

Dimensions

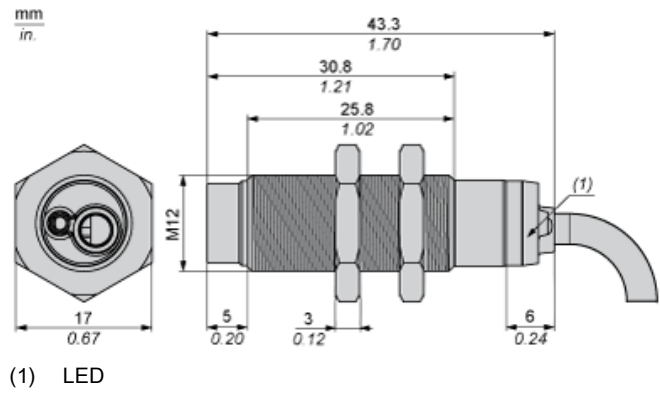

Minimum Mounting Distances

Side by side



e (1) 16 mm/0.63 in.

≥

Face to face



e (2) 48 mm/1.89 in.

≥

Facing a metal object

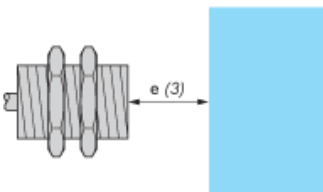

e (3) 12 mm/0.47 in.

≥

Mounted in a metal support



d ≥ 36 mm/1.42 in.

h ≥ 8 mm/0.31 in.