

Dimensions

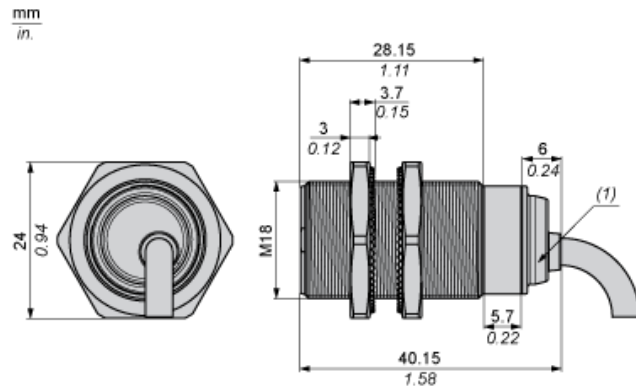

(1) LED

## Minimum Mounting Distances

Side by side



e (1) 16 mm/0.63 in.

≥

Face to face



e (2) 100 mm/3.94 in.

≥

Facing a metal object



e (3) 25 mm/0.98 in.

≥