

Dimensions

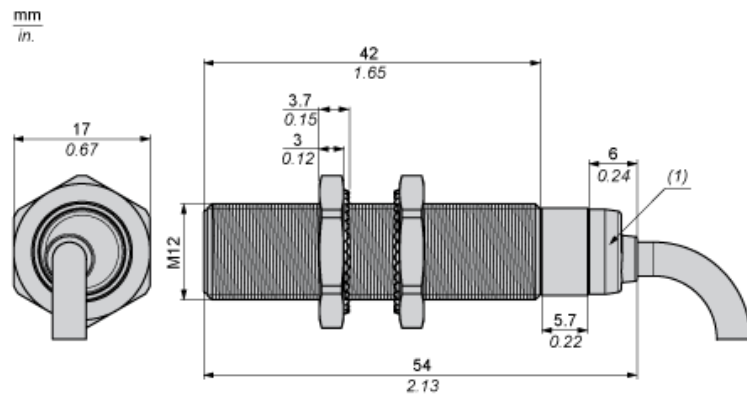

(1) LED

---

Minimum Mounting Distances

---

Side by side



$e (1) \geq 16 \text{ mm}/0.63 \text{ in.}$

Face to face



$e (2) \geq 48 \text{ mm}/1.89 \text{ in.}$

Facing a metal object



$e (3) \geq 12 \text{ mm}/0.47 \text{ in.}$

Mounted in a metal support



$d \geq 36 \text{ mm}/1.42 \text{ in.}$

$h \geq 8 \text{ mm}/0.31 \text{ in.}$