

Dimensions

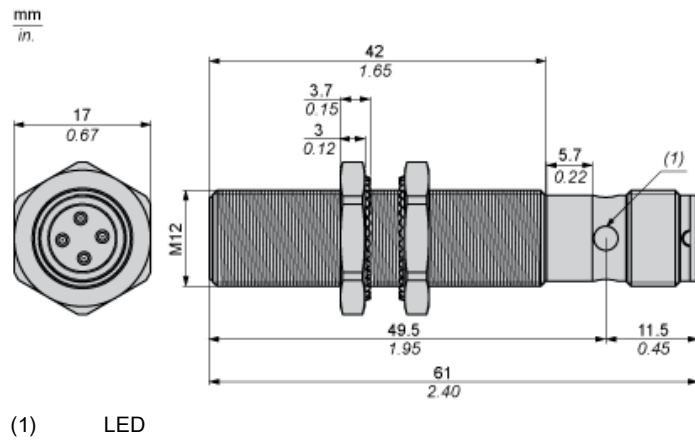

Minimum Mounting Distances

Side by side



$e (1) \geq 8 \text{ mm}/0.31 \text{ in.}$

Face to face



$e (2) \geq 48 \text{ mm}/1.89 \text{ in.}$

Facing a metal object



$e (3) \geq 12 \text{ mm}/0.47 \text{ in.}$