

Dimensions

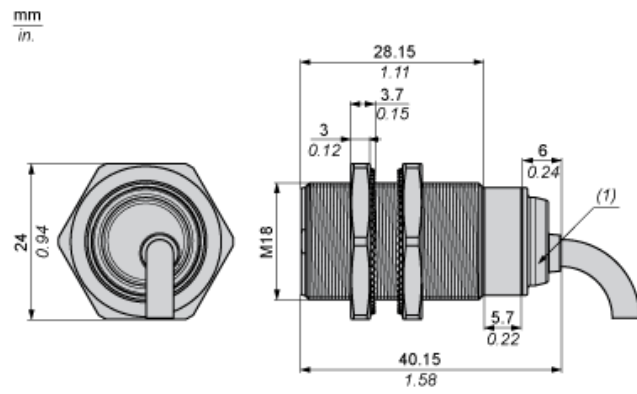

(1) LED

---

Minimum Mounting Distances

---

Side by side



$e (1) \geq 10 \text{ mm}/0.39 \text{ in.}$

Face to face



$e (2) \geq 60 \text{ mm}/2.36 \text{ in.}$

Facing a metal object



$e (3) \geq 15 \text{ mm}/0.60 \text{ in.}$