

Dimensions

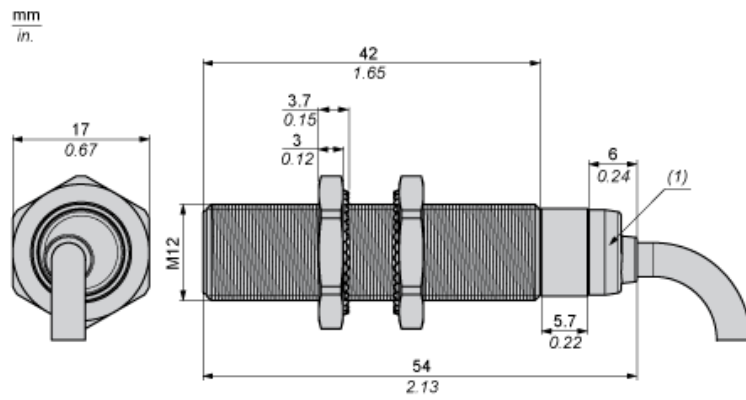

(1) LED

Minimum Mounting Distances

Side by side

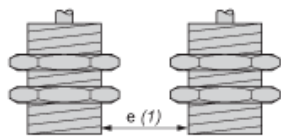

e (1) 4 mm/0.16 in.

≥

Face to face

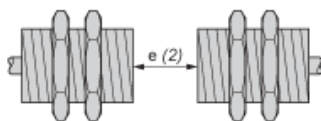

e (2) 24 mm/0.94 in.

≥

Facing a metal object

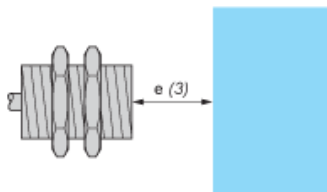

e (3) 6 mm/0.24 in.

≥

Mounting

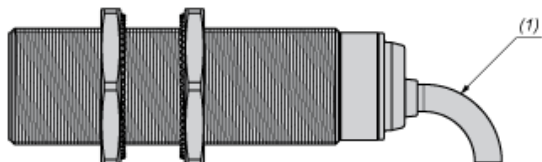

(1) Bending cable: 4 x external cable diameter