



Main

Range of product	OsiSense XU
Series name	Application
Electronic sensor type	Photo-electric sensor
Sensor name	XUY
Sensor design	Fork
Detection system	Thru beam
Emission	Infrared LED, modulated
Passage width	80 mm
Passage depth	59 mm
Material	Metal/plastic
Supply circuit type	DC
Wiring technique	4-wire
Discrete output type	PNP and NPN
Discrete output function	1 NO or 1 NC programmable
Electrical connection	1 male connector M8, 4 pins
Product specific application	Detection of double sheet Detection of labels Detection of reference marks Detection on vibrating rail Detection on small conveyor
[Sn] nominal sensing distance	80 mm

Complementary

Enclosure material	Painted aluminium and polyamide/glass
Keypad type	Yellow
Minimum object diameter for detection	0.2 mm
Type of output signal	Discrete
Output type	Solid state
Status LED	1 LED (red) for adjustment mode and keypad locking 1 LED (yellow) for output state
[Us] rated supply voltage	12...24 V DC with reverse polarity protection
Supply voltage limits	10...30 V DC
Switching capacity in mA	100 mA (overload and short-circuit protection)

Switching frequency	10 kHz
Voltage drop	< 2 V (closed state)
Current consumption	40 mA (no-load)
Load capacitance	330 nF
Time response	-20...20 µs
Setting-up	Self teaching
Product weight	0.19 kg

Environment

Product certifications	CE cULus
Ambient air temperature for operation	-20...60 °C
Ambient air temperature for storage	-30...80 °C
Immunity to ambient light	10000 lux with natural light 5000 lux with incandescent bulb
Vibration resistance	7 gn, amplitude = +/- 0.75 mm (f = 10...55 Hz) conforming to IEC 60068-2-6
Shock resistance	30 gn (duration = 11 ms) conforming to IEC 60068-2-27
IP degree of protection	IP65 conforming to IEC 60529

Offer Sustainability

RoHS (date code: YYWW)	Compliant - since 0648 - Schneider Electric declaration of conformity Schneider Electric declaration of conformity
------------------------	---

Contractual warranty

Warranty period	18 months
-----------------	-----------

Dimensions

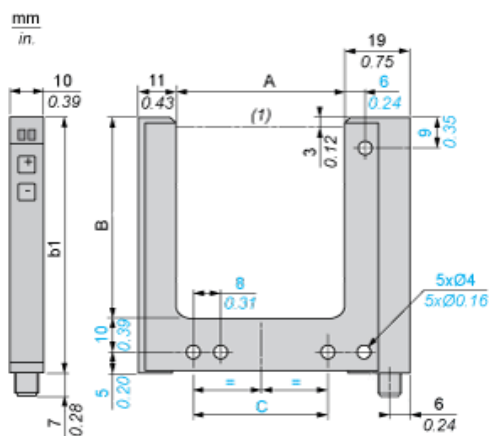

(1) Optical axis

Dimensions in mm

A	B	b1	C
80	59	74	70

Dimensions in in.

A	B	b1	C
3.15	2.32	2.91	2.76

Wiring Schemes

M8 Connector



- 1 : BN: Brown
- 2 : WH: White
- 3 : BU: Blue
- 4 : BK: Black

4-Wire, PNP/NPN Outputs



- BN : Brown
- WH : White
- BK : Black
- BU : Blue