

XS508B1PBM8

inductive sensor XS5 M8 - L42mm - stainless -
Sn1.5mm - 12..24VDC - M8



Main

Range of product	OsiSense XS
Series name	General purpose
Sensor type	Inductive proximity sensor
Device application	-
Sensor name	XS5
Sensor design	Cylindrical M8
Size	42 mm
Body type	Fixed
Detector flush mounting acceptance	Flush mountable
Material	Metal
Type of output signal	Discrete
Wiring technique	3-wire
[Sn] nominal sensing distance	1.5 mm
Discrete output function	1 NC
Output circuit type	DC
Discrete output type	PNP
Electrical connection	Male connector M8 3 pins
[Us] rated supply voltage	12...24 V DC with reverse polarity protection
Switching capacity in mA	<= 200 mA DC with overload and short-circuit protection
IP degree of protection	IP67 conforming to IEC 60529

Complementary

Thread type	M8 x 1
Detection face	Frontal
Front material	PPS
Enclosure material	Nickel plated brass
Operating zone	0...1.2 mm
Differential travel	1...15% of Sr
Status LED	1 LED (yellow) for output state
Supply voltage limits	10...36 V DC
Switching frequency	<= 5000 Hz
Voltage drop	<= 2 V, closed state
Current consumption	<= 10 mA (no-load)
Delay first up	<= 10 ms
Delay response	<= 0.1 ms
Delay recovery	<= 0.1 ms
Marking	CE
Threaded length	26 mm
Height	10 mm
Length	42 mm
Product weight	0.025 kg

Environment

The information provided in this documentation contains general descriptions and/or technical characteristics of the products contained herein. This documentation is not intended as a substitute for and is not to be used for determining suitability or reliability of these products for specific user applications. It is the duty of any such user or integrator to perform the appropriate and complete risk analysis, evaluation and testing of the products with respect to the relevant specific application or use thereof. Neither Schneider Electric Industries SAS nor any of its affiliates or subsidiaries shall be responsible or liable for misuse of the information contained herein.

product certifications	CSA UL
ambient air temperature for operation	-25...70 °C
ambient air temperature for storage	-40...85 °C
vibration resistance	25 gn, amplitude: +/- 2 mm (f = 10...55 Hz) conforming to IEC 60068-2-6
shock resistance	50 gn (duration = 11 ms) conforming to IEC 60068-2-27

Offer Sustainability

Sustainable offer status	Green Premium product
RoHS (date code: YYWW)	Compliant - since 1010 - Schneider Electric declaration of conformity
REACH	Reference not containing SVHC above the threshold
Product environmental profile	Available
Product end of life instructions	Available

Contractual warranty

Warranty period	24 months
-----------------	-----------

Dimensions

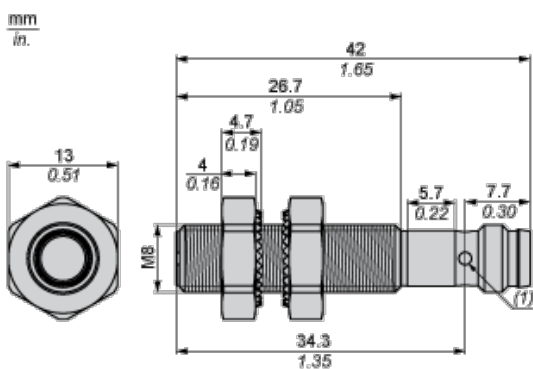

(1) LED

Minimum Mounting Distances

Side by side

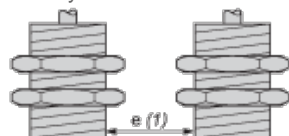

e (1) 3 mm/0.12 in.

≥

Face to face

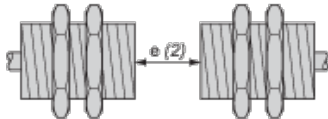

e (2) 18 mm/0.71 in.

≥

Facing a metal object

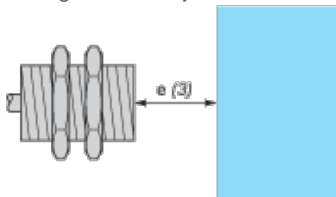

e (3) 4.5 mm/0.18 in.

≥

Wiring Schemes

M8 Connector

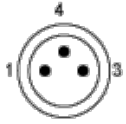

PNP

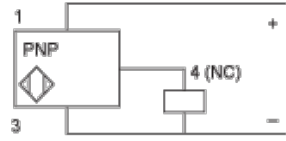

Performance Curves

Standard Steel Target : 8x8x1 mm

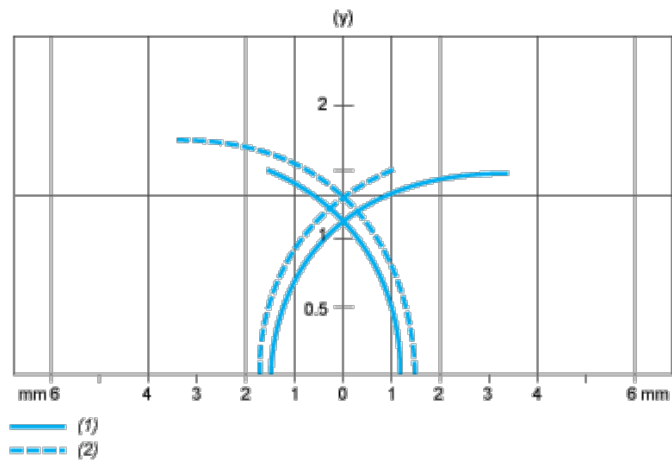

- (1) Pick-up points
- (2) Drop-out points (object approaching from the side)
- (y) Sensing distance in mm