

<b>BASIC CHARACTERISTICS</b> ( $T_{amb} = 25\text{ }^{\circ}\text{C}$ , unless otherwise specified)						
PARAMETER	TEST CONDITION	SYMBOL	MIN.	TYP.	MAX.	UNIT
<b>COUPLER</b>						
Collector current	$V_{CE} = 5\text{ V}$ , $I_F = 15\text{ mA}$	$I_C$	300	600		$\mu\text{A}$
Collector emitter saturation voltage	$I_F = 15\text{ mA}$ , $I_C = 0.05\text{ mA}$	$V_{CEsat}$			0.4	V
<b>INPUT (EMITTER)</b>						
Forward voltage	$I_F = 15\text{ mA}$	$V_F$	1	1.2	1.4	V
Reverse current	$V_R = 5\text{ V}$	$I_R$			10	$\mu\text{A}$
Junction capacitance	$V_R = 0\text{ V}$ , $f = 1\text{ MHz}$	$C_j$		25		pF
<b>OUTPUT (DETECTOR)</b>						
Collector emitter voltage $I_C$	$I_C = 1\text{ mA}$	$V_{CEO}$	20			V
Emitter collector voltage	$I_E = 100\text{ }\mu\text{A}$	$V_{ECO}$	7			V
Collector dark current	$V_{CE} = 25\text{ V}$ , $I_F = 0\text{ A}$ , $E = 0\text{ lx}$	$I_{CEO}$		1	100	nA
<b>SWITCHING CHARACTERISTICS</b>						
Rise time	$I_C = 0.3\text{ mA}$ , $V_{CE} = 5\text{ V}$ , $R_L = 100\text{ }\Omega$ (see figure 3)	$t_r$		20	150	$\mu\text{s}$
Fall time	$I_C = 0.3\text{ mA}$ , $V_{CE} = 5\text{ V}$ , $R_L = 100\text{ }\Omega$ (see figure 3)	$t_f$		30	150	$\mu\text{s}$

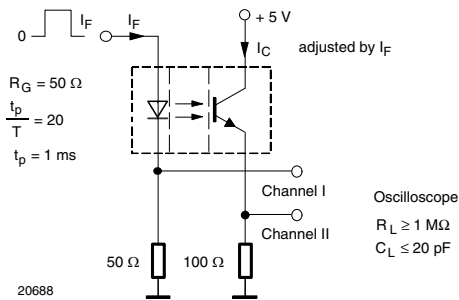
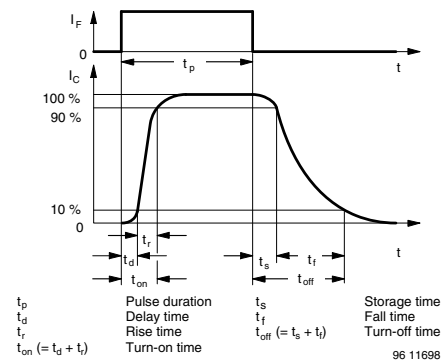

 Fig. 3 - Test Circuit for  $t_r$  and  $t_f$ 


Fig. 4 - Switching Times

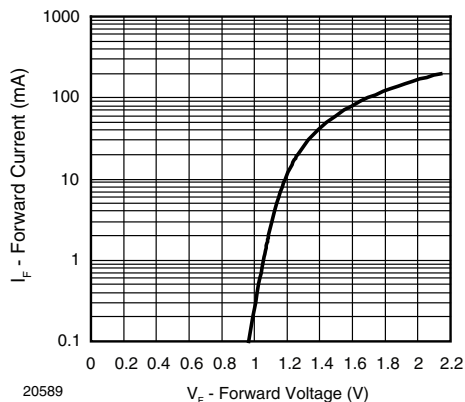
**BASIC CHARACTERISTICS** ( $T_{amb} = 25\text{ }^{\circ}\text{C}$ , unless otherwise specified)


Fig. 5 - Forward Current vs. Forward Voltage

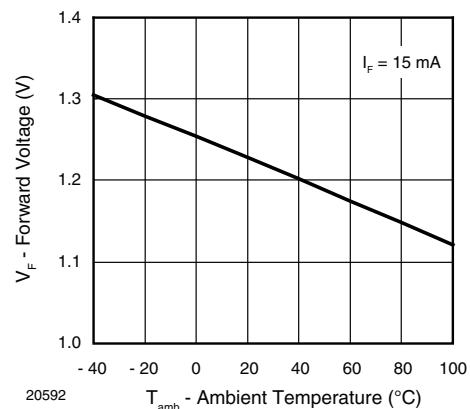


Fig. 6 - Forward Voltage vs. Ambient Temperature

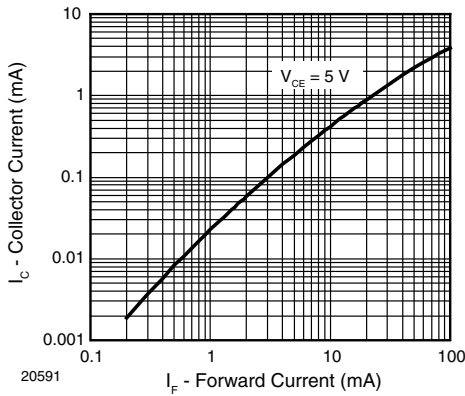


Fig. 7 - Collector Current vs. Forward Current

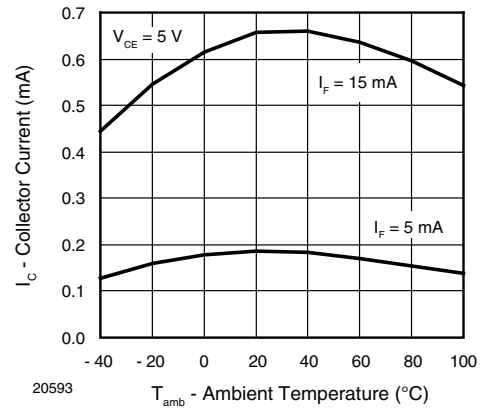


Fig. 10 - Collector Current vs. Ambient Temperature

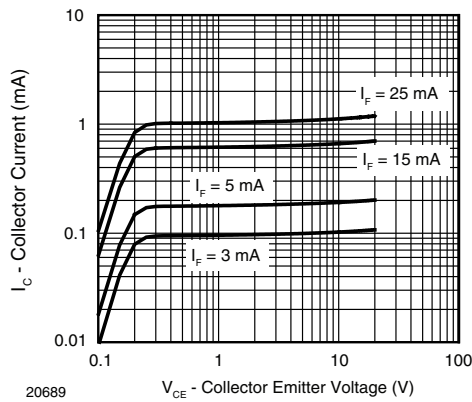


Fig. 8 - Collector Current vs. Collector Emitter Voltage

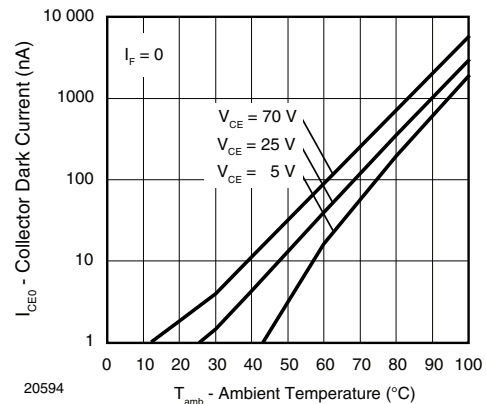


Fig. 11 - Collector Dark Current vs. Ambient Temperature

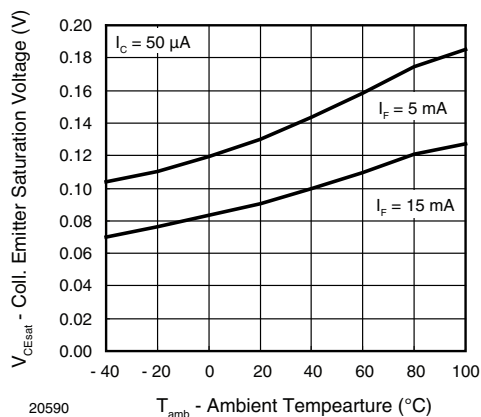


Fig. 9 - Collector Emitter Saturation Voltage vs. Ambient Temperature

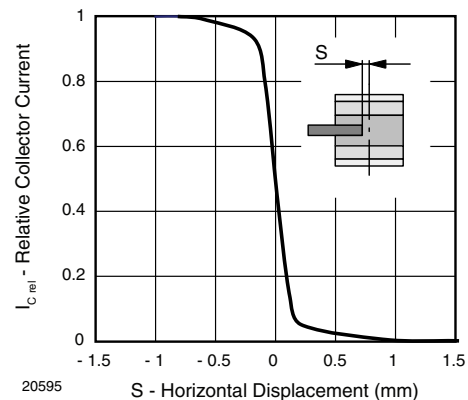


Fig. 12 - Relative Collector Current vs. Horizontal Displacement