

Σ Series SGM/SGMP/SGDA USER'S MANUAL

AC Servomotors and Drivers

SGM/SGMP Servomotors

SGDA Servopack



YASKAWA

MANUAL NO. TSE-S800-15C

PREFACE

The rapid progress being made in today's automation and information technologies is resulting in a growing need for even more-advanced motion control for future high-tech equipment. The end result is a need for devices that can provide more-precise and quicker motion at higher speeds. Servo control technology makes this possible. Launched by Yaskawa in 1993, the Σ Series consists of innovative AC Servos that were developed using leading-edge servo control technology.

This manual covers all products in the Σ Series, which feature superior functions and performance. This manual was designed to provide comprehensible information for users who are about to use a servo for the first time as well as for users who already have experience in using servos. This manual enables users to understand what Σ -Series AC Servos are all about and how to design, install, operate, and maintain a servo system. Keep this manual in a convenient location and refer to it whenever necessary in operating and maintaining the servo system.

YASKAWA ELECTRIC CORPORATION

General Precautions

- Some drawings in this manual are shown with the protective cover or shields removed, in order to describe the detail with more clarity. Make sure all covers and shields are replaced before operating this product.
- Some drawings in this manual are shown as typical example and may differ from the shipped product.
- This manual may be modified when necessary because of improvement of the product, modification or changes in specifications.
Such modification is made as a revision by renewing the manual No.
- To order a copy of this manual, if your copy has been damaged or lost, contact your YASKAWA representative listed on the last page stating the manual No. on the front cover.
- YASKAWA is not responsible for accidents or damages due to any modification of the product made by the user since that will void our guarantee.

NOTES FOR SAFE OPERATION

Read this manual thoroughly before installation, operation, maintenance or inspection of the AC Servo Drives. In this manual, the NOTES FOR SAFE OPERATION are classified as “WARNING” or “CAUTION”.



Indicates a potentially hazardous situation which, if not avoided, could result in death or serious personal injury.



Indicates a potentially hazardous situation which, if not avoided, may result in minor or moderate personal injury and/or damage to the equipment.

In some instances, items described in  may also result in a serious accident. In either case, follow these important items.



WARNING

(WIRING)

- Grounding must be in accordance with the national code and consistent with sound local practices.
Failure to observe this warning may lead to electric shock or fire.

(OPERATION)

- Never touch any rotating motor parts during operation.
Failure to observe this warning may result in personal injury.

(INSPECTION AND MAINTENANCE)

- Be sure to turn OFF power before inspection or maintenance.
Otherwise, electric shock may result.
- Never open the terminal cover while power is ON, and never turn ON power when the terminal cover is open.
Otherwise, electric shock may result.
- After turning OFF power, wait at least five minutes before servicing the product.
Otherwise, residual electric charges may result in electric shock.



CAUTION

(RECEIVING)

- Use the specified combination of SERVOMOTOR and SERVOPACK.
Failure to observe this caution may lead to fire or failure.

(INSTALLATION)

- Never use the equipment where it may be exposed to splashes of water, corrosive or flammable gases, or near flammable materials.
Failure to observe this caution may lead to electric shock or fire.

(WIRING)

- Do not connect three-phase power supply to output terminals U, V and W.
Failure to observe this caution may lead to personal injury or fire.
- Securely tighten screws on the power supply and motor output terminals.
Failure to observe this caution can result in a fire.



CAUTION

(OPERATION)

- To avoid inadvertent accidents, run the SERVOMOTOR only in test run (without load).
Failure to observe this caution may result in personal injury.
- Before starting operation with a load connected, set up user constants suitable for the machine.
Starting operation without setting up user constants may lead to overrun failure.
- Before starting operation with a load connected, make sure emergency-stop procedures are in place.
Failure to observe this caution may result in personal injury.
- During operation, do not touch the heat sink.
Failure to observe this caution may result in burns.

(INSPECTION AND MAINTENANCE)

- Do not disassemble the SERVOMOTOR.
Failure to observe this caution may result in electric shock or personal injury.
- Never change wiring while power is ON.
Failure to observe this caution may result in electric shock or personal injury.

Manual Contents

This manual provides Σ -Series users with information on the following:

- An overview of servo systems for first-time users.
- Checking the product on delivery and basic applications of the servo.
- Servo applications.
- Selecting an appropriate servo for your needs and placing an order.
- Inspection and maintenance.

Manual Structure

All chapters in this manual are classified into one or more of three areas according to their contents: A, B, and C. Refer to the applicable chapters for the information you require.

A: Chapters explaining how to select a servo: For users who wish to gain a basic understanding of Σ Series products or who need to select an appropriate servo.

B: Chapters explaining how to design a servo system: For users who are about to design, install, and operate a Σ -Series Servo Control System.

C: Chapters explaining maintenance: For users who are going to maintain and troubleshoot Σ -Series products.

<u>Chapter</u>	<u>Title</u>	<u>Page</u>	<u>Area</u>
CHAPTER 1	For First-time Users of AC Servos	1	A, B
	Provides an overview of servos and the Σ Series.		
CHAPTER 2	Basic Uses of Σ-series Products	15	B
	Describes steps to take when product is received, plus basic wiring and application methods.		
CHAPTER 3	Applications of Σ-series Products	51	B
	Describes the effective usage of Σ -Series features according to application.		
CHAPTER 4	Using the Digital Operator	167	B
	Describes operating procedures for Σ -Series servos, turning features ON and OFF, setting control constants, etc.		
CHAPTER 5	Servo Selection and Data Sheets	205	A, B
	Describes selection methods for Σ -Series servos and peripherals and provides servo specifications.		
CHAPTER 6	Inspection, Maintenance, and Troubleshooting	343	C
	Describes user maintenance and troubleshooting.		
 <u>APPENDIXES</u>			
A	Differences between SGDA and SGD Servopacks	367	A, B, C
B	Servo Adjustment	374	B, C
C	List of I/O Signals	365	A, B, C
D	List of User Constants	397	B, C
E	List of Alarm Displays	409	B, C
<u>INDEX</u>		415	A, B, C

Basic Terms

Unless otherwise specified, the following definitions are used:

Servomotor: Σ -Series SGM/SGMP Servomotor

Servopack: An amplifier (Trademark of Yaskawa servo amplifier “SGDA Servopack”)

Servodrive: A SGM/SGMP Servomotor and an amplifier (SGDA Servopack)

Servo system: A complete servo control system consisting of servodrive, host controller, and peripheral devices

Visual Aids

The following aids are used to indicate certain types of information for easier reference.



Indicates references for additional information.



Technical terms placed in bold in the text are briefly explained in a “TERMS” section at the bottom of the page. The following kinds of technical terms are explained: Technical terms that need to be explained to users who are not very familiar with servo systems or electronic devices and technical terms specific to Σ Series Servos that need to be explained in descriptions of functions.

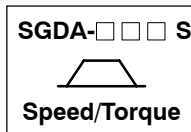

The text indicated by this icon is applicable only to Servopacks for speed/torque control (Type: SGDA-□□□S).

If neither this icon nor the following icon appears, the description is applicable to both types of Servopack.

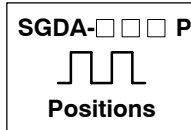

The text indicated by this icon is applicable only to Servopacks for position control (Type: SGDA-□□□P).

If neither this icon nor the previous icon appears, the description is applicable to both types of Servopack.

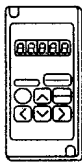

JUSP-OP02A-1

The text indicated by this icon explains the operating procedure using hand-held type digital operator (Type: JUSP-OP02A-1).

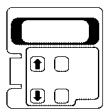

JUSP-OP03A

The text indicated by this icon explains the operating procedure using mount type digital operator (Type: JUSP-OP03A).

NOTE A Σ -Series Servodrive alone cannot ensure the functionality and performance of the entire machine control system. It must be combined with an appropriate machine and host controller so that the entire control system works properly. Therefore, carefully read the instruction manuals for the machine to be used before attempting to operate the servodrive.

©Yaskawa, 1995

All rights reserved. No part of this publication may be reproduced, stored in a retrieval system, or transmitted, in any form, or by any means, mechanical, electronic, photocopying, recording, or otherwise, without the prior written permission of Yaskawa. No patent liability is assumed with respect to the use of the information contained herein. Moreover, because Yaskawa is constantly striving to improve its high-quality products, the information contained in this manual is subject to change without notice. Every precaution has been taken in the preparation of this manual. Nevertheless, Yaskawa assumes no responsibility for errors or omissions. Neither is any liability assumed for damages resulting from the use of the information contained in this publication.

CONTENTS

CHAPTER 1	FOR FIRST-TIME USERS OF AC SERVOS	1
1.1	Basic Understanding of AC Servos	2
1.1.1	Servo Mechanisms	2
1.1.2	Servo Configuration	5
1.1.3	Features of Σ -Series Servos	11
CHAPTER 2	BASIC USES OF Σ-SERIES PRODUCTS	15
2.1	Precautions	16
2.1.1	Notes on Use	16
2.2	Installation	18
2.2.1	Checking on Delivery	18
2.2.2	Installing the Servomotor	19
2.2.3	Installing the Servopack	22
2.3	Connection and Wiring	25
2.3.1	Connecting to Peripheral Devices	25
2.3.2	Main Circuit Wiring and Power ON Sequence	28
2.3.3	Examples of Connecting I/O Signal Terminals	30
2.4	Conducting a Test Run	37
2.4.1	Test Run in Two Steps	37
2.4.2	Step 1: Conducting a Test Run for Motor without Load	39
2.4.3	Step 2: Conducting a Test Run with the Motor Connected to the Machine	44
2.4.4	Supplementary Information on Test Run	46
2.4.5	Minimum User Constants Required and Input Signals	48
CHAPTER 3	APPLICATIONS OF Σ-SERIES PRODUCTS	51
3.1	Setting User Constants According to Machine Characteristics	54
3.1.1	Changing the Direction of Motor Rotation	54
3.1.2	Setting the Overtravel Limit Function	56
3.1.3	Restricting Torque	59
3.2	Setting User Constants According to Host Controller	65
3.2.1	Inputting Speed Reference	65
3.2.2	Inputting Position Reference	69
3.2.3	Using Encoder Output	73
3.2.4	Using Contact I/O Signals	77
3.2.5	Using Electronic Gear	79
3.2.6	Using Contact Input Speed Control	83
3.2.7	Using Torque Control	88
3.2.8	Using Torque Feed-forward Function	94
3.2.9	Using Torque Restriction by Analog Voltage Reference	95
3.2.10	Using the Reference Pulse Inhibit Function (INHIBIT)	97
3.2.11	Using the Reference Pulse Input Filter Selection Function	99
3.3	Setting Up the Σ Servopack	100
3.3.1	Setting User Constants	100
3.3.2	Setting the Jog Speed	101
3.3.3	Setting the Number of Encoder Pulses	102
3.3.4	Setting the Motor Type	103

CONTENTS

3.4	Setting Stop Mode	104
3.4.1	Adjusting Offset	104
3.4.2	Using Dynamic Brake	105
3.4.3	Using Zero-Clamp	106
3.4.4	Using Holding Brake	107
3.5	Running the Motor Smoothly	111
3.5.1	Using the Soft Start Function	111
3.5.2	Using the Smoothing Function	112
3.5.3	Adjusting Gain	112
3.5.4	Adjusting Offset	113
3.5.5	Setting the Torque Reference Filter Time Constant	113
3.6	Minimizing Positioning Time	114
3.6.1	Using Autotuning Function	114
3.6.2	Setting Servo Gain	114
3.6.3	Using Feed-forward Control	116
3.6.4	Using Proportional Control	116
3.6.5	Setting Speed Bias	117
3.6.6	Using Mode Switch	118
3.6.7	Using Speed Loop Compensation Function	124
3.7	Forming a Protective Sequence	125
3.7.1	Using Servo Alarm Output and Alarm Code Output	125
3.7.2	Using Servo ON Input Signal	125
3.7.3	Using Positioning Complete Signal	129
3.7.4	Using Speed Coincidence Output Signal	131
3.7.5	Using Running Output Signal	132
3.7.6	Handling of Power Loss	134
3.8	Special Wiring	136
3.8.1	Wiring Instructions	136
3.8.2	Wiring for Noise Control	138
3.8.3	Using More Than One Servo Drive	143
3.8.4	Using Regenerative Units	144
3.8.5	Using an Absolute Encoder	148
3.8.6	Extending an Encoder Cable	157
3.8.7	Using SGDA Servopack with High Voltage Line	159
3.8.8	Connector Terminal Layouts	161
CHAPTER 4	USING THE DIGITAL OPERATOR	167
4.1	Basic Operations	168
4.1.1	Connecting the Digital Operator	168
4.1.2	Resetting Servo Alarms	169
4.1.3	Basic Functions and Mode Selection	170
4.1.4	Operation in Status Display Mode	171
4.1.5	Operation in User Constant Setting Mode	174
4.1.6	Operation in Monitor Mode	179

CONTENTS

4.2	Using the Functions	183
4.2.1	Operation in Alarm Trace-back Mode	183
4.2.2	Operation Using the Digital Operator	186
4.2.3	Autotuning	189
4.2.4	Reference Offset Automatic Adjustment	196
4.2.5	Speed Reference Offset Manual Adjustment Mode	174
4.2.6	Clearing Alarm Trace-back Data	202
4.2.7	Checking Motor Type	203
4.2.8	Checking Software Version	204
CHAPTER 5	SERVO SELECTION AND DATA SHEETS	205
5.1	Selecting a Σ -Series Servo	207
5.1.1	Selecting a Servomotor	207
5.1.2	Selecting a Servopack	213
5.1.3	Selecting a Digital Operator	215
5.2	SGM Servomotor	217
5.2.1	Ratings and Specifications	217
5.2.2	Mechanical Characteristics	232
5.3	Servopack Ratings and Specifications	235
5.3.1	Ratings and Specifications	235
5.3.2	Overload Characteristics	240
5.3.3	Starting Time and Stopping Time	241
5.3.4	Load Inertia	241
5.3.5	Overhanging Loads	244
5.3.6	In-rush Current and Power Loss	245
5.4	Σ -Series Dimensional Drawings	246
5.4.1	Servomotor Dimensional Drawings	246
5.4.2	Servopack Dimensional Drawings	289
5.4.3	Digital Operator Dimensional Drawings	291
5.5	Selecting Peripheral Devices	293
5.5.1	Selecting Peripheral Devices	293
5.5.2	Order List	299
5.6	Specifications and Dimensional Drawings of Peripheral Devices	308
5.6.1	Cable Specifications and Peripheral Devices	308
5.6.2	Motor Cables	311
5.6.3	Connector Kits	314
5.6.4	Brake Power Supply	318
5.6.5	Encoder Cables	320
5.6.6	Battery for Absolute Encoder	325
5.6.7	1CN Connector	326
5.6.8	Connector Terminal Block Converter Unit	328
5.6.9	Cable With 1CN Connector and One End Without Connector	330
5.6.10	Circuit Breaker	330
5.6.11	Noise Filter	331
5.6.12	Magnetic Contactor	332
5.6.13	Surge Suppressor	333
5.6.14	Regenerative Unit	334

CONTENTS

5.6.15	Variable Resistor for Speed Setting	335
5.6.16	Encoder Signal Converter Unit	336
5.6.17	Cables for Connecting PC and Servopack	338
CHAPTER 6 INSPECTION, MAINTENANCE, AND TROUBLESHOOTING		343
6.1	Inspection and Maintenance	344
6.1.1	Servomotor	344
6.1.2	Servopack	345
6.1.3	Replacing Battery for Absolute Encoder	346
6.2	Troubleshooting	347
6.2.1	Troubleshooting Problems with Alarm Display	347
6.2.2	Troubleshooting Problems With No Alarm Display	366
6.2.3	Internal Connection Diagram and Instrument Connection Examples	368
APPENDIXES		
A	Differences Between SGDA and SGD Servopacks	367
B	Servo Adjustment	374
B.1	Σ -Series AC Servopack Gain Adjustment	374
B.1.1	Σ -Series AC Servopacks and Gain Adjustment Methods	374
B.1.2	Basic Rules for Gain Adjustment	375
B.2	Adjusting a Speed-control Servopack	376
B.2.1	Adjusting Using Auto-tuning	376
B.2.2	Manual Adjustment	377
B.3	Adjusting a Position-control Servopack	380
B.3.1	Adjusting Using Auto-tuning	380
B.3.2	Manual Adjustment	381
B.4	Gain Setting References	385
B.4.1	Guidelines for Gain Settings According to Load Inertia Ratio	385
C	List of I/O Signals	385
D	List of User Constants	397
E	List of Alarm Displays	409
INDEX		415

FOR FIRST-TIME USERS OF AC SERVOS

1

This chapter is intended for first-time users of AC servos. It describes the basic configuration of a servo mechanism and basic technical terms relating to servos.

Users who already have experience in using a servo should also take a look at this chapter to understand the features of Σ -Series AC Servos.

- 1.1 Basic Understanding of AC Servos 2**
 - 1.1.1 Servo Mechanisms 2
 - 1.1.2 Servo Configuration 5
 - 1.1.3 Features of Σ -Series Servos 11

1.1 Basic Understanding of AC Servos

This section describes the basic configuration of a servo mechanism and technical terms relating to servos and also explains the features of Σ -Series AC Servos.

1.1.1	Servo Mechanisms	2
1.1.2	Servo Configuration	5
1.1.3	Features of Σ -Series Servos	11

1.1.1 Servo Mechanisms

You may be familiar with the following terms:

- Servo
- **Servo mechanism**
- Servo control system

In fact, these terms are synonymous. They have the following meaning:

A control mechanism that monitors physical quantities such as specified positions.

In short, a servo mechanism is like a servant who does tasks faithfully and quickly according to his master's instructions. In fact, "servo" originally derives from the word "servant."



Servo mechanism

According to Japanese Industrial Standard (JIS) terminology, a "servo mechanism" is defined as a mechanism that uses the position, direction, or orientation of an object as a process variable to control a system to follow any changes in a target value (set point). More simply, a servo mechanism is a control mechanism that monitors physical quantities such as specified positions. Feedback control is normally performed by a servo mechanism. (Source: JIS B0181)

Servo system could be defined in more detail as a mechanism that:

- Moves at a specified speed and
- Locates an object in a specified position

To develop such a servo system, an automatic control system involving **feedback control** must be designed. This automatic control system can be illustrated in the following block diagram:

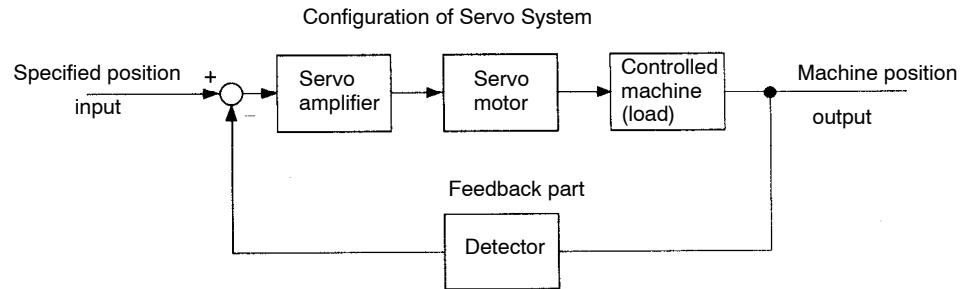

This servo system is an automatic control system that detects the machine position (output data), feeds back the data to the input side, compares it with the specified position (input data), and moves the machine by the difference between the compared data.

In other words, the servo system is a control system that forces the output data to match the specified input data.

If, for example, the specified position changes, the servo system will reflect the changes.

In the above example, input data is defined as a position, but input data can be any physical quantities such as orientation (angle), water pressure, or voltage.

Position, speed, force (torque), electric current, and so on are typical controlled values for a servo system.

The main technical terms used in this manual are as follows:

- 1) Servo mechanism
- 2) Servo

Normally, servo is synonymous with servo mechanism. However, because “mechanism” is omitted, the meaning becomes somewhat ambiguous. Servo may refer to the entire servo mechanism but may also refer to an integral part of a servo mechanism such as a servomotor or a servo amplifier. This manual also follows this convention in the use of the term “servo”.



Feedback control

A control that returns process variables to the input side and forms a closed loop. It is also called closed-loop control.

3) Servo control system

Servo control system is almost synonymous with servo mechanism but places the focus on system control. In this manual, the term “servo system” is also used as a synonym of servo control system.

Related Terms	Meaning
Servomotor	General servomotors or Yaskawa SGM/SGMP Servomotors. In some cases, a position detector (encoder) is included in a servomotor.
Servopack	Trademark of Yaskawa servo amplifier “SGDA Servopack.” Servopack is divided into two types: SGDA-□□□S (for speed/torque control) and SGDA-□□□P (for position control).
Servo drive	A Servomotor and amplifier pair. Also called “servo.”
Servo system	A closed control system consisting of a host controller, servo drive and controlled system to form a servo mechanism.

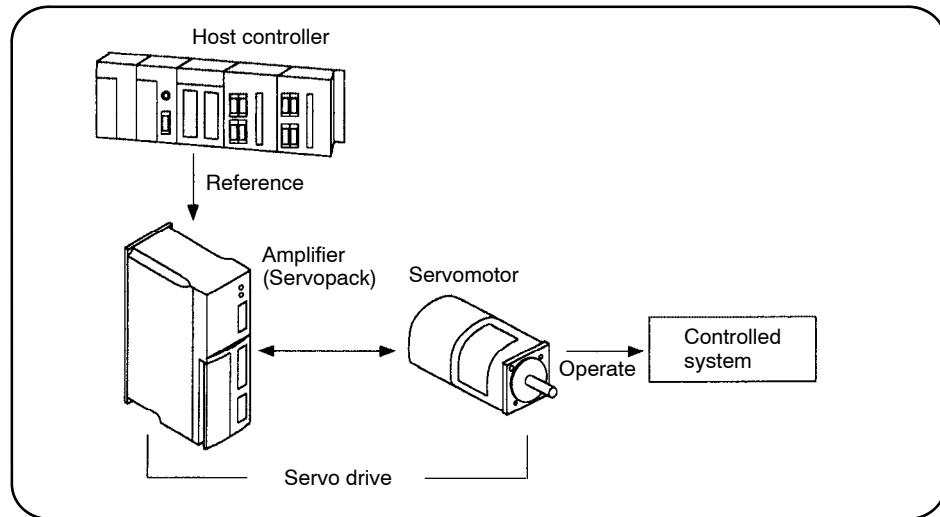

Servo system

1.1.2 Servo Configuration

1) Configuration of Servo System

The following diagram illustrates a servo system in detail:

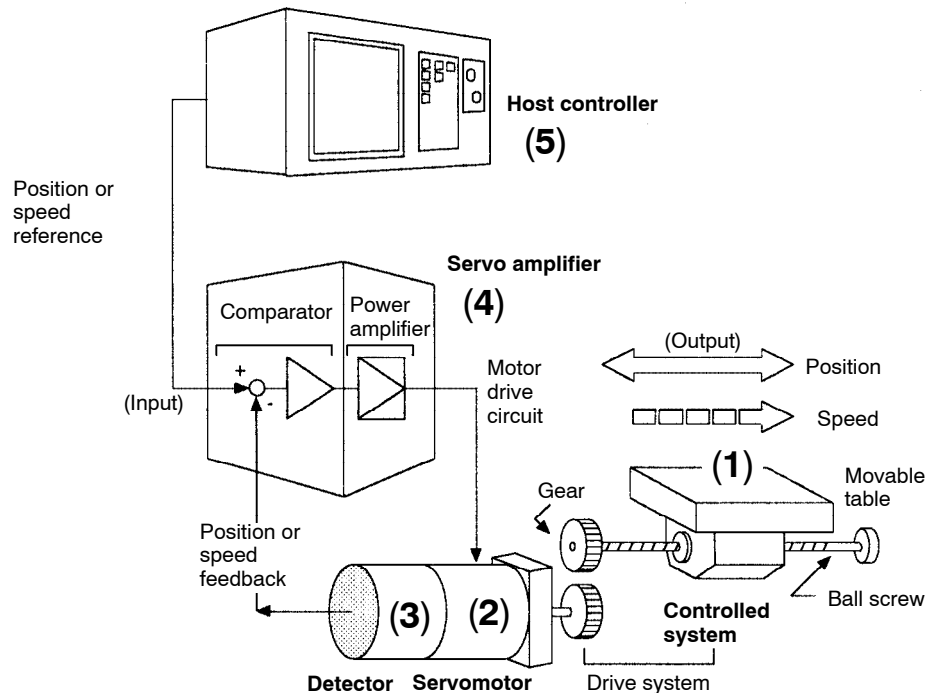

- (1) **Controlled system:** Mechanical system for which the position or speed is to be controlled. This includes a drive system that transmits torque from a servomotor.
- (2) **Servomotor:** A main actuator that moves a controlled system. Two types are available: AC servomotor and DC servomotor.
- (3) **Detector:** A position or speed detector. Normally, an encoder mounted on a motor is used as a position detector.
- (4) **Servo amplifier:** An amplifier that processes an error signal to correct the difference between a reference and feedback data and operates the servomotor accordingly. A servo amplifier consists of a comparator, which processes error signals, and a power amplifier, which operates the servomotor.
- (5) **Host controller:** A device that controls a servo amplifier by specifying a position or speed as a set point.

Servo components (1) to (5) are outlined below:

(1) Controlled system

In the previous figure, the controlled system is a movable table for which the position or speed is controlled. The movable table is driven by a ball screw and is connected to the servomotor via gears.

So, the **drive system** consists of:

Gears + Ball Screw

This drive system is most commonly used because the power transmission ratio (gear ratio) can be freely set to ensure high positioning accuracy. However, play in the gears must be minimized.

The following drive system is also possible when the controlled system is a movable table:

Coupling + Ball Screw

When the power transmission ratio is 1 : 1, a coupling is useful because it has no play.

This drive system is widely used for machining tools.

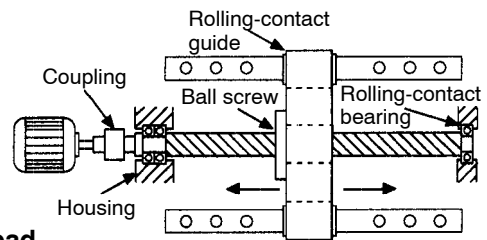

Timing Belt + Trapezoidal Screw Thread

A timing belt is a coupling device that allows the power transmission ratio to be set freely and that has no play.

A trapezoidal screw thread does not provide excellent positioning accuracy, so can be treated as a minor coupling device.

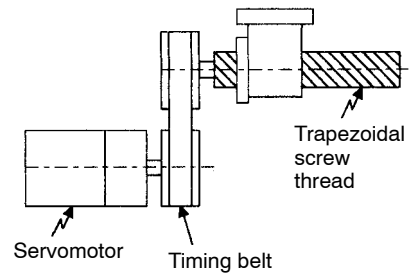

To develop an excellent servo system, it is important to select a rigid drive system that has no play.

Configure the controlled system by using an appropriate drive system for the control purpose.



Drive system

Also called a drive mechanism.

A drive system connects an actuator (such as a servomotor) to a controlled system and serves as a mechanical control component that transmits torque to the controlled system, orientates the controlled system, and converts motion from rotation to linear motion and vice versa.

(2) Servomotor

(a) DC Servomotor and AC Servomotor

Servomotors are divided into two types: DC servomotors and AC servomotors.

DC servomotors are driven by direct current (DC). They have a long history. Up until the 1980s, the term “servomotor” used to imply a DC servomotor.

From 1984, AC servomotors were emerging as a result of rapid progress in micro-processor technology. Driven by alternating current (AC), AC servomotors are now widely used because of the following advantages:

- Easy maintenance: No brush
- High speed: No limitation in rectification rate

Note however that servomotors and Servopacks use some parts that are subject to mechanical wear or aging. For preventive maintenance, inspect and replace parts at regular intervals.

For details, refer to *Chapter 6 Inspection, Maintenance, and Troubleshooting*.

(b) AC Servomotor

AC servomotors are divided into two types: synchronous type and induction type. The synchronous type is more commonly used.

For a synchronous type servomotor, motor speed is controlled by changing the frequency of alternating current.

A synchronous type servomotor provides strong holding torque when stopped, so this type is ideal when precise positioning is required. Use this type for a servo mechanism for position control.

The following figure illustrates the structure of a synchronous type servomotor:

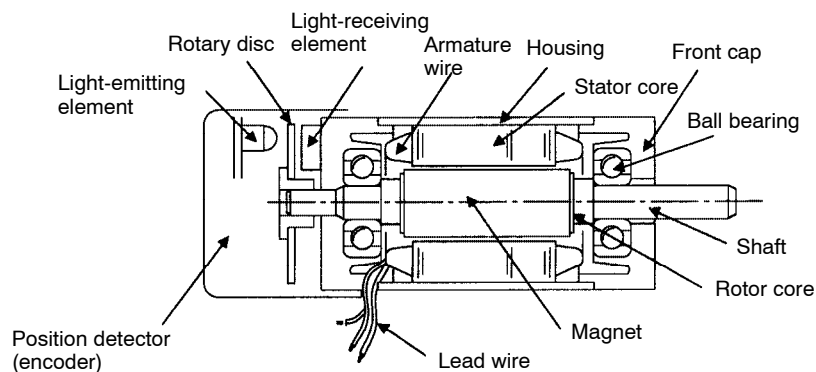

Yaskawa SGM and SGMP Servomotors are of the synchronous type.

(c) Performance of Servomotor

A servomotor must have “instantaneous power” so that it can start as soon as a start reference is received.

The term “power rating (kW/s)” is used to represent instantaneous power.

It refers to the electric power (kW) that a servomotor generates per second.

The greater the power rating, the more powerful the servomotor.

(3) Detector

A servo system requires a position or speed detector. It uses an encoder mounted on a servomotor for this purpose.

Encoders are divided into the following two types:

(a) Incremental Encoder

An incremental encoder is a pulse generator, which generates a certain number of pulses per revolution (e.g., 2,000 pulses per revolution). If this encoder is connected to the mechanical system and one pulse is defined as a certain length (e.g., 0.001 mm), it can be used as a position detector.

However, this encoder does not detect an absolute position and merely outputs a pulse train. Hence zero return operation must be performed before positioning.

The following figure illustrates the operation principle of a pulse generator:

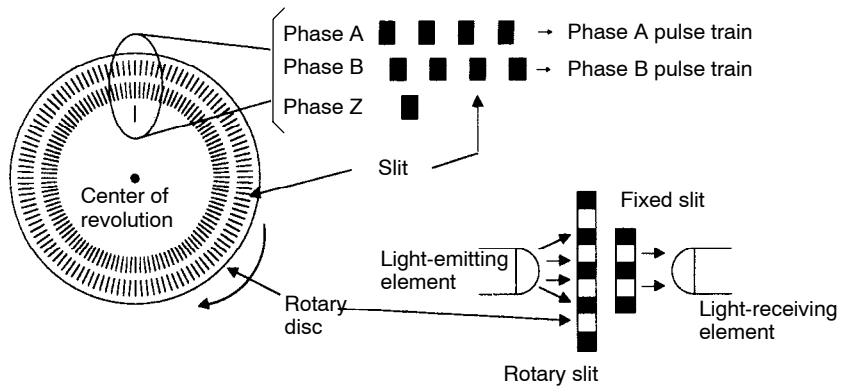

(b) Absolute Encoder

An absolute encoder is designed to detect an absolute angle of rotation as well as to perform the general functions of an incremental encoder. With an absolute encoder, therefore, it is possible to create a system that does not require zero return operation at the beginning of each operation.

- Difference between an absolute and incremental encoder:
An absolute encoder will keep track of the motor shaft position even if system power is lost and some motion occurs during that period of time. The incremental encoder is incapable of the above.

(4) Servo amplifier

A servo amplifier is required to operate an AC servomotor.

The following figure illustrates the configuration of a servo amplifier:

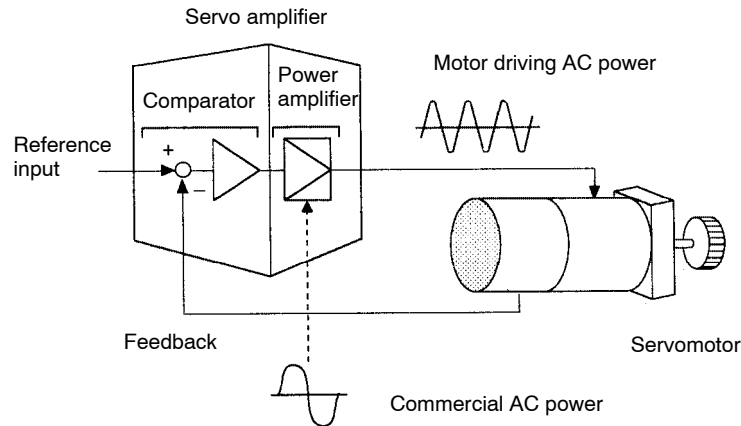

A servo amplifier consists of the following two sections:

(a) Comparator

A comparator consists of a comparison function and a control function. The comparison function compares reference input (position or speed) with a feedback signal and generates a differential signal.

The control function amplifies and transforms the differential signal. In other words, it performs proportional (P) control or **proportional/integral (PI) control**. (It is not important if you do not understand these control terms completely at this point.)

(b) Power Amplifier

A power amplifier runs the servomotor at a speed or torque proportional to the output of the comparator. In other words, from the commercial power supply of 50/60 Hz, it generates alternating current with a frequency proportional to the reference speed and runs the servomotor with this current.

**Proportional/integral (PI) control**

PI control provides more accurate position or speed control than proportional control, which is more commonly used.

(5) Host Controller

A host controller controls a servo amplifier by specifying a position or speed as a set point.

For speed reference, a position control loop may be formed in the host controller when a position feedback signal is received. Yaskawa **PROGIC-8** is a typical host controller.



PROGIC-8

A programmable machine controller. If combined with a servo amplifier for speed control (maximum eight axis control), the PROGIC-8 can provide position control. The PROGIC-8 also provides programmable controller functions.

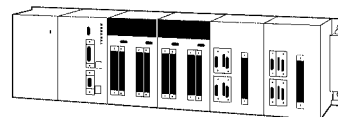

1.1.3 Features of Σ -Series Servos

1) Σ -Series SGM/SGMP Servomotors are synchronous type servomotors and have the following features:

- Size and weight reduced to one-third those of our conventional models.
Compact Servomotor for saving installation space.
- Servo performance (power rating) enhanced to three times that of our conventional models.
Enhanced **power rating (kW/s)** to satisfy every need.
- A wide product range covering rated output of 30 W to 750 W.

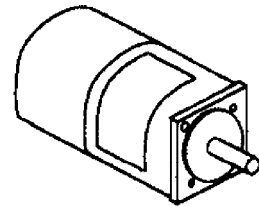

SGM type

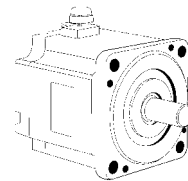

SGMP type

Supply Voltage	Rated Output
100 VAC:	30 W, 50 W, 100 W, 200 W, 300 W (0.04 HP, 0.07 HP, 0.13 HP, 0.27 HP, 0.40 HP)
200 VAC:	30 W, 50 W, 100 W, 200 W, 400 W, 750 W (0.04 HP, 0.07 HP, 0.13 HP, 0.27 HP, 0.53 HP, 1.01 HP)

2) SGDA Servopacks are divided into the following two types according to usage:

- For Speed/Torque Control: SGDA-□□□S Type
This type uses speed or torque reference input. Reference input is by analog voltage.
- For Position Control: SGDA-□□□P Type
This type uses position reference input. Reference input is by pulse train.

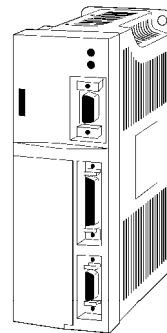

Power rating (kW/s)

A constant that represents response performance of a servomotor. It can be determined by dividing squared rated torque by motor inertia. Power rating is the electric power (kW) that a servomotor can generate per second.

The greater the power rating, the more powerful the servomotor.

3) The most common usage of a Servopack for speed/torque control is shown below:

- Using Servopack for Speed/Torque Control (Speed Control)

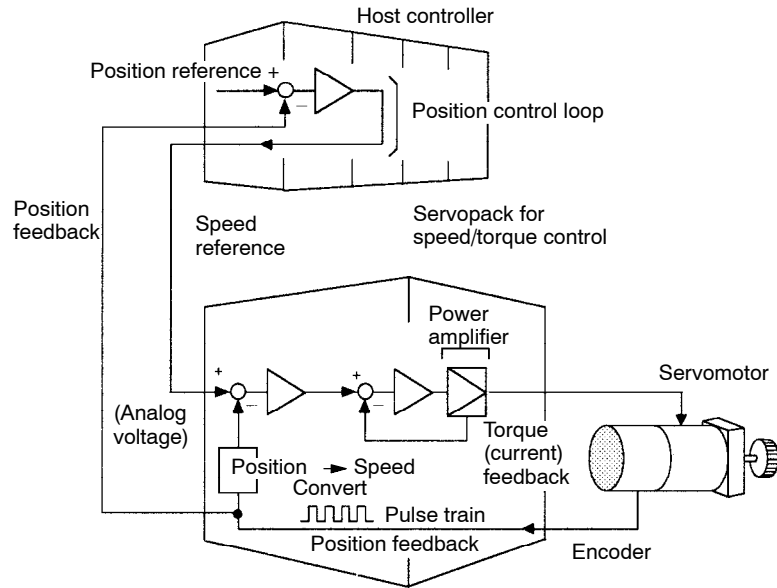

As shown in the figure above, a position control loop is formed in the host controller. The host controller compares a position reference with a position feedback signal and sends processing results to the Servopack as a speed reference.

In this way, the host controller can freely perform the control required for the servo mechanism. The Servopack undertakes the speed control loop and subsequent control processing.

Yaskawa programmable machine controller PROGIC-8 is available as a typical host controller.

4) Servopack for speed/torque control can also provide torque control as shown below.

- Using Servopack for Speed/Torque Control (Torque Control)

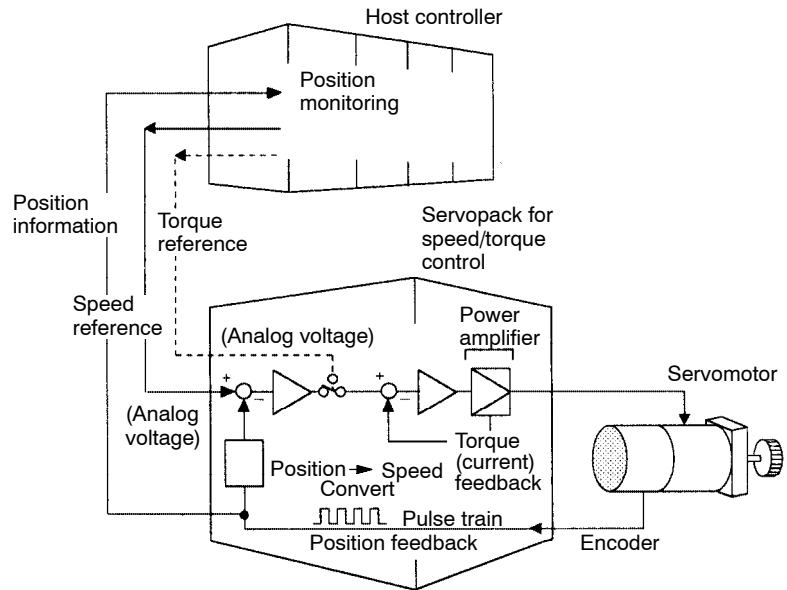

Set the user constants for Servopack to switch between the following torque control modes:

- (1) Controlling servomotor torque by torque reference
(Torque control I)
- (2) Operating servomotor by switching between torque reference and speed reference
(Torque control II)

The host controller outputs a torque reference or speed reference to control the Servopack. It also receives a pulse train (position information) from the Servopack and uses it to monitor the position.

5) Servopack for position control can be used as below.

- Using Servopack for Position Control

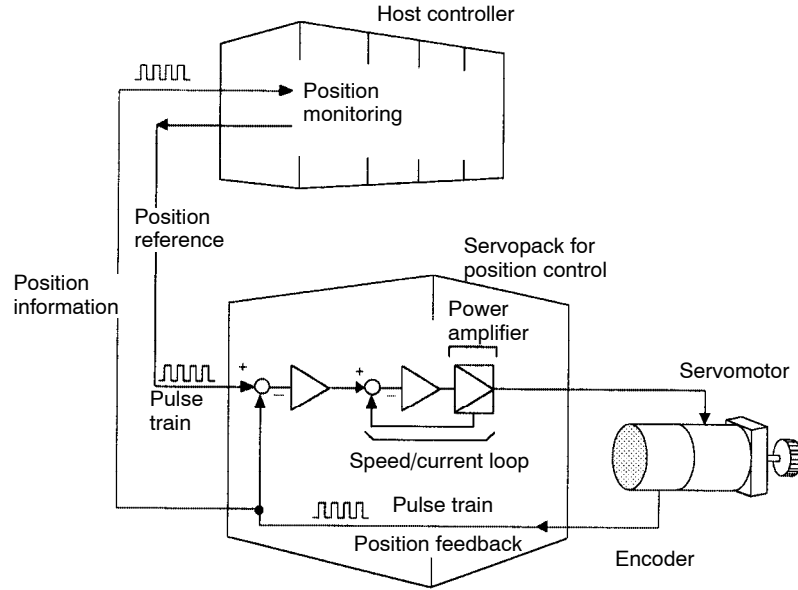

The host controller can send a position reference (pulse train) to the Servopack to perform positioning or interpolation. This type of Servopack contains a position control loop.

User constants can be used to select either of the following pulse trains:

- (1) Code and pulse train
- (2) Two-phase pulse train with 90° phase difference
- (3) Forward and reverse pulse trains

The host controller receives a pulse train (position information) from the Servopack and uses it to monitor the position.

6) A Digital Operator can be used to set user constants for a Servopack as follows:

- (1) Setting user constants to enable or disable each function
- (2) Setting user constants required for functions to be used

Set user constants according to the servo system to be set up.

BASIC USES OF Σ -SERIES PRODUCTS

2

This chapter describes the first things to do when Σ -Series products are delivered. It also explains the most fundamental ways of connecting and operating Σ -Series products. Both first-time and experienced servo users **must read** this chapter.

2.1	Precautions	16
2.1.1	Notes on Use	16
2.2	Installation	18
2.2.1	Checking on Delivery	18
2.2.2	Installing the Servomotor	19
2.2.3	Installing the Servopack	22
2.3	Connection and Wiring	25
2.3.1	Connecting to Peripheral Devices	25
2.3.2	Main Circuit Wiring and Power ON Sequence	28
2.3.3	Examples of Connecting I/O Signal Terminals	30
2.4	Conducting a Test Run	37
2.4.1	Test Run in Two Steps	37
2.4.2	Step 1: Conducting a Test Run for Motor without Load	39
2.4.3	Step 2: Conducting a Test Run with the Motor Connected to the Machine	44
2.4.4	Supplementary Information on Test Run	46
2.4.5	Minimum User Constants Required and Input Signals	48

2.1 Precautions

This section provides notes on using Σ-Series products.

2.1.1 Notes on Use 16

2.1.1 Notes on Use

NOTE Always note the following to ensure safe use.

Two types of supply voltage are available, 100 V and 200 V.

Both Σ-Series Servomotor and Servopack have 100 V and 200 V types. Be sure to use the correct type.

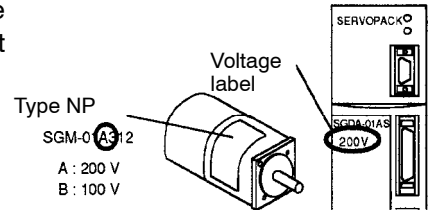

Always use the SGM Servomotor and SGDA Servopack in pairs.

The SGM Servomotor cannot run without the SGDA Servopack. Do not plug the SGM Servomotor directly into the commercial power supply. (Direct connection to the commercial power supply will damage the Servomotor.)

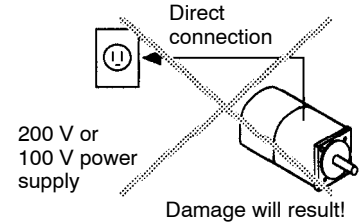

Do not change wiring when power is ON.

Always turn the power OFF before connecting or disconnecting a connector. (Except for Digital Operator (Types: JUSP-OP02A-1, JUSP-OP03A))

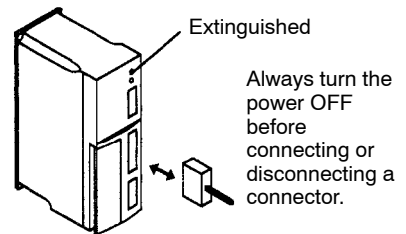

Note that residual voltage still remains in the Servopack even after the power is turned OFF.

Even after the power is turned OFF, residual voltage still remains in the capacitor inside the Servopack. If inspection is to be performed after the power is turned OFF, always wait at least 5 minutes to avoid the risk of an electrical shock.

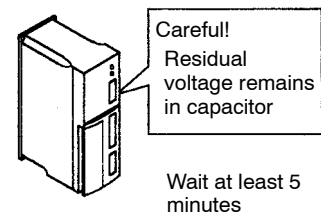

Always follow the specified installation method.

The Servopack generates heat. Install the Servopack so that it can radiate heat freely. Note also that the Servopack must be in an environment free from condensation, vibration and shock.

Provide sufficient clearance

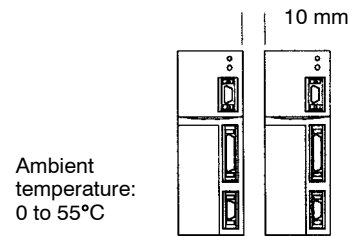

Perform noise reduction and grounding properly.

If the signal line is noisy, vibration or malfunction will result.

- Separate high-voltage cables from low-voltage cables.
- Use cables as short as possible.
- Use at least class 3 grounding (ground resistance 100Ω or below) for the Servomotor and Servopack.
- Never use a line filter for the power supply in the motor circuit.

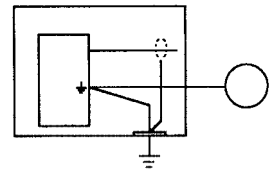

Conduct a voltage resistance test under the following conditions.

- Voltage: 1,500 Vrms AC, one minute
- Braking current: 20 mA
- Frequency: 50/60 Hz
- Voltage applied point: Between R, T terminals and frame ground (connect terminals R and T securely.)



Conduct a dielectric strength test as described on the left.

Use a fast-response type ground-fault interrupter.

For a ground-fault interrupter, always use a fast-response type or one designed for PWM inverters. Do not use a time-delay type.

Ground-fault interrupter

GOOD	GOOD	POOR
Fast-response type	For PWM inverter	Time-delay type

Do not perform continuous operation under overhanging load.

Continuous operation cannot be performed by rotating the motor from the load and applying regenerative braking. Regenerative braking by the Servopack can be applied only for a short period, such as the motor deceleration time.

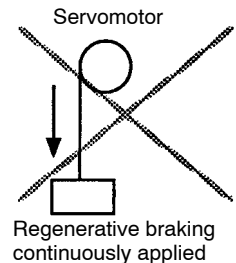

The Servomotor cannot be operated by turning the power ON and OFF.

Frequently turning the power ON and OFF causes the internal circuit elements to deteriorate. Always start or stop the servomotor by using reference pulses.

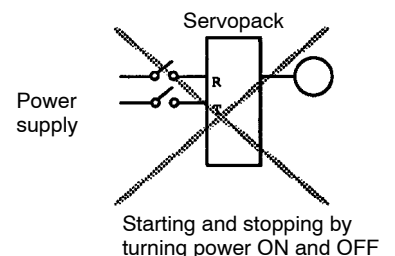

2.2 Installation

This section describes how to check Σ-Series products on delivery and how to install them.

2.2.1	Checking on Delivery	18
2.2.2	Installing the Servomotor	19
2.2.3	Installing the Servopack	22

2.2.1 Checking on Delivery

1) When Σ-Series products are delivered, check the following items:

Check Items	Remarks
Check if the delivered products are the ones you ordered.	Check the types marked on the nameplates of Servomotor and Servopack (see the table below).
Check if the motor shaft rotates smoothly.	If the motor shaft is smoothly turned by hand, it is normal. However, if the motor has brakes, it cannot be turned manually.
Check for damage.	Check the overall appearance, and check for damage or scratches resulting from transportation.
Check screws for looseness.	Check for looseness by using a screwdriver as necessary.

If any of the above items are faulty or incorrect, contact the dealer from which you purchased the products or your nearest local sales representative.

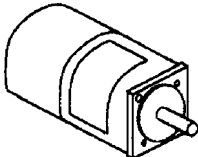
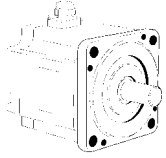
	Appearance	Nameplate	Type
Servomotor	 <p>Σ-Series SGM Servomotor</p>  <p>Σ-Series SGMP Servomotor</p>	<p>Rated output</p> <p>Servomotor type</p> <p>Rated current</p> <p>Rated torque</p> <p>AC SERVO MOTOR SGM-02A312</p> <p>W200 N·m 0.637A 2.0</p> <p>r/min 3000 1995.06</p> <p>S/N 598022-1-3</p> <p>YASKAWA ELECTRIC CORPORATION JAPAN</p> <p>Serial number</p> <p>Manufacturing date</p> <p>Rated rotation speed</p>	<p>SGM-01A312</p> <p>Σ-Series SGM: SGM Servomotor SGMP: SGM Servomotor</p> <p>Rated Output A3:0.04HP A5:0.07HP 01:0.13HP 02:0.27HP 03:0.40HP 04:0.53HP 08:1.01HP</p> <p>Power supply A:200V B:100V</p> <p>Encoder specifications 3: 2048P/R incremental encoder W: 12-bit absolute encoder</p> <p>Design revision order</p> <p>Shaft specifications 2: Straight without key 4: Straight with key 6: Straight with key, shaft end screw hole provided</p> <p>Option B: With brake S: With oil seal D: With brake and oil seal P: Drip-proof provision</p>

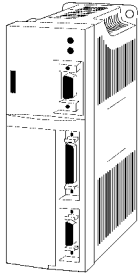
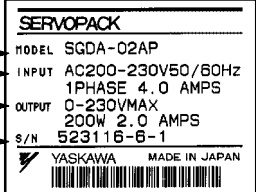
	Appearance	Nameplate	Type
Servo-pack	 <p>Σ-Series SGDA Servopack</p>	<p>Servopack type</p>  <p>Serial number</p> <p>Output power voltage</p> <p>Applicable power supply</p>	<p>SGDA-01ASP</p> <p>Σ-Series SGDA Servopack</p> <p>Rated Output A3:0.04HP A5:0.07HP 01:0.13HP 02:0.27HP 03:0.40HP 04:0.53HP 08:1.01HP</p> <p>Power Supply A : 200 V B : 100 V</p> <p>Type S: For speed/torque control P: For position control</p> <p>Applicable motor Blank: SGM Servomotor P: SGMP Servomotor</p>

2.2.2 Installing the Servomotor

Servomotor SGM and SGMP types can be installed either horizontally or vertically. However, if the Servomotor is installed incorrectly or in an inappropriate location, the service life will be shortened or unexpected problems will occur. To prevent this, always observe the installation instructions described below.

Before installation:

Anticorrosive paint is coated on the edge of the motor shaft. Clean off the anticorrosive paint thoroughly using a cloth moistened with thinner.

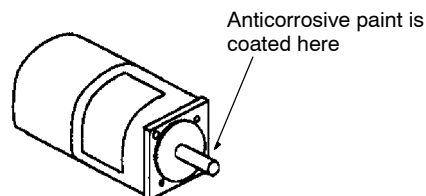

NOTE Avoid getting thinner on other parts of the Servomotor when cleaning the shaft.

Storage:

When the Servomotor is to be stored with the power cable disconnected, store it in the following temperature range:

Between -20°C and 60°C

Installation sites:

The Servomotor SGM and SGMP types are designed for indoor use. Install Servomotor in an environment which meets the following conditions:

- Free from corrosive and explosive gases

- Well-ventilated and free from dust and moisture
- Ambient temperature of 0 to 40°C
- Relative humidity of 20% to 80% (non-condensing)
- Inspection and cleaning can be performed easily

If the Servomotor is used in a location subject to water or oil mist, install a shield cover over the Servomotor.

2

Alignment:

Align the shaft of the Servomotor with that of the equipment to be controlled, then connect the shafts with couplings. Install the Servomotor so that alignment accuracy falls within the range shown below.

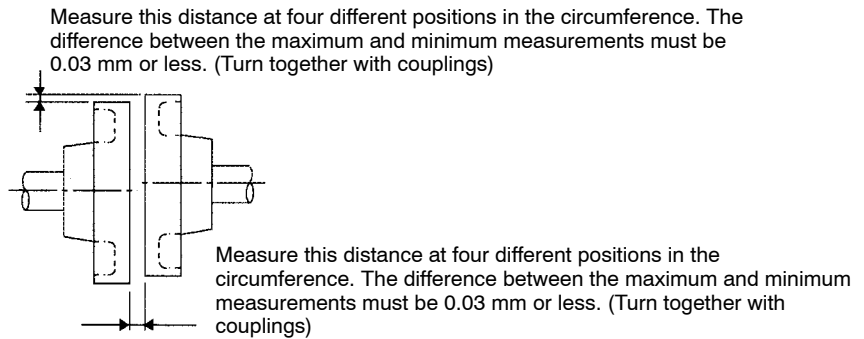

NOTE If the shafts are not aligned properly, vibration will occur, resulting in damage to the bearings.

Mechanical shock to the shaft end must be less than 98m/s² (10G) and must be applied no more than twice.

Design the mechanical system so that **thrust load and radial load** applied to the servomotor shaft end during operation falls within the range shown in the following table.



Thrust load and radial load

1. Thrust load: Shaft-end load applied parallel to the centerline of a shaft
2. Radial load: Shaft-end load applied perpendicular to the centerline of a shaft

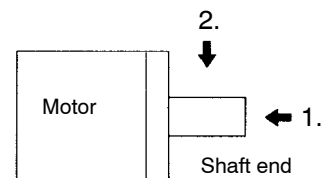

- Servomotor with incremental encoder

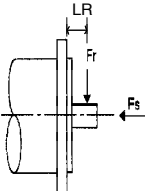
Motor Type	Allowable Radial Load Fr [N(lb)]	Allowable Thrust Load Fs [N(lb)]	LR mm (in.)	Reference Drawing
SGM-A3	68 (15)	54 (12)	20 (0.82)	
SGM-A5	68 (15)	54 (12)	20 (0.82)	
SGM-01	78 (17)	54 (12)	20 (0.82)	
SGM-02	245 (55)	74 (16)	25 (1.02)	
SGM-03	245 (55)	74 (16)	25 (1.02)	
SGM-04	245 (55)	74 (16)	25 (1.02)	
SGM-08	392 (88)	147 (33)	35 (1.43)	
SGMP-01	78 (17)	49 (11)	20 (0.82)	
SGMP-02	245 (55)	68 (15)	25 (1.02)	
SGMP-03	245 (55)	68 (15)	25 (1.02)	
SGMP-04	245 (55)	69 (15)	25 (1.02)	
SGMP-08	392 (88)	147 (33)	35 (1.43)	

- Servomotor with absolute encoder

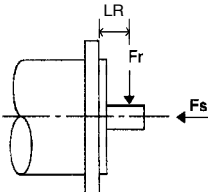
Motor Type	Allowable Radial Load Fr [N(lb)]	Allowable Thrust Load Fs [N(lb)]	LR mm (in.)	Reference Drawing
SGM-A3	49 (11)	19 (4)	20 (0.82)	
SGM-A5	68 (15)	19 (4)	20 (0.82)	
SGM-01	68 (15)	19 (4)	20 (0.82)	
SGM-02	196 (44)	49 (11)	25 (1.02)	
SGM-03	196 (44)	49 (11)	25 (1.02)	
SGM-04	196 (44)	68 (15)	25 (1.02)	
SGM-08	343 (77)	98 (22)	35 (1.43)	
SGMP-01	78 (17)	49 (11)	20 (0.82)	
SGMP-02	245 (55)	68 (15)	25 (1.02)	
SGMP-03	245 (55)	68 (15)	25 (1.02)	
SGMP-04	245 (55)	69 (15)	25 (1.02)	
SGMP-08	392 (88)	147 (33)	35 (1.43)	

Note The radial load and thrust load values shown above are the maximum allowed values for the sum of the load generated by motor torque and the load externally applied to the shaft.

2.2.3 Installing the Servopack

Σ-Series SGDA Servopack is a book-shaped compact servo controller.

Incorrect installation will cause problems. Always observe the installation instructions described in the next page.

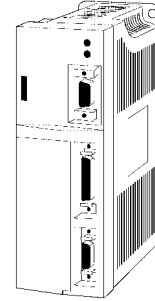

SGDA Servopack

Storage:

When the Servopack is to be stored with the power cable disconnected, store it in the following temperature range:

Between -20°C and 85°C

Installation sites:

Situation	Notes on Installation
When installed in a control panel	Design the control panel size, unit layout, and cooling method so that the temperature around the periphery of the Servopack does not exceed 55°C .
When installed near a heating unit	Suppress radiation heat from the heating unit and a temperature rise caused by convection so that the temperature around the periphery of the Servopack does not exceed 55°C .
When installed near a source of vibration	Install a vibration isolator underneath the Servopack to prevent it from receiving vibration.
When installed in a place receiving corrosive gases	Corrosive gases do not immediately affect the Servopack but will eventually cause contactor-related devices to malfunction. Take appropriate action to prevent corrosive gases.
Others	Avoid installation in a hot and humid place or where excessive dust or iron powder is present in the air.

Orientation:

Install the Servopack perpendicular to the wall as shown in the figure.

The Servopack must be orientated as shown in the figure because it is designed to be cooled by natural convection.

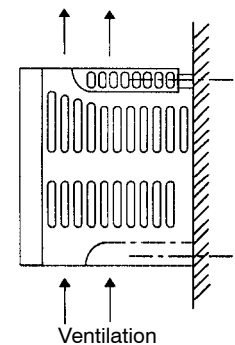

- Firmly secure the Servopack through three or four mounting holes.

Installation method:

When installing multiple Servopacks side by side in a control panel, observe the following installation method:

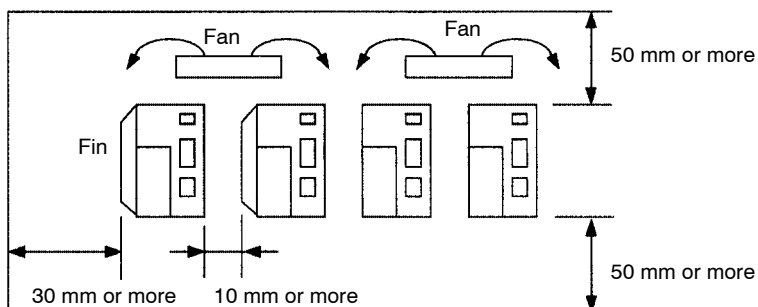

- Install Servopack perpendicular to the wall so that the front panel (containing connectors) faces outward.
- Provide sufficient space around each Servopack to allow cooling by natural convection.

2.2.3 Installing the Servopack cont.

- c) When installing Servopacks side by side, provide at least 10 mm space between them and at least 50 mm space above and below them as shown in the figure above. Install cooling fans above the Servopacks to prevent the temperature around each Servopack from increasing excessively and also to maintain the temperature inside the control panel evenly.
- d) Maintain the following conditions inside the control panel:
- Ambient temperature for Servopack: 0 to 55°C
 - Humidity: 90%RH or less
 - Vibration: 0.5G (4.9 m/s²)
 - Condensation and freezing: None
 - Ambient temperature to ensure long-term reliability: 45°C or less

2.3 Connection and Wiring

This section describes how to connect Σ -Series products to peripheral devices and explains a typical example of wiring the main circuit. It also describes an example of connecting to main host controllers.

2.3.1	Connecting to Peripheral Devices	25
2.3.2	Main Circuit Wiring and Power ON Sequence	28
2.3.3	Examples of Connecting I/O Signal Terminals	30

2.3.1 Connecting to Peripheral Devices

This section shows a standard example of connecting Σ -Series products to peripheral devices and briefly explains how to connect to each peripheral device.

Standard connection method for Σ -Series AC Servo Drives:

Molded-case circuit breaker (MCCB)

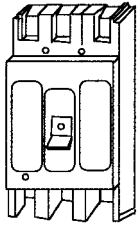

Used to protect power supply line. Shuts the circuit off when overcurrent is detected.

Noise filter

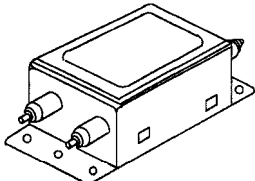

Used to eliminate external noise from power supply line.

Types: LF-205A (for SGDA-A3A, A5B, 01A, 02A, A3B, A5B, and 01B)
 LF-210 (for SGDA-04A and 02B)
 LF-220 (for SGDA-03B and 08A)

Magnetic contactor

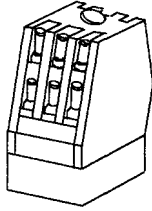

Turns the servo ON or OFF. Use a surge suppressor for the magnetic contactor.

Type: HI-15E5 (30 A)

Brake power supply

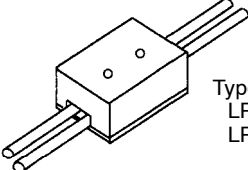

Used for Servomotor with brake.

Types: LPSE-2H01 (for 200 V input)
 LPDE-1H01 (for 100 V input)

Regenerative unit

Type: JUSP-RG08

Exterior type regenerative resistor

Type: JUSP-RG08C

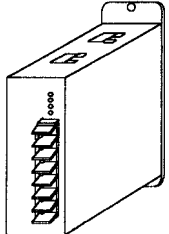

Digital

Allows the user to set user constants or operation references and display operation status or alarm status. The following two types are available in addition to personal computers:

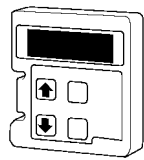

Mount type (JUSP-OP03A)
 This type can be mounted directly on the Servopack.

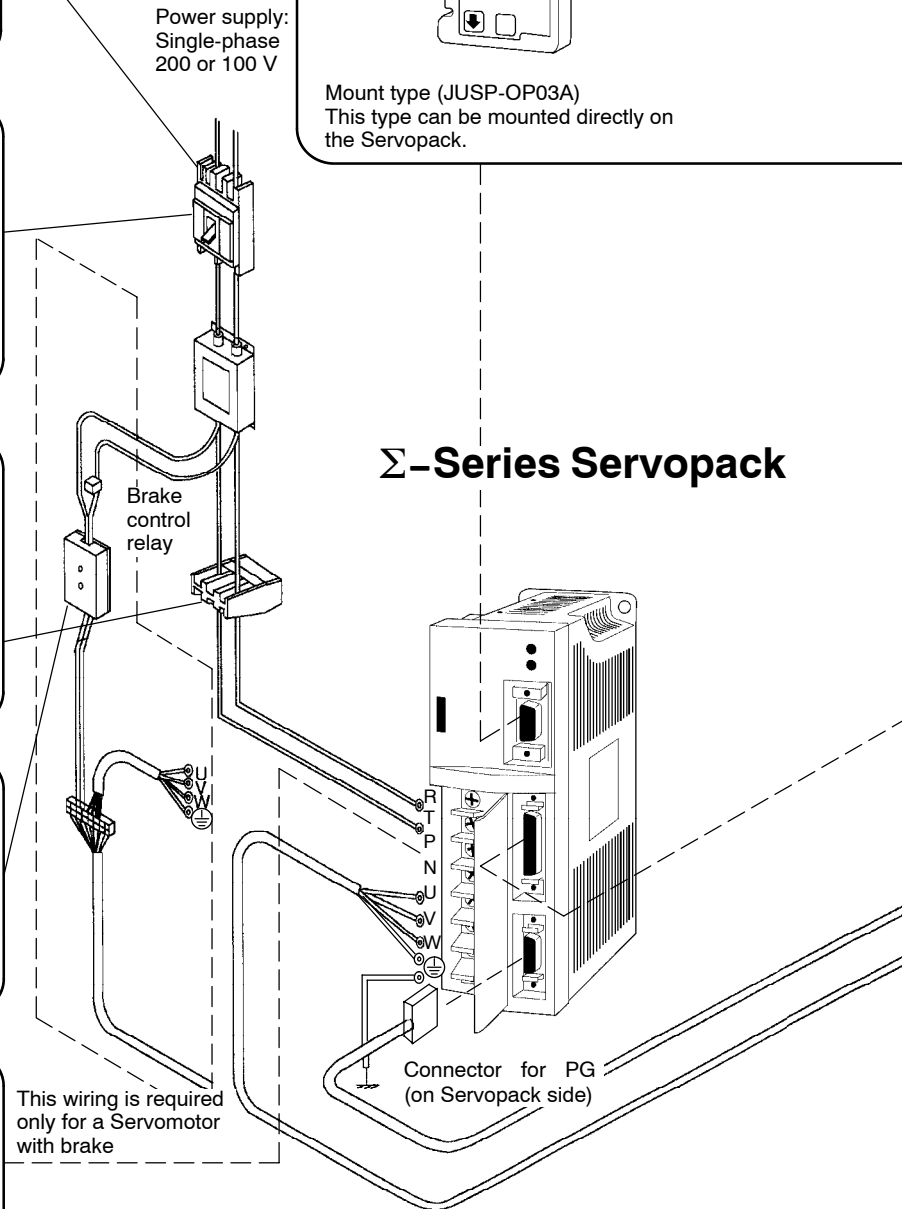

Connector kits for pulse generator (PG) and for motor are not required if the following parts are ordered:

- Cable with terminal connectors
- Cable with connector and amplifier terminal

Operator

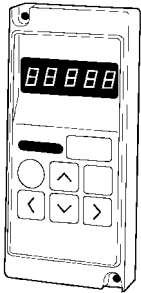

Hand-held type
(JUSP-OP02A-1)
1-meter(3.3ft.) cable included

Personal computer

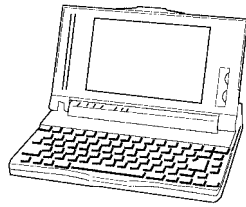

Exclusive-use cable between personal computer and Servopack (for NEC PC) is available.
Type: DE9405258 (2m, 6.6ft.)
Consult factory about cable for IBM PC (IBM compatible PC).

Host controller

Servopack is compatible with most P.L.C. motion controllers and indexers.

References are input as analog signals or pulse trains.

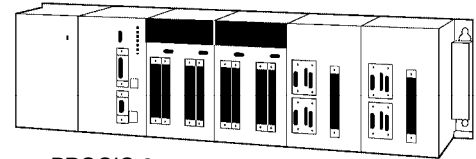

PROGIC-8

1CN connector kit

(Type: DP9420007)



1-meter cable with 1CN connector and one end without connector

(Type: DE9404859)

1CN

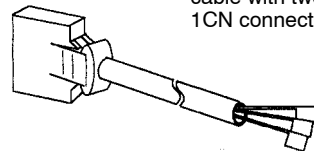

Connector terminal block conversion unit

(Type: JUSP-TA36P)

The terminal block allows connection to a host controller.

0.5-meter (1.6ft) cable with two 1CN connectors



Cable for PG

This cable is used to connect a Servomotor encoder to a Servopack.

The following two types of cable are available according to the encoder type:

- Cable for incremental encoder (with connector on both ends)

9.8ft: DP9320089-1	16.4ft: DP9320089-2
32.8ft: DP9320089-3	49.2ft: DP9320089-4
65.6ft: DP9320089-5	

- Cable for absolute encoder (with connectors on both ends)

9.8ft: DP9320088-1	16.4ft: DP9320088-2
32.8ft: DP9320088-3	49.2ft: DP9320088-4
65.6ft: DP9320088-5	

A cable with a single connector (without connector on Servopack side) and a cable without connectors are also available.

Connector kit for PG

On Servomotor side



On Servopack side

2CN



This connector kit is required for cables without connectors. For moving parts, a cable for robot must be ordered separately.

Connector for PG (on motor side)

Connector for motor

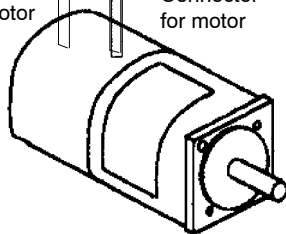

Σ-Series Servomotor

Cable for motor

This is a power cable for connecting a Servomotor to a Servopack.

For a Servomotor with brake, this cable is also used to wire the brake.

- Without brake (connector and amplifier terminal included)

9.8ft: DP9320081-1	16.4ft: DP9320081-2
32.8ft: DP9320081-3	49.2ft: DP9320081-4
65.6ft: DP9320081-5	
- With brake (connector and amplifier terminal included)

9.8ft: DP9320083-1	16.4ft: DP9320083-2
32.8ft: DP9320083-3	49.2ft: DP9320083-4
65.6ft: DP9320083-5	

A cable without connector and amplifier terminal is also available.

Connector kit for motor

Connector for motor (on motor side)



This connector kit is required for cables without connector and amplifier terminal.

2.3.2 Main Circuit Wiring and Power ON Sequence

1) The following diagram shows a typical example of wiring the main circuit for Σ-Series products:

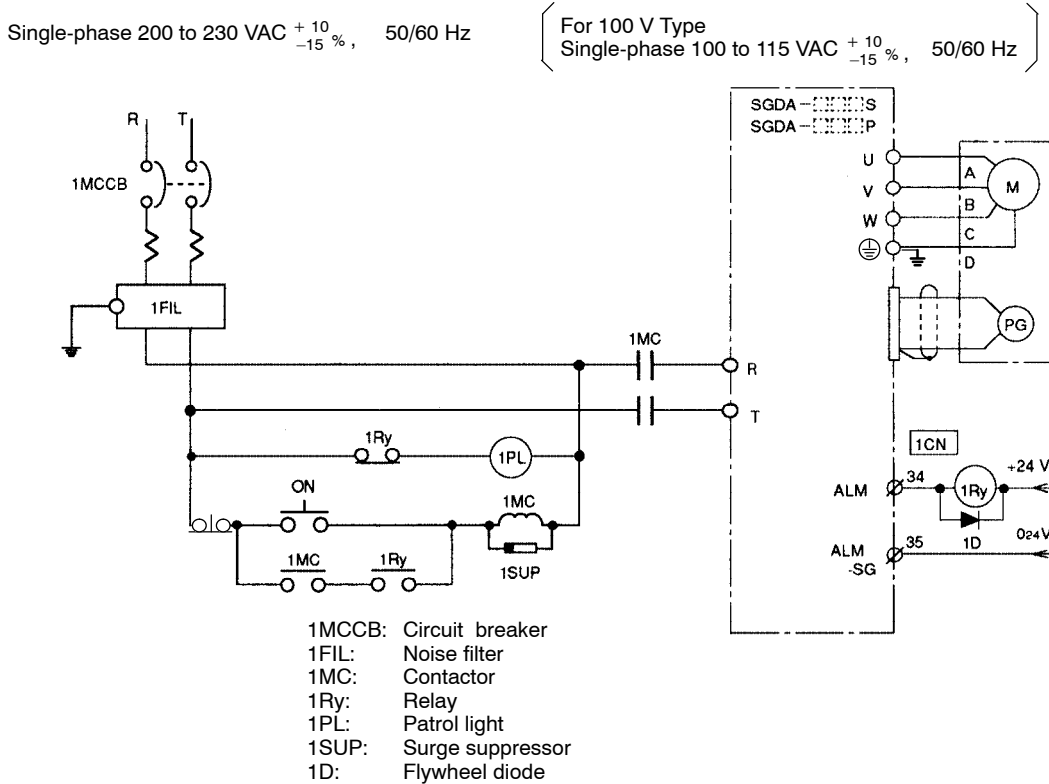

2) The following table shows the name and description of each main circuit terminal:

Terminal Symbol	Name	Description
(R)(T)	Main circuit AC input terminal	Single-phase 200 to 230 VAC $\begin{matrix} +10 \\ -15 \end{matrix} \%$, 50/60Hz*
(U)(V)(W)	Motor connection terminal	Connect U to the red motor terminal, V to the white motor terminal, and W to the blue motor terminal
(⊕)	Ground terminal	Connect to the motor ground terminal (green) for grounding purposes.
(P)(N)	Regenerative unit connection terminal	Connect to a regenerative unit when applicable.

* For 100 V power supply: Single-phase 100 to 115 VAC $\begin{matrix} +10 \\ -15 \end{matrix} \%$, 50/60Hz

- 3) Form a power ON sequence as follows:
- Form a power ON sequence so that the power is turned OFF when a servo alarm signal is output. (See the circuit diagram shown on the previous page.)
 - Hold down the power ON push-button for at least two seconds. The Servopack outputs a servo alarm signal for approximately two seconds or less when the power is turned ON. This operation is required to initialize the Servopack.

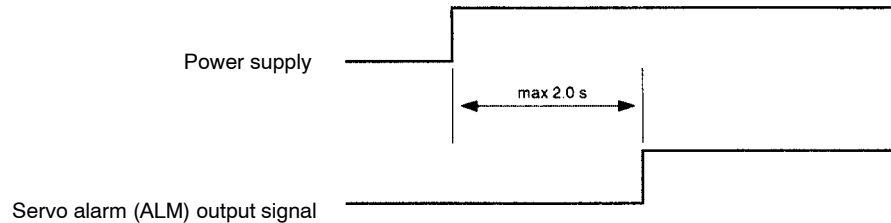

NOTE After turning the power OFF, do not touch the power terminals for 5 minutes. High voltage may remain in the Servopack.

- Avoid frequently turning the power ON and OFF. Since the Servopack has a capacitor in the power supply, a high charging current flows (for 0.2 second) when the power is turned ON. Therefore, frequently turning the power ON and OFF causes the main power devices (such as capacitors and fuses) to deteriorate, resulting in unexpected problems.
- If the Servopack is turned ON immediately after being turned OFF, a power loss alarm may arise. To prevent this, always wait for the time shown in the following table before turning the power ON again:

	Single-phase 200 VAC	Single-phase 100 VAC	Power Holding Time
Servopack Type SGDA-	A3A□, A5A□	A3B□	6 seconds
	01A□, 02A□, 04A□	A5B□, 01B□, 02B□	10 seconds
	08A□	03B	15 seconds

2.3.3 Examples of Connecting I/O Signal Terminals

1) This sub-section provides typical examples of connecting to main host controllers. Connection to other host controllers is also possible. Connect to the host controller according to the connection examples shown below by referring to technical documentation for the host controller.

NOTE This sub-section describes signals related to the SGDA Servopack only. For other signals, refer to the relevant technical documentation.

2) Example of Connecting to PROGIC-8

2

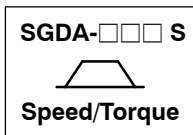

Servopack for Speed/Torque Control

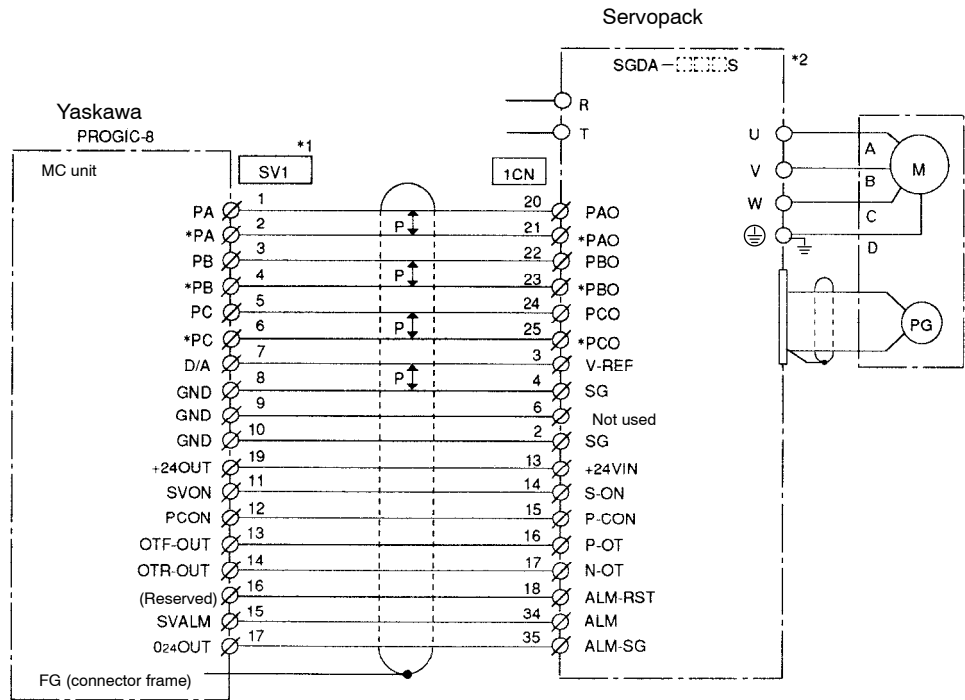

*1 These pin numbers are also applicable to SV2 to SV4.

*2 Do not change the standard settings of user constants for the Servopack.

3) Example of Connecting to GL-Series Positioning Module B2833

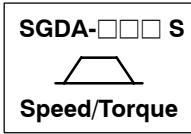

Servopack for Speed/Torque Control

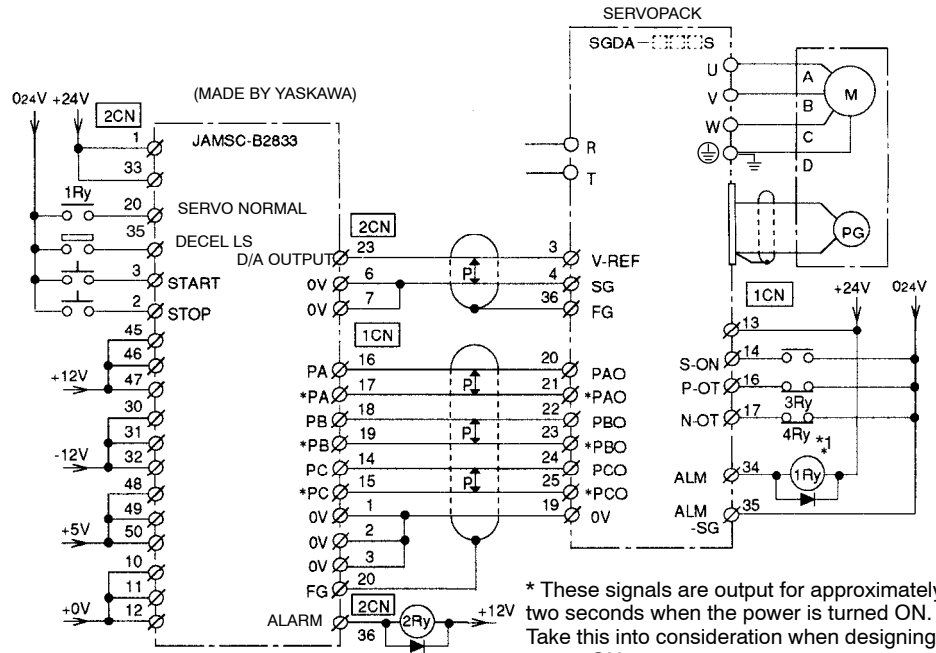

* These signals are output for approximately two seconds when the power is turned ON. Take this into consideration when designing a power ON sequence. Relay 1Ry is used to stop main circuit power supply to the Servopack.

4) Example of Connecting to GL-Series Positioning Module B2813

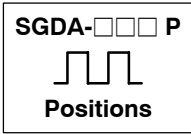

Servopack for Position Control

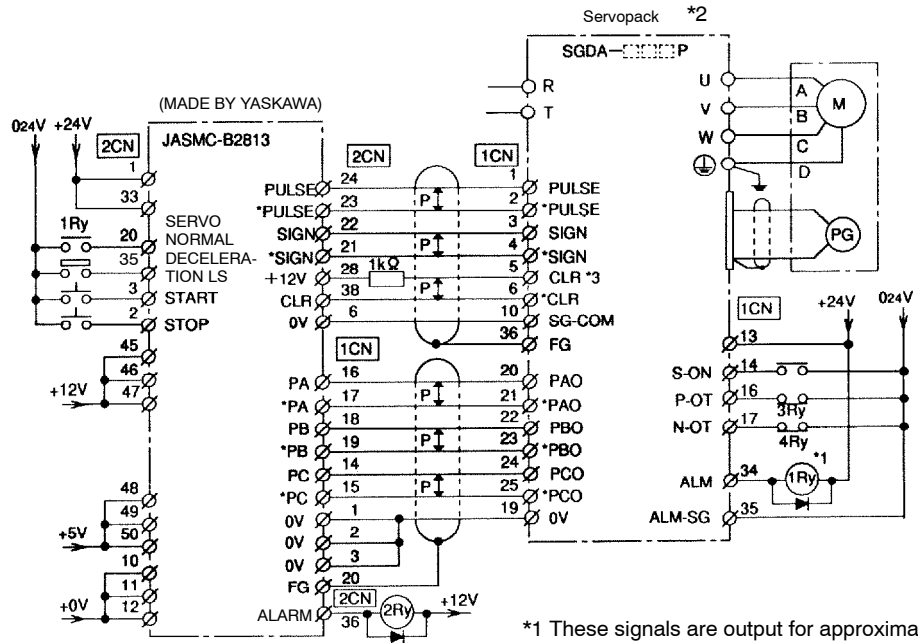

*1 These signals are output for approximately two seconds when the power is turned ON. Take this into consideration when designing a power ON sequence. Relay 1Ry is used to stop main circuit power supply to Servopack.

*2 Change the Cn-02 setting as follows:
 Bit No. 3 = 1
 Bit No. 4 = 0
 Bit No. 5 = 0

*3 Pull up the CLR signal with 1 kΩ resistance.
 Change the Cn-02 setting as follows:
 Bit No. A = 1

2

5) Example of Connecting to OMRON Position Control Unit C500-NC222

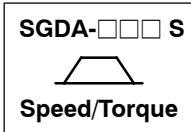

Servopack for Speed/Torque Control

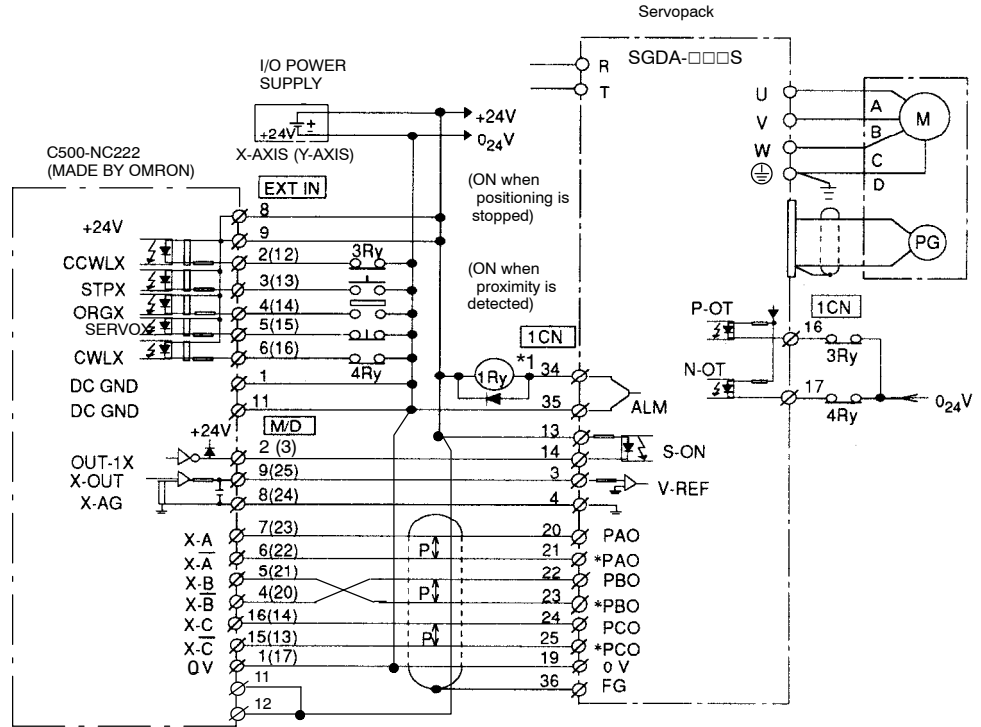

*1 These signals are output for approximately two seconds when the power is turned ON. Take this into consideration when designing a power ON sequence. Relay 1Ry is used to stop main circuit power supply to Servopack.

Note The signals shown here are applicable only to OMRON Sequencer C500-NC222 and Yaskawa Servopack SGDA-□□□S.

2

6) Example of Connecting to OMRON Position Control Unit C500-NC112



Servopack for Position Control

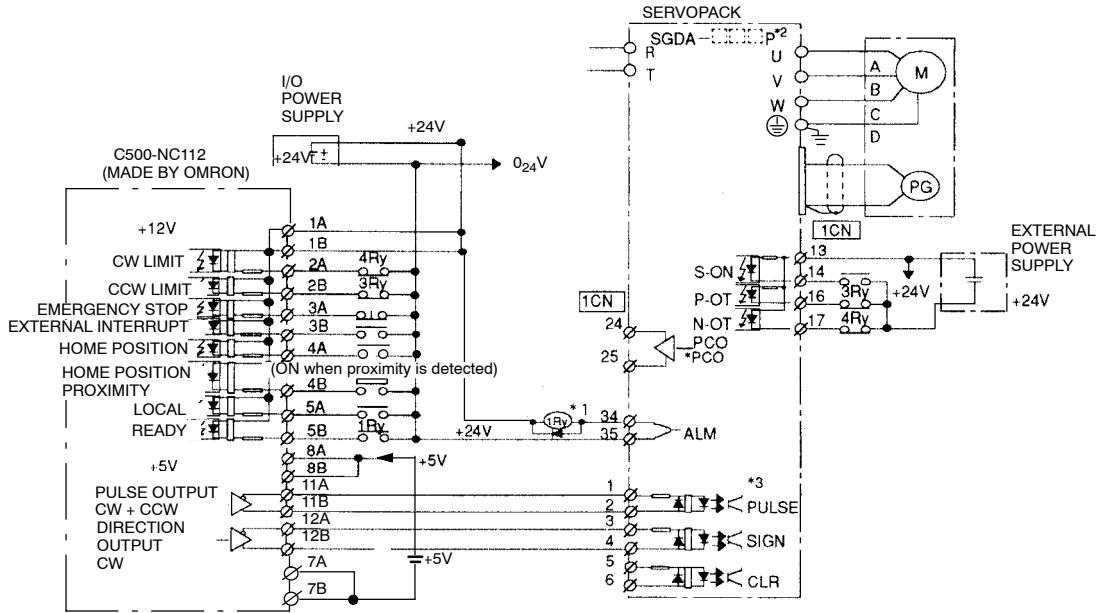

*1 These signals are output for approximately two seconds when the power is turned ON. Take this into consideration when designing a power ON sequence. Relay 1Ry is used to stop main circuit power supply to Servopack.

*2 Change the Cn-02 setting as follows:
 Bit No. 3 = 1
 Bit No. 4 = 0
 Bit No. 5 = 0

Note The signals shown here are applicable only to OMRON Sequencer C500-NC112 and Yaskawa Servopack SGDA-□□□P.

2

7) Example of Connecting to MITSUBISHI Positioning Unit AD72

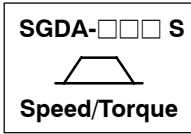

Servopack for Speed/Torque Control

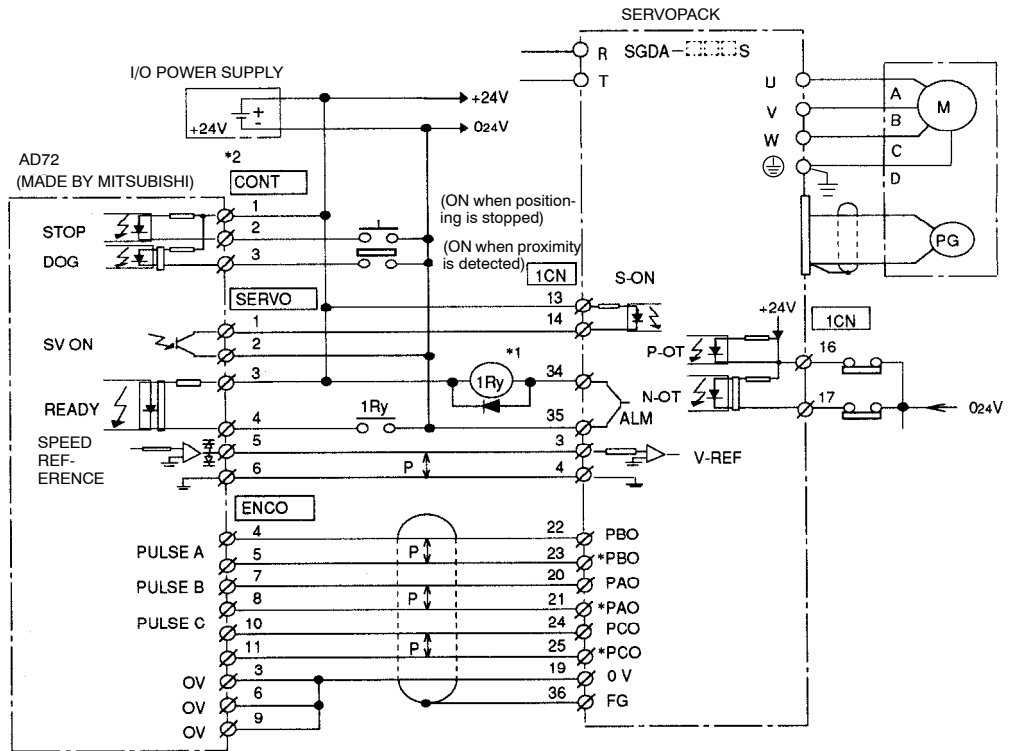

*1 These signals are output for approximately two seconds when the power is turned ON. Take this into consideration when designing a power ON sequence. Relay 1Ry is used to stop main circuit power supply to Servopack.

*2 These pin numbers are the same for both X and Y axes.

Note The signals shown here are applicable only to MITSUBISHI Sequencer AD72 and Yaskawa Servopack SGDA-□□□S.

2

8) Example of Connecting to MITSUBISHI Positioning Unit AD71 (B Type)

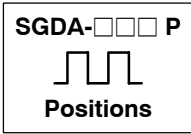

Servopack for Position Control

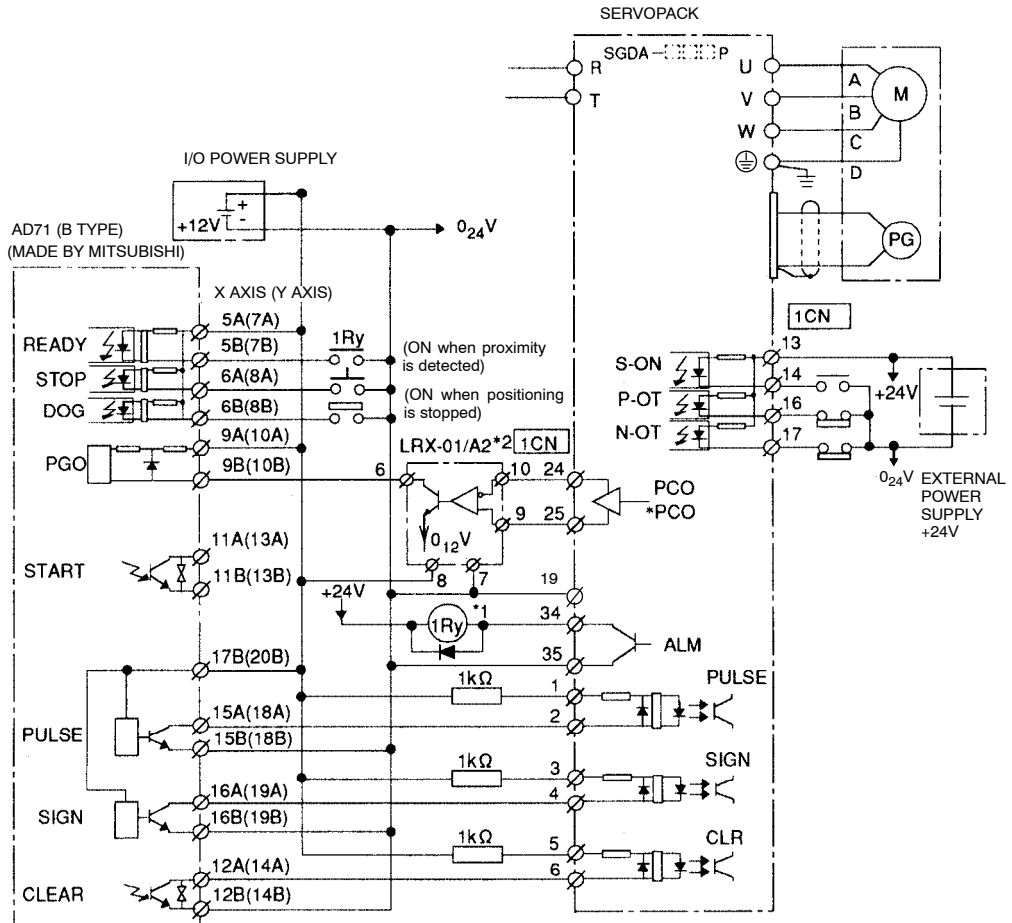

*1 These signals are output for approximately two seconds when the power is turned ON. Take this into consideration when designing a power ON sequence. Relay 1Ry is used to stop main circuit power supply to Servopack.

*2 Manufactured by Yaskawa Controls Co., Ltd.

Note The signals shown here are applicable only to MITSUBISHI Sequencer AD71 (B Type) and Yaskawa Servopack SGDA-□□□P.

2

2.4 Conducting a Test Run

This section describes how to conduct a full test run. The test run is divided into two steps. Complete a test run in step 1 first, then proceed to step 2.

2.4.1	Test Run in Two Steps	37
2.4.2	Step 1: Conducting a Test Run for Motor without Load	39
2.4.3	Step 2: Conducting a Test Run with the Motor Connected to the Machine	44
2.4.4	Supplementary Information on Test Run	46
2.4.5	Minimum User Constants Required and Input Signals	48

2.4.1 Test Run in Two Steps

Conduct the test run when wiring is complete.

Generally, conducting a test run for servo drives can be difficult. However, by following the two steps described below, the test run can be performed safely and correctly.

NOTE To prevent accidents, initially conduct a test run only for a servomotor under no load (i.e., with all couplings and belts disconnected). Do not run the servomotor while it is connected to a machine.

The test run is divided here into steps 1 and 2.

Complete the test run in step 1 first, then proceed to step 2. The purposes of each step are described on the next page.

2

Step 1: Conducting a test run for the motor without load . . . Check that the motor is wired correctly.

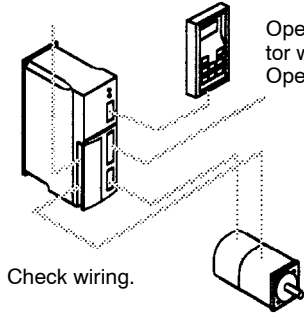

Operate the motor with a Digital Operator.

Check wiring.

Do not connect to a machine.

Conduct a test run with the motor shaft disconnected from the machine.

Purpose:

- To check power supply circuit wiring
- To check motor wiring
- To check I/O signal (1CN) wiring

Outline:

- Turn the power ON.
- Operate the motor with a digital operator.
- Check I/O signals (1CN).
- Conduct a test run using I/O signals.

Step 2: Conducting a test run with the motor and machine connected Adjust Servopack according to machine characteristics.

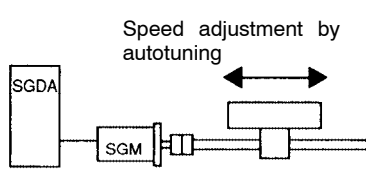

Speed adjustment by autotuning

Connect to the machine.

Adjust Servopack according to machine characteristics.

Connect to the machine and conduct a test run.

Purpose:

- To perform autotuning to adjust the motor according to machine characteristics
- To match the speed and direction of rotation with the machine specifications
- To check the final control mode

Outline:

- Perform autotuning.
- Adjust user constant settings.
- Record user constant settings.

End of test run

For customers who use a servomotor with a brake, refer to *Section 2.4.4 Supplementary Information on Test Run* before starting a test run.

The following pages describe the test run procedure in detail.

2.4.2 Step 1: Conducting a Test Run for Motor without Load

Check that the motor is wired correctly.

If the motor fails to rotate properly during a servo drive test run, the cause most frequently lies in incorrect wiring.

Conduct a test run for the motor without load according to the procedure described below. For customers who use a servomotor with brake, refer to *Section 2.4.4 Supplemental Information on Test Run* before starting a test run.

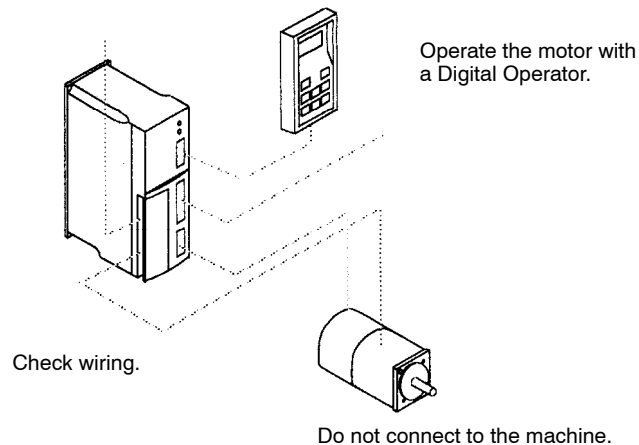

(1) Secure the servomotor.

Secure the servomotor to mounting holes to prevent it from moving during operation. Alternatively, install the servomotor on the machine and disconnect couplings and belts.

Secure servomotor to mounting holes.

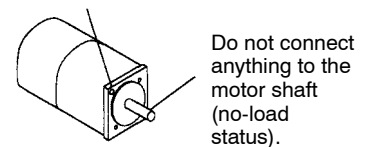

(2) Disconnect connector 1CN, then check the motor wiring in the power supply circuit. I/O signals (1CN) are not to be used so leave connector 1CN disconnected.

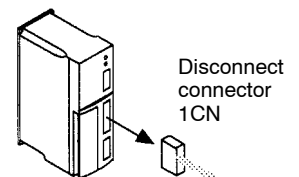

Note: When absolute encoder is used, connect the battery. Also, initialize the absolute encoder.

See 3.8.5 *Using an Absolute Encoder* for details.

(3) Short the alarm signal circuit.

Because connector 1CN is disconnected, the alarm signal prevents the power supply circuit from being turned ON. Therefore, temporarily short the alarm signal circuit.

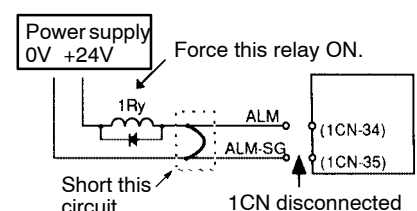

- (4) Turn the power ON.
 Turn the Servopack power ON. If the Servopack is turned ON normally, the LED on the Digital Operator lights up as shown in the figure.
 Power is not supplied to the servomotor because the servo is OFF.

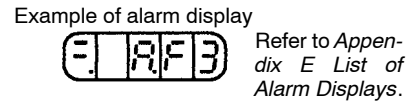
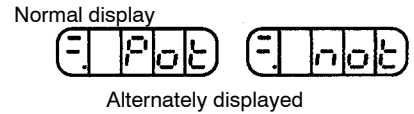

If an alarm display appears on the LED as shown in the figure above, the power supply circuit, motor wiring or encoder wiring is incorrect. In this case, turn the power OFF, then correct the problem.

Note: When absolute encoder is used, perform the following procedures after turning ON the power.

- ① Set the bit E of Cn-01 to 1.
- ② Set the number of encoder pulses (Cn-11) to 1024.
- ③ Set the dividing ratio of encoder pulses (Cn-0A) to 1024 or below.
- ④ Turn OFF the power once. Then turn ON the power again after checking if the displays of digital operator extinguish.

(5) Operate using the Digital Operator

Operate the motor with the Digital Operator. Check that the motor runs normally.

Refer to 4.2.2 Operating Using the Digital Operator.

Operation by Digital Operator

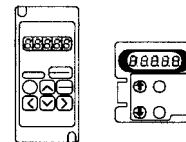

If an alarm occurs, the power supply circuit, motor wiring, or encoder wiring is incorrect.

(6) Connect signal lines.

Connect connector 1CN as follows:

- (1) Turn the power OFF.
- (2) Return the alarm signal circuit shorted in the above step (3) to its original state.
- (3) Connect connector 1CN.
- (4) Turn the power ON again.

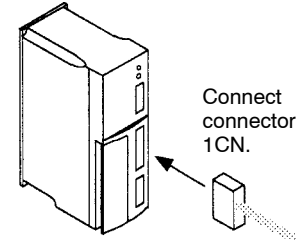
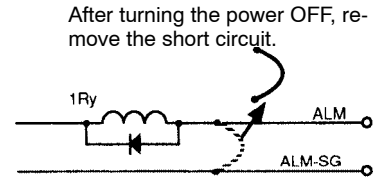

(7) Check input signals.

Check the input signal wiring in monitor mode. For the checking method, refer to 4.1.6 Operation in Monitor Mode.

- Checking method
Turn each connected signal line ON and OFF to check that the monitor bit display changes accordingly.

Example of Internal status bit display (Un-05, Un-06)

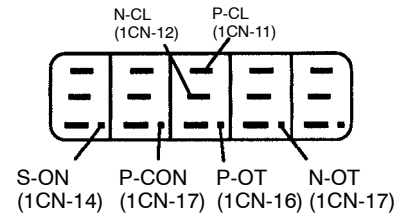

The memory switch can be used to eliminate the need for external short-circuits in wiring (see pages 55 and 128).

Input Signal	ON/OFF	Monitor Bit Display
High level or open	OFF	Extinguished
0 V level	ON	Lit

If the signal lines below are not wired correctly, the motor fails to rotate. Always wire them correctly. (If signal lines are not to be used, short them as necessary.)

P-OT	1CN-16	Motor can rotate in forward direction when this input signal is at 0 V.
N-OT	1CN-17	Motor can reverse when this input signal is at 0 V.
S-ON	1CN-14	Servo is turned ON when this input signal is at 0 V. However, leave the servo in OFF status.

(8) Turn servo (motor) ON.

Turn the servo ON as follows:

- (1) Check that no reference has been input.

For speed/torque control (SGDA-□□□S):
V-REF (1CN-3) and T-REF (1CN-1) are at 0 V.

For position control (SGDA-□□□P):
PULS (1CN-1) and SIGN (1CN-3) are fixed.

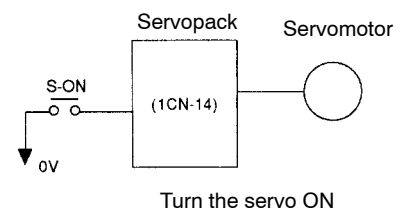

(2) Turn the servo ON signal ON.

Display when servo is turned ON

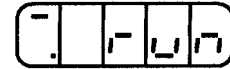

Set S-ON (1CN-14) to 0 V. If normal, the motor is turned ON and the Digital Operator displays the data as shown in the figure. If an alarm display appears, take appropriate action as described in *Appendix E List of Alarm Displays*.

(9) Operate by reference input.

The operating procedure differs according to the Servopack control mode used.

2

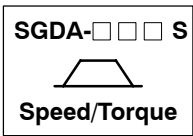

Servopack for Speed/Torque

(This section describes the standard speed control setting.)

(1) Gradually increase the speed reference input (V-REF, 1CN-3) voltage. The motor will rotate.

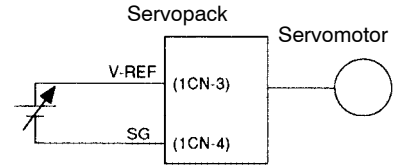

Servomotor rotates at a speed proportional to the reference voltage.

When a host controller such as a programmable controller performs position control, it may be difficult to directly input the speed reference voltage. In this case, constant voltage reference should be input once to ensure correct operation.

(2) Check the following items in monitor mode (see page 179):

- (1) Has a reference speed been input?
- (2) Is the motor speed as set?
- (3) Does the reference speed match the actual motor speed?
- (4) Does the motor stop when no reference is input?

Un-00	Actual motor speed
Un-01	Reference speed

(3) If the motor rotates at an extremely slow speed when 0 V is specified as the reference voltage, correct the reference offset value as described in *Section 4.2.4 Reference Offset Automatic Adjustment*

- (4) To change motor speed or the direction of rotation, reset the user constants shown below.

Cn-03	Speed reference gain (see page 68)
Cn-02 bit 0	Reverse rotation mode (see page 54)

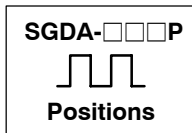

Servopack for Position Control

- (1) Set user constant Cn-02 so that the reference pulse form matches the host controller output form. (See page 174 for details on how to set user constants.)

Selecting reference pulse form (See page 70)

Cn-02	Bit 3
	Bit 4
	Bit 5
	Bit D

- (2) Input a slow speed pulses from the host controller and execute low-speed operation.

- (3) Check the following items in monitor mode (see page 179):

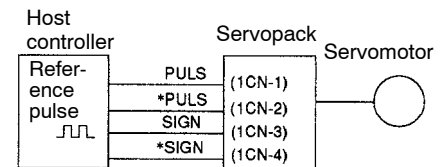

- (1) Has a reference pulse been input?
- (2) Is the motor speed as set?
- (3) Does the reference speed match the actual motor speed?
- (4) Does the motor stop when no reference is input?

Un-00	Actual motor speed
Un-07	Reference pulse speed display
Un-08	Position error

- (4) To change motor speed or the direction of rotation, reset the user constants shown below.

Cn-24,Cn-25	Electronic gear ratio (see page 81)
Cn-02 bit 0	Reverse rotation mode (see page 54)

If an alarm occurs or the motor fails to rotate during the above operation, connector 1CN wiring is incorrect or the user constant settings do not match the host controller specifications.

In this case, check the wiring and review the user constant settings, then repeat step 1.

Refer to Appendix E List of Alarm Displays and Appendix D List of User Constants.

This is all that is required to complete step 1 (conducting a test run for motor without load). Whenever possible, perform tuning associated with the host controller and other necessary adjustments in step 1 (before installing the motor on the machine).

2

2.4.3 Step 2: Conducting a Test Run with the Motor Connected to the Machine

After step 1 is complete, proceed to step 2 in which a test run is conducted with the motor connected to the machine. The purpose of step 2 is to adjust the Servopack according to the machine characteristics.

Conduct a test run according to the procedure described below.

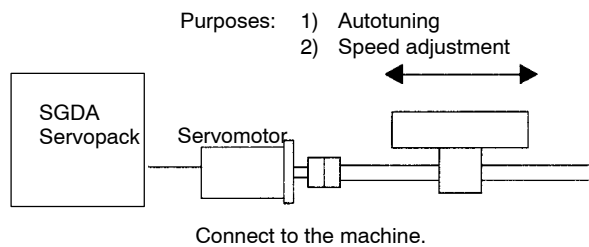

NOTE Before proceeding to step 2, repeat step 1 (conducting a test run for the motor without load) until you are fully satisfied that the test has been completed successfully. Operation faults that arise after the motor is connected to the machine not only damage the machine but may also cause an accident resulting in injury or death. Therefore, all items including user constants setting and wiring should be tested as conclusively as possible before step 1 is complete.

- (1) Check that power is OFF.
Turn the Servopack power OFF.

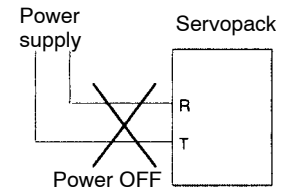

- (2) Connect the servomotor to the machine.
Refer to 2.2.2 *Installing the Servomotor*.

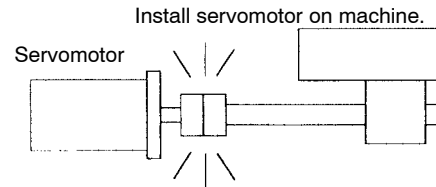

- (3) Perform autotuning.
Tune the Servopack according to the machine characteristics. Refer to 4.2.3 *Autotuning*.

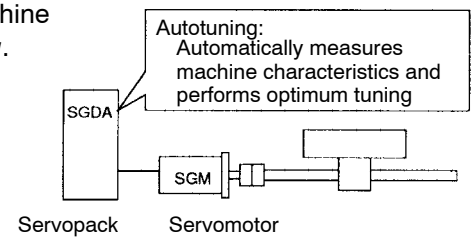

- (4) Operate by reference input.
As in step 1 (conducting a test run for motor without load), perform (9) *Operate by reference input* on page 42. Perform tuning associated with the host controller.

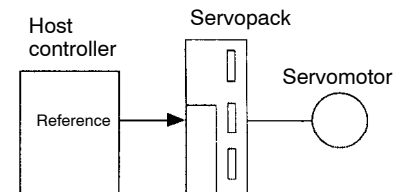

- (5) Set user constants and record the settings.
Set user constants as necessary. Record all the user constant settings for maintenance purposes.

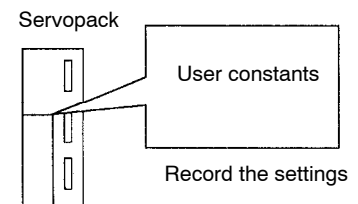

This is all that is required to conduct the test run.

Normally, the machine may cause much friction because of an insufficient running-in period. After a test run is complete, perform adequate running-in.

2.4.4 Supplementary Information on Test Run

In the following cases, always refer to the information described below before starting a test run:

- When using a servomotor with a brake
- When performing position control from the host controller

1) When using a servomotor with brake

The brake prevents the motor shaft from rotating due to a backdriving torque. Such a torque may be created by an external force or the force of gravity acting on the load and may result in undesired motion or the load, should motor power be lost.

Servopack uses the brake interlock output (BK) signal to control holding brake operation for a servomotor with brake.

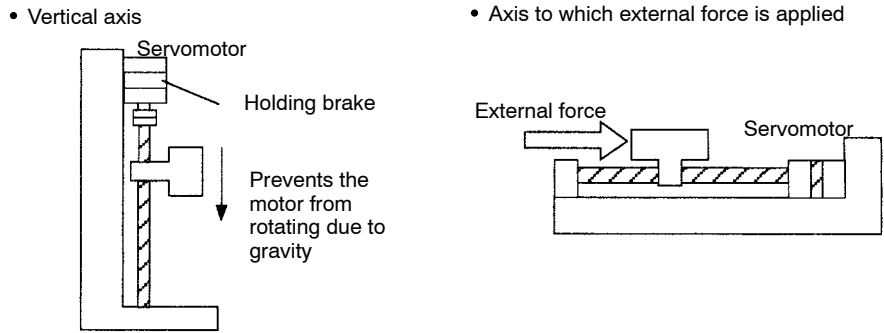

NOTE To prevent faulty operation caused by gravity (or external force), first check that the motor and holding brake operate normally with the motor disconnected from the machine. Then, connect the motor to the machine and conduct a test run.

For wiring of a servomotor with a brake, refer to 3.4.4 Using Holding Brake.

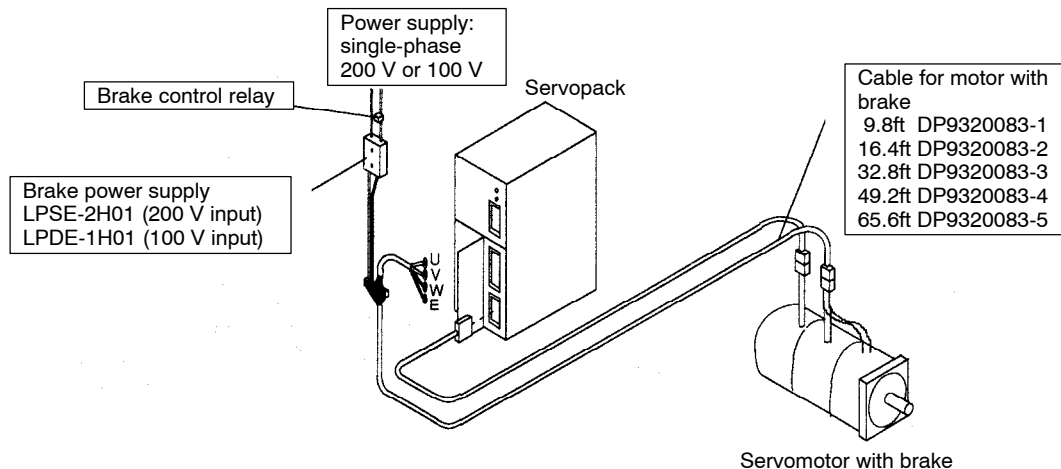

2) **When performing position control from the host controller**

Check motor operation first and then conduct a test run as described in the table below.

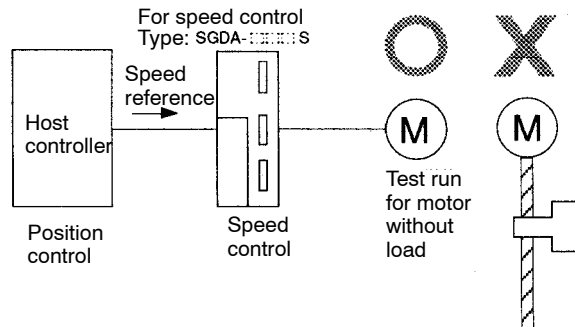

NOTE Check the motor operation with the motor disconnected from the machine. If the host controller does not perform position control correctly, the motor may run out of control.

Reference from Host Controller	Check Items	Check Method	Review Items
Jogging (constant-speed reference input from host controller)	Motor speed	<p>Check the motor speed as follows:</p> <ul style="list-style-type: none"> Use the speed monitor (Un-00) of the digital operator. Run the motor at low speed. For example, input a speed reference of 60 r/min and check that the motor makes one revolution per one second. 	Check whether the speed reference gain value (user constant Cn-03) is correct.
Simple positioning	Number of motor revolutions	<ul style="list-style-type: none"> Input a reference equivalent to one motor revolution and visually check that the motor shaft makes one revolution. 	Check whether the dividing ratio count (user constant Cn-0A) is correct.
Overtravel (when P-OT and N-OT signals are used)	Whether the motor stops rotating when P-OT and N-OT signals are input	<ul style="list-style-type: none"> Check that the motor stops when P-OT and N-OT signals are input during continuous motor operation. 	If the motor does not stop, review the P-OT and N-OT wiring.

2.4.5 Minimum User Constants Required and Input Signals

1) This section describes the minimum user constants that must be set to conduct a test run. For details on how to set each user constant, refer to *4.1.5 Operation in User Constant Setting Mode*.

a) Servopack for speed/torque control

Cn-01 bit E	Encoder selection
Cn-02 bit 8	Motor selection
Cn-03	Speed reference adjustment gain
Cn-0A	Encoder pulse dividing ratio
Cn-11	Number of encoder pulse

b) Servopack for position control

Cn-01 bit E	Encoder selection
Cn-02 bit 8	Motor selection
Cn-02 bits 3,4,5	Reference pulse form selection
Cn-02 bit D	Logic of reference pulse
Cn-02 bit F	Reference pulse output form
Cn-0A	Encoder pulse dividing ratio
Cn-11	Number of encoder pulses
Cn-24	Electronic gear ratio (numerator)
Cn-25	Electronic gear ratio (denominator)

After changing the Cn-02 setting, always turn the power OFF, then ON. This makes the new setting valid.alone

2) If the specified direction of rotation differs from the actual direction of rotation, the wiring may be incorrect. In this case, recheck the wiring and correct it accordingly. Then, if the direction of rotation is to be reversed, set the following user constant:

Cn-02 (bit 0)	Reverse rotation mode (see page 54)
---------------	-------------------------------------

After changing the Cn-02 setting, always turn the power OFF, then ON. This makes the new setting valid.

3) The following table lists the minimum input signals required to conduct a test run. For details of each input signal, refer to the relevant page.

Signal Name	Pin Number	Function
S-ON (servo ON)	1CN-14	Switching between motor ON and OFF status. The memory switch can be used to eliminate the need for external short-circuit wiring (see page 129).
P-OT (forward rotation prohibited)	1CN-16	Overtravel limit switch The memory switch can be used to eliminate the need for external short-circuit wiring (see page 57).
N-OT (reverse rotation prohibited)	1CN-17	

APPLICATIONS OF Σ -SERIES PRODUCTS

3

This chapter is prepared for readers who wish to learn more about the applications of Σ -series products after fully understanding *Chapter 2 Basic Uses of Σ -series Products*. It explains how to set user constants for each purpose and how to use each function. Read the applicable sections according to your requirements.

3.1	Setting User Constants According to Machine Characteristics	54
3.1.1	Changing the Direction of Motor Rotation	54
3.1.2	Setting the Overtravel Limit Function	56
3.1.3	Restricting Torque	59
3.2	Setting User Constants According to Host Controller	65
3.2.1	Inputting Speed Reference	65
3.2.2	Inputting Position Reference	69
3.2.3	Using Encoder Output	73
3.2.4	Using Contact I/O Signals	77
3.2.5	Using Electronic Gear	79
3.2.6	Using Contact Input Speed Control	83
3.2.7	Using Torque Control	88
3.2.8	Using Torque Feed-forward Function	94
3.2.9	Using Torque Restriction by Analog Voltage Reference	95
3.2.10	Using the Reference Pulse Inhibit Function (INHIBIT)	97
3.2.11	Using the Reference Pulse Input Filter Selection Function	99
3.3	Setting Up the Σ Servopack	100
3.3.1	Setting User Constants	100
3.3.2	Setting the Jog Speed	101
3.3.3	Setting the Number of Encoder Pulses	102
3.3.4	Setting the Motor Type	103
3.4	Setting Stop Mode	104
3.4.1	Adjusting Offset	104
3.4.2	Using Dynamic Brake	105
3.4.3	Using Zero-Clamp	106
3.4.4	Using Holding Brake	107

3.5	Running the Motor Smoothly	111
3.5.1	Using the Soft Start Function	111
3.5.2	Using the Smoothing Function	112
3.5.3	Adjusting Gain	112
3.5.4	Adjusting Offset	113
3.5.5	Setting the Torque Reference Filter Time Constant	113
3.6	Minimizing Positioning Time	114
3.6.1	Using Autotuning Function	114
3.6.2	Setting Servo Gain	114
3.6.3	Using Feed-forward Control	116
3.6.4	Using Proportional Control	116
3.6.5	Setting Speed Bias	117
3.6.6	Using Mode Switch	118
3.6.7	Using Speed Loop Compensation Function	124
3.7	Forming a Protective Sequence	125
3.7.1	Using Servo Alarm Output and Alarm Code Output	125
3.7.2	Using Servo ON Input Signal	128
3.7.3	Using Positioning Complete Signal	129
3.7.4	Using Speed Coincidence Output Signal	131
3.7.5	Using Running Output Signal	132
3.7.6	Handling of Power Loss	134
3.8	Special Wiring	136
3.8.1	Wiring Instructions	136
3.8.2	Wiring for Noise Control	138
3.8.3	Using More Than One Servo Drive	143
3.8.4	Using Regenerative Units	144
3.8.5	Using an Absolute Encoder	148
3.8.6	Extending an Encoder Cable	157
3.8.7	Using SGDA Servopack with High Voltage Line	159
3.8.8	Connector Terminal Layouts	161

Before Reading this Chapter

- 1) This chapter describes how to use each 1CN connector I/O signal for the SGDA Servopack and how to set the corresponding user constant.
- 2) For a list of I/O signals of 1CN connector, refer to *Appendix C List of I/O Signals*. For terminal arrangement for I/O signals of 1CN connector, refer to *3.8.8 Connector Terminal Layouts*.

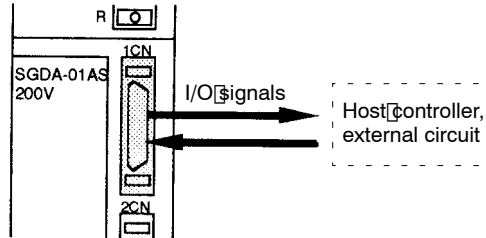

- 3) For a list of user constants, refer to *Appendix D List of User Constants*.
- 4) User constants are divided into the following two types.

1) Memory switch Cn-01 and Cn-02	Set each bit to ON or OFF to select a function.
2) Constant setting Cn-03 and later	Set a numerical value such as a torque limit value or speed loop gain.

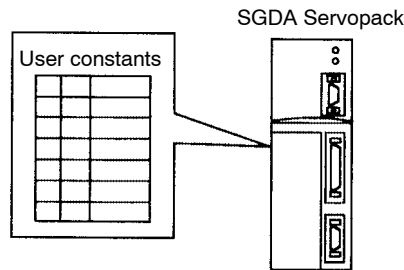

- 5) For details on how to set user constants, refer to *4.1.5 Operation in User Constant Setting Mode*.

3.1 Setting User Constants According to Machine Characteristics

This section describes how to set user constants according to the dimensions and performance of the machine to be used.

3.1.1	Changing the Direction of Motor Rotation	54
3.1.2	Setting the Overtravel Limit Function	56
3.1.3	Restricting Torque	59

3.1.1 Changing the Direction of Motor Rotation

- 1) This Servopack provides a reverse rotation mode in which the direction of rotation can be reversed without altering the servomotor wiring. With the standard setting, forward rotation is defined as counterclockwise (ccw) rotation viewed from the drive end.
- 2) If reverse rotation mode is used, the direction of motor rotation can be reversed without other items being changed. The direction (+/-) of axial motion is reversed.

	Standard Setting	Reverse Rotation Mode
Forward Run Reference	<p>Encoder output from Servopack (Phase A) PAO PBO (Phase B)</p>	<p>Encoder output from Servopack (Phase A) PAO PBO (Phase B)</p>
Reverse Run Reference	<p>Encoder output from Servopack (Phase A) PAO PBO (Phase B)</p>	<p>Encoder output from Servopack (Phase A) PAO PBO (Phase B)</p>

3

3) **Setting Reverse Rotation Mode:**

Reverse rotation mode can be set in either of the following two ways. Normally, method 1 is easier to use.

a) **Method 1: Setting Memory Switch**

Set bit 0 of memory switch Cn-02 to select reverse rotation mode.

Cn-02 Bit 0	Rotation Direction Selection	Factory Setting: 0	For Speed/Torque Control and Position Control
--------------------	------------------------------	--------------------	---

Set the direction of rotation.

Setting	Meaning
0	Forward rotation is defined as counterclockwise rotation when viewed from the drive end. (Standard setting)
1	Forward rotation is defined as clockwise rotation when viewed from the drive end. (Reverse rotation mode)

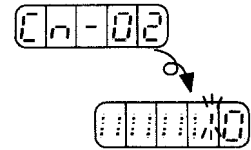

b) **Method 2: Shorting the Wiring in the 2CN Connector**

Reverse rotation mode can be set for the 2CN connector for the encoder. This method is used to standardize user constant settings without using the memory switch.

In this case, reverse rotation mode is set regardless of the memory switch setting.

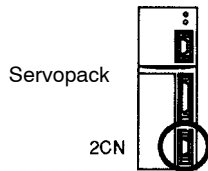
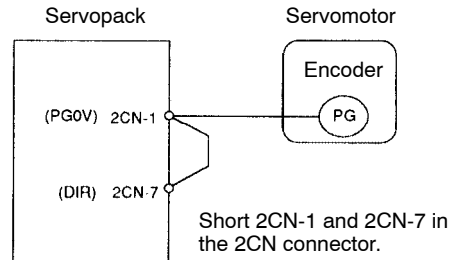

3.1.2 Setting the Overtravel Limit Function

- 1) The overtravel limit function forces the moving part of the machine to stop when it exceeds the movable range.
- 2) To use the overtravel limit function, connect the following input signal terminals correctly.

→ Input P-OT 1CN-16	Forward Rotation Prohibited (Forward Overtravel)	For Speed/Torque Control and Position Control
→ Input N-OT 1CN-17	Reverse Rotation Prohibited (Reverse Overtravel)	For Speed/Torque Control and Position Control

Inputs terminals for overtravel limit switch.

For linear motion, connect a limit switch to prevent damage to the machine.

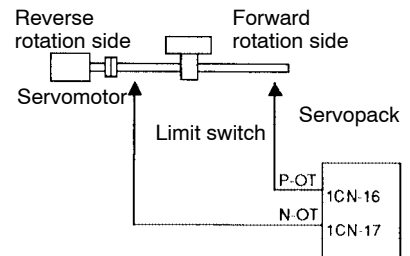

P-OT	ON: 1CN-16 is at low level.	Forward rotation allowed. Normal operation status.
	OFF: 1CN-16 is at high level.	Forward rotation prohibited (reverse rotation allowed).
N-OT	ON: 1CN-17 is at low level.	Reverse rotation allowed. Normal operation status.
	OFF: 1CN-17 is at high level.	Reverse rotation prohibited (forward rotation allowed).

3

3) Use the following user constants (memory switch) to specify whether input signals for overtravel are to be used.

Cn-01 Bit 2	Use of P-OT Input Signal	Factory Setting: 0	For Speed/Torque Control and Position Control
Cn-01 Bit 3	Use of N-OT Input Signal	Factory Setting: 0	For Speed/Torque Control and Position Control

Specifies whether the P-OT input signal for prohibiting forward rotation at overtravel (1CN-16) is to be used and whether the N-OT input signal for prohibiting reverse rotation at overtravel (1CN-17) is to be used.

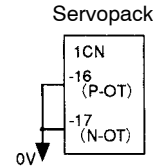

Specifies "1" when external short-circuit wiring is to be omitted.

The short-circuit wiring shown in the figure can be omitted when P-OT and N-OT are not used.

Bit	Setting	Meaning
Bit 2	0	Uses the P-OT input signal for prohibiting forward rotation. (Forward rotation is prohibited when 1CN-16 is open. Forward rotation is allowed when 1CN-16 is at 0 V.)
	1	Does not use the P-OT input signal for prohibiting forward rotation. (Forward rotation is always allowed. This has the same effect as shorting 1CN-16 to 0 V.)
Bit 3	0	Uses the N-OT input signal for prohibiting reverse rotation. (Reverse rotation is prohibited when 1CN-17 is open. Reverse rotation is allowed when 1CN-17 is at 0 V.)
	1	Does not use the N-OT input signal for prohibiting reverse rotation. (Reverse rotation is always allowed. This has the same effect as shorting 1CN-17 to 0 V.)

4) If the P-OT and N-OT input signals are used, set the following user constants to specify how to stop the motor.

Cn-01 Bit 8	How to Stop Motor at Overtravel	Factory Setting: 0	For Speed/Torque Control and Position Control
Cn-01 Bit 9	Operation to be Performed when Motor Stops after Overtravel	Factory Setting: 0	For Speed/Torque Control and Position Control

- Inputs signal for prohibiting forward rotation (P-OT, 1CN-16)
- Inputs signal for prohibiting reverse rotation (N-OT, 1CN-17)

Specify how to stop the motor when either of the above signals is input.

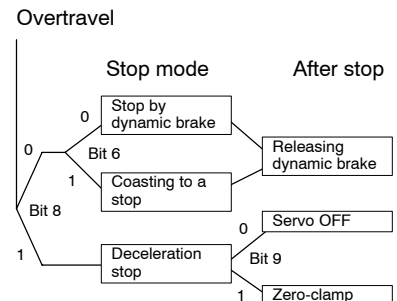

3.1.2 Setting the Overtravel Limit Function cont.

	Setting	Meaning
Cn-01 bit 8	0	Stops the motor in the same way as when the servo is turned OFF. The motor is stopped by dynamic brake or coasts to a stop. Either of these stop modes can be selected by setting bit 6 of Cn-01.
	1	Stops the motor by decelerating it with the preset torque. Preset value: Cn-06 (EMGTRQ) emergency stop torque

If deceleration stop mode is selected, specify the operation to be done after the motor stops.

	Setting	Meaning
Cn-01 bit 9	0	Turns the servo OFF when the motor stops in deceleration stop mode.
	1	Causes the motor to enter zero-clamp status after it stops in deceleration stop mode.

If torque control mode is selected for the Servopack for speed/torque control (SGDA-□□□S), the motor stops in the same way as when the servo is turned OFF, regardless of the setting of Cn-01 bit 8.

Cn-06	EMGTRQ Emergency Stop Torque	Unit: %	Setting Range: 0 to Maximum Torque	Factory Setting: Maximum Torque	For Speed/Torque Control and Position Control
-------	---------------------------------	------------	------------------------------------	---------------------------------	---

Specifies the stop torque to be applied at overtravel when the input signal for prohibiting forward or reverse rotation is to be used.

Specifies a torque value in terms of a percentage of the rated torque.

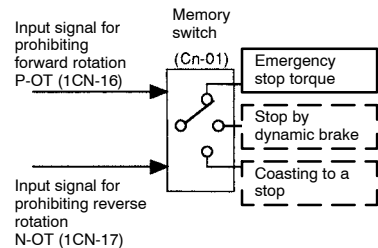

Cn-01 Bit 6	How to Stop Motor at Servo OFF	Factory Setting: 0	For Speed/Torque Control and Position Control
Cn-01 Bit 7	Operation to Be Performed when Motor Stops after Servo OFF	Factory Setting: 1	For Speed/Torque Control and Position Control

The Servopack enters servo OFF status when:

- Servo ON input signal (S-ON, 1CN-14) is turned OFF.
- Servo alarm arises.
- Power is turned OFF.

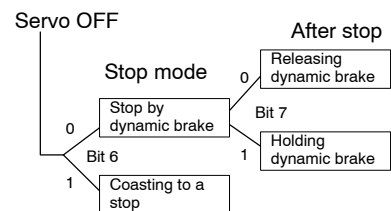

Dynamic brake is a function that electrically applies brakes by using a resistor to consume motor rotation energy.

Specify how to stop the motor when one of the above events occurs during operation.

	Setting	Meaning
Cn-01 bit 6	0	Stops the motor by dynamic brake.
	1	Causes the motor to coast to a stop. The motor power is OFF and stops due to machine friction.

If dynamic brake stop mode is selected, specify the operation to be performed when the motor stops.

	Setting	Meaning
Cn-01 bit 7	0	Releases dynamic brake after the motor stops.
	1	Does not release dynamic brake even after the motor stops.

3.1.3 Restricting Torque

1) The Servopack can provide the following torque control:

- Torque restriction
 - Level 1: To restrict the maximum output torque to protect the machine or workpiece
 - Level 2: To restrict torque after the motor moves the machine to a specified position
- Torque control
 - Level 3: To always control output torque, not speed
 - Level 4: To alternately use speed control and torque control

This section describes how to use levels 1 and 2 of the torque restriction function.

2) How to Set Level 1: Internal Torque Limit

The maximum torque is restricted to the values set in the following user constants.

Cn-08	TLMTF Forward Rotation Torque Limit	Unit: %	Setting Range: 0 to Maximum Torque	Factory Setting: Maximum Torque	For Speed/Torque Control and Position Control
Cn-09	TLMTR Reverse Rotation Torque Limit	Unit: %	Setting Range: 0 to Maximum Torque	Factory Setting: Maximum Torque	For Speed/Torque Control and Position Control

3.1.3 Restricting Torque cont.

Sets the maximum torque values for forward rotation and reverse rotation, respectively.

Sets these user constants when torque must be restricted according to machine conditions.

This torque restriction function always monitors torque, and outputs the signal shown on the right when the limit value is reached.

Specifies a torque limit value in terms of a percentage of the rated torque.

Output Signal for Torque Restriction Function

- $\overline{\text{TGON}}$ (1CN-9)
 - Status indication mode bit data
 - Monitor mode (Un-05) bit 4
- User Constant Setting:
Memory switch (Cn-01) bit 4 = 1

Example of Use: Machine Protection

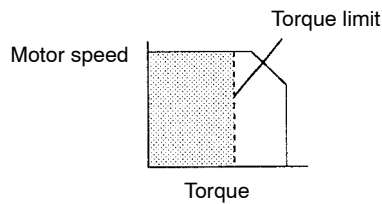

Note that too small a torque limit value will result in torque shortage at acceleration or deceleration.

• Using $\overline{\text{TGON}}$ Signal

This section describes how to use contact output signal $\overline{\text{TGON}}$ as a torque limit output signal.

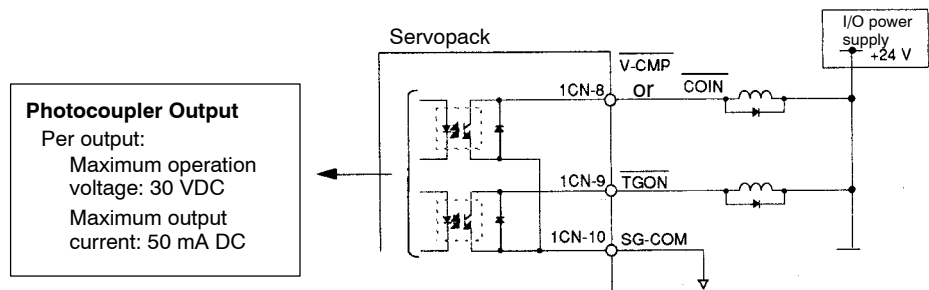

Photocoupler Output
Per output:
Maximum operation voltage: 30 VDC
Maximum output current: 50 mA DC

Output → $\overline{\text{TGON}}$ 1CN-9	Torque Limit Output (Running Output)	For Speed/Torque Control and Position Control
---	--------------------------------------	---

This signal indicates whether motor output torque (current) is being restricted.

ON status: The circuit between 1CN-9 and 1CN-10 is closed. 1CN-9 is at low level.	Motor output torque is being restricted. (Internal torque reference is greater than the preset value.)
OFF status: The circuit between 1CN-9 and 1CN-10 is open. 1CN-9 is at high level.	Motor output torque is not being restricted. (Internal torque reference is equal to or below the preset value.)

Preset Value: Cn-08 (TLMTF)
 Cn-09 (TLMTR)
 Cn-18 (CLMIF) : P-CL input only
 Cn-19 (CLMIR) : N-CL input only

Note This function is changed to another function depending on the setting of bit 4 of memory switch Cn-01.

To use output signal $\overline{\text{TGON}}$ as a torque limit output signal, set the following memory switch to 1.

This memory switch can also be used to set level 2 torque restriction (described in the next subsection).

Cn-01 Bit 4	$\overline{\text{TGON}}$ Output Signal Selection	Factory Setting: 0	For Speed/Torque Control and Position Control
--------------------	--	--------------------	---

Sets the output conditions for output signal $\overline{\text{TGON}}$ (1CN-9).

Setting	Meaning				
0	<p>Uses $\overline{\text{TGON}}$ output signal as a running output signal.</p> <p>Compares the motor speed with the Cn-0B (TGONLV) setting.</p> <table border="1"> <tr> <td>Motor speed \geq preset value</td> <td>Closes the circuit between 1CN-9 and 1CN-10</td> </tr> <tr> <td>Motor speed $<$ preset value</td> <td>Opens the circuit between 1CN-9 and 1CN-10</td> </tr> </table>	Motor speed \geq preset value	Closes the circuit between 1CN-9 and 1CN-10	Motor speed $<$ preset value	Opens the circuit between 1CN-9 and 1CN-10
Motor speed \geq preset value	Closes the circuit between 1CN-9 and 1CN-10				
Motor speed $<$ preset value	Opens the circuit between 1CN-9 and 1CN-10				
1	<p>Uses $\overline{\text{TGON}}$ output signal as a torque limit output signal.</p> <p>Compares the SGDA Servopack internal torque (current) reference with the preset value.</p> <p>Preset Value: Cn-08 (TLMTF) Cn-09 (TLMTR) Cn-18 (CLMIF): P-CL input only Cn-19 (CLMIR): N-CL input only</p> <table border="1"> <tr> <td>Internal torque (current) reference \geq preset value</td> <td>Opens the circuit between 1CN-9 and 1CN-10</td> </tr> <tr> <td>Internal torque (current) reference $<$ preset value</td> <td>Closes the circuit between 1CN-9 and 1CN-10</td> </tr> </table>	Internal torque (current) reference \geq preset value	Opens the circuit between 1CN-9 and 1CN-10	Internal torque (current) reference $<$ preset value	Closes the circuit between 1CN-9 and 1CN-10
Internal torque (current) reference \geq preset value	Opens the circuit between 1CN-9 and 1CN-10				
Internal torque (current) reference $<$ preset value	Closes the circuit between 1CN-9 and 1CN-10				

Bit 4 of memory switch Cn-01

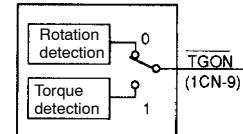

When $\overline{\text{TGON}}$ output signal is changed, the following bit data are also changed:

- Status indication mode bit data
- Monitor mode Un-05 bit 4

3) How to Set Level 2: External Torque Limit

First, use a contact input signal to make the torque (current) limit value set in the user constant valid. Torque limit can be set separately for forward and reverse rotation.

To use this function, always set bit 2 of memory switch Cn-02 to 0 (standard setting). The contact input speed control function cannot be used.

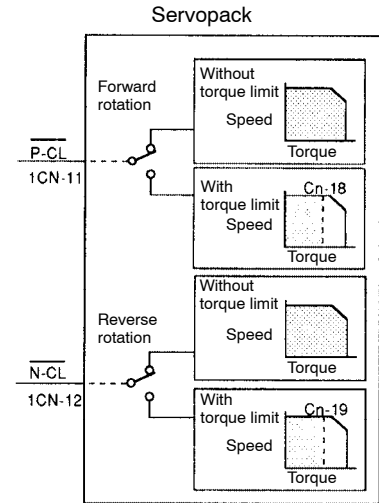

P-CL	ON: 1CN-11 is at low level.	Torque restriction applies during forward rotation.	Limit value: Cn-18
	OFF: 1CN-11 is at high level.	Torque restriction does not apply during forward rotation.	
N-CL	ON: 1CN-12 is at low level.	Torque restriction applies during reverse rotation.	Limit value: Cn-19
	OFF: 1CN-12 is at high level.	Torque restriction does not apply during reverse rotation.	

This torque restriction function outputs the signal shown on the right.

Output Signal for Torque Restriction Function

<ul style="list-style-type: none"> • TGON (1CN-9) • Status indication mode bit data • Monitor mode Un-05 bit 4
<p>User Constant Setting: Memory switch Cn-01 bit 4 = 1</p>

Examples of Use:

- Forced stopping
- Holding workpiece by robot

Sets a torque limit value when torque is restricted by external contact input.

This function is valid when bit 2 of memory switch Cn-02 is set to 0.

Cn-18	CLMIF Forward External Torque Limit	Unit: %	Setting Range: 0 to Maximum Torque	Factory Setting: 100	For Speed/Torque Control and Position Control
Cn-19	CLMIR Reverse External Torque Limit	Unit: %	Setting Range: 0 to Maximum Torque	Factory Setting: 100	For Speed/Torque Control and Position Control

When $\overline{P-CL}$ (1CN-11) is input	Applies torque restriction as specified in Cn-18
When $\overline{N-CL}$ (1CN-12) is input	Applies torque restriction as specified in Cn-19

For torque restriction by analog voltage reference, refer to 3.2.9 Using Torque Restriction by Analog Voltage Reference.

- Using $\overline{P-CL}$ and $\overline{N-CL}$ Signals

This section describes how to use input signals $\overline{P-CL}$ and $\overline{N-CL}$ as torque limit input signals.

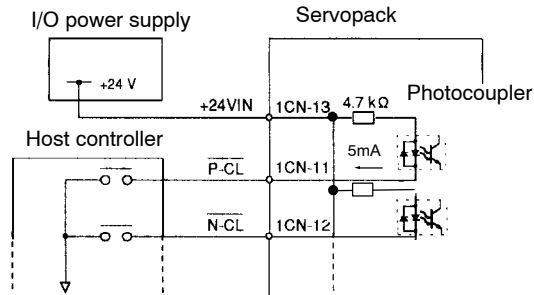

→ Input $\overline{P-CL}$ 1CN-11	Forward External Torque Limit Input (Speed Selection 1)	For Speed/Torque Control and Position Control
→ Input $\overline{N-CL}$ 1CN-12	Reverse External Torque Limit Input (Speed Selection 2)	For Speed/Torque Control and Position Control

These signals are for forward and reverse external torque (current) limit input.

This function is useful in forced stopping.

Output Signal for Torque Restriction Function

- TGON (1CN-9)
 - Status indication mode bit data
 - Monitor mode Un-05 bit 4
- User Constant Setting:
Memory switch Cn-01 bit 4 = 1

3.1.3 Restricting Torque cont.

P-CL	ON: 1CN-11 is at low level.	Torque restriction applies during forward rotation.	Limit value: Cn-18
	OFF: 1CN-11 is at high level.	Torque restriction does not apply during forward rotation. Normal operation status.	
N-CL	ON: 1CN-12 is at low level.	Torque restriction applies during reverse rotation.	Limit value: Cn-19
	OFF: 1CN-12 is at high level.	Torque restriction does not apply during reverse rotation. Normal operation status.	

The signal shown on the right is output while torque is being restricted.

Note This function is changed to another function depending on the setting of bit 2 of memory switch Cn-02 (see below).

To use input signals $\overline{P-CL}$ and $\overline{N-CL}$ as torque limit input signals, set the following memory switch to 0.

Cn-02 Bit 2	Contact Input Speed Control Selection	Factory Setting: 0	For Speed/Torque Control and Position Control
--------------------	---------------------------------------	--------------------	---

Prohibits the contact input speed control function.

If the contact input speed control function is used, the contents of the input signals shown below will change.

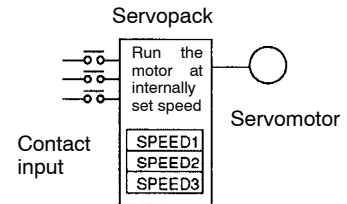

After this memory switch is reset, the meanings of the following signals will also change:

Monitor mode (Un-05) bit 7 and bit 8

Setting	Meaning	Input Signal			
0	Does not use the contact input speed control function.	$\overline{P-CON}$ (1CN-15)	Used to switch between P control and PI control. (For speed/torque control, bits A and B of Cn-01 take precedence over this signal.)		
		$\overline{P-CL}$ (1CN-11)	Used for forward external torque limit input		
		$\overline{N-CL}$ (1CN-12)	Used for reverse external torque limit input		
1	Uses the contact input speed control function.	0: OFF, 1: ON			
		P-CON	P-CL	N-CL	Speed Setting
		Direction of rotation 0: Forward 1: Reverse	0	0	Normal speed/torque or position control
			0	1	Cn-1F (SPEED1)
			1	1	Cn-20 (SPEED2)
	1	0	Cn-21 (SPEED3)		

- Handling of the \overline{TGON} signal is the same as for level 1 (internal torque limit). Refer to *Using \overline{TGON} Signal* on page 60.

3.2 Setting User Constants According to Host Controller

This section describes how to connect a Σ -series Servo to a host controller and how to set user constants.

3.2.1	Inputting Speed Reference	65
3.2.2	Inputting Position Reference	69
3.2.3	Using Encoder Output	73
3.2.4	Using Contact I/O Signals	77
3.2.5	Using Electronic Gear	79
3.2.6	Using Contact Input Speed Control	83
3.2.7	Using Torque Control	88
3.2.8	Using Torque Feed-forward Function	94
3.2.9	Using Torque Restriction by Analog Voltage Reference	95
3.2.10	Using the Reference Pulse Inhibit Function (INHIBIT)	97
3.2.11	Using the Reference Pulse Input Filter Selection Function	99

3.2.1 Inputting Speed Reference

- 1) Input a speed reference by using the following input signal “speed reference input.” Since this signal can be used in different ways, set the optimum reference input for the system to be created.

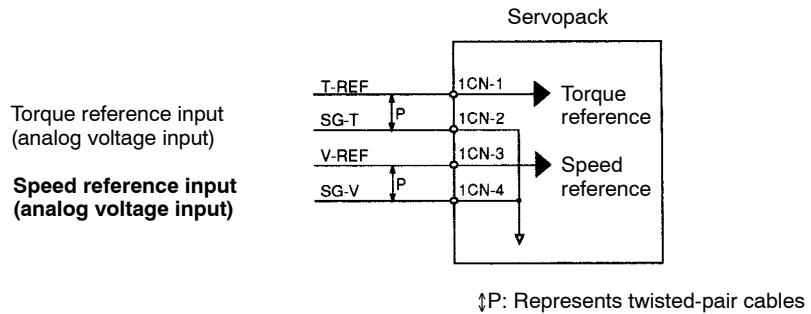

→ Input V-REF	1CN-3	Speed Reference Input	For Speed/Torque Control Only
→ Input SG-V	1CN-4	Signal Ground for Speed Reference Input	For Speed/Torque Control Only

Use these signals when speed control is selected (bits A and B of memory switch Cn-01).

For ordinary speed control, always wire the V-REF and SG-V terminals.

Motor speed is controlled in proportion to the input voltage between V-REF and SG-V.

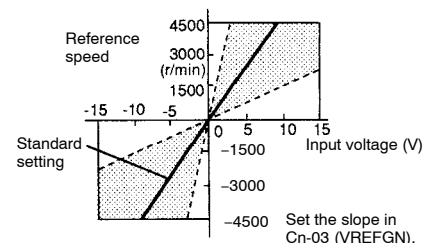

3.2.1 Inputting Speed Reference cont.

- Standard Setting:

Cn-03 = 500: This setting means that 6 V is equivalent to rated speed (3,000 r/min)

Examples:

- +6 V input → 3,000 r/min in forward direction
- +1 V input → 500 r/min in forward direction
- 3 V input → 1,500 r/min in reverse direction

User constant Cn-03 can be used to change the voltage input range.

- Example of Input Circuit
(See the figure on the right)

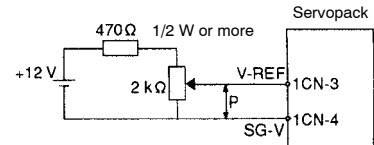

For noise control, always use twisted-pair cables.

Recommended Variable Resistor for Speed Setting:

Type 25HP-10B manufactured by Sakae Tsushin Kogyo Co., Ltd.

When position control is performed by a host controller such as a programmable controller.

Connect V-REF and SG-V to speed reference output terminals on the host controller. In this case, adjust Cn-03 according to output voltage specifications.

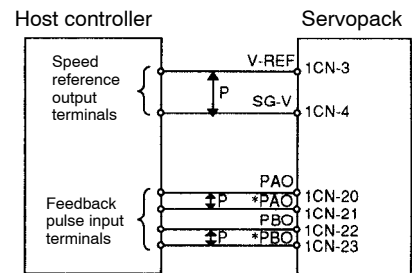

⇓P: Represents twisted-pair cables

- 2) Use the memory switch and input signal P-CON to specify one of the four modes shown below.

Cn-01 Bit A	Control Mode Selection	Factory Setting: 0	For Speed/Torque Control Only
Cn-01 Bit B	Control Mode Selection	Factory Setting: 0	For Speed/Torque Control Only

The Servopack for speed/torque control (SGDA-□□□S) provides four different control modes.

Cn-01 Setting		Control Mode					
Bit B	Bit A						
0	0	<p>Speed Control</p> <p>This is normal speed control.</p> <ul style="list-style-type: none"> Speed reference is input from V-REF (1CN-3). P-CON (1CN-15) signal is used to switch between P control and PI control. <table border="1"> <tr> <td>1CN-15 is open</td> <td>PI control</td> </tr> <tr> <td>1CN-15 is at 0 V</td> <td>P control</td> </tr> </table> <ul style="list-style-type: none"> Torque reference input T-REF (1CN-1) cannot be used. 	1CN-15 is open	PI control	1CN-15 is at 0 V	P control	<p>SGDA Servopack</p>
1CN-15 is open	PI control						
1CN-15 is at 0 V	P control						
0	1	<p>Zero-clamp Speed Control</p> <p>This speed control allows the zero-clamp function to be set when the motor stops.</p> <ul style="list-style-type: none"> Speed reference is input from V-REF (1CN-3). P-CON (1CN-15) signal is used to turn the zero-clamp function ON or OFF. <table border="1"> <tr> <td>1CN-15 is open</td> <td>Turns zero-clamp function OFF</td> </tr> <tr> <td>1CN-15 is at 0 V</td> <td>Turns zero-clamp function ON</td> </tr> </table> <ul style="list-style-type: none"> Torque reference input T-REF (1CN-1) cannot be used. 	1CN-15 is open	Turns zero-clamp function OFF	1CN-15 is at 0 V	Turns zero-clamp function ON	<p>SGDA Servopack</p> <p>Zero-clamp is performed when the following two conditions are met: Condition 1: P-CON is turned ON. Condition 2: Motor speed drops below the preset value. Preset value: Cn-0F (ZCLVL)</p>
1CN-15 is open	Turns zero-clamp function OFF						
1CN-15 is at 0 V	Turns zero-clamp function ON						
1	0	Torque control I					
1	1	Torque control II					

For torque control, refer to 3.2.7 Using Torque Control.

- Using P-CON Signal:

→ Input P-CON 1CN-15	Proportional Control, etc.	For Speed/Torque Control and Position Control
----------------------	----------------------------	---

The function of input signal P-CON changes with the memory switch setting.

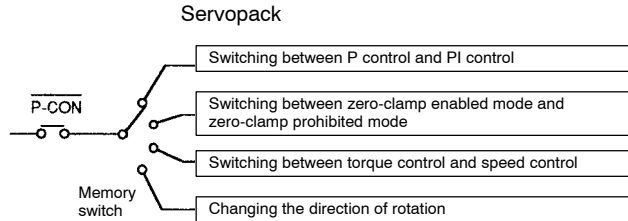

Memory Switch			Meaning of P-CON Signal
Cn-02 Bit 2	Cn-01 Bit B	Cn-01 Bit A	
0	0	0	Switching between proportional (P) control and proportional/integral (PI) control
0	0	1	Switching between zero-clamp enabled/prohibited mode (for speed/torque control (SGDA-□□□S) only)
0	1	0	Not used (for speed/torque control (SGDA-□□□S) only)
0	1	1	Switching between torque control and speed control (for speed/torque control (SGDA-□□□S) only)
1	-	-	Changing the direction of rotation during contact input speed control

- 3) Adjust the speed reference gain using the following user constant.

Cn-03	VREFGN Speed Reference Gain	Unit: (r/min)/V	Setting Range: 0 to 2162	Factory Setting: 500	For Speed/Torque Control Only
--------------	-----------------------------	-----------------	--------------------------	----------------------	-------------------------------

This user constant is for speed/torque control (SGDA-□□□S) only. Sets the voltage range for speed reference input V-REF (1CN-3). Sets this user constant according to the output form of the host controller or external circuit.

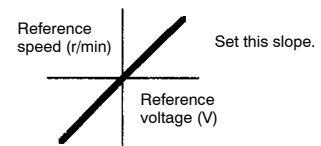

The factory setting is as follows:
 Rated speed (3,000 r/min)/6 V = 500



Zero-clamp function

This function is used for a system in which the host controller does not form a position loop. In this case, the stopping position may shift even if a speed reference is set to 0. If the zero-clamp function is turned ON, a position loop is internally formed so that the stopping position is firmly “clamped.”

3.2.2 Inputting Position Reference

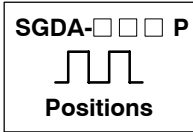

1) Input a position reference by using the following input signal “reference pulse input.” Since there are several specifications for input signal, select reference input for the system to be created.

Inputs a move reference by pulse input.

Position reference can correspond to the following three types of output form:

- Line driver output
- +12V Open collector output
- +5V Open collector output

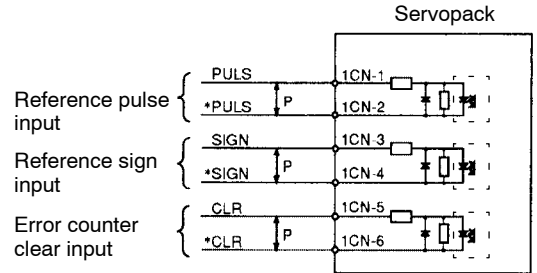

⇓P: Represents twisted-pair cables

Connection Example 1: Line Driver Output

Line Driver Used:

SN75174 manufactured by Texas Instruments Inc., or MC3487 or equivalent.

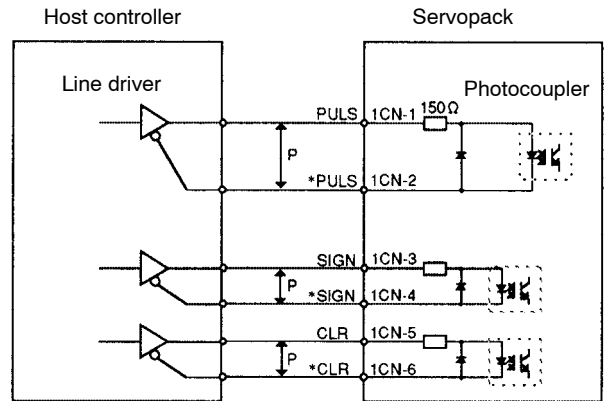

Connection Example 2: Open Collector Output

Sets the value of limiting resistor R1 so that input current i falls within the following range:

Input Current i : 7 to 15 mA

Examples:

- When V_{cc} is 12 V, $R1 = 1\text{ k}\Omega$
- When V_{cc} is 5 V, $R1 = 180\ \Omega$

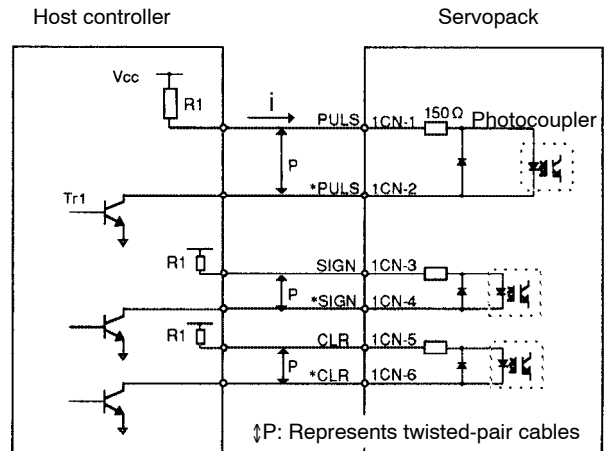

⇓P: Represents twisted-pair cables

Note The signal logic for open collector output is as follows.

When Tr1 is ON	Equivalent to high level input
When Tr1 is OFF	Equivalent to low level input

2) Use the following memory switch to select the reference pulse form to be used:

→ Input PULS	1CN-1	Reference Pulse Input	For Position Control Only
→ Input *PULS	1CN-2	Reference Pulse Input	For Position Control Only
→ Input SIGN	1CN-3	Reference Sign Input	For Position Control Only
→ Input *SIGN	1CN-4	Reference Sign Input	For Position Control Only

The motor only rotates at an angle proportional to the input pulse.

Cn-02 Bit 3	Reference Pulse Form Selection	Factory Setting: 0	For Position Control Only
Cn-02 Bit 4	Reference Pulse Form Selection	Factory Setting: 0	For Position Control Only
Cn-02 Bit 5	Reference Pulse Form Selection	Factory Setting: 0	For Position Control Only

Sets the form of a reference pulse that is external output to the Servopack.

Sets the pulse form according to the host controller specifications.

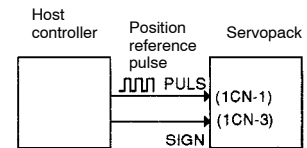

Set also the input pulse logic in bit D of Cn-02.

Bit D	Cn-02			Input Pulse Multiplier	Reference Pulse Form	Motor Forward Run Reference	Motor Reverse Run Reference
	Bit 5	Bit 4	Bit 3				
0 (Positive logic setting)	0	0	0	/	Sign + pulse train		
	0	1	0	×1	Two-phase pulse train with 90° phase difference		
	0	1	1	×2			
	1	0	0	×4			
	0	0	1	/	CW pulse + CCW pulse		

Cn-02				Input Pulse Multiplier	Reference Pulse Form	Motor Forward Run Reference	Motor Reverse Run Reference
Bit D	Bit 5	Bit 4	Bit 3				
1 (Negative logic setting)	0	0	0	/	Sign + pulse train		
	0	1	0	×1	Two-phase pulse train with 90° phase difference		
	0	1	1	×2			
	1	0	0	×4			
	0	0	1	/	CW pulse + CCW pulse		

Input Pulse Multiply Function:

When the reference form is two-phase pulse train with 90° phase difference, the input pulse multiply function can be used.

The electronic gear function can also be used to convert input pulses.

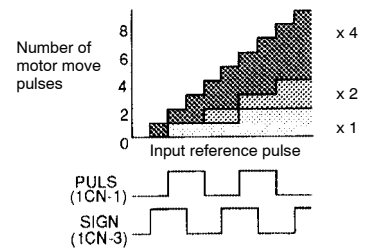

Example of I/O Signal Generation Timing

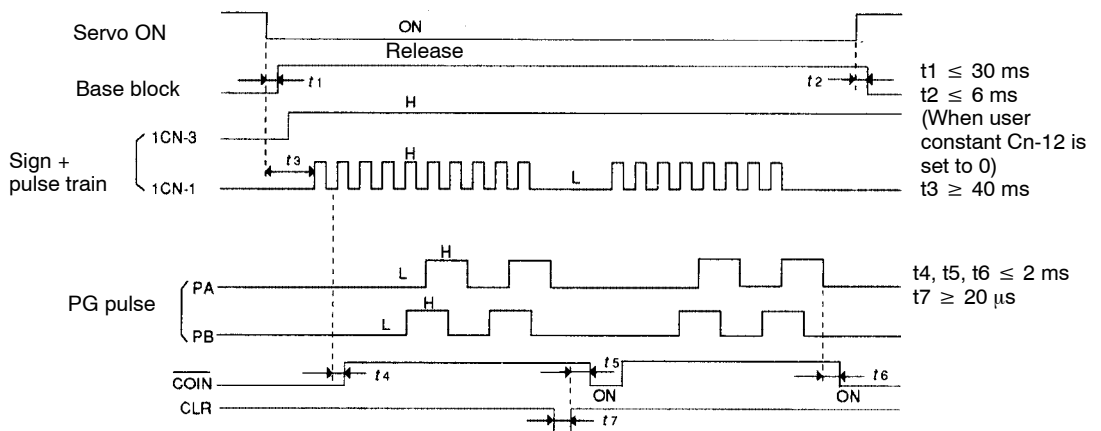

Note The interval from the time the servo ON signal is turned ON until a reference pulse is input must be at least 40 ms. Otherwise, the reference pulse may not be input. The error counter clear (CLR) signal must be ON for at least 20 μs . Otherwise, it becomes invalid.

Allowable Voltage Level and Timing for Reference Pulse Input

Reference Pulse Form	Electrical Specifications	Remarks
Sign + pulse train input (SIGN + PULS signal) Maximum reference frequency: 450 kpps	<p> $t_1, t_2 \leq 0.1 \mu s$ $r \geq 1.1 \mu s$ $t_3, t_7 \leq 0.1 \mu s$ $t_4, t_5, t_6 > 3 \mu s$ </p>	The signs for each reference pulse are as follows: ⊕: High level ⊖: Low level
90° different two-phase pulse train (phase A + phase B) Maximum reference frequency x 1 multiplier: 450 kpps x 2 multiplier: 400 kpps x 4 multiplier: 200 kpps	<p> $t_1, t_2 \leq 0.1 \mu s$ $r \geq 1.1 \mu s$ $\frac{r}{T} \times 100 \leq 50\%$ </p>	User constant Cn-02 (bits 3, 4 and 5) is used to switch the input pulse multiplier mode.
CCW pulse + CW pulse Maximum reference frequency: 450 kpps	<p> $t_1, t_2 \leq 0.1 \mu s$ $r \geq 1.1 \mu s$ $t_3 > 3 \mu s$ $\frac{r}{T} \times 100 \leq 50\%$ </p>	

3) The following describes how to clear the error counter.

→ Input CLR 1CN-5	Error Counter Clear Input	For Position Control Only
→ Input *CLR 1CN-6	Error Counter Clear Input	For Position Control Only

Setting the CLR signal to high level does the following:

- Sets the error counter inside the Servopack to 0.
- Prohibits position loop control.

Use this signal to clear the error counter from the host controller.

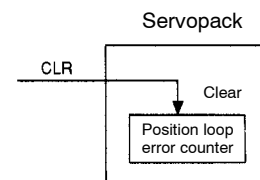

Bit A of memory switch Cn-02 can be set so that the error counter is cleared only once when the leading edge of an input pulse rises.

Cn-02 Bit A	Error Counter Clear Signal Selection	Factory Setting: 0	For Position Control Only
-------------	--------------------------------------	--------------------	---------------------------

For position control (SGDA-□□□P) only.

Selects the pulse form of error counter clear signal CLR (1CN-5).

Setting	Meaning	
0	Clears the error counter when the CLR signal is set at high level. Error pulses do not accumulate while the signal remains at high level.	
1	Clears the error counter only once when the rising edge of the CLR signal rises.	

3.2.3 Using Encoder Output

- 1) Encoder output signals **divided** inside the Servopack can be output externally. These signals can be used to form a position control loop in the host controller.

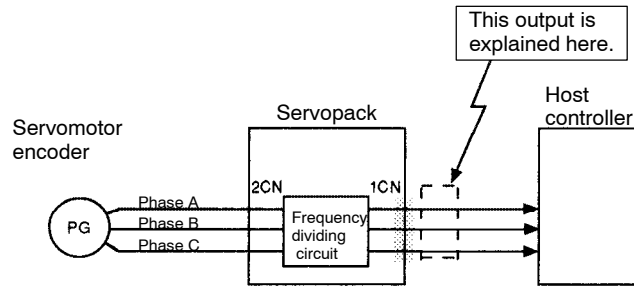

Divided (or dividing)

“Dividing” means converting an input pulse train from the encoder mounted on the motor according to the preset pulse density and outputting the converted pulse. The unit is pulses per revolution.

The output circuit is for line driver output. Connect each signal line according to the following circuit diagram.

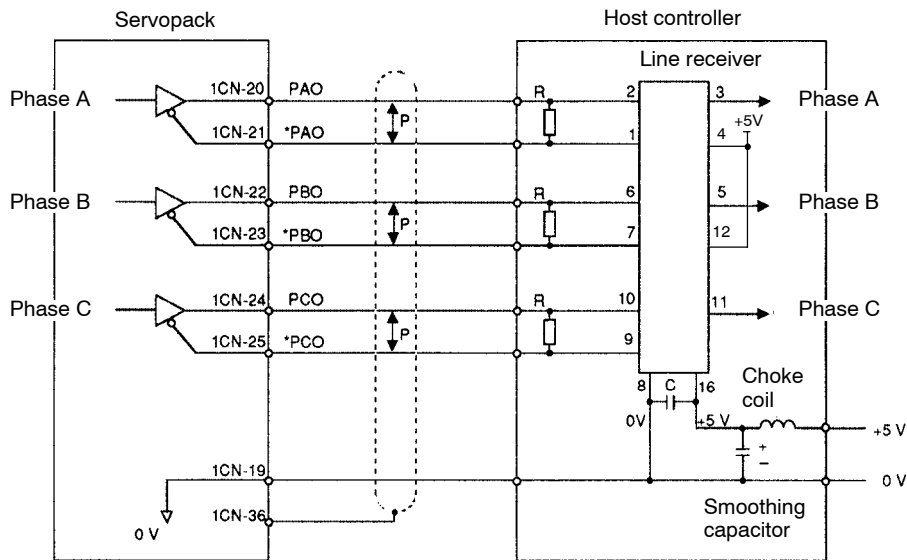

‡P: Represents twisted-pair cables

Line receiver used: SN75175 manufactured by Texas Instruments Inc. or MC3486 (or equivalent)

R (termination resistor): 220 to 470 Ω

C (decoupling capacitor): 0.1 μF

2) I/O signals are described below.

Output → PAO 1CN-20	Encoder Output Phase-A	For Speed/Torque Control and Position Control
Output → * PAO 1CN-21	Encoder Output Phase-A	For Speed/Torque Control and Position Control
Output → PBO 1CN-22	Encoder Output Phase-B	For Speed/Torque Control and Position Control
Output → * PBO 1CN-23	Encoder Output Phase-B	For Speed/Torque Control and Position Control
Output → PCO 1CN-24	Encoder Output Phase-C	For Speed/Torque Control and Position Control
Output → * PCO 1CN-25	Encoder Output Phase-C	For Speed/Torque Control and Position Control

Divided encoder signals are output.

Always connect these signal terminals when a position loop is formed in the host controller to perform position control.

Set a dividing ratio in the following user constant.

Dividing ratio setting	Cn-0A PGRAT
-------------------------------	-------------

The dividing ratio setting is not relevant to the gear ratio setting (Cn-24, 25) for the electronic gear function of the Servopack for position control (SGDA-□□□P).

Output Phase Form

Incremental Encoder

Forward rotation

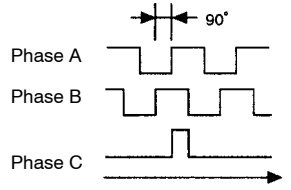

Reverse rotation

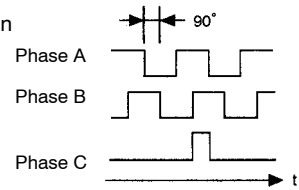

Absolute Encoder

Forward rotation

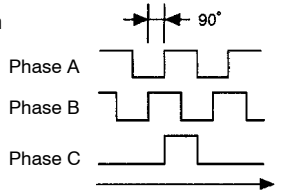

Reverse rotation

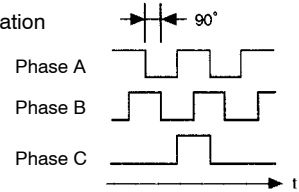

→ Input SEN 1CN-5	SEN Signal Input	For Speed/Torque Control Only
→ Input 0SEN 1CN-6	SEN Signal Input	For Speed/Torque Control Only
Output → PSO 1CN-26	Encoder Output Phase-S	For Speed/Torque Control and Position Control
Output → *PSO 1CN-27	Encoder Output Phase-S	For Speed/Torque Control and Position Control
→ Input BAT 1CN-28	Battery (+)	For Speed/Torque Control and Position Control
→ Input BAT0 1CN-29	Battery (-)	For Speed/Torque Control and Position Control

Use these signals (SEN to BAT0) for absolute encoders. For details, refer to 3.8.5 Using an Absolute Encoder.

Output → SG 1CN-19	Signal Ground for Encoder Output	For Speed/Torque Control and Position Control
Output → FG 1CN-36	Frame Ground	For Speed/Torque Control and Position Control

SG: Connect to 0 V on the host controller.

FG: Connect to the cable shielded wire.

3) Use the following memory switch to specify the type of the encoder to be used.

Cn-01 Bit E	Encoder Type Selection	Factory Setting: 0	For Speed/Torque Control and Position Control
-------------	------------------------	--------------------	---

Sets the encoder type according to the servomotor type as shown in the table.

After changing the memory switch setting, always turn the power OFF, then ON.

Motor Type	Number of Encoder Pulses Per Revolution (P/R)	Setting
SGM-□□□31□	Incremental encoder: 2,048 pulses per revolution	0
SGM-□□□W1□	Absolute encoder: 1,024 pulses per revolution	1

- 4) Set the pulse dividing ratio in the following user constant.

Cn-0A	PGRAT Dividing Ratio Setting	Unit: P/R	Setting Range: 16 to No. of Encoder Pulses	Factory Setting: 2048	For Speed/Torque Control and Position Control
--------------	---------------------------------	--------------	--	-----------------------------	---

Sets the number of output pulses for PG output signals (PAO, *PAO, PBO and *PBO).

Pulses from motor encoder (PG) are divided by the preset number of pulses before being output.

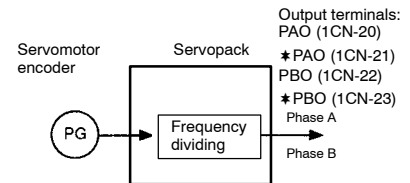

The number of output pulses per revolution is set in this user constant. Set this value according to the reference unit of the machine or controller to be used.

The setting range varies according to the encoder used.

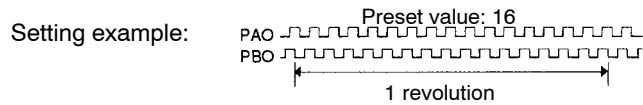

Motor Type	Number of Encoder Pulses Per Revolution	Setting Range
SGM-□□□31□	Incremental encoder: 2048 pulses per revolution	16 to 2048
SGM-□□□W1□	Absolute encoder: 1024 pulses per revolution	16 to 1024

3

3.2.4 Using Contact I/O Signals

1) Contact Input Signal Terminal Connections

These signals are used to control SGDA Servopack operation. Connect these signal terminals as necessary.

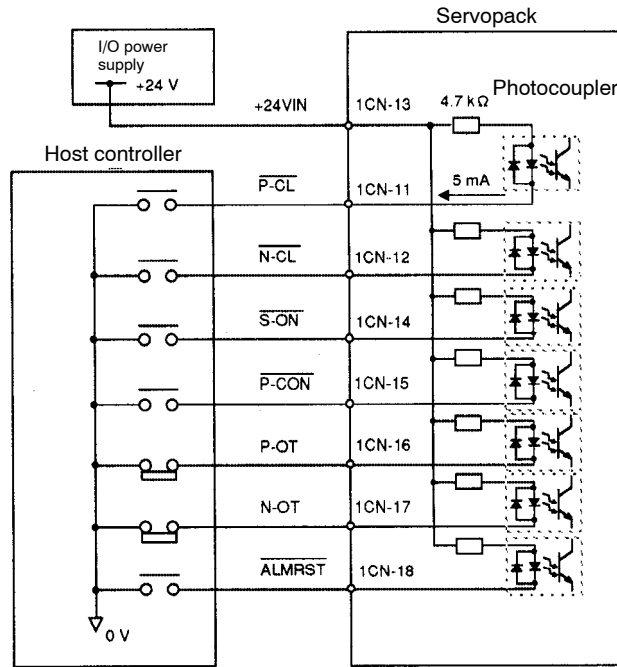

Note Provide an external I/O power supply separately. There are no power terminals to which the SGDA Servopack outputs signals externally.

External Power Supply: 24 ± 1 VDC
50 mA or more

Yaskawa recommends that this external power supply be the same type as for the output circuit.

→ Input +24VIN 1CN-13	I/O Power Supply	For Speed/Torque Control and Position Control
-----------------------	------------------	---

This external power supply input terminal is common to the following contact input signals:

- Contact Input Signals:**
- $\overline{P-CL}$ (1CN-11)
 - $\overline{N-CL}$ (1CN-12)
 - $\overline{S-ON}$ (1CN-14)
 - $\overline{P-CON}$ (1CN-15)
 - $\overline{P-OT}$ (1CN-16)
 - $\overline{N-OT}$ (1CN-17)
 - \overline{ALMRST} (1CN-18)

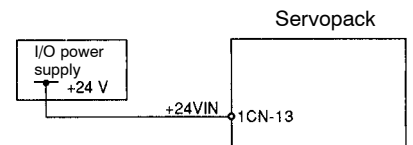

Connect an external I/O power supply.

2) Contact Output Signal Terminal Connections

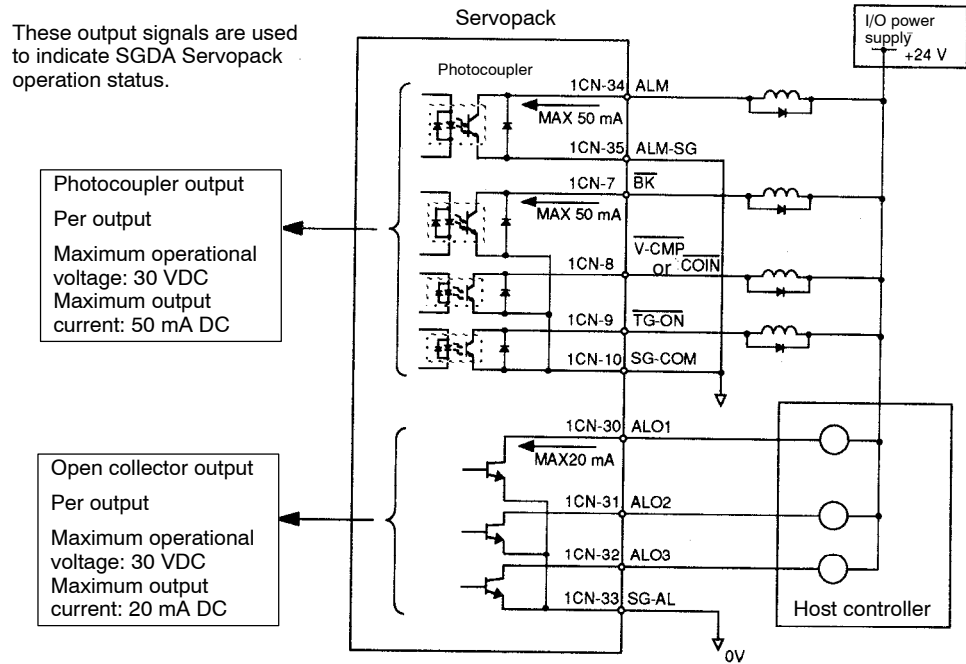

Note Provide an external I/O power supply separately. There are no power terminals to which the SGDA Servopack outputs signals externally. Yaskawa recommends that this external power supply be the same type as for the input circuit.

Output → SG-COM 1CN-10	Output Signal Ground Common	For Speed/Torque Control and Position Control
-------------------------------	-----------------------------	---

This signal ground is used for the following output signals. Connect to 0 V on the external power supply.

- Contact Output Signals:** **BK** (1CN-7)
V-CMP (1CN-8) (for speed/torque control only)
COIN (1CN-8) (for position control only)
TGON (1CN-9)

3

3.2.5 Using Electronic Gear

For position control (SGDA-□□□P) only.

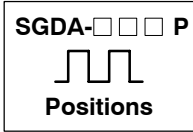

1) Outline

The electronic gear function enables the motor travel distance per input reference pulse to be set to any value. It allows the host controller to perform control without having to consider the machine gear ratio and the number of encoder pulses.

When Electronic Gear Function is Not Used

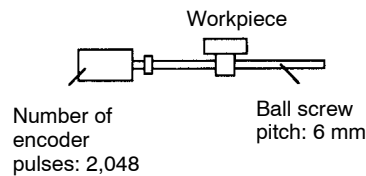

To move a workpiece 10 mm,
 One revolution is equivalent to 6 mm, so
 $10 \div 6 = 1.6666$ (revolutions)
 2048 x 4 (pulses) is equivalent to one revolution, so
 $1.6666 \times 2,048 \times 4 = 13,653$ (pulses)
 A total of 13653 pulses must be input as a reference.
 the host controller needs to make this calculation.

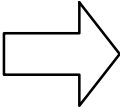

When Electronic Gear Function is Used

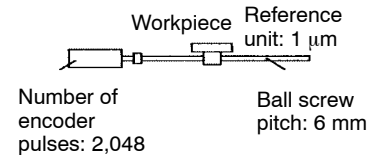

Machine conditions and reference unit must be defined for the electronic gear function beforehand.

To move a workpiece 10 mm:
 Reference unit is 1 μm, so
 $10 \text{ mm} \div 1 \mu\text{m} = 10,000$ pulses

2) Setting the Electronic Gear

Calculate the electronic gear ratio (B/A) according to the procedure below and set the value in Cn-24 and Cn-25.

a) Check the machine specifications.

Items related to electronic gear:

- Gear ratio
- Ball screw pitch
- Pulley diameter

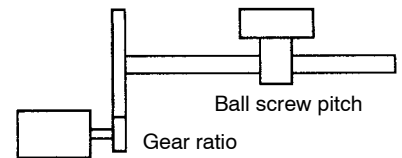

b) Check the number of encoder pulses for the SGM Servomotor.

Motor Type	Encoder Type	Number of Encoder Pulses Per Revolution
SGM-□□□31□	Incremental encoder	2048
SGM-□□□W1□	Absolute encoder	1024

Same as user constant Cn-11 settings.

- c) Determine the reference unit to be used.

Reference unit is the minimum unit of position data used for moving the load. (Minimum unit of reference from host controller)

**Examples:
0.01 mm, 0.001 mm, 0.1°, 0.01 inch**

Reference input of one pulse moves the load by one reference unit.

Example: When reference unit is 1 μm
If a reference of 50,000 pulses is input, the load moves 50 mm (50,000 x 1 μm).

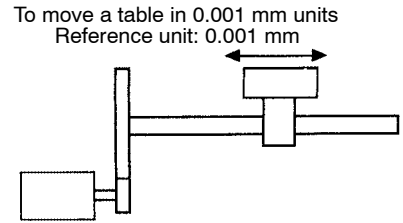

Determine the reference unit according to machine specifications and positioning accuracy.

- d) Determine the load travel distance per revolution of load shaft in reference units.

Load travel distance per revolution of load shaft (in reference units)

$$= \frac{\text{Load travel distance per revolution of load shaft (in unit of distance)}}{\text{Reference unit}}$$

**Example: When ball screw pitch is 5 mm and reference unit is 0.001 mm
5/0.001 = 5,000 (reference units)**

Ball Screw	Disc Table	Belt & Pulley
<p>Load shaft P: Pitch 1 revolution = $\frac{P}{\text{Reference unit}}$</p>	<p>Load shaft 1 revolution = $\frac{360^\circ}{\text{Reference unit}}$</p>	<p>Load shaft D: Pulley diameter 1 revolution = $\frac{\pi D}{\text{Reference unit}}$</p>

- e) Determine the electronic gear ratio $\left(\frac{B}{A}\right)$.

If the load shaft makes “n” revolutions when the motor shaft makes “m” revolutions, the gear ratio of motor shaft and load shaft is $\frac{n}{m}$.

Electronic gear ratio $\left(\frac{B}{A}\right) =$

$$\frac{\text{Number of encoder pulses} \times 4}{\text{Travel distance per revolution of load shaft (in reference units)}} \times \frac{m}{n}$$

NOTE Make sure that the electronic gear ratio meets the following condition:

$$0.01 \leq \text{Electronic gear ratio} \left(\frac{B}{A}\right) \leq 100$$

If the electronic gear ratio is outside this range, the Servopack does not work properly. In this case, modify the load configuration or reference unit.

f) Set the electronic gear ratio in the user constants below.

Reduce the electronic gear ratio $\left(\frac{B}{A}\right)$ to their lowest terms so that both A and B are an integer smaller than 65535, then set A and B in the following user constants.

$\left(\frac{B}{A}\right)$	Cn-24	RATB	Electronic gear ratio (numerator)
	Cn-25	RATA	Electronic gear ratio (denominator)

This is all that is required to set the electronic gear.

Cn-24	RATB Electronic Gear Ratio (Numerator)	Unit: None	Setting Range: 1 to 65535	Factory Setting: 1	For Position Control Only
Cn-25	RATA Electronic Gear Ratio (Denominator)	Unit: None	Setting Range: 1 to 65535	Factory Setting: 1	For Position Control Only

3

These user constants are for position control (SGDA-□□□P) only.

Set the electronic gear ratio according to machine specifications.

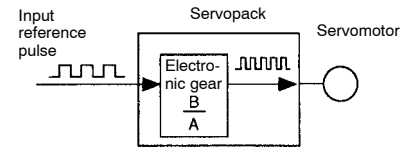

$$\text{Electronic gear ratio } \left(\frac{B}{A}\right) = \frac{\text{Cn-24}}{\text{Cn-25}}$$

$$B = [(\text{Number of encoder pulses}) \times 4] \times [\text{Motor shaft rotating speed}]$$

$$A = [\text{Reference unit (load travel distance per revolution of load shaft)}] \times [\text{Load shaft rotating speed}]$$

Note that the user constant settings must meet the following condition:

$$0.01 \leq \left(\frac{B}{A}\right) \leq 100$$

3) Examples of Setting an Electronic Gear Ratio for Different Load Mechanisms

Ball Screw

Reference unit: 0.001 mm

$$\text{Travel distance per revolution of load shaft} = \frac{6\text{mm}}{0.001\text{mm}} = 6000$$

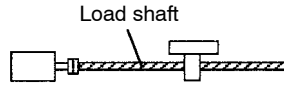

Incremental encoder:
2048 pulses per revolution

Ball screw pitch: 6 mm

$$\text{Electronic gear ratio } \left(\frac{B}{A}\right) = \frac{2048 \times 4 \times 1}{6000 \times 1} = \frac{Cn-24}{Cn-25}$$

Preset values	Cn-24	8192
	Cn-25	6000

Disc Table

Reference unit:
0.1°

Gear ratio:
3 : 1

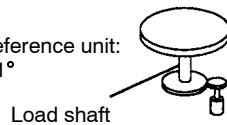

Incremental encoder:
2048 pulses per revolution

$$\text{Travel distance per revolution of load shaft} = \frac{360^\circ}{0.1^\circ} = 3600$$

$$\text{Electronic gear ratio } \left(\frac{B}{A}\right) = \frac{2048 \times 4 \times 3}{3600 \times 1} = \frac{Cn-24}{Cn-25}$$

Preset values	Cn-24	24576
	Cn-25	3600

Belt & Pulley

Reference unit: 0.0254 mm
Load shaft

$$\text{Travel distance per revolution of load shaft} = \frac{3.14 \times 100\text{mm}}{0.0254\text{mm}} = 12362$$

Gear ratio:
2.4 : 1

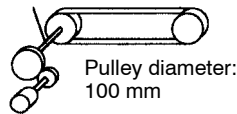

Absolute encoder:
1024 pulses per revolution

$$\text{Electronic gear ratio } \left(\frac{B}{A}\right) = \frac{1024 \times 4 \times 2.4}{12362 \times 1} = \frac{Cn-24}{Cn-25}$$

$$= \frac{9830.4}{12362} = \frac{49152}{61810}$$

Preset values	Cn-24	49152
	Cn-25	61810

4) Control Block Diagram for SGDA-□□□P Servopack for Position Control

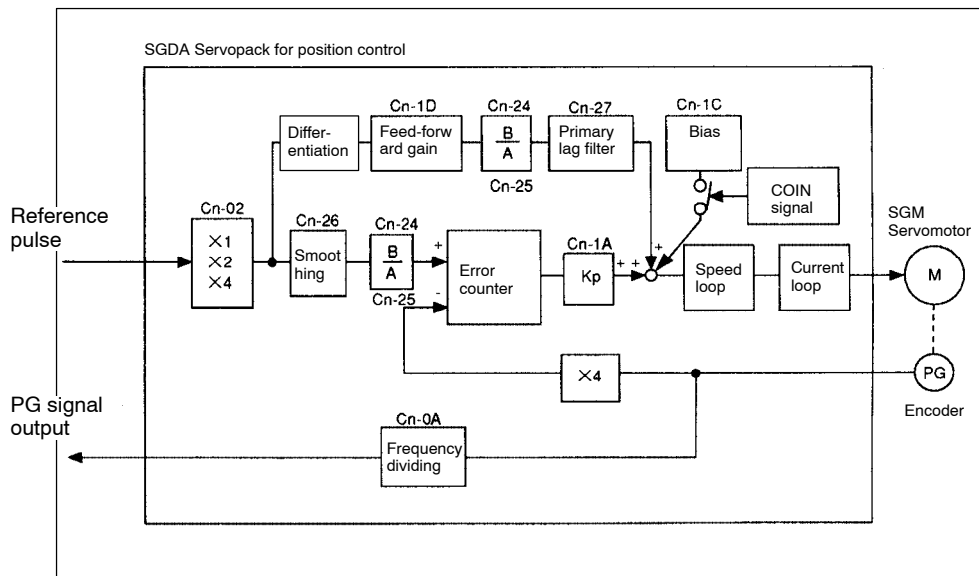

3.2.6 Using Contact Input Speed Control

- 1) The contact input speed control function provides easy-to-use speed control. It allows the user to initially set three different motor speeds in user constants, select one of the speeds externally by contact input and run the motor.

This function can be used for both speed/torque control (SGDA-□□□S) and position control (SGDA-□□□P).

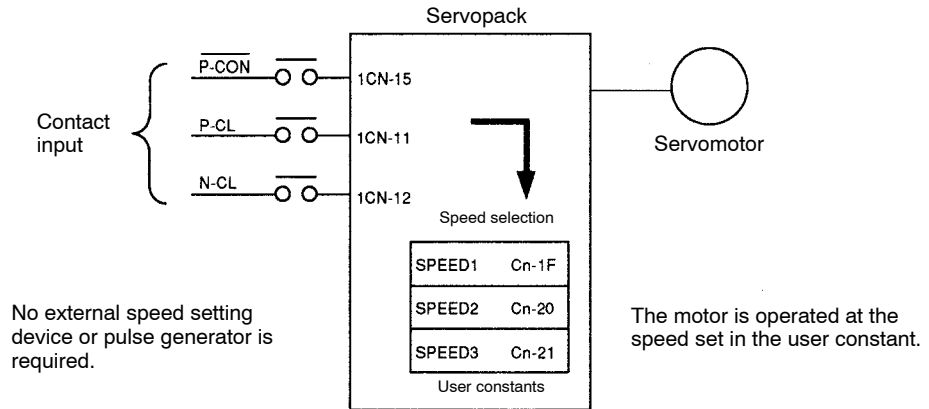

- 2) To use the contact input speed control function, perform Steps a) to c).
 - a) Set the following memory switch to 1.

Cn-02 Bit 2	Contact Input Speed Control Selection	Factory Setting: 0	For Speed/Torque Control and Position Control
--------------------	---------------------------------------	--------------------	---

Enables the contact input speed control function.

If the contact input speed control function is used, the contents of the input signals shown below will change.

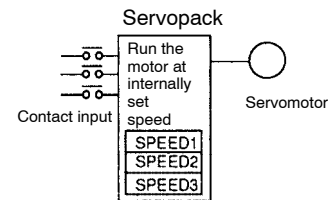

When this memory switch is reset, the meanings of the following signals will also change:

Monitor mode (Un-05) bit 7 and bit 8

3

Setting	Meaning	Input Signal			
0	Does not use the contact input speed control function.	P-CON(1CN-15)	Used to switch between P control and PI control.		
		P-CL(1CN-11)	Used for forward external current limit input		
		N-CL(1CN-12)	Used for reverse external current limit input		
1	Uses the contact input speed control function. Note In the case of the position control type, the reference pulse inhibit function (INHIBIT) cannot be used.	0: OFF, 1: ON			
		P-CON	P-CL	N-CL	Speed Setting
		Direction of rotation 0: Forward 1: Reverse	0	0	Stop (or pulse reference)
			0	1	Cn-1F, SPEED1
			1	1	Cn-20, SPEED2
1	0		Cn-21, SPEED3		

b) Set three motor speeds in the following user constants.

Constant	Description	Unit	Setting Range	Factory Setting	Application
Cn-1F	SPEED1 1st Speed (Contact Input Speed Control)	r/min	0 to Maximum Speed	100	For Speed/Torque Control and Position Control
Cn-20	SPEED2 2nd Speed (Contact Input Speed Control)	r/min	0 to Maximum Speed	200	For Speed/Torque Control and Position Control
Cn-21	SPEED3 3rd Speed (Contact Input Speed Control)	r/min	0 to Maximum Speed	300	For Speed/Torque Control and Position Control

Use these user constants to set motor speeds when the contact input speed control function is used (set bit 2 of memory switch Cn-02).

Speed selection input signals $\overline{P-CL}$ (1CN-11) and $\overline{N-CL}$ (1CN-12), and rotation direction selection signal P-CON (1CN-15) enable the motor to run at the preset speeds.

Contact input speed control (Memory switch Cn-02 bit 2 = 1)

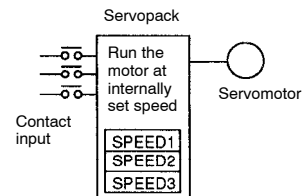

c) Set the soft start time.

Constant	Description	Unit	Setting Range	Factory Setting	Application
Cn-07	SFSACC Soft Start Time (Acceleration)	ms	0 to 10000	0	For Speed/Torque Control and Position Control
Cn-23	SFSDEC Soft Start Time (Deceleration)	ms	0 to 10000	0	For Speed/Torque Control and Position Control

In the Servopack, a speed reference is multiplied by the preset acceleration or deceleration value to provide speed control.

When a progressive speed reference is input or contact input speed control is used, smooth speed control can be performed. (For normal speed control, set "0" in each user constant.)

Set the following value in each user constant.

- Cn-07: Time interval from the time the motor starts until it reaches the maximum speed (4,500 r/min)
- Cn-23: Time interval from the time the motor is running at the maximum speed until it stops

Note For position control type, the soft start function is available only when the contact input speed control function is used.

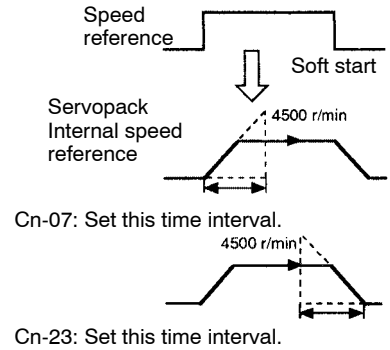

3) Contact input speed control performs the following operation.

The following input signals are used to start and stop the motor.

→ Input $\overline{\text{P-CL}}$ 1CN-11	Speed Selection 1 (Forward External Torque Limit Input)	For Speed/Torque Control and Position Control
→ Input $\overline{\text{N-CL}}$ 1CN-12	Speed Selection 2 (Reverse External Torque Limit Input)	For Speed/Torque Control and Position Control

a) Contact Input Speed Control when Cn-02 bit 2 = 1

- For Speed/Torque Control:

0: OFF, 1: ON

Contact Signal			User Constant			Selected Speed	
P-CON	P-CL	N-CL	Cn-02	Cn-01			
			Bit 2	Bit A	Bit B		
----	0	0	1	0	0	Stop	Stopped by internal speed reference 0
				1	0		Stopped by zero-clamp
				0	1	Analog speed reference (V-REF) input	With zero-clamp function
				1	1		
Direction of rotation 0: Forward 1: Reverse	0	1	----	----	SPEED1 (Cn-1F)		
	1	1			SPEED2 (Cn-20)		
	1	0			SPEED3 (Cn-21)		

Preset values (0 or 1) and input signal status in the portions indicated by horizontal bars (–) are optional.

- For Position Control:

0: OFF, 1: ON

Contact Signal			User Constant		Selected Speed
$\overline{P-CON}$	$\overline{P-CL}$	$\overline{N-CL}$	Cn-0 2	Cn-01	
			Bit 2	Bit F	
-----	0	0	1	0	Stop
				1	Pulse reference input
Direction of rotation 0: Forward rotation 1: Reverse rotation	0	1		-----	SPEED (Cn-1F)
	1	1			SPEED (Cn-20)
	1	0			SPEED (Cn-21)

Preset values (0 or 1) and input signal status in the portions indicated by horizontal bars (-) are optional.

Note When the contact input speed control function is used, the reference pulse inhibit function is not available.

b) Standard Setting when Cn-02 bit 2 = 0

Input signals are used as external torque limit input.

Input signal $\overline{P-CON}$ is used to specify the direction of motor rotation.

→ Input $\overline{P-CON}$ 1CN-15	Proportional Control, etc.	For Speed/Torque Control and Position Control
---	----------------------------	---

a) Contact Input Speed Control when Cn-02 bit 2 = 1

Use input signal $\overline{P-CON}$ to specify the direction of motor rotation.

P-CON	Meaning
1	Reverse rotation
0	Forward rotation

0: OFF (high level), 1: ON (low level)

b) Standard Setting when Cn-02 bit 2 = 0

$\overline{P-CON}$ signal is used for proportional control, zero-clamp and torque/speed control changeover.

Note For the speed/torque control type, control by external reference (voltage reference) is possible when the contact input speed control function is used by setting bits A and B of user constant Cn-01.

For the position control type, control by external reference (pulse reference) is possible when the contact input speed control function is used by setting bit F of user constant Cn-01.

- 4) The figure below illustrates an example of operation in contact input speed control mode. Using the soft start function reduces physical shock at speed changeover.

When Contact Input Speed Control is Used

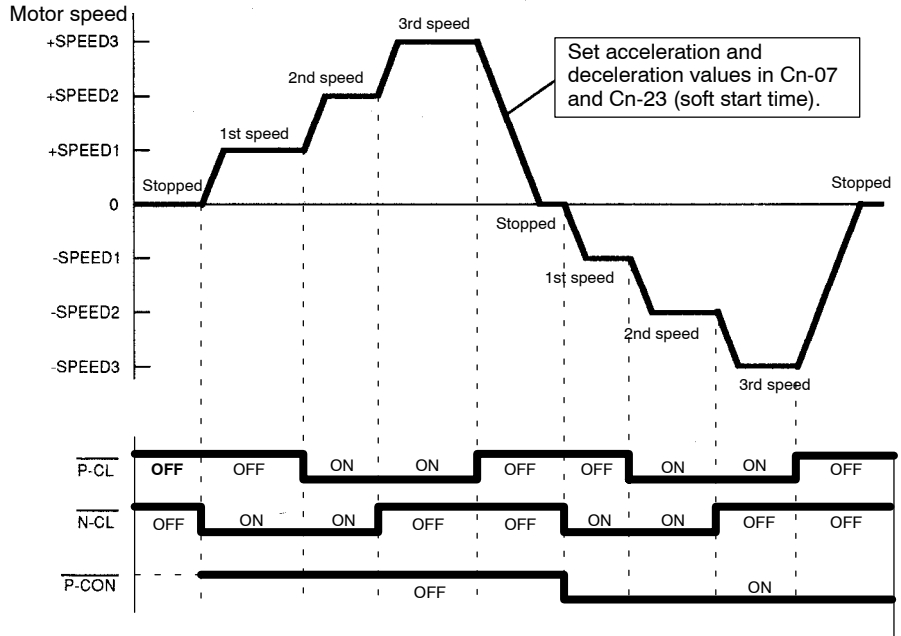

Note For the position control type, the soft start function is available only when contact input speed control is used. The soft start function is not available when pulse reference input is used.

For the position control type, if contact input speed control mode is switched to pulse reference input mode when the motor is running at the 1st, 2nd or 3rd speed, the Servopack does not receive a pulse reference until positioning complete signal $\overline{\text{COIN}}$ is output.

Always start outputting a pulse reference from the host controller after a positioning complete signal is output from the Servopack.

Signal Generation Timing for Position Control Type

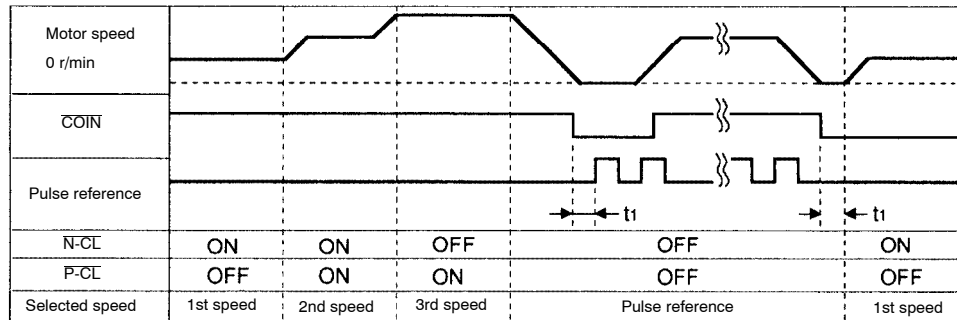

$t_1 > 6 \text{ ms}$

The above figure illustrates signal generation timing when the soft start function is used.

The value of t_1 is not influenced by use of the soft start function.

A maximum of 6 ms delay occurs when $\overline{\text{P-CL}}$ or $\overline{\text{N-CL}}$ signal is read.

3.2.7 Using Torque Control

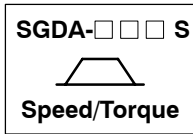

1) The Servopack can provide the following torque control:

- Torque restriction
 - Level 1: To restrict the maximum output torque to protect the machine or workpiece
 - Level 2: To restrict torque after the motor moves the machine to a specified position
- Torque control
 - Level 3: To always control output torque, not speed
 - Level 4: To switch between speed control and torque control

This section describes how to use levels 3 and 4 of the torque control function.

2) Use the following memory switch to select level 3 (torque control I) or level 4 (torque control II).

Cn-01 Bit A	Control Mode Selection	Factory Setting: 0	For Speed/Torque Control Only
Cn-01 Bit B	Control Mode Selection	Factory Setting: 0	For Speed/Torque Control Only

This is dedicated torque control.

A motor torque reference value is externally input into the Servopack to control torque.

Examples of Use: Tension control Pressure control

Cn-01 Setting		Control Mode
Bit B	Bit A	
1	0	<p>Torque Control I</p> <p>This is a dedicated torque control mode.</p> <div style="text-align: right;"> </div> <ul style="list-style-type: none"> • A torque reference is input from T-REF (1CN-1). • $\overline{P-CON}$ is not used. • Speed reference input V-REF (1CN-3) cannot be used. • User constant Cn-14 can be used for maximum speed control. <p>Example of Use:</p> <div style="text-align: center;"> </div>

Cn-01 Setting		Control Mode				
Bit B	Bit A					
1	1	<p>Torque Control II</p> <p>Torque control and speed control can be switched.</p> <ul style="list-style-type: none"> • A speed reference or speed limit value is input from V-REF (1CN-3). • T-REF (1CN-1) inputs a torque reference, torque feed-forward reference or torque limit value depending on the control mode used. • P-CON (1CN-15) is used to switch between torque control and speed control. <table border="1"> <tr> <td>When 1CN-15 is open</td> <td>Torque control</td> </tr> <tr> <td>When 1CN-15 is at 0 V</td> <td>Speed control</td> </tr> </table> <div style="float: right; text-align: center;"> </div>	When 1CN-15 is open	Torque control	When 1CN-15 is at 0 V	Speed control
When 1CN-15 is open	Torque control					
When 1CN-15 is at 0 V	Speed control					
1	1	<p>For Torque Control when P-CON is OFF:</p> <ul style="list-style-type: none"> • T-REF reference controls torque. • V-REF can be used to limit motor speed. • V-REF voltage (+) limits motor speed during forward or reverse rotation. <p>Principle of Speed Restriction:</p> <p>When the speed exceeds the speed limit, negative feedback of torque proportional to the difference between the current speed and the limit speed is performed to return the speed to within the normal speed range. Therefore, the actual motor speed limit value has a certain range depending on the load conditions.</p> <div style="float: right; text-align: center;"> </div>				

3

Cn-01 Setting		Control Mode																																											
Bit B	Bit A																																												
1	1	For Speed Control when P-CON is ON: Values set in bit F of user constant Cn-01 and bit F of Cn-02 determine the following:																																											
		<table border="1"> <thead> <tr> <th colspan="2">User Constant</th> <th rowspan="2">Speed Reference Input (V-REF) (1CN-3,4)</th> <th rowspan="2">Torque Input (T-REF) (1CN-1,2)</th> <th rowspan="2">Remarks</th> </tr> <tr> <th>Cn-01</th> <th>Cn-02</th> </tr> <tr> <th>Bit F</th> <th>Bit F</th> <td colspan="2"></td> <td></td> </tr> </thead> <tbody> <tr> <td>0</td> <td>0</td> <td colspan="2">Speed control</td> <td></td> </tr> <tr> <td></td> <td></td> <td>Speed reference</td> <td>Cannot be used</td> <td></td> </tr> <tr> <td>1</td> <td>----</td> <td colspan="2">Speed control with torque feed-forward</td> <td>Any value can be set in bit F of Cn-02 (0 and 1 have the same effect). For details of speed control with torque feed-forward, refer to 3.2.8 Using Torque Feed-forward Function.</td> </tr> <tr> <td></td> <td></td> <td>Speed reference</td> <td>Torque feed-forward</td> <td></td> </tr> <tr> <td>0</td> <td>1</td> <td colspan="2">Speed control with torque limit by analog voltage reference</td> <td>For details of speed control with torque limit by analog voltage reference, refer to 3.2.9 Using Torque Restriction by Analog Voltage Reference.</td> </tr> <tr> <td></td> <td></td> <td>Speed reference</td> <td>Torque limit value</td> <td></td> </tr> </tbody> </table>		User Constant		Speed Reference Input (V-REF) (1CN-3,4)	Torque Input (T-REF) (1CN-1,2)	Remarks	Cn-01	Cn-02	Bit F	Bit F				0	0	Speed control					Speed reference	Cannot be used		1	----	Speed control with torque feed-forward		Any value can be set in bit F of Cn-02 (0 and 1 have the same effect). For details of speed control with torque feed-forward, refer to 3.2.8 Using Torque Feed-forward Function.			Speed reference	Torque feed-forward		0	1	Speed control with torque limit by analog voltage reference		For details of speed control with torque limit by analog voltage reference, refer to 3.2.9 Using Torque Restriction by Analog Voltage Reference.			Speed reference	Torque limit value	
		User Constant		Speed Reference Input (V-REF) (1CN-3,4)	Torque Input (T-REF) (1CN-1,2)				Remarks																																				
		Cn-01	Cn-02																																										
Bit F	Bit F																																												
0	0	Speed control																																											
		Speed reference	Cannot be used																																										
1	----	Speed control with torque feed-forward		Any value can be set in bit F of Cn-02 (0 and 1 have the same effect). For details of speed control with torque feed-forward, refer to 3.2.8 Using Torque Feed-forward Function.																																									
		Speed reference	Torque feed-forward																																										
0	1	Speed control with torque limit by analog voltage reference		For details of speed control with torque limit by analog voltage reference, refer to 3.2.9 Using Torque Restriction by Analog Voltage Reference.																																									
		Speed reference	Torque limit value																																										
0	0	Speed control (Standard setting)																																											
0	1	Zero-clamp speed control																																											

3) The following input signals perform torque control.

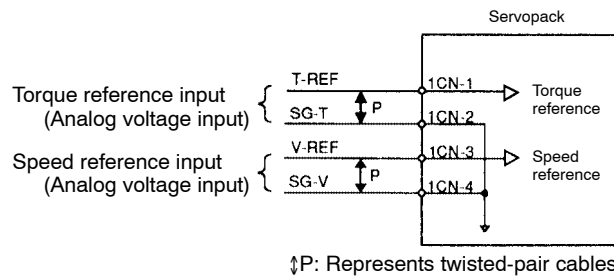

→ Input T-REF 1CN-1	Torque Reference Input	For Speed/Torque Control Only
→ Input SG-T 1CN-2	Signal Ground for Torque Reference Input	For Speed/Torque Control Only

These signals are used when torque control is selected (bits A and B of memory switch Cn-01).

Motor torque is controlled so that it is proportional to the input voltage between T-REF and SG-T.

Standard Setting

Cn-13 = 30: This setting means that 3 V is equivalent to rated torque.

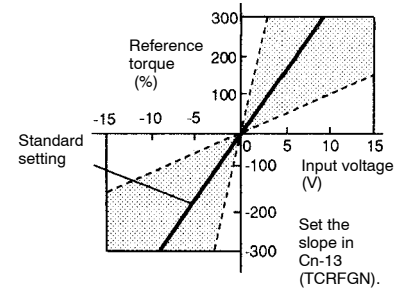

- Examples:
- +3 V input → Rated torque in forward direction
 - +9 V input → 300% of rated torque in forward direction
 - 0.3 V input → 10% of rated torque in reverse direction

User constant Cn-13 can be used to change the voltage input range.

Example of Input Circuit:
See the figure on the right.

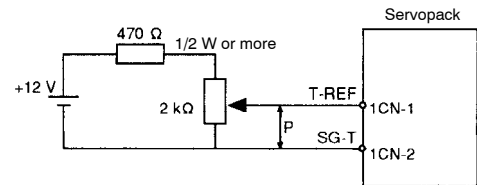

- For noise control, always use twisted-pair cables.
- Example of Variable Resistor for Speed Setting:
Type 25HP-10B manufactured by Sakae Tsushin Kogyo Co., Ltd.

→ Input V-REF 1CN-3	Speed Reference Input (or Speed Limit Input)	For Speed/Torque Control Only
→ Input SG-V 1CN-4	Signal Ground for Speed Reference Input	For Speed/Torque Control Only

These signals are used when speed control is selected (bits A and B of memory switch Cn-01).

For normal speed control, always connect these signal terminals.

Motor speed is controlled so that it is proportional to the input voltage between V-REF and SG-V.

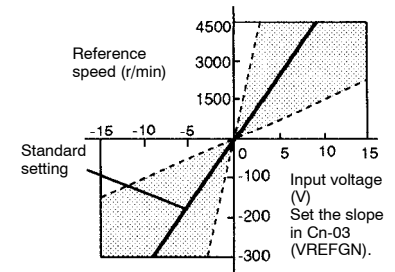

Standard Setting

Cn-03 = 500: This setting means that 6 V is equivalent to rated speed (3000 r/min).

- Examples:
- +6 V input → 3000 r/min in forward direction
 - +1 V input → 500 r/min in forward direction
 - 3 V input → 1500 r/min in reverse direction

User constant Cn-03 can be used to change the voltage input range. (This is also applicable to speed restriction.)

Example of Input Circuit:
See the figure on the right.

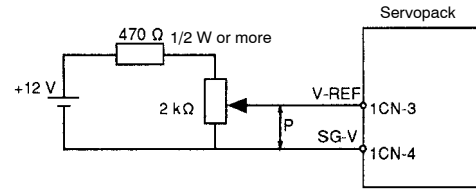

- For noise control, always use twisted-pair cables.

- Example of Variable Resistor for Speed Setting:
Type 25HP-10B manufactured by Sakae Tsushin Kogyo Co., Ltd.

When input signal $\overline{P-CON}$ is used to switch between speed reference and torque reference for torque control II, set both bits A and B of memory switch Cn-01 to 1.

3

→ Input $\overline{P-CON}$ 1CN-15	Proportional Control, etc.	For Speed/Torque Control and Position Control
-----------------------------------	----------------------------	---

The function of this input signal varies according to the memory switch setting.

Cn-02 Bit 2	Cn-01 Bit B	Cn-01 Bit A	Function of $\overline{P-CON}$
0	0	0	Proportional control (Standard setting)
0	0	1	For speed/torque control (SGDA-□□□S) only Zero-clamp control
0	1	0	For speed/torque control (SGDA-□□□S) only Not used
0	1	1	For speed/torque control (SGDA-□□□S) only Torque/speed changeover control
1	-	-	Rotation direction control for contact input speed control

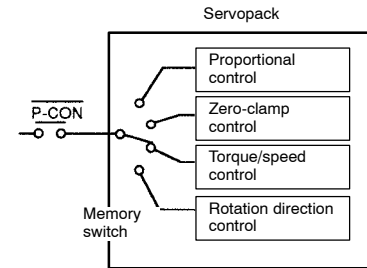

The function of $\overline{P-CON}$ signal varies according to the memory switch setting.

• **Torque/Speed Changeover Control**

This function is used to switch between torque control and speed control in torque control II mode.

ON: 1CN-15 is at low level.	Speed control
OFF: 1CN-15 is at high level.	Torque control

4) Set the following user constants for torque control according to the servo system used.

Cn-13	TCRFGN Torque Reference Gain	Unit: 0.1 V/Rated Torque	Setting Range: 10 to 100	Factory Setting: 30	For Speed/Torque Control Only
--------------	---------------------------------	-----------------------------	-----------------------------	------------------------	-------------------------------

This user constant is for speed/torque control (SGDA-□□□S) only.

Sets the voltage range of torque reference input T-REF (1CN-1) according to the output form of the host controller or external circuit.

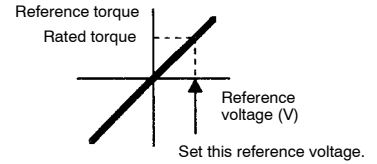

The factory setting is 30, so the rated torque is 3 V (30 x 0.1).

Cn-14	TCRLMT Speed Limit for Torque Control I	Unit: r/min	Setting Range: 0 to Maximum Speed	Factory Setting: Maximum Speed	For Speed/Torque Control Only
--------------	--	----------------	-----------------------------------	-----------------------------------	-------------------------------

Sets a motor speed limit value in this constant when torque control I is selected.

This user constant is used to prevent machine overspeed during torque control.

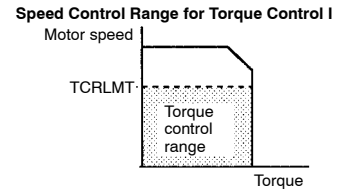

For torque control I, set bits A and B of memory switch Cn-01.

Cn-03	VREFGN Speed Reference Gain	Unit: (r/min)/V	Setting Range: 0 to 2162	Factory Setting: 500	For Speed/Torque Control Only
--------------	--------------------------------	--------------------	--------------------------	-------------------------	-------------------------------

This user constant is for speed/torque control (SGDA-□□□S) only.

Sets the voltage range of speed reference input V-REF (1CN-3) according to the output form of the host controller or external circuit.

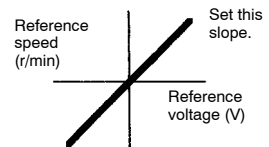

The factory setting is 500 [rated speed (3,000 r/min)/6 V = 500].

3.2.8 Using Torque Feed-forward Function

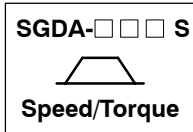

For speed/torque control (SGDA-□□□S) only.

1) Outline

The torque feed-forward function reduces positioning time. It differentiates a speed reference at the host controller (prepared by the customer) to generate a torque feed-forward reference, then sends this torque feed-forward reference and the speed reference to the Servopack.

Too high a torque feed-forward value will result in overshoot or undershoot. To prevent this, set the optimum value while observing system response.

Connect a speed reference signal line and torque feed-forward reference signal line from the host controller to V-REF (1CN-3, 1CN-4) and T-REF (1CN-1, 1CN-2), respectively.

3

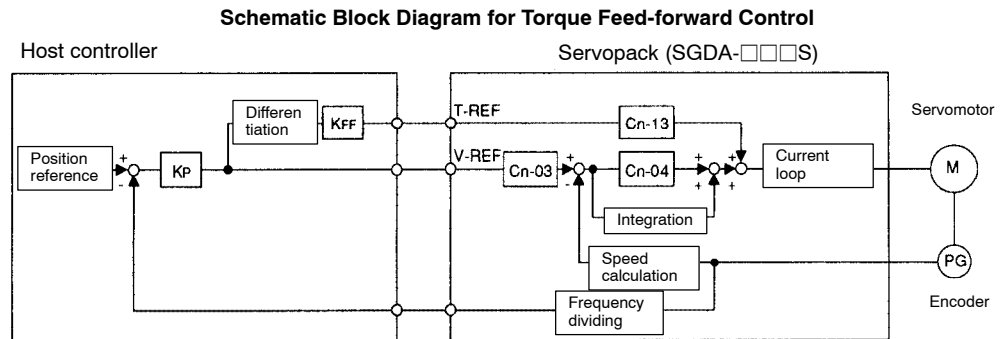

KP: Position loop gain
KFF: Feed-forward gain

2) How to Use Torque Feed-forward Function

To use the torque feed-forward function, set the following memory switch to 1.

Cn-01 Bit F	Selection of Torque Feed-forward Function	Factory Setting: 0	For Speed/Torque Control Only
--------------------	---	--------------------	-------------------------------

Enables the torque feed-forward function.

To use the torque feed-forward function, input a speed reference to the V-REF terminal and a torque feed-forward reference to the T-REF terminal.

The host controller must generate a torque feed-forward reference from a speed reference.

Setting	Meaning
0	Does not use the torque feed-forward function.
1	Uses the torque feed-forward function.

- This function cannot be used with the function for torque restriction by analog voltage reference, described in 3.2.9 Using Torque Restriction by Analog Voltage Reference.
- For user constants and control modes, refer to Appendix D List of User Constants.

3) **Setting a Torque Feed-forward Value in User Constant Cn-13**

The factory setting is Cn-13 = 30. If, for example, the torque feed-forward value is ± 3 V, torque is restricted to $\pm 100\%$ (rated torque).

Cn-13	TCRFGN Torque Reference Gain	Unit: 0.1 V/Rated Torque	Setting Range: 10 to 100	Factory Setting: 30	For Speed/Torque Control Only
--------------	------------------------------------	--------------------------------	--------------------------------	---------------------------	----------------------------------

3.2.9 Using Torque Restriction by Analog Voltage Reference

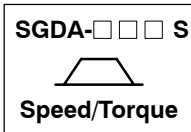

For speed/torque control (SGDA-□□□S) only.

1) **Outline**

This function restricts torque by assigning the T-REF terminal (1CN-3, 1CN-4) a torque limit value in terms of analog voltage. Since torque reference input terminal T-REF is used as an input terminal, this function cannot be used for torque control.

Schematic Block Diagram for Torque Restriction by Analog Voltage Reference

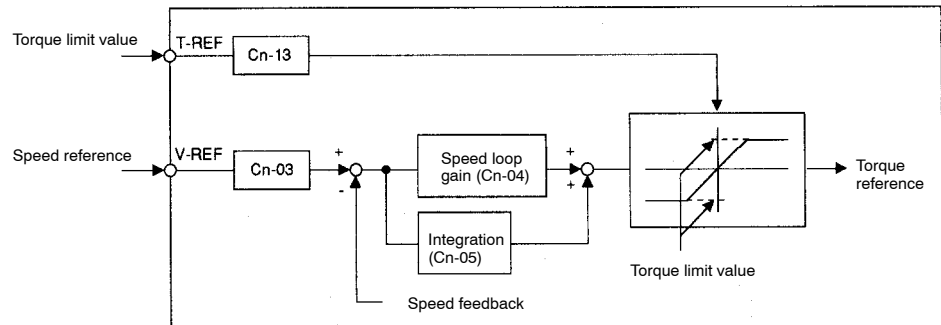

2) **How to Use Torque Restriction by Analog Voltage Reference**

To use this torque restriction function, set the following memory switch to 1.

Cn-02 Bit F	Torque Restriction by Analog Voltage Reference	Factory Setting: 0	For Speed/Torque Control Only
--------------------	---	-----------------------	----------------------------------

Enables this torque restriction function.

3.2.9 Using Torque Restriction by Analog Voltage Reference cont.

To use this function, input a speed reference to the V-REF terminal and a torque limit value to the T-REF terminal.

This function cannot be used for torque control.

Torque restriction cannot be set separately for forward and reverse rotation. (The same setting applies to both forward and reverse rotation.)

Setting	Meaning
0	Uses the T-REF terminal as a torque reference or torque feed-forward reference input terminal.
1	Uses the T-REF terminal as a torque limit value input terminal.

- This function cannot be used with the torque feed-forward function described in 3.2.8 *Using Torque Feed-forward Function*.

- For user constants and control modes, refer to *Appendix D List of User Constants*.

3) **Setting a Torque Limit Value in User Constant Cn-13**

The factory setting is Cn-13 = 30. If, for example, the torque limit value is 3 V, torque is restricted to 100% (rated torque). A torque value in excess of 100% is clamped at 100%.

Cn-13	TCRFGN Torque Reference Gain	Unit: 0.1 V/ Rated Torque	Setting Range: 10 to 100	Factory Setting: 30	For Speed/Torque Control Only



3.2.10 Using the Reference Pulse Inhibit Function (INHIBIT)

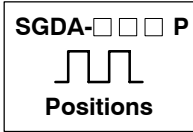

For position control (SGDA-□□□P) only.

1) Outline

This function inhibits a Servopack for position control from counting input reference pulses.

While this function is being used, the motor remains in servo locked (clamped) status. The P-CON signal is used to enable or prohibit this function.

When this function is used, therefore, the P-CON signal cannot be used to switch between proportion (P) control and proportional/integral (PI) control for speed loop. (PI control is always used.)

Schematic Block Diagram for INHIBIT Function

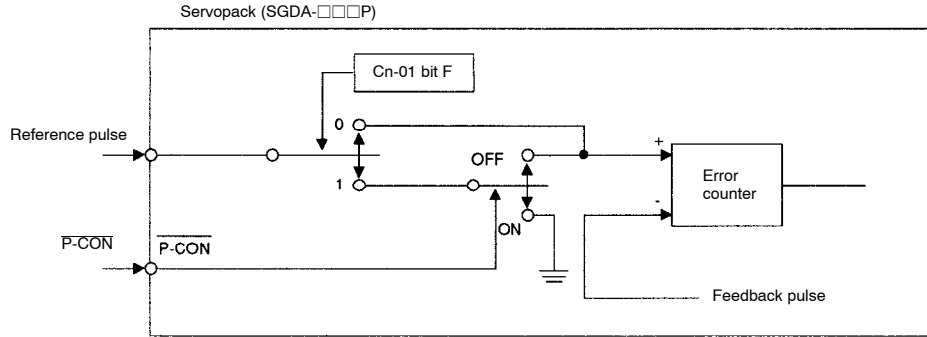

Note: Whether INHIBIT function is used, select by bit F of Cn-01.

2) How to Use Reference Pulse Inhibit Function (INHIBIT)

To use the INHIBIT function, set the bit F of memory switch Cn-01 to 1:

Cn-01 Bit F	Reference Pulse Inhibit Function (INHIBIT)	Factory Setting: 0	For Position Control Only
--------------------	--	--------------------	---------------------------

Enables the INHIBIT function.

Setting	Meaning						
0	Does not use the INHIBIT function. Reference pulses are always counted.						
1	Uses the INHIBIT function. P-CON signal is used to enable or prohibit the INHIBIT function.						
	<table border="1"> <thead> <tr> <th>P-CON</th> <th>Meaning</th> </tr> </thead> <tbody> <tr> <td>OFF</td> <td>Counts reference pulses.</td> </tr> <tr> <td>ON</td> <td>Prohibits the Servopack from counting reference pulses. The motor remains in servo locked (clamped) status.</td> </tr> </tbody> </table>	P-CON	Meaning	OFF	Counts reference pulses.	ON	Prohibits the Servopack from counting reference pulses. The motor remains in servo locked (clamped) status.
	P-CON	Meaning					
OFF	Counts reference pulses.						
ON	Prohibits the Servopack from counting reference pulses. The motor remains in servo locked (clamped) status.						

3.2.10 Using the Reference Pulse Inhibit Function (INHIBIT) cont.

- Always set bit 2 of memory switch Cn-02 to 0.
If bit 2 is set to 1, the contact input speed control function is selected, and the INHIBIT function cannot be used. (The $\overline{P-CON}$ signal is used for changing the motor rotation direction. For the contact input speed function, refer to 3.2.6 Using Contact Input Speed Control.)

3) Relationship between INHIBIT Signal and Reference Pulse

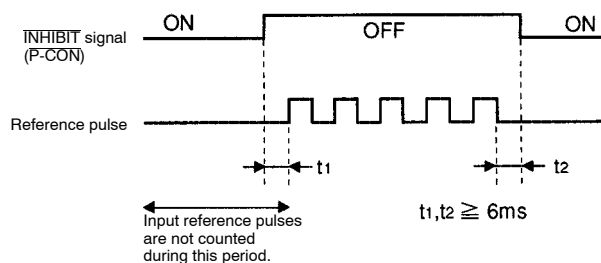

3.2.11 Using the Reference Pulse Input Filter Selection Function



For position control (SGDA-□□□P) only.

1) Outline

This function selects a reference pulse input filter inside the Servopack according to the output form of reference pulses from the host controller.

2) How to Use Reference Pulse Input Filter

Set the following memory switch according to the output form of reference pulses from the host controller:

Cn-02 Bit F	Reference Pulse Input Filter Selection Function	Factory Setting: 0	For Position Control Only
--------------------	---	--------------------	---------------------------

Sets the memory switch according to the output form (line driver or open collector) of reference pulses from the host controller.

Setting	Meaning
0	Output form of reference pulses from host controller: Line driver output (maximum frequency of reference pulse: 450 kpps)
1	Output form of reference pulses from host controller: Open collector output (maximum frequency of reference pulse: 200 kpps)

- For open collector output, the wire length must be as short as possible (maximum 3 m).

Note Even if the open collector output is used, if frequency of reference pulse exceeds 200 kpps, reference pulses may be miscounted (resulting in wrong positioning) due to noise. If over 200 kpps reference pulses are output, make sure to set bit F of Cn-02 to 0.

3.3 Setting Up the Σ Servopack

■ This section describes how to set user constants to operate the SGDA Servopack.

3.3.1	Setting User Constants	100
3.3.2	Setting the Jog Speed	101
3.3.3	Setting the Number of Encoder Pulses	102
3.3.4	Setting the Motor Type	103

3.3.1 Setting User Constants

1) Σ-series Servopacks provide many functions, and have parameters called “user constants” to allow the user to specify each function and perform fine adjustment.

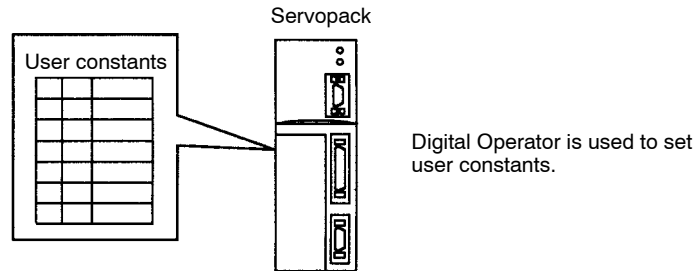

2) User constants are divided into the following two types.

1) Memory switch Cn-01, Cn-02	Each bit of this switch is turned ON or OFF to specify a function.
2) User constant setting Cn-03 and later	A numerical value such as a torque limit value or speed loop gain is set in this constant.

• For Speed/Torque Control:

User Constant	Name and Code		Remarks
Cn-01	Memory switch		} Each bit number has a switch (ON/OFF).
Cn-02	Memory switch		
Cn-03	VREFGN	Speed reference gain	} User constant setting
Cn-..	
Cn-..	
Cn-29	AXISNO	Axis address	

- For Position Control:

User Constant	Name and Code		Remarks
Cn-01	Memory switch		Each bit number has a switch (ON/OFF).
Cn-02	Memory switch		
Cn-04	LOOPHZ	Speed loop gain	User constant setting
Cn-..	
Cn-..	
Cn-29	AXISNO	Axis address	

- 3) For a list of user constants, refer to *Appendix D List of User Constants*.

Some user constants for speed/torque control type (SGDA-□□□S) and position control type (SGDA-□□□P) have different meanings. Refer to a list of user constants for each type.

- 4) For details of how to set user constants, refer to *4.1.5 Operation in User Constant Setting Mode*

3.3.2 Setting the Jog Speed

- 1) Use the following user constant to set or modify a motor speed when operating the Σ -series Servo from a Digital Operator:

User Constant	Name and Code	Unit	Setting Range	Factory Setting	Remarks
Cn-10	JOGSPD Jog Speed	r/min	0 to Maximum Speed	500	For Speed/Torque Control and Position Control

This constant is used to set a motor speed when the motor is operated using a Digital Operator.

Operation Using Digital Operator

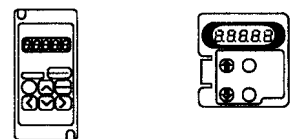

3.3.3 Setting the Number of Encoder Pulses

- 1) To ensure that the Σ -series Servo System operates properly, set the type of the encoder to be used and the number of encoder pulses per revolution in the following user constants:

Cn-01 Bit E	Encoder Type Selection	Factory Setting: 0	For Speed/Torque Control and Position Control
--------------------	------------------------	--------------------	---

Set the encoder type according to the servomotor type to be used.

After changing the memory switch setting, turn the power OFF, then ON.

Motor Type	Number of Encoder Pulses Per Revolution	Preset Value
SGM-□□□31□ SGMP-□□□31□	Incremental encoder: 2048 pulses per revolution	0
SGM-□□□W1□ SGMP-□□□W1□	Absolute encoder: 1024 pulses per revolution	1

Cn-11	PULSNO Number of Encoder Pulses	Unit: Pulses Per Revolution	Setting Range: Number of Encoder Pulses	Factory Setting: 2048	For Speed/Torque Control and Position Control
--------------	------------------------------------	-----------------------------	---	-----------------------	---

Set the number of encoder pulses according to the servomotor type to be used. If this user constant is set incorrectly, system operation cannot be guaranteed.

After changing the memory switch setting, turn the power OFF, then ON.

Motor Type	Number of Encoder Pulses Per Revolution	Preset Value
SGM-□□□31□ SGMP-□□□31□	Incremental encoder: 2048 pulses per revolution	2048
SGM-□□□W1□ SGMP-□□□W1□	Absolute encoder: 1024 pulses per revolution	1024

3

3.3.4 Setting the Motor Type

- 1) To ensure that the Σ -series Servo System operates properly, set the type of the servomotor to be used in the following user constant.

Cn-02 Bit 8	Motor Selection	Factory Setting: SGDA-□□□: 0 SGDA-□□□P: 1	For Speed/Torque Control and Position Control
--------------------	-----------------	---	--

Set this memory switch according to the servomotor type to be used (SGM or SGMP). After changing the memory switch setting, turn the power OFF, then ON.

Motor Type	Preset Value
SGM-□□□□□□	0
SGMP-□□□□□□	1

3.4 Setting Stop Mode

■ This section describes how to stop the motor properly.

3.4.1	Adjusting Offset	104
3.4.2	Using Dynamic Brake	105
3.4.3	Using Zero-Clamp	106
3.4.4	Using Holding Brake	107

3.4.1 Adjusting Offset

1) "Why does not the motor stop?"

When 0 V is specified as reference voltage for Servopack for speed/torque control, the motor may rotate at a very slow speed and fail to stop. This happens when reference voltage from the host controller or external circuit has a slight reference offset (in mV units). If this offset is adjusted to 0 V, the motor will stop.

When reference voltage from the host controller or external circuit has an offset

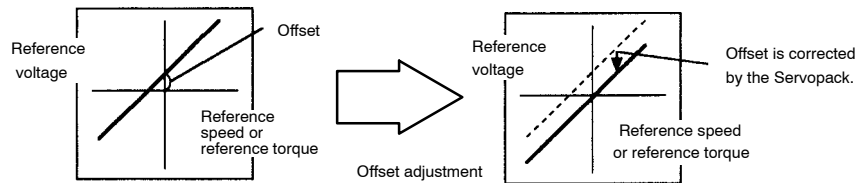

2) The following two methods can be used to adjust the reference offset to 0 V.

1) Automatic adjustment of reference offset	Reference offset is automatically adjusted to 0 V.
2) Manual adjustment of reference offset	Reference offset can be intentionally set to a specified value.

NOTE If a position control loop is formed in the host controller, do not use automatic adjustment in 1. Always use manual adjustment in 2.

- 3) For detailed adjustment procedures, refer to the following sections.

	Adjustment Method
1) Automatic adjustment of reference offset	4.2.4 Reference Offset Automatic Adjustment
2) Manual adjustment of reference offset	4.2.5 Speed Reference Offset Manual Adjustment Mode

3.4.2 Using Dynamic Brake

- 1) To stop the servomotor by applying **dynamic brake (DB)**, set desired values in the following memory switch. If dynamic brake is not used, the servomotor will stop naturally due to machine friction.

Cn-01Bit 6	How to Stop Motor When Servo is Turned OFF	Factory Setting: 0	For Speed/Torque Control and Position Control
Cn-01Bit 7	Operation to Be Performed When Motor Stops After Servo is Turned OFF	Factory Setting: 1	For Speed/Torque Control and Position Control

The Servopack enters servo OFF status when:

- Servo ON input signal (S-ON, 1CN-14) is turned OFF
- Servo alarm arises
- Power is turned OFF

Specify how to stop the motor when one of the above events occurs during operation.

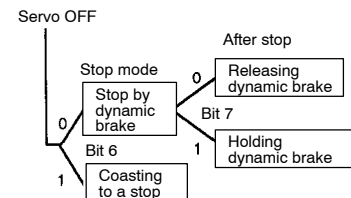

	Setting	Meaning
Cn-01 bit 6	0	Stops the motor by dynamic brake.
	1	Causes the motor to coast to a stop. The motor power is OFF and stops due to machine friction.

If dynamic brake stop mode is selected, specify the operation to be performed when the motor stops.

	Setting	Meaning
Cn-01 bit 7	0	Releases dynamic brake after the motor stops.
	1	Does not release dynamic brake even after the motor stop.



Dynamic brake (DB)

One of the general methods to cause a motor sudden stop. "Dynamic brake" suddenly stops a servomotor by shorting its electrical circuit.

This dynamic brake circuit is incorporated in the Servopack.

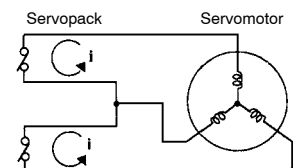

3.4.3 Using Zero-Clamp

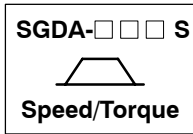

- 1) The zero-clamp function is used for a system in which the host controller does not form a position loop by speed reference input.

In other words, this function is used to cause the motor to stop and enter a servo locked status when the input voltage of speed reference V-REF is not 0 V. When the zero-clamp function is turned ON, an internal position loop is temporarily formed, causing the motor to be clamped within one pulse. Even if the motor is forcibly rotated by external force, it returns to the zero-clamp position.

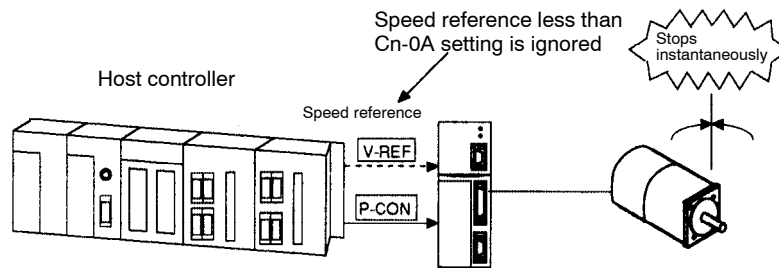

- 2) Set the following memory switch so that input signal $\overline{P-CON}$ can be used to enable or disable the zero-clamp function.

Cn-01Bit A	Control Mode Selection	Factory Setting:0	For Speed/Torque Control Only
Cn-01Bit B	Control Mode Selection	Factory Setting:0	For Speed/Torque Control Only

→ Input $\overline{P-CON}$ 1CN-15	Proportional Control, etc.	For Speed/Torque Control and Position Control
-----------------------------------	----------------------------	---

Cn-01 Setting		Control Mode									
Bit B	Bit A										
0	1	<p>Zero-clamp Speed Control</p> <p>This speed control allows the zero-clamp function to be set when the motor stops.</p> <ul style="list-style-type: none"> • A speed reference is input from V-REF (1CN-3). • $\overline{P-CON}$ (1CN-15) is used to turn the zero-clamp function ON or OFF. <table border="1"> <tr> <td>$\overline{P-CON}$ (1CN-15) is open (OFF)</td> <td>Turns zero-clamp function OFF</td> </tr> <tr> <td>$\overline{P-CON}$ (1CN-15) is closed (ON)</td> <td>Turns zero-clamp function ON</td> </tr> </table>	$\overline{P-CON}$ (1CN-15) is open (OFF)	Turns zero-clamp function OFF	$\overline{P-CON}$ (1CN-15) is closed (ON)	Turns zero-clamp function ON	<p>Servopack</p> <table border="1"> <tr> <td>Speed reference</td> <td>V-REF (1CN-3)</td> </tr> <tr> <td>Zero-clamp</td> <td>$\overline{P-CON}$ (1CN-15)</td> </tr> </table> <p>Zero-clamp is performed when the following two conditions are met: $\overline{P-CON}$ signal is closed. Motor speed is below the value set in Cn-0F (ZCLVL).</p>	Speed reference	V-REF (1CN-3)	Zero-clamp	$\overline{P-CON}$ (1CN-15)
$\overline{P-CON}$ (1CN-15) is open (OFF)	Turns zero-clamp function OFF										
$\overline{P-CON}$ (1CN-15) is closed (ON)	Turns zero-clamp function ON										
Speed reference	V-REF (1CN-3)										
Zero-clamp	$\overline{P-CON}$ (1CN-15)										

- 3) Set in the following user constant the motor speed level at which zero-clamp is to be performed:

Cn-0F	ZCLVL Zero-Clamp Level	Unit: r/min	Setting Range: 0 to Maximum Speed	Factory Setting: 10	For Speed/Torque Control Only
--------------	------------------------	-------------	-----------------------------------	---------------------	-------------------------------

If zero-clamp speed control is selected, set the motor speed level at which zero-clamp is to be performed.

Conditions for Zero-clamp

Zero-clamp is performed when all the following conditions are met:

- Zero-clamp speed control is selected. (Bits A and B of memory switch Cn-01 are set to 1 and 0, respectively.)
- $\overline{\text{P-CON}}$ (1CN-15) is turned ON (0 V).
- Motor speed drops below the preset value.

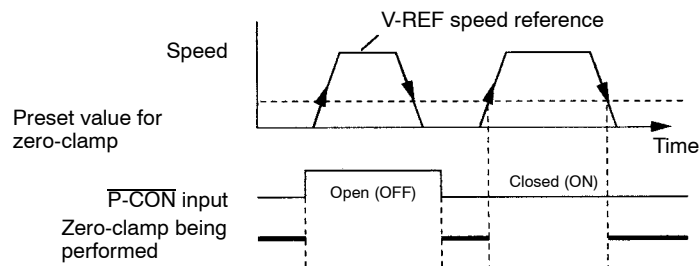

3.4.4 Using Holding Brake

1) Outline

Holding brake is useful when a servo drive is used to control a vertical axis. A servomotor with brake prevents the movable part from dropping due to gravitation when the system power is turned OFF.

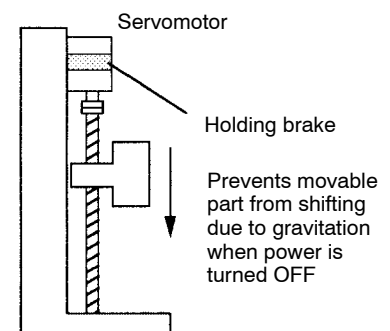

NOTE The built-in brake in Servomotor with brake is a de-energization operation type, which is used for holding purposes only and cannot be used for braking purposes. Use the holding brake only to retain a stopped motor. Brake torque is more than 100% of the rated motor torque.

- 2) Use Servopack contact output-signal \overline{BK} and brake power supply to form a brake ON/OFF circuit.

An example of standard wiring is shown below.

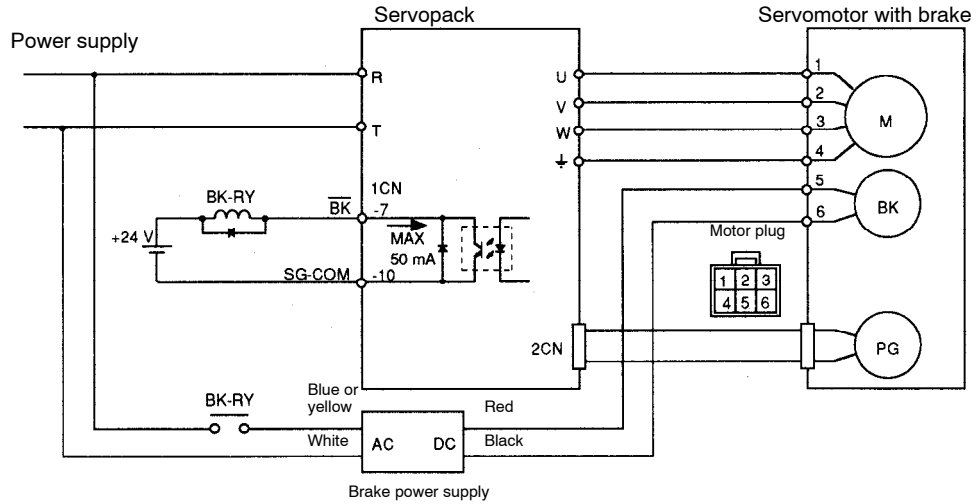

BK-RY: Brake control relay

Brake power supply has two types (200 V, 100 V).

Output → BK 1CN-7	Brake Interlock Output	For Speed/Torque Control and Position Control
--------------------------	------------------------	---

This output signal controls the brake when a motor with brake is used. This signal terminal need not be connected when a motor without brake is used.

Related User Constants

Cn-12	Time delay from brake signal until servo OFF
Cn-15	Speed level for brake signal output during operation
Cn-16	Output timing of brake signal during motor operation

<p>ON Status: Circuit between 1CN-7 and 1CN-10 is closed. 1CN-7 is at low level.</p>	Releases the brake.
<p>OFF Status: Circuit between 1CN-7 and 1CN-10 is open. 1CN-7 is at high level.</p>	Applies the brake.

Output → SG-COM 1CN-10	Output Signal Ground	For Speed/Torque Control and Position Control
	Common	

This is a signal ground for the output signals shown below. Connect this signal terminal to 0 V on the external power supply.

Contact Output Signals: $\overline{\text{BK}}$ (1CN-7)
 $\overline{\text{V-CMP}}$ (1CN-8) (for speed/torque control only)
 $\overline{\text{COIN}}$ (1CN-8) (for position control only)
 $\overline{\text{TGON}}$ (1CN-9)

- 3) If the machine moves slightly due to gravity when the brake is applied, set the following user constant to adjust brake ON timing:

Cn-12	BRKTIM	Time delay from the time a brake signal is output until servo OFF status occurs	Unit: 10 ms	Setting Range: 0 to 50	Factory Setting: 0	For Speed/Torque Control and Position Control
--------------	--------	---	----------------	---------------------------	-----------------------	---

This user constant is used to set output timing of brake control signal BK (1CN-7) and servo OFF operation (motor output stop) when SGM/SGMP Servomotor with brake is used.

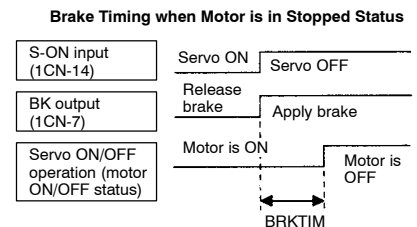

With the standard setting, the servo is turned OFF when BK signal (brake operation) is output. The machine may move slightly due to gravitation. This movement depends on machine configuration and brake characteristics. If this happens, use this user constant to delay servo OFF timing to prevent the machine from moving.

Set in this constant the brake ON timing used when the motor is in stopped status.

For brake ON timing during motor operation, use Cn-15 and Cn-16.

- 4) Set the following user constants to adjust brake ON timing so that holding brake is applied when the motor stops.

Cn-15	BRKSPD	Speed Level at which Brake Signal Is Output during Motor Operation	Unit: r/min	Setting Range: 0 to Maximum Speed	Factory Setting: 100	For Speed/Torque Control and Position Control
Cn-16	BRKWAI	Output Timing of Brake Signal during Motor Operation	Unit: 10 ms	Setting Range: 10 to 100	Factory Setting: 50	For Speed/Torque Control and Position Control

Cn-15 and Cn-16 are used for SGM/SGMP Servomotors with brake. Use these user constants to set brake timing used when the servo is turned OFF by input signal S-ON (1CN-14) or alarm occurrence during motor rotation.

Brakes for SGM/SGMP Servomotors are designed as holding brakes. Therefore, brake ON timing when the motor stops must be appropriate. Adjust the user constant settings while observing machine operation.

Brake Timing when Motor is in Stopped Status

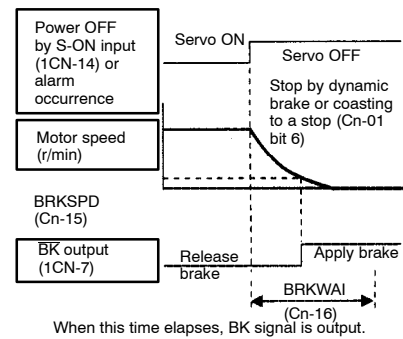

- Conditions for BK signal (1CN-7) output during motor operation. The circuit between 1CN-7 and 1CN-10 is opened in either of the following situations.

1	Motor speed drops below the value set in Cn-15 (BRKSPD) after servo OFF occurs.
2	The time set in Cn-16 (BRKWAI) has elapsed since servo OFF occurred.

3

3.5 Running the Motor Smoothly

This section explains how to run the servomotor smoothly.

3.5.1	Using the Soft Start Function	111
3.5.2	Using the Smoothing Function	112
3.5.3	Adjusting Gain	112
3.5.4	Adjusting Offset	113
3.5.5	Setting the Torque Reference Filter Time Constant	113

3.5.1 Using the Soft Start Function

- The soft start function adjusts progressive speed reference input inside the Servopack so that acceleration and deceleration can be as constant as possible. To use this function, set the following user constants.

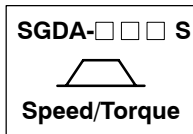

Cn-07	SFSACC Soft Start Time (Acceleration)	Unit: ms	Setting Range: 0 to 10000	Factory Setting: 0	For Speed/Torque Control Only
Cn-23	SFSDEC Soft Start Time (Deceleration)	Unit: ms	Setting Range: 0 to 10000	Factory Setting: 0	For Speed/Torque Control Only

In the Servopack, a speed reference is multiplied by the acceleration or deceleration value set in Cn-07 or Cn-23 to provide speed control.

Smooth speed control can be achieved when progressive speed references are input or when contact input speed control is used.

Set these user constants as follows.

Cn-07: Time interval from the time the motor starts until the maximum speed (4500 r/min) is reached

Cn-23: Time interval from the time the motor is running at the maximum speed (4500 r/min) until it stops

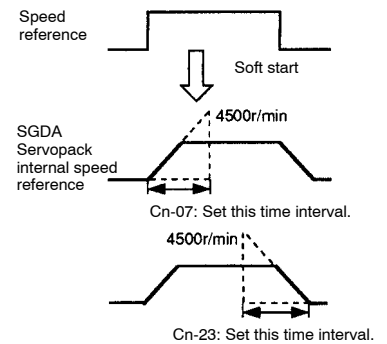

3.5.2 Using the Smoothing Function

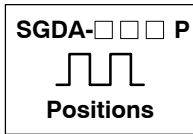

- 1) The smoothing function adjusts constant-frequency reference input inside the Servopack so that acceleration and deceleration can be as constant as possible. To use this function, set the following user constant.

Cn-26	ACCTME	Position Reference Acceleration/Deceleration Time Constant (Smoothing)	Unit: 0.1 ms	Setting Range: 0 to 640	Factory Setting: 0	For Position Control Only
--------------	--------	--	--------------	-------------------------	--------------------	---------------------------

This user constant is used for position control (SGDA-□□□P) only.

This function performs acceleration/deceleration processing for input reference pulses (primary lag characteristics).

This function prevents the motor from running at progressive speeds in the following cases:

- When the host controller which outputs references cannot perform acceleration/deceleration processing
- When reference pulse frequency is too low
- When reference electronic gear ratio is too high (more than 10 times)

This function does not change the travel distance (number of pulses).

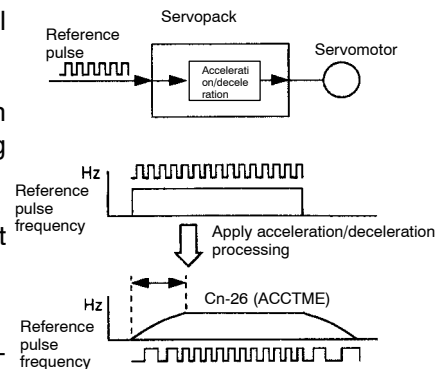

3.5.3 Adjusting Gain

- 1) If speed loop gain or position loop gain exceeds the allowable limit for the servo system including the machine to be controlled, the system will vibrate or become too susceptible. Under such conditions, smooth operation cannot be expected. Reduce each loop gain value to an appropriate value.
- 2) For servo gain adjustment, refer to the following section:

3.6.2 Setting Servo Gain

3.5.4 Adjusting Offset

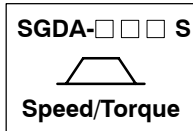

- 1) If reference voltage from the host controller or external circuit has an offset in the vicinity of 0 V, smooth operation cannot be expected. Adjust the reference offset to 0 V.

When Reference Voltage from Host Controller or External Circuit has an Offset

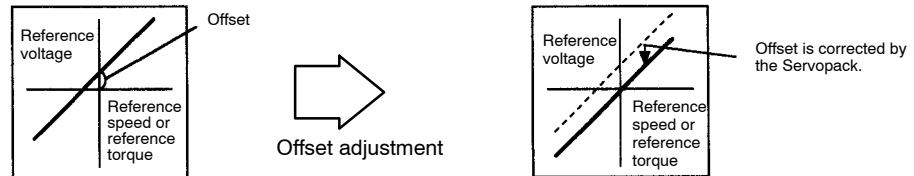

- 2) The following two methods are available to adjust the reference offset to 0 V.

1) Automatic adjustment of reference offset	Reference offset is automatically adjusted.
2) Manual adjustment of reference offset	Reference offset can be intentionally set to a specified value.

NOTE If a position control loop is formed in the host controller, do not use automatic adjustment in 1). Always use manual adjustment in 2).

- 3) For detailed adjustment procedures, refer to the following sections:

	Adjustment Method
1) Automatic adjustment of reference offset	4.2.4 Reference Offset Automatic Adjustment
2) Manual adjustment of reference offset	4.2.5 Speed Reference Offset Manual Adjustment Mode

3.5.5 Setting the Torque Reference Filter Time Constant

- 1) If the machine causes vibration, possibly resulting from the servo drive, adjust the following filter time constant. Vibration may stop.

Cn-17	TRQFIL Torque Reference Filter Time Constant	Unit: 100 μ s	Setting Range: 0 to 250	Factory Setting: 4	For Speed/Torque Control and Position Control
--------------	--	----------------------	-------------------------------	--------------------------	---

Cn-17 is a torque reference filter time constant for the SGDA Servopack. The smaller the value, the higher the torque control response. There is, however, a certain limit depending on machine conditions.

With the standard setting, the machine may cause vibration resulting from the servo drive. In this case, increase the constant setting. Vibration may stop. Vibration can be caused by incorrect gain adjustment, machine problems and so on.

3.6 Minimizing Positioning Time

■ This section describes how to minimize positioning time.

3.6.1	Using Autotuning Function	114
3.6.2	Setting Servo Gain	114
3.6.3	Using Feed-forward Control	116
3.6.4	Using Proportional Control	116
3.6.5	Setting Speed Bias	117
3.6.6	Using Mode Switch	118
3.6.7	Using Speed Loop Compensation Function	124

3

3.6.1 Using Autotuning Function

- 1) If speed loop gain and position loop gain for the servo system are not set properly, positioning may become slow. Techniques and experience are required to set these servo gain values according to machine configuration and machine rigidity.
- 2) Σ -series Servopacks have an autotuning function that automatically measures machine characteristics and sets the necessary servo gain values. With this function, even first-time servo users can easily perform tuning for servo gain. Servo gain values are set in user constants.
- 3) The following user constants can be automatically set by the autotuning function.

User Constant	Meaning
Cn-04	Speed loop gain
Cn-05	Speed loop integration time constant
Cn-1A	Position loop gain

- 4) For details of how to perform autotuning, refer to *4.2.3 Autotuning*

3.6.2 Setting Servo Gain

- 1) Check and reset the servo gain when:
 - a) Automatically set servo gain values need to be checked after autotuning.
 - b) Each servo gain value checked in a) is to be directly set for another Servopack.
 - c) Response performance needs to be further enhanced after autotuning, or servo gain values need to be reset for a system with lower response performance.

2) Set the following user constants related to speed loop as necessary.

Cn-04	LOOPHZ Speed Loop Gain (Kv)	Unit: Hz	Setting Range: 1 to 2000	Factory Setting: 80	For Speed/Torque Control and Position Control
Cn-05	PITIME Speed Loop Integration Time Constant (Ti)	Unit: ms	Setting Range: 2 to 10000	Factory Setting: 20	For Speed/Torque Control and Position Control

Cn-04 and Cn-05 are a speed loop gain and an integration time constant for the Servopack, respectively.

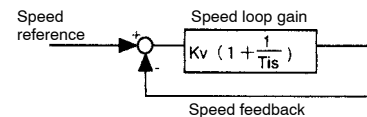

The higher the speed loop gain value or the smaller the speed loop integration time constant value, the higher the speed control response. There is, however, a certain limit depending on machine characteristics.

These user constants are automatically set by the autotuning function.

The unit of speed loop integration time constant Cn-05 (Ti) can be changed to 0.01 ms.

3) Set the following user constants related to position loop as necessary.

Cn-1A	POSGN Position Loop Gain (Kp)	Unit: 1/s	Setting Range: 1 to 200	Factory Setting: 40	For Speed/Torque Control and Position Control
--------------	----------------------------------	--------------	-------------------------------	---------------------------	---

This user constant is a position loop gain for the Servopack.

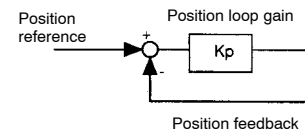

Increasing the position loop gain value provides position control with higher response and less error. However, there is a certain limit depending on machine characteristics.

This user constant is automatically set by the autotuning function.

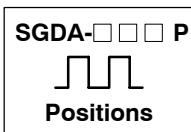

Cn-1E	OVERLV Overflow	Unit: 256 References	Setting Range: 1 to 65536	Factory Setting: 1024	For Position Control Only
--------------	--------------------	-------------------------	---------------------------------	-----------------------------	------------------------------

This user constant is for position control (SGDA-□□□P) only.

Set in this user constant the error pulse level at which a position error pulse overflow alarm (alarm A.31) is detected.

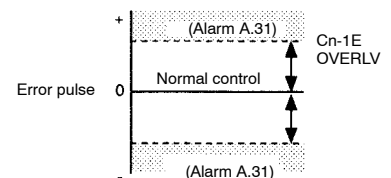

If the machine permits only a small position loop gain value to be set in Cn-1A, an overflow alarm may arise during high-speed operation. In this case, increase the value set in this user constant to suppress alarm detection.

3.6.3 Using Feed-forward Control

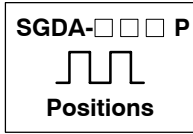

Feed-forward control shortens positioning time. To use **feed-forward control**, set the following user constant.

Cn-1D	FFGN Feed-forward Gain	Unit: %	Setting Range: 0 to 100	Factory Setting: 0	For Position Control Only
--------------	---------------------------	------------	-------------------------------	-----------------------	------------------------------

This user constant is for position control (SGDA-□□□P) only.

This user constant is set to apply feed-forward frequency compensation to position control inside the Servopack.

Use this user constant to shorten positioning time. Too high a value may cause the machine to vibrate. For ordinary machines, set 80% or less in this constant.

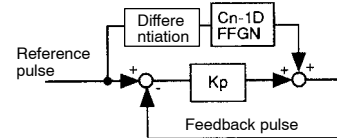

3.6.4 Using Proportional Control

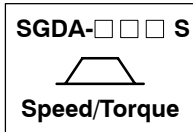

1) If both bits A and B of memory switch Cn-01 are set to 0 as shown below, input signal $\overline{P-CON}$ serves as a PI/P control changeover switch.

- PI Control: Proportional/Integral control
- P Control: Proportional control

Cn-01 Bit A	Control Mode Selection	Factory Setting: 0	For Speed/Torque Control Only
Cn-01Bit B	Control Mode Selection	Factory Setting: 0	For Speed/Torque Control Only



Feed-forward control

Control for making necessary corrections beforehand to prevent the control system from receiving the effects of disturbance. Using feed-forward control increases effective servo gain, enhancing response performance.

For speed/torque control (SGDA-□□□S) only.

Cn-01 Setting		Control Mode					
Bit B	Bit A						
0	0	<p>Speed Control This is normal speed control.</p> <ul style="list-style-type: none"> Speed reference is input from V-REF (1CN-3). Signal P-CON (1CN-15) is used to switch between P control and PI control. <table border="1"> <tr> <td>P-CON (1CN-15) is open (OFF)</td> <td>PI control</td> </tr> <tr> <td>P-CON (1CN-15) is closed (ON)</td> <td>P control</td> </tr> </table> <ul style="list-style-type: none"> Torque reference input T-REF (1CN-1) cannot be used. 	P-CON (1CN-15) is open (OFF)	PI control	P-CON (1CN-15) is closed (ON)	P control	
P-CON (1CN-15) is open (OFF)	PI control						
P-CON (1CN-15) is closed (ON)	P control						

2) Proportional control can be used in the following two ways.

- a) When operation is performed by sending speed references from the host controller to the Servopack, the host controller can selectively use P control mode for particular conditions only. This method can prevent the occurrence of overshoot and also shorten settling time. For particular conditions, refer to 3.6.6 Using Mode Switch.
- b) If PI control mode is used when the speed reference has a reference offset, the motor may rotate at a very slow speed and fail to stop even if 0 is specified as a speed reference. In this case, use P control mode to stop the motor.

3.6.5 Setting Speed Bias

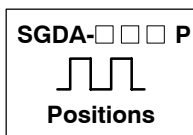

The settling time for positioning can be reduced by assigning bias to the speed reference output part in the Servopack. To assign bias, use the following constant.

Cn-1C	BIASLV Bias	Unit: r/min	Setting Range: 0 to 450	Factory Setting: 0	For Position Control Only
-------	-------------	-------------	-------------------------	--------------------	---------------------------

This user constant is for position control (SGDA-□□□P) only.

This user constant is set to assign an offset to a speed reference in the SGDA Servopack.

Use this constant to shorten settling time.

Set this user constant according to machine conditions.

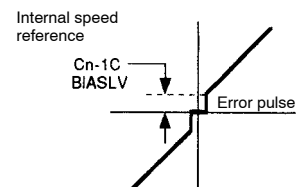

3.6.6 Using Mode Switch

- 1) Use the mode switch for the following purposes:
 - a) To prevent overshoot during acceleration or deceleration (for speed control).
 - b) To prevent undershoot during positioning in order to reduce settling time (for position control).

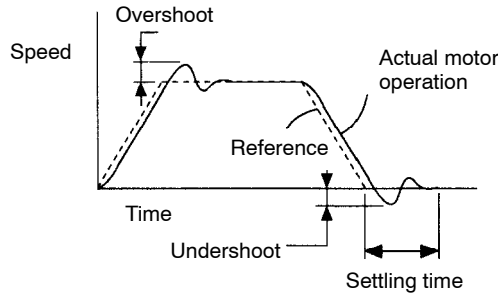

- 2) In other words, the mode switch is a function that automatically switches the speed control mode inside the Servopack **from PI control to P control** while certain conditions are being established.

NOTE The mode switch is used to fully utilize performance of a servo drive to achieve very high-speed positioning. The speed response waveform must be observed to adjust the mode switch. For normal use, the speed loop gain and position loop gain set by autotuning provide sufficient speed/position control. Even if overshoot or undershoot occurs, they can be suppressed by setting the acceleration/deceleration time constant for the host controller, the soft start time constants (Cn-07, Cn-23), or smoothing time constant (Cn-26) for the Servopack.



From PI control to P control

PI control means proportional/integral control and P control means proportional control. In short, switching “from PI control to P control” reduces effective servo gain, making the servo system more stable.

3) Servopacks can use four types of mode switches (1 to 4). To select a mode switch, use the following memory switch. Note that the mode switch setting methods for speed/torque control and position control are slightly different.

For Speed/Torque Control (SGDA-□□□S)		For Position Control (SGDA-□□□P)			Mode Switch Setting	User Constant	Unit
Memory Switch Cn-01		Memory Switch Cn-01					
Bit D	Bit C	Bit D	Bit C	Bit B			
1	1	-	-	1	Does not use mode switch.	/	/
0	0	0	0	0	Uses torque reference as a detection point. (Standard setting)	Cn-0C	Percentage of rated torque: %
0	1	0	1	0	Uses speed reference as a detection point.	Cn-0D	Motor speed: r/min
1	0	1	0	0	Uses acceleration reference as a detection point.	Cn-0E	Acceleration reference inside the Servopack: 10 (r/min)/s
/	/	1	1	0	Uses error pulse as a detection point.	Cn-0F	Reference unit

3

When Torque Reference Is Used as a Detection Point of Mode Switch (Standard Setting)

If a torque reference exceeds the torque value set in user constant Cn-0C, the speed loop switches to P control.

The SGDA Servopack is factory set to this standard mode (Cn-0C = 200).

Example of Use:

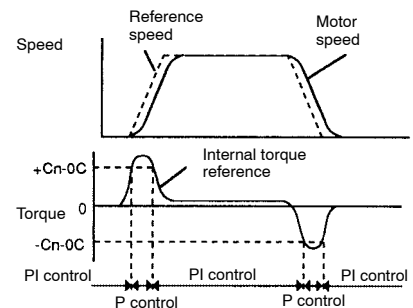

If a mode switch is not used and PI control is always performed, torque may enter a saturation state during acceleration or deceleration, causing the motor speed to have overshoot or undershoot.

Using the mode switch suppresses torque saturation and prevents the motor speed from having overshoot and undershoot.

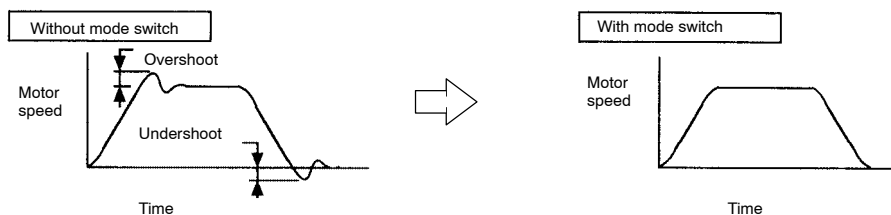

When Speed Reference Is Used as a Detection Point of Mode Switch

If a speed reference exceeds the value set in user constant Cn-0D, the speed loop switches to P control.

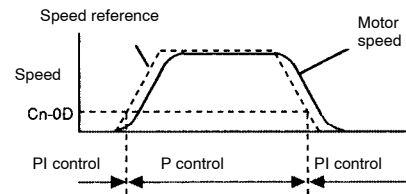

Example of Use:

The mode switch is used to reduce settling time.

Generally, speed loop gain must be increased to reduce settling time. Using the mode switch suppresses the occurrence of overshoot and undershoot when speed loop gain is increased.

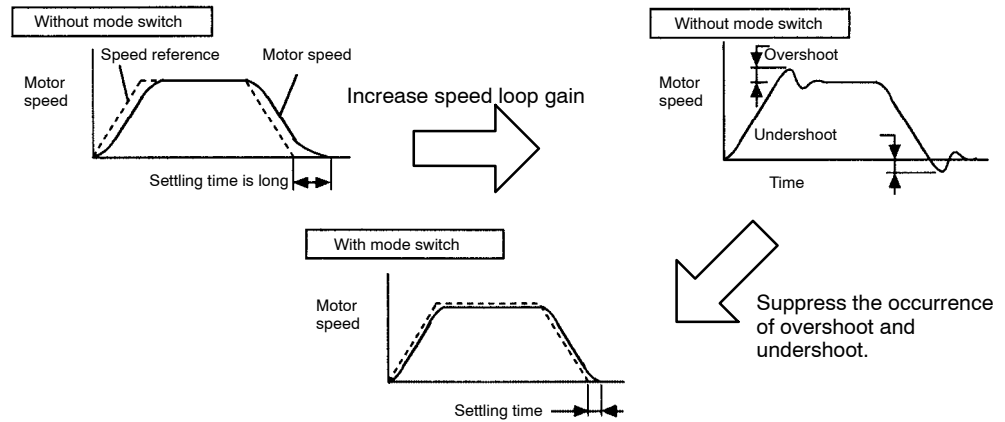

When Acceleration Is Used as a Detection Point of Mode Switch

(Standard Setting)

If motor acceleration exceeds the value set in user constant Cn-0E, the speed loop switches to P control.

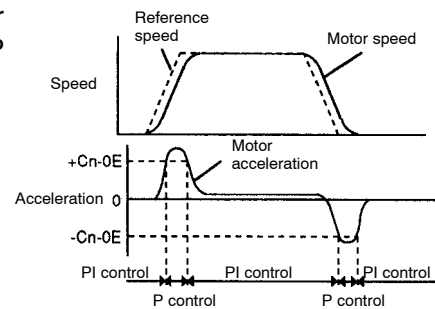

Example of Use:

If a mode switch is not used and PI control is always performed, torque may enter a saturation state during acceleration or deceleration, causing the motor speed to have overshoot or undershoot.

Using the mode switch suppresses torque saturation and prevents the motor speed from having overshoot and undershoot.

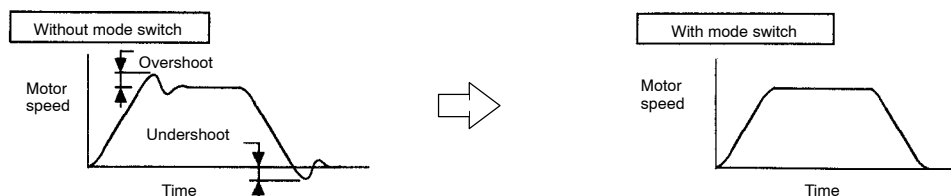

3

When Error Pulse Is Used as a Detection Point of Mode Switch

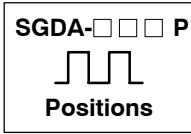

For position control (SGDA-□□□P) only.

If an error pulse exceeds the value set in user constant Cn-0F, the speed loop switches to P control.

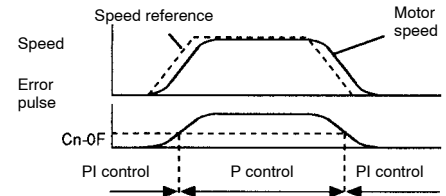

Example of Use:

The mode switch is used to reduce settling time. Generally, speed loop gain must be increased to reduce settling time. Using the mode switch suppresses the occurrence of overshoot and undershoot when speed loop gain is increased.

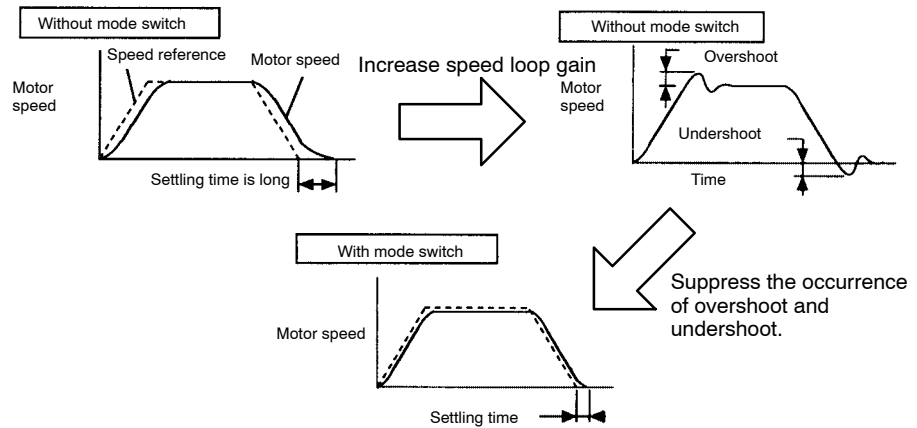

4) The user constants required to set each mode switch are summarized as follows.

Cn-01Bit B	Mode Switch ON/OFF	Factory Setting: 0	For Position Control Only
-------------------	--------------------	--------------------	---------------------------

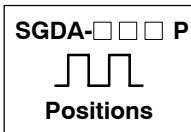

For position control (SGDA-□□□P) only.

This user constant is used to enable or disable the mode switch function.

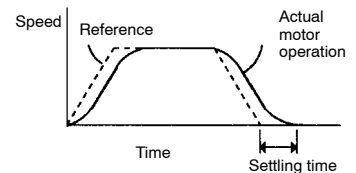

Setting	Meaning
0	Uses the mode switch function
1	Does not use the mode switch function

Mode switch is used to reduce settling time and suppress undershoot when the motor stops. It switches PI control to P control when certain conditions are met.

The Servopack allows use of four different types of mode switch. To select a mode switch, set bits C and D of memory switch Cn-01. For speed/torque control (SGDA-□□□S), bits C and D are used to enable or disable the mode switch function.

APPLICATIONS OF Σ -SERIES PRODUCTS

3.6.6 Σ Mode Switch cont.

Cn-01 Bit C	Mode Switch Selection	Factory Setting: 0	For Speed/Torque Control and Position Control
Cn-01 Bit D	Mode Switch Selection	Factory Setting: 0	For Speed/Torque Control and Position Control

Use the following user constants to set the mode switch to be used.

Memory Switch Cn-01		Mode Switch Type		User Constant for Setting Detection Point
Bit D	Bit C			
0	0	Uses torque reference as a detection point.		Cn-0C
0	1	Uses speed reference as a detection point.		Cn-0D
1	0	Uses acceleration reference as a detection point.		Cn-0E
1	1	For speed/torque control	Does not use mode switch.	/
		For position control	Uses error pulse as a detection point.	

Mode switch is used to reduce settling time and suppress undershoot when the motor stops. It switches PI control to P control when certain conditions are met.

Cn-0C	TRQMSW	Mode Switch (Torque Reference)	Unit: %	Setting Range: 0 to Maximum Torque	Factory Setting: 200	For Speed/Torque Control and Position Control
Cn-0D	REFMSW	Mode Switch (Speed Reference)	Unit: r/min	Setting Range: 0 to Maximum Speed	Factory Setting: 0	For Speed/Torque Control and Position Control
Cn-0E	ACCMSW	Mode Switch (Acceleration Reference)	Unit: 10 (r/min)/s	Setting Range: 0 to 3000	Factory Setting: 0	For Speed/Torque Control and Position Control
Cn-0F	ERPMSW	Mode Switch (Error Pulse)	Unit: Reference Unit	Setting Range: 0 to 10000	Factory Setting: 10000	For Position Control Only

Mode switch is used to reduce settling time and suppress undershoot when the motor stops. It switches PI control to P control when certain conditions are met.

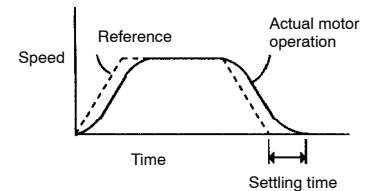

The Servopack allows use of four different types of mode switch. To select a mode switch, set bits B, C and D of memory switch Cn-01.

Memory Switch Cn-01			Mode Switch Setting	User Constant	Unit
Bit D	Bit C	Bit B			
-	-	1	Does not use mode switch.		
0	0	0	Uses torque reference as a detection point.	Cn-0C	Percentage of rated torque: %
0	1	0	Uses speed reference as a detection point.	Cn-0D	Motor speed: r/min
1	0	0	Uses acceleration reference as a detection point.	Cn-0E	Acceleration reference inside the SGD Servopack: 10 (r/min)/s
1	1	0	Uses error pulse as a detection point.	Cn-0F	Reference unit

User constant Cn-0F is for position control (SGDA-□□□P) only. For speed/torque control (SGDA-□□□S), Cn-0F is used to set a zero-clamp level.

3.6.7 Using Speed Loop Compensation Function

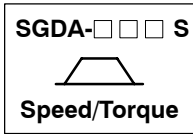

1) This function compensates for the phase-delay generated by the digital control speed detection. For this function, use the following constant.

Cn-28	NDBCC Speed Loop Compensation Constant	Unit: —	Setting Range: 0 to 100	Factory Setting: 0	For Speed/Torque Control Only
--------------	--	---------	-------------------------	--------------------	-------------------------------

First, adjust the servo (position/speed loop gain, speed loop, integration time constant, torque reference filter) appropriately in the “Cn-28 = 0” status.

Then, gradually increase the set value of Cn-28 from 0, find the proper value at which noise and oscillation are minimal.

Note Use the speed loop compensation function (set value of Cn-28 is other than 0) under the following status:

- No servo system oscillation
- No abnormal noise from the machine

Even if the speed loop compensation function is used, it may bring little effect or even increase the oscillation. In these cases, stop using the speed loop compensation function. (Set the value of Cn-28 to 0, again.)

2) Speed loop compensation function can be illustrated by the following block diagram:

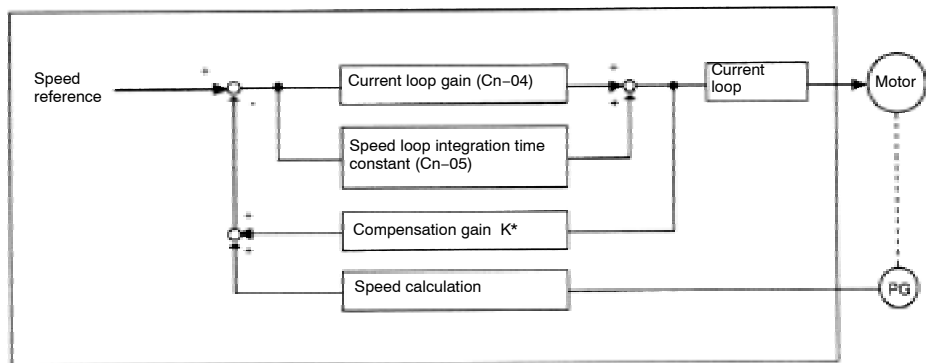

* Compensation gain (K) is in proportion to the compensation constant (user constant Cn-28). Cn-28 = 0 shows no compensation status.

3.7 Forming a Protective Sequence

This section describes how to use I/O signals from the Servopack to form a protective sequence for safety purposes.

3.7.1	Using Servo Alarm Output and Alarm Code Output	125
3.7.2	Using Servo ON Input Signal	128
3.7.3	Using Positioning Complete Signal	129
3.7.4	Using Speed Coincidence Output Signal	131
3.7.5	Using Running Output Signal	132
3.7.6	Handling of Power Loss	134

3.7.1 Using Servo Alarm Output and Alarm Code Output

1) Basic Wiring for Alarm Output Signals

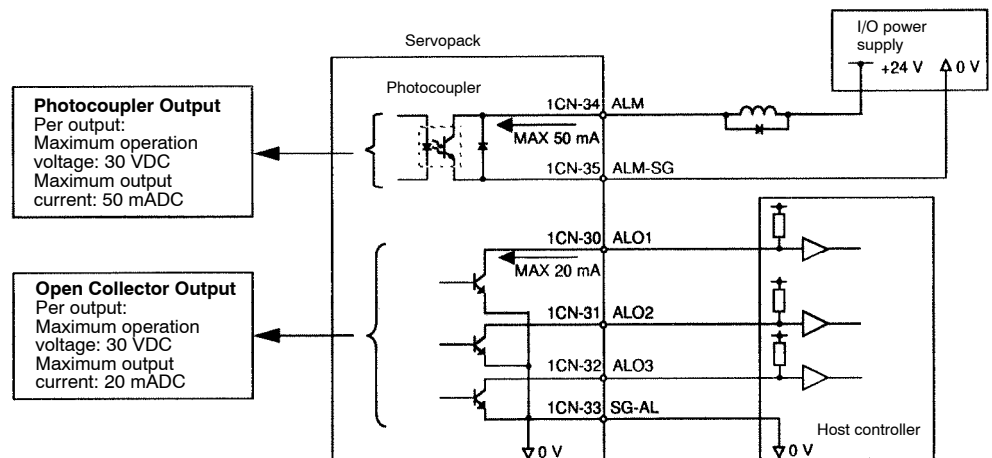

Provide an external I/O power supply separately. There are no DC power available from Servopack for output signals.

2) Contact Output Signal ALM

Output → ALM 1CN-34	Servo Alarm Output	For Speed Torque Control and Position Control
Output → ALM-SG 1CN-35	Signal Ground for Servo Alarm Output	For Speed Torque Control and Position Control

Signal ALM is output when the Servopack detects an alarm.

Form an external circuit so that this alarm output (ALM) turns the Servopack OFF.

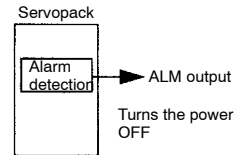

ON status:	Circuit between 1CN-34 and 1CN-35 is closed. 1CN-34 is at low level.	Normal state
OFF status:	Circuit between 1CN-34 and 1CN-35 is open. 1CN-34 is at high level.	Alarm state

Alarm codes ALO1, ALO2, and ALO3 are output to indicate each alarm type.

3) Contact Output Signals ALO1, ALO2, and ALO3

Output → ALO1 1CN-30	Alarm Code Output	For Speed/Torque Control and Position Control
Output → ALO2 1CN-31	Alarm Code Output	For Speed/Torque Control and Position Control
Output → ALO3 1CN-32	Alarm Code Output	For Speed/Torque Control and Position Control
Output → SG-AL 1CN-33	Signal Ground for Alarm Code Output	For Speed/Torque Control and Position Control

These signals output an alarm code to indicate the type of alarm detected by the Servopack.

Use these signals to display alarm codes at the host controller.

NOTE Using Alarm Codes:

When an alarm is detected, alarm output (ALM) causes the external circuit to turn the SGDA Servopack OFF. The alarm code remains output for at least 100 ms. For this reason, the host controller must read the alarm code within 100 ms of the alarm occurrence. When an alarm signal is output, be sure to identify the cause of the problem, take corrective action and operate again. For trouble shooting problems and procedures, refer to 6.2 Troubleshooting.

3

4) Relationship between Alarm Display and Alarm Code Output

Alarm Display and Alarm Code Output:

Alarm Display	Alarm Code Output			Servo Alarm (ALM) Output	Alarm Type	Alarm Description
	ALO1	ALO2	ALO3			
R0*	×	×	×	×	User constant error	An absolute encoder error occurred or user constant is faulty.
R10	○	×	×	×	Overcurrent	Overcurrent flowed through the main circuit. Servopack overheated.
R31	○	○	×	×	Position error pulse overflow	The number of pulses in error counter has exceeded the preset value.
R40	×	×	○	×	Overvoltage	Main circuit DC voltage has exceeded approximately 420 V.
R51	○	×	○	×	Overspeed	Motor speed has exceeded the maximum allowable speed.
R70	○	○	○	×	Overload	Motor and Servopack are overloaded.
RE*	○	×	○	×	Overrun Disconnection of PG signal line	Overrun occurred due to motor or encoder signal wiring faults. Encoder signal line is disconnected.
R8*	×	×	×	×	Absolute encoder error	Absolute encoder is faulty.
RF3	×	○	×	×	Power loss alarm	After power was turned OFF, power was turned ON again within power holding time. Power loss occurred during operation.
CPFD0	Undefined				Digital Operator transmission error	Communication error occurred between Digital Operator and Servopack.
CPFD1						
R99	×	×	×	○	No error	

○ : Output transistor is ON

× : Output transistor is OFF

* : Displays an alarm category number.

For details, refer to *Appendix E List of Alarm Displays*.

- When the servo alarm (ALM) is output, eliminate the cause of the alarm and set the following $\overline{\text{ALMRST}}$ input signal at high level (+24 V) to reset the alarm state.

→ Input $\overline{\text{ALMRST}}$ 1CN-18	Alarm Reset	For Speed/Torque Control and Position Control
---	-------------	---

This signal is used to reset the servo alarm state.

Normally, this signal terminal need not be wired. This is because an external circuit is normally formed so that servo power is turned OFF when servo alarm is output. Alarm state is automatically reset when servo power is turned ON next time.

Alarm state can be reset using the Digital Operator.

When an alarm occurs, always eliminate the cause before resetting the alarm state. 6.2.1 *Troubleshooting Problems with Alarm Display* describes how to troubleshoot the system when an alarm arises.

3

3.7.2 Using Servo ON Input Signal

- This section describes how to wire and use contact input signal “servo ON ($\overline{\text{S-ON}}$).” Use this signal to forcibly turn the servomotor OFF from the host controller.

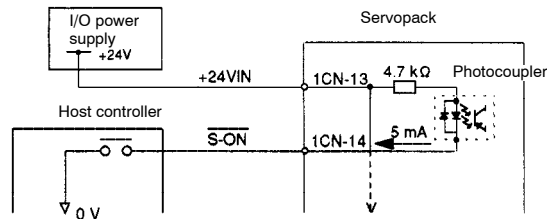

→ Input $\overline{\text{S-ON}}$ 1CN-14	Servo ON	For Speed/Torque Control and Position Control
---	----------	---

This signal is used to turn the motor ON or OFF.

ON: 1CN-14 is at low level	Turns the motor ON. This is normal operation state (called “servo ON state”).
OFF: 1CN-14 is at high level	Turns the motor OFF. This is inoperable state (called “servo OFF state”). If the servo is turned OFF during motor operation, the motor is decelerated to a stop by applying dynamic brake (standard setting). This function can be selected by setting bits 6 and 7 of memory switch Cn-01.

Servo ON

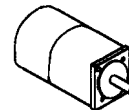

Motor is ON

Motor is operated according to input signals.

Servo OFF

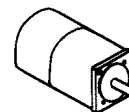

Motor is OFF

Motor cannot run.

NOTE Do not use the $\overline{S-ON}$ signal to start or stop the motor. Always use an input reference to start and stop the motor.

2) If the $\overline{S-ON}$ signal is not to be used, set the following memory switch to 1:

Cn-01 Bit 0	Use of Servo ON Input Signal	Factory Setting: 0	For Speed/Torque Control and Position Control
--------------------	------------------------------	--------------------	---

This memory switch is used to enable or disable the servo ON input signal $\overline{S-ON}$ (1CN-14).

When external short-circuit wiring is omitted, set the memory switch to "1."

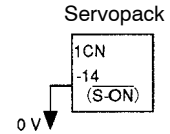

When S-ON is not used, this short-circuit wiring can be omitted.

Setting	Meaning
0	Uses servo ON signal $\overline{S-ON}$. (When 1CN-14 is open, servo is OFF. When 1CN-14 is at 0 V, servo is ON.)
1	Does not use servo ON signal $\overline{S-ON}$.

3

3.7.3 Using Positioning Complete Signal

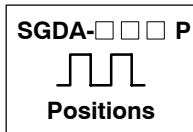

1) This section describes how to wire and use contact output-signal "positioning complete output (\overline{COIN}).” This signal is output to indicate that servomotor operation is complete.

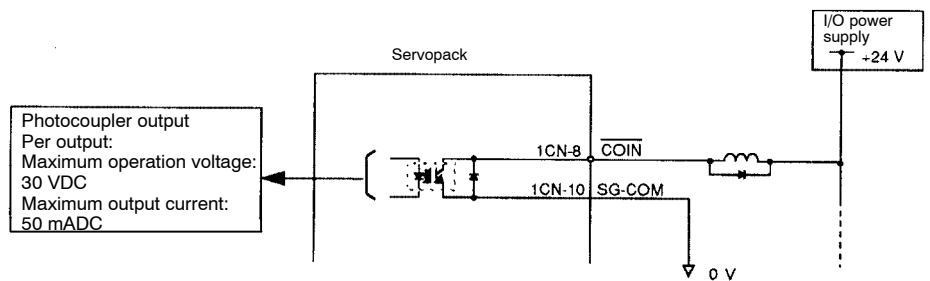

Output → COIN 1CN-8	Positioning Complete Output	For Position Control Only
----------------------------	-----------------------------	---------------------------

For position control (SGDA-□□□P) only.

This output signal indicates that motor operation is complete during position control. The host controller uses this signal as an interlock to confirm that positioning is complete.

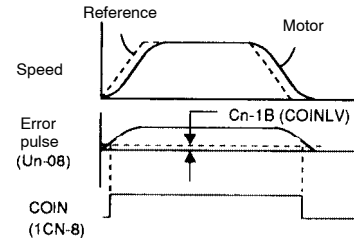

ON status:	Circuit between 1CN-8 and 1CN-10 is closed. 1CN-8 is at low level.	Positioning is complete (position error is below the preset value).
OFF status:	Circuit between 1CN-8 and 1CN-10 is open. 1CN-8 is at high level.	Positioning is not complete (position error is over the preset value).

Preset Value: Cn-1B (positioning complete range)

- Set the number of error pulses in the following user constant to adjust output timing of COIN (positioning complete output).

Cn-1B	COINLV	Positioning Complete Range	Unit: Reference Unit	Setting Range: 0 to 250	Factory Setting: 1	For Position Control Only
--------------	--------	----------------------------	----------------------	-------------------------	--------------------	---------------------------

For position control (SGDA-□□□P) only.

This user constant is used to set output timing of positioning complete signal (COIN, 1CN-8) to be output when motor operation is complete after a position reference pulse has been input.

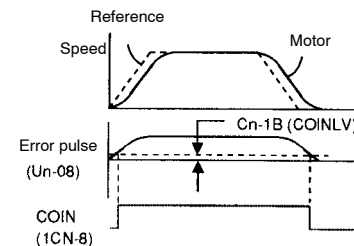

Set the number of error pulses in terms of reference unit (the number of input pulses that is defined using the electronic gear function).

If too large a value is set in this user constant, error may become too small when the motor runs at a low speed, causing COIN to be output continuously.

COINLV does not affect the final positioning accuracy.

3

3.7.4 Using Speed Coincidence Output Signal

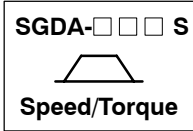

- 1) This section describes how to wire and use contact output signal “speed coincidence output ($\overline{V-CMP}$).” This signal is output to indicate that actual motor speed matches a reference speed. The host controller uses this signal as an interlock.

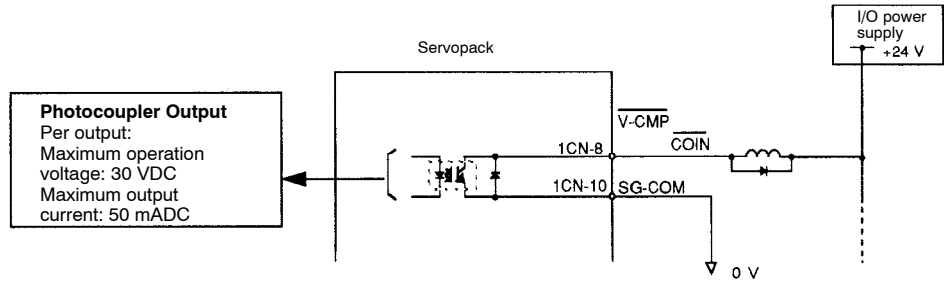

Output → $\overline{V-CMP}$ 1CN-8	Speed Coincidence Output	For Speed/Torque Control Only
---	--------------------------	-------------------------------

3

For speed/torque control (SGDA-□□□S) only.

This output signal indicates that actual motor speed matches the input speed reference during speed control.

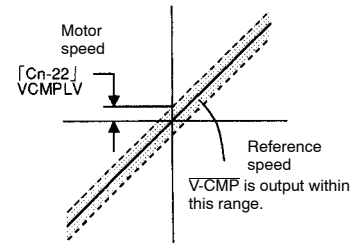

ON status:	Circuit between 1CN-8 and 1CN-10 is closed. 1CN-8 is at low level.	Actual motor speed matches the speed reference (speed difference is below the preset value).
OFF status:	Circuit between 1CN-8 and 1CN-10 is open. 1CN-8 is at high level.	Actual motor speed does not match the speed reference (speed difference is greater than the preset value).

Preset value: Cn-22 (speed coincidence signal output width)

- 2) Set the following user constant to specify the output conditions for speed coincidence signal $\overline{V-CMP}$.

Cn-22	VCMPPLV	Speed Coincidence Signal Output Width	Unit: r/min	Setting Range: 0 to 100	Factory Setting: 10	For Speed/Torque Control Only
-------	---------	---------------------------------------	-------------	-------------------------	---------------------	-------------------------------

For speed/torque control (SGDA-□□□S).

Set the output conditions for speed coincidence signal $\overline{V-CMP}$ (1CN-8).

$\overline{V-CMP}$ signal is output when the difference between the reference speed and actual motor speed is not greater than the preset value.

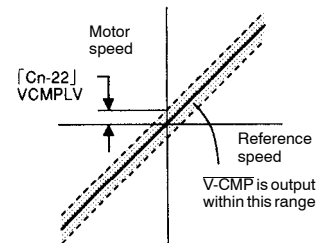

Example: When preset value is 100 and reference speed is 2000 r/min.

$\overline{\text{V-CMP}}$ is ON (circuit between 1CN-8 and 1CN-10 is closed) when the speed is between 1,900 and 2,100 r/min.

3.7.5 Using Running Output Signal

- 1) This section describes how to wire and use contact output signal $\overline{\text{TGON}}$ as a running output signal. This signal indicates that a servomotor is currently running.

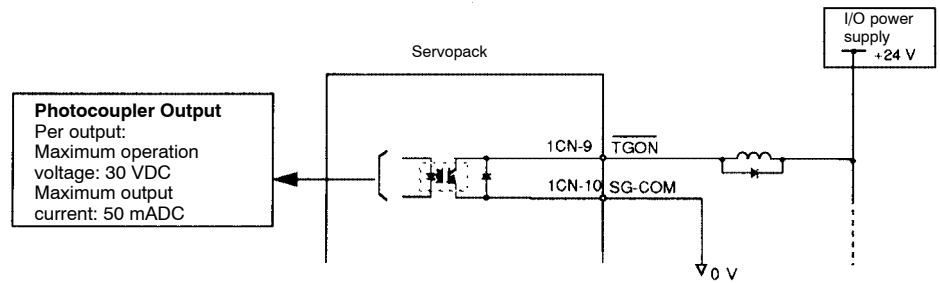

Output → $\overline{\text{TGON}}$ 1CN-9	Running Output (Torque Limit Output)	For Speed/Torque Control and Position Control
---	--------------------------------------	---

This output signal indicates that the motor is currently running.

It is used as an external interlock.

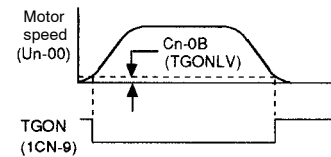

ON status:	Circuit between 1CN-9 and 1CN-10 is closed. 1CN-9 is at low level.	Motor is running. (Motor speed is greater than the preset value.)
OFF status:	Circuit between 1CN-9 and 1CN-10 is open. 1CN-9 is at high level.	Motor is stopped. (Motor speed is below the preset value.)

Preset value: Cn-0B (zero-speed level)

Note This function is changed to another function depending on the setting of bit 4 of memory switch Cn-01.

2) To use $\overline{\text{TGON}}$ as a running output signal, set the following memory switch to “0.”

Cn-01 Bit 4	TGON Output Signal Selection	Factory Setting: 0	For Speed/Torque Control and Position Control
--------------------	------------------------------	--------------------	---

This memory switch is used to set output conditions for output signal $\overline{\text{TGON}}$ (1CN-9)

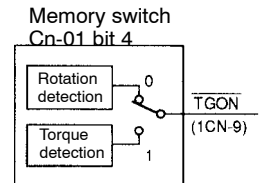

When $\overline{\text{TGON}}$ signal is changed, the following bit data are also changed:

- Status indication mode bit data
- Monitor mode Un-05 bit 4

Setting	Meaning				
0	Uses $\overline{\text{TGON}}$ as a running output signal. TGON compares motor speed with the value set in Cn-0B (TGONLV).				
	<table border="1"> <tr> <td>Motor speed \geq preset value</td> <td>Closes circuit between 1CN-9 and 1CN-10.</td> </tr> <tr> <td>Motor speed $<$ preset value</td> <td>Opens circuit between 1CN-9 and 1CN-10.</td> </tr> </table>	Motor speed \geq preset value	Closes circuit between 1CN-9 and 1CN-10.	Motor speed $<$ preset value	Opens circuit between 1CN-9 and 1CN-10.
	Motor speed \geq preset value	Closes circuit between 1CN-9 and 1CN-10.			
Motor speed $<$ preset value	Opens circuit between 1CN-9 and 1CN-10.				
1	Uses $\overline{\text{TGON}}$ as a torque limit output signal. TGON compares an internal torque (current) reference inside the SGDA Servopack with the preset value. Preset Value: Cn-08 (TLMTF) Cn-09 (TLMTR) Cn-18 (CLMIF): $\overline{\text{P-CL}}$ input only Cn-19 (CLMIR): $\overline{\text{N-CL}}$ input only				
	<table border="1"> <tr> <td>Internal torque (current) reference \geq preset value</td> <td>Closes the circuit between 1CN-9 and 1CN-10</td> </tr> <tr> <td>Internal torque (current) reference $<$ preset value</td> <td>Opens the circuit between 1CN-9 and 1CN-10</td> </tr> </table>	Internal torque (current) reference \geq preset value	Closes the circuit between 1CN-9 and 1CN-10	Internal torque (current) reference $<$ preset value	Opens the circuit between 1CN-9 and 1CN-10
	Internal torque (current) reference \geq preset value	Closes the circuit between 1CN-9 and 1CN-10			
Internal torque (current) reference $<$ preset value	Opens the circuit between 1CN-9 and 1CN-10				

3) Use the following user constant to specify the output conditions for running output signal TGON.

Cn-0B	TGONLV	Zero-Speed Level	Unit: r/min	Setting Range: 1 to Maximum Speed	Factory Setting: 20	For Speed/Torque Control and Position Control
--------------	--------	------------------	-------------	-----------------------------------	---------------------	---

This user constant is used to set the speed level at which the Servopack determines that the motor is running and then outputs a signal.

The following signals are output when motor speed exceeds the preset value. (The circuit between 1CN-9 and 1CN-10 is closed when motor speed exceeds the preset value.)

Signals are output when motor speed exceeds the preset value.

<ul style="list-style-type: none"> • TGON (1CN-9) • Status indication mode bit data • Monitor mode Un-05 bit 4
User Constant Setting: Memory switch Cn-01 bit 4 = 0

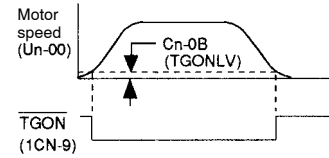

3.7.6 Handling of Power Loss

- 1) Use the following memory switch to specify whether to clear or hold a servo alarm that occurred at power loss.

Cn-01 Bit 5	Operation to Be Performed at Recovery from Power Loss	Factory Setting: 0	For Speed/Torque Control and Position Control
-------------	---	--------------------	---

If the Servopack detects instantaneous voltage drop in power supply, it outputs alarm A.F3 to prevent a hazardous situation.

Select the operation to be performed when voltage is recovered after alarm occurrence.

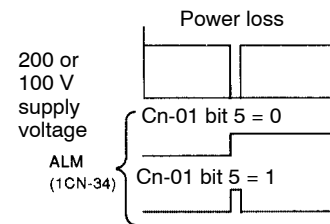

Setting	Meaning
0	Holds servo alarm even after recovery from power loss. ALM output remains OFF (circuit between 1CN-34 and 1CN-35 remains open).
1	Clears servo alarm after recovery from power loss. ALM output remains ON (circuit between 1CN-34 and 1CN-35 is closed).

- 2) If this memory switch is set to “1” (to clear servo alarm), power loss is not stored as **alarm traceback data**.



Alarm traceback data

The SGDA Servopack stores up to 10 last alarms as alarm data. This alarm data can be displayed with a Digital Operator. For details, refer to 4.2.1 Operation in Alarm Trace-back Mode.

Note Setting Bit 5 of Cn-01 to Clear Servo Alarm:

To change a user constant that is made valid by turning the Servopack OFF and then ON, always wait for at least the “power holding time” after the Servopack is turned OFF, then turn the Servopack ON. Follow the procedure below.

- a) Make sure that all indicators (LEDs) on the Digital Operator have gone OFF.
- b) Make sure that the power and alarm indicators (LEDs) on the front panel of the Servopack have gone OFF.
- c) Then, turn the power ON again.

Reason

When bit 5 of Cn-01 is set to “1” (clearing servo alarm), the Servopack will operate normally even if it is turned ON without waiting “power holding time” after being turned OFF. In this case, however, the inside of the Servopack has not yet been reset (power ON reset). Therefore, user constants that have been modified do not become valid if these constants are made valid by turning the power OFF and then ON. Although the modified (new) settings appear on the display, the old settings are still valid inside the Servopack.

3.8 Special Wiring

This section describes special wiring methods including the one for noise control. Always refer to 3.8.1 Notes on Wiring and 3.8.2 Wiring for Noise Control, and refer to other sections as necessary.

3.8.1	Wiring Instructions	136
3.8.2	Wiring for Noise Control	138
3.8.3	Using More Than One Servo Drive	143
3.8.4	Using Regenerative Units	144
3.8.5	Using an Absolute Encoder	148
3.8.6	Extending an Encoder Cable	157
3.8.7	Using SGDA Servopack with High Voltage Line	159
3.8.8	Connector Terminal Layouts	161

3

3.8.1 Wiring Instructions

To ensure safe and stable operation, always refer to the following wiring instructions.

NOTE Always use the following cables for reference input and encoder wiring.

	Cable Type	Yaskawa Drawing No.	Maximum Allowable Length
For reference input	Twisted-pair cables	DE9404859	3 m (9.8 ft.)
For encoder	Multiconductor shielded twisted-pair cable	B9400064 (for incremental encoder) DP8409123 (for absolute encoder)	20 m (65.6 ft.)

- Trim off the excess portion of the cable to minimize the cable length.

NOTE For a ground wire, use as thick a cable as possible.

- At least class 3 grounding (ground to 100 Ω or less) is recommended.
- Always use one-line grounding.
- If the motor is insulated from the machine, ground the motor directly.



NOTE Do not bend or apply tension to cables.

- Since the conductor of a signal cable is very thin (0.2 to 0.3 mm), handle it with adequate care.

NOTE Use a noise filter to prevent noise interference.
(For details, refer to the following *Caution*.)

- If the servo is to be used near private houses or may receive noise interference, install a noise filter on the input side of the power supply line. Since this Servopack is designed as an industrial device, it provides no mechanism to prevent noise interference.

Noise filter

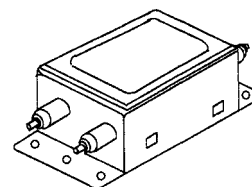

NOTE To prevent malfunction due to noise, take the following actions:

- Position the input reference device and noise filter as close to the Servopack as possible.
- Always install a surge absorber circuit in the relay, solenoid and magnetic contactor coils.
- The distance between a power line (such as a power supply line or motor cable) and a signal line must be at least 30 cm (12 in). Do not put the power and signal lines in the same duct or bundle them together.
- Do not share the power supply with an electric welder or electrical discharge machine. When the Servopack is placed near a high-frequency oscillator, install a noise filter on the input side of the power supply line.

- Note** a) Since Servopack uses high-speed switching elements, signal lines may receive noise. To prevent this, always take the above actions.
b) For details of grounding and noise filters, refer to 3.8.2 *Wiring for Noise Control*.

NOTE Use a molded-case circuit breaker (MCCB) or fuse to protect the power supply line from high voltage.

- This Servopack is directly connected to commercial power supply without a transformer. Always use an MCCB or fuse to protect the servo system from accidental high voltage.
- Select an appropriate MCCB or fuse according to the Servopack capacity and the number of Servopacks to be used as shown below.

MCCB

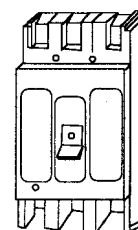

MCCB or Fuse for Each Power Capacity

Power Voltage	Servopack Type	Power Capacity Per Servopack (kVA) (see note 1)	Power Capacity Per MCCB or Fuse (A) (see note 2)
200 V	SGDA-A3A□	0.25	5
	SGDA-A5A□	0.3	
	SGDA-01A□	0.5	
	SGDA-02A□	0.75	
	SGDA-04A□	1.2	9
	SGDA-08A□	2.2	16
100 V	SGDA-A3B□	0.2	5
	SGDA-A5B□	0.3	
	SGDA-01B□	0.5	
	SGDA-02B□	0.75	8
	SGDA-03B□	1.4	15

- Note**
- 1) Power capacity at rated load
 - 2) Operating characteristics (25°C): 2 seconds or more for 200%, 0.01 second or more for 700%
 - 3) A fast-operating fuse cannot be used because the Servopack power supply is a capacitor input type. A fast-operating fuse may blow out when the power is turned ON.

3.8.2 Wiring for Noise Control

1) **Example of Wiring for Noise Control**

- a) This Servopack uses high-speed switching elements in the main circuit. It may receive “switching noise” from these high-speed switching elements if wiring or grounding around the Servopack is not appropriate. To prevent this, always wire and ground the Servopack correctly.
- b) This Servopack has a built-in microprocessor (CPU). To protect the microprocessor from external noise, install a noise filter in place.

3

c) The following is an example of wiring for noise control.

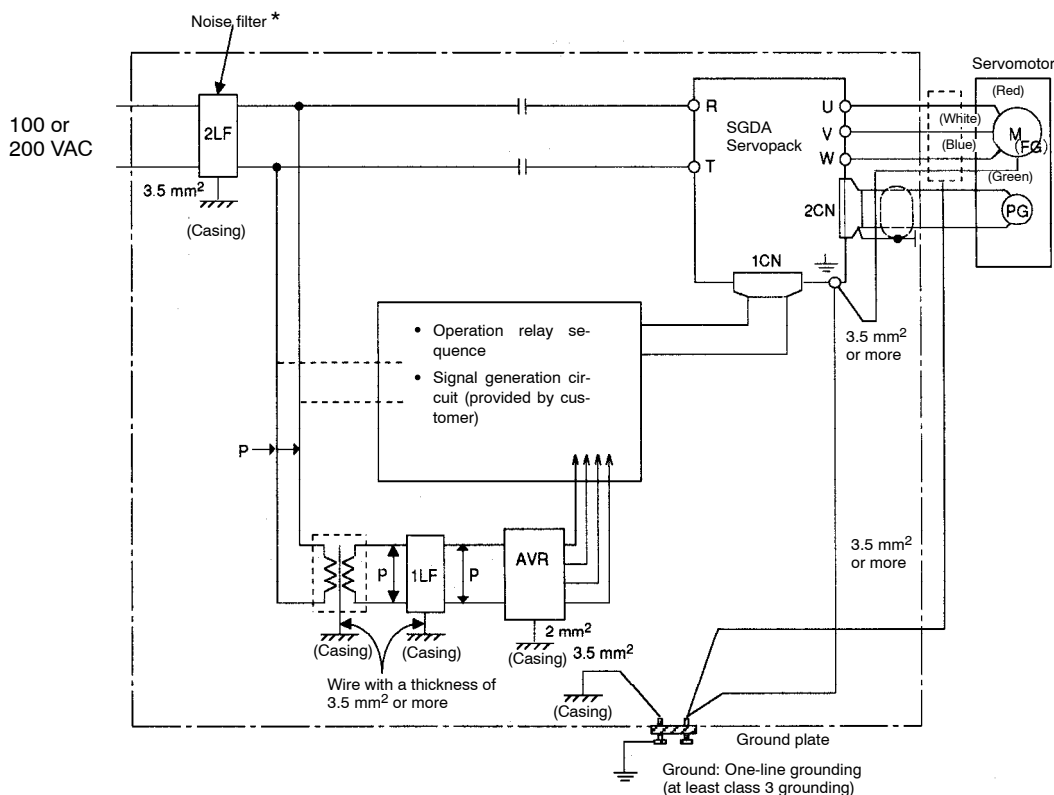

* When using a noise filter, always observe the following wiring instructions:

- Note**
- For a ground wire to be connected to the casing, use a thick wire with a thickness of at least 3.5 mm² (preferably, plain stitch cooper wire).
 - For wires indicated by P↕, use twisted-pair cables whenever possible.

2) Correct Grounding

- Always ground the motor frame.

Always connect servomotor frame terminal FG (green) to the Servopack ground terminal. Be sure to ground the ground terminal.

- If the servomotor is grounded via the machine, a switching noise current will flow from the Servopack power unit through motor stray capacitance. The above grounding is required to prevent the adverse effects of switching noise.
- If the reference input line receives noise, do the following.

Ground the 0 V line (such as SG-V and SG-T) of the reference input line. If the main circuit wiring for the motor is accommodated in a metal conduit, ground the conduit and its junction box. For all grounding, always use one-line grounding.

3) Noise Filter Installation

- a) Use an inhibit type noise filter to prevent noise from the power supply line.

Install a noise filter on the power supply line for peripheral equipment as necessary.

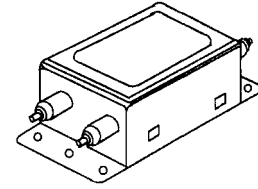

The following table lists recommended noise filters for each Servopack type.

Noise Filter Types

Power Voltage	Servopack Type		Noise Filter Connection	Recommended Noise Filter		
				Type	Specifications	
200 V	30 W (0.04 HP)	SGDA-A3A□	(Correct) 	LF-205A	Single-phase 200 VAC, 5 A	
	50 W (0.07 HP)	SGDA-A5A□				
	100 W (0.13 HP)	SGDA-01A□				
	200 W (0.27 HP)	SGDA-02A□		(Incorrect) 	LF-210	Single-phase 200 VAC, 10 A
	400 W (0.53 HP)	SGDA-04A□			LF-220	Single-phase 200 VAC, 20 A
	750 W (1.01 HP)	SGDA-08A□				
100 V	30 W (0.04 HP)	SGDA-A3B□	(Incorrect) 	LF-205A	Single-phase 200 VAC, 5 A	
	50 W (0.07 HP)	SGDA-A5B□				
	100 W (0.13 HP)	SGDA-01B□		LF-210 LF-220	Single-phase 200 VAC, 10 A Single-phase 200 VAC, 20 A	
	200 W (0.27 HP)	SGDA-02B□				
	300 W (0.39 HP)	SGDA-03B□				

Note These noise filters are manufactured by Tokin Corp. and available from Yaskawa. For noise filters, contact your nearest Yaskawa sales representatives.

b) Always observe the following installation and wiring instructions. Incorrect use of a noise filter halves its benefits.

- Separate input lines from output lines.

Do not put the input and output lines in the same duct or bundle them together.

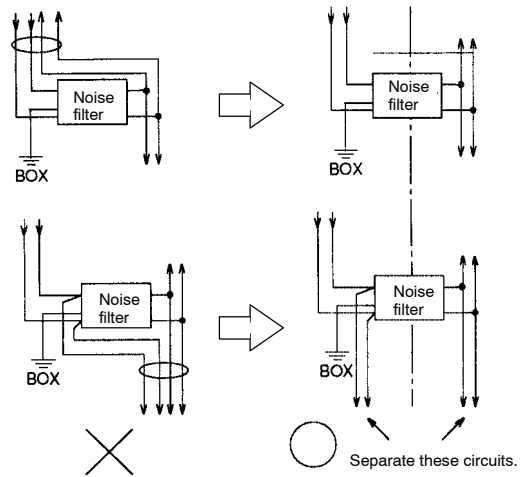
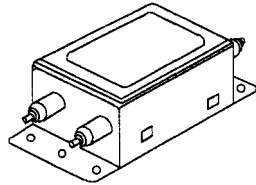

- Separate the noise filter ground wire from the output lines.

Do not accommodate the noise filter ground wire, output lines and other signal lines in the same duct or bundle them together.

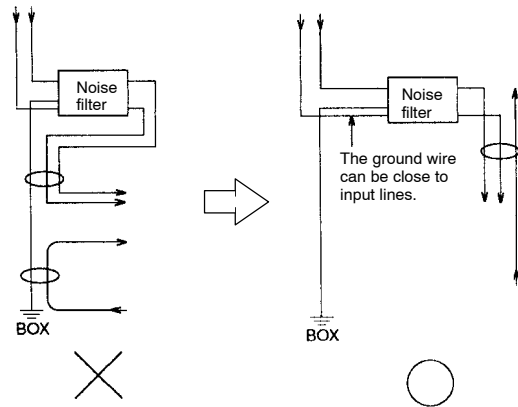

- Connect the noise filter ground wire directly to the ground plate.

Do not connect the noise filter ground wire to other ground wires.

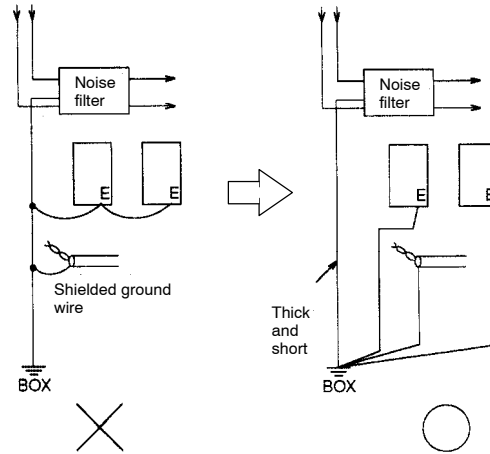

3

- When grounding a noise filter inside a Unit.

If a noise filter is located inside a Unit, connect the noise filter ground wire and the ground wires from other devices inside the Unit to the ground plate for the Unit first, then ground these wires.

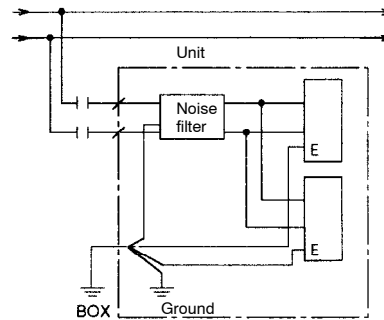

3.8.3 Using More Than One Servo Drive

Example of Wiring More than One Servo Drive

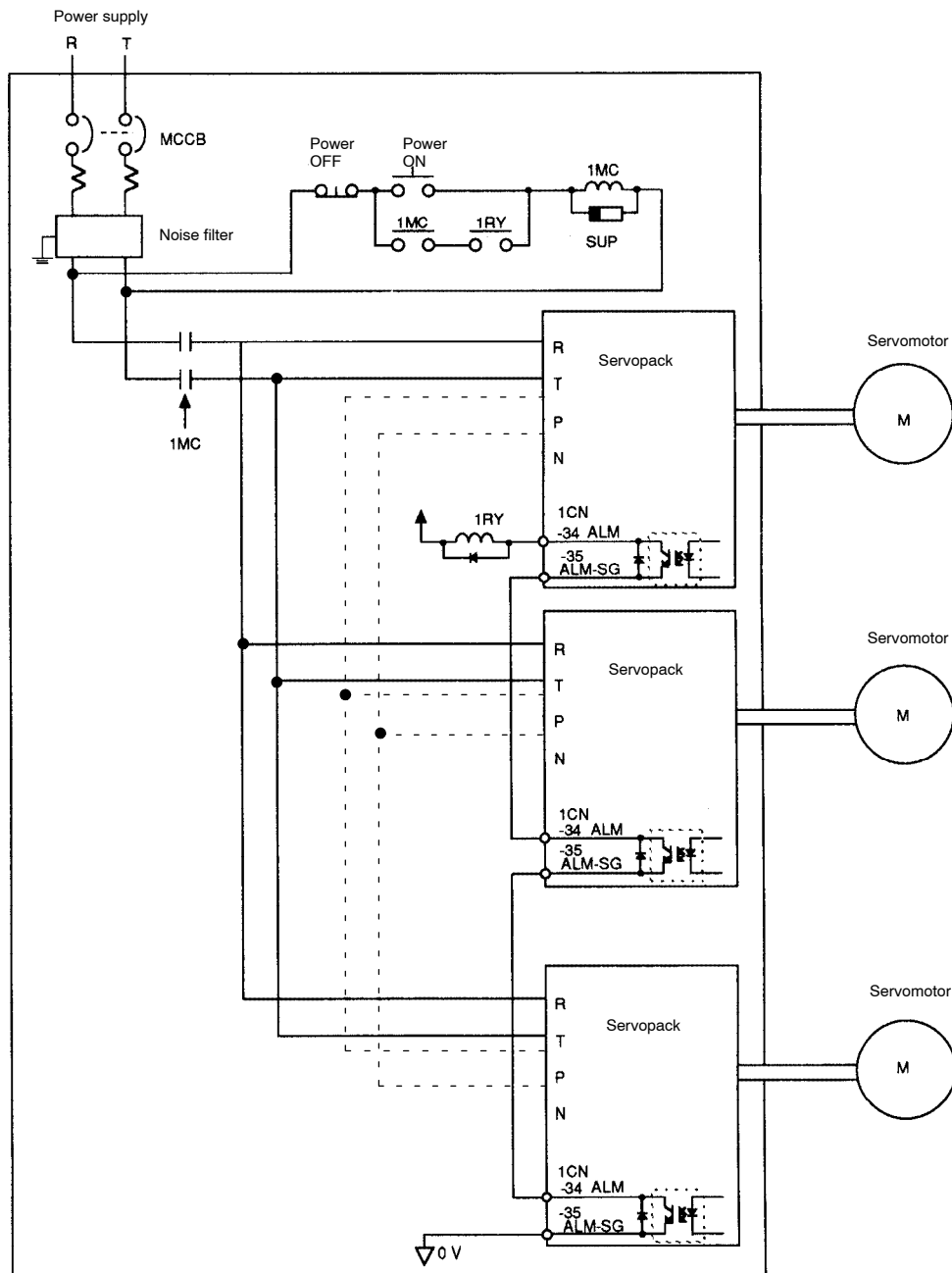

- 1) Connect the alarm output (ALM) terminals for the three Servopacks in series to enable alarm detection relay 1RY to operate. This is because ALM is a logical complement output signal, so the output transistor is turned OFF when the system enters an alarm state.
- 2) Since the Servopack power supply is a capacitor input type, connecting P and N terminals in parallel produces high power capacity as a whole, enhancing regenerative performance.

- 3) When connecting P and N terminals in parallel, be sure to turn all the Servopack power ON simultaneously. Do not turn any Servopack power ON when connecting P and N terminals in parallel.
- 4) Multiple servos can share a single MCCB or noise filter. Always select a MCCB or noise filter that has enough capacity for the total power capacity (load conditions) of those servos. For details, refer to page 138.

MCCB

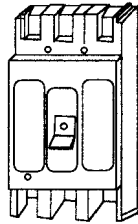

Noise filter

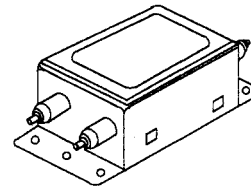

3

3.8.4 Using Regenerative Units

1) “What is a Regenerative Unit?”

A regenerative unit is designed to safely consume electric energy that is generated when the servomotor is rotated by the load.

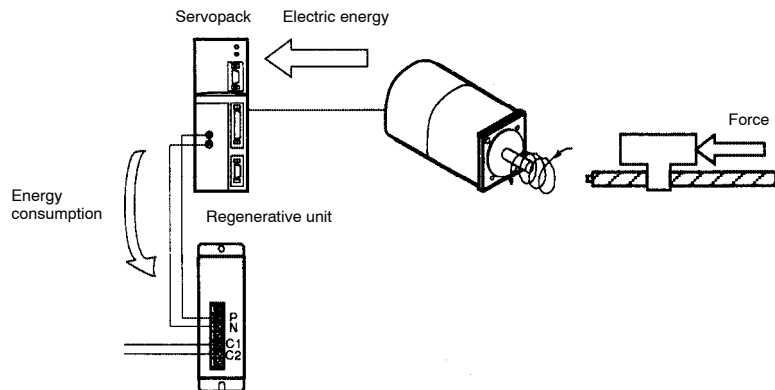

2) “When is a Regenerative Unit Required?”

Generally, a regenerative unit is not required. In the following cases, however, the user must determine whether a regenerative unit is required or not:

- a) When the motor is used to control a vertical axis.
- b) When the motor starts and stops frequently.

- c) When load inertia exceeds the allowable load inertia on the motor side.
- d) When the motor rotates at a speed higher than the rated speed (3000 r/min).

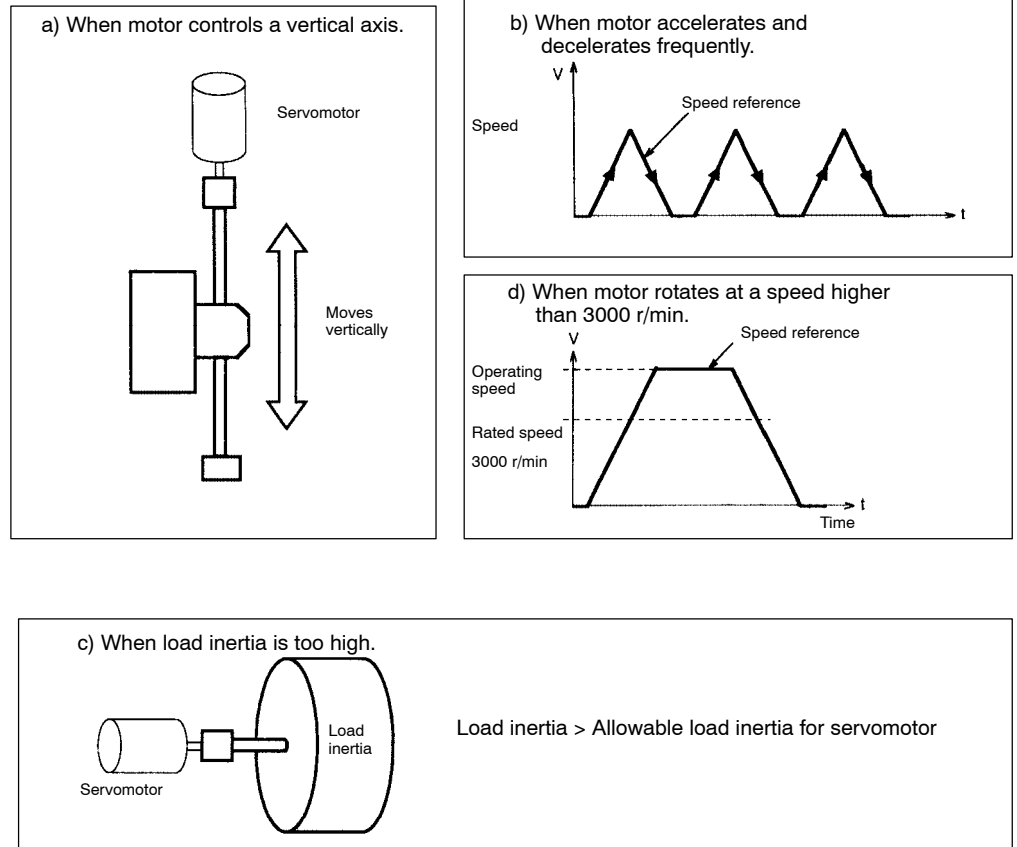

3) “How can we Determine Whether a Regenerative Unit is Required or Not?”

Using software “regenerative capacity check program” enables the user to easily determine whether a regenerative unit is required. This software is included as part of Yaskawa proprietary software “**AC servomotor sizing software**,” which is supplied free of charge. Use this software as necessary.

4) Connecting a Regenerative Unit (JUSP-RG08 type)

The standard connection diagram for a regenerative unit (JUSP-RG08) is shown below.

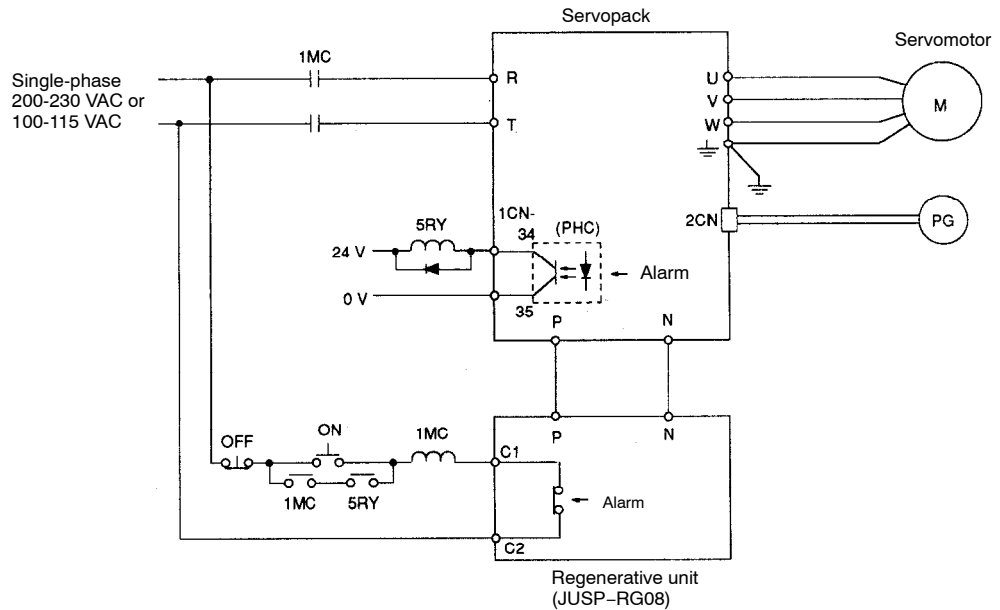

3

- a) A regenerative unit has the following fault detection functions:
- Detecting disconnection in a regenerative resistor
 - Detecting faults in a regenerative transistor
 - Detecting overvoltage
- b) When one of these fault detection functions operates, the internal alarm relay is actuated. Then, the circuit between output terminals C1 and C2 is opened.
- c) Form a sequence so that the Servopack power is turned OFF when the alarm relay is actuated.

5) Connecting a Regenerative Unit (JUSP-RG08C type)

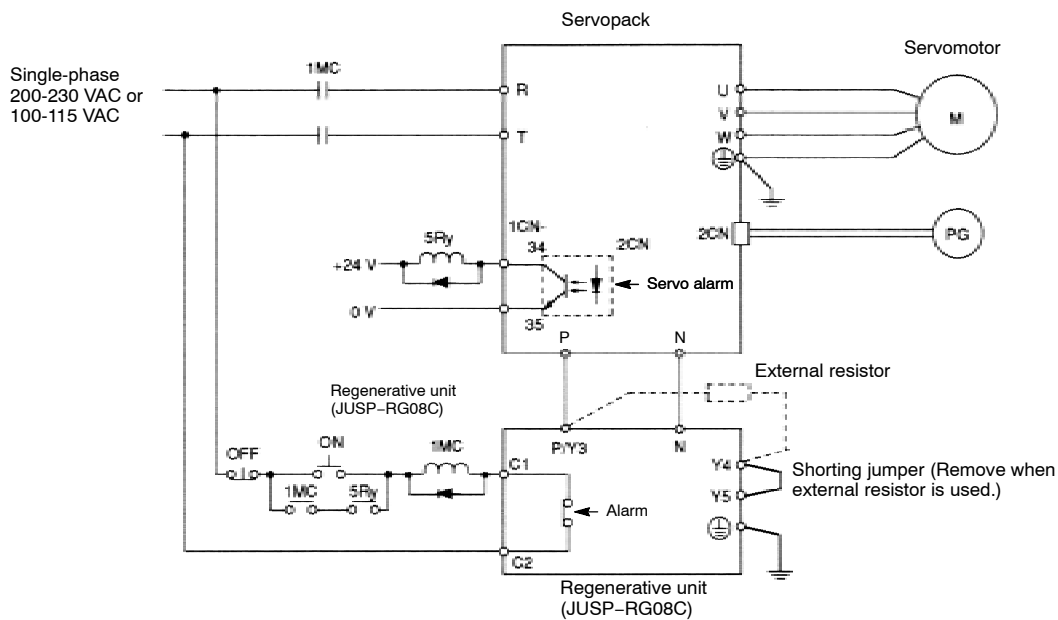

- A regenerative unit has the following fault detection functions:
 - Detecting disconnection in a regenerative resistor
 - Detecting faults in a regenerative transistor
 - Detecting overvoltage
- When one of these fault detection functions operates, the internal alarm relay is actuated. Then, the circuit between output terminals C1 and C2 is opened.
- When an external resistor is used, remove the shorting jumper between Y4 and Y5. Then, connect the resistor between P/Y3 and Y4.
- The resistance value of the external resistor should be 50Ω min.

3.8.5 Using an Absolute Encoder

1) Outline

An absolute value detection system detects an absolute position of the machine even when the servo system is OFF. If such a system is to be formed in the host controller, use an SGM or SGMP Servomotor with absolute encoder. Consequently, automatic operation can be performed without zero return operation immediately after the power is turned ON.

SGM□□□W1□
(SGMP□□□W1□)

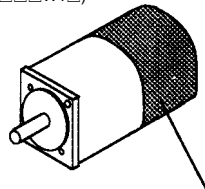

12-bit absolute encoder

Always detects absolute position



2) Standard Connection Diagram for a 12-bit Absolute Encoder Mounted on a Servomotor

• Interface Circuit

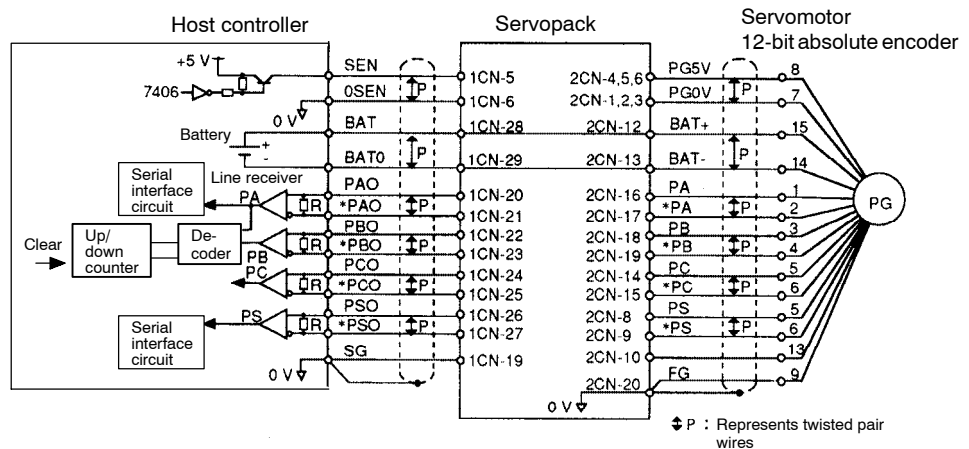

Line Receiver Used: SN75175 or MC3486 manufactured by Texas Instruments Inc.
Termination Resistor R: 220 to 470 Ω

For Speed/Torque Control (SGDA-□□□S)
Normally, PAO serial data is used. In this case, PS serial interface is unnecessary.

For Position Control (SGDA-□□□P)
SEN signal is not used. Normally, PSO serial data is used. In this case, PA serial interface is unnecessary.

SEN signal

- The SEN signal must be set at high level after at least three seconds after the power is turned ON.
- When the SEN signal is changed from low level to high level, +5 V is applied to the absolute encoder, and serial data and initial incremental pulses are transmitted.
- The motor is not turned ON until these operations are complete, regardless of the servo ON signal (SV-ON).

Electrical Specifications

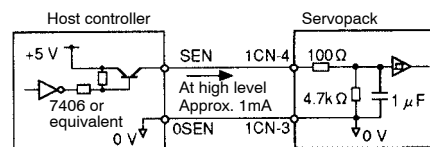

- A PNP transistor is recommended.
- Signal level High level: Min. 4 V
Low level: Max. 0.7 V

3) Memory Switch to Determine Whether to Use Input Signal SEN

Cn-01 Bit 1	Use of SEN Input Signal	Factory Setting: 0	For Speed/Torque Control Only
--------------------	-------------------------	--------------------	-------------------------------

This memory switch is used to determine whether to use input signal SEN (1CN-5).

This memory switch is available for absolute encoders only (not for incremental encoders).

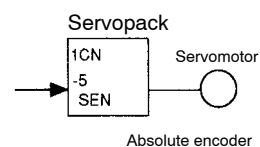

Setting	Meaning
0	Uses SEN signal.
1	Does not use SEN signal.

NOTE If the SEN signal is to be turned OFF, then ON again, it must remain at high level for at least 1.3 seconds before being turned OFF.

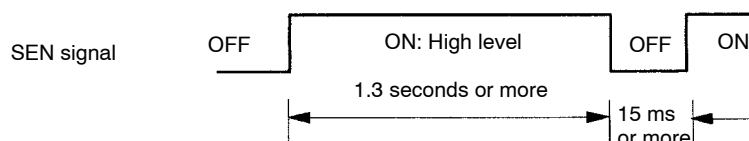

4) Memory Switch to 1 to Select Absolute Encoder

Cn-01 Bit E	Encoder Type Selection	Factory Setting: 0	For Speed/Torque Control and Position Control
--------------------	------------------------	--------------------	---

Sets the encoder type according to the servomotor type to be used.

After changing the memory switch setting, turn the power OFF, then ON.

Motor Type	Number of Encoder Pulses Per Revolution	Preset Value
SGM-□□□31□ SGMP-□□□31□	Incremental encoder: 2048 pulses per revolution	0
SGM-□□□W1□ SGMP-□□□W1□	Absolute encoder: 1024 pulses per revolution	1

Use the following user constant to set the number of pulses for the absolute encoder to be used:

Cn-11	PULSNO Number of Encoder Pulses	Unit: P/R	Setting Range: Number of Encoder Pulses	Factory Setting: 2048	For Speed/Torque Control and Position Control
--------------	------------------------------------	--------------	--	--------------------------	---

Sets the number of encoder pulses according to the servomotor type to be used.

Motor Type	Number of Encoder Pulses Per Revolution	Preset Value
SGM-□□□31□ SGMP-□□□31□	Incremental encoder: 2048 pulses per revolution	2048
SGM-□□□W1□ SGMP-□□□W1□	Absolute encoder: 1024 pulses per revolution	1024

5) Using a Battery

Use the following battery to enable the absolute encoder to store position information even when the power is turned OFF. Load the battery in the host controller and connect it to Servopack input terminals BAT and BAT0.

Recommended battery:	<ul style="list-style-type: none"> Connect the battery securely to prevent contact faults resulting from environmental changes or aging. Battery voltage is not monitored inside the Servopack. Provide a battery voltage monitor circuit as necessary. Minimum voltage: 2.8 V
Lithium battery Toshiba Battery ER6V C3 Type 3.6 V, 2000 mAH	

6) Setting up Absolute Encoder

a) Set up the absolute encoder in the following cases:

- When starting the machine for the first time
- When the absolute encoder is not connected to power supply or backup power supply (battery) for more than two days

b) The setup procedure is as follows:

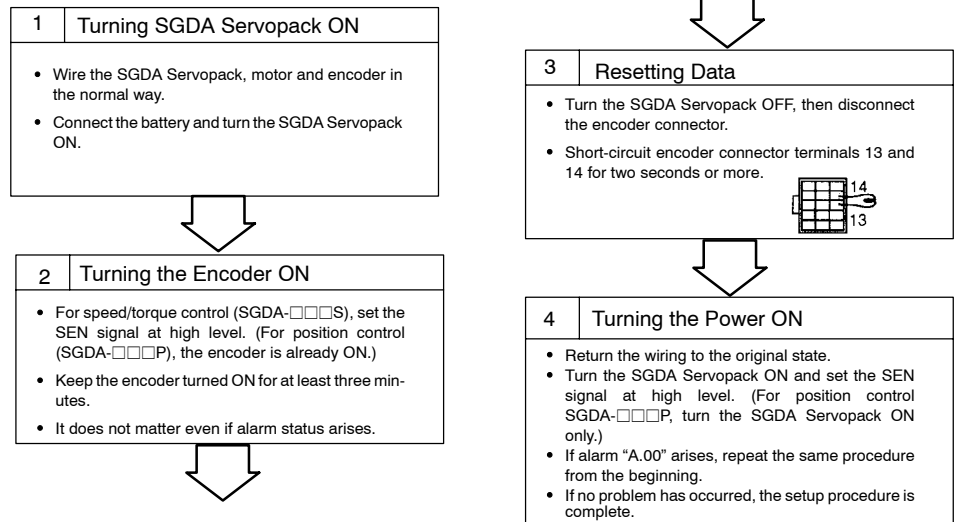

NOTE Setting up the encoder sets the revolution count inside the encoder to 0. After setting up the encoder, always reset the machine home position. Operating the machine without the home position being reset does not only damage the machine but may also cause an accident resulting in injury or death.

7) **Absolute Data Exchange Sequence**

The Servopack sends absolute data to the host controller when receiving output from a 12-bit absolute encoder. This data exchange sequence is described below.

Use the following detailed information when designing a host controller.

a) **Outline of Absolute Signal**

The 12-bit absolute encoder outputs PAO, PBO, PCO and PSO as shown on the right.

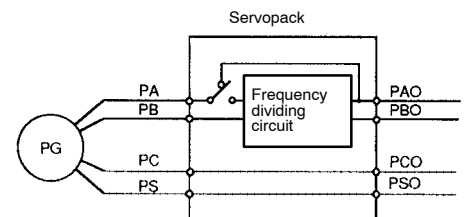

Signal Name	Status	Contents
PAO	Initial state	Serial data Initial incremental pulse
	Normal state	Incremental pulse
PBO	Initial state	Initial incremental pulse
	Normal state	Incremental pulse
PCO	Normal state	Home position pulse
PSO	Normal state	Rotation count serial data

b) Contents of Absolute Data

Serial Data: Indicates how many turns the motor shaft has made from the reference position (position specified at setup).

Initial Incremental Pulse: Outputs pulses at the same pulse rate as when the motor shaft rotates from the home position to the current position at the maximum speed of 4,900 r/min.

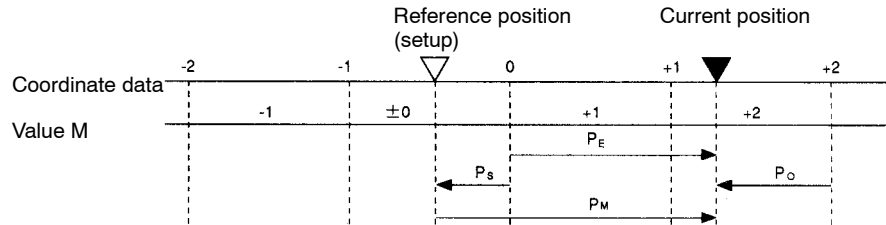

Absolute data P_M can be determined using the following formula.

$$P_E = M \times R + P_o$$

$$P_M = P_E - P_s$$

P_E	Current value read by encoder
M	Serial data (rotation count data)
P_o	Number of initial incremental pulses (Normally, this is a negative value)
P_s	Number of initial incremental pulses read at setup
P_M	Current value required for the customer system
R	Number of pulses per encoder revolution (pulse count after dividing, value of Cn-0A)

c) Absolute Data Transmitting Sequence

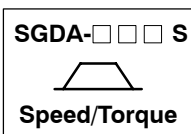

For speed/torque control (SGDA-□□□S).

- (3) Set the SEN signal at high level.
- (4) After 100 ms, set the system to serial data reception-waiting-state. Clear the incremental pulse up/down counter to zero.
- (5) Receive eight bytes of serial data.
- (6) The system enters a normal incremental operation state approximately 50 ms after the last serial data is received.

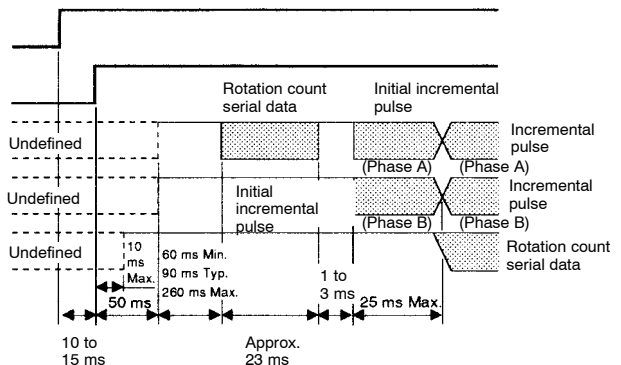

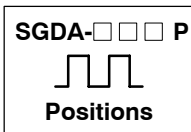

For position control (SGDA-□□□P).

A 12-bit absolute encoder outputs PAO, PBO, PCO and PSO as shown below.

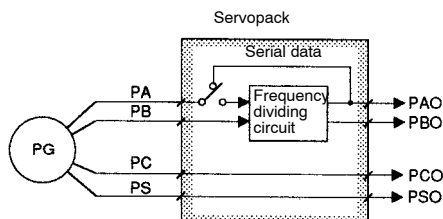

Absolute data is read from phase S (PSO) as serial data. It is first output from PAO as serial data when the Servopack is turned ON. Next, it is output as initial incremental pulses PAO and PBO (two-phase pulse with 90° phase difference).

Then, output operation becomes the same as normal incremental encoder operation (two-phase pulse with 90° phase difference).

Rotation count serial data is output from PSO. Absolute data must be processed in the following sequence.

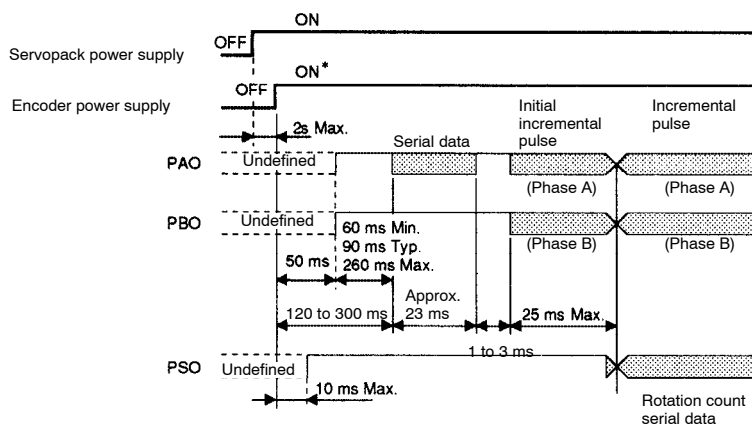

*Encoder power is automatically turned ON inside the Servopack.

Use PAO, PBO and PCO as necessary. If PAO and PBO are used, absolute data is output to PAO and PBO when power is turned ON as shown in the figure above. However, since encoder power ON timing is not adjusted within the processing circuit prepared by the customer, absolute data cannot be read via PAO or PBO.

d) Detailed Specifications of Each Signal

• Specifications of PAO Serial Data:

The number of revolutions is output in five digits.

Data transmission method	Start-stop synchronization (ASYNC)
Baud rate	9600
Start bit	1 bit
Stop bit	1 bit
Parity	Even number
Character code	ASCII 7-bit code
Data format	8 characters. As shown on the right.

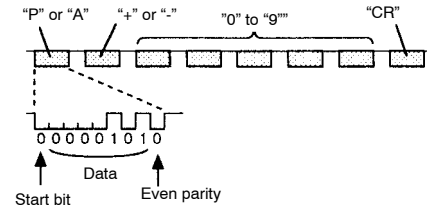

- Data is P+00000 (CR) or P-00000 (CR) when the number of revolutions is zero.
- The maximum number of revolutions is ± 99999. If this value is exceeded, it returns to 0000.

• Specifications of PSO Serial Data:

The number of revolutions and the absolute position within one revolution are always output in five and four digits, respectively. The transmission cycle is approximately 40 ms.

Data transmission method	Start-stop synchronization (ASYNC)
Baud rate	9600
Start bit	1 bit
Stop bit	1 bit
Parity	Even number
Character code	ASCII 7-bit code
Data format	13 characters. As shown on the right.

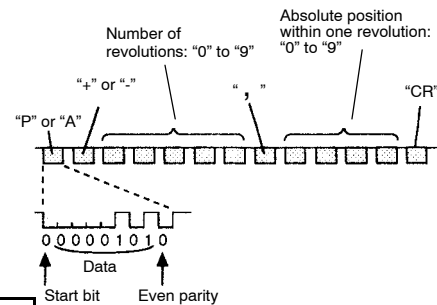

- Absolute position data within one revolution is a value before frequency dividing. (4,096 pulses per revolution)
- Absolute position data increases during forward rotation (standard setting). (Not valid in reverse rotation mode)

• Incremental Pulse and Home Position Pulse:

Initial incremental pulses which provide absolute data are first divided by the frequency divider inside the Servopack and then output in the same way as normal incremental pulses.

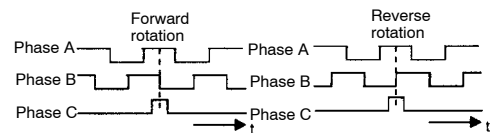

- Note that phase C is not divided so its pulse width is narrower than phase A.

- Use the following user constant to set the pulse dividing ratio.

Cn-0A	PGRAT Dividing Ratio Setting	Unit: P/R	Setting Range: 16 to Number of Encoder Pulses	Factory Setting: 2048	For Speed/Torque Control and Position Control
--------------	------------------------------------	-----------	--	-----------------------------	---

Set the number of output pulses for PG output signals (PAO, *PAO, PBO and *PBO).

Pulses from motor encoder (PG) are divided by the preset number of pulses before being output.

The number of output pulses per revolution is set in this user constant. Set this value according to the reference unit of the machine or controller to be used.

The setting range varies according to the encoder used.

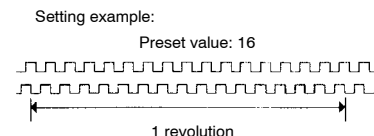
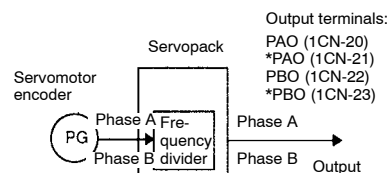

Motor Type	Number of Encoder Pulses Per Revolution	Setting Range
SGM-□□□31□	Incremental encoder: 2048 pulses per revolution	16 to 2048
SGM-□□□W1□	Absolute encoder: 1024 pulses per revolution	16 to 1024

8) Alarm Display

When a 12-bit absolute encoder is used, the following alarms are detected and displayed.

List of Alarms

Alarm Type	Meaning	Digital Operator Display	PAO Serial Data	PSO Serial Data
Backup Alarm	Indicates that backup voltage drop was detected. (This alarm helps maintain reliability of rotation count data.)		ALM81. (CR)	ALARMOA BACK (CR)
Battery Alarm	Indicates that backup voltage drop was detected. (This alarm warns of battery replacement and disconnection.)		ALM83. (CR)	ALARMOD BATT (CR)
Checksum Error	Indicates that an error was detected in memory data check.		ALM82. (CR)	ALARMOB CHEC (CR)
Overspeed	Indicates that the motor was running at a speed exceeding 400 r/min when the encoder was turned ON.		ALM85. (CR)	ALARMOP OVER (CR)
Absolute Error	Indicates that an error was detected in sensor check inside the encoder.		ALM84. (CR)	ALARMOH ABSO (CR)
Backup/Battery Combination Alarm			ALM81. (CR)	ALARMOE BACK (BATT) (CR)

The SEN signal can be used to output alarm information from PAO and PSO as serial data. (This function is not available if the Servopack is turned OFF by the external circuit when an alarm occurs.)

SEN Signal				
Digital Operator Display	 or 	 Absolute encoder alarm (Details unknown)	 Absolute encoder alarm (Alarm type identified)	
PAO Serial Data	 Incremental pulse	ALM80. (CR)	ALARMO* (CR)	ALM8*. (CR)
PSO Serial Data	P±□□□□□, H±□□□□□, □□□□ (CR) □□□□ (CR) and so on	(Undefined)	ALARMO* (CR) ****	(Undefined)

3

9) Absolute Encoder Home Position Error Detection

Cn-02 Bit 1	Absolute Encoder Home Position Error Detection	Factory Setting: 0	For Speed/Torque Control and Position Control
--------------------	--	--------------------	---

This memory switch is used to specify whether to use **home position error detection** (alarm A.80) when an absolute encoder is used.

Setting	Meaning
0	Detects a home position error.
1	Does not detect a home position error.

Normally, set this memory switch to “0.”

This memory switch has no significance when an incremental encoder is used.

3

3.8.6 Extending an Encoder Cable

- 1) Both incremental and absolute encoders have a standard encoder cable (maximum 20 meters (65.6 ft.)). If a longer cable is required, prepare an extension cable as described below. The maximum allowable cable length is 50 meters (164 ft.).

- a) 3-meter (19.8 ft.) Cable with Connectors:

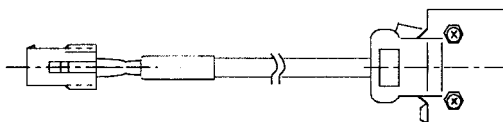

- For incremental encoder: DP9320089-1
- For absolute encoder: DP9320088-1

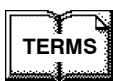

Home position error detection

This function detects an encoder count error resulting from noise. It checks the number of pulses per motor revolution, and outputs a home position error alarm if that number is incorrect.

If the absolute encoder detects an error, it inverts phase C and notifies the Servopack of the error. In this case, this “home position error detection” function also works.

b) 50-meter (164 ft.) Extension Cable:

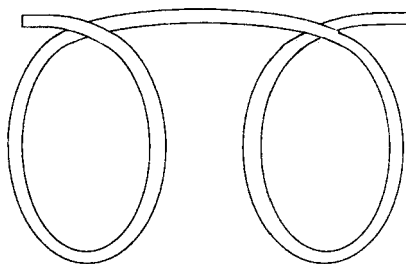

- For both incremental and absolute encoders: DP8409179

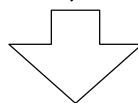

Cut this cable 30 cm (0.98 ft.) or less from each end.

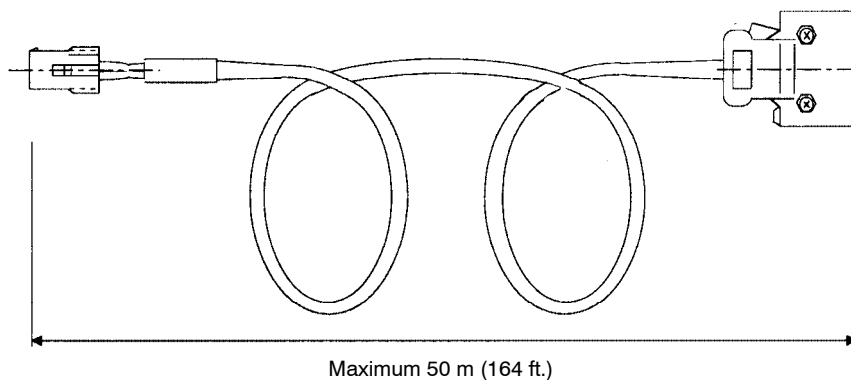
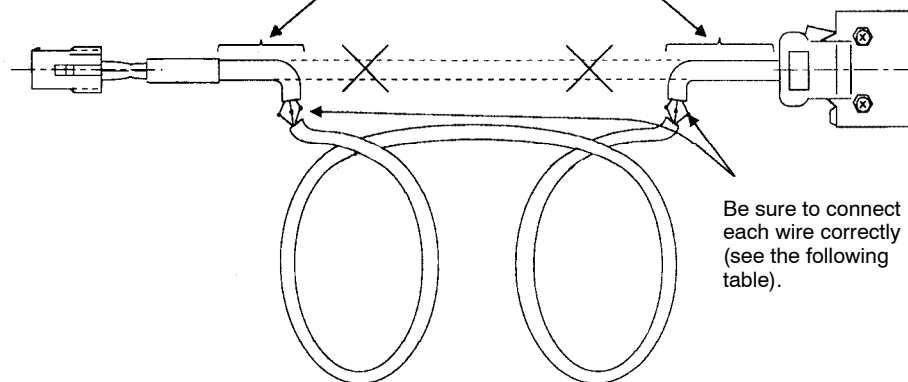

3

- 2) Connect cables of the same color to each other as shown in the table below. Note that wiring for incremental and absolute encoders is different.

Signal Name	Color and Wire Size of Cable with Connectors		Color and Wire Size of 50-meter Extension Cable (DP8409179)	
PG5V	Red	AWG22	Red	AWG16
PG0V	Black	AWG22	Black	AWG16
FG	Green/Yellow	AWG22	Green/Yellow	AWG16
PA	Blue	AWG26	Blue	AWG26
*PA	White/Blue	AWG26	White/Blue	AWG26
PB	Yellow	AWG26	Yellow	AWG26
*PB	White/Yellow	AWG26	White/Yellow	AWG26
PC	Green	AWG26	Green	AWG26
*PC	White/Green	AWG26	White/Green	AWG26
PS	Violet	AWG26	Purple	AWG26
*PS	White/Green	AWG26	White/Green	AWG26
RESET	White/Gray	AWG26	White/Gray	AWG26
BAT	Orange	AWG26	Orange	AWG26
BAT0	White/Orange	AWG26	White/Orange	AWG26

Only the absolute encoder can be connected.

3

3.8.7 Using SGDA Servopack with High Voltage Line

- 1) SGDA Servopacks are divided into single-phase 200 V and single-phase 100 V types according to supply voltage.

If, however, three-phase 400 VAC class (400 V, 440 V) power supply must be used, prepare the following power transformer (for single-phase).

<Primary side>

<Secondary side>

1) 400 or 440 VAC

→

200 VAC

2) 400 or 440 VAC

→

100 VAC

APPLICATIONS OF Σ -SERIES PRODUCTS

3.8.7 Σ SGDA Σ Servopack with High Voltage Line cont.

2) Select appropriate power transformer capacity according to the following table.

Supply Voltage	Servopack Type	Power Supply Capacity Per SGDA Servopack (kVA) (see note)
200 V	SGDA-A3A	0.25
	SGDA-A5A	0.3
	SGDA-01A	0.5
	SGDA-02A	0.75
	SGDA-04A	1.2
	SGDA-08A	2.2
100 V	SGDA-A3B	0.2
	SGDA-A5B	0.3
	SGDA-01B	0.5
	SGDA-02B	0.75
	SGDA-03B	1.4

Note At rated load.

3) When 400-V-class supply voltage is used, power must be turned ON and OFF on the primary side of the power transformer.

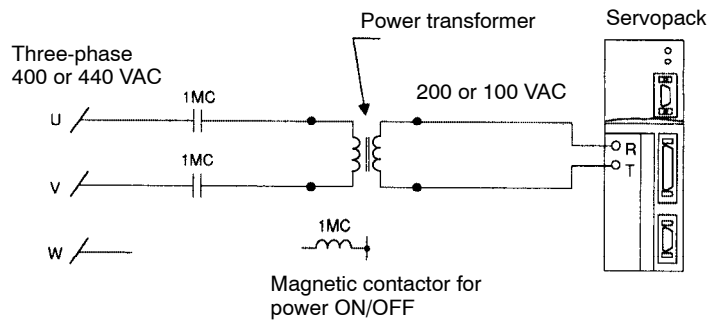

3.8.8 Connector Terminal Layouts

This section describes connector terminal layouts for Servopacks, Servomotors and Digital Operators.

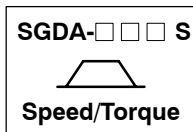

1) Servopack Connectors for Speed/Torque Control

1CN Terminal Layout

2	SG	Torque reference input 0 V	1	T-REF	Torque reference input	20	PAO	PG output phase A	19	SG	PG output signal 0V
4	SG	Speed reference input 0 V	3	V-REF	Speed reference input	22	PBO	PG output phase B	21	*PAO	PG output phase A
6	0SEN	SEN signal input (for absolute encoder only)	5	SEN	SEN signal input (for absolute encoder only)	24	PCO	PG output phase C	23	*PBO	PG output phase B
8	V-CMP	Speed coincidence output	7	BK	Brake interlock signal output	26	PSO	PG output phase S (for absolute encoder only)	25	*PCO	PG output phase C
10	SG-COM	BK/V-CMP/TGON common 0 V	9	TGON	TGON signal output	28	BAT	Battery (+) (for absolute encoder only)	27	*PSO	PG output phase S (for absolute encoder only)
12	N-CL	Reverse external torque limit ON input	11	P-CL	Forward external torque limit ON input	30	ALO1	Alarm code output (open collector output)	29	BAT0	Battery (-) (for absolute encoder only)
14	S-ON	Servo ON input	13	+24 V IN	External power supply input	32	ALO3		31	ALO2	Alarm code output (open collector output)
16	P-OT	Forward rotation prohibited	15	P-CON	P control input	34	ALM	Servo alarm output	33	SG-AL	Alarm code output common 0 V
18	ALMRST	Alarm reset input	17	N-OT	Reverse rotation prohibited	36	FG	Frame ground	35	ALM-SG	Servo alarm output

- **Servopack Side** Connector type: 10236-52A2JL (manufactured by 3M)
- **Cable Side** Connector type: 10136-3000VE (manufactured by 3M)
Connector case type: 10336-52A0-008 (manufactured by 3M)

2CN Terminal Layout

2	PG0V	PG power supply 0 V	1	PG0V	PG power supply 0 V	12	BAT +	Battery (+) (for absolute encoder only)	11		
4	PG5V	PG power supply +5 V	3	PG0V		14	PC	PG input phase C	13	BAT -	Battery (-) (for absolute encoder only)
6	PG5V		5	PG5V	PG power supply +5 V	16	PA	PG input phase A	15	*PC	PG input phase C
8	PS	PG input phase S (for absolute encoder only)	7	DIR	Rotation direction input	18	PB	PG input phase B	17	*PA	PG input phase A
10			9	*PS	PG input phase S (for absolute encoder only)	20	FG	Frame ground	19	*PB	PG input phase B

- **Servopack Side** Connector type: 10220-52A2JL (manufactured by 3M)
- **Cable Side** Connector type: 10120-3000VE (manufactured by 3M)
Connector case type: 10320-52A0-008 (manufactured by 3M)

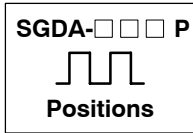

2) Servopack Connectors for Position Control

1CN Terminal Layout

2	*PULS	Reference pulse input	1	PULS	Reference pulse input	20	PAO	PG output phase A	19	SG	PG output signal 0 V
4	*SIGN	Reference signal input	3	SIGN	Reference sign input	22	PBO	PG output phase B	21	*PAO	PG output phase A
6	*CLR	Error counter clear input	5	CLR	Error counter clear input	24	PCO	PG output phase C	23	*PBO	PG output phase B
8	COIN	Positioning complete signal output	7	BK	Brake interlock signal output	26	PSO	PG output phase S (for absolute encoder only)	25	*PCO	PG output phase C
10	SG-COM	BK/COIN/TGON common 0 V	9	TGON	TGON signal output	28	BAT	Battery (+) (for absolute encoder only)	27	*PSO	PG output phase S (for absolute encoder only)
12	N-CL	Reverse external torque limit ON input	11	P-CL	Forward external torque limit ON input	30	ALO1	Alarm code output (open collector output)	29	BAT0	Battery (-) (for absolute encoder only)
14	S-ON	Servo ON input	13	+24 V IN	External power supply input	32	ALO3		31	ALO2	Alarm code output (open collector output)
16	P-OT	Forward rotation prohibited input	15	P-COM	P control input	34	ALM		Servo alarm output	33	SG-AL
18	ALMRST	Alarm reset input	17	N-OT	Reverse rotation prohibited	36	FG	Frame ground	35	ALM-SG	Servo alarm output

- **Servopack Side** Connector type:10236-52A2JL (manufactured by 3M)
- **Cable Side** Connector type:10136-3000VE (manufactured by 3M)
Connector case type:10336-52A0-008 (manufactured by 3M)

2CN Terminal Layout

2	PG0V	PG power supply 0 V	1	PG0V	PG power supply 0 V	12	BAT +	Battery (+) (for absolute encoder only)	11		
4	PG5V	PG power supply +5 V	3	PG0V		14	PC	PG input phase C	13	BAT -	Battery (-) (for absolute encoder only)
6	PG5V		5	PG5V	PG power supply +5 V	16	PA	PG input phase A	15	*PC	PG input phase C
8	PS	PG input phase S (for absolute encoder only)	7	DIR	Rotation direction input	18	PB	PG input phase B	17	*PA	PG input phase A
10			9	*PS	PG input phase S (for absolute encoder only)	20	FG	Frame ground	19	*PB	PG input phase B

- **Servopack Side** Connector type:10220-52A2JL (manufactured by 3M)
- **Cable Side** Connector type:10120-3000VE (manufactured by 3M)
Connector case type:10320-52A0-008 (manufactured by 3M)

3) Connectors for Incremental Encoder

1	Channel A output	Blue
2	Channel \bar{A} output	Blue/Black
3	Channel B output	Yellow
4	Channel \bar{B} output	Yellow/Black
5	Channel C output	Green
6	Channel \bar{C} output	Green/Black
7	0 V (power supply)	Gray
8	+5 V (power supply)	Red
9	Frame ground (FG)	Orange

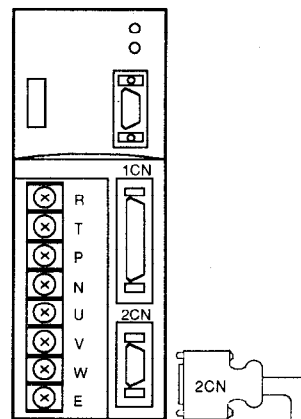

Items to be Prepared by Customer
 Cap: 172161-1
 Socket: 170361-1 (chain type) or
 170365-1 (loose type)

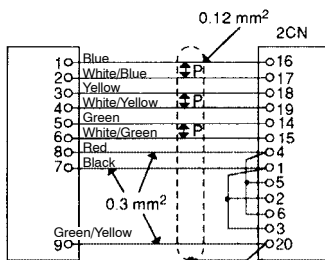
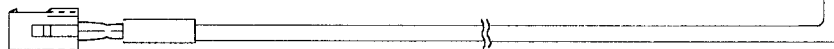
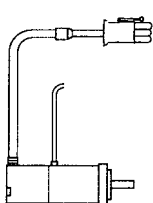

Items to be Prepared by Customer
 Case:
 10320-52A0-008
 (manufactured by 3M)
 Connector:
 10120-3000VE
 (manufactured by 3M)

4) Connectors for Absolute Encoder

1	Channel A output	Blue
2	Channel \bar{A} output	White/Blue
3	Channel B output	Yellow
4	Channel \bar{B} output	White/Yellow
5	Channel Z output	Green
6	Channel \bar{Z} output	White/Green
7	0 V (power supply)	Black
8	+5 V (power supply)	Red
9	Frame ground (FG)	Green/Yellow
10	Channel S output	Purple
11	Channel \bar{S} output	White/Purple
12	(Capacitor reset)	(Gray)
13	Reset	White/Gray
14	0 V (battery)	White/Orange
15	3.6 V (battery)	Orange

Do not use this terminal. (It is used to discharge electricity from capacitor before shipment.)



Items to be Prepared by Customer
 Cap: 172163-1
 Socket: 170361-1 (chain type) or 170365-1 (loose type)

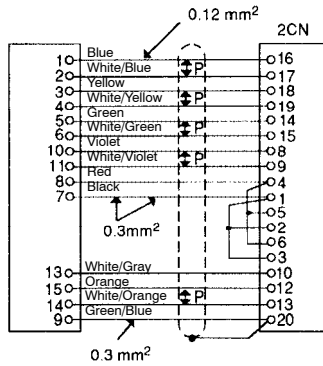
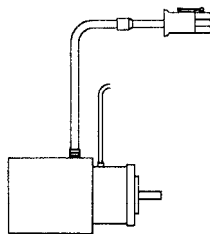
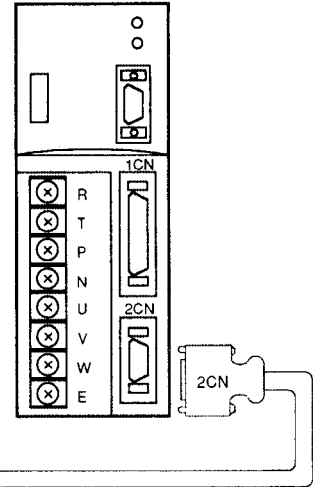

Items to be Prepared by Customer
 Case: 10320-52A0-008 (manufactured by 3M)
 Connector: 10120-3000VE (manufactured by 3M)

3

5) Connectors and Terminals for Standard-type Motor without Brake

1	Phase U	Red
2	Phase V	White
3	Phase W	Blue
4	Frame ground (FG)	Green

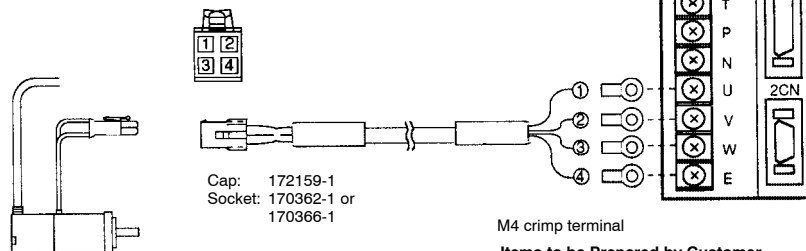

Items to be Prepared by Customer
Round crimp terminal R1.25-4TOR (manufactured by AMP.)

6) Connectors and Terminals for Motor with Brake

1	Phase U	Red
2	Phase V	White
3	Phase W	Blue
4	Frame ground (FG)	Green
5	Brake terminal	Black
6	Brake terminal	Black

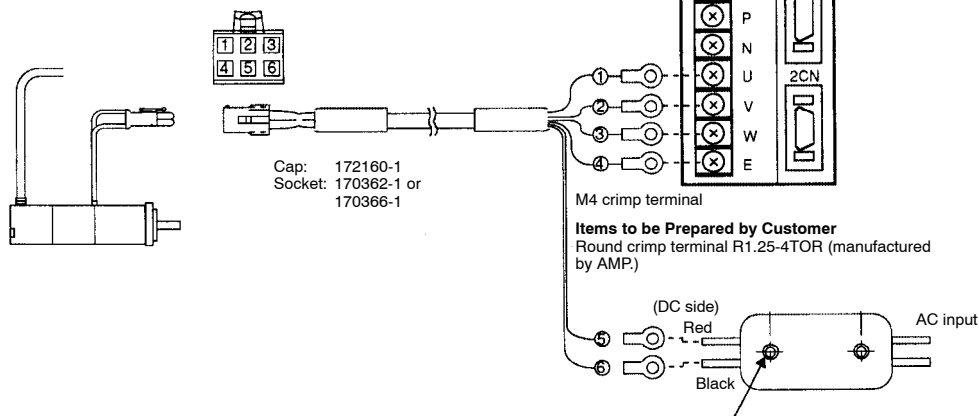

Items to be Prepared by Customer
Round crimp terminal R1.25-4TOR (manufactured by AMP.)

Brake power supply (manufactured by Yaskawa Controls Co., Ltd.)

- 100 VAC input: 90 VDC (LPDE-1H01)
- 200 VAC input: 90 VDC (LPSE-2H01)

7) Connectors for Digital Operator

- JUSP-OP02A-1 (Hand-held Type)

- JUSP-OP03A (Mount Type)

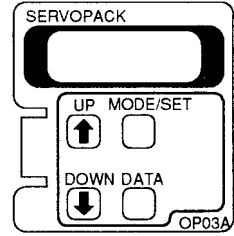
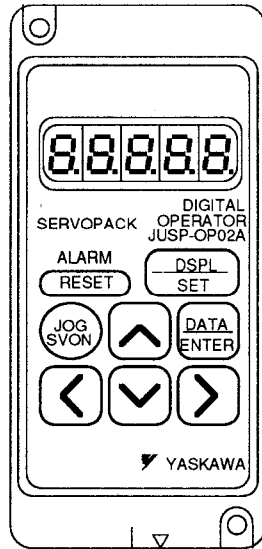

Fits directly into "OPERATOR" on the Servopack.

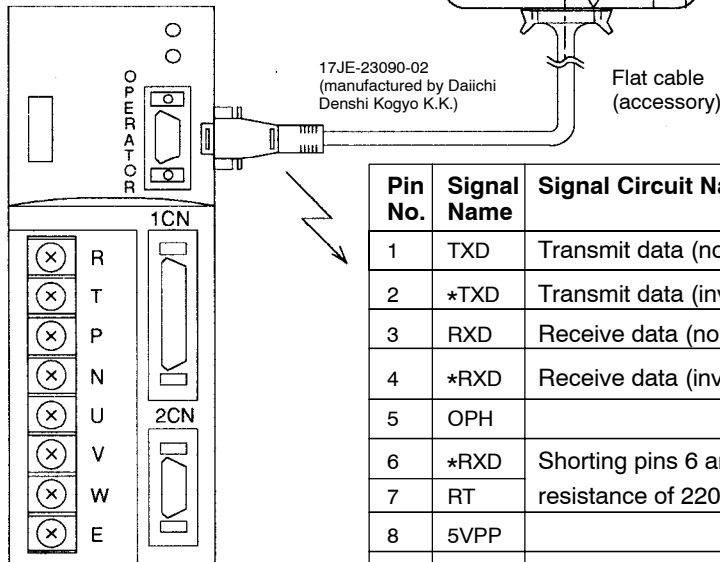

Pin No.	Signal Name	Signal Circuit Name	Signal Direction
1	TXD	Transmit data (non-inversion side)	P ← S
2	*TXD	Transmit data (inversion side)	P ← S
3	RXD	Receive data (non-inversion side)	P → S
4	*RXD	Receive data (inversion side)	P → S
5	OPH		#
6	*RXD	Shorting pins 6 and 7 produces a terminal resistance of 220 Ω between RXD and *RXD.	
7	RT		
8	5VPP		#
9	GND	Signal ground 0 V	

3

This chapter describes the basic operation of the digital operator and the convenient features it offers.

All constant settings and motor operations are possible by simple, convenient, operation.

Operate the digital operator as you read through this chapter.

4.1	Basic Operations	168
4.1.1	Connecting the Digital Operator	168
4.1.2	Resetting Servo Alarms	169
4.1.3	Basic Functions and Mode Selection	170
4.1.4	Operation in Status Display Mode	171
4.1.5	Operation in User Constant Setting Mode	174
4.1.6	Operation in Monitor Mode	179
4.2	Using the Functions	183
4.2.1	Operation in Alarm Trace-back Mode	183
4.2.2	Operation Using the Digital Operator	186
4.2.3	Autotuning	189
4.2.4	Reference Offset Automatic Adjustment	196
4.2.5	Speed Reference Offset Manual Adjustment Mode	199
4.2.6	Clearing Alarm Trace-back Data	202
4.2.7	Checking Motor Type	203
4.2.8	Checking Software Version	204

4.1 Basic Operations

This section describes the basic operations using the Digital Operator.

4.1.1	Connecting the Digital Operator	168
4.1.2	Resetting Servo Alarms	169
4.1.3	Basic Functions and Mode Selection	170
4.1.4	Operation in Status Display Mode	171
4.1.5	Operation in User Constant Setting Mode	174
4.1.6	Operation in Monitor Mode	179

4.1.1 Connecting the Digital Operator

The Digital Operator is available as two types: JUSP-OP02A-1 (Hand-held Type) and JUSP-OP03A (Mount Type).

Each type is connected to the Servopack as shown below.

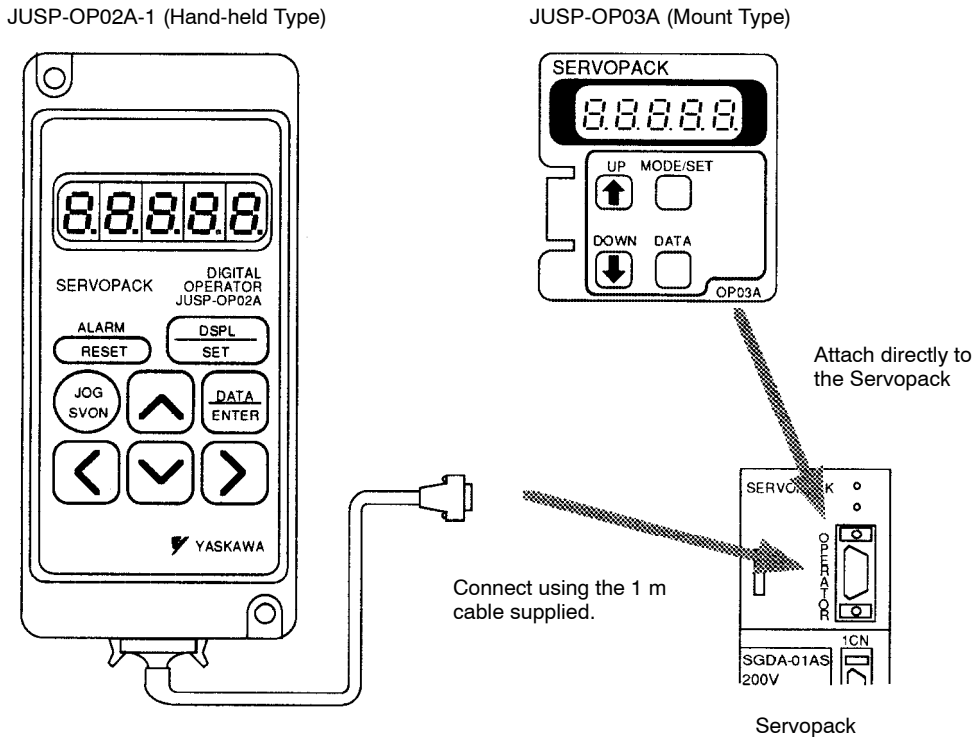

- The Digital Operator connector can be connected or disconnected while the Servopack power is ON.

4.1.2 Resetting Servo Alarms

Servo alarms can be reset using the Digital Operator. (Servo alarms can also be reset by the 1CN-18, ALMRST input signal. Refer to 3.7.1 for details.)

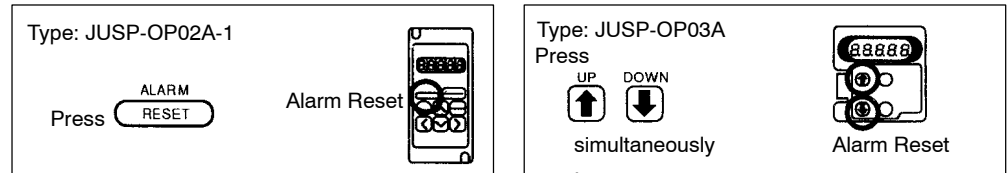

NOTE After an alarm occurs, remove the cause of the alarm before resetting it. Refer to *Section 6.2 Troubleshooting* to determine and remedy the cause of an alarm.

4.1.3 Basic Functions and Mode Selection

Digital Operator operation allows status display, user constant setting, operating reference, and auto-tuning operations.

Basic Mode Selection

The four basic modes are listed below. Each time the mode key is pressed, the next mode in the sequence is selected.

JUSP-OP02A-1

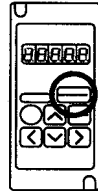

Press the



key to switch the mode.

JUSP-OP03A

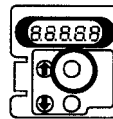

Press the



key to switch the mode.

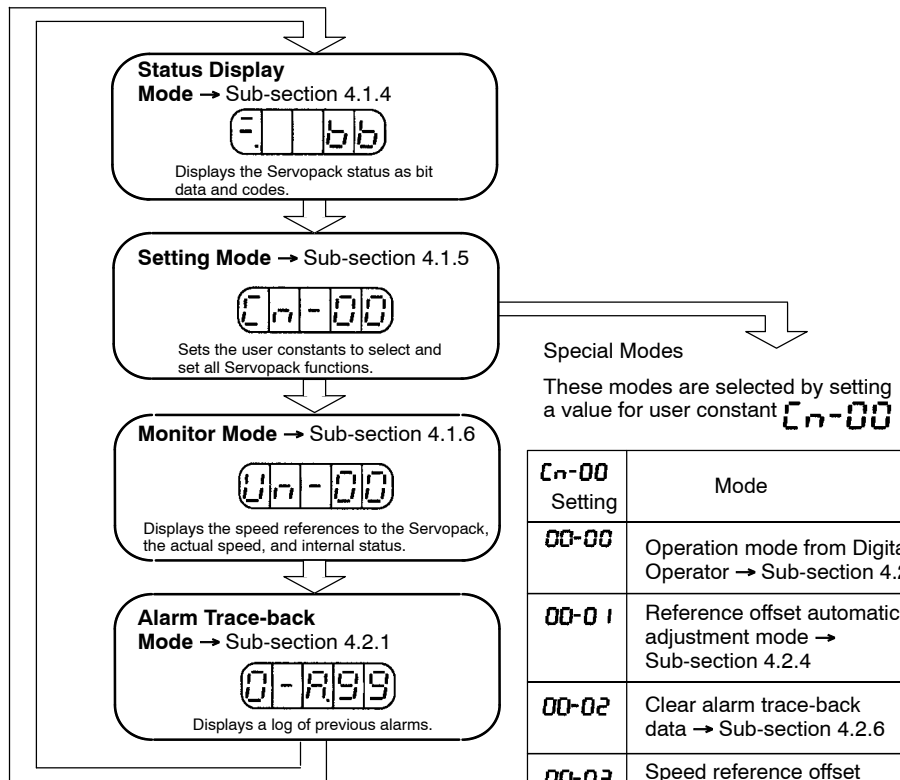

$Cn-00$ Setting	Mode
00-00	Operation mode from Digital Operator → Sub-section 4.2.2
00-01	Reference offset automatic adjustment mode → Sub-section 4.2.4
00-02	Clear alarm trace-back data → Sub-section 4.2.6
00-03	Speed reference offset manual adjustment mode → Sub-section 4.2.5
00-04	Motor-type check mode → Sub-section 4.2.7
00-05	Auto-tuning mode → Sub-section 4.2.3
00-06	Software-version check mode → Sub-section 4.2.8

4.1.4 Operation in Status Display Mode

The status display mode displays the Servopack status as bit data and codes.

- Selecting Status Display Mode

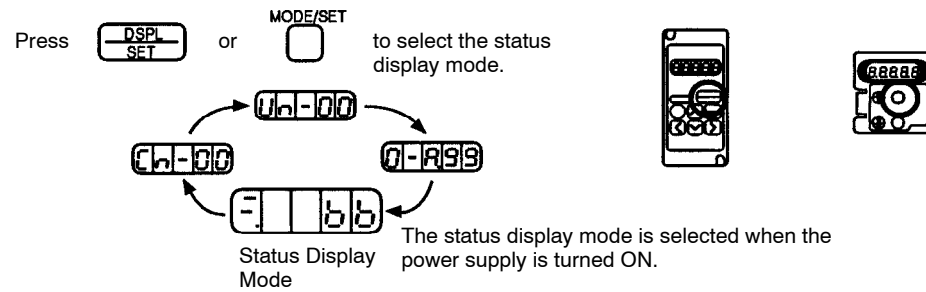

Keys to the status display are shown below. Note that the display differs between the speed/torque control (SGDA -□□□S) and position control (SGDA -□□□P) types.

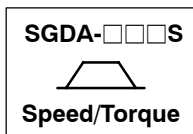

For Speed/Torque Control (SGDA -□□□S)

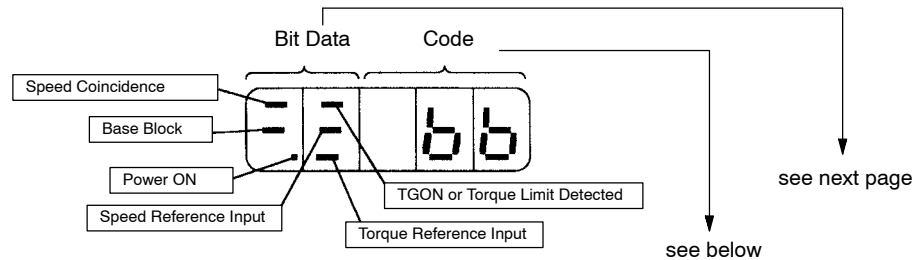

Code	Status
	Base block Servo OFF (motor power OFF)
	Run Servo ON (motor power ON)
	Forward Rotation Prohibited (P-OT) 1CN-16 (P-OT) OFF. See Cn-01 Bit 2 (page 57).
	Reverse Rotation Prohibited (N-OT) 1CN-17 (N-OT) OFF. See Cn-01 Bit 3 (page 57).
	Alarm Status Displays the alarm number. See the table of alarms on page 185

USING THE DIGITAL OPERATOR

4.1.4 Operation in Status Display Mode cont.

Bit Data	Description
Power ON	Lit when Servopack power ON. Not lit when Servopack power OFF.
Base Block	Lit for base block. Not lit at servo ON.
Speed Coincidence	Lit if motor speed reaches speed reference. Otherwise, not lit.
TGON or Torque Limit Detected (selected by Cn-01 Bit 4)	Lit if motor speed exceeds preset value. Not lit if motor speed is below preset value. Preset value: Set in Cn-0B (20 r/min is factory setting)
	Lit if Servopack internal torque reference exceeds preset value. Not lit if Servopack internal torque reference is below preset value. Preset value: Set in Cn-08, -09 (max. torque is standard setting) Cn-18 is preset value during 1CN-11 ($\overline{P-CL}$) input. Cn-19 is preset value during 1CN-12 ($\overline{N-CL}$) input. Not lit during torque control.
Speed Reference Input	Lit if input speed reference exceeds preset value. Not lit if input speed reference is below preset value. Specified value: Set in Cn-0B (20 r/min is factory setting)
Torque Reference Input	Lit if input torque reference exceeds preset value. Not lit if input torque reference is below preset value. Preset value: Set in Cn-0B (10% rated torque is standard setting)

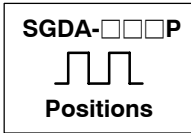

For Position Control (SGDA -□□□P)

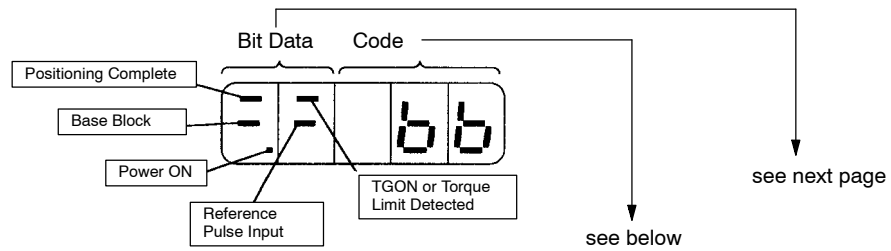

Code	Status
bb	Base block Servo OFF
run	Run Servo ON
Pot	Forward Rotation Prohibited 1CN-16 (P-OT) OFF. See Cn-01 Bit 2 (page 57).
not	Reverse Rotation Prohibited 1CN-17 (N-OT) OFF. See Cn-01 Bit 3 (page 57).
R00	Alarm Status Displays the alarm number. See the table of alarms on page 185.
R02	
?	

Bit Data	Description
Power ON	Lit when Servopack power ON. Not lit when Servopack power OFF.
Base Block	Lit for base block. Not lit at servo ON.
Positioning Complete	Lit if error between position reference and actual motor position is below preset value. Not lit if error between position reference and actual motor position exceeds preset value. Preset value: Set in Cn-1B (1 pulse is standard setting)
TGON or Torque Limit Detected (selected by Cn-01 Bit 4)	Lit if motor speed exceeds preset value. Not lit if motor speed is below preset value. Preset value: Set in Cn-0B (20 r/min is standard setting) Lit if Servopack internal torque reference exceeds preset value. Not lit if Servopack internal torque reference is below preset value. Preset value: Set in Cn-08, -09 (max. torque is standard setting) The smaller of Cn-08 and Cn-18 is preset value during 1CN-11 (P-CL) input. The smaller of Cn-09 and Cn-19 is preset value during 1CN-12 (N-CL) input. Not lit during torque control.
Reference Pulse Input	Lit if reference pulse is input. Not lit if no reference pulse is input.

4.1.5 Operation in User Constant Setting Mode

1) Two types of user constant are used

- a) Constant Settings (Cn-03 to Cn-23)
- b) Memory Switches (Cn-01, Cn-02)

The setting method is different for each type.

The Servopack offers a large number of functions, which are selected and adjusted by the user constant settings.

The constant settings (Cn-03 to Cn-23) allow setting of a constant within a fixed range.

The memory switches (Cn-01, Cn-02) allow the required functions to be selected.

Refer to *Appendix D List of User Constant Settings*.

2) Using the Setting Mode for Constant Settings (Cn-03 to Cn-23)

The constant settings (Cn-03 to Cn-23) allow setting of a constant. Check the permitted range of the constant in *Appendix D List of User Constant Settings*, before changing the data. The example below shows how to change user setting Cn-15 from 100 to 85.

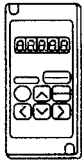

JUSP-OP02A-1

For JUSP-OP02A-1

- 1) Press to select the user constant setting mode.

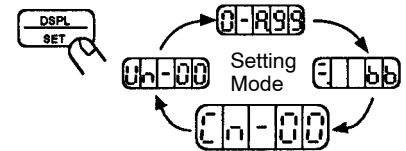

- 2) Select the user constant number to set.
Press the and keys to select the digit.
Press the and keys to change the value.

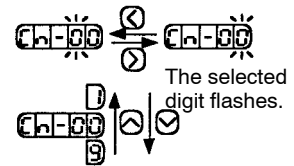

- 3) Press to display the current data for the user constant selected at step 2.

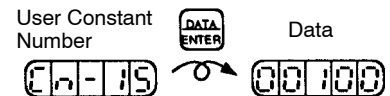

- 4) Set the required data.
Press the and keys to select the digit.
Press the and keys to change the value.

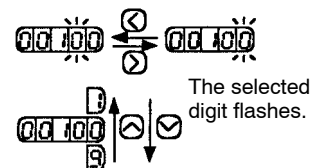

- 5) Press to store the data.

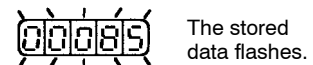

- 6) Press once more to display the user constant number again.

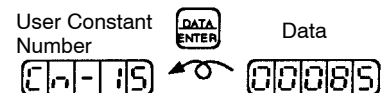



- 7) Repeat steps 2 to 6 as often as required.



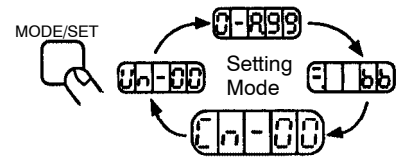

For JUSP-OP03A

1) Press ^{MODE/SET}  to select the user constant setting mode.



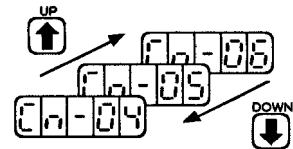

2) Press the ^{UP}  and ^{DOWN}  keys to select the user constant number to set.

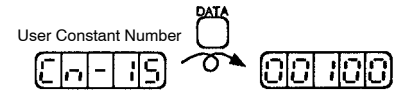

3) Press ^{DATA}  to display the current data for the user constant selected at step 2.



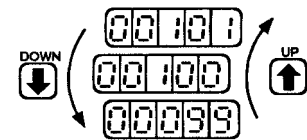

4) Press the ^{UP}  and ^{DOWN}  keys to change the data to the required value.

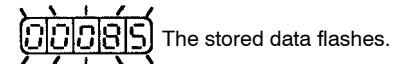

Value changes rapidly when key held down

5) Press ^{DATA}  to store the data.



6) Press ^{DATA}  once more to display the user constant number again.



7) Repeat steps 2 to 6 as often as required.

- Refer to *Appendix D List of User Constant Settings*

3) Using the Setting Mode for Memory Switches (Cn-01, Cn-02)

Turn the bits of the memory switches ON and OFF to select the functions required. The example below shows how to turn ON Bit 4 of memory switch Cn-01.

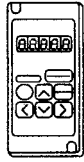

JUSP-OP02A-1

For JUSP-OP02A-1

1) Press to select the user constant setting mode.

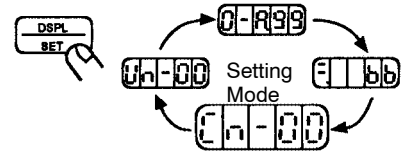

2) Select the user constant number to set.
 Press the and keys to select the digit.
 Press the and keys to change the value.

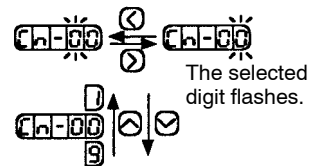

3) Press to display the current data for the memory switch selected at step 2.

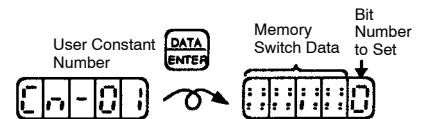

4) Press the and keys to select the bit number to set.

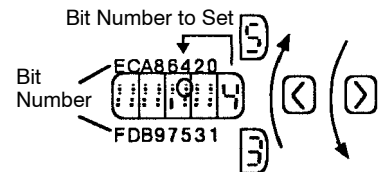

5) Press the and keys to set the memory switch data ON or OFF for the bit number.

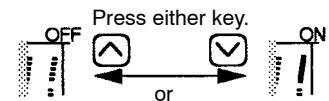

6) Repeat steps 4 and 5 as often as required.

7) Press to store the data.



Turning Bits ON and OFF

Memory switches use bits, not numbers, to select functions.

Sixteen bits are available (1 to 9 and A to E). Select the required functions by turning the appropriate bit ON (function ON) or OFF (function OFF).

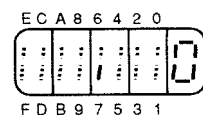

: = OFF
 | = ON

USING THE DIGITAL OPERATOR

4.1.5 Operation in User Constant Setting Mode cont.

- 8) Press  once more to display the user constant number again.





• Refer to *Appendix D List of User Constant Settings*.



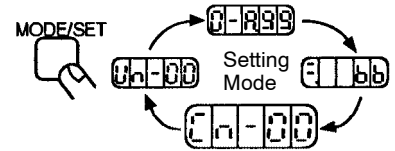

For JUSP-OP03A

- 1) Press  to select the user constant setting mode.



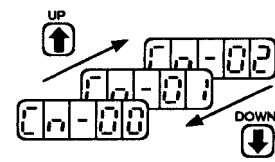

- 2) Press the  and  keys to select the user constant number to set.

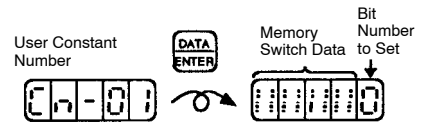

- 3) Press  to display the current data for the memory switch selected at step 2.



- 4) Press the  and  keys to select the bit number to set.

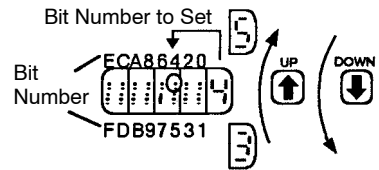



- 5) Press  to set the memory switch data ON or OFF for the bit number.

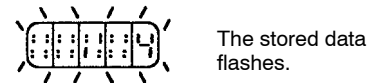

- 6) Repeat steps 4 and 5 as often as required.

- 7) Press  to store the data.



- 8) Press  once more to display the user constant number again.

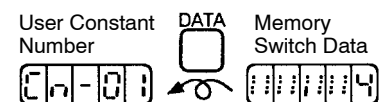

• Refer to *Appendix D List of User Constant Settings*

4.1.6 Operation in Monitor Mode

- 1) The monitor mode allows the reference values input into the Servopack, I/O signal status, and Servopack internal status to be monitored.
The monitor mode can be set during motor operation.

2) Using the Monitor Mode

The example below shows how to display 1500, the contents of monitor number Un-00.

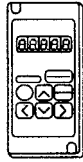



JUSP-OP02A-1

For JUSP-OP02A-1

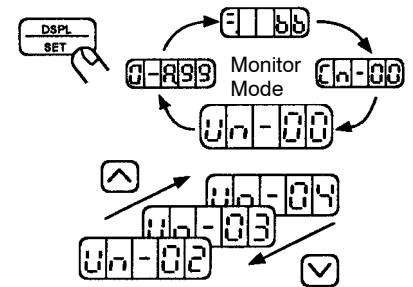
- 1) Press  to select the monitor mode



- 2) Press the  and  keys to select the monitor number to display.

- 3) Press  to display the data for the monitor number selected at step 2.



- 4) Press  once more to display the monitor number again.

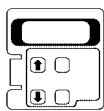



JUSP-OP03A

For JUSP-OP03A

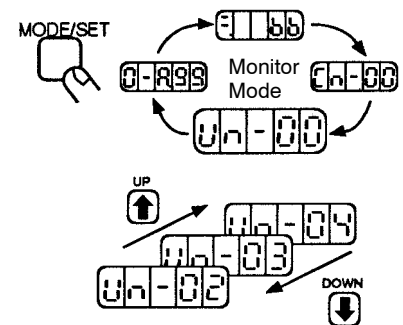
- 1) Press  to select the monitor mode.



- 2) Press the  and  keys to select the monitor number to display.

- 3) Press  to display the data for the monitor number selected at step 2.



- 4) Press  once more to display the monitor number again.



3) Keys to Monitor Mode Display are shown below. Note that the display differs between the speed/torque control (SGDA -□□□S) and position control (SGDA -□□□P) types.

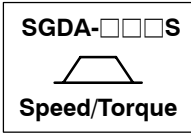

For Speed/Torque Control (SGDA -□□□S)

Monitor Number	Monitor Display
Un-00	Actual motor speed Units: r/min.
Un-01	Input speed reference Units: r/min.
Un-02	Internal torque reference Units: % (with respect to rated torque)
Un-03	Number of pulses from motor U-phase edge Units: pulses
Un-04	Electrical angle Units: deg
Un-05	Internal status bit display

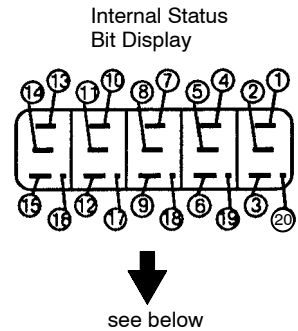

Bit #	Description	Related I/O Signal, User Constant
1	Servo alarm	1CN-34(ALM)
2	Dynamic brake ON	
3	Reverse rotation mode	Cn-02 Bit 0, 2CN-7(DIR)
4	During motor rotation or torque limit	1CN-9 ($\overline{\text{TG-ON}}$), status display mode
5	Speed coincidence	1CN-8 ($\overline{\text{V-CMP}}$), status display mode
6	Mode switch ON	
7	During forward current limit	Or contact input speed control 1CN-11 ($\overline{\text{P-CL}}$)
8	During reverse current limit	
9	Motor power ON	
10	A-phase	2CN-16(PA), 2CN-17(*PA)
11	B-phase	2CN-18(PB), 2CN-19(*PB)
12	C-phase	2CN-14(PC), 2CN-15(*PC)
13	U-phase	
14	V-phase	
15	W-phase	
16	Servo ON	1CN-14 ($\overline{\text{S-ON}}$), Cn-01 Bit 0
17	P operation, zero clamp, or rotation direction input	1CN-15 ($\overline{\text{P-CON}}$), Cn-01 Bit A, B, Cn-02 Bit 2
18	Forward overtravel	1CN-16 (P-OT), Cn-01 Bit 2
19	Reverse overtravel	1CN-17 (N-OT), Cn-01 Bit 3
20	SEN signal input	1CN-5 (SEN)

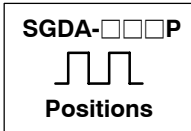

For Position Control (SGDA -□□□P)

Monitor Number	Monitor Display
Un-00	Actual motor speed Units:r/min.
Un-02	Internal torque reference Units: % (with respect to rated torque)
Un-03	Number of pulses from motor U-phase edge Units: pulses
Un-04	Electrical angle Units: deg
Un-05	Internal status bit display
Un-06	Internal status bit display
Un-07	Input reference pulse speed display Units: r/min.
Un-08	Positional error Units: x1 reference unit (Cn-02 Bit E = 0) x100 reference unit (Cn-02 Bit E = 1)
Un-09	Reference pulse count value 0 to 65535 Units: reference unit

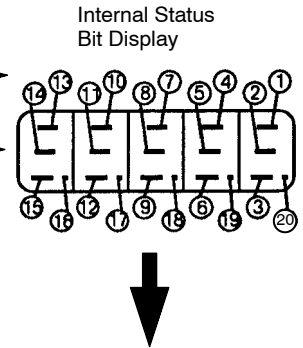

4

Monitor #	Bit #	Description	Related I/O Signal, User Constant	
Un-05	1	Servo alarm	1CN-34 (ALM)	
	2	Dynamic brake ON		
	3	Reverse rotation mode	Cn-02 Bit 0, 2CN-7 (DIR)	
	4	During motor rotation or current limit	1CN-9 (TGON), status display mode	
	5	Positioning complete	1CN-8 (COIN), status display mode	
	6	Mode switch ON		
	7	During forward current limit	Or contact input speed control	1CN-11 (P-CL)
	8	During reverse current limit		1CN-12 (N-CL)
	9	Motor power ON		
	10	A-phase	2CN-16(PA), 2CN-17(*PA)	
	11	B-phase	2CN-18(PB), 2CN-19(*PB)	
	12	C-phase	2CN-14(PC), 2CN-15(*PC)	
	13	U-phase		
	14	V-phase		
	15	W-phase		
	16	Servo ON	1CN-14 (S-ON), Cn-01 Bit 0	
	17	P operation or rotation direction input	1CN-15 (P-CON)	
	18	Forward overtravel	1CN-16 (P-OT), Cn-01 Bit 2	
	19	Reverse overtravel	1CN-17 (N-OT), Cn-01 Bit 3	
	20	Not used		

USING THE DIGITAL OPERATOR

4.1.6 Operation in Monitor Mode cont.

Monitor #	Bit #	Description	Related I/O Signal, User Constant
Un-06	1	Input reference pulse	1CN-1 (PLUS), 1CN-2(*PULS)
	2	Input pulse sign	1CN-3(SIGN), 1CN-4 (*SIGN)
	3	Error counter clear input	1CN-5 ($\overline{\text{CLR}}$), 1CN-6(*CLR)
	4 to 20	Not used	

4.2 Using the Functions

This section describes how to use the basic operations described in section 1 to operate and adjust the motor.

4.2.1	Operation in Alarm Trace-back Mode	183
4.2.2	Operation Using the Digital Operator	186
4.2.3	Autotuning	189
4.2.4	Reference Offset Automatic Adjustment	196
4.2.5	Speed Reference Offset Manual Adjustment Mode	199
4.2.6	Clearing Alarm Trace-back Data	202
4.2.7	Checking Motor Type	203
4.2.8	Checking Software Version	204

4.2.1 Operation in Alarm Trace-back Mode

- 1) The alarm trace-back mode displays up to ten alarms which occurred previously. By allowing confirmation of what alarm occurred when, it is a useful aid to speed up troubleshooting.

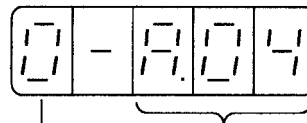

Alarm Sequence Number
The higher the number,
the older the alarm data

Alarm Code

See the table of
alarms on page 185.

NOTE The alarm trace-back data is not cleared on alarm reset or when the Servopack power is turned OFF. This does not adversely affect operation. The data is cleared using the special mode: Clear alarm trace-back data. Refer to sub-section 4.2.6 for details.

2) Using the Alarm Trace-back Mode

Follow the procedure below to determine which alarms occurred previously.

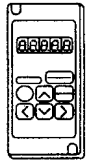

JUSP-OP02A-1

For JUSP-OP02A-1

- 1) Press to select the alarm trace-back mode.

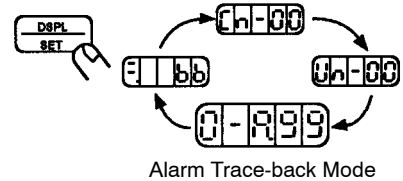

- 2) Press the and keys to scroll the alarm sequence numbers up and down and display information on previous alarms. The higher the left-hand digit (alarm sequence number), the older the alarm data.

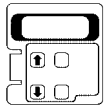
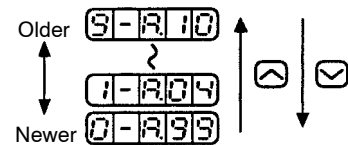

JUSP-OP03A

For JUSP-OP03A

- 1) Press to select the alarm trace-back mode.

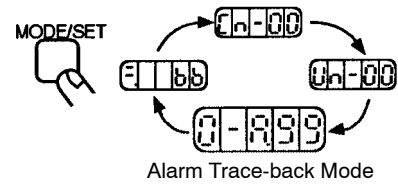

- 2) Press the and keys to scroll the alarm sequence numbers up and down and display information on previous alarms. The higher the left-hand digit (alarm sequence number), the older the alarm data.

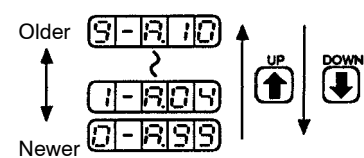

3) The table below lists the alarms displayed in the alarm trace-back mode.

Displayed Alarm Code	Description
R00	Absolute data error
R02	User constant breakdown
R04	User constant setting error
R10	Overcurrent
R31	Position error pulse overflow (for position control only)
R40	Overvoltage
R51	Overspeed
R70	Overload
R80	Absolute encoder error
R81	Absolute encoder back-up error
R82	Absolute encoder checksum error
R83	Absolute encoder battery error
R84	Absolute encoder data error
R85	Absolute encoder overspeed
Rb1	Reference input read error
Rc1	Servo overrun detected *
Rc2	Encoder output phase error
Rc3	Encoder A-, B-phase disconnection
Rc4	Encoder C-phase disconnection
Rf3	Power loss error (detected if power reconnected within power holding time)
R99	Not an alarm. Reset by alarm reset or Servopack power ON.

* This function prevents overrun.

The following are operator-related alarms which are not recorded by alarm trace-back.

CPFD0	Digital Operator transmission error 1
CPFD1	Digital Operator transmission error 2

- Refer to the troubleshooting procedures when an alarm occurs, described in section 6.2.

4.2.2 Operation Using the Digital Operator



Simple Motor Check

Operation from the Digital Operator allows the Servopack to run the motor. This allows rapid checking of basic operations during machine set-up and testing, without the trouble of connecting a host controller.

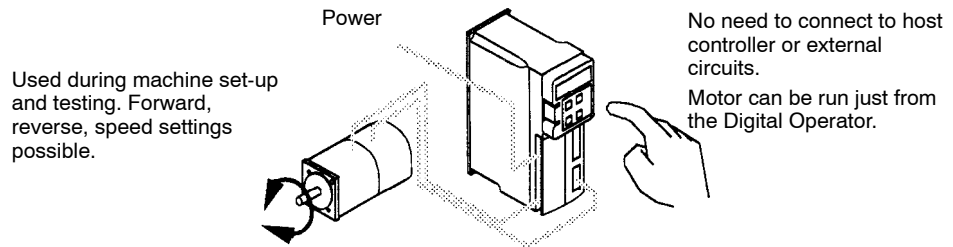

1) Operation Using the Digital Operator

Use the following procedure to operate the motor from the Digital Operator



For JUSP-OP02A-1

- 1) Press to select the user constant setting mode.

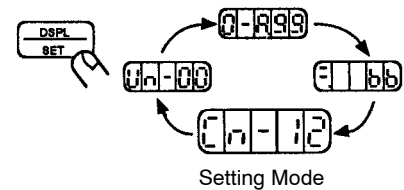

- 2) Select the user constant number Cn-00. (User constant Cn-00 is selected when the power is turned ON.)

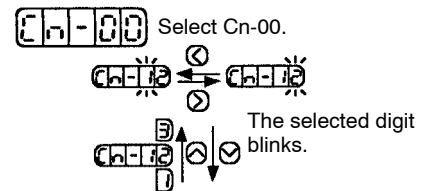



Press the and keys to select the digit.

Press the and keys to change the value.

- 3) Press  to display the current data for the user constant Cn-00.



- 4) Press the  and  keys to change the data to 00.
(This user constant is set to 00 when the power is turned ON.)

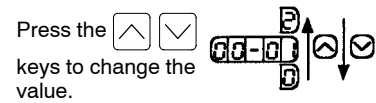

- 5) Press  to set the Digital Operator in operation mode. Operation is now possible under Digital Operator control.

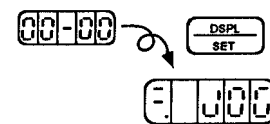

Display for operation mode from Digital Operator

- 6) Press  to set the servo ON status (motor power turned ON).

Select Servo ON/Servo OFF

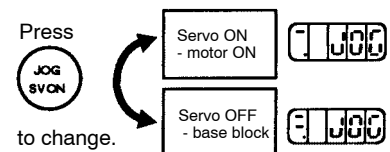

- 7) Press the  and  keys to operate the motor.

Motor Forward/Reverse Rotation

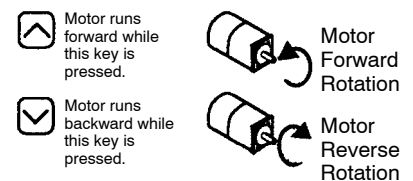

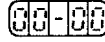
- 8) Press  to revert to . This sets the servo OFF status (motor power turned OFF).

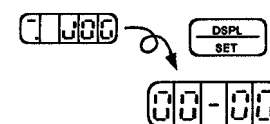

(Alternatively, press  to set the servo OFF status.)

- 9) Press  to return to the setting mode display. This disables operation under Digital Operator control.

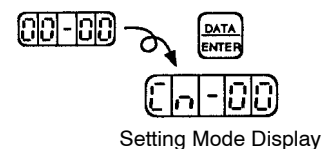

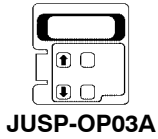

For JUSP-OP03A

1) Press ^{MODE/SET} to select the user constant setting mode.

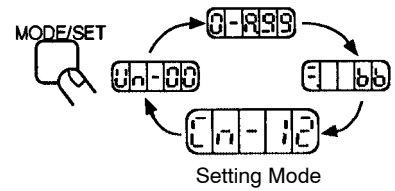

2) Press the ^{UP} and ^{DOWN} keys to select the user constant number Cn-00.
(User constant Cn-00 is selected when the power is turned ON.)

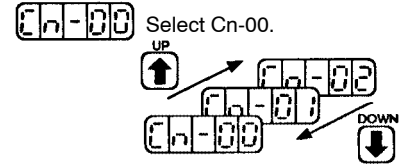

3) Press ^{DATA} to display the current data for the user constant Cn-00.



4) Press the ^{UP} and ^{DOWN} keys to change the data to 00.
(This user constant is set to 00 when the power is turned ON.)

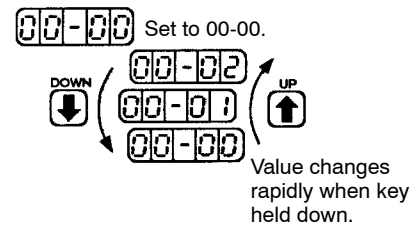

5) Press ^{MODE/SET} to set the Digital Operator in operation mode. Operation is now possible under Digital Operator control.

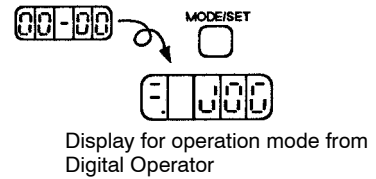

6) Press ^{DATA} to set the servo ON status (motor power turned ON).

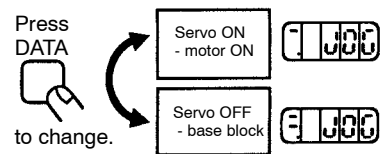

Select Servo ON/Servo OFF

7) Press the ^{UP} and ^{DOWN} keys to operate the motor.

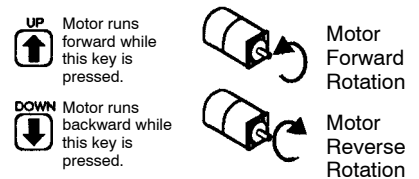

Motor Forward/Reverse Rotation

8) Press ^{MODE/SET} to revert to . This sets the servo OFF status (motor power turned OFF).

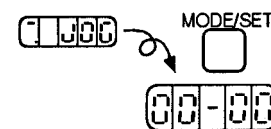

(Alternatively, press ^{DATA} to set the servo OFF status.)

- 9) Press  to return to the setting mode display. This disables operation under Digital Operator control.

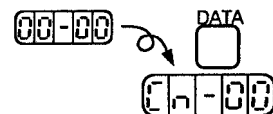

Setting Mode Display

2) Changing Motor Speed

The motor speed for operation under Digital Operator control can be changed with a following user constant.

User Constant: Cn-10 (JOGSPD), Units: r/min., Standard setting: 500

For details about setting the motor speed, refer to 4.1.5 Operation in User Constant Setting Mode and Appendix D List of User Constants.

4.2.3 Autotuning



No experience required to achieve optimum settings.

The Servopack contains a built-in autotuning function to automatically measure the machine characteristics and set the user constants.

Servo drives normally require tuning to match the machine configuration and rigidity. This tuning requires a great deal of experience and is difficult for a person unfamiliar with the tuning procedure.

However, autotuning allows even totally inexperienced people to easily complete the tuning.

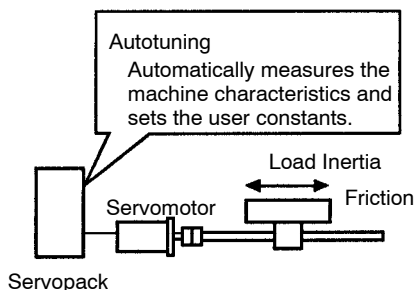

Autotuning is similar to auto-focus for a camera.

1) User Constants Automatically Settable with Autotuning

SGDA-□□□ S



Speed/Torque

Speed/torque control
(SGDA-□□□S)

SGDA-□□□ P



Positions

Position control
(SGDA-□□□P)

Cn-04	Speed loop gain
Cn-05	Speed loop integration time constant

Cn-04	Speed loop gain
Cn-05	Speed loop integration time constant
Cn-1A	Position loop gain

Once autotuning has been completed, the autotuning procedure can be omitted for subsequent machines, providing the machine specifications remain unchanged. It is sufficient to directly set the user constants for subsequent machines. The **machine rigidity** can be selected from one of seven levels.

- NOTE**
- Conduct autotuning with the motor attached to the machine. Make sure that the machine is ready for operation and take sufficient safety precautions when operating the machine.
 - Make sure that the $\overline{P-CON}$ signal is OFF (PI control is selected) before starting autotuning.
 - Make sure that the speed control mode is set to PI control before starting autotuning. If the mode switch is used, PI control automatically switches to P control above a set operating level (PI control to P control switching level), even if the $\overline{P-CON}$ signal is OFF. If the mode switch is used, follow operation a) or operation b) below before starting autotuning.
 - a) Set the user constants to disable the mode switch.
 Speed control (SGDA-□□S): Set both Cn-01 Bit C and Bit D to 1.
 Position control (SGDA-□□P): Set both Cn-01 Bit B to 1.
 - b) Increase the operating level, such that P control is not selected. In practice, set the operating level as shown in the table below.

Operating Level	User Constant Setting
Torque reference	Cn-0C to maximum torque
Speed reference	Cn-0D to a preset value exceeding Cn-10
Acceleration	Cn-0E to the maximum value: 3000
Error pulse	Cn-0F to the maximum value: 10000

Select the operating level using Bit C and Bit D of Cn-01.

Refer to 3.6.6 for details of the mode switch function.



Machine Rigidity

The machine rigidity is one of the machine characteristics related to servo control. Set the servo to high response for a machine, such as a machine tool, with high rigidity, and to low response for a machine, such as a robot, with low rigidity.

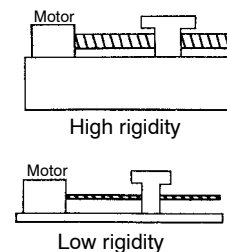

2) Using Autotuning

Follow the procedure below to run autotuning.



JUSP-OP02A-1

For JUSP-OP02A-1

- 1) Press to select the user constant setting mode.

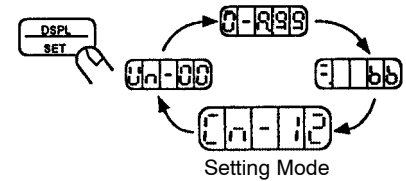

- 2) Select the user constant number Cn-00. (User constant Cn-00 is selected when the power is turned ON.)

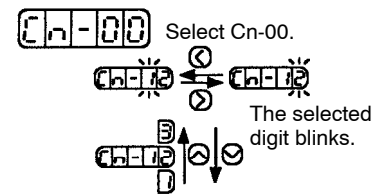

Press the and keys to select the digit.

Press the and keys to change the value.

- 3) Press to display the current data for the user constant Cn-00.

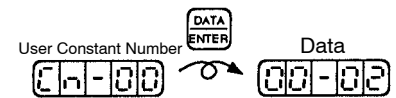

- 4) Press the and keys to change the data to 05.

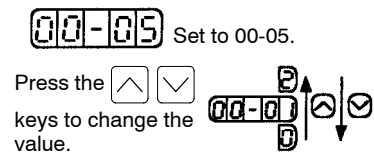

- 5) Press to display the machine rigidity.

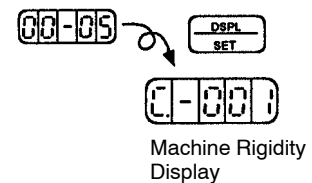

- 6) Press the and keys to select the machine rigidity. If the actual rigidity is unknown, select medium rigidity.

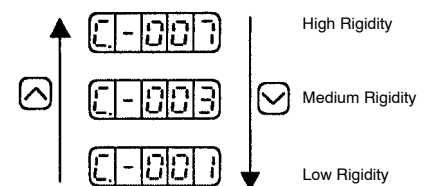

- 7) Press to select autotuning mode.

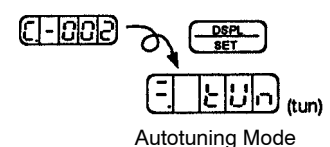

- 8) Press  to set the servo ON status.

Select Servo ON/Servo OFF

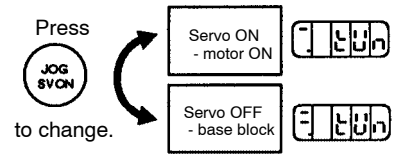

- 9) Press the  and  keys to operate the motor.

Motor Forward/Reverse Rotation

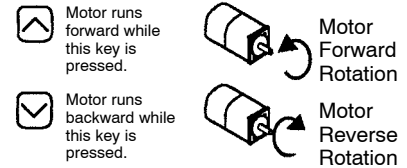

- 10) When autotuning is complete, the END message is displayed, as shown to the right.
Servo OFF status is automatically selected. If Servo ON/Servo OFF is selected by a signal from an external contact, turn this signal OFF.



- 11) Release the  and  keys to revert to the 00-09 display.



- 12) Press  to return to the setting mode display. This ends the autotuning operation.

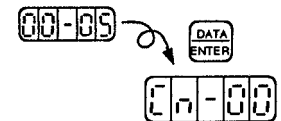

Setting Mode Display



• Refer to sub-section 3) on page 194 for the precautions relating to autotuning.



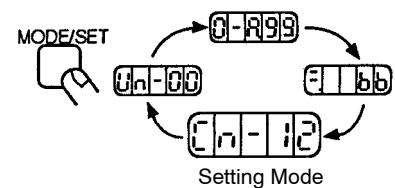

For JUSP-OP03A

- 1) Press  to select the user constant setting mode.

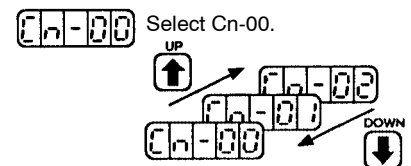

- 2) Press the  and  keys to select the user constant number Cn-00.
(User constant Cn-00 is selected when the power is turned ON.)



- 3) Press  to display the current data for the user constant Cn-00.

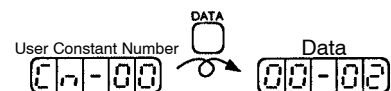

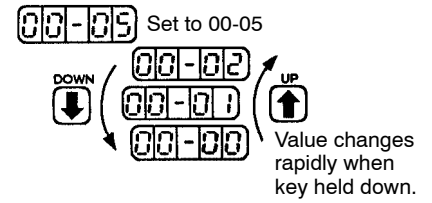

- 4) Press the  and  keys to change the data to 05.

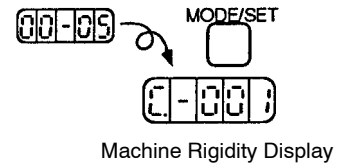

- 5) Press  to display the machine rigidity.



- 6) Press the  and  keys to select the machine rigidity.

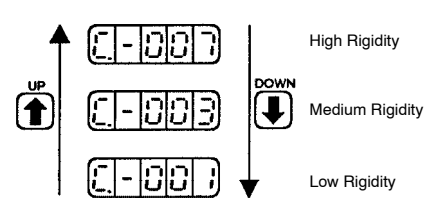

- 7) Press  to select autotuning mode.

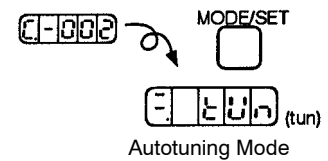

- 8) Press  to set the servo ON status.

Select Servo ON/Servo OFF

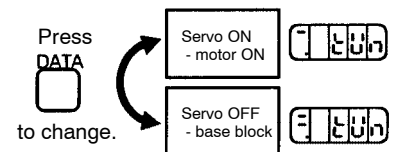

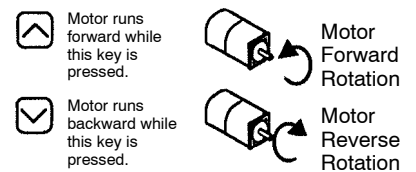

- 9) Press the  and  keys to operate the motor.

Motor Forward/Reverse Rotation



- 10) When autotuning is complete, the END message is displayed, as shown to the right.
Servo OFF status is automatically selected. If Servo ON/Servo OFF is selected by a signal from an external contact, turn this signal OFF.



11) Release the  and  keys to revert to the  display.



12) Press  to return to the setting mode display. This ends autotuning operation.

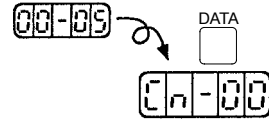





Setting Mode Display

- Refer to the following sub-section 3) for the precautions relating to autotuning.

3) Precautions Relating to Autotuning

a) Speed Setting During Autotuning

The motor speed during autotuning is set by user constant Cn-10. Set to 500 r/min., which is the factory setting. Autotuning may be unsuccessful if this value is set too low.

The motor runs intermittently while the  or  (or  or ) key is held down. The motor does not rotate continuously.

b) Machine Rigidity Selection







Select the machine rigidity as described below. If the actual rigidity is unknown, select medium rigidity.

 High Rigidity

 Medium Rigidity



 Low Rigidity

- If the Machine Resonates

At servo ON when the  (or ) key is pressed or when the motor is operated by pressing the  or  ( or ) key, machine resonance indicates an inappropriate machine rigidity setting.

Follow the procedure below to correct the machine rigidity setting, and run autotuning once more.



(1) Press the  (or ) key to cancel autotuning.

(2) Press the  (or ) key once more to enter the machine rigidity setting mode. Reduce the setting by one.

- If Autotuning Does Not End

Failure of autotuning to end (E1E2E3E4), is caused by an inappropriate machine rigidity setting. Follow the procedure below to correct the machine rigidity setting, and run autotuning once more.

(1) Press the  (or ) key to cancel autotuning.

(2) Press the  (or ) key once more to enter the machine rigidity setting mode. Increase the setting by one.

Autotuning may not end for machines with large play or extremely low rigidity. In these cases, use conventional manual adjustment.

c) Input Signals

- The OT signal and SEN signal (absolute encoder only) are enabled during autotuning. Input the OT signal and SEN signal (absolute encoder only) during autotuning. To conduct autotuning without inputting these signals, set user constant Cn-01 Bits 1, 2, and 3 to 1.

- Autotuning is not possible during overtravel (P-OT or N-OT signal OFF).

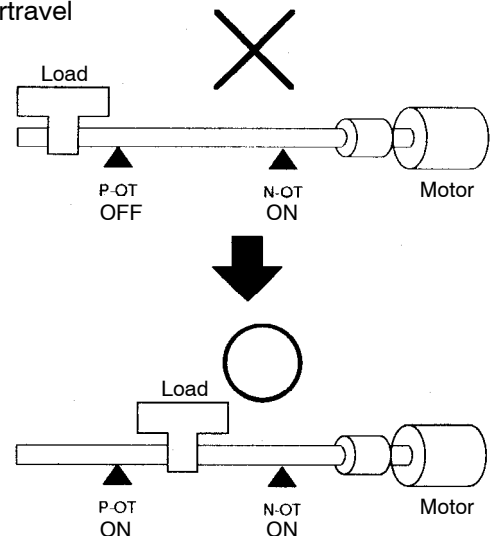

- Conduct autotuning when no overtravel has occurred (both P-OT and N-OT signal ON).

- Set the $\overline{\text{P-CON}}$ signal OFF during autotuning.

- If the mode switch is used, take one of the steps below before running autotuning.

(1) Cancel the mode switch.

(2) Set the mode switch operating level to a high level.

Refer to page 118 for details about setting the mode switch.

- If using the $\overline{S-ON}$ signal to set the servo ON status, display $\boxed{-} \boxed{E} \boxed{n} \boxed{0}$ before turning ON the $\overline{S-ON}$ signal.

4.2.4 Reference Offset Automatic Adjustment

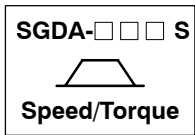

1) Why Does Reference Offset Occur?

Using a speed/torque control (SGDA-□□□S) type, the motor may rotate slowly when the reference voltage is intended to be 0 V.

This occurs when the host controller or external circuit has a small offset (measured in mV) in the reference voltage.



Automatic Adjustment of Reference Voltage

The reference offset automatic adjustment mode automatically measures the offset and adjusts the reference voltage. It adjusts both speed and torque references.

The following diagram illustrates automatic adjustment of an offset in the reference voltage from the host controller or external circuit.

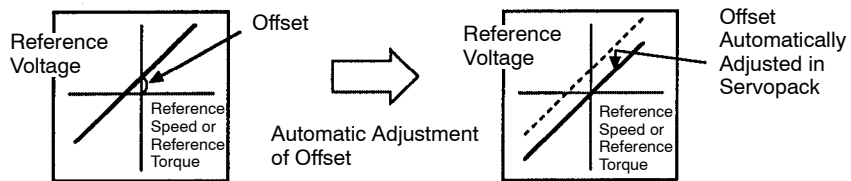

2) After completion of offset automatic adjustment, the amount of offset is stored in the Servopack.

The amount of offset can be checked in the speed reference offset manual adjustment mode. Refer to sub-section 4.2.5 for details.

3) Using the Reference Offset Automatic Adjustment Mode

Follow the procedure below to automatically adjust the reference offset.



JUSP-OP02A-1

For JUSP-OP02A-1

- 1) Follow the procedure below to set the motor into operating mode.

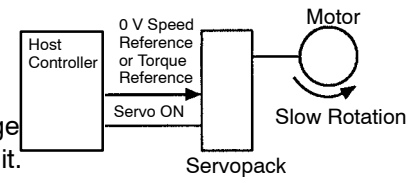

- (1) Input the (intended) 0 V reference voltage from the host controller or external circuit.

- (2) Then, turn ON the servo ON (1CN-14, S-ON) signal.

- 2) Press to select the user constant setting mode.

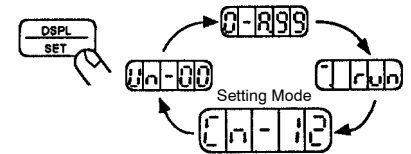

- 3) Select the user constant number Cn-00. (User constant Cn-00 is selected when the power is turned ON.)

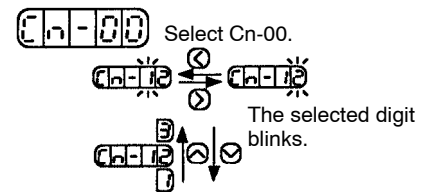

Press the and keys to select the digit.

Press the and keys to change the value.

- 4) Press to display the current data for the user constant Cn-00.

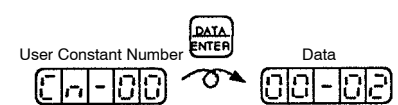

- 5) Press the and keys to change the data to 01.

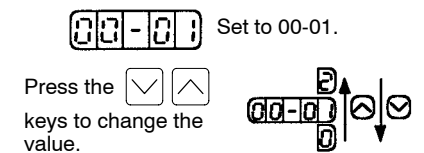

- 6) Press to automatically adjust the reference offset. The motor rotation stops.

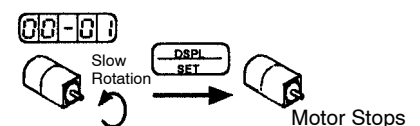

- 7) Press to return to the setting mode display. This ends reference offset automatic adjustment.

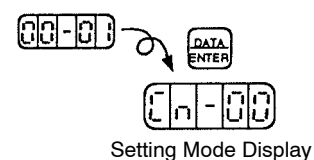

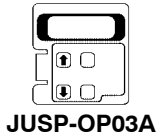

For JUSP-OP03A

1) Follow the procedure below to set the motor into operating mode.

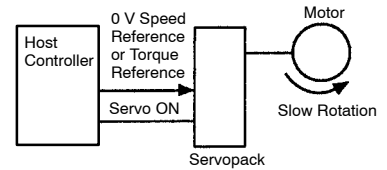

(1) Input the (intended) 0V reference voltage from the host controller or external circuit.

(2) Then, turn ON the servo ON (1CN-14, $\overline{S-ON}$) signal.

2) Press MODE/SET to select the user constant setting mode.

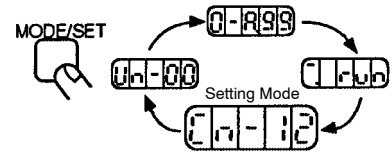

3) Press the UP and DOWN keys to select the user constant number Cn-00. (User constant Cn-00 is selected when the power is turned ON.)

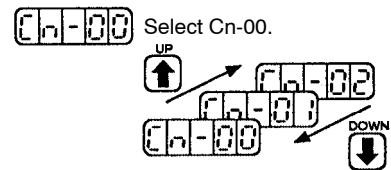

4) Press DATA to display the current data for the user constant Cn-00.

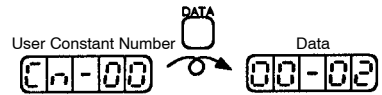

5) Press the UP and DOWN keys to change the data to 01.

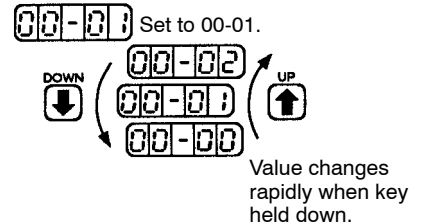

6) Press MODE/SET to automatically adjust the reference offset. The motor rotation stops.

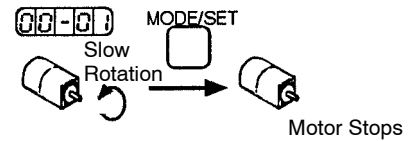

7) Press DATA to return to the setting mode display. This ends reference offset automatic adjustment.

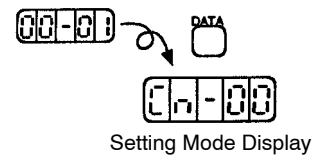

4

- 4) **The reference offset automatic adjustment mode cannot be used** where a position loop is formed with the host controller and the error pulses are zeroed when servo lock is stopped.

In this case, use the speed reference offset manual adjustment mode. Refer to sub-section 4.2.5 for details.

Zero-clamp speed control is available to force the motor to stop during zero speed reference. Refer to sub-section 3.4.3 for details.

4.2.5 Speed Reference Offset Manual Adjustment Mode

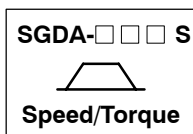

- 1) Speed reference offset manual adjustment is available for the speed/torque control (SGDA-□□□S) type.

It is very convenient in the following situations:

- If a position loop is formed with the host controller and the error pulses are zeroed when servo lock is stopped.
- To deliberately set the offset to some value.

This mode can also be used to check the data set in the reference offset automatic adjustment mode.

In principle, this mode operates in the same way as the reference offset automatic adjustment mode, except that the amount of offset is directly input during the adjustment.

The offset can be set for speed references only.

Offset Adjustment Range and Setting Units are as follows:

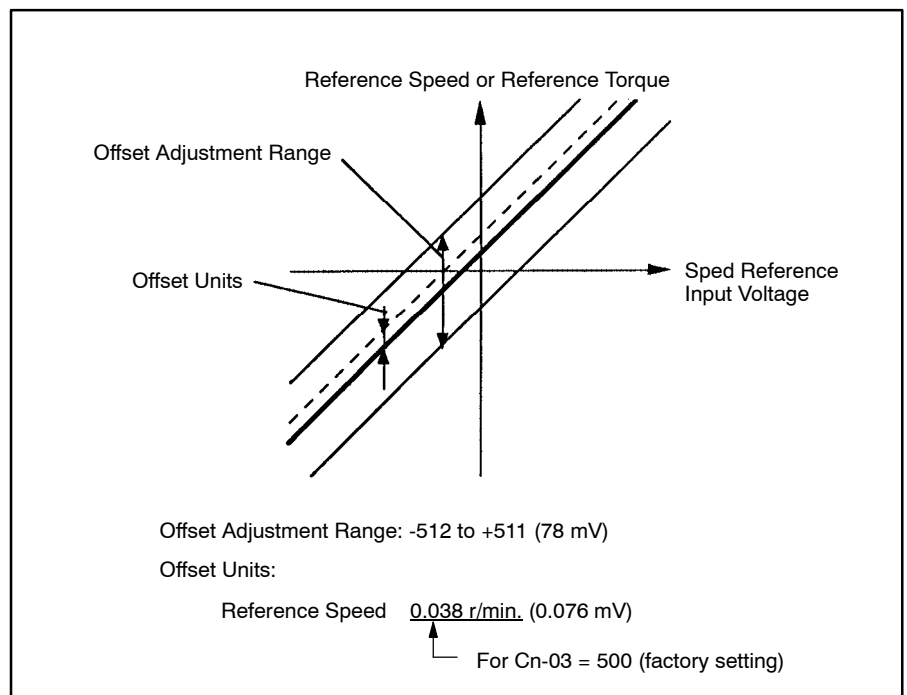

2) Follow the procedure below to manually adjust the reference voltage.

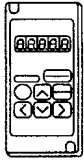

JUSP-OP02A-1

For JUSP-OP02A-1

1) Press to select the user constant setting mode.

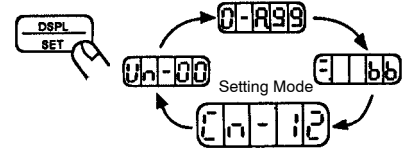

2) Select the user constant number Cn-00. (User constant Cn-00 is selected when the power is turned ON.)

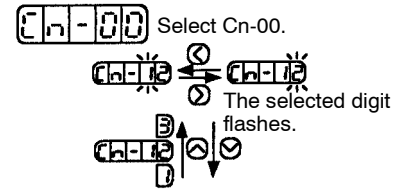

Press the and keys to select the digit.

Press and keys to change the value.

3) Press to display the current data for the user constant Cn-00.

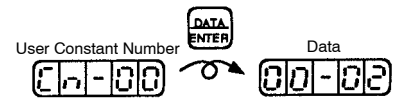

4) Press the and keys to change the data to 03.

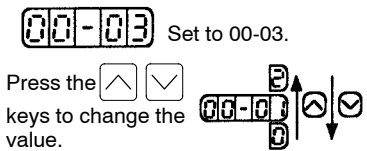

5) Press to select the speed reference offset manual adjustment mode.

(The amount of speed reference offset is displayed.)

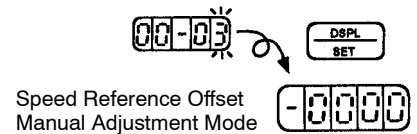

6) Press the and keys to adjust the amount of offset.

(Adjust the speed references.)

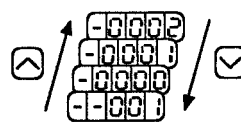

7) Press to return to the user constant data display.

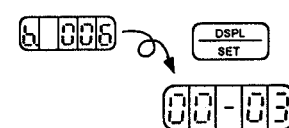

8) Press to return to the setting mode display. This ends the reference offset manual adjustment.

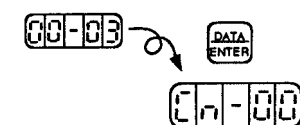

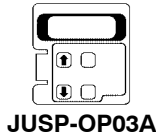

Setting Mode Display



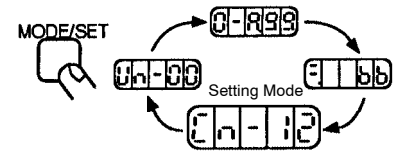

For JUSP-OP03A

- 1) Press  to select the user constant setting mode.

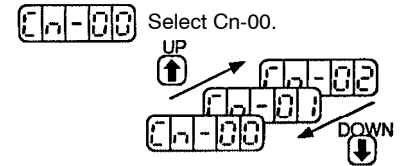

- 2) Press the  and  keys to select the user constant number Cn-00.
(User constant Cn-00 is selected when the power is turned ON.)



- 3) Press  to display the current data for the user constant Cn-00.

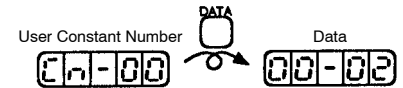

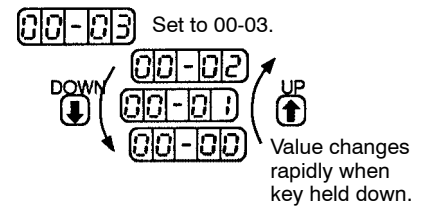

- 4) Press the  and  keys to change the data to 03.

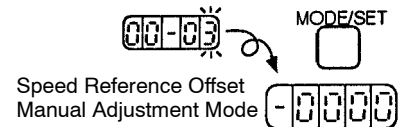

- 5) Press  to select the speed reference offset manual adjustment mode.
(The amount of speed reference offset is displayed.)



- 6) Press the  and  keys to adjust the amount of offset.
(Adjust the speed references.)

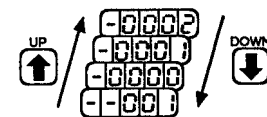

- 7) Press  to return to the user constant data display.

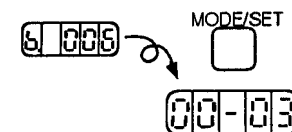

- 8) Press  to return to the setting mode display. This ends the reference offset manual adjustment.

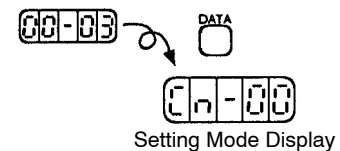

4.2.6 Clearing Alarm Trace-back Data

- 1) This procedure clears the alarm history, which stores the alarms occurring in the Servo-pack. Each alarm in the alarm history is set to A99, which is not an alarm code. Refer to 4.2.1 Operation in Alarm Trace-back Mode for details.
- 2) Follow the procedure below to clear the alarm trace-back data.

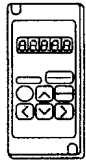

JUSP-OP02A-1

For JUSP-OP02A-1

- 1) Press to select the user constant setting mode.

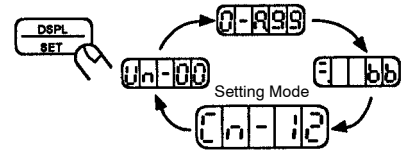

- 2) Select the user constant number Cn-00. (User constant Cn-00 is selected when the power is turned ON.)

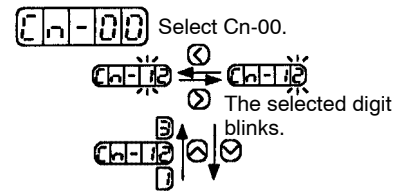

Press the and keys to select the digit.

Press the and keys to change the value.

- 3) Press to display the current data for the user constant Cn-00.

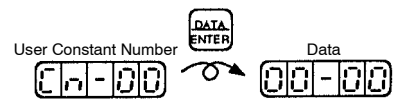

- 4) Press the and keys to change the data to 02.

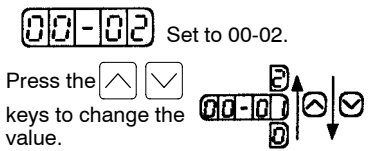

- 5) Press to clear the alarm trace-back data.



- 6) Press to return to the user constant data display.

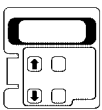
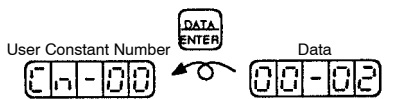



JUSP-OP03A

For JUSP-OP03A

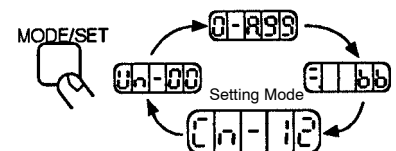
- 1) Press to select the user constant setting mode.



- 2) Press the  and  keys to select the user constant number Cn-00.
(User constant Cn-00 is selected when the power is turned ON.)

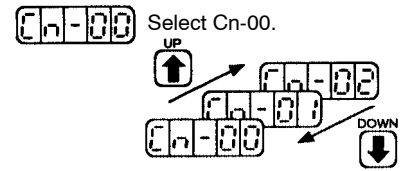

- 3) Press  to display the current data for the user constant Cn-00.

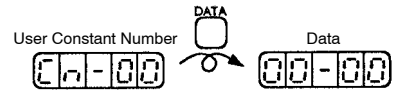

- 4) Press the  and  keys to change the data to 02.

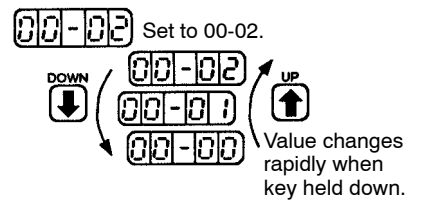

- 5) Press  to clear the alarm trace-back data.



Clear the alarm trace-back data.

- 6) Press  to return to the user constant data display.

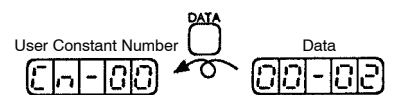

4.2.7 Checking Motor Type

Set Cn-00 to 00-04 to select the motor-type check mode.
This mode is used for maintenance and is not normally used by the customer.

Operation

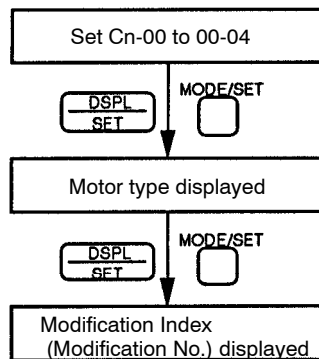

Motor Type Display

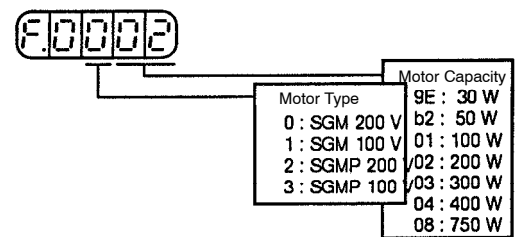

Modification Index (Modification No.) Display



$$\textcircled{1} \times 16^3 + \textcircled{2} \times 16^2 + \textcircled{3} \times 16 + \textcircled{4} = \text{Modification index (Modification No.)}$$

4.2.8 Checking Software Version

- 1) Set Cn-00 to 00-06 to select the software-version check mode.
This mode is used for maintenance and is not normally used by the customer.

Operation

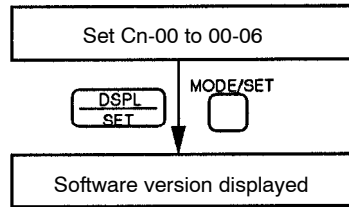

Software Version Display

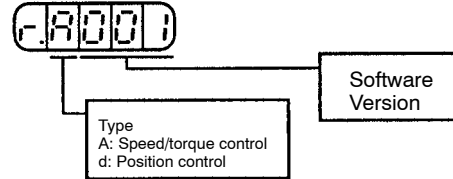

SERVO SELECTION AND DATA SHEETS

5

This chapter describes how to select Σ -Series servo drives and peripheral devices.

The section also presents the specifications and dimensional drawings required for selection and design.

Choose and carefully read the relevant sections of this chapter.

5.1	Selecting a Σ-Series Servo	207
5.1.1	Selecting a Servomotor	207
5.1.2	Selecting a Servopack	213
5.1.3	Selecting a Digital Operator	215
5.2	SGM Servomotor	217
5.2.1	Ratings and Specifications	217
5.2.2	Mechanical Characteristics	232
5.3	Servopack Ratings and Specifications	235
5.3.1	Ratings and Specifications	235
5.3.2	Overload Characteristics	240
5.3.3	Starting Time and Stopping Time	241
5.3.4	Load Inertia	241
5.3.5	Overhanging Loads	244
5.3.6	In-rush Current and Power Loss	245
5.4	Σ-Series Dimensional Drawings	246
5.4.1	Servomotor Dimensional Drawings	246
5.4.2	Servopack Dimensional Drawings	289
5.4.3	Digital Operator Dimensional Drawings	291
5.5	Selecting Peripheral Devices	293
5.5.1	Selecting Peripheral Devices	293
5.5.2	Order List	299

5.6	Specifications and Dimensional Drawings of Peripheral Devices	308
5.6.1	Cable Specifications and Peripheral Devices	308
5.6.2	Motor Cables	311
5.6.3	Connector Kits	314
5.6.4	Brake Power Supply	318
5.6.5	Encoder Cables	320
5.6.6	Battery for Absolute Encoder	325
5.6.7	1CN Connector	326
5.6.8	Connector Terminal Block Converter Unit	328
5.6.9	Cable With 1CN Connector and One End Without Connector	330
5.6.10	Circuit Breaker	330
5.6.11	Noise Filter	331
5.6.12	Magnetic Contactor	332
5.6.13	Surge Suppressor	333
5.6.14	Regenerative Unit	334
5.6.15	Variable Resistor for Speed Setting	335
5.6.16	Encoder Signal Converter Unit	336
5.6.17	Cables for Connecting PC and Servopack	338

5.1 Selecting a Σ -Series Servo

This section describes how to select the Σ -Series Servomotor, Servopack, and Digital Operator.

5.1.1	Selecting a Servomotor	207
5.1.2	Selecting a Servopack	213
5.1.3	Selecting a Digital Operator	215

5.1.1 Selecting a Servomotor

- 1) The selection of an SGM or SGMP Servomotor matched to the servo system in which it is used is based on the servomotor type, that is, the seven alphanumeric characters after “SGM-” or “SGMP-”, described below. The numbers (1) to (6) below correspond to the numbers in the flowchart for Servomotor selection on the following pages.

SGM- 01 A 3 1 2 □

- Σ-Series
- SGM: SGM Servomotor
- SGMP: SGMP Servomotor (cube type)
- 1) Rated output (motor capacity) (Type SGM only)
 A3: 30W (0.04HP) A5: 50W (0.07HP)
 (Types SGM and SGMP)
 01: 100W (0.13HP) 02: 200W (0.27HP)
 03: 300W (0.40HP) 04: 400W (0.53HP)
 08: 750W (1.01HP)
- 2) Supply voltage
 A: 200V B: 100V
- 3) Encoder specification
 3: 2048 P/R incremental encoder
 W: 12-bit absolute encoder (Available upon special request)
 S: 15-bit absolute encoder
 5: 2000 P/R incremental encoder
- 4) Design revision order
- 5) Shaft specification
 2: Straight without key
 4: Straight with key
 6: Straight with key, shaft end screw hole provided
- 6) Options
 B: with brake S: with shaft seal
 D: with brake and shaft seal
 P: drip-proofed

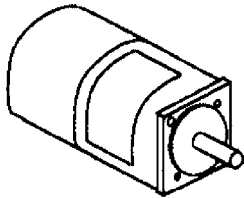

SGM type

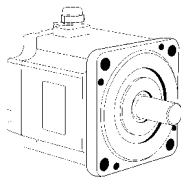

SGMP type

Flowchart for Servomotor selection

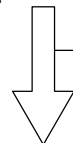

	Selected motor type
Example	SGM- [0][2][B][W][1][4][B]
Axis 1	SGM-□□□□□□□□
Axis 2	SGM-□□□□□□□□
• • •	• • • • • • • •

2) The actual selection of the SGM or SGMP Servomotor is conducted according to the flowchart in the next page.

If an SGMP Servomotor is selected, replace SGM with SGMP. SGMP Servomotors are available from 100W (0.13HP) to 750W (1.01HP). A 1500W (2.01HP) type also exists but the SGDA Servopack can handle up to 750W (1.01HP).

Flowchart for Servomotor Selection

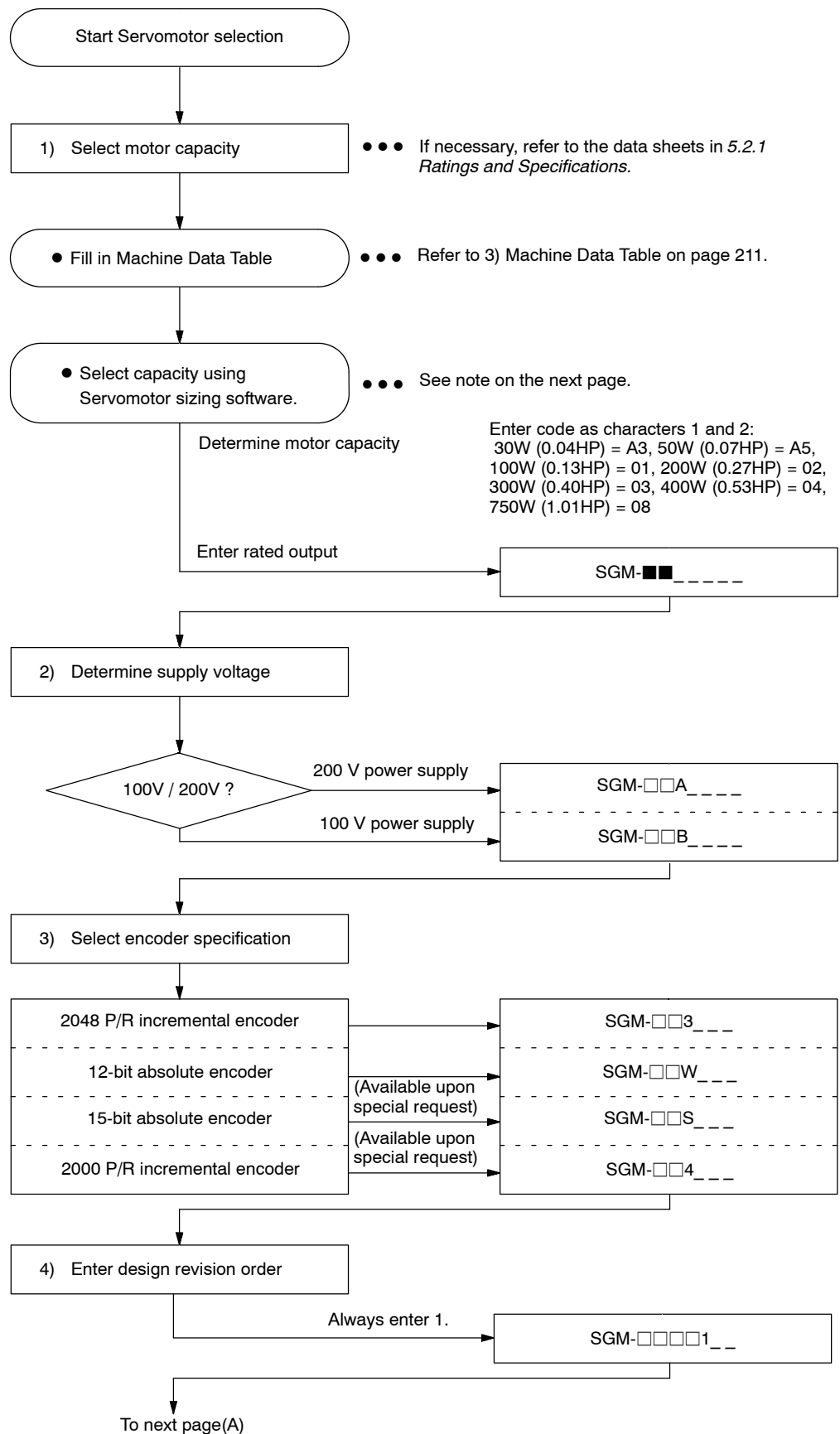

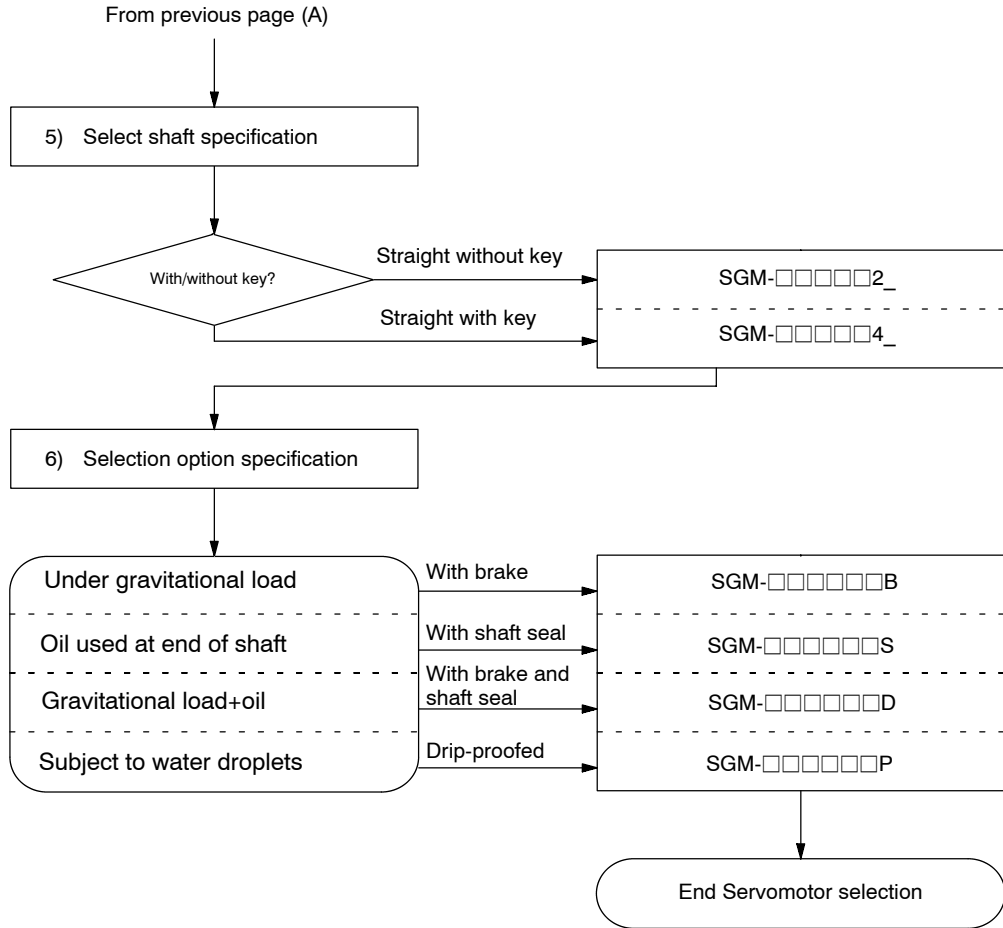

Note Consult Yaskawa sales representative for sizing or sizing software.

3) Machine Data Table

Fill out the machine data table below as an aid to selecting the drive system. When the machine data table is complete, use the servomotor sizing software to select the motor capacity.

1) Ball Screw Horizontal Axis			
Load mass	W	—kg (lb)	
Thrust	F	—kg (lb)	
Coefficient of friction	μ	—	
Overall efficiency	η	—	
Gear ratio	R (= Nm/Nl)	—	
Gear+coupling	GD ² g	—kg·cm ² (lb·in ² .)	
Ball screw pitch	P	—mm (in.)	
Ball screw diameter	D	—mm (in.)	
Ball screw length	L	—mm (in.)	
2) Ball Screw Vertical Axis			
Load mass	W ₁	—kg (lb)	
Counterweight	W ₂	—kg (lb)	
Coefficient of friction	μ	—	
Overall efficiency	η	—	
Gear ratio	R (= Nm/Nl)	—	
Gear+coupling	GD ² g	—kg·cm ² (lb·in ² .)	
Ball screw pitch	P	—mm (in.)	
Ball screw diameter	D	—mm (in.)	
Ball screw length	L	—mm (in.)	
3) Timing Belt			
Load mass	W	—kg (lb)	
Thrust	F	—kg (lb)	
Coefficient of friction	μ	—	
Overall efficiency	η	—	
Gear ratio	R (= Nm/Nl)	—	
Gear+coupling	GD ² g	—kg·cm ² (lb·in ² .)	
Pulley	GD ² d	—kg·cm ² (lb·in ² .)	
Pulley diameter	D	—mm (in.)	
4) Rack and Pinion			
Load mass	W	—kg (lb)	
Thrust	F	—kg (lb)	
Coefficient of friction	μ	—	
Overall efficiency	η	—	
Gear ratio	R (= Nm/Nl)	—	
Gear+coupling	GD ² g	—kg·cm ² (lb·in ² .)	
Pinion diameter	D	—mm (in.)	
Pinion thickness	t	—mm (in.)	

SERVO SELECTION AND DATA SHEETS

5.1.1 Selecting a Servomotor cont.

5) Roll Feeder			
Load GD^2	$GD^2\ell$	—kg·cm ² (lb·in ² .)	
Tension	F	—kg (lb)	
Press force	P	—kg (lb)	
Roller diameter	D	—mm (in.)	
Coefficient of friction	μ	—	
Overall efficiency	η	—	
Gear ratio	R (= Nm/NI)	—	
Gear+coupling	GD^2g	—kg·cm ² (lb·in ² .)	
6) Rotor			
Load GD^2	$GD^2\ell$	—kg·cm ² (lb·in ² .)	
Load torque	$T\ell$	—kg·cm ² (lb·in ² .)	
Overall efficiency	η	—	
Gear ratio	R (= Nm/NI)	—	
Gear+coupling	GD^2g	—kg·cm ² (lb·in ² .)	
7) Others			
Load GD^2	$GD^2\ell$	—kg·cm ² (lb·in ² .)	
Load torque	$T\ell$	—kg·cm ² (lb·in ² .)	
Motor speed	Nm	—r/min	
DUTY	t_d	—s	
Positioning time	t_s	—s	
Accel/decel time	t_a	—s	
● Duty cycle			
DUTY	t_d	—s	
Positioning distance	L_s	—mm (in.)	
Moving member speed	$v\ell$	—m/min	
Positioning time	t_s	—s	
Accel/decel time	t_a	—s	
Enter either $v\ell$ or t_s . If both are entered, specify priority.			
● Operating environment			
	Operating temperature		
	Other		

5

5.1.2 Selecting a Servopack

- 1) The selection of an SGDA Servopack matched to the servo system in which it is used is based on the Servopack type, that is, the four alphanumeric characters after “SGDA-”, described below.

The numbers (1) to (3) below correspond to the numbers in the flowchart for Servopack selection on the following pages.

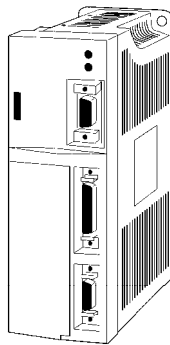

SGDA- 01 A S P

Σ -Series

SGDA: SGDA Servopack

- 1) Rated output

A3: 30W (0.04HP) A5: 50W (0.07HP)
 01: 100W (0.13HP) 02: 200W (0.27HP)
 03: 300W (0.40HP) 04: 400W (0.53HP)
 08: 750W (1.01HP)

- 2) Supply voltage

A: 200V B: 100V

- 3) Model

S: For speed/torque control
 P: For position control

- 4) Factory setting of applicable motor type

Blank: SGM Servomotor
 P: SGMP Servomotor

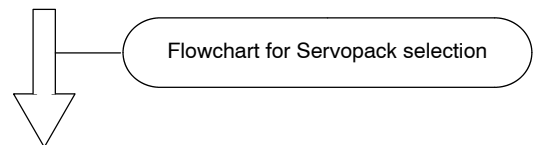

	Selected Servopack type
Example	SGDA- 0 2 B S
Axis 1	SGDA-□□□□
Axis 2	SGDA-□□□□
• • •	• • • • •

* The applicable motor type (SGM/SGMP) can be changed by setting the user constants.

- 2) The actual selection of the SGDA Servopack is conducted according to the flowchart in the next page.

Flowchart for Servopack Selection

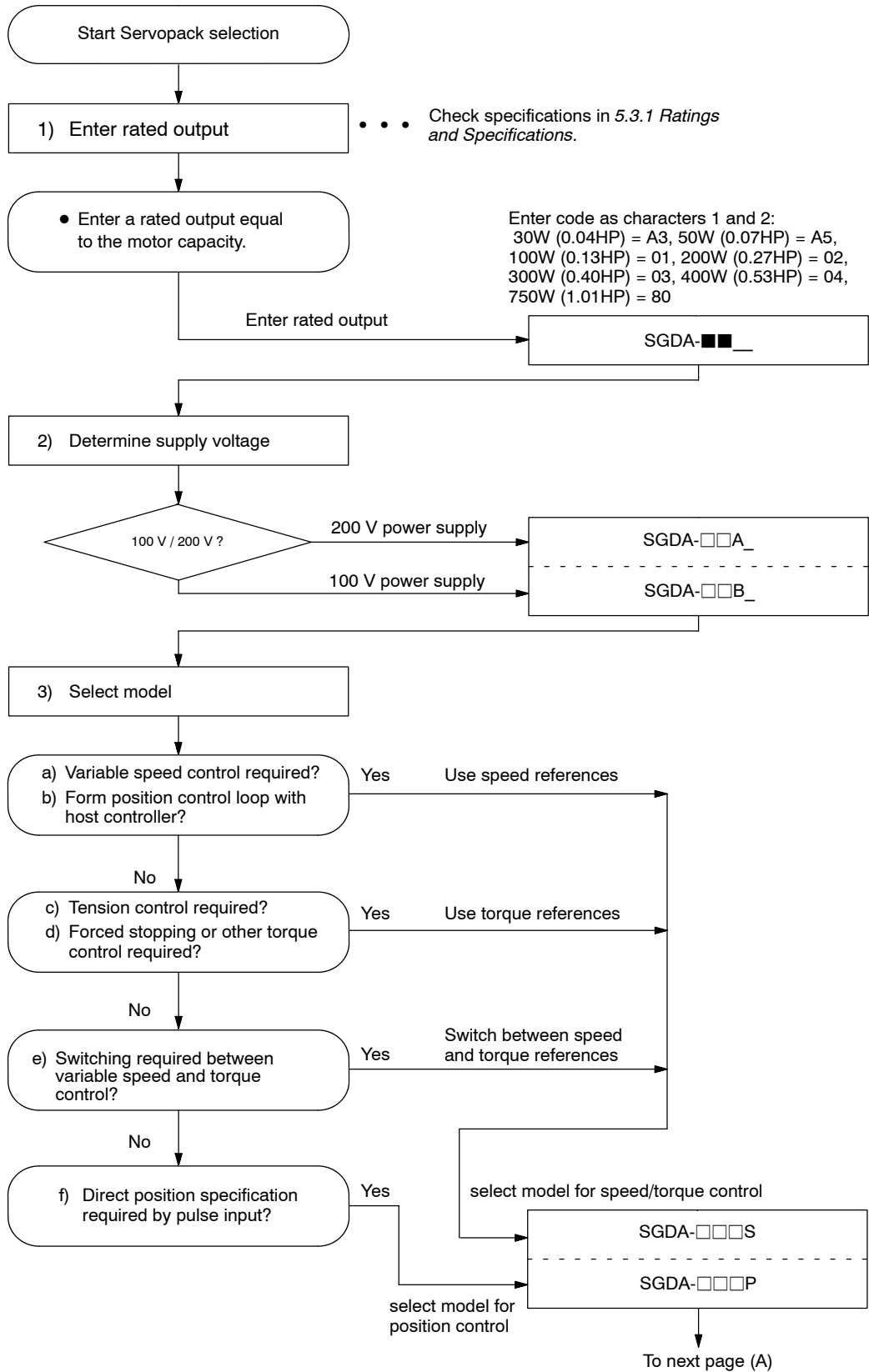

5

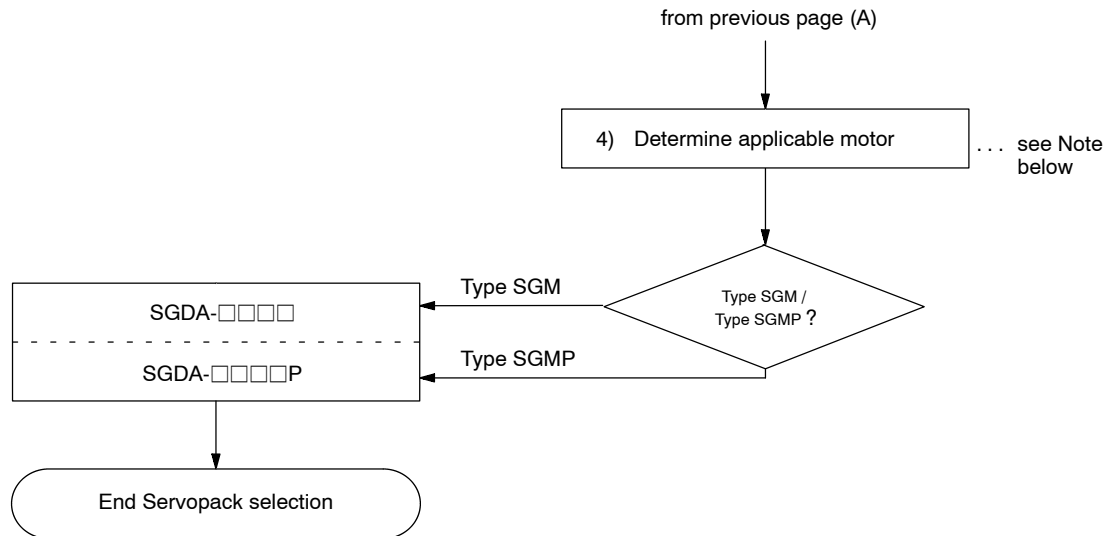

Note The applicable motor type (SGM/SGMP) can be changed by setting the user constants.

5.1.3 Selecting a Digital Operator

- The following two types of Digital Operator are available.
The two types cannot be used simultaneously. However, it is convenient to prepare both types and use whichever suits the circumstances.
Each type differs in shape but the operating functions are identical.

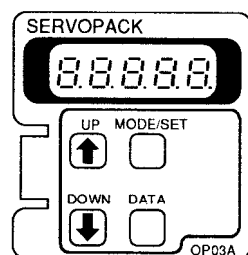

JUSP-OP03A (Mount Type)

- Use attached to the top of the Servopack front face.

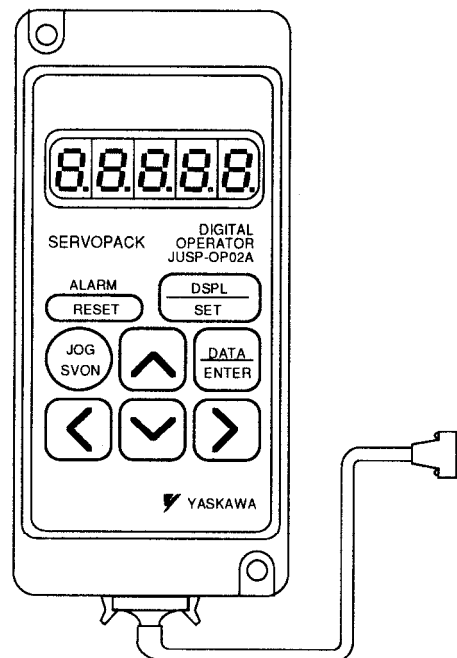

JUSP-OP02A-1 (Hand-held Type)

- Use held in the hand while connected with the 1 m cable supplied.

2) The Digital Operator is selected according to the flowchart below.

Flowchart for Digital Operator Selection

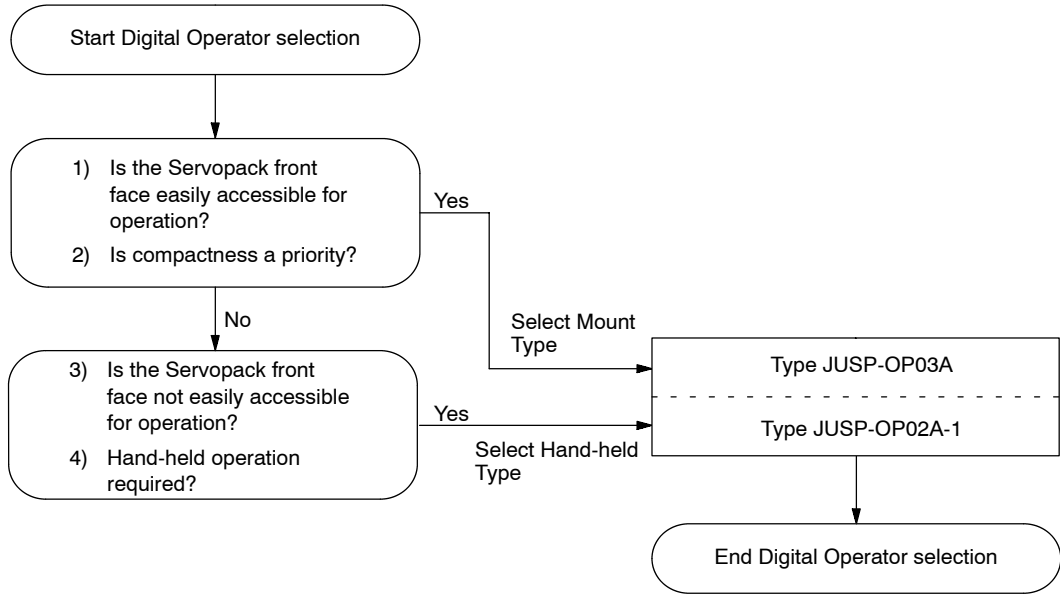

5.2 SGM Servomotor

This section presents tables of ratings and specifications for SGM and SGMP Servomotors. Refer to these tables when selecting a Servomotor.

5.2.1	Ratings and Specifications	217
5.2.2	Mechanical Characteristics	232

5.2.1 Ratings and Specifications

1) Ratings and Specifications of 200-VAC SGM Servomotors

Time rating:	continuous
Heat resistance class:	Class B
Vibration class:	15 μ m or below
Withstand voltage:	1500 VAC
Insulation resistance:	500 VDC 10M Ω min.
Enclosure:	totally enclosed, self-cooled
Ambient temperature:	0 to 40°C
Ambient humidity:	20% to 80% (non-condensing)
Excitation:	permanent magnet
Drive method:	direct drive
Mounting:	flange method

SGM Servomotor		A3A	A5A	01A	02A	04A	08A
Rated Output* ¹	W (HP)	30 (0.04)	50 (0.07)	100 (0.13)	200 (0.27)	400 (0.53)	750 (1.01)
Rated Torque* ¹ * ²	N·m	0.095	0.159	0.318	0.637	1.27	2.39
	(oz·in)	(13.5)	(22.6)	(45.1)	(90.1)	(181)	(338)
Instantaneous Peak Torque* ¹	N·m	0.29	0.48	0.96	1.91	3.82	7.1
	(oz·in)	(40.5)	(67.7)	(135)	(270)	(542)	(1010)
Rated Current* ¹	A (rms)	0.42	0.6	0.87	2.0	2.6	4.4
Instantaneous Max Current* ¹	A (rms)	1.3	1.9	2.8	6.0	8.0	13.9
Rated Speed* ¹	r/min	3000					
Instantaneous Max Speed* ¹	r/min	4500					
Torque Constant* ¹	N·m/A (rms)	0.255	0.286	0.408	0.355	0.533	0.590
	(oz·in/A) (rms)	(36.2)	(40.5)	(57.8)	(50.2)	(75.5)	(83.5)
Moment of Inertia [J _M]	kg·m ² × 10 ⁻⁴	0.021	0.026	0.040	0.123	0.191	0.671
	(oz·in·s ² × 10 ⁻³)	(0.288)	(0.368)	(0.576)	(1.74)	(2.70)	(9.52)
Rated Power Rate* ¹	kW/s	4.36	9.63	25.4	32.8	84.6	85.1
Rated Angular Acceleration* ¹	rad/s ²	45200	61200	79500	51800	666000	35600
Inertia Time Constant	ms	1.5	0.9	0.5	0.4	0.3	0.3
Inductive Time Constant	ms	1.5	1.8	1.9	5.4	6.4	13

SERVO SELECTION AND DATA SHEETS

5.2.1 Ratings and Specifications cont.

- *1 These items and torque-motor speed characteristics quoted in combination with an SGDA Servopack at an armature winding temperature of 100°C. Other values quoted at 20°C. All values typical.
- *2 Rated torques are continuous allowable torque values at 40°C with a 250 x 250 x 6 (mm) (9.84 x 9.84 x 0.24 (in.)) heat sink attached.

NOTE The ratings and specifications above refer to a standard Servomotor.

Add the numerical values below to the moment of inertia values in the table for a motor fitted with a **holding brake** and/or a 12-bit absolute encoder.

Other specifications will also change slightly.

Item \ Type		SGM-					
		A3A	A5A	01A	02A	04A	08A
Holding brake	$\text{kg}\cdot\text{m}^2 \times 10^{-4}$	0.0085			0.058		0.14
	$(\text{oz}\cdot\text{in}\cdot\text{s}^2 \times 10^{-3})$	(0.120)			(0.816)		(1.98)
12-bit absolute encoder	$\text{kg}\cdot\text{m}^2 \times 10^{-4}$	0.025					
	$(\text{oz}\cdot\text{in}\cdot\text{s}^2 \times 10^{-3})$	(0.352)					

Note When a shaft seal is mounted on a motor, run the motor at the following derating factors because of increase in friction torque.

SGM-	A3A	A5A	01A	02A	04A	08A
Derating Rate (%)	70	80	90		95	



Holding Brake

The holding brake is automatically applied to the motor shaft to prevent the load falling in vertical axis applications when the motor power supply is turned off or fails. It is only to hold the load and cannot be used for stopping motor.

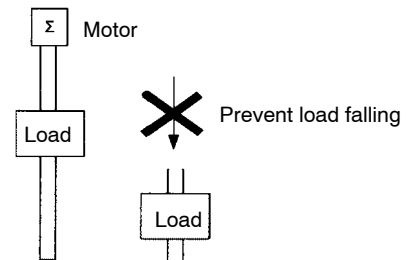

Electrical Specifications of the Holding Brake

a) SGM Type (Rated Voltage: 90 VDC) . . Standard

Motor Model	Motor Capacity (W)	Holding Brake Specifications			
		Capacity (W)	Holding Torque (kg-cm)	Coil Resistance Ω (at 20°C)	Rated Current A (at 20°C)
SGM-A3□□□□	30	6	2.0	1350	0.067
SGM-A5□□□□	50	6	2.0	1350	0.067
SGM-01□□□□	100	6	3.5	1350	0.067
SGM-02□□□□	200	6.5	15	1246	0.072
SGM-04□□□□	400	6.5	15	1246	0.072
SGM-08□□□□	750	6	25	1350	0.067

b) SGM Type (Rated Voltage: 24 VDC) . . Non-standard

Motor Model	Motor Capacity (W)	Holding Brake Specifications			
		Capacity (W)	Holding Torque (kg-cm)	Coil Resistance Ω (at 20°C)	Rated Current A (at 20°C)
SGM-A3□□□□	30	6	2.0	96	0.25
SGM-A5□□□□	50	6	2.0	96	0.25
SGM-01□□□□	100	6	3.5	96	0.25
SGM-02□□□□	200	6.5	15	89	0.27
SGM-04□□□□	400	6.5	15	89	0.27
SGM-08□□□□	750	6	25	96	0.25

■ 200-VAC SGM Servomotor Torque-Motor Speed Characteristics

• SGM-A3A

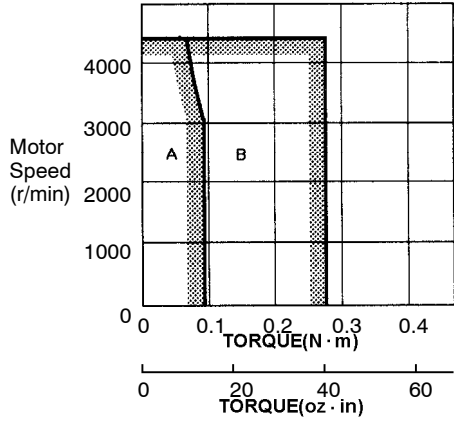

• SGM-A5A

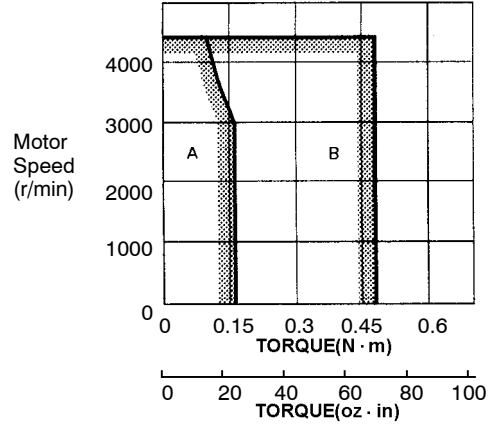

• SGM-01A

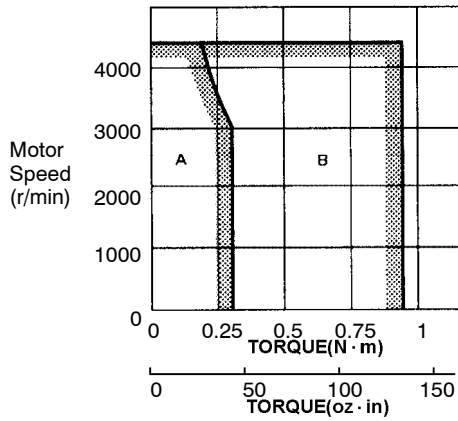

• SGM-02A

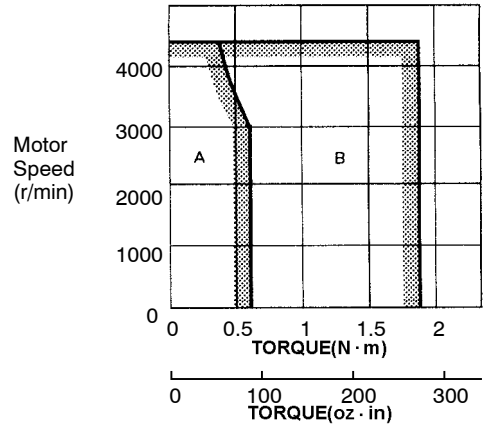

• SGM-04A

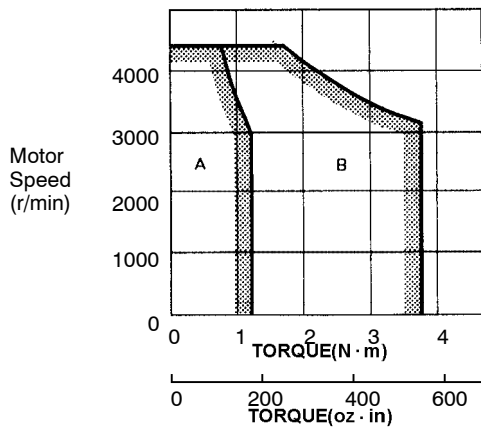

• SGM-08A

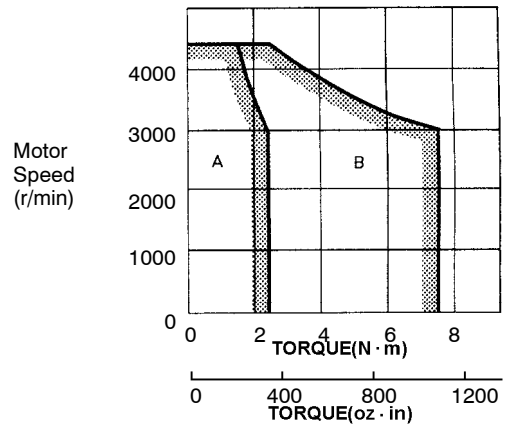

A: Continuous Duty Zone
B: Intermittent Duty Zone

5

2) Ratings and Specifications of 200-VAC SGMP Servomotors

Time rating:	continuous
Heat resistance class:	Class B
Vibration class:	15 μ m or below
Withstand voltage:	1500 VAC
Insulation resistance:	500 VDC 10M Ω min.
Enclosure:	totally enclosed, self-cooled
Ambient temperature:	0 to 40°C
Ambient humidity:	20% to 80% (non-condensing)
Excitation:	permanent magnet
Drive method:	direct drive
Mounting:	flange method

SGMP Servomotor		01A	02A	04A	08A	
Rated Output *1	W (HP)	100 (0.13)	200 (0.27)	400 (0.54)	750 (1.01)	
Rated Torque *1 *2	N·m	0.318	0.637	1.27	2.39	
	(oz·in)	(45.1)	(90.1)	(181)	(338)	
Instantaneous Peak Torque *1	N·m	0.96	1.91	3.82	7.1	
	(oz·in)	(135)	(270)	(542)	(1010)	
Rated Current *1	A (rms)	0.89	2.0	2.6	4.1	
Instantaneous Peak Current *1	A (rms)	2.8	6.0	8.0	13.9	
Rated Rotation Speed *1	r/min	3000				
Max. Rotation Speed *1	r/min	4500				
Torque Constant *1	N·m/A (rms)	0.392	0.349	0.535	0.641	
	oz·in/A (rms)	55.5	49.4	75.8	91.0	
Moment of Inertia	Incremental encoder, no brake	(=GD ² M/4) kg·m ²	0.065 × 10 ⁻⁴	0.209 × 10 ⁻⁴	0.347 × 10 ⁻⁴	2.11 × 10 ⁻⁴
		(oz·in·s ² × 10 ⁻³)	(0.917)	(2.96)	(4.92)	(29.9)
	Incremental encoder, with brake	(=GD ² M/4) kg·m ²	0.103 × 10 ⁻⁴	0.307 × 10 ⁻⁴	0.445 × 10 ⁻⁴	2.52 × 10 ⁻⁴
		(oz·in·s ² × 10 ⁻³)	(1.46)	(4.35)	(6.31)	(35.7)
	Absolute encoder, no brake	(=GD ² M/4) kg·m ²	0.090 × 10 ⁻⁴	0.234 × 10 ⁻⁴	0.372 × 10 ⁻⁴	2.14 × 10 ⁻⁴
		(oz·in·s ² × 10 ⁻³)	(1.27)	(3.31)	(5.27)	(30.3)
	Absolute encoder, with brake	(=GD ² M/4) kg·m ²	0.128 × 10 ⁻⁴	0.332 × 10 ⁻⁴	0.470 × 10 ⁻⁴	2.55 × 10 ⁻⁴
		(oz·in·s ² × 10 ⁻³)	(1.81)	(4.70)	(6.66)	(36.1)
Rated Power Rate *1	kW/s	15.7	19.4	46.8	26.9	
Rated Angular Acceleration *1	rad/s	49200	30500	36700	11300	
Inertia Time Constant	ms	0.7	0.6	0.4	0.7	
Inductive Time Constant	ms	3.7	7.4	8.5	18	

*1 These items and torque-motor speed characteristics quoted in combination with an SGDA Servopack at an armature winding temperature of 100°C. Other values quoted at 20°C. All values typical.

*2 Rated torques are continuous allowable torque values at 40°C with an attached heat sink as specified below.

SERVO SELECTION AND DATA SHEETS

5.2.1 Ratings and Specifications cont.

Heat sink dimensions 01A, 02A, 04A . 250×250×6(mm), (9.84×9.84×0.24 (in.))
 08A 300×300×12(mm), (11.81×11.81×0.47(in.))

NOTE The ratings and specifications above refer to a standard Servomotor.

Add the numerical values below to the moment of inertia values in the table for a motor fitted with a holding brake and/or a 12-bit absolute encoder.

Other specifications will also change slightly.

Item	Type	SGMP-			
		01A	02A	04A	08A
Holding brake	$\text{kg}\cdot\text{m}^2 \times 10^{-4}$	0.038	0.098		0.41
	$(\text{oz}\cdot\text{in}\cdot\text{s}^2 \times 10^{-3})$	0.54	1.39		5.82
12-bit absolute encoder	$\text{kg}\cdot\text{m}^2 \times 10^{-4}$	0.025			
	$(\text{oz}\cdot\text{in}\cdot\text{s}^2 \times 10^{-3})$	0.36			

Note When a shaft seal is mounted on a motor, run the motor at the following derating factors because of increase in friction torque.

SGMP-	01A	02A	04A	08A
Derating Rate (%)	90		95	

Electrical Specifications of the Holding Brake

a) SGMP Type (Rated Voltage: 90 VDC) . Standard

Motor Model	Motor Capacity (W)	Holding Brake Specifications			
		Capacity (W)	Holding Torque (kg-cm)	Coil Resistance Ω (at 20°C)	Rated Current A (at 20°C)
SGMP-01□□□□	100	6	5.0	1555	0.062
SGMP-02□□□□	200	5	10	1573	0.056
SGMP-04□□□□	400	7.6	20	1062	0.085
SGMP-08□□□□	750	7.5	37	1083	0.083

b) SGMP Type (Rated Voltage: 24 VDC) . Non-standard

Motor Model	Motor Capacity (W)	Holding Brake Specifications			
		Capacity (W)	Holding Torque (kg-cm)	Coil Resistance Ω (at 20°C)	Rated Current A (at 20°C)
SGMP-01□□□□	100	6	5.0	114	0.23
SGMP-02□□□□	200	5	10	116	0.21
SGMP-04□□□□	400	7.6	20	89	0.29
SGMP-08□□□□	750	7.5	37	77	0.31

■ 200-VAC SGMP Servomotor Torque-Motor Speed Characteristics

• SGMP-01A

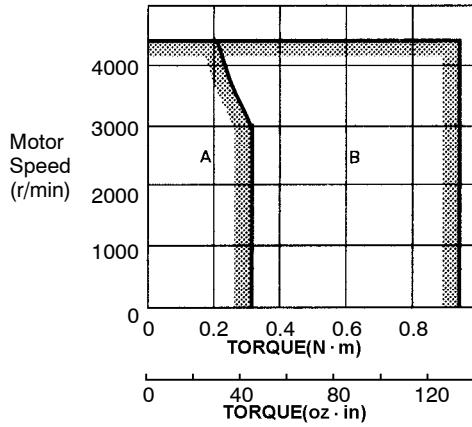

• SGMP-02A

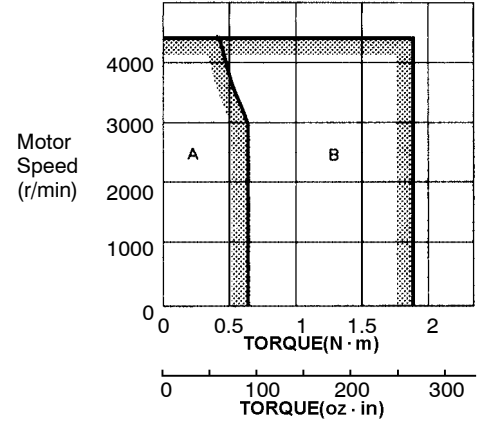

• SGMP-04A

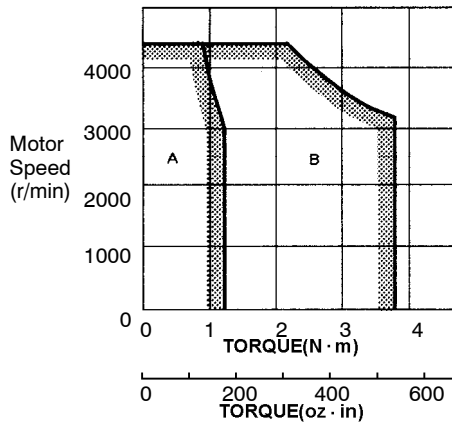

• SGMP-08A

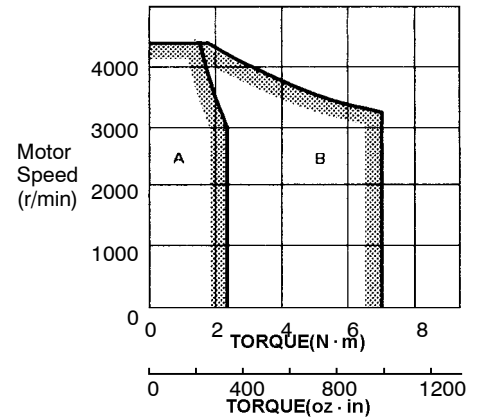

A: Continuous Duty Zone
 B: Intermittent Duty Zone

5

3) Ratings and Specifications of 100-VAC SGM Servomotors

Time rating:	continuous
Heat resistance class:	Class B
Vibration class:	15 μ m or below
Withstand voltage:	1500 VAC
Insulation resistance:	500 VDC 10M Ω min.
Enclosure:	totally enclosed, self-cooled
Ambient temperature:	0 to 40°C
Ambient humidity:	20% to 80% (non-condensing)
Excitation:	permanent magnet
Drive method:	direct drive
Mounting:	flange method

SGM Servomotor		A3B	A5B	01B	02B	03B
Rated Output *1	W (HP)	30 (0.04)	50 (0.07)	100 (0.13)	200 (0.27)	300 (0.40)
Rated Torque *1 *2	N·m	0.095	0.159	0.318	0.637	0.95
	(oz·in)	(13.5)	(22.6)	(45.1)	(90.1)	(135.0)
Instantaneous Peak Torque *1	N·m	0.29	0.48	0.96	1.91	3.72
	(oz·in)	(40.5)	(67.7)	(135)	(270)	(527.7)
Rated Current *1	A (rms)	0.63	0.9	2.2	2.7	3.7
Instantaneous Peak Current *1	A (rms)	2.0	2.9	7.1	8.4	14.8
Rated Rotation Speed *1	r/min	3000				
Max. Rotation Speed *1	r/min	4500				
Torque Constant *1	N·m/A (rms)	0.168	0.194	0.156	0.255	0.279
	oz·in/A (rms)	(23.8)	(27.5)	(22.1)	(36.1)	(39.6)
Moment of Inertia	(=GD ² _M /4) kg·m ²	0.021 ×10 ⁻⁴	0.026 ×10 ⁻⁴	0.040 ×10 ⁻⁴	0.123 ×10 ⁻⁴	0.191 ×10 ⁻⁴
	(oz·in·s ² × 10 ⁻³)	(0.288)	(0.368)	(0.576)	(1.74)	(2.71)
Rated Power Rating *1	kW/S	4.36	9.63	25.4	32.8	47.3
Rated Angular Acceleration *1	rad/s ²	45200	61200	79500	51800	49700
Inertia Time Constant	ms	1.6	0.9	0.6	0.4	0.3
Inductive Time Constant	ms	1.3	1.6	1.6	5.7	5.3

*1 These items and torque-motor speed characteristics quoted in combination with an SGDA Servopack at an armature winding temperature of 100°C. Other values quoted at 20°C. All values typical.

*2 Rated torques are continuous allowable torque values at 40°C with a 250 x 250 x 6 (mm) (9.84 x 9.84 x 0.24 (in.)) heat sink attached.

SERVO SELECTION AND DATA SHEETS

5.2.1 Ratings and Specifications cont.

NOTE The ratings and specifications above refer to a standard Servomotor.

Add the numerical values below to the moment of inertia values in the table for a motor fitted with a holding brake and/or a 12-bit absolute encoder.

Other specifications will also change slightly.

Item \ Type		SGM-				
		A3B	A5B	01B	02B	03B
Holding brake	$\text{kg}\cdot\text{m}^2 \times 10^{-4}$	0.0085			0.058	
	$(\text{oz}\cdot\text{in}\cdot\text{s}^2 \times 10^{-3})$	0.12			0.82	
12-bit absolute encoder	$\text{kg}\cdot\text{m}^2 \times 10^{-4}$	0.025				
	$(\text{oz}\cdot\text{in}\cdot\text{s}^2 \times 10^{-3})$	0.36				

Note When a shaft seal is mounted on a motor, run the motor at the following derating factors because of increase in friction torque.

SGM-	A3B	A5B	01B	02B	03B
Derating Rate (%)	70	80	90		

Electrical Specifications of the Holding Brake

a) SGM Type (Rated Voltage: 90 VDC) .. Standard

Motor Model	Motor Capacity (W)	Holding Brake Specifications			
		Capacity (W)	Holding Torque (kg-cm)	Coil Resistance Ω (at 20°C)	Rated Current A (at 20°C)
SGM-A3□□□□	30	6	2.0	1350	0.067
SGM-A5□□□□	50	6	2.0	1350	0.067
SGM-01□□□□	100	6	3.5	1350	0.067
SGM-02□□□□	200	6.5	15	1246	0.072
SGM-03□□□□	400	6.5	15	1246	0.072

b) SGM Type (Rated Voltage: 24 VDC) .. Non-standard

Motor Model	Motor Capacity (W)	Holding Brake Specifications			
		Capacity (W)	Holding Torque (kg-cm)	Coil Resistance Ω (at 20°C)	Rated Current A (at 20°C)
SGM-A3□□□□	30	6	2.0	96	0.25
SGM-A5□□□□	50	6	2.0	96	0.25
SGM-01□□□□	100	6	3.5	96	0.25
SGM-02□□□□	200	6.5	15	89	0.27
SGM-03□□□□	400	6.5	15	89	0.27

■ 100-VAC SGM Servomotor Torque-Motor Speed Characteristics

• SGM-A3B

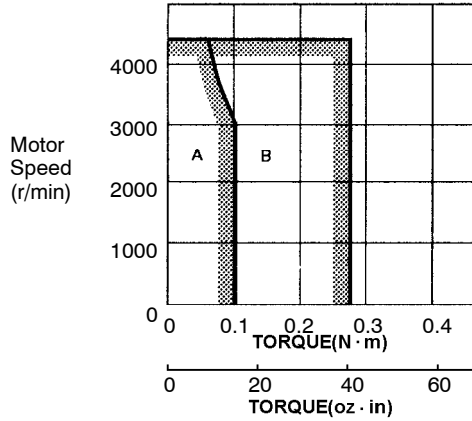

• SGM-A5B

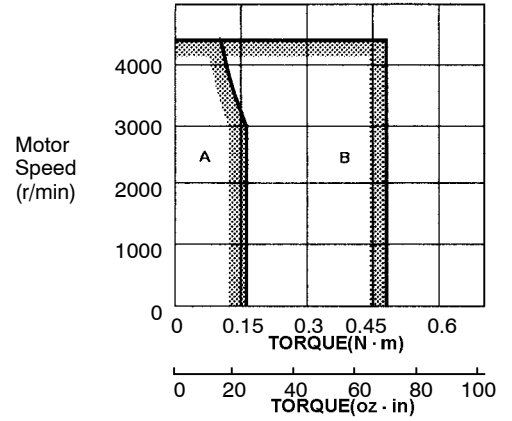

• SGM-01B

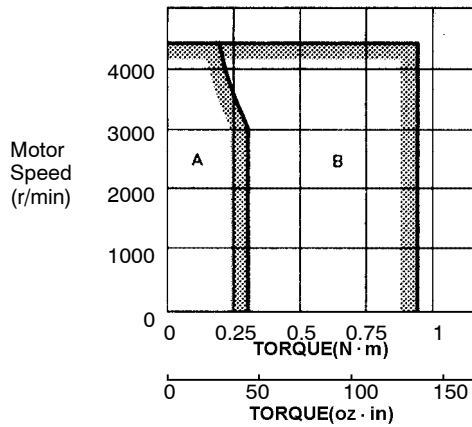

• SGM-02B

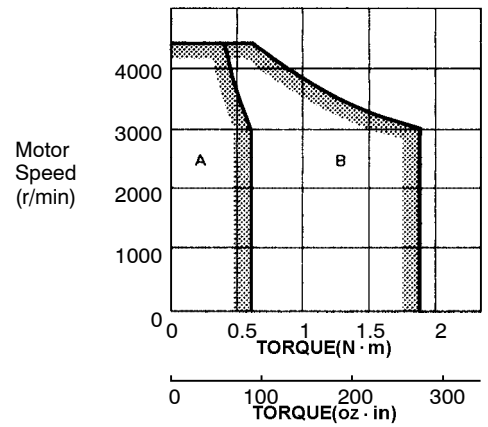

• SGM-03B

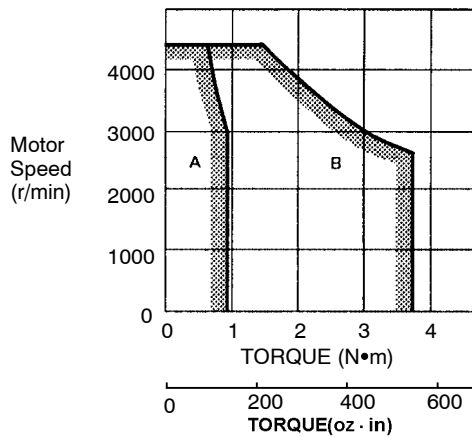

A: Continuous Duty Zone
B: Intermittent Duty Zone

SERVO SELECTION AND DATA SHEETS

5.2.1 Ratings and Specification cont

4) Ratings and Specifications of 100-VAC SGMP Servomotors

Time rating:	continuous
Heat resistance class:	Class B
Vibration class:	15 μ m or below
Withstand voltage:	1500 VAC
Insulation resistance:	500 VDC 10M Ω min.
Enclosure:	totally enclosed, self-cooled
Ambient temperature:	0 to 40°C
Ambient humidity:	20% to 80% (non-condensing)
Excitation:	permanent magnet
Drive method:	direct drive
Mounting:	flange method

SGMP Servomotor			01B	02B	03B
Rated Output*1		W (HP)	100 (0.13)	200 (0.27)	300 (0.40)
Rated Torque*1 *2		N.m	0.318	0.637	0.955
		(oz.in)	(45.1)	(90.1)	(135)
Instantaneous Peak Torque*1		N.m	0.96	1.91	2.86
		(oz.in)	(135)	(270)	(406)
Rated Current*1		A (rms)	2.2	2.7	4.3
Instantaneous Peak Current*1		A (rms)	7.1	8.4	13.9
Rated Rotation Speed*1		r/min	3000		
Max. Rotation Speed*1		r/min	4500		
Torque Constant*1		N.m/A (rms)	0.160	0.258	0.246
		oz.in/A (rms)	22.8	36.5	34.9
Moment of Inertia	Incremental encoder, no brake	(=GD ² _M /4) kg.m ²	0.065 $\times 10^{-4}$	0.209 $\times 10^{-4}$	0.347 $\times 10^{-4}$
		(oz.in.s ² $\times 10^{-3}$)	(0.917)	(2.96)	(4.92)
	Incremental encoder, with brake	(=GD ² _M /4) kg.m ²	0.103 $\times 10^{-4}$	0.307 $\times 10^{-4}$	0.445 $\times 10^{-4}$
		(oz.in.s ² $\times 10^{-3}$)	(1.46)	(4.35)	(6.31)
	Absolute encoder, no brake	(=GD ² _M /4) kg.m ²	0.090 $\times 10^{-4}$	0.234 $\times 10^{-4}$	0.372 $\times 10^{-4}$
		(oz.in.s ² $\times 10^{-3}$)	(1.27)	(3.31)	(5.27)
	Absolute encoder, with brake	(=GD ² _M /4) kg.m ²	0.128 $\times 10^{-4}$	0.332 $\times 10^{-4}$	0.470 $\times 10^{-4}$
		(oz.in.s ² $\times 10^{-3}$)	(1.81)	(4.70)	(6.66)
Rated Power Rate*1		kW/s	15.7	19.4	26.3
Rated Angular Acceleration*1		rad/s	49200	30500	27500
Inertia Time Constant		ms	0.8	0.7	0.4
Inductive Time Constant		ms	3.6	6.3	8.5

*1 These items and torque-motor speed characteristics quoted in combination with an SGDA Servopack at an armature winding temperature of 100°C. Other values quoted at 20°C. All values typical.

*2 Rated torques are continuous allowable torque values at 40°C with a 250 x 250 x 6 (mm) (9.84 x 9.84 x 0.24 (in.)) heat sink attached.

NOTE The ratings and specifications above refer to a standard Servomotor.

Add the numerical values below to the moment of inertia values in the table for a motor fitted with a holding brake and/or a 12-bit absolute encoder.

Other specifications will also change slightly.

Item \ Type		SGMP-		
		01B	02B	03B
Holding brake	$\text{kg}\cdot\text{m}\times 10^{-4}$	0.038	0.098	
	$(\text{oz}\cdot\text{in}\cdot\text{s}^2\times 10^{-3})$	0.54	1.39	
12-bit absolute encoder	$\text{kg}\cdot\text{m}\times 10^{-4}$	0.025		
	$(\text{oz}\cdot\text{in}\cdot\text{s}^2\times 10^{-3})$	0.36		

Note When a shaft seal is mounted on a motor, run the motor at the following derating factors because of increase in friction torque.

SGMP-	01B	02B	03B
Derating Rate (%)	90		95

Electrical Specifications of the Holding Brake

a) SGMP Type (Rated Voltage: 90 VDC) . Standard

Motor Model	Motor Capacity (W)	Holding Brake Specifications			
		Capacity (W)	Holding Torque (kg-cm)	Coil Resistance Ω (at 20°C)	Rated Current A (at 20°C)
SGMP-01□□□□	100	6	5.0	1555	0.062
SGMP-02□□□□	200	5	10	1573	0.056
SGMP-04□□□□	400	7.6	20	1062	0.085
SGMP-08□□□□	750	7.5	37	1083	0.083

b) SGMP Type (Rated Voltage: 24 VDC) . Non-standard

Motor Model	Motor Capacity (W)	Holding Brake Specifications			
		Capacity (W)	Holding Torque (kg-cm)	Coil Resistance Ω (at 20°C)	Rated Current A (at 20°C)
SGMP-01□□□□	100	6	5.0	114	0.23
SGMP-02□□□□	200	5	10	116	0.21
SGMP-04□□□□	400	7.6	20	89	0.29
SGMP-08□□□□	750	7.5	37	77	0.31

5

■ 100-VAC SGMP Servomotor Torque-Motor Speed Characteristics

• SGMP-01B

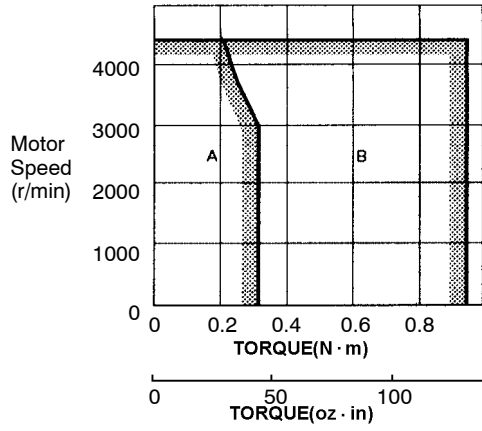

• SGMP-02B

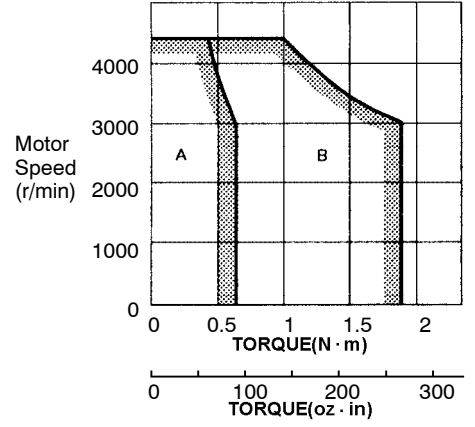

• SGMP-03B

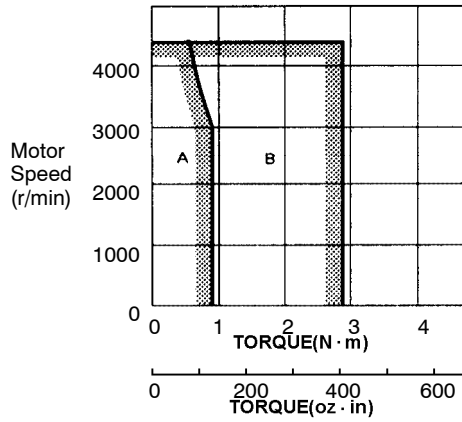

A: Continuous Duty Zone
 B: Intermittent Duty Zone

5.2.2 Mechanical Characteristics

1) Allowable Radial Load, Allowable Thrust Load

The output shaft allowable loads for SGM and SGMP Servomotor are shown below.

Conduct mechanical design such that the thrust loads and radial loads do not exceed the values stated below.

- Servomotor with incremental encoder

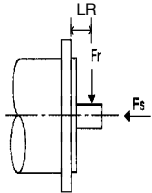
Motor Type	Allowable Radial Load Fr [N(lb)]	Allowable Thrust Load Fs [N(lb)]	LR mm (in.)	Reference Drawing
SGM-A3	68 (15)	54 (12)	20 (0.82)	
SGM-A5	68 (15)	54 (12)	20 (0.82)	
SGM-01	78 (17)	54 (12)	20 (0.82)	
SGM-02	245 (55)	74 (16)	25 (1.02)	
SGM-03	245 (55)	74 (16)	25 (1.02)	
SGM-04	245 (55)	74 (16)	25 (1.02)	
SGM-08	392 (88)	147 (33)	35 (1.43)	
SGMP-01	78 (17)	49 (11)	20 (0.82)	
SGMP-02	245 (55)	68 (15)	25 (1.02)	
SGMP-03	245 (55)	68 (15)	25 (1.02)	
SGMP-04	245 (55)	69 (15)	25 (1.02)	
SGMP-08	392 (88)	147 (33)	35 (1.43)	

- Servomotor with absolute encoder

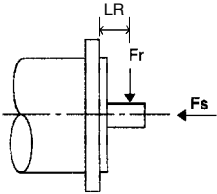
Motor Type	Allowable Radial Load Fr [N(lb)]	Allowable Thrust Load Fs [N(lb)]	LR mm (in.)	Reference Drawing
SGM-A3	49 (11)	19 (4)	20 (0.82)	
SGM-A5	68 (15)	19 (4)	20 (0.82)	
SGM-01	68 (15)	19 (4)	20 (0.82)	
SGM-02	196 (44)	49 (11)	25 (1.02)	
SGM-03	196 (44)	49 (11)	25 (1.02)	
SGM-04	196 (44)	68 (15)	25 (1.02)	
SGM-08	343 (77)	98 (22)	35 (1.43)	
SGMP-01	78 (17)	49 (11)	20 (0.82)	
SGMP-02	245 (55)	68 (15)	25 (1.02)	
SGMP-03	245 (55)	68 (15)	25 (1.02)	
SGMP-04	245 (55)	69 (15)	25 (1.02)	
SGMP-08	392 (88)	147 (33)	35 (1.43)	

Note The radial load and thrust load limit values are the sum of the loads generated by the motor torque and the external loads applied to the shaft.

2) Mechanical Tolerance

The tolerances of the SGM and SGMP Servomotor output shaft and installation are shown in the table below.

Tolerance (T.I.R.)		Reference Diagram
Perpendicularity between flange face and output shaft (A)	0.04mm (0.0016in.)	
Mating concentricity of flange O.D. (B)	0.04mm (0.0016in.)	
Run-out at end of shaft (C)	0.02mm (0.00079in.)	

Note T.I.R. = Total Indicator Reading

3) Direction of Motor Rotation

Positive rotation of the servomotor is counter-clockwise, viewing from the load.

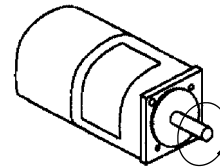

4) Impact Resistance

Mount the servomotor with the axis horizontal. The servomotor must withstand the following vertical impacts.

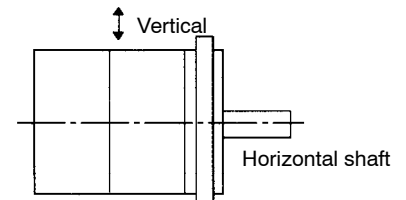

- Impact Acceleration: 98 m/s² (10 G)
- Number of Impacts: 2

NOTE In SGM and SGMP Servomotors, an accurate detector is attached to the shaft at the opposite end from the load.

Avoid applying impacts directly to the shaft as these may damage the detector

5) Vibration Resistance

Mount the servomotor with the axis horizontal. The servomotor must withstand the following vibration accelerations in three directions: vertical, transverse, and longitudinal.

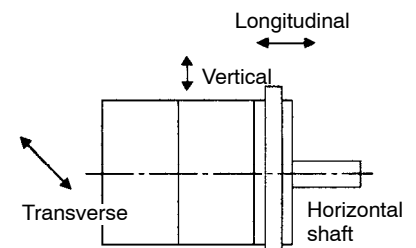

- Vibration Acceleration: 24.5 m/s² (2.5 G)

6) Vibration Class

The SGM Servomotor meets the following **vibration class** at rated speed.

- Vibration Class: 15 μ m or below

Vibration Measurement Position

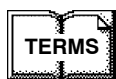
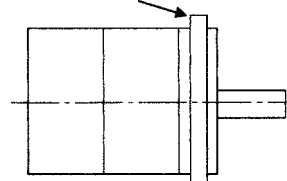

Vibration Class

Vibration class 15 μ m or below indicates that the total amplitude of vibration of the motor alone, running at rated speed, does not exceed 15 μ m.

5.3 Servopack Ratings and Specifications

This section presents tables of SGDA Servopack ratings and specifications separately for speed/torque control and for position control.

5.3.1	Ratings and Specifications	235
5.3.2	Overload Characteristics	240
5.3.3	Starting Time and Stopping Time	241
5.3.4	Load Inertia	241
5.3.5	Overhanging Loads	244
5.3.6	In-rush Current and Power Loss	245

5.3.1 Ratings and Specifications

1) The ratings and specifications of the SGDA Servopack are shown below. Refer to them as required when selecting a Servopack.

Refer to the specifications listed for combination with the appropriate type of Servomotor.

2) Ratings and Specifications of SGDA Servopack for Speed/Torque Control

Voltage			200 VAC					100 VAC					
SGDA Servopack			A3AS	A5AS	01AS	02AS	04AS	08AS	A3BS	A5BS	01BS	02BS	03BS
Max. Applicable Motor Capacity W (HP)			30 (0.04)	50 (0.07)	100 (0.13)	200 (0.27)	400 (0.53)	750 (1.01)	30 (0.04)	50 (0.07)	100 (0.13)	200 (0.27)	300 (0.40)
Combined Specifica- tions	Motor	Type	A3A□	A5A□	01A□	02A□	04A□	08A□	A3B□	A5B□	01B□	02B□	03B□
		Motor Ca- pacity W (HP)	30 (0.04)	50 (0.07)	100 (0.13)	200 (0.27)	400 (0.53)	750 (1.01)	30 (0.04)	50 (0.07)	100 (0.13)	200 (0.27)	300 (0.40)
		Rated/ Max. Mo- tor Speed	3000/4500 r/min					3000/4500 r/min					
		Applicable encoder	Incremental encoder 2048 P/R, absolute encoder 1024 P/R										
Combined Specifica- tions	Allowable Load Iner- tia*1 J _L kg·m ² × 10 ⁻⁴ (oz·in·s ² × 10 ⁻³)	0.63 (8.80)	0.78 (11.0)	1.20 (17.0)	3.69 (52.2)	3.82 (54.1)	13.4 (189)	0.63 (8.80)	0.78 (11.0)	1.20 (17.0)	3.69 (52.2)	3.82 (54.1)	
Combined Specifica- tions	Continuous Output Current	0.42	0.6	0.87	2.0	2.6	4.4	0.63	0.90	2.2	2.7	3.7	
	Max. Output Current	1.3	1.9	2.8	6.0	8.0	13.9	2.0	2.9	7.1	8.4	14.8	

SERVO SELECTION AND DATA SHEETS

5.3.1 Ratings and Specifications cont.

Voltage		200 VAC					100 VAC					
SGDA Servopack		A3AS	A5AS	01AS	02AS	04AS	08AS	A3BS	A5BS	01BS	02BS	03BS
Max. Applicable Motor Capacity W (HP)		30 (0.04)	50 (0.07)	100 (0.13)	200 (0.27)	400 (0.53)	750 (1.01)	30 (0.04)	50 (0.07)	100 (0.13)	200 (0.27)	300 (0.40)
Basic Specifica- tions	Power Supply	Single-phase 200 to 230 VAC, +10% to -15%, 50/60 Hz					Single-phase 100 to 115 VAC* ² , +10% to -15%, 50/60 Hz					
	Control Method	Single-phase, full-wave rectification IGBT-PWM (sine-wave driven)										
	Feedback	Incremental encoder 2048 P/R, absolute encoder 1024 P/R										
	Location	Ambient Temp.	0 to 55°C* ³									
		Storage Temp.	-20 to +85°C									
		Ambient/ Storage Humidity	90% or less (with no condensation)									
		Vibration/ Shock Resistance	0.5/2G									
	Structure	Base mounted										
Approx. mass kg (lb)	0.9 (1.98)				1.2 (2.65)	1.5 (3.31)	0.9 (1.98)			1.2 (2.65)	1.5 (3.31)	
Perfor- mance	Speed Control Range* ⁴	1:5000										
	Speed Regulation* ⁵	Load Regulation	0% to 100%:0.01% max. (at rated speed)									
		Voltage Regulation	0%									
		Temperature Regulation	25±25°C: ±0.1% max. (at rated speed)									
	Frequency Characteristics	250 Hz (at $J_L=J_M$)										
	Torque Control (Repeatability)	±2.0%										
	Accel/Decel Time Setting	0 to 10 s										
Input Signal	Speed Reference	Rated Reference Voltage	±6 VDC (positive motor rotation with positive reference) at rated speed (factory setting) Variable setting range: ±2 to ±10 VDC at rated speed									
		Input Impedance	Approx. 30 kΩ									
		Circuit Time Constant	Approx. 47 μs									
	Torque Reference	Rated Reference Voltage	±3 VDC (positive motor rotation with positive reference) at rated speed (factory setting) Variable setting range: ±1 to ±10 VDC at rated torque									
		Input Impedance	Approx. 30 kΩ									
		Circuit Time Constant	Approx. 47 μs									

5

Voltage			200 VAC	100 VAC
I/O Signals	Position Output	Output Form	A-, B-, C-phase line driver	
		Frequency Dividing Ratio	(16 to N) /N N=2048, 1024* ⁶	
	Sequence Input		Servo ON, P drive (or motor forward/reverse by torque control, zero-clamp drive reference, or internal setting speed), forward run stop (P-OT), reverse run stop (N-OT), current limit + selection (or internal speed selection), current limit – selection (or internal speed selection), alarm reset	
	Sequence Output		Current limit detection (or TGON), speed coincidence, external brake interlock, servo alarm, 3-bit alarm codes	
Dynamic Brake			Operated at main power OFF, servo alarm or overtravel.	
External Regenerative Unit			Required when exceeding the allowable load inertia* ¹	
Overtravel			Dynamic brake stop at P-OT or N-OT or deceleration stop	
Protective Functions			Overcurrent, grounding, overload, overvoltage, overspeed, reference input read error, overrun prevention, origin error, CPU error, encoder error	
Indicators			Alarm and power LEDs	
			Programming panel is available as an option	
Others			Torque control, zero clamp operation (position loop stop), soft start/stop, speed coincidence, brake interlock signal output, reverse run connection, JOG run, auto-tuning	

*¹ Allowable load inertia ranges require no optional external regenerative unit. Values are 30 times the moment of inertia for 30 W (0.04 HP) to 200 W (0.27 HP) Servomotors, and 20 times for 400 W (0.53 HP) and 750 W (1.01 HP) Servomotors. If load inertias exceed these ranges, restrict the operation or use a regenerative unit.

*² Supply voltage should not exceed 230 V + 10% (253 V) or 115 V + 10% (127 V). A step-down transformer is required if the voltage should exceed these values.

*³ Use within the ambient temperature range. When enclosed in a box, the internal temperatures must not exceed the ambient temperature range.

*⁴ The lowest speed of the speed control range is the speed at which the motor does not stop under 100% load.

*⁵ Speed regulation is defined as follows:

$$\text{Speed regulation} = \frac{\text{No-load-speed} - \text{Full-load-speed}}{\text{Rated speed}} \times 100\%$$

The motor speed may change due to voltage variations or amplifier drift and changes in processing resistance due to temperature variation.

These ratios of the speed changes to the rated speed represent the speed regulation due to voltage and temperature variations.

*⁶ N is the number of encoder pulses.

SERVO SELECTION AND DATA SHEETS

5.3. Ratings and Specifications cont.

3) Ratings and Specifications of SGDA Servopack for Position Control

Voltage			200 VAC					100 VAC					
SGDA Servopack			A3AP	A5AP	01AP	02AP	04AP	08AP	A3BP	A5BP	01BP	02BP	03BP
Max. Applicable Motor Capacity W (HP)			30 (0.04)	50 (0.07)	100 (0.13)	200 (0.27)	400 (0.53)	750 (1.01)	30 (0.04)	50 (0.07)	100 (0.13)	200 (0.27)	300 (0.40)
Combined Specifications	Motor	Type	A3A□	A5A□	01A□	02A□	04A□	08A□	A3B□	A5B□	01B□	02B□	03B□
		Motor Capacity W (HP)	30 (0.04)	50 (0.07)	100 (0.13)	200 (0.27)	400 (0.53)	750 (1.01)	30 (0.04)	50 (0.07)	100 (0.13)	200 (0.27)	300 (0.40)
	Rated/Max. Motor Speed	3000/4500 r/min						3000/4500 r/min					
	Applicable encoder	Incremental encoder 2048 P/R, absolute encoder 1024 P/R											
	Allowable Load Inertia*1 J _L kg·m ² × 10 ⁻⁴ (oz·in·s ² × 10 ⁻³)	0.63 (8.80)	0.78 (11.0)	1.20 (17.0)	3.69 (52.2)	3.82 (54.1)	13.4 (189)	0.63 (8.80)	0.78 (11.0)	1.20 (17.0)	3.69 (52.2)	3.82 (54.1)	
	Continuous Output Current	0.42	0.6	0.87	2.0	2.6	4.4	0.63	0.90	2.2	2.7	3.7	
Max. Output Current			1.3	1.9	2.8	6.0	8.0	13.9	2.0	2.9	7.1	8.4	14.8
Basic Specifications	Power Supply		Single-phase 200 to 230 VAC, +10% to -15%, 50/60 Hz*2					Single-phase 100 to 115 VAC*2, +10% to -15%, 50/60 Hz					
	Control Method		Single-phase, full-wave rectification IGBT-PWM (sine-wave driven)										
	Feedback		Incremental encoder 2048 P/R, absolute encoder 1024 P/R										
	Location	Ambient Temp.	0 to 55°C*3										
		Storage Temp.	-20°C to +85°C										
		Ambient/Storage Humidity	90% or less (with no condensation)										
		Vibration/Shock Resistance	0.5/2G										
Structure		Base mounted											
Mass kg (lb)		0.9 (1.98)				1.2 (2.65)	1.5 (3.31)	0.9 (1.98)			1.2 (2.65)	1.5 (3.31)	
Performance	Bias Setting		0 to 450 r/min. (Setting resolution: 1 r/min.)										
	Feed Forward Compensation		0 to 100% (Setting resolution: 1%)										
	Position Complete Width Setting		0 to 250 reference units. Reference unit: minimum unit of position data which moves load										

5

Voltage			200 VAC	100 VAC
Input Signal	Reference Pulse	Type	SIGN + PULSE train, 90° phase difference 2-phase pulse, (A-phase+B-phase), CCW pulse+CW pulse	
		Pulse Form	Line driver (+5 V level), open collector (+5 V or +12 V level)	
		Pulse Frequency	0 to 450 kpps	
	Control Signal	CLEAR (input pulse form identical to reference pulse)		
I/O Signals	Position Output	Output Form	A-, B-, C-phase line driver	
		Frequency Dividing Ratio	(16 to N) /N N=2048, 1024)* ⁴	
	Sequence Input	Servo ON, P drive (or motor forward/reverse by internal speed setting), forward run stop (P-OT), reverse run stop (N-OT), alarm reset, current limit + selection (or internal speed selection), current limit – selection (or internal speed selection)		
	Sequence Output	Current limit detection (or TGON), positioning complete, brake interlock, servo alarm, 3-bit alarm codes		
Dynamic Brake		Operated at main power OFF, servo alarm or overtravel.		
External Regenerative Unit		Required when exceeding the allowable load inertia		
Overtravel		Dynamic brake stop at P-OT or N-OT or deceleration stop		
Protective Functions		Overcurrent, grounding, overload, overvoltage, overspeed, overrun prevention, origin error, CPU error, encoder error, overflow		
Indicators		Alarm and power LEDs		
		Programming panel is available as an option		
Others		Brake interlock signal output, reverse run connection, JOG run, electronic gear, auto-tuning		

*¹ Allowable load inertia ranges require no optional external regenerative unit. Values are 30 times the moment of inertia for 30 W (0.04 HP) to 200 W (0.27 HP) Servomotors, and 20 times for 400 W (0.53 HP) and 750 W (1.01 HP) Servomotors. If load inertias exceed these ranges, restrict the operation or use a regenerative unit.

*² Supply voltage should not exceed 230 V + 10% (253 V) or 115 V + 10% (127 V). A step-down transformer is required if the voltage should exceed these values.

*³ Use within the ambient temperature range. When enclosed in a box, the internal temperatures must not exceed the ambient temperature range.

*⁴ N is the number of encoder pulses.

5.3.2 Overload Characteristics

The Servopack has a built-in overload protective function to protect the Servopack and Servomotor from overload. Therefore, the Servopack allowable power is limited by the overload protective function, as shown below.

The overload detection level is quoted under **hot start** conditions at a motor ambient temperature of 40°C.

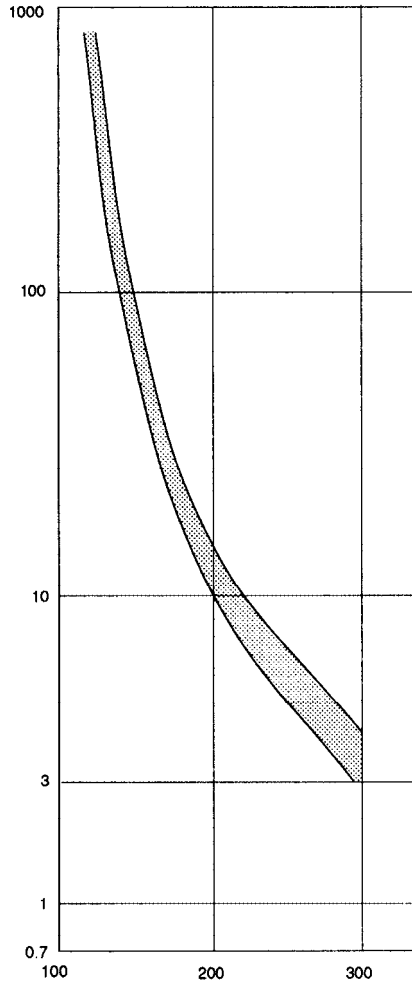

5



Hot Start

Indicates that both Servopack and Servomotor have run long enough at rated load to be thermally saturated.

5.3.3 Starting Time and Stopping Time

- 1) The motor starting time (t_r) and stopping time (t_f) under constant load are calculated by the following formulas. The motor viscous torque and friction torque are ignored.

$$\text{Starting Time: } t_r = 104.7 \times \frac{N_R (J_M + J_L)}{K_t I_R (\alpha - \beta)} \text{ [ms]}$$

$$\text{Stopping Time: } t_f = 104.7 \times \frac{N_R (J_M + J_L)}{K_t I_R (\alpha + \beta)} \text{ [ms]}$$

N_R : Motor rated speed (r/min.)

J_M : Motor moment of inertia ($\text{kg}\cdot\text{m}^2 = \text{lb}\cdot\text{in}\cdot\text{s}^2$) . . . ($\text{GD}^2_M/4$)

J_L : Load converted to shaft moment of inertia ($\text{kg}\cdot\text{m}^2$) . . ($\text{GD}^2_L/4$)

K_t : Motor torque constant ($\text{N}\cdot\text{m}/\text{A} = \text{lb}\cdot\text{in}/\text{A}$)

I_R : Motor rated current (A)

$\alpha = I_P/I_R$: Accel/decel current coefficient

[where I_P is accel/decel current (accel/decel current is α times the motor rated current) (A)]

$\beta = I_L/I_R$: Load current coefficient

[I_L : Load torque equivalent current (load current is β times the motor rated current) (A)]

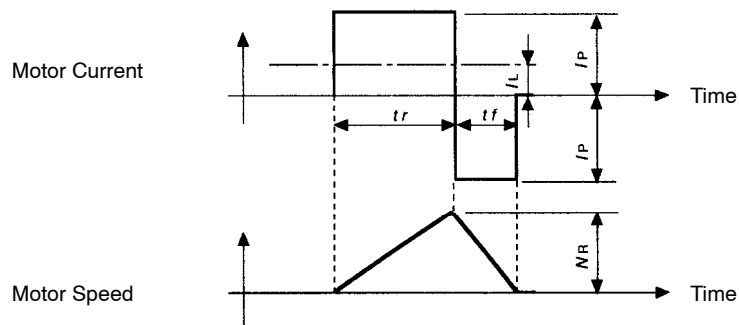

Motor Current (size) - Motor Speed Timing Chart

5.3.4 Load Inertia

- 1) The larger the load inertia becomes, the worse the movement response of the load. The size of the load inertia [J_L] allowable when using a Servomotor depends on the motor capacity, as shown in the diagrams below.

- Small Load Inertia

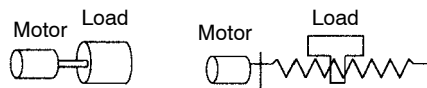

• Large Load Inertia

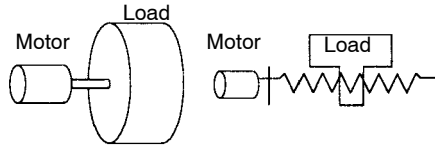

a) SGM Servomotors
200-VAC Servomotors with incremental encoder

Load Inertia
 $\text{kg}\cdot\text{m}^2 \times 10^{-4}$
 $(\text{oz}\cdot\text{in}\cdot\text{s}^2 \times 10^{-3})$

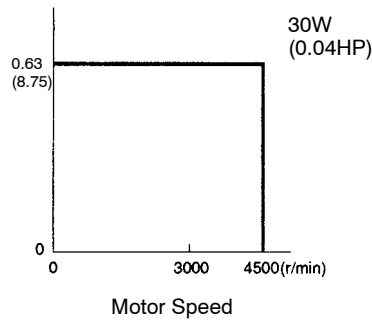

Load Inertia
 $\text{kg}\cdot\text{m}^2 \times 10^{-4}$
 $(\text{oz}\cdot\text{in}\cdot\text{s}^2 \times 10^{-3})$

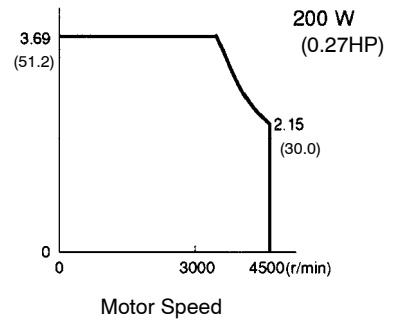

Load Inertia
 $\text{kg}\cdot\text{m}^2 \times 10^{-4}$
 $(\text{oz}\cdot\text{in}\cdot\text{s}^2 \times 10^{-3})$

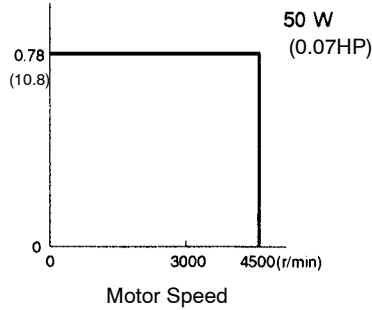

Load Inertia
 $\text{kg}\cdot\text{m}^2 \times 10^{-4}$
 $(\text{oz}\cdot\text{in}\cdot\text{s}^2 \times 10^{-3})$

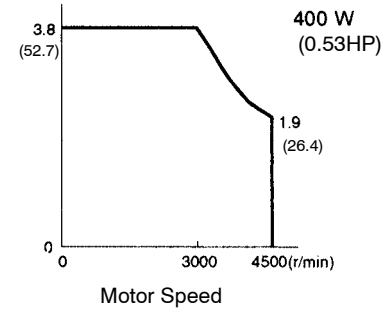

Load Inertia
 $\text{kg}\cdot\text{m}^2 \times 10^{-4}$
 $(\text{oz}\cdot\text{in}\cdot\text{s}^2 \times 10^{-3})$

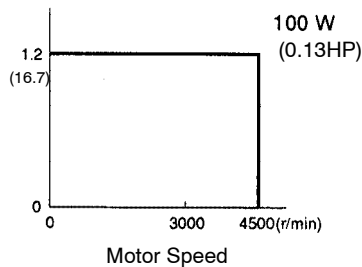

Load Inertia
 $\text{kg}\cdot\text{m}^2 \times 10^{-4}$
 $(\text{oz}\cdot\text{in}\cdot\text{s}^2 \times 10^{-3})$

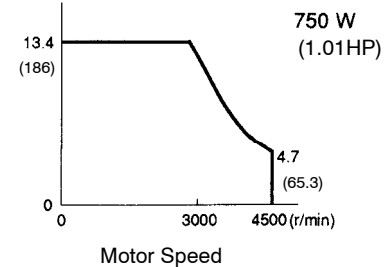

Note The above diagrams represent deceleration under maximum torque. Applying an acceleration/deceleration curve to the reference allows operation outside the range of the diagrams. (That is, characteristics change according to pattern of operation and load conditions).

5

b) SGMP Servomotors
200-VAC Servomotors with incremental encoder

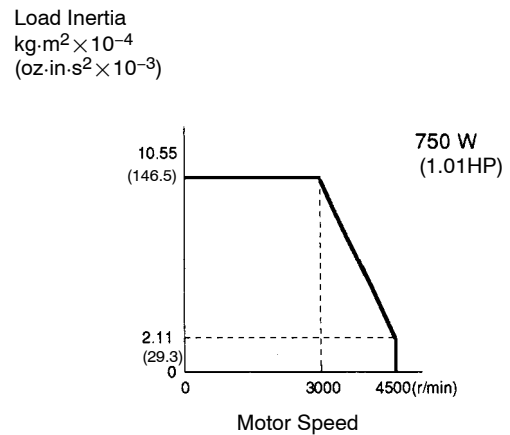
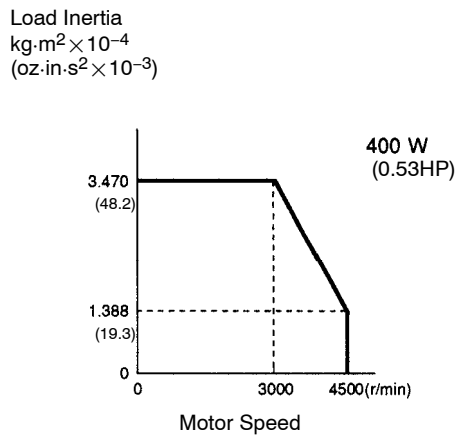
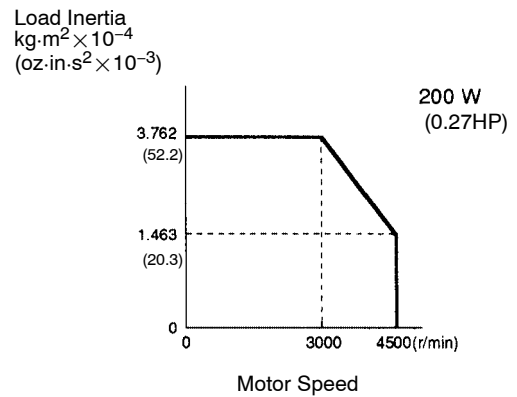
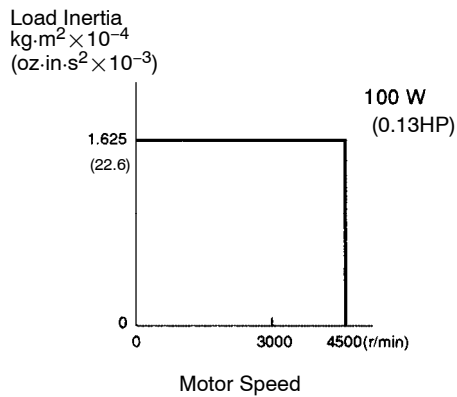

Note Diagrams above represent deceleration under maximum torque. Applying an acceleration/ deceleration curve to the reference allows operation outside the range of the diagrams. (That is, the characteristics change according to pattern of operation and load conditions).

- 2) An overvoltage alarm is likely during deceleration if the load inertia exceeds the range of the diagrams. Take one of the countermeasures below.
 - a) Reduce the torque limit value.
 - b) Reduce the deceleration rate.
 - c) Reduce the maximum speed used.
 - d) Add a regenerative unit.

5.3.5 Overhanging Loads

1) A Servomotor may not be operated under an overhanging load, that is a load which tends to continually rotate the motor.

Under an overhanging load (e.g. when the direction of the torque applied by the motor is opposite from the direction of shaft rotation), the Servopack regenerative brake is applied continuously and the regenerative energy of the load may exceed the allowable range and damage the Servopack.

The regenerative brake capacity of the SGDA Servopack is rated for short-time operation, approximately equivalent to the deceleration stopping time.

- Overhanging Load Example 1: Motor drive for vertical axis, using no counterweight

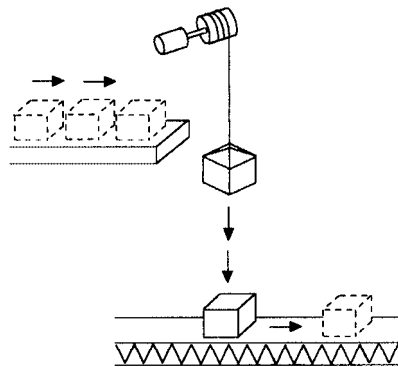

- Overhanging Load Example 2: Tension control drive

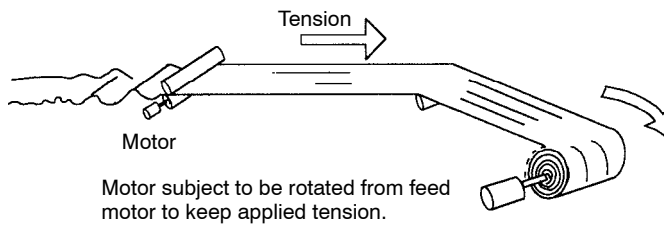

5.3.6 In-rush Current and Power Loss

Servopack SGDA-		In-rush Current (Peak Value) A	Output Current (Effective Value) A	Power Loss W
Supply Voltage 200V	A3 (30W-0.04HP)	35	0.42	15
	A5 (50W-0.07HP)	35	0.6	18
	01 (100W-0.13HP)	35	0.87	20
	02 (200W-0.27HP)	350	2.0	35
	04 (400W-0.53HP)	35	2.6	45
	08 (750W-1.01HP)	70	4.4	60
Supply Voltage 100V	A3 (30W-0.04HP)	18	0.63	17
	A5 (50W-0.07HP)	18	0.9	20
	01 (100W-0.13HP)	18	2.2	30
	02 (200W-0.27HP)	18	2.7	47
	03 (300W-0.40HP)	35	3.7	70

5.4 Σ -Series Dimensional Drawings

This section presents dimensional drawings of the Σ -Series Servomotor, Servopack, and Digital Operator.

5.4.1	Servomotor Dimensional Drawings	246
5.4.2	Servopack Dimensional Drawings	289
5.4.3	Digital Operator Dimensional Drawings	291

5.4.1 Servomotor Dimensional Drawings

1) The dimensional drawings of the SGM Servomotors are broadly grouped into the following four categories.

- a) Incremental encoder, no brake (from page 247)
- b) Incremental encoder, with brake (from page 252)
- c) Absolute encoder, no brake (from page 257)
- d) Absolute encoder, with brake (from page 262)

Motor capacities are available as 30 W (0.04 HP), 50 W (0.07 HP), 100 W (0.13 HP), 200 W (0.27 HP), 300 W (0.40 HP), 400 W (0.53 HP), 750 W (1.01 HP). These are grouped into three categories, as follows:

- 30W (0.04 HP), 50W (0.07 HP), 100W (0.13 HP)
- 200W (0.27 HP), 300W (0.40 HP), 400W (0.53 HP)
- 750W (1.01 HP)

(1) SGM Servomotor
Incremental encoder, no brake (Type SGM-□□□31□)

- 30W (0.04 HP), 50W (0.07 HP), 100W (0.13 HP)

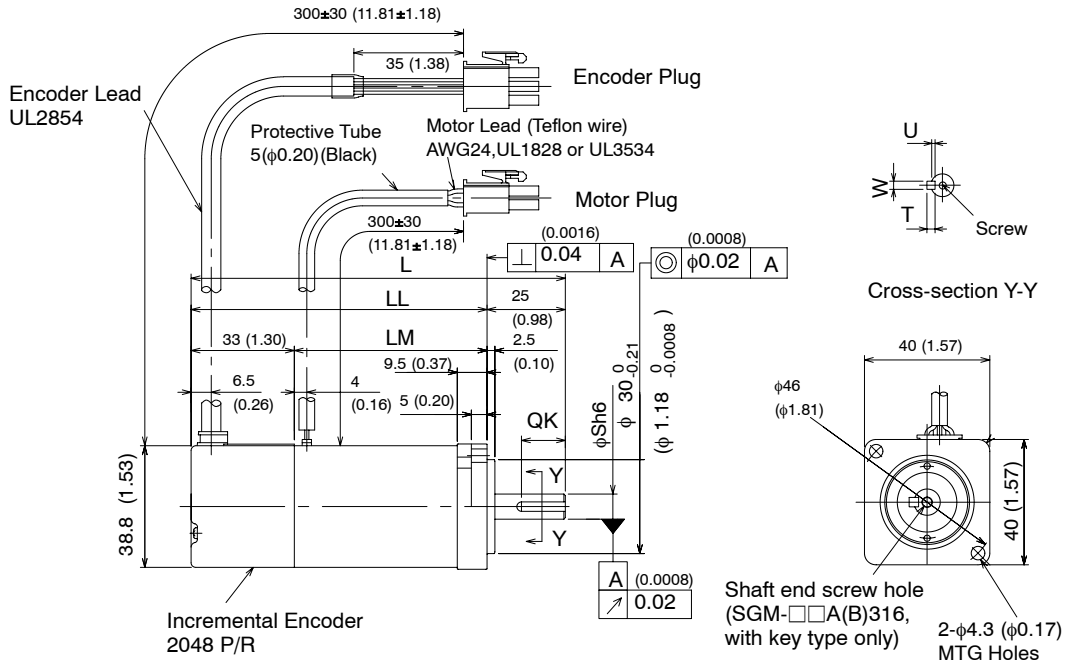

Type SGM-	L	LL	LM	S	QK	U	W	T	Screw Dimensions	Output W (HP)	Approx. mass kg (lb)	Allowable radial load N (lb)	Allowable thrust load N (lb)
A3A312	94.5 (3.72)	69.5 (2.74)	36.5 (1.44)	6 (0.24)	No key				—	30 (0.04)	0.3 (0.66)	68 (15)	54 (12)
A3B312					14 (0.55)	1.2 (0.05)	2 (0.08)	2 (0.08)					
A3A314													
A3B314													
A3A316													
A3B316													
A5A312	102.0 (4.02)	77.0 (3.03)	44.0 (1.73)	6 (0.24)	No key				—	50 (0.07)	0.4 (0.88)	78 (18)	
A5B312					14 (0.55)	1.2 (0.05)	2 (0.08)	2 (0.08)					
A5A314													
A5B314													
A5A316													
A5B316													
01A312	119.5 (4.70)	94.5 (3.72)	61.5 (2.42)	8 (0.31)	No key				—	100 (0.13)	0.5 (1.10)	78 (18)	
01B312					14 (0.55)	1.8 (0.07)	3 (0.12)	3 (0.12)					
01A314													
01B314													
01A316													
01B316													

SERVO SELECTION AND DATA SHEETS

5.4.1 Servomotor Dimensional Drawings cont.

- Note**
- 1) The detector uses an incremental encoder 2048 P/R.
 - 2) Type "A" indicates 200 V specification, and type "B" indicates 100 V specification.
 - 3) "A3A(B)314", "A3A(B)316", "A5A(B)314", "A5A(B)316", "01A(B)314" and "01A(B)316" have a keyed shaft. The keyway complies with JIS B 1301-1976 (precision). A straight key is supplied.
 - 4) The quoted allowable radial load is the value at a position 20 mm (0.79 in.) from the motor mounting surface.

• 200 W (0.27 HP), 300 W (0.40 HP), 400 W (0.53 HP)

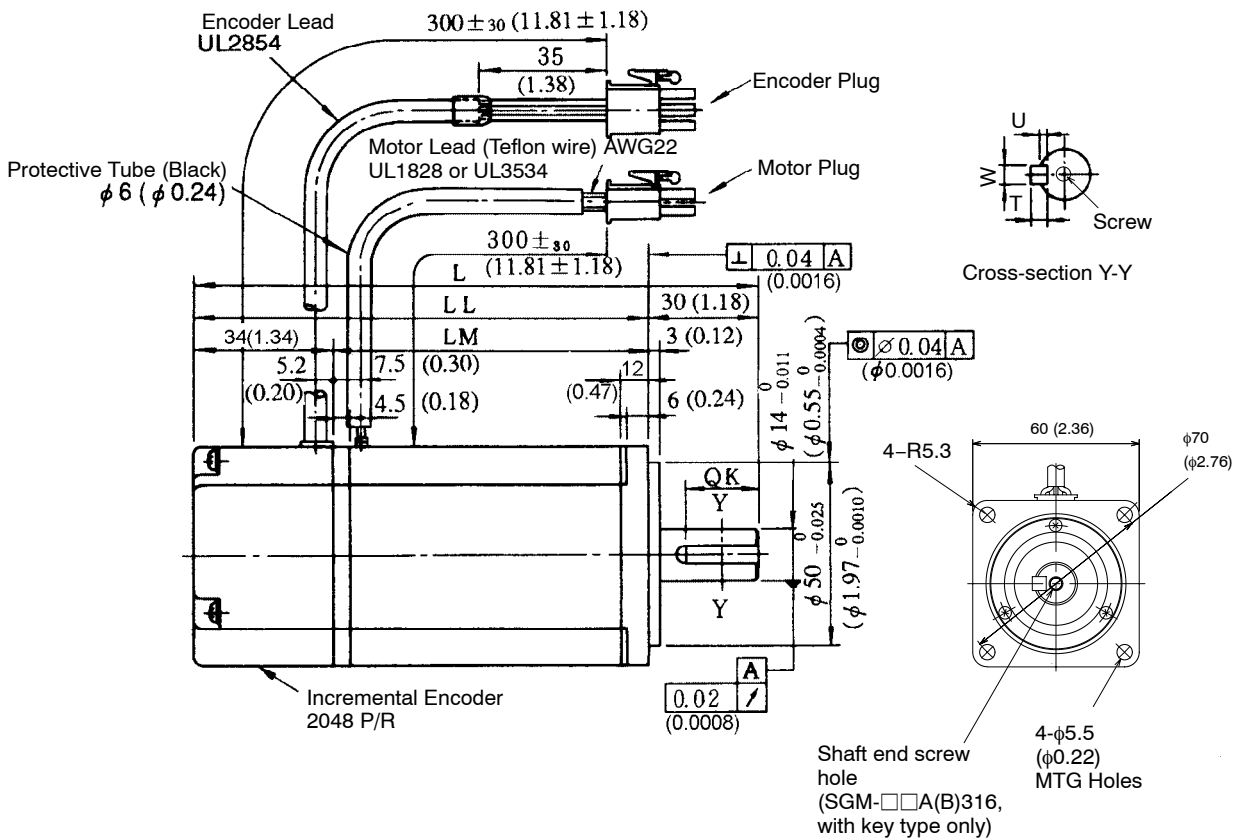

5

Type SGM-	L	LL	LM	QK	U	W	T	Screw Dimensions	Output W (HP)	Approx. mass kg (lb)	Allowable radial load N (lb)	Allowable thrust load N (lb)
02A312	126.5 (4.98)	96.5 (3.80)	62.5 (2.46)	No key				—	200 (0.27)	1.1 (2.43)	245 (55.1)	74 (17)
02B312												
02A314				20 (0.79)	3 (0.12)	5 (0.20)	5 (0.20)					
02B314												
02A316								M5, depth 8 (0.31)				
02B316												
03B312	154.5 (6.08)	124.5 (4.90)	90.5 (3.56)	No key				—	300 (0.40)	1.7 (3.75)		
03B314				20 (0.79)	3 (0.12)	5 (0.20)	5 (0.20)					
03B316												
04A312				No key								
04A314				20 (0.79)	3 (0.12)	5 (0.20)	5 (0.20)	400 (0.53)				
04A316												

- Note**
- 1) The detector uses an incremental encoder 2048 P/R.
 - 2) Type “A” indicates 200 V specification, and type “B” indicates 100 V specification.
 - 3) “02A(B)314”, “02A(B)316”, “03B314”, “03B316”, “04A314” and “04A316” have a keyed shaft. The keyway complies with JIS B 1301-1976 (precision). A straight key is supplied.
 - 4) The quoted allowable radial load is the value at a position 25 mm (0.98 in.) from the motor mounting surface.

SERVO SELECTION AND DATA SHEETS

5.4.1 Servomotor Dimensional Drawings cont.

• 750 W (1.01 HP)

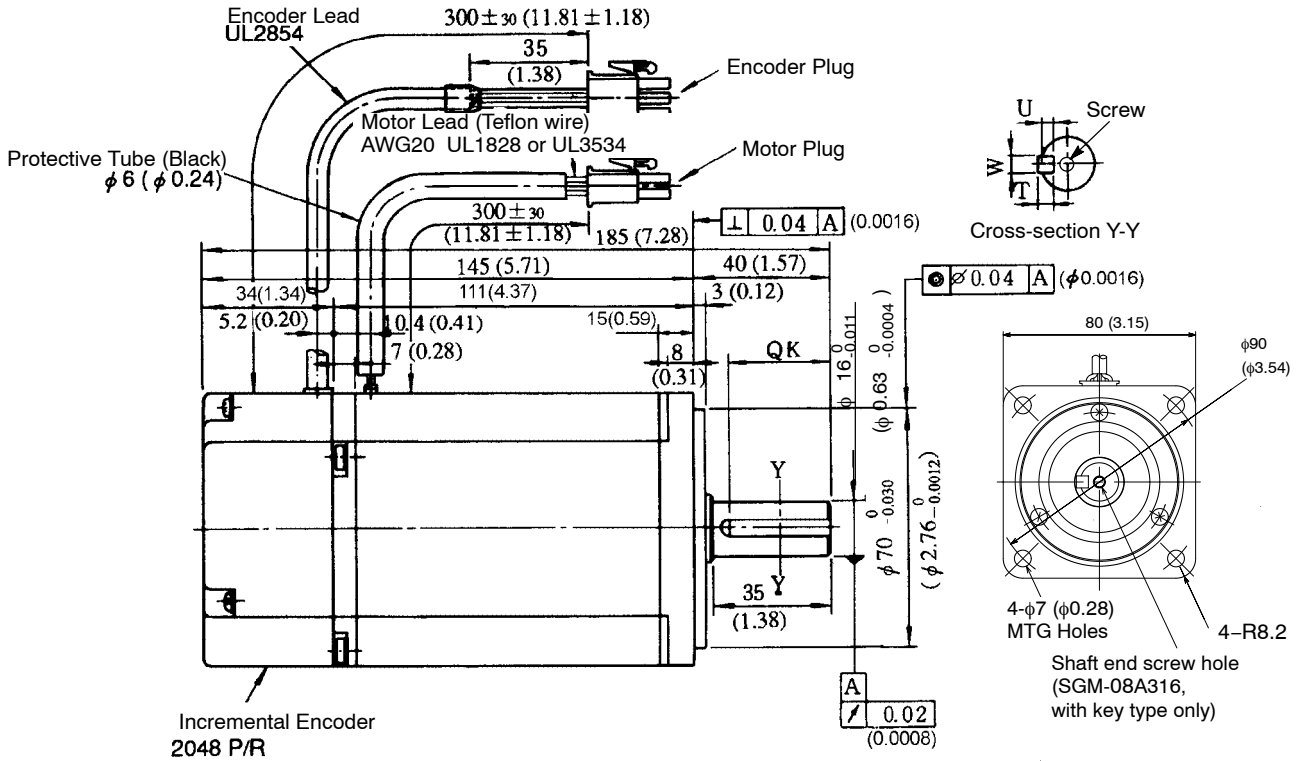

Type SGM-	QK	U	W	T	Screw Dimensions	Output W (HP)	Approx. mass kg (lb)	Allowable radial load N (lb)	Allowable thrust load N (lb)
08A312	No key				—	750 (1.01)	3.4 (7.50)	392 (88)	147 (33)
08A314	30 (1.18)	3 (0.12)	5 (0.20)	5 (0.20)					
08A316	M5, depth 8(0.31)								

- Note**
- 1) The detector uses an incremental encoder 2048 P/R.
 - 2) Type “A” indicates 200 V specification.
 - 3) “08A314” and “08A316” have a keyed shaft. The keyway complies with JIS B 1301-1976 (precision). A straight key is supplied.
 - 4) The quoted allowable radial load is the value at a position 35 mm (1.38 in.) from the motor mounting surface.

• Details of Motor and Encoder Plugs (Common for 30 W (0.04 HP) to 750 W (1.01 HP))

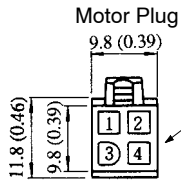

Plug : 172167-1 (AMP)
 Pin: 170360-1 or 170364-1
 (170359-1 or 170363-1: 30, 50, or 100 W only)
 Connected to
 Cap: 172159-1
 Socket: 170362 -1 or 170366-1

Motor Wiring Specifications

1	U phase	Red
2	V phase	White
3	W phase	Blue
4	FG	Green

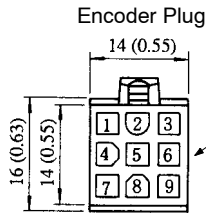

Plug: 172169-1 (Made by AMP)
 Pin: 170359-1 or 170363-1
 Connected to
 Cap :172161-1
 Socket: 170361-1 or 170365-1

Incremental Encoder Wiring Specifications

1	A channel output	Blue
2	\bar{A} channel output	Blue/Black
3	B channel output	Yellow
4	\bar{B} channel output	Yellow/Black
5	C channel output	Green
6	\bar{C} channel output	Green/Black
7	0V (power supply)	Gray
8	+5V (power supply)	Red
9	FG (Frame Ground)	Orange

- Note**
- 1) The detector uses an incremental encoder 2048 P/R.
 - 2) Type “A” indicates 200 V specification, and type “B” indicates 100 V specification.
 - 3) “A3A(B)314B”, “A3A(B)316B”, “A5A(B)314B”, “A5A(B)316B”, “01A(B)314B” and “01A(B)316B” have a keyed shaft. The keyway complies with JIS B 1301-1976 (precision). A straight key is supplied.
 - 4) The quoted allowable radial load is the value at a position 20 mm (0.79 in.) from the motor mounting surface.
 - 5) The electromagnetic brake is only to hold the load in position and cannot be used to stop the motor.

SERVO SELECTION AND DATA SHEETS

5.4.1 Servomotor Dimensional Drawings cont.

- 200 W (0.53 HP), 300 W (0.40 HP), 400 W (0.27 HP)

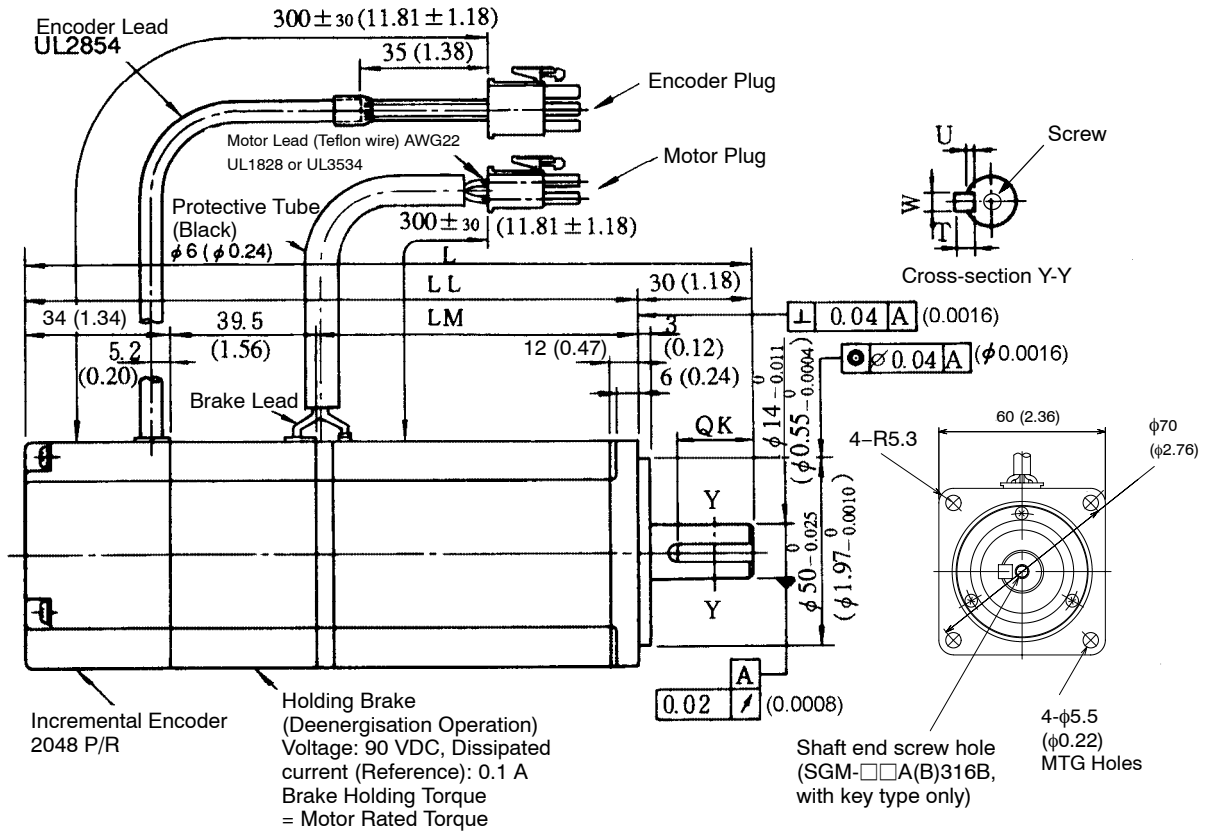

Type SGM-	L	LL	LM	QK	U	W	T	Screw Dimensions	Output W (HP)	Approx. mass kg (lb)	Allowable radial load N (lb)	Allowable thrust load N (lb)
02A312B	166.0 (6.54)	136.0 (5.35)	62.5 (2.46)	No key				M5, depth 8 (0.31)	200 (0.27)	1.6 (3.53)	245 (55.1)	74 (17)
02B312B												
02A314B				20 (0.79)	3 (0.12)	5 (0.20)	5 (0.20)					
02B314B												
02A316B												
02B316B												
03B312B	194.0 (7.64)	164.0 (6.46)	90.5 (3.56)	No key				M5, depth 8 (0.31)	300 (0.40)	2.2 (4.85)	245 (55.1)	74 (17)
03B314B				20 (0.79)	3 (0.12)	5 (0.20)	5 (0.20)					
03B316B												
04A312B	194.0 (7.64)	164.0 (6.46)	90.5 (3.56)	No key				M5, depth 8 (0.31)	400 (0.53)	2.2 (4.85)	245 (55.1)	74 (17)
04A314B				20 (0.79)	3 (0.12)	5 (0.20)	5 (0.20)					
04A316B												

Note 1) The detector uses an incremental encoder 2048 P/R.

2) Type "A" indicates 200 V specification, and type "B" indicates 100 V specification.

- 3) "02A(B)314B", "02A(B)316B", "03B314B", "03B316B", "04A314B" and "04A316B" have a keyed shaft. The keyway complies with JIS B 1301-1976 (precision). A straight key is supplied.
- 4) The quoted allowable radial load is the value at a position 25 mm (0.98 in.) from the motor mounting surface.
- 5) The electromagnetic brake is only to hold the load in position and cannot be used to stop the motor.

• 750 W (1.01 HP)

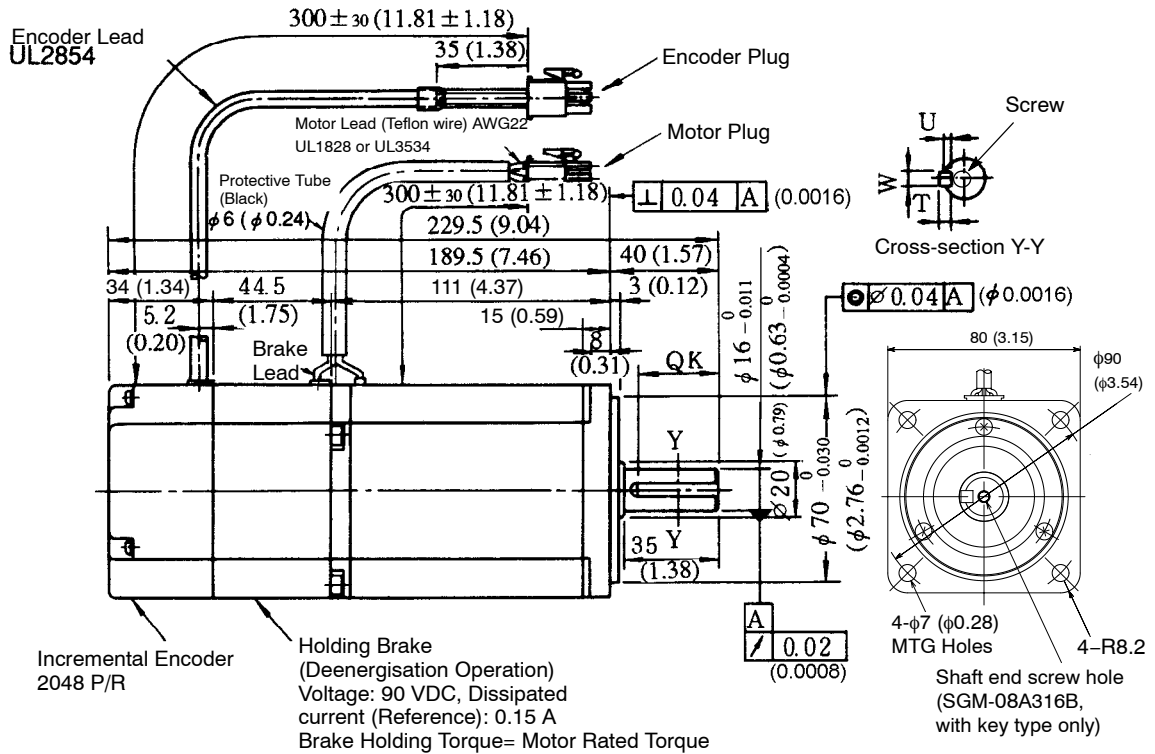

Type SGM-	QK	U	W	T	Screw Dimensions	Output W (HP)	Approx. mass kg (lb)	Allowable radial load N (lb)	Allowable thrust load N (lb)
08A312B	No key				—	750 (1.01)	4.3 (9.48)	392 (88)	147 (33)
08A314B	30 (1.18)	3 (0.12)	5 (0.20)	5 (0.20)	M5, depth 8 (0.31)				
08A316B									

- Note**
- 1) The detector uses an incremental encoder 2048 P/R.
 - 2) Type "A" indicates 200 V specification.
 - 3) "08A314B" and "08A316B" have a keyed shaft. The keyway complies with JIS B 1301-1976 (precision). A straight key is supplied.

SERVO SELECTION AND DATA SHEETS

5.4.1 Servomotor Dimensional Drawings

- 4) The quoted allowable radial load is the value at a position 35 mm (1.38 in.) from the motor mounting surface.
- 5) The electromagnetic brake is only to hold the load in position and cannot be used to stop the motor.

• Details of Motor and Encoder Plugs (Common for 30 W (0.04 HP) to 750 W (1.01 HP))

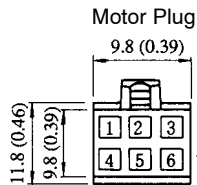

Plug : 172168-1 (AMP)
 Pin: 170360-1 or 170364-1
 (17359-1 or 170363-1: 30, 50, or
 100 W only)
 Connected to
 Cap: 172160-1
 Socket: 170362 -1 or 170366-1

Motor Wiring Specifications

1	U phase	Red
2	V phase	White
3	W phase	Blue
4	FG	Green/Yellow
5	Brake terminal	Red
6	Brake terminal	Black

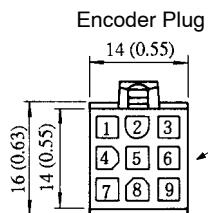

Plug: 172169-1 (AMP)
 Pin: 170359-1 or 170363-1
 Connected to
 Cap :172161-1
 Socket: 170361-1 or 170365-1

Incremental Encoder Wiring Specifications

1	A channel output	Blue
2	\bar{A} channel output	Blue/Black
3	B channel output	Yellow
4	\bar{B} channel output	Yellow/Black
5	C channel output	Green
6	\bar{C} channel output	Green/Black
7	0V (power supply)	Gray
8	+5V (power supply)	Red
9	FG (Frame Ground)	Orange

(3) SGM Servomotor
Absolute encoder, no brake (Type SGM-□□□W1□)

- 30 W (0.04 HP), 50 W (0.07 HP), 100 W (0.13 HP)

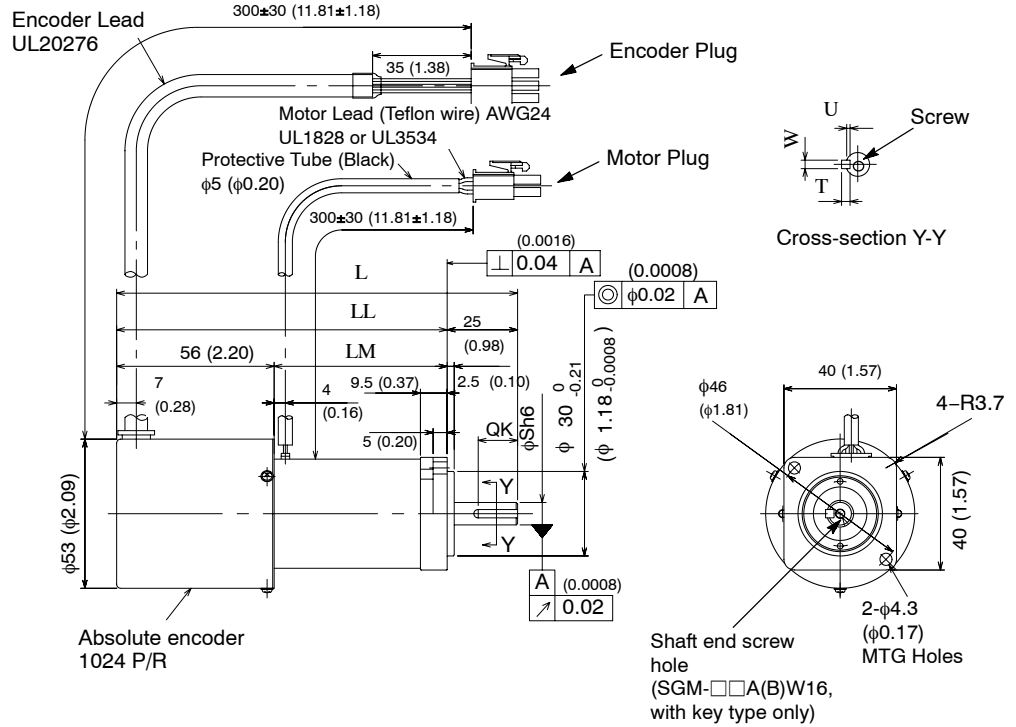

Type SGM-	L	LL	LM	S	QK	U	W	T	Screw Dimensions	Output W (HP)	Approx mass kg (lb)	Allowable radial load N (lb)	Allowable thrust load N (lb)
A3AW12	117.5 (4.63)	92.5 (3.64)	36.5 (1.44)	6 (0.24)	No key				---	30 (0.04)	0.45 (0.99)	68 (15.3)	54 (12.1)
A3BW12					14 (0.55)	1.2 (0.05)	2 (0.08)	2 (0.08)					
A3AW14													
A3BW14													
A3AW16													
A3BW16													
A5AW12	125.0 (4.92)	100.0 (3.94)	44.0 (1.73)	6 (0.24)	No key				---	50 (0.07)	0.55 (1.21)	68 (15.3)	
A5BW12					14 (0.55)	1.2 (0.05)	2 (0.08)	2 (0.08)					
A5AW14													
A5BW14													
A5AW16													
A5BW16													
01AW12	142.5 (5.61)	117.5 (4.63)	61.5 (2.42)	8 (0.31)	No key				---	100 (0.13)	0.65 (1.43)	78 (17.5)	
01BW12					14 (0.55)	1.8 (0.07)	3 (0.12)	3 (0.12)					
01AW14													
01BW14													
01AW16													
01BW16													

Type SGM-	L	LL	LM	QK	U	W	T	Screw Dimensions	Output W (HP)	Approx. mass kg (lb)	Allowable radial load N (lb)	Allowable thrust load N (lb)	
02AW12	147.5 (5.81)	117.5 (4.63)	62.5 (2.46)	No key				—	200 (0.27)	1.2 (2.65)	245 (55.1)	74 (16.6)	
02BW12													
02AW14				20 (0.79)	3 (0.12)	5 (0.20)	5 (0.20)						
02BW14													
02AW16								M5, depth 8 (0.31)					
02BW16													
03BW12	175.5 (6.91)	145.5 (5.73)	90.5 (3.56)	No key				—	300 (0.40)	1.8 (3.97)			
03BW14													
03BW16				20 (0.79)	3 (0.12)	5 (0.20)	5 (0.20)						M5, depth 8 (0.31)
04AW12				No key				—					
04AW14				20 (0.79)	3 (0.12)	5 (0.20)	5 (0.20)						400 (0.53)
04AW16													

- Note**
- 1) The detector uses a 12-bit absolute encoder 1024 P/R.
 - 2) Type “A” indicates 200 V specification, and type “B” indicates 100 V specification.
 - 3) “02A(B)W14”, “02A(B)W16”, “03BW14”, “03BW16”, “04AW14” and “04AW16” have a keyed shaft. The keyway complies with JIS B 1301-1976 (precision). A straight key is supplied.
 - 4) The quoted allowable radial load is the value at a position 25 mm (0.98 in.) from the motor mounting surface.

SERVO SELECTION AND DATA SHEETS

5.4.1 Servomotor Dimensional Drawings cont.

• 750 W (1.01 HP)

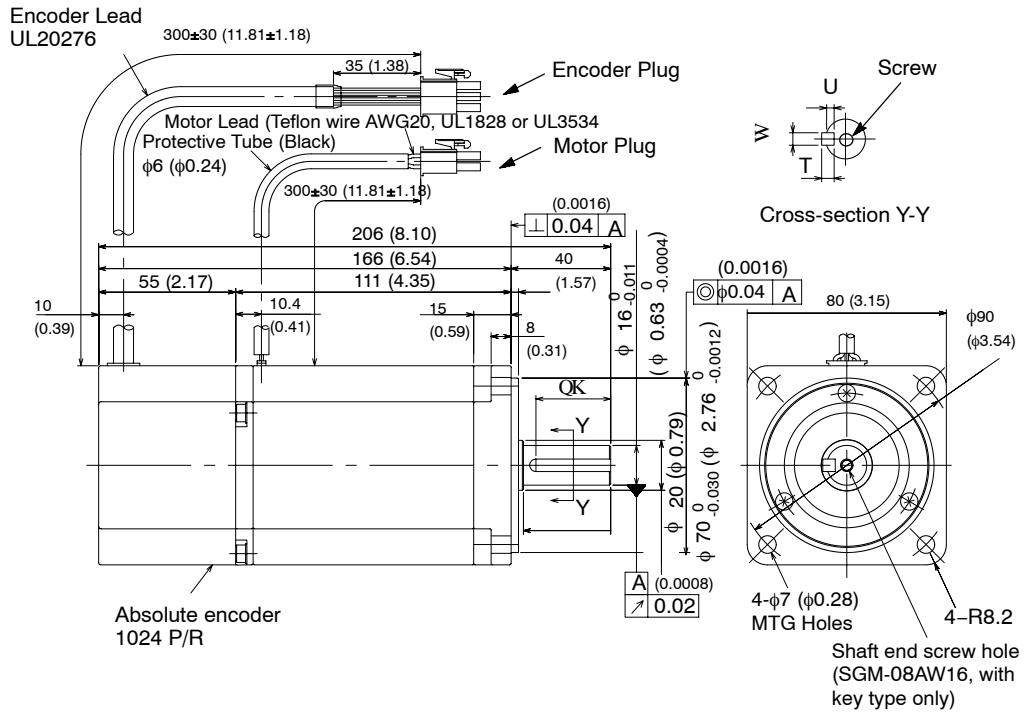

5

Type SGM-	QK	U	W	T	Screw Dimensions	Output W (HP)	Approx. mass kg (lb)	Allowable radial load N (Kgf)	Allowable thrust load N (Kgf)
08AW12	No key				M5, depth 8 (0.31)	750 (1.01)	3.5 (7.72)	392 (86.5)	147 (32.4)
08AW14	30 (1.18)	3 (0.12)	5 (0.20)	5 (0.20)					
08AW16									

- Note**
- 1) The detector uses a 12-bit absolute encoder 1024 P/R.
 - 2) Type "A" indicates 200 V specification.
 - 3) "08AW14" and "08AW16" have a keyed shaft. The keyway complies with JIS B 1301-1976 (precision). A straight key is supplied.
 - 4) The quoted allowable radial load is the value at a position 35 mm (1.38 in.) from the motor mounting surface.

- Details of Motor and Encoder Plugs (Common for 30 W (0.04 HP) to 750 W (1.01 HP))

Motor Plug



Plug : 172167-1 (AMP)
 Pin: 170360-1 or 170364-1
 (17359-1 or 170363-1: 30, 50, or
 100 W only)
 Connected to
 Cap: 172159-1
 Socket: 170362 -1 or 170366-1

Motor Wiring Specifications

1	U phase	Red
2	V phase	White
3	W phase	Blue
4	FG	Green/Yellow

Encoder Plug

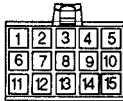

Plug: 172171-1 (AMP)
 Pin: 170359-1 or 170363-1
 Connected to
 Cap :172163-1
 Socket: 170361-1 or 170365-1

Incremental Encoder Wiring Specifications

1	A channel output	Blue
2	\bar{A} channel output	White/Blue
3	B channel output	Yellow
4	\bar{B} channel output	White/Yellow
5	Z channel output	Green
6	\bar{Z} channel output	White/Green
7	0V (power supply)	Gray
8	+5V (power supply)	Red
9	FG (Frame Ground)	Orange
10	S channel output	Purple
11	\bar{S} channel output	White/Purple
* (12)	(Capacitor reset)	(Gray)
13	Reset	White/Gray
14	0 V (battery)	White/Orange
15	3.6 V (battery)	Orange

* Terminal to discharge capacitor for product dispatch. Do not use.

(4) SGM Servomotor
 Absolute encoder, with brake (Type SGM-□□□W1□B)

- 30 W (0.04 HP), 50 W (0.07 HP), 100 W (0.13 HP)

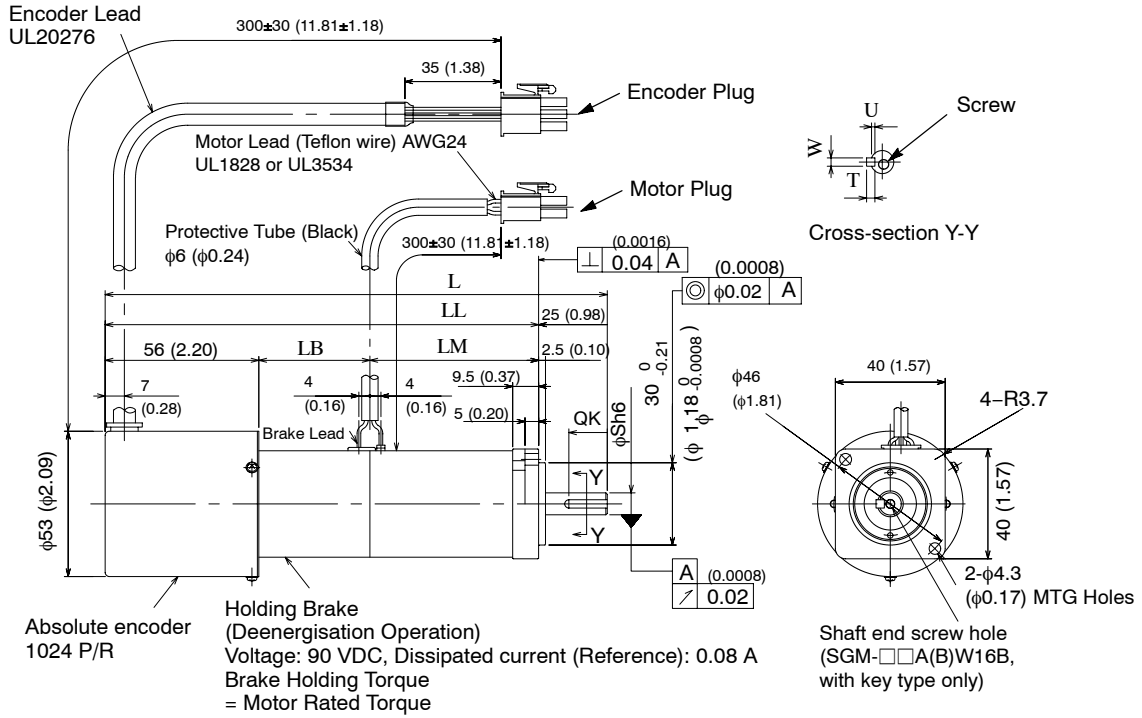

Type SGM-	L	LL	LM	LB	S	QK	U	W	T	Screw Dimensions	Output W (HP)	Approx. Mass kg (lb)	Allowable radial load N (lb)	Allowable thrust load N (lb)
A3AW12B	149.0 (5.87)	124.0 (4.88)	36.5 (1.44)	31.5 (1.24)	6 (0.24)	No key				—	30 (0.04)	0.75 (1.65)	68 (15.3)	54 (12.1)
A3BW12B						14 (0.55)	1.2 (0.05)	2 (0.08)	2 (0.08)					
A3AW14B										M2.5, depth 5 (0.20)				
A3BW14B														
A3AW16B														
A3BW16B														
A5AW12B	156.5 (6.16)	131.5 (5.18)	44.0 (1.73)			No key				—	50 (0.07)	0.85 (1.87)		
A5BW12B						14 (0.55)	1.2 (0.05)	2 (0.08)	2 (0.08)					
A5AW14B										M2.5, depth 5 (0.20)				
A5BW14B														
A5AW16B														
A5BW16B														
01AW12B	183.0 (7.20)	158.0 (6.22)	61.5 (2.42)	40.5 (1.59)	8 (0.31)	No key				—	100 (0.13)	0.95 (2.09)	78 (17.5)	
01BW12B						14 (0.55)	1.8 (0.07)	3 (0.12)	3 (0.12)					
01AW14B										M3, depth 6 (0.24)				
01BW14B														
01AW16B														
01BW16B														

- Note**
- 1) The detector uses a 12-bit absolute encoder 1024 P/R.
 - 2) Type "A" indicates 200 V specification, and type "B" indicates 100 V specification.
 - 3) "A3A(B)W14B", "A3A(B)W16B", "A5A(B)W14B", "A5A(B)W16B", "01A(B)W14B" and "01A(B)W16B" have a keyed shaft. The keyway complies with JIS B 1301-1976 (precision). A straight key is supplied.
 - 4) The quoted allowable radial load is the value at a position 20 mm (0.79 in.) from the motor mounting surface.
 - 5) The electromagnetic brake is only to hold the load in position and cannot be used to stop the motor.

SERVO SELECTION AND DATA SHEETS

5.4.1 Servomotor Dimensional Drawings cont.

- 200 W (0.27 HP), 300 W (0.40 HP), 400 W (0.53 HP)

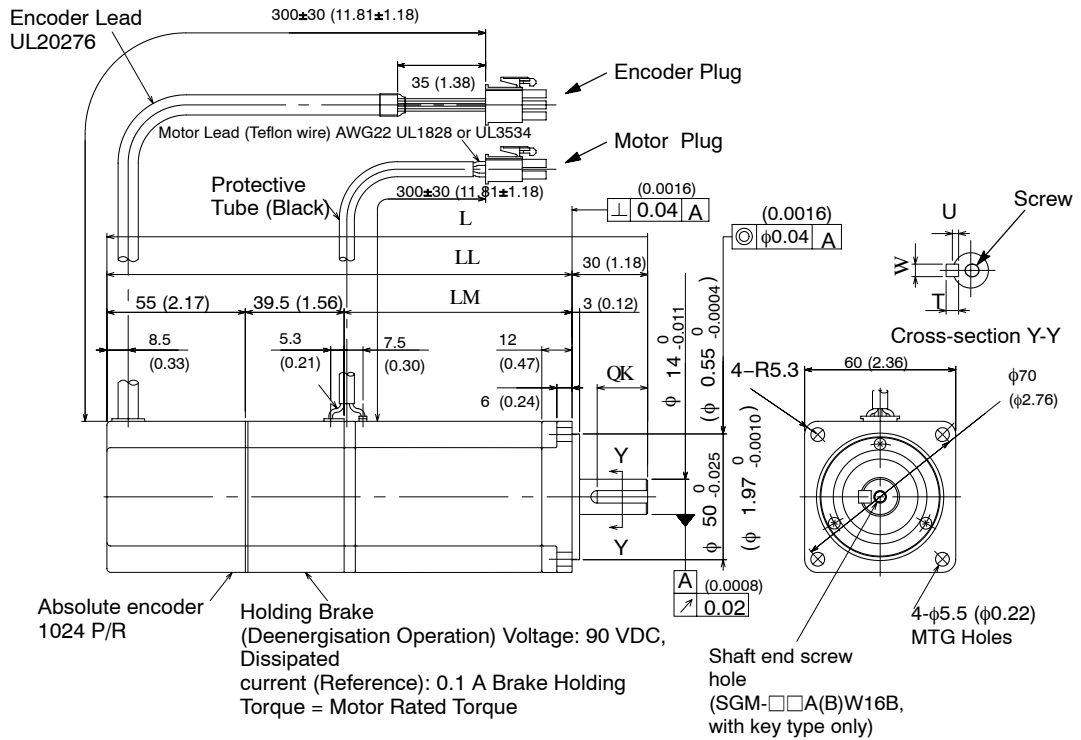

5

Type SGM-	L	LL	LM	QK	U	W	T	Screw Dimensions	Output W (HP)	Approx. mass kg (lb)	Allowable radial load N (lb)	Allowable thrust load N (lb)
02AW12B	187.0 (7.36)	157.0 (6.18)	62.5 (2.46)	No key				—	200 (0.27)	1.7 (3.75)	245 (55.1)	74 (16.6)
02BW12B				20 (0.79)	3 (0.12)	5 (0.20)	5 (0.20)					
02AW14B												
02BW14B												
02AW16B												
02BW16B				M5, depth 8 (0.31)								
03BW12B	215.0 (8.46)	185.0 (7.28)	90.5 (3.56)	No key				—	300 (0.40)	2.3 (5.07)		
03BW14B				20 (0.79)	3 (0.12)	5 (0.20)	5 (0.20)					
03BW16B												M5, depth 8 (0.31)
04AW12B	215.0 (8.46)	185.0 (7.28)	90.5 (3.56)	No key				—	400 (0.53)			
04AW14B				20 (0.79)	3 (0.12)	5 (0.20)	5 (0.20)					
04AW16B												M5, depth 8 (0.31)

- Note**
- 1) The detector uses a 12-bit absolute encoder 1024 P/R.
 - 2) Type “A” indicates 200 V specification, and type “B” indicates 100 V specification.
 - 3) “02A(B)W14B”, “02A(B)W16B”, “03BW14B”, “03BW16B” “04AW14B” and “04AW16B” have a keyed shaft. The keyway complies with JIS B 1301-1976 (precision). A straight key is supplied.
 - 4) The quoted allowable radial load is the value at a position 25 mm (0.98 in.) from the motor mounting surface.
 - 5) The electromagnetic brake is only to hold the load in position and cannot be used to stop the motor.

SERVO SELECTION AND DATA SHEETS

5.4.1 Servomotor Dimensional Drawings cont.

• 750 W (1.01 HP)

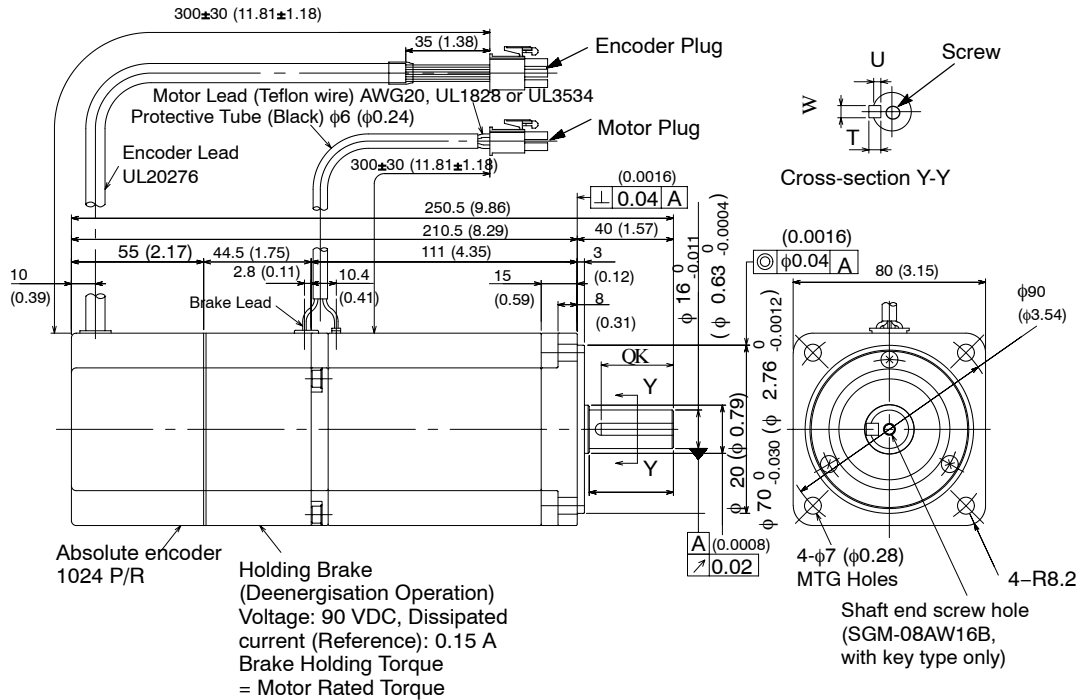

5

Type SGM-	QK	U	W	T	Screw Dimensions	Output W (HP)	Approx. mass kg (lb)	Allowable radial load N (lb)	Allowable thrust load N (lb)
08AW12B	No key				M5, depth 8 (0.31)	750 (1.01)	4.5 (9.92)	392 (86.5)	147 (32.4)
08AW14B	30 (1.18)	3 (0.12)	5 (0.20)	5 (0.20)					
08AW16B									

- Note**
- 1) The detector uses a 12-bit absolute encoder 1024 P/R.
 - 2) Type "A" indicates 200 V specification.
 - 3) "08AW14B" and "08AW16B" a keyed shaft. The keyway complies with JIS B 1301-1976 (precision). A straight key is supplied.
 - 4) The quoted allowable radial load is the value at a position 35 mm (1.38 in.) from the motor mounting surface.
 - 5) The electromagnetic brake is only to hold the load in position and cannot be used to stop the motor.

- Details of Motor and Encoder Plugs (Common for 30 W (0.04 HP) to 750 W (1.01 HP))

Motor Plug



Plug : 172168-1 (AMP)
 Pin: 170360-1 or 170364-1
 (17359-1 or 170363-1: 30, 50, or
 100 W only)
 Connected to
 Cap: 172160-1
 Socket: 170362 -1 or 170366-1

Motor Wiring Specifications

1	U phase	Red
2	V phase	White
3	W phase	Blue
4	FG	Green/Yellow
5	Brake terminal	Red
6	Brake terminal	Black

Encoder Plug

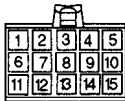

Plug: 172171-1 (AMP)
 Pin: 170359-1 or 170363-1
 Connected to
 Cap :172163-1
 Socket: 170361-1 or 170365-1

Incremental Encoder Wiring Specifications

1	A channel output	Blue
2	\bar{A} channel output	White/Blue
3	B channel output	Yellow
4	\bar{B} channel output	White/Yellow
5	Z channel output	Green
6	\bar{Z} channel output	White/Green
7	0V (power supply)	Black
8	+5V (power supply)	Red
9	FG (Frame Ground)	Green/Yellow
10	S channel output	Purple
11	\bar{S} channel output	White/Purple
* (12)	(Capacitor reset)	(Gray)
13	Reset	White/Gray
14	0 V (battery)	White/Orange
15	3.6 V (battery)	Orange

* Terminal to discharge capacitor for product dispatch. Do not use.

2) The dimensional drawings of the SGMP Servomotors are broadly grouped into the following four categories.

- a) Incremental encoder, no brake (from page 269)
- b) Incremental encoder, with brake (from page 274)
- c) Absolute encoder, no brake (from page 279)
- d) Absolute encoder, with brake (from page 283)

Motor capacities are available as 100 W (0.13 HP), 200 W (0.27 HP), 300 W (0.40 HP), 400 W (0.53 HP), 750 W (1.01 HP). These are grouped into three categories, as follows:

- 100W (0.13 HP)
- 200W (0.27 HP), 300W (0.40 HP), 400W (0.53 HP)
- 750W (1.01 HP)

- Note**
- 1) The detector uses an incremental encoder 2048 P/R.
 - 2) Type “A” indicates 200 V specification, and type “B” indicates 100 V specification.
 - 3) “02A(B)314”, “02A(B)316”, “03B314”, “03B316”, “04A314” and “04A316”, have a keyed shaft. The keyway complies with JIS B 1301-1976 (precision). A straight key is supplied.
 - 4) The quoted allowable radial load is the value at a position 25 mm (0.98 in.) from the motor mounting surface.
 - 5) Conforms to “IP55” protective structure (except connector and output shaft faces).

SERVO SELECTION AND DATA SHEETS

5.4.1 Servomotor Dimensional Drawings cont.

• 750 W (1.01 HP)

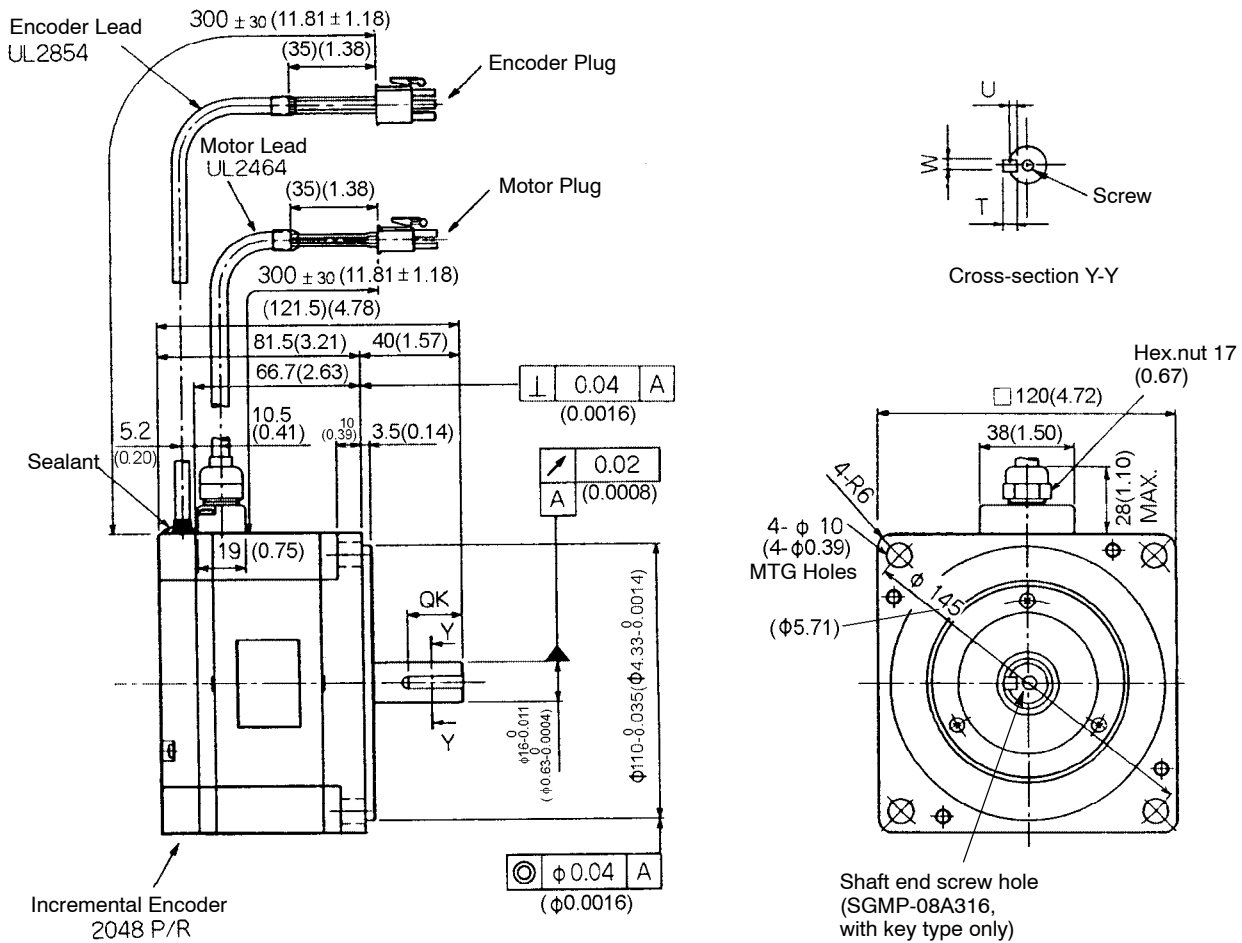

Type SGMP-	QK	U	W	T	Screw dimensions	Output W (HP)	Approx. mass kg (lb)	Allowable radial load N (lb)	Allowable thrust load N (lb)
08A312	No key				---	750 (1.01)	4.2 (9.26)	392 (80)	147 (33)
08A314	22 (0.87)	3 (0.12)	5 (0.20)	5 (0.20)	M5, depth 8 (0.31)				
08A316									

- Note**
- 1) The detector uses an incremental encoder 2048 P/R.
 - 2) Type "A" indicates 200 V specification.
 - 3) "08A314" and "08A316" have a keyed shaft. The keyway complies with JIS B 1301-1976 (precision). A straight key is supplied.
 - 4) The quoted allowable radial load is the value at a position 35 mm (1.38in.) from the motor mounting surface.
 - 5) Conforms to IP55 protective structure (except connector and output shaft faces).

5

- Details of Motor and Encoder Plugs (Common for 100 W (0.13HP) to 750 W (1.01HP))

Motor Plug



Plug : 172167-1 (AMP)
Pin: 170360-1 or 170364-1

Connected to
Cap 172159-1
Socket 170362-1 or 170366-1

Motor Wiring Specifications

1	U phase	Red
2	V phase	White
3	W phase	Blue
4	FG	Green/Yellow

Encoder Plug



Plug: 172169-1 (AMP)
Pin: 170359-1 or 170363-1

Connected to
Cap :172161-1
Socket: 170361-1 or 170365-1

Incremental Encoder Wiring Specifications

1	A channel output	Blue
2	\bar{A} channel output	Blue/Black
3	B channel output	Yellow
4	\bar{B} channel output	Yellow/Black
5	C channel output	Green
6	\bar{C} channel output	Green/Black
7	0V (power supply)	Gray
8	+5V (power supply)	Red
9	FG (Frame Ground)	Orange

SERVO SELECTION AND DATA SHEETS

5.4.1 Servomotor Dimensional Drawings cont.

(2) SGMP Servomotor
Incremental encoder, with brake (Type SGMP-□□□31□B)

• 100 W (0.13HP)

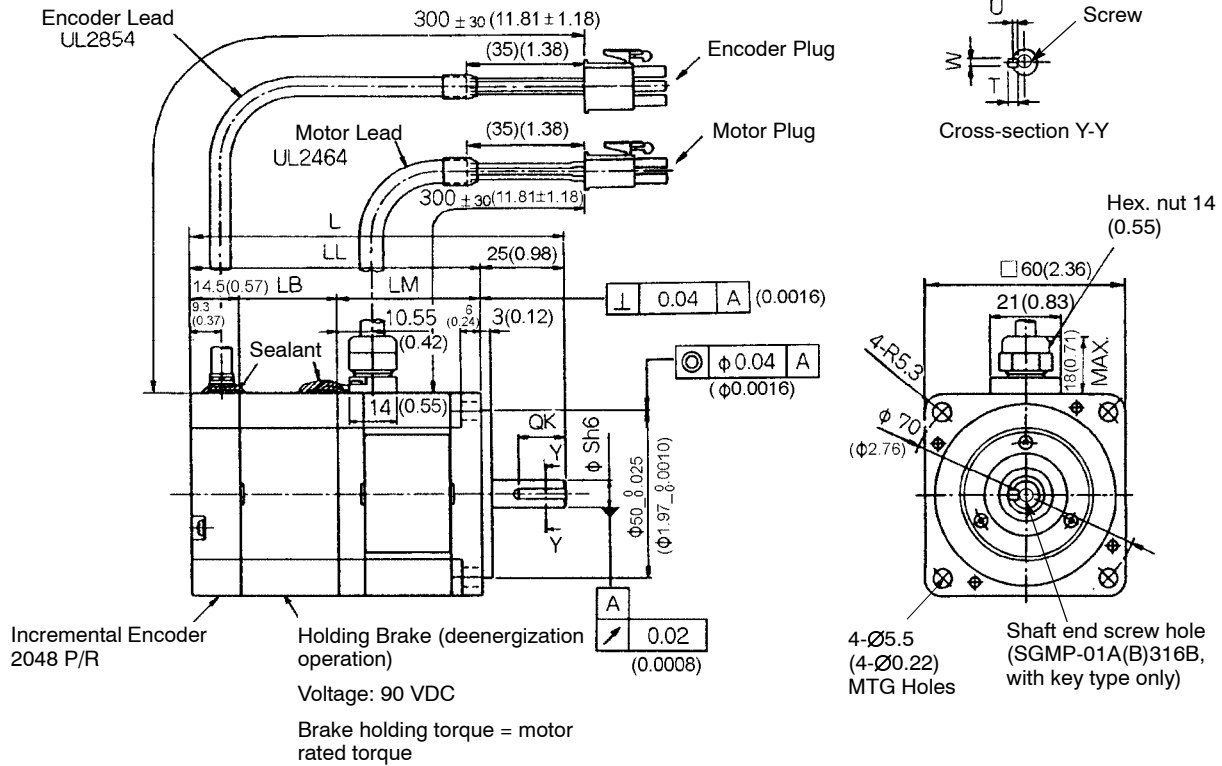

5

Type SGMP-	L	LL	LM	LB	S	QK	U	W	T	Screw dimensions	Output W (HP)	Approx. mass kg (lb)	Allowable radial load N (lb)	Allowable thrust load N (lb)	
01A312B	111	86	42.5	29	8	No key				---	100 (0.13)	0.9 (1.98)	78 (17)	49 (11)	
01B312B	(4.37)	(3.39)	(1.67)	(1.14)	(0.31)	14 (0.55)	1.8 (0.07)	3 (0.12)	3 (0.12)						
01A314B										M3, depth 6 (0.24)					
01B314B															
01A316B															
01B316B															

- Note**
- 1) The detector uses an incremental encoder 2048 P/R.
 - 2) Type "A" indicates 200 V specification, and type "B" indicates 100V specification.
 - 3) "01A314B", "01A316B", "01B314B" and "01B316B" have a keyed shaft. The keyway complies with JIS B 1301-1976 (precision). A straight key is supplied.

- 4) The quoted allowable radial load is the value at a position 20 mm (0.79in.) from the motor mounting surface.
- 5) The electromagnetic brake is only to hold the load in position and cannot be used to stop the motor.
- 6) Conforms to IP55 protective structure (except connector and output shaft faces).

• 200 W (0.27HP), 300W (0.40HP), 400 W (0.53HP)

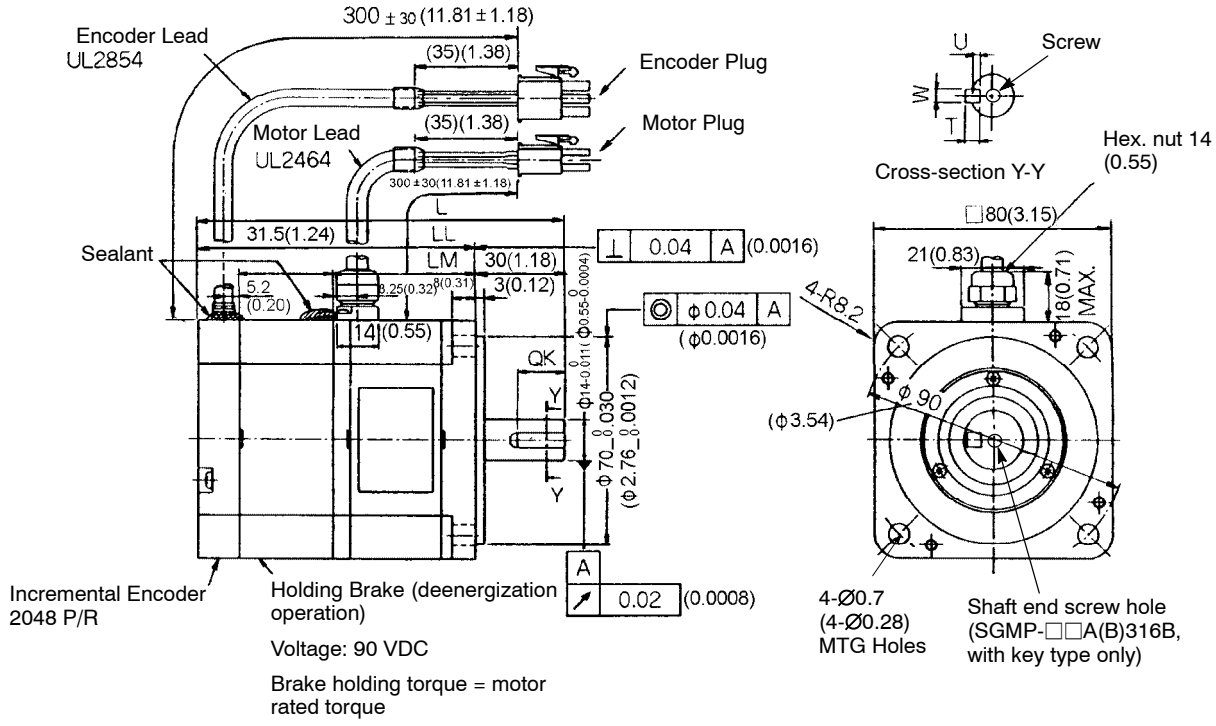

5

SERVO SELECTION AND DATA SHEETS

5.4.1 Servomotor Dimensional Drawings cont.

Type SGMP-	L	LL	LM	QK	U	W	T	Screw dimensions	Output W (HP)	Approx. mass kg (lb)	Allowable radial load N (lb)	Allowable thrust load N (lb)		
02A312B	123.5 (4.86)	93.5 (3.68)	48.1 (1.89)	No key				---	M5, depth 8 (0.31)	200 (0.27)	1.9 (4.19)	245 (55.1)	68 (15.4)	
02B312B														
02A314B				16 (0.63)	3 (0.12)	5 (0.20)	5 (0.20)							
02B314B														
02A316B														
02B316B														
03B312B	143.5 (5.65)	113.5 (4.47)	68.1 (2.68)	No key				---	M5, depth 8 (0.31)	300 (0.40)	2.6 (5.73)			
03B314B														
03B316B				16 (0.63)	3 (0.12)	5 (0.20)	5 (0.20)							
04A312B				No key				---						400 (0.53)
04A314B														
04A316B				16 (0.63)	3 (0.12)	5 (0.20)	5 (0.20)							

- Note**
- 1) The detector uses an incremental encoder 2048 P/R.
 - 2) Type "A" indicates 200 V specification, and type "B" indicates 100V specification.
 - 3) "02A(B)314B", "02A(B)316B", "03B314B", "03B316B", "04A314B" and "04A316B" have a keyed shaft. The keyway complies with JIS B 1301-1976 (precision). A straight key is supplied.
 - 4) The quoted allowable radial load is the value at a position 25 mm (0.98in.) from the motor mounting surface.
 - 5) The electromagnetic brake is only to hold the load in position and cannot be used to stop the motor.
 - 6) Conforms to IP55 protective structure (except connector and output shaft faces).

• 750 W (1.01HP)

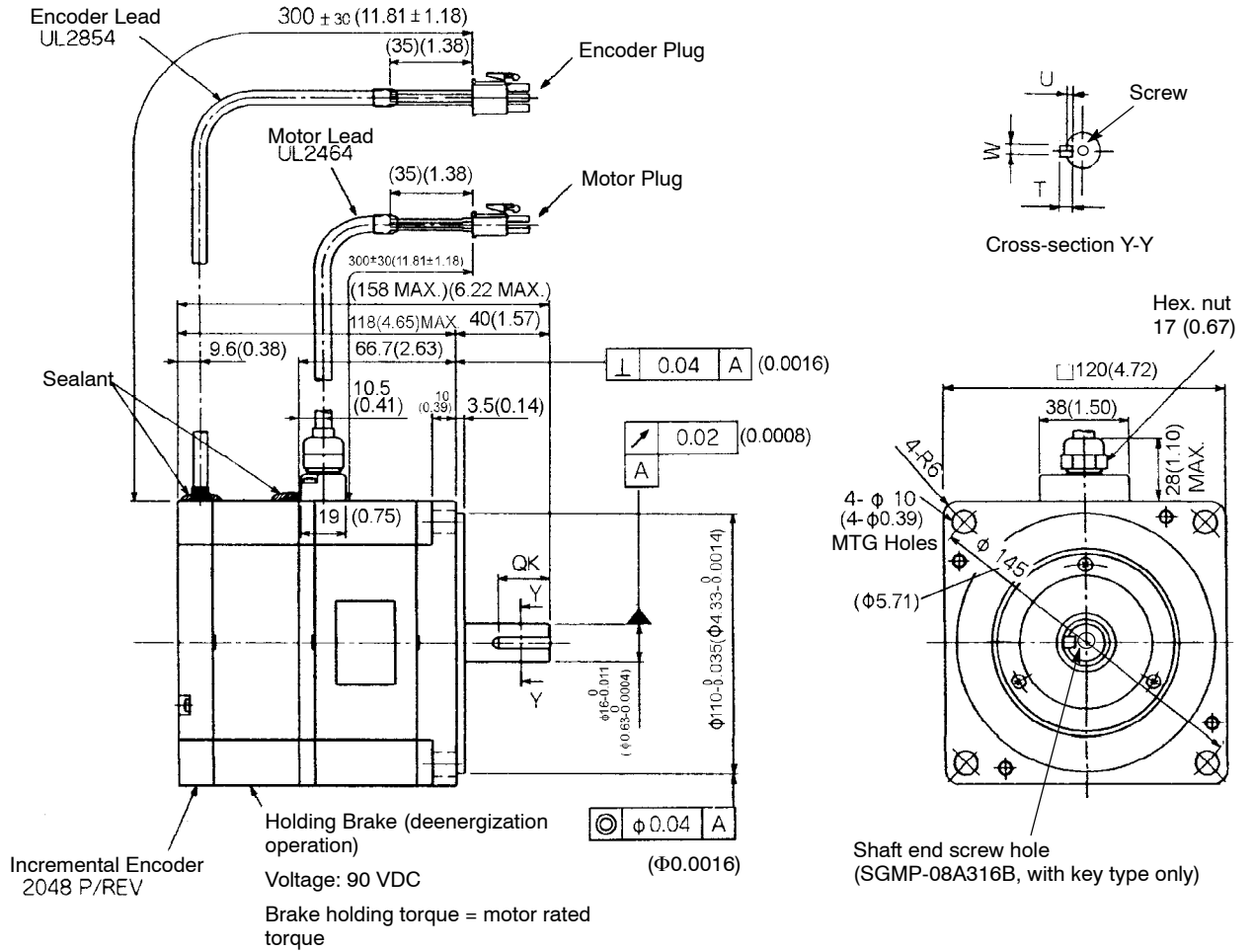

Type SGMP-	QK	U	W	T	Screw Dimensions	Output W (HP)	Approx. mass kg (lb)	Allowable radial load N (lb)	Allowable thrust load N (lb)
08A312B	No key				—	750 (1.01)	6.1 (13.45)	392 (88)	147 (33)
08A314B	22 (0.87)	3 (0.12)	5 (0.20)	5 (0.20)	M5, depth 8 (0.31)				
08A316B									

- Note**
- 1) The detector uses an incremental encoder 2048 P/R.
 - 2) Type "A" indicates 200 V specification.
 - 3) "08A314B" and "08A316B" have a keyed shaft. The keyway complies with JIS B 1301-1976 (precision).
A straight key is supplied.

SERVO SELECTION AND DATA SHEETS

5.4.1 Servomotor Dimensional Drawings cont.

- 4) The quoted allowable radial load is the value at a position 35 mm (1.38 in.) from the motor mounting surface.
- 5) The electromagnetic brake is only to hold the load in position and cannot be used to stop the motor.
- 6) Conforms to IP55 protective structure (except connector and output shaft faces).

• Details of Motor and Encoder Plugs (Common for 100 W (0.13 HP) to 750 W (1.01 HP))

Motor Plug



Plug : 172168-1 (AMP)
Pin 170360-1 or 170364-1
Connected to
Cap 172160-1
Socket 170362-1 or 170366-1

Encoder Plug



Plug: 172169-1 (AMP)
Pin: 170359-1 or 170366-1
Connected to
Cap :172161-1
Socket: 170361-1 or 170365-1

Motor Wiring Specifications

1	U phase	Red
2	V phase	White
3	W phase	Blue
4	FG	Green/Yellow
5	Brake	Black
6	Brake	Black

Incremental Encoder Wiring Specifications

1	A channel output	Blue
2	\bar{A} channel output	Blue/Black
3	B channel output	Yellow
4	\bar{B} channel output	Yellow/Black
5	C channel output	Green
6	\bar{C} channel output	Green/Black
7	0V (power supply)	Gray
8	+5V (power supply)	Red
9	FG (Frame Ground)	Orange

(3) SGMP Servomotor
Absolute encoder, no brake (Type SGMP-□□□W1□)

• 100 W (0.13HP)

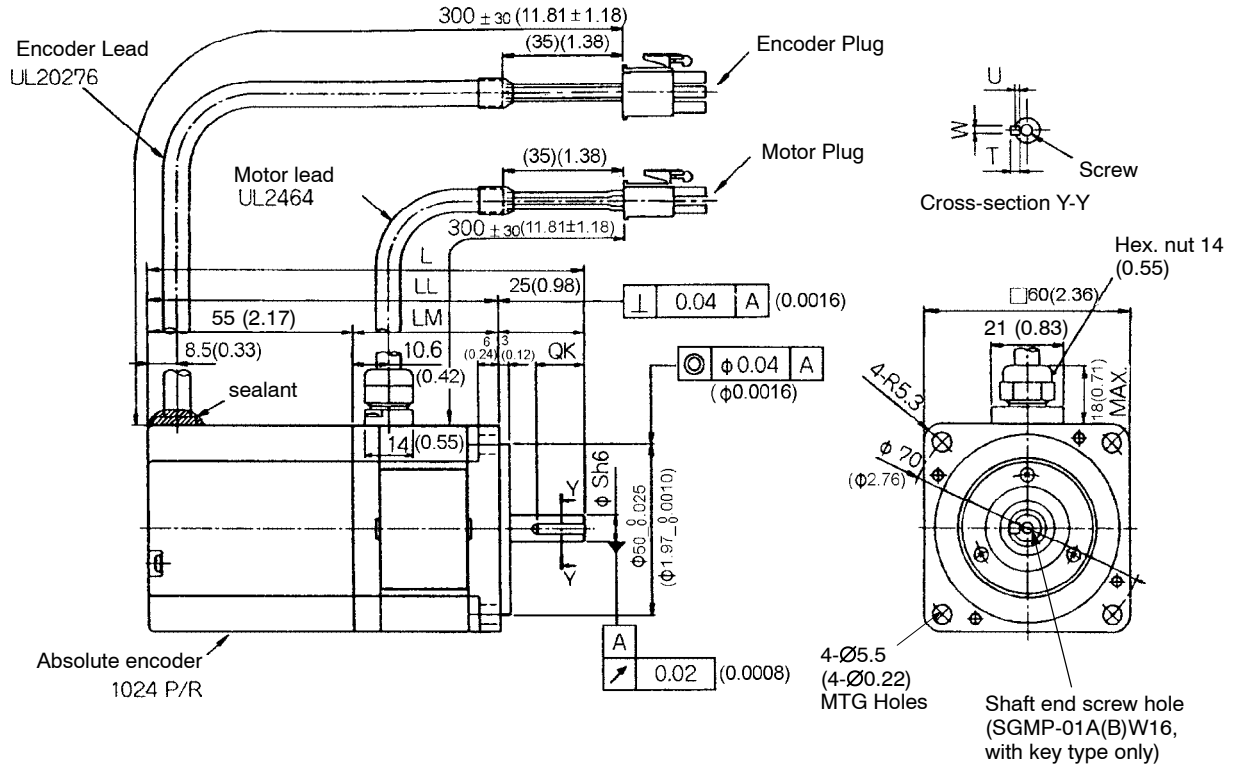

Type SGMP-	L	LL	LM	S	QK	U	W	T	Screw dimensions	Output W (HP)	Approx. mass kg (lb)	Allowable radial load N (lb)	Allowable thrust load N (lb)
01AW12	122.5 (4.82)	97.5 (3.84)	42.5 (1.67)	8 (0.31)	No key				---	100 (0.13)	0.95 (2.09)	78 (17)	49 (11)
01BW12					14 (0.55)	1.8 (0.07)	3 (0.12)	3 (0.12)					
01AW14													
01BW14													
01AW16													
01BW16					M3, depth 6 (0.24)								

- Note**
- 1) The detector uses a 12-bit absolute encoder 1024 P/R.
 - 2) Type "A" indicates 200 V specification, and type "B" indicates 100 V specification.
 - 3) "01A(B)W14" and "01A(B)W16" have a keyed shaft. The keyway complies with JIS B 1301-1976 (precision). A straight key is supplied.
 - 4) The quoted allowable radial load is the value at a position 20 mm (0.79 in.) from the motor mounting surface.
 - 5) Conforms to IP55 protective structure (except connector and output shaft faces).

SERVO SELECTION AND DATA SHEETS

5.4.1 Servomotor Dimensional Drawings cont.

- 200 W (0.27 HP), 300 W (0.40 HP) (100 V only), 400 W (0.53HP) (200 V only)

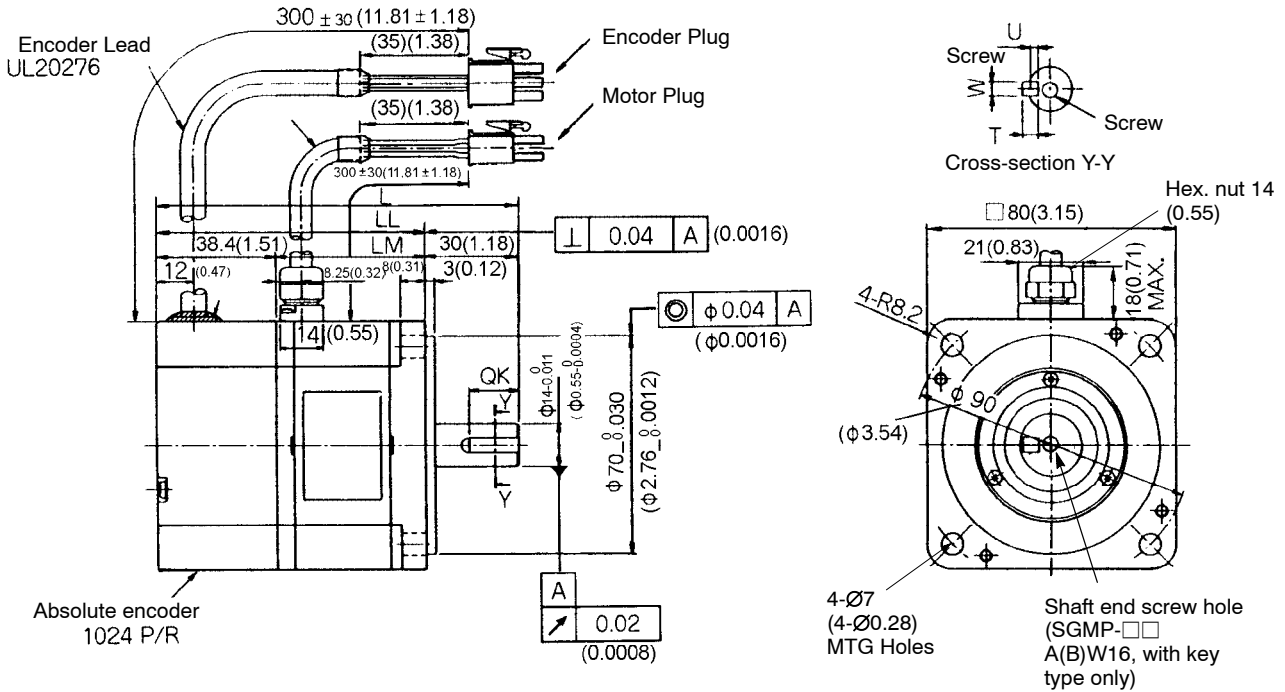

Type SGMP-	L	LL	LM	QK	U	W	T	Screw dimensions	Output W (HP)	Approx. mass kg (lb)	Allowable radial load N (lb)	Allowable thrust load N (lb)	
02AW12	116.5 (4.59)	86.5 (3.41)	48.1 (1.89)	No key				---	M5, depth 8 (0.31)	200 (0.27)	1.6 (3.53)	245 (55.1)	68 (15.4)
02BW12				16 (0.63)	3 (0.12)	5 (0.20)	5 (0.20)						
02AW14													
02BW14													
02AW16													
02BW16													
03BW12	136.5 (5.37)	106.5 (4.19)	68.1 (2.68)	No key				---	M5, depth 8 (0.31)	300 (0.40)	2.3 (5.07)		
03BW14				16 (0.63)	3 (0.12)	5 (0.20)	5 (0.20)						
03BW16													
04AW12				No key				---	M5, depth 8 (0.31)	400 (0.53)			
04AW14				16 (0.63)	3 (0.12)	5 (0.20)	5 (0.20)						
04AW16													

- Note**
- 1) The detector uses a 12-bit absolute encoder 1024 P/R.
 - 2) Type "A" indicates 200 V specification, and type "B" indicates 100 V specification.
 - 3) "02A(B)W14", "02A(B)W16", "03BW14", "03BW16", "04AW14", and "04AW16" have a keyed shaft. The keyway complies with JIS B 1301-1976 (precision). A straight key is supplied.

- 4) The quoted allowable radial load is the value at a position 25 mm (0.98 in.) from the motor mounting surface.
- 5) Conforms to IP55 protective structure (except connector and output shaft faces).

• 750 W (1.01HP)

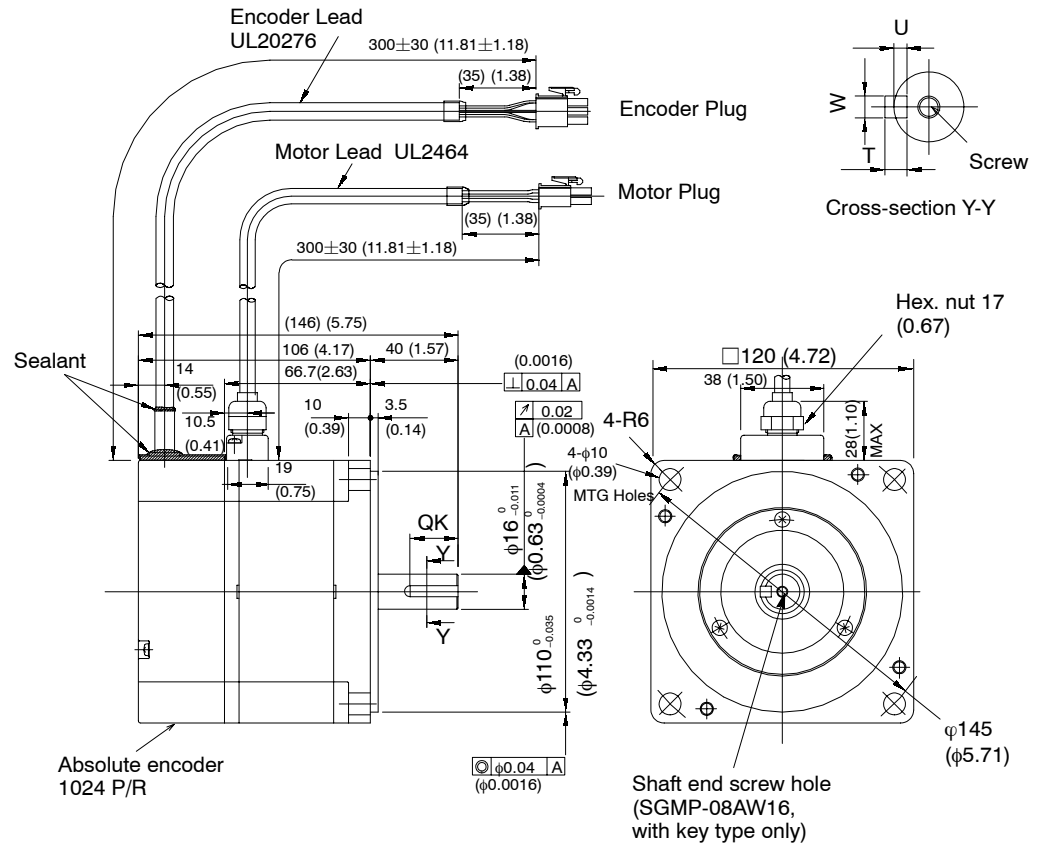

Type SGMP-	QK	U	W	T	Screw Dimensions	Output W (HP)	Approx. mass kg (lb)	Allowable radial load N (lb)	Allowable thrust load N (lb)
08AW12	No key				—	750 (1.01)	4.8 (10.58)	392 (88)	147 (33)
08AW14	22 (0.87)	3 (0.12)	5 (0.20)	5 (0.20)	M5, depth 8 (0.31)				
08AW16									

- Note**
- 1) The detector uses a 12-bit absolute encoder 1024 P/R.
 - 2) Type “A” indicates 200 V specification.

SERVO SELECTION AND DATA SHEETS

5.4.1 Servomotor Dimensional Drawings cont.

- 3) "08AW14" and "08AW16" have a keyed shaft. The keyway complies with JIS B 1301-1976 (precision). A straight key is supplied.
- 4) The quoted allowable radial load is the value at a position 35 mm (1.38 in.) from the motor mounting surface.
- 5) Conforms to IP55 protective structure (except connector and output shaft faces).

• Details of Motor and Encoder Plugs (Common for 100 W (0.13 HP) to 750 W (1.01 HP))

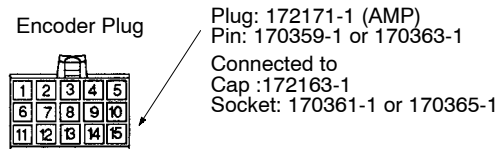
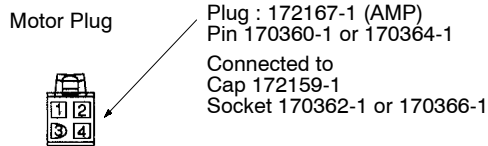

Motor Wiring Specifications

1	U phase	Red
2	V phase	White
3	W phase	Blue
4	FG	Green/Yellow

Absolute Encoder Wiring Specifications

1	A channel output	Blue
2	\bar{A} channel output	White/Blue
3	B channel output	Yellow
4	\bar{B} channel output	White/Yellow
5	Z channel output	Green
6	\bar{Z} channel output	White/Green
7	0V (power supply)	Black
8	+5 V(power supply)	Red
9	FG (Frame Ground)	Green/Yellow
10	S channel output	Purple
11	\bar{S} channel output	White/Purple
* (12)	(Capacitor reset)	(Gray)
13	Reset	White/Gray
14	0V(battery)	White/Orange
15	3.6V(battery)	Orange

* Terminal to discharge capacitor for product dispatch. Do not use.

(4) SGMP Servomotor

Absolute encoder, with brake (Type SGMP-□□□W1□B)

• 100 W (0.13 HP)

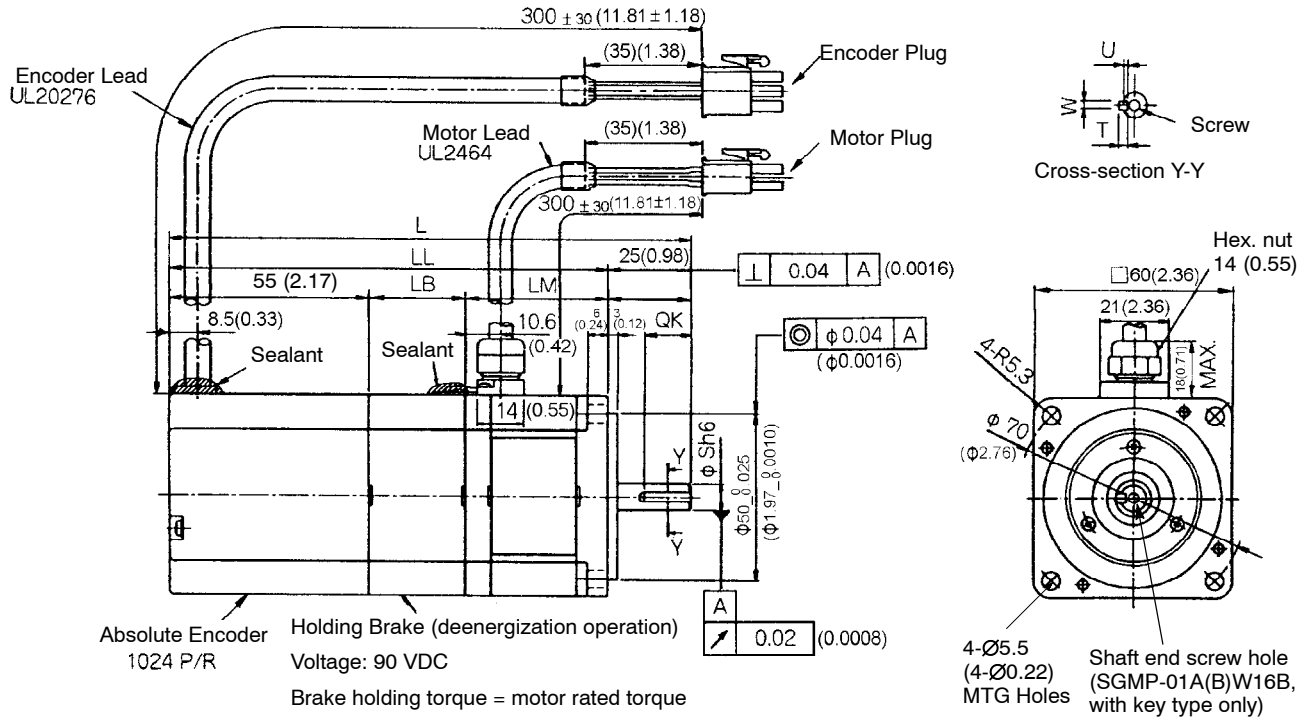

Type SGMP-	L	LL	LM	LB	S	QK	U	W	T	Screw dimensions	Output W (HP)	Approx. mass kg (lb)	Allowable radial load N (lb)	Allowable thrust load N (lb)
01AW12B	151.5 (5.96)	126.5 (4.98)	42.5 (1.67)	29 (1.14)	8 (0.31)	No key				---	100 (0.13)	1.2 (2.65)	78 (17)	49 (11)
01BW12B														
01AW14B						14 (0.55)	1.8 (0.07)	3 (0.12)	3 (0.12)					
01BW14B														
01AW16B														
01BW16B								M3, depth 6 (0.24)						

- Note**
- 1) The detector uses a 12-bit absolute encoder 1024 P/R.
 - 2) Type "A" indicates 200 V specification, and type "B" indicates 100 V specification.
 - 3) "01A(B)W14B" and "01A(B)W16B" have a keyed shaft. The keyway complies with JIS B 1301-1976 (precision). A straight key is supplied.

SERVO SELECTION AND DATA SHEETS

5.4.1 Servomotor Dimensional Drawings cont.

- 4) The quoted allowable radial load is the value at a position 20 mm (0.79 in.) from the motor mounting surface.
- 5) The electromagnetic brake is only to hold the load in position and cannot be used to stop the motor.
- 6) Conforms to IP55 protective structure (except connector and output shaft faces).

- 200 W (0.27 HP), 300 W (0.40 HP), 400 W (0.53 HP)

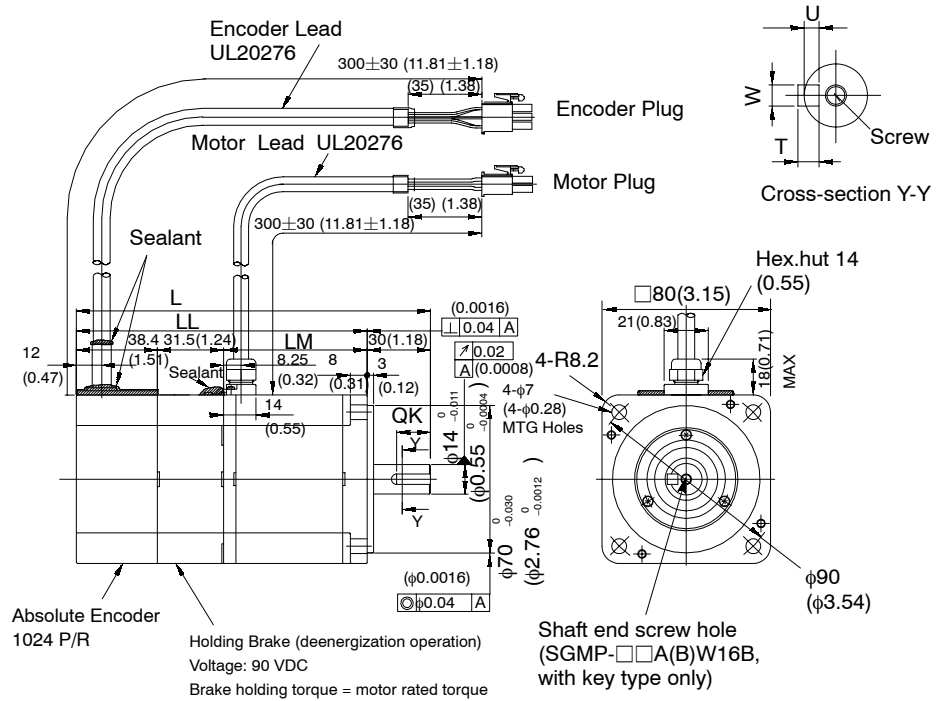

Type SGMP-	L	LL	LM	QK	U	W	T	Screw dimensions	Output W (HP)	Approx. mass kg (lb)	Allowable radial load N (lb)	Allowable thrust load N (lb)
02AW12B	148 (5.83)	118 (4.65)	48.1 (1.89)	No key				M5, depth 8 (0.31)	200 (0.27)	2.3 (5.07)	245 (55.1)	68 (15.4)
02BW12B				16 (0.63)	3 (0.12)	5 (0.20)	5 (0.20)					
02AW14B												
02BW14B												
02AW16B												
02BW16B												
03BW12B	168 (6.61)	138 (5.43)	68.1 (2.68)	No key				M5, depth 8 (0.31)	300 (0.40)	3.0 (6.61)		
03BW14B				16 (0.63)	3 (0.12)	5 (0.20)	5 (0.20)					
03BW16B												
04AW12B				No key				M5, depth 8 (0.31)	400 (0.53)			
04AW14B				16 (0.63)	3 (0.12)	5 (0.20)	5 (0.20)					
04AW16B												

Note 1) The detector uses a 12-bit absolute encoder 1024 P/R.

2) Type "A" indicates 200 V specification, and type "B" indicates 100 V specification.

5.4.1 Servomotor Dimensional Drawings cont.

- 3) "02A(B)W14B", "02A(B)W16B", "03BW14B", "03BW16B", "04AW14B", and "04AW16B" have a keyed shaft. The keyway complies with JIS B 1301-1976 (precision). A straight key is supplied.
- 4) The quoted allowable radial load is the value at a position 25 mm (0.98 in.) from the motor mounting surface.
- 5) The electromagnetic brake is only to hold the load in position and cannot be used to stop the motor.
- 6) Conforms to IP55 protective structure (except connector and output shaft faces).

• 750 W (1.01 HP)

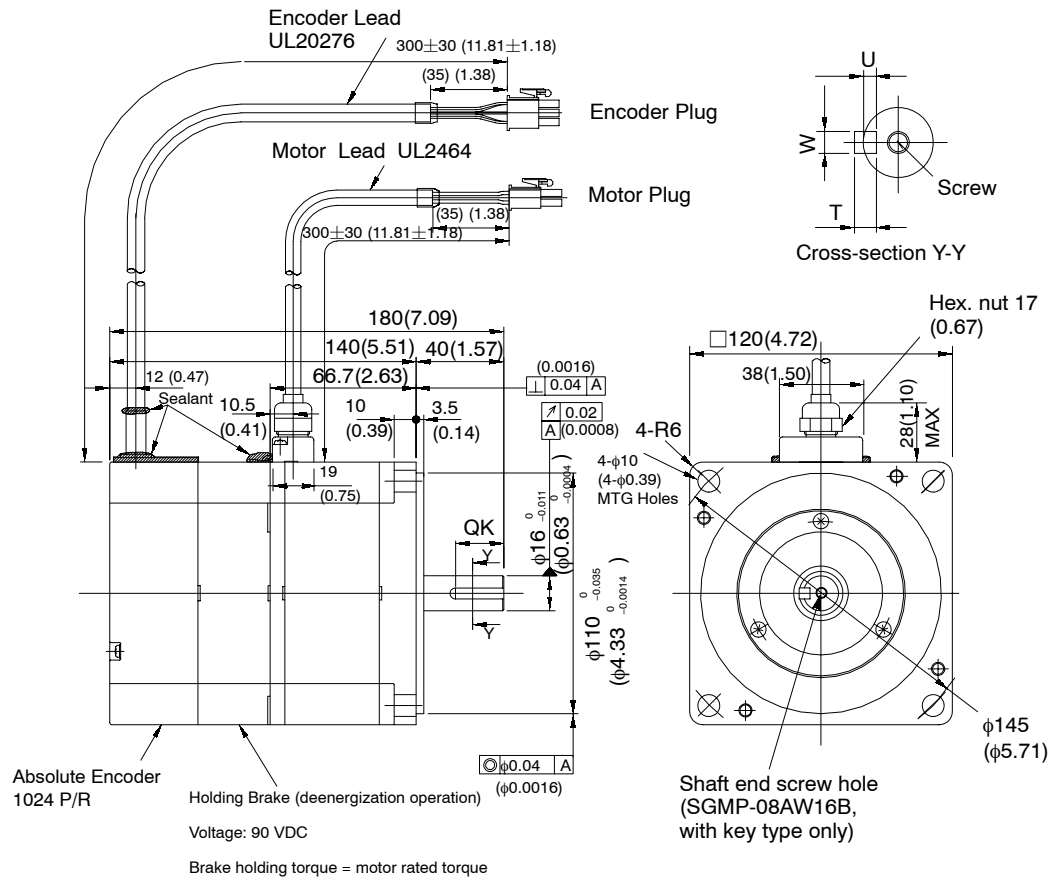

Type SGMP-	QK	U	W	T	Screw Dimensions	Output W (HP)	Approx. mass kg (lb)	Allowable radial load N (lb)	Allowable thrust load N (lb)
08AW12B	No key				—	750 (1.01)	6.2 (13.67)	392 (88)	147 (33)
08AW14B	22 (0.87)	3 (0.12)	5 (0.20)	5 (0.20)					
08AW16B				M5, depth 8 (0.31)					

- Note**
- 1) The detector uses a 12-bit absolute encoder 1024 P/R.
 - 2) Type “A” indicates 200 V specification.
 - 3) “08AW14B” and “08AW16B” have a keyed shaft. The keyway complies with JIS B 1301-1976 (precision). A straight key is supplied.
 - 4) The quoted allowable radial load is the value at a position 35 mm (1.38 in) from the motor mounting surface.
 - 5) The electromagnetic brake is only to hold the load in position and cannot be used to stop the motor.

6) Conforms to IP55 protective structure (except connector and output shaft faces).

- Details of Motor and Encoder Plugs (Common for 100W (0.13 HP) to 750 W (1.01 HP))

Motor Plug



Plug : 172168-1 (AMP)
 Pin 170360-1 or 170364-1 (1 to 4pin)
 170359-1 or 170363 (5 to 6 pin)
 (17360-1 or 17364-1:only 750W)
 Connected to
 Cap 172160-1
 Socket 170362-1 or 170366-1

Motor Wiring Specifications

1	U phase	Red
2	V phase	White
3	W phase	Blue
4	FG	Green/Yellow
5	Brake terminal	Black
6	Brake terminal	Black

Encoder Plug

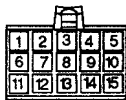

Plug: 172171-1 (AMP)
 Pin: 170359-1 or 170363-1
 Connected to
 Cap :172163-1
 Socket: 170361-1 or 170365-1

Absolute Encoder Wiring Specifications

1	A channel output	Blue
2	\bar{A} channel output	White/Blue
3	B channel output	Yellow
4	\bar{B} channel output	White/Yellow
5	Z channel output	Green
6	\bar{Z} channel output	White/Green
7	0 V (power supply)	Black
8	+5 V (power supply)	Red
9	FG (Frame Ground)	Green/Yellow
10	S channel output	Purple
11	\bar{S} channel output	White/Purple
* (12)	(Capacitor reset)	(Gray)
13	Reset	White/Gray
14	0V(battery)	White/Orange
15	3.6V(battery)	Orange

* Terminal to discharge capacitor for product dispatch. Do not use.

5.4.2 Servopack Dimensional Drawings

1) The dimension drawings of the SGDA Servopack are broadly grouped according to capacity into the following three categories.

a) 200V, 30W (0.04 HP) to 200 W (0.27HP) (Type: SGDA-A3A□ to 02A□)
 100V, 30W (0.04 HP) to 100 W (0.13HP) (Type: SGDA-A3B□ to 01B□)

b) 200V, 400W (0.53 HP) (Type: SGDA-04A□)
 100V, 200W (0.27 HP) (Type: SGDA-02B□)

c) 200V, 750W (1.01 HP) (Type: SGDA-08A□)
 100V, 300W (0.40 HP) (Type: SGDA-03B□)

(1) SGDA-A3A□ to 02A□ (200V, 30 (0.04 HP) to 200 W (0.27HP))
 SGDA-A3B□ to 01B□ (100V, 30 (0.04 HP) to 100 W (0.13HP))

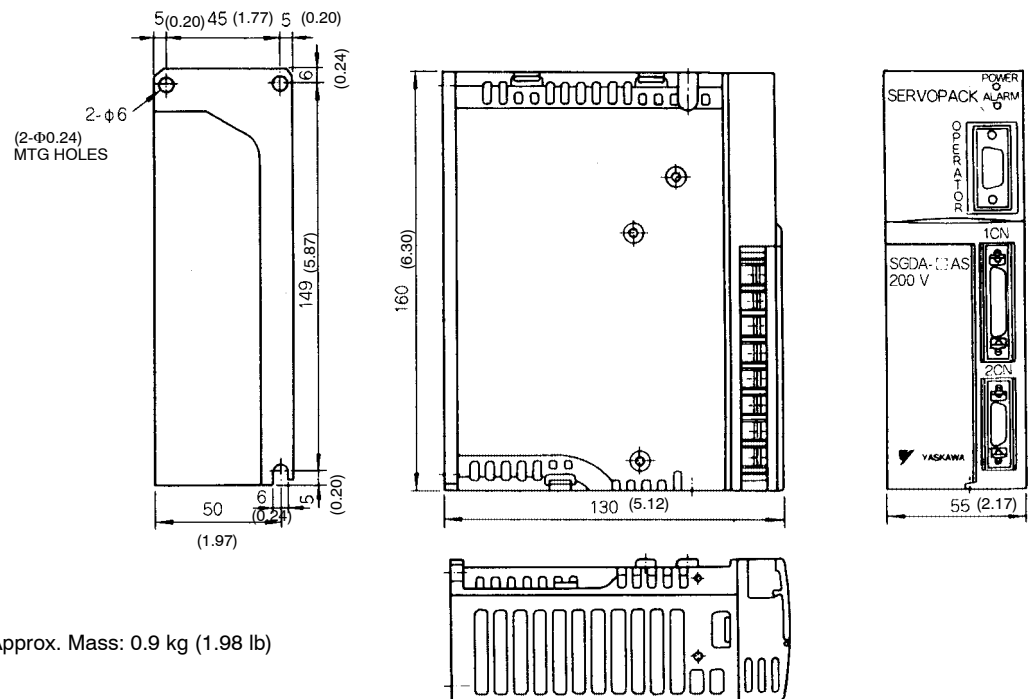

SERVO SELECTION AND DATA SHEETS

5.4.2 Servopack Dimensional Drawings cont.

- (2) SGDA-04A □ (200V, 400W (0.53 HP))
- SGDA-02B □ (100V, 200W (0.27 HP))

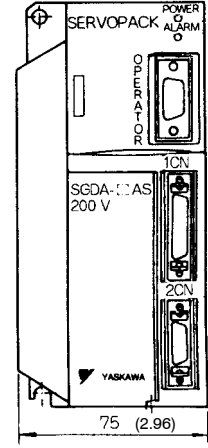
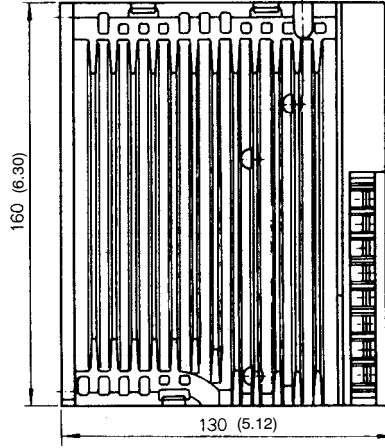
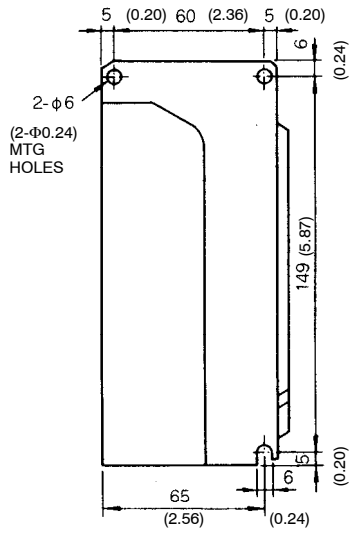

Approx. Mass: 1.2 kg (2.65 lb)

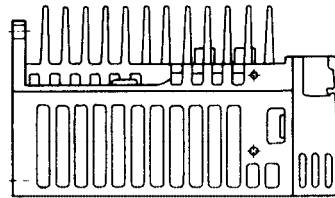

- (3) SGDA-08A□ (200V, 750W (1.01 HP))
 SGDA-03B□ (100V, 300W (0.40 HP))

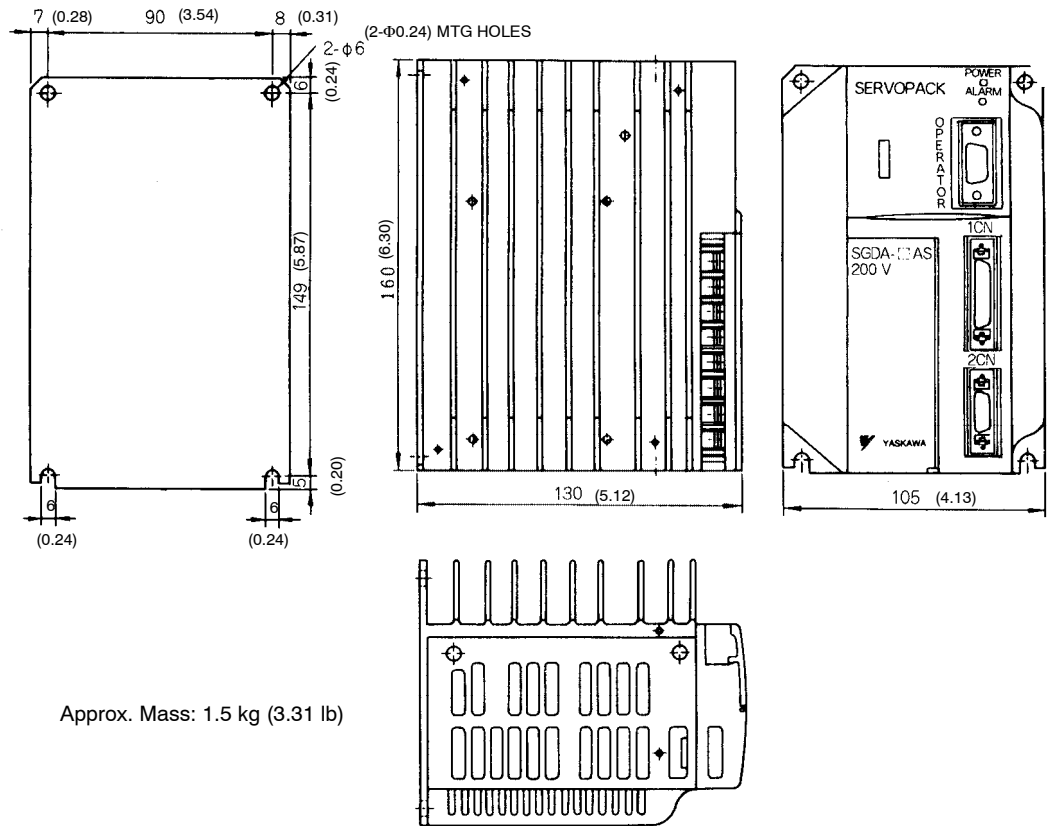

5.4.3 Digital Operator Dimensional Drawings

- 1) The following two types of Digital Operator are available.
 - a) JUSP-OP02A-1 Hand-held Type
 - b) JUSP-OP03A Mount Type

a) JUSP-OP02A-1

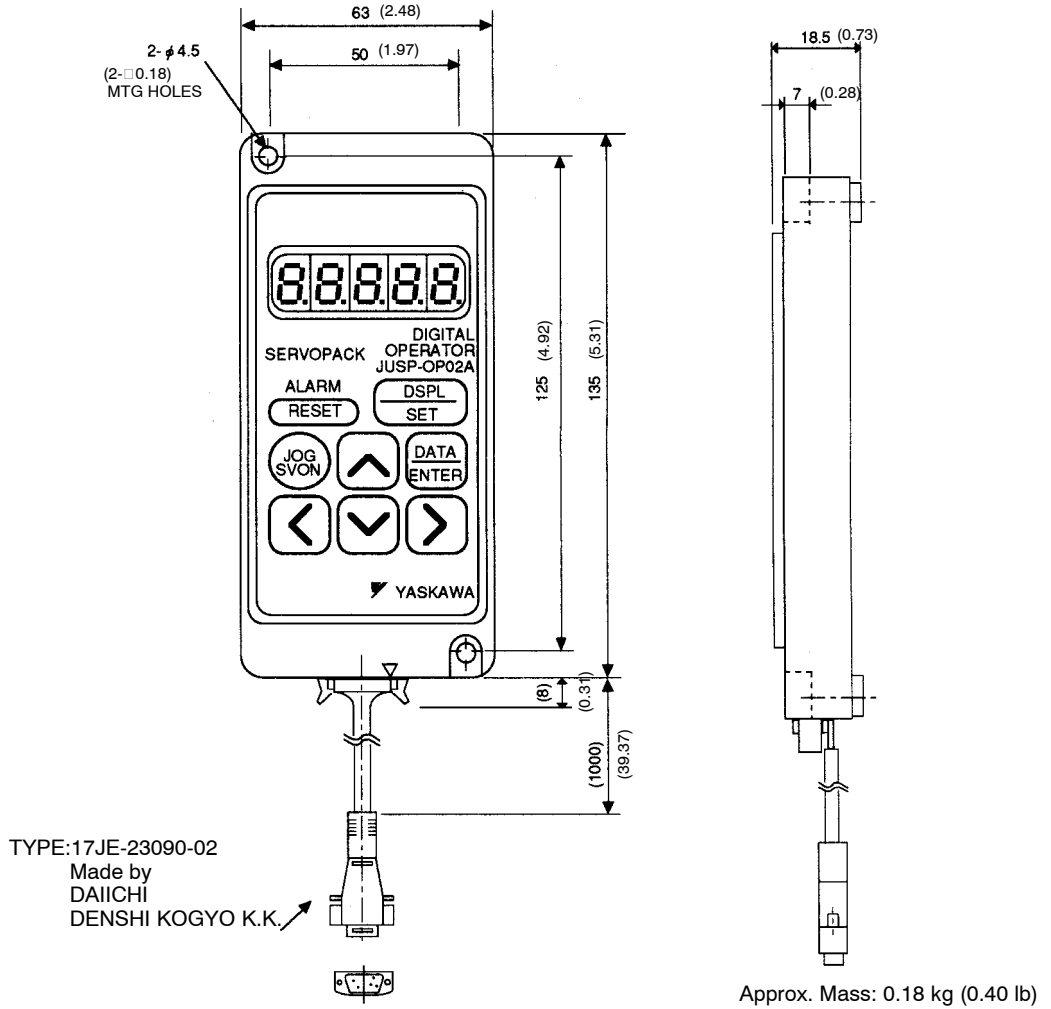

b) JUSP-OP03A

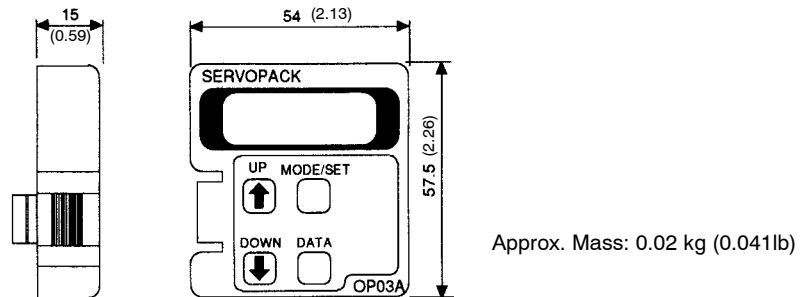

5

5.5 Selecting Peripheral Devices

This section shows how to select peripheral devices using flowcharts. Order lists for Servomotors, Servopacks, digital operators, and peripheral devices are also included.

5.5.1	Selecting Peripheral Devices	293
5.5.2	Order List	299

5.5.1 Selecting Peripheral Devices

Select the peripheral devices using the flowcharts on the subsequent pages.

The items below are not included in the flowcharts. Refer to *5.6 Specifications and Dimensional Drawings of Peripheral Devices*.

- Variable resistors for speed setting
- Encoder signal converter units
- Cables for connecting PC and Servopack

<Flowchart for peripheral device selection>

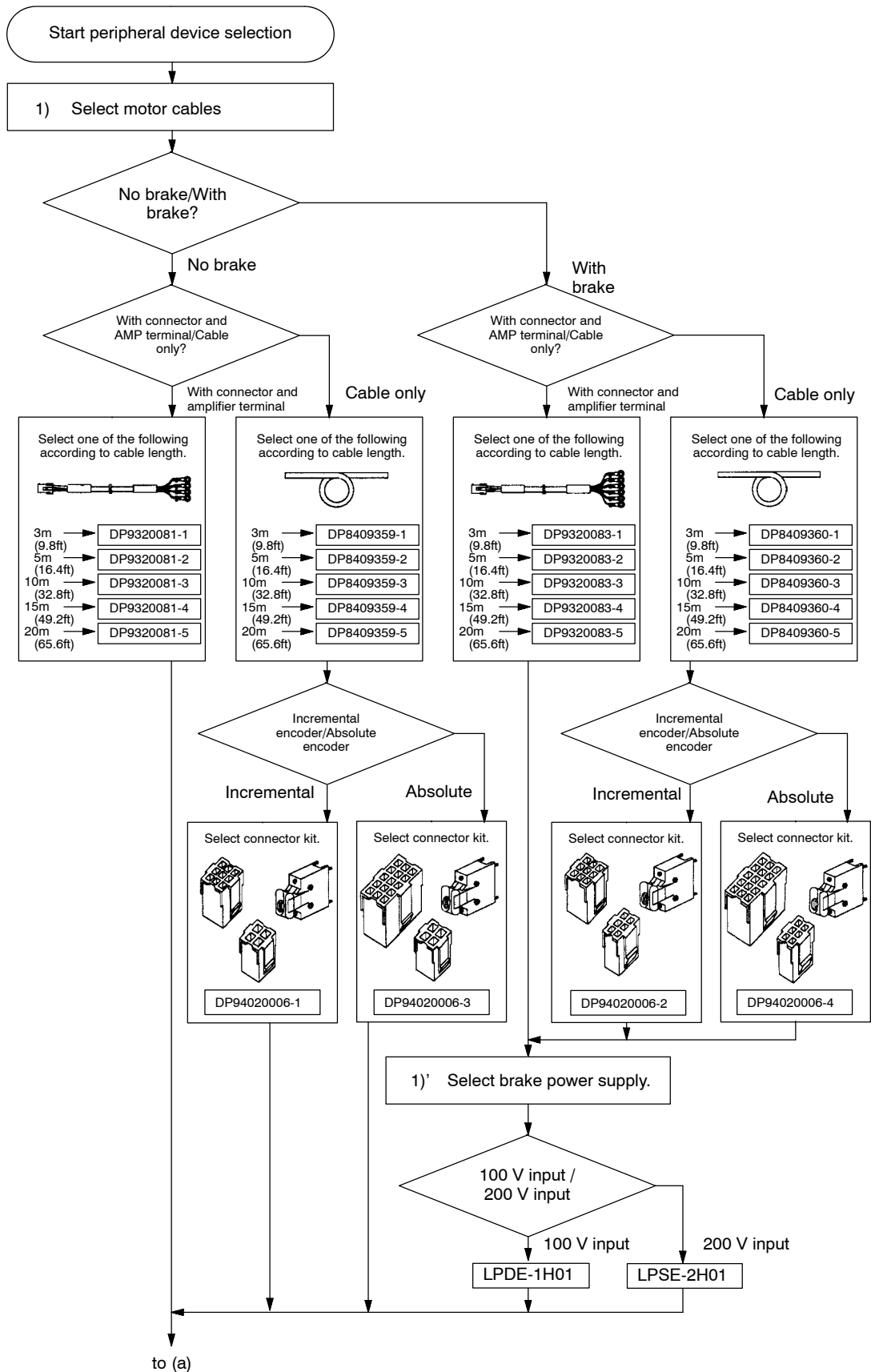

5

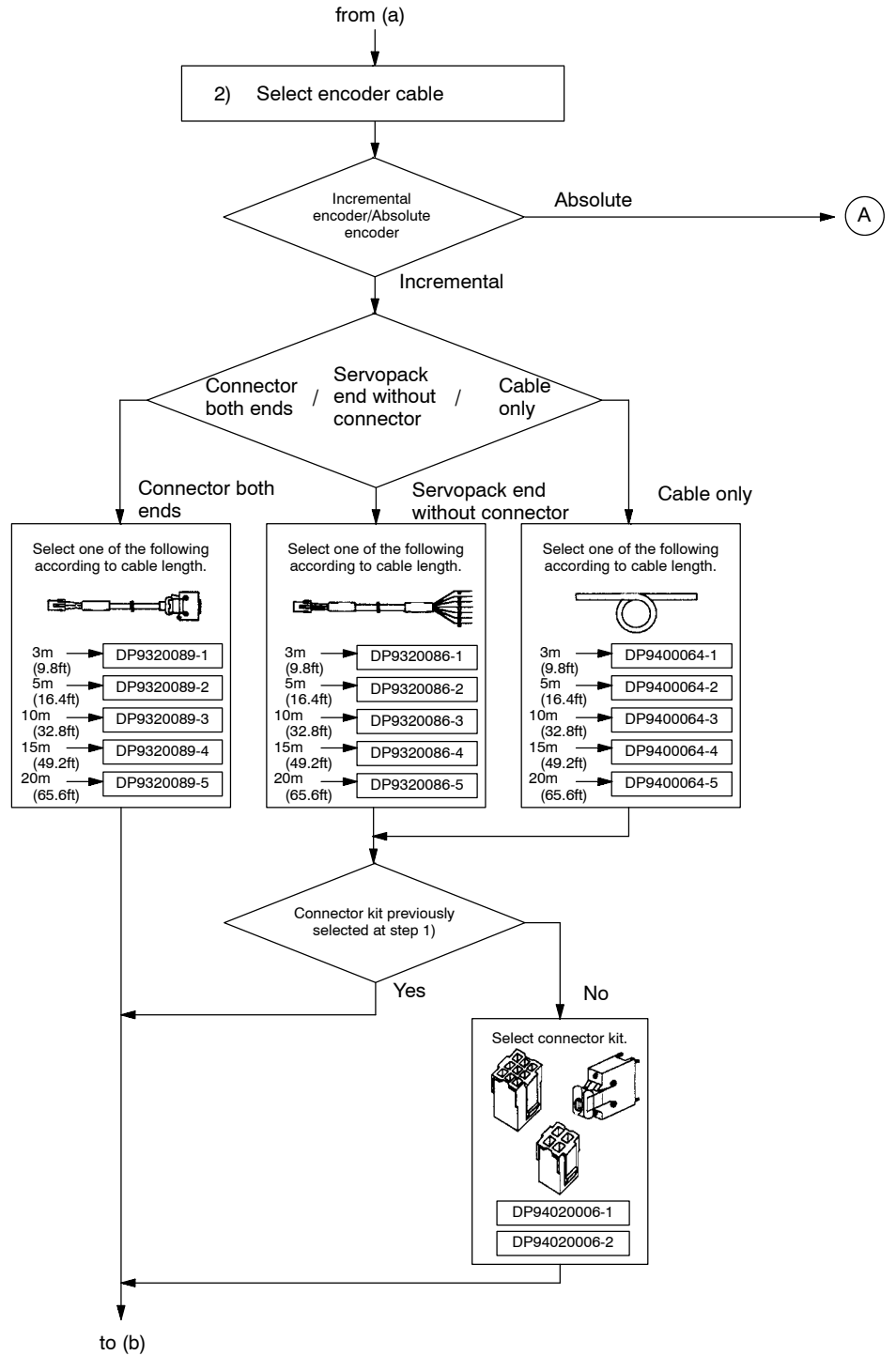

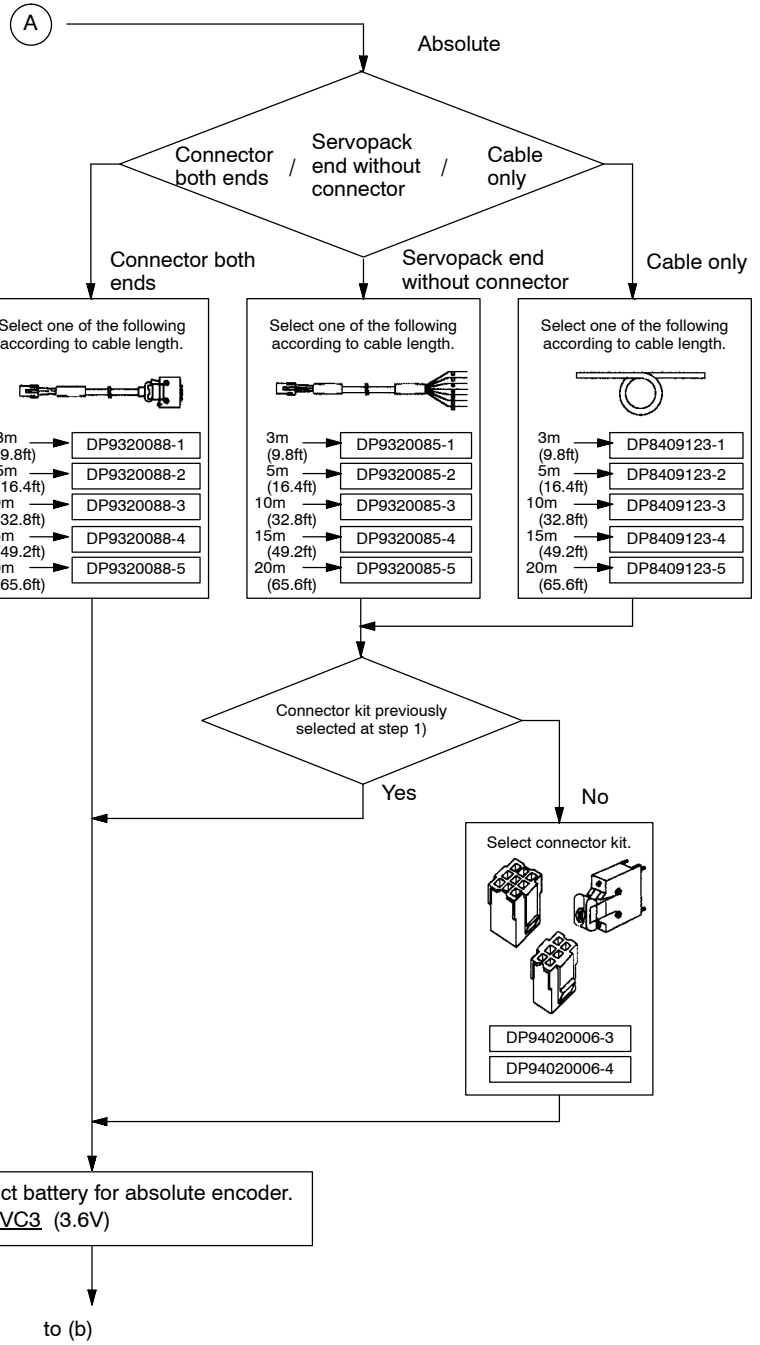

5

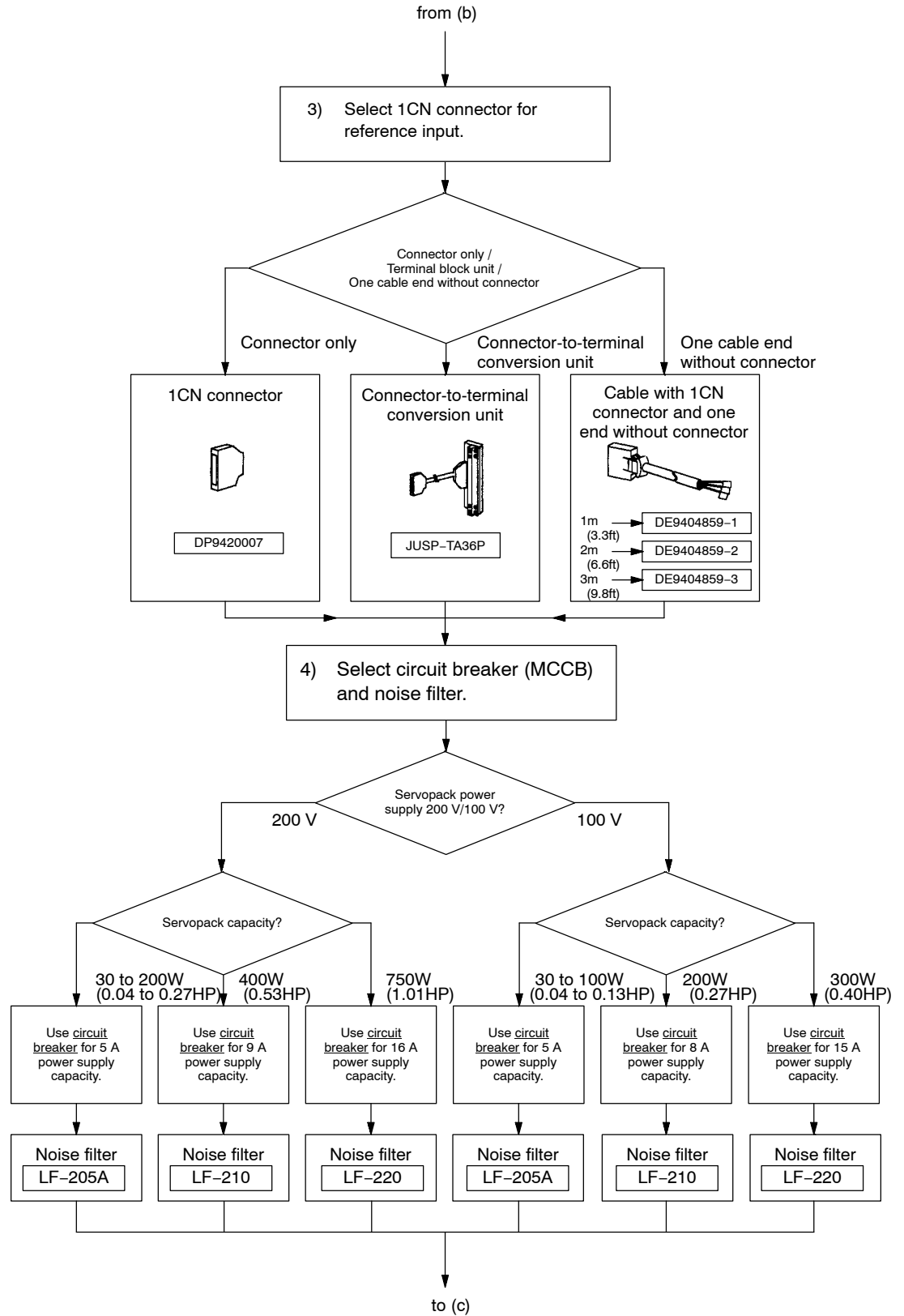

5

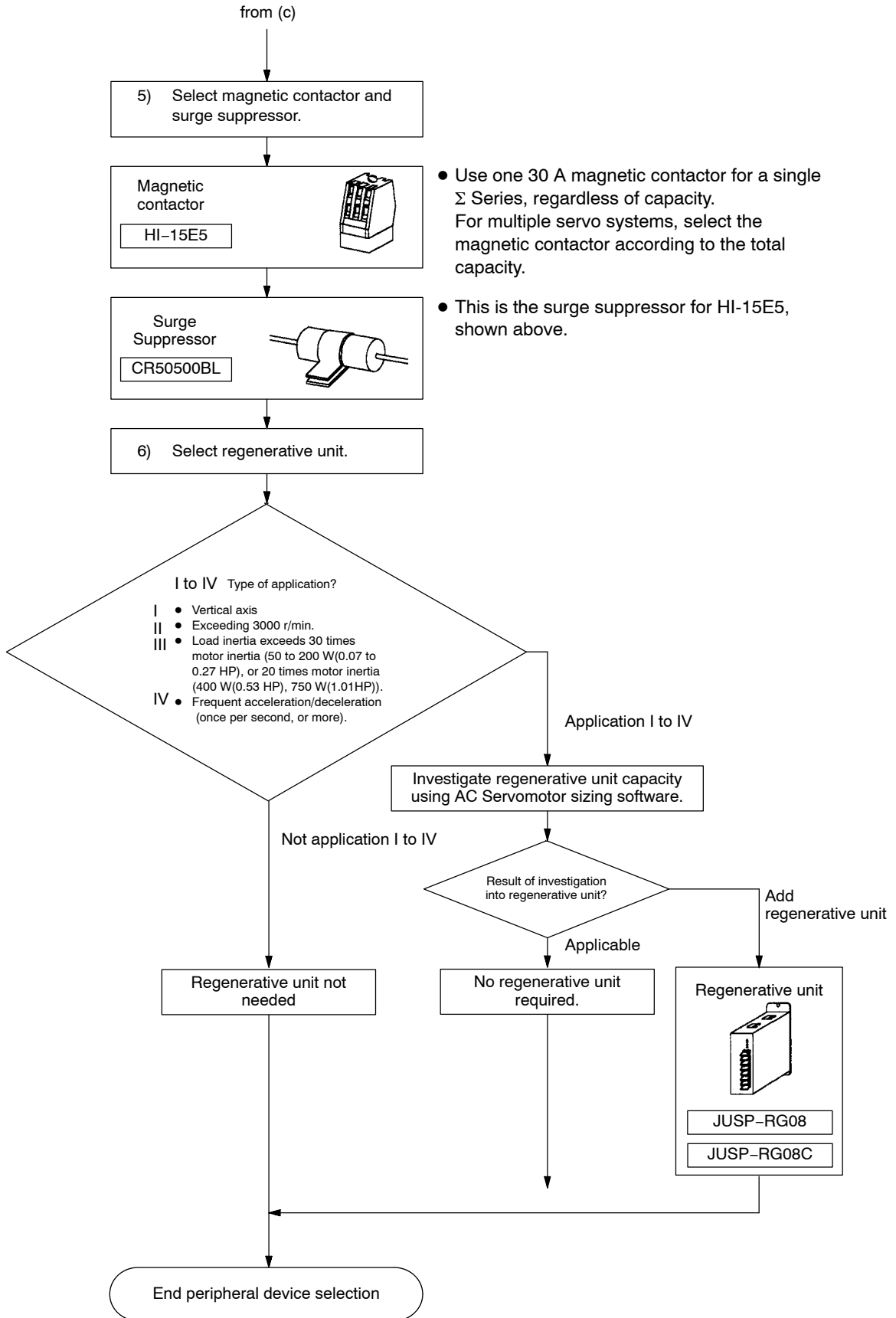

5.5.2 Order List

- 1) Order lists are given below for the Servomotors, Servopacks, digital operators, and peripheral devices which comprise the AC Servo Σ -Series. These order lists are a convenient aid to selecting peripheral devices.

SGM Servomotor

Servomotor Type	Qty
SGM-□□□□□□□□	
SGM-□□□□□□□□	
SGM-□□□□□□□□	
SGM-□□□□□□□□	
SGM-□□□□□□□□	
SGM-□□□□□□□□	

SGDA Servopack (excluding cables and connectors)

Servopack Type	Qty
SGDA-□□□□	
SGDA-□□□□	
SGDA-□□□□	
SGDA-□□□□	
SGDA-□□□□	
SGDA-□□□□	

SGMP Servomotor

Servomotor Type	Qty
SGMP-□□□□□□□□	
SGMP-□□□□□□□□	
SGMP-□□□□□□□□	
SGMP-□□□□□□□□	
SGMP-□□□□□□□□	
SGMP-□□□□□□□□	

Digital Operator

(Purchase Separately)

Digital Operator Type	Qty
JUSP-OP02A-1	
JUSP-OP03A	

M1

Cables for Servomotor without Brake

(with connector and amplifier terminals)

(Purchase Separately)

Cable Type	Qty
DP9320081-1	3 m (9.8 ft)
DP9320081-2	5 m (16.4 ft)
DP9320081-3	10 m (32.8 ft)
DP9320081-4	15 m (49.2 ft)
DP9320081-5	20 m (65.6 ft)

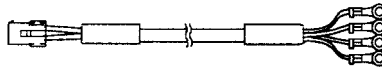

M2

Cables for Servomotor without Brake

(Cable Only)*1

(Purchase Separately)

Cable Type	Qty
DP8409359-1	3 m (9.8 ft)
DP8409359-2	5 m (16.4 ft)
DP8409359-3	10 m (32.8 ft)
DP8409359-4	15 m (49.2 ft)
DP8409359-5	20 m (65.6 ft)

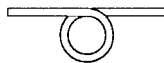

*1 Customer to attach connector and amplifier terminals. Requires K1 connector kit.

M3

Cables for Servomotor with Brake

(with connector and amplifier terminals)

(Purchase Separately)

Cable Type	Qty
DP9320083-1	3 m (9.8 ft)
DP9320083-2	5 m (16.4 ft)
DP9320083-3	10 m (32.8 ft)
DP9320083-4	15 m (49.2 ft)
DP9320083-5	20 m (65.6 ft)

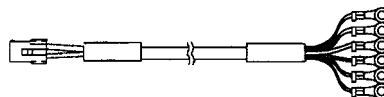

5

M4

Cables for Servomotor with Brake

(Cable Only)*1

(Purchase Separately)

Cable Type		Qty
DP8409360-1	3 m (9.8 ft)	
DP8409360-2	5 m (16.4 ft)	
DP8409360-3	10 m (32.8 ft)	
DP8409360-4	15 m (49.2 ft)	
DP8409360-5	20 m (65.6 ft)	

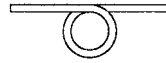

*1 Customer to attach connector and amplifier terminals. Requires K1 connector kit.

K1

Connector Kits

(Purchase Separately)

Connector Kit Type	Qty
DP9420006-1 (Incremental encoder, no brake)	
DP9420006-2 (Incremental encoder, with brake)	
DP9420006-3 (Absolute encoder, no brake)	
DP9420006-4 (Absolute encoder, with brake)	

5.5.2 Order List cont.

- The three products in the diagrams below are supplied as a set.
 - 1) Motor Connector for Motor End of Cable ... one connector for Servomotor with or without brake
 - 2) Encoder Connector for Motor End of Cable ... one connector for incremental or absolute encoder
 - 3) Encoder Connector for Servopack End of Cable ... one 2CN connector

1) Motor Connector for Motor End of Cable

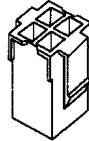

No Brake

2) Encoder Connector for Motor End of Cable

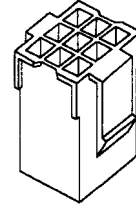

For Incremental Encoder

3) Encoder Connector for Servopack End of Cable

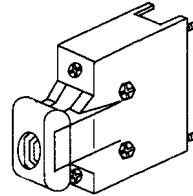

5

Brake Power Supply (for motor with brake)

(Purchase Separately)

Brake Power Supply Type	Qty
LPSE-2H01 (for 200 V)	
LPDE-1H01 (for 100 V)	

E1

Cables for Incremental Encoder

(Connector Both Ends)

(Purchase Separately)

Cable Type	Qty
DP9320089-1	3m (9.8 ft)
DP9320089-2	5m (16.4 ft)
DP9320089-3	10m (32.8 ft)
DP9320089-4	15m (49.2 ft)
DP9320089-5	20m (65.6 ft)

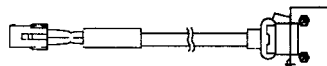

E2

Cables for Incremental Encoder

(Servopack end without connectors)*2

(Purchase Separately)

Cable Type	Qty
DP9320086-1	3m (9.8 ft)
DP9320086-2	5m (16.4 ft)
DP9320086-3	10m (32.8 ft)
DP9320086-4	15m (49.2 ft)
DP9320086-5	20m (65.6 ft)

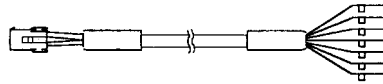

*2 Customer to attach connector to Servopack end of cable. Requires K1 connector kit.

E3

Cables for Incremental Encoder

(Cable Only)*3

(Purchase Separately)

Cable Type	Qty
B9400064-1	3m (9.8 ft)
B9400064-2	5m (16.4 ft)
B9400064-3	10m (32.8 ft)
B9400064-4	15m (49.2 ft)
B9400064-5	20m (65.6 ft)

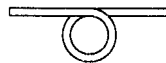

*3 Customer to attach connector to both ends of cable. Requires K1 connector kit.

E4 Cables for Absolute Encoder

(Connector Both Ends)

(Purchase Separately)

Cable Type		Qty
DP9320088-1	3m (9.8 ft)	
DP9320088-2	5m (16.4 ft)	
DP9320088-3	10m (32.8 ft)	
DP9320088-4	15m (49.2 ft)	
DP9320088-5	20m (65.6 ft)	

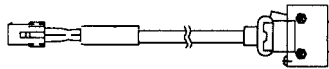

E5 Cables for Absolute Encoder

(Servopack end without connectors)*2

(Purchase Separately)

Cable Type		Qty
DP9320085-1	3m (9.8 ft)	
DP9320085-2	5m (16.4 ft)	
DP9320085-3	10m (32.8 ft)	
DP9320085-4	15m (49.2 ft)	
DP9320085-5	20m (65.6 ft)	



*2 Customer to attach connector to Servopack end of cable. Requires **K1** connector kit.

E6

Cables for Absolute Encoder

(Cable Only)*3

(Purchase Separately)

Cable Type	Qty
DP8409123-1	3m (9.8 ft)
DP8409123-2	5m (16.4 ft)
DP8409123-3	10m (32.8 ft)
DP8409123-4	15m (49.2 ft)
DP8409123-5	20m (65.6 ft)



*3 Customer to attach connector to both ends of cable. Requires **K1** connector kit.

Battery for Absolute Encoder

(Purchase Separately)

Battery Type	Qty
ER6VC3 (3.6V)	

C1

1CN Connector

(Purchase Separately)

Connector Type	Qty
DP9420007	

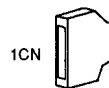

One 1CN Connector

C2

Connector Terminal Block Converter Unit

(Purchase Separately)

Converter Unit Type	Qty
JUSP-TA36P	

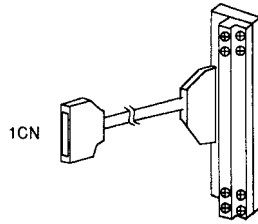

1CN Connector Cable (0.5m)

C3

Cable with 1CN Connector and One End Loose Wires

(Purchase Separately)

Cable Type	Qty
DE9404859-1	1m (3.3 ft)
DE9404859-2	2m (6.6 ft)
DE9404859-3	3m (9.8 ft)

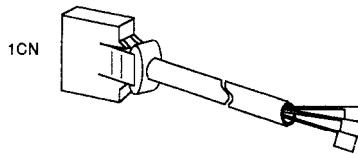

Noise Filter

(Purchase Separately)

Noise Filter Type	Qty
LF-205A (5A)	
LF-210 (10A)	
LF-220 (20A)	

Magnetic Contactor

(Purchase Separately)

Magnetic Contactor Type	Qty
HI-15E5 (30A)	

5

Surge Suppressor

(Purchase Separately)

Surge Suppressor Type	Qty
CR50500BL	

Regenerative Unit

(Purchase Separately)

Regenerative Unit Type	Qty
JUSP-RG08	

Variable Resistor for Speed Setting

(Purchase Separately)

Variable Resistor Type	Qty
25HP-10B	

Cables for Connecting PC and Servopack

(Purchase Separately)

Cable Type	Qty
DE9405258	2m (6.6 ft)

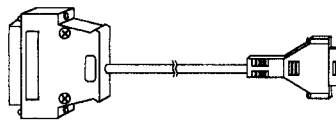
**Encoder Signal Converter Unit**

(Purchase Separately)

Unit Type	Qty
LRX-01/A1	
LRX-01/A2	
LRX-01/A3	
LRX-01/A4	

5.6 Specifications and Dimensional Drawings of Peripheral Devices

This section shows the specifications and dimensional drawings of the peripheral devices required for the Σ -Series servo system. The sequence of peripheral devices is given by the Flowchart for Peripheral Device Selection in *5.5 Selecting Peripheral Devices*.



5.6.1	Cable Specifications and Peripheral Devices	308
5.6.2	Motor Cables	311
5.6.3	Connector Kits	314
5.6.4	Brake Power Supply	318
5.6.5	Encoder Cables	320
5.6.6	Battery for Absolute Encoder	325
5.6.7	1CN Connector	326
5.6.8	Connector Terminal Block Converter Unit	328
5.6.9	Cable With 1CN Connector and One End Without Connector	330
5.6.10	Circuit Breaker	330
5.6.11	Noise Filter	331
5.6.12	Magnetic Contactor	332
5.6.13	Surge Suppressor	333
5.6.14	Regenerative Unit	334
5.6.15	Variable Resistor for Speed Setting	335
5.6.16	Encoder Signal Converter Unit	336
5.6.17	Cables for Connecting PC and Servopack	338

5.6.1 Cable Specifications and Peripheral Devices

- 1) The rated current of the SGDA Servopack external terminals, cable size, and peripheral devices are listed in the next table.

The cable specifications and size are selected according to the operating environment and current capacity.

The cable specifications were selected under conditions of three cables per bundle at 40° C ambient temperature, with the rated current flowing.

Type	Servopack Type SGDA-		Main circuit power input terminal (R) (T)		Motor connection terminals (U) (V) (W) $\underline{\quad}$		Power Supply capacity per Servopack* ¹ kVA	MCCB or fuse capacity* ² A	Noise filter type (reference diagram)	Recommended noise filter* ³		Power ON/OFF switch
			Rated current A(rms)	Cable spec.	Rated current A (rms)	Cable spec.				Type	Spec.	
For 200 V	30 W (0.04HP)	A3A <input type="checkbox"/>	1.3	HIV 1.25 min.	0.42	Use Yaskawa cable. See 5.6.2 <i>Motor Cables</i> below for details.	0.25	5	Applicable 	LF-205A	Single-phase 200 VAC Class, 5 A	Yaskawa HI-15E5 (30 A), or equivalent
	50 W (0.07HP)	A5A <input type="checkbox"/>	1.5		0.6		0.3					
	100 W (0.13HP)	01A <input type="checkbox"/>	2.5		0.87		0.5					
	200 W (0.27HP)	02A <input type="checkbox"/>	4.0		2.0		0.75					
	400 W (0.53HP)	04A <input type="checkbox"/>	6.0	HIV 2.0 min.	2.6	When selecting non-Yaskawa cables, check the cable current rating and consider the operating environment.	1.2	9	Not applicable 	LF-210	Single-phase 200 VAC Class, 10 A	
	750 W (1.01HP)	08A <input type="checkbox"/>	11.0		4.4		2.2			16	LF-220	
For 100 V	30 W (0.04HP)	A3B <input type="checkbox"/>	2.0	HIV 1.25 min.	0.63	Use cable size AWG22 to AWG18 (0.3 to 0.89 mm ²).	0.25	5	Not applicable 	LF-205A	Single-phase 200 VAC Class, 5 A	
	50 W (0.07HP)	A5B <input type="checkbox"/>	2.6		0.9		0.3					
	100 W (0.13HP)	01B <input type="checkbox"/>	4.5		2.2		0.5					
	200 W (0.27HP)	02B <input type="checkbox"/>	8.0	HIV 2.0 min.	2.7		0.75	8		LF-210	Single-phase 200 VAC Class, 10 A	
	300 W (0.40HP)	03B <input type="checkbox"/>	14.0		3.7		1.4			15	LF-220	Single-phase 200 VAC Class, 20 A

*1 Value at rated load.

*2 Braking characteristics (at 25°C): 200% for 2 s min., 700% for 0.01 s min.

*3 Yaskawa recommends noise filters manufactured by Tokin Corp. Yaskawa Controls Co., Ltd. can supply these noise filters.

SERVO SELECTION AND DATA SHEETS

5.6.1 Cable Specifications and Peripheral Devices cont.

- 2) The types of cable are shown in the table below. Use it in combination with the table above.

Cable Type		Conductor Allowable Temperature °C
Symbol	Name	
PVC	Normal vinyl cable	---
IV	600 V vinyl cable	60
HIV	Temperature-resistant vinyl cable	75

- Note**
- 1) Use cable with 600 V min. withstand voltage for main circuits.
 - 2) Consider allowable current reduction ratio if cables are bundled in PVC or metal ducts.
 - 3) Use temperature-resistant cable under high ambient or panel temperature where normal vinyl cables rapidly deteriorate.
- 3) The appropriate cables for Servopack connectors 1CN and 2CN are shown in the table below.

Control I/O Signal Connector	1CN	Cable	Use twisted-pair cable or twisted-pair shielded cable.
		Applicable Cable	AWG24,26,28,30
		Finished Cable Dimensions	Ø16.0 mm (Ø 0.63 in.)MAX.
PG Signal Connector	2CN	Cable	Use Yaskawa cable. Use twisted-pair shielded cable if Yaskawa cable is not used.
		Applicable Cable	Applicable cable types: AWG24, 26, 28, 30. However, use AWG22 for encoder power supply and FG line. Use AWG26 for other signals. These connections permit wiring distances up to 20 m (65.6 ft).
		Finished Cable Dimensions	Ø11.6(Ø0.46 in.) mm MAX.

- Note** Cable selection conditions: three cables per bundle at 40 °C ambient temperature, with the rated current flowing.

5.6.2 Motor Cables

1) The dimensions and appearance of the motor cables are shown below. Specify the cable type when ordering.

a) Cables For Motor Without Brake (with connector and AMP terminals)

Type	L in mm (feet)
DP9320081-1	3000 ⁺¹⁰⁰ ₀ (10 ^{+0.33} ₀)
DP9320081-2	5000 ⁺¹⁰⁰ ₀ (16.7 ^{+0.33} ₀)
DP9320081-3	10000 ⁺⁵⁰⁰ ₀ (33.3 ^{+1.67} ₀)
DP9320081-4	15000 ⁺⁵⁰⁰ ₀ (50 ^{+1.67} ₀)
DP9320081-5	20000 ⁺⁵⁰⁰ ₀ (66.7 ^{+1.67} ₀)

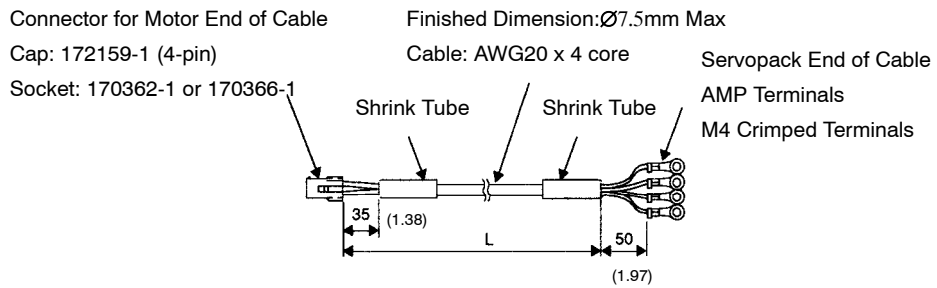

b) Cables For Motor With Brake (with connector and AMP terminals)

Type	L in mm (feet)
DP9320083-1	3000 ⁺¹⁰⁰ ₀ (10 ^{+0.33} ₀)
DP9320083-2	5000 ⁺¹⁰⁰ ₀ (16.7 ^{+0.33} ₀)
DP9320083-3	10000 ⁺⁵⁰⁰ ₀ (33.3 ^{+1.67} ₀)
DP9320083-4	15000 ⁺⁵⁰⁰ ₀ (50 ^{+1.67} ₀)
DP9320083-5	20000 ⁺⁵⁰⁰ ₀ (66.7 ^{+1.67} ₀)

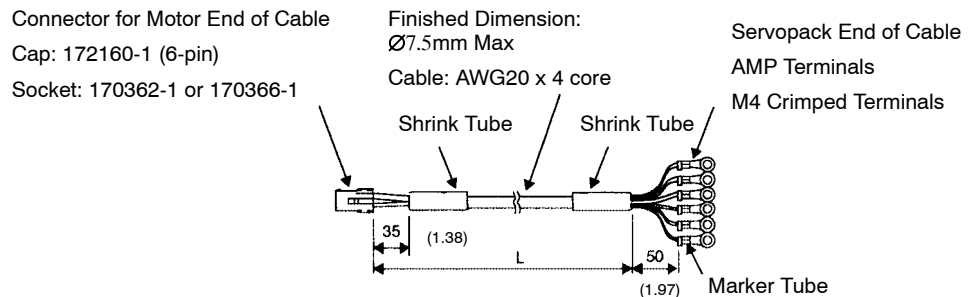

c) Cables For Motor Without Brake
(Cable Only)

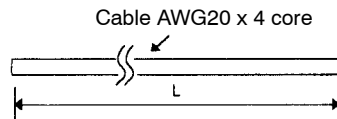

Type	L in mm (feet)
DP8409359-1	3000 ⁺¹⁰⁰ ₀ (10 ^{+0.33} ₀)
DP8409359-2	5000 ⁺¹⁰⁰ ₀ (16.7 ^{+0.33} ₀)
DP8409359-3	10000 ⁺⁵⁰⁰ ₀ (33.3 ^{+1.67} ₀)
DP8409359-4	15000 ⁺⁵⁰⁰ ₀ (50 ^{+1.67} ₀)
DP8409359-5	20000 ⁺⁵⁰⁰ ₀ (66.7 ^{+1.67} ₀)

AMP Connector
Cap: 172159-1
Socket: 170362-1 or 170366-1 (Manufactured by AMP.) *

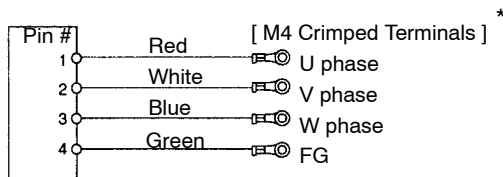

5

d) Cables For Motor With Brake
(Cable Only)

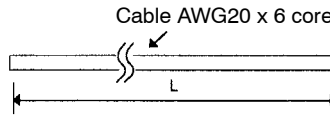

Type	L in mm (feet)
DP8409360-1	3000 ⁺¹⁰⁰ ₀ (10 ^{+0.33} ₀)
DP8409360-2	5000 ⁺¹⁰⁰ ₀ (16.7 ^{+0.33} ₀)
DP8409360-3	10000 ⁺⁵⁰⁰ ₀ (33.3 ^{+1.67} ₀)
DP8409360-4	15000 ⁺⁵⁰⁰ ₀ (50 ^{+1.67} ₀)
DP8409360-5	20000 ⁺⁵⁰⁰ ₀ (66.7 ^{+1.67} ₀)

AMP Connector
Cap: 172160-1
Socket: 170362-1 or 170366-1 (Manufactured by AMP.) *

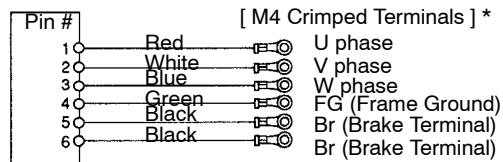

* If cable only is ordered, purchase the AMP connector and M4 crimped terminals separately. Refer to 5.6.3 Connector Kits for details about caps and sockets.

5.6.3 Connector Kits

- 1) A connector kit comprises three connectors as shown in the diagram below: one encoder connector at both the motor and Servopack ends of the cable and a motor connector for the motor end of the cable.

Encoder Connector for Motor End of Cable

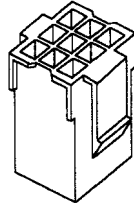

Encoder Connector for Servopack End of Cable

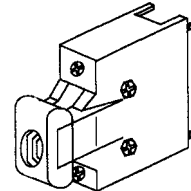

Motor Connector for Motor End of Cable

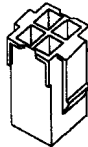

Four types of connector kit are available according to the following information:

- Is the encoder incremental or absolute?
- Is the motor with or without a brake?

A connector kit is required in the following cases:

- a) If motor cable only is purchased (whether or not motor has a brake).
 - b) If the encoder cable with a motor connector only and Servopack end without connector, or encoder cable only is purchased (for either incremental or absolute encoder).
- 2) Select one of the following two types of encoder cable connector.
- a) For Incremental Encoder

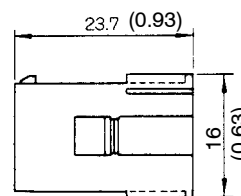
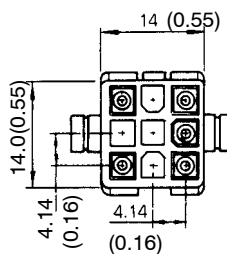

Cap: 172161-1
Socket: 170365-1

b) For Absolute Encoder

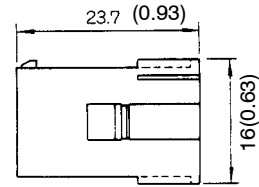
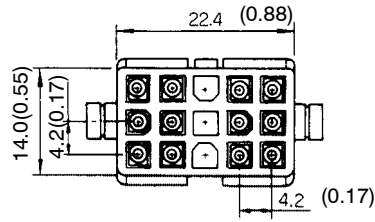

Cap: 172163-1

Socket: 170361-1 or 170365-1

3) Select one of the following two types of motor cable connector.

a) Motor Without Brake

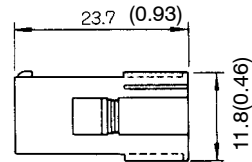
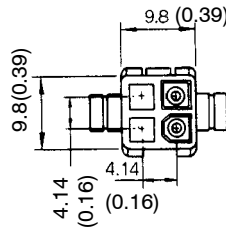

Cap: 172159-1

Socket: 170362-1 or 170366-1

b) Motor With Brake

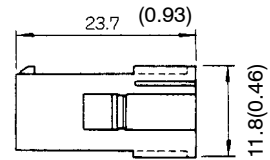
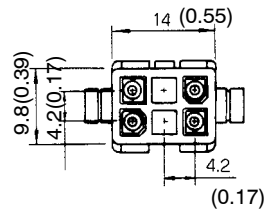

Cap: 172160-1

Socket: 170362-1 or 170366-1

4) Only one type of encoder connector is available for the Servopack end of the cable.

- Connector

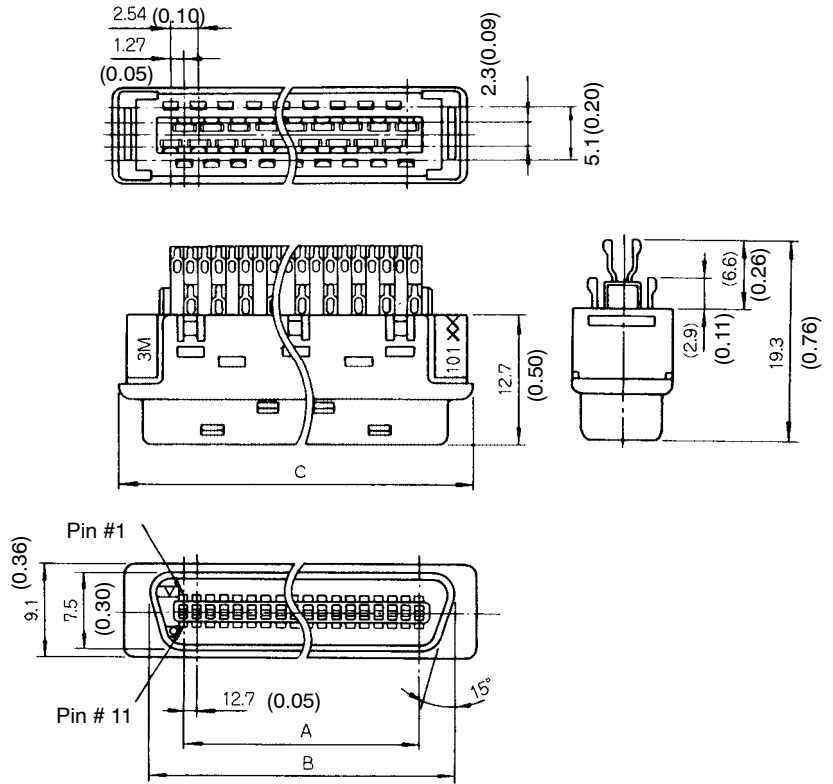

Units: mm (inches)

Connector Type	A	B	C
10120-3000VE	11.43(0.45)	17.6(0.69)	22.0(0.87)

- Case

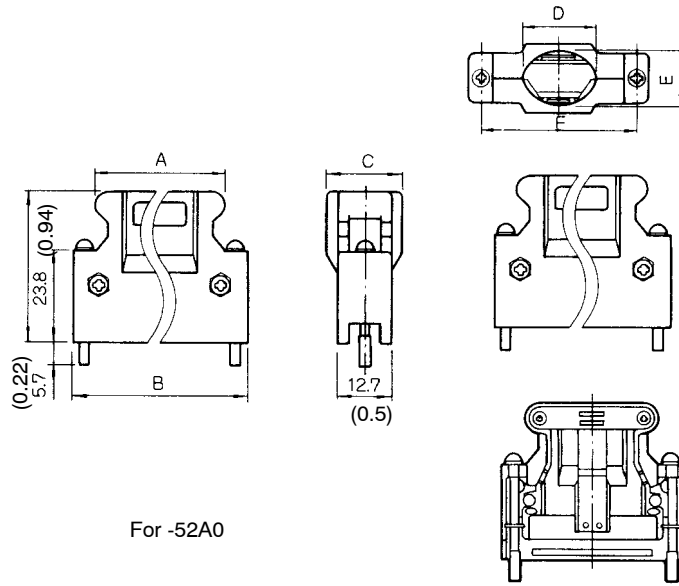

Diagram of Assembled Connector (for reference)

Units: mm (inches)

Connector	Case	A	B	C	D	E	F
10120-3000VE	10320-52A0-008	22.0 (0.87)	18.0 (0.71)	14.0 (0.55)	12.0 (0.47)	10.0 (0.39)	27.4 (1.08)

- 5) The types of connector kit are shown below. Select the type of connector kit according to the connectors selected in (2), (3), and (4) above.

Connector Kit Type	Application		Connector Kit Part List											
			Encoder/Motor Cable		For Encoder Cable						For Motor Cable			
	Encoder Type	Motor Brake With/Without	Encoder End				Servopack End				Cap		Socket	
			Cap		Socket		Connector		Case		Type	Qty	Type	Qty
Type	Qty	Type	Qty	Type	Qty	Type	Qty	Type	Qty	Type	Qty	Type	Qty	
DP9420006-1	Incremental	Without	*1	1	*1	*3	*2	1	*2	1	*1	1	*1	*3
			172161		170365	10	10120-3000VE		10320-52A0-008		172159		170366	5
DP9420006-2	Incremental	With	-1		-1						*1	1	-1	*3
											172160			7
DP9420006-3	Absolute	Without	*1	1		*3					*1	1		*3
			172163			16					172159			5
DP9420006-4	Absolute	With	-1								*1	1		*3
											172160			7
											-1			

*1 Manufactured by AMP.

*2 Manufactured by 3M.

*3 Including one spare.

5.6.4 Brake Power Supply

1) Brake power supplies are available for 200 V and 100 V input.

200 VAC Input: LPSE-2H01

100 VAC Input: LPDE-1H01

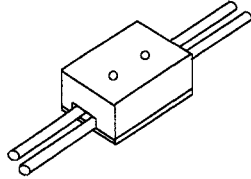

Use for Servomotor with brake.

• Dimensional Drawings

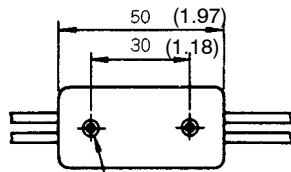

Manufactured by Yaskawa Controls Co., Ltd.

2- \varnothing 3(2- \varnothing 0.12) MTG HOLES
(SPOT FACING \varnothing 5.5
(\varnothing 0.22), 4 (0.16) LONG)

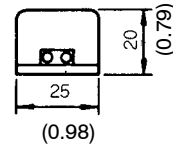
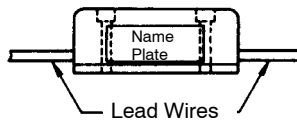

• Lead Wire Length: 500 mm each (19.69 in.)

• Max. Ambient Temperature: 60°C

• Lead Wires: Color Coded

AC Input		Brake
100V	200V	
Blue/White	Yellow/White	Red/Black

- 2) The internal circuits are shown below. While it is possible to switch either the AC or DC side of the brake power supply, it is normally safer to switch the AC side. If the DC side is to be switched, install a surge suppressor near the brake coil to prevent the surge voltages due to switching the DC side damaging the brake coil.

- Internal Circuit for 200 VAC Input (LPSE-2H01)

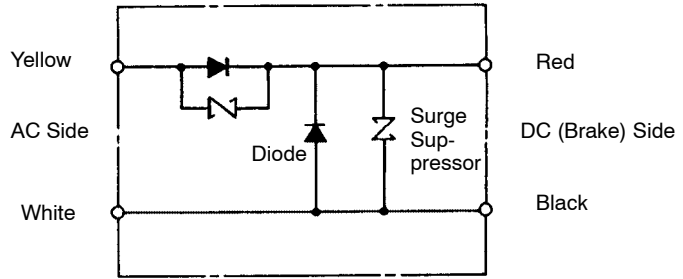

- Internal Circuit for 100 VAC Input (LPDE-1H01)

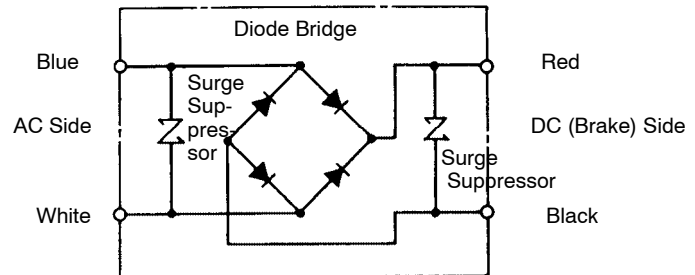

5.6.5 Encoder Cables

1) The dimensions and appearance of the encoder cables are shown below. Specify the cable type when ordering.

a) Cables for Incremental Encoder (Connector Both Ends)

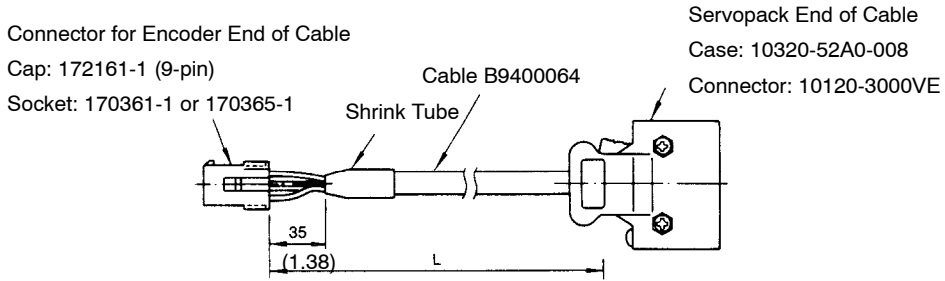

Type	L in mm (feet)
DP9320089-1	3000 ⁺¹⁰⁰ ₀ (10 ^{+0.33} ₀)
DP9320089-2	5000 ⁺¹⁰⁰ ₀ (16.7 ^{+0.33} ₀)
DP9320089-3	10000 ⁺⁵⁰⁰ ₀ (33.3 ^{+1.67} ₀)
DP9320089-4	15000 ⁺⁵⁰⁰ ₀ (50 ^{+1.67} ₀)
DP9320089-5	20000 ⁺⁵⁰⁰ ₀ (66.7 ^{+1.67} ₀)

b) Cables for Absolute Encoder (Connector Both Ends)

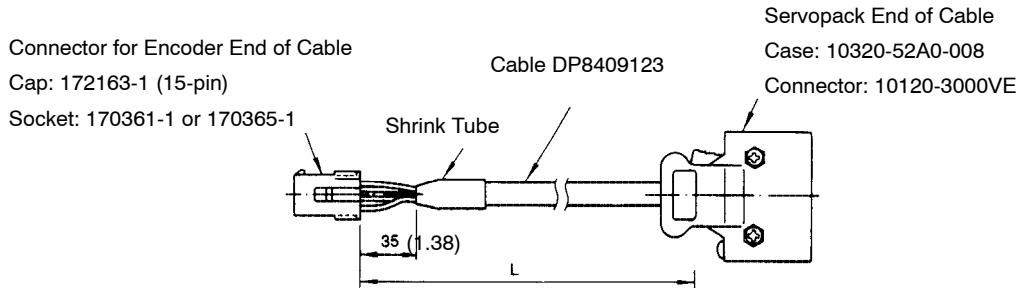

Type	L in mm (feet)
DP9320088-1	3000 ⁺¹⁰⁰ ₀ (10 ^{+0.33} ₀)
DP9320088-2	5000 ⁺¹⁰⁰ ₀ (16.7 ^{+0.33} ₀)
DP9320088-3	10000 ⁺⁵⁰⁰ ₀ (33.3 ^{+1.67} ₀)
DP9320088-4	15000 ⁺⁵⁰⁰ ₀ (50 ^{+1.67} ₀)
DP9320088-5	20000 ⁺⁵⁰⁰ ₀ (66.7 ^{+1.67} ₀)

5

c) Cables for Incremental Encoder (Servopack End without Connector)

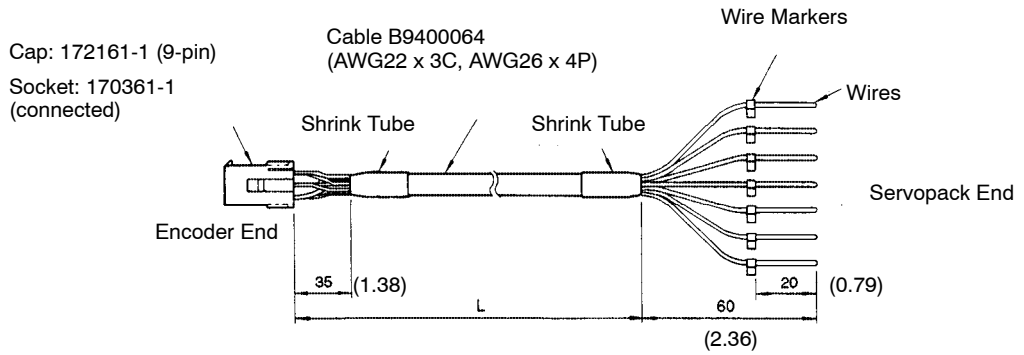

Type	L in mm (feet)
DP9320086-1	3000 ⁺¹⁰⁰ ₀ (10 ^{+0.33} ₀)
DP9320086-2	5000 ⁺¹⁰⁰ ₀ (16.7 ^{+0.33} ₀)
DP9320086-3	10000 ⁺⁵⁰⁰ ₀ (33.3 ^{+1.67} ₀)
DP9320086-4	15000 ⁺⁵⁰⁰ ₀ (50 ^{+1.67} ₀)
DP9320086-5	20000 ⁺⁵⁰⁰ ₀ (66.7 ^{+1.67} ₀)

Case: 10320-52A0-008 (Manufactured by 3M.)
 Connector: 10120-3000VE (Manufactured by 3M.)

5

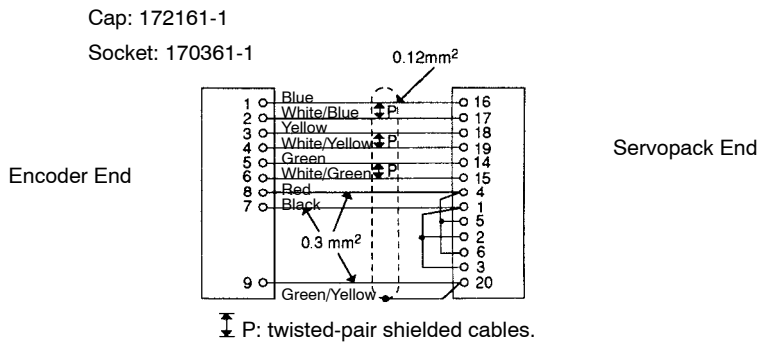

*Purchase cases and connectors separately. Refer to 5.6.3 Connector Kits for details.

d) Cables for Absolute Encoder (Servopack End without Connector)

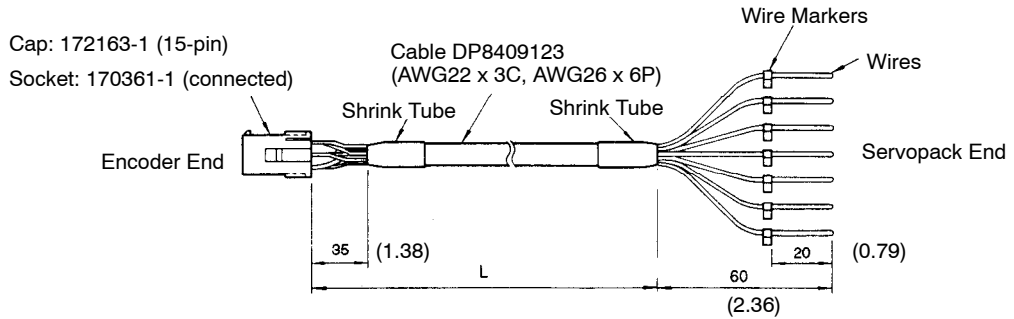

Type	L in mm (feet)
DP9320085-1	3000 ⁺¹⁰⁰ ₀ (10 0 ^{+0.33})
DP9320085-2	5000 ⁺¹⁰⁰ ₀ (16.7 0 ^{+0.33})
DP9320085-3	10000 ⁺⁵⁰⁰ ₀ (33.3 0 ^{+1.67})
DP9320085-4	15000 ⁺⁵⁰⁰ ₀ (50 0 ^{+1.67})
DP9320085-5	20000 ⁺⁵⁰⁰ ₀ (66.7 0 ^{+1.67})

Case: 10320-52A0-008 (Manufactured by 3M.)
 Connector: 10120-3000VE (Manufactured by 3M.) *

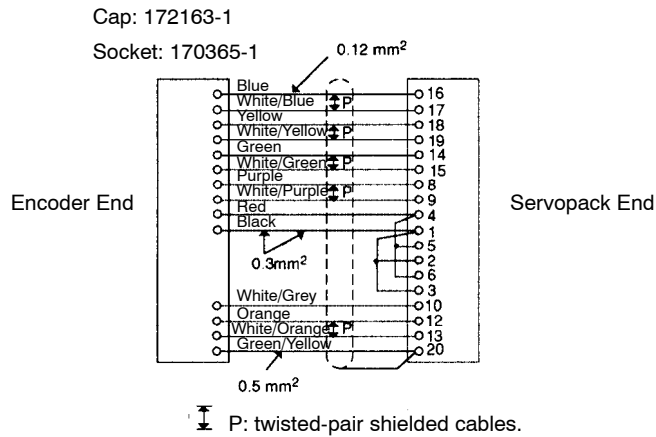

⚡ P: twisted-pair shielded cables.

*Purchase cases and connectors separately. Refer to 5.6.3 Connector Kits for details.

e) Cables for Incremental Encoder (Cable Only)

Cable AWG22 x 3C, AWG26 x 4P

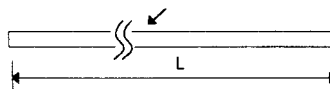

5

Type	L in mm (feet)
B9400064-1	3000 ⁺¹⁰⁰ ₀ (10 ^{+0.33} ₀)
B9400064-2	5000 ⁺¹⁰⁰ ₀ (16.7 ^{+0.33} ₀)
B9400064-3	10000 ⁺⁵⁰⁰ ₀ (33.3 ^{+1.67} ₀)
B9400064-4	15000 ⁺⁵⁰⁰ ₀ (50 ^{+1.67} ₀)
B9400064-5	20000 ⁺⁵⁰⁰ ₀ (66.7 ^{+1.67} ₀)

Cap: 172161-1 (Manufactured by AMP.) * Case: 10320-52A0-008 (Manufactured by 3M.) *

Socket: 170361-1 or 170365-1 (Manufactured by AMP.) Connector: 10120-3000VE (Manufactured by 3M.)

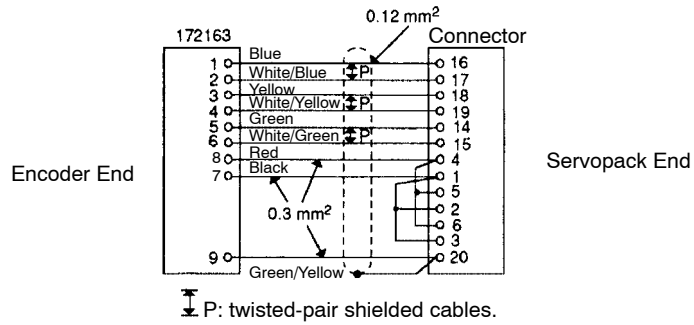

* Purchase caps, sockets, cases, and connectors separately. Refer to 3. Connector Kits for details.

f) Cables for Absolute Encoder (Cable Only)

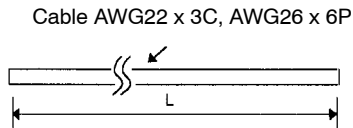

SERVO SELECTION AND DATA SHEETS

5.6.5 Encoder Cables cont.

Type	L in mm (feet)
DP8409123-1	3000 ⁺¹⁰⁰ ₀ (10 ^{+0.33} ₀)
DP8409123-2	5000 ⁺¹⁰⁰ ₀ (16.7 ^{+0.33} ₀)
DP8409123-3	10000 ⁺⁵⁰⁰ ₀ (33.3 ^{+1.67} ₀)
DP8409123-4	15000 ⁺⁵⁰⁰ ₀ (50 ^{+1.67} ₀)
DP8409123-5	20000 ⁺⁵⁰⁰ ₀ (66.7 ^{+1.67} ₀)

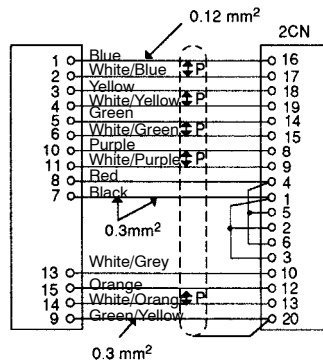
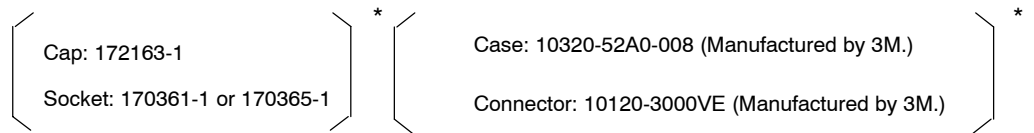

⚡ P: twisted-pair shielded cables.

* Purchase caps, sockets, cases, and connectors separately. Refer to 3. Connector Kits for details.

2) Details of the encoder cables are summarized in the table below. These cables are not supplied as accessories with a Servopack or Servomotor. Purchase in standard specified lengths as required.

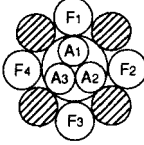
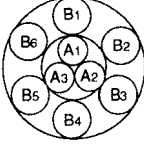
Cable Specification	Incremental Encoder (Yaskawa Drg. #B9400064)	Absolute Encoder (Yaskawa Drg. #DP8409123)
Basic Specifications	Compound KQVV-SW AWG22 x 3C, AWG26 x 4P	Compound KQVV-SW AWG22 x 3C, AWG26 x 6P
Finished Dimension	Ø7.5 mm (Ø0.30 in.)	Ø8.0 mm (Ø0.31 in.)
Internal Structure and Lead Colors	 <p>A₁ Red A₂ Black A₃ Green/Yellow F₁ Blue – White/Blue (Twisted pair) F₂ Yellow – White/Yellow (Twisted Pair) F₃ Green – White/Green (Twisted Pair) F₄ Orange – White/Orange (Twisted Pair)</p>	 <p>A₁ Red A₂ Black A₃ Green/Yellow B₁ Blue – White/Blue (Twisted pair) B₂ Yellow – White/Yellow (Twisted Pair) B₃ Green – White/Green (Twisted Pair) B₄ Orange – White/Orange (Twisted Pair) B₅ Purple – White/Purple (Twisted Pair) B₆ Grey – White/Grey (Twisted Pair)</p>
Yaskawa standard specifications	Standard lengths: 3 m (9.8ft.) , 5 m (16.4ft.) , 10 m (32.8ft.) , 15 m (49.2ft.) , 20 m (65.6ft.) *	

*When appropriate cable is used, the allowable wiring distance between Servopack and Servomotor (PG) is 20 m (65.6ft.) max.

Note See items a) to d) in this section for details about cables with connectors.

5.6.6 Battery for Absolute Encoder

- 1) Purchase the following battery if using an absolute encoder. (Manufactured by Toshiba Battery Co., Ltd.)

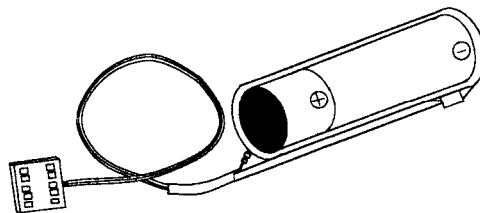

- Lithium Battery: ER 6 V C3
- Nominal Voltage: 3.6 V
- Standard Capacity: 2000 mAh

5.6.7 1CN Connector

1) This connector is required to connect the host controller to 1CN on the Servopack.

- Connector

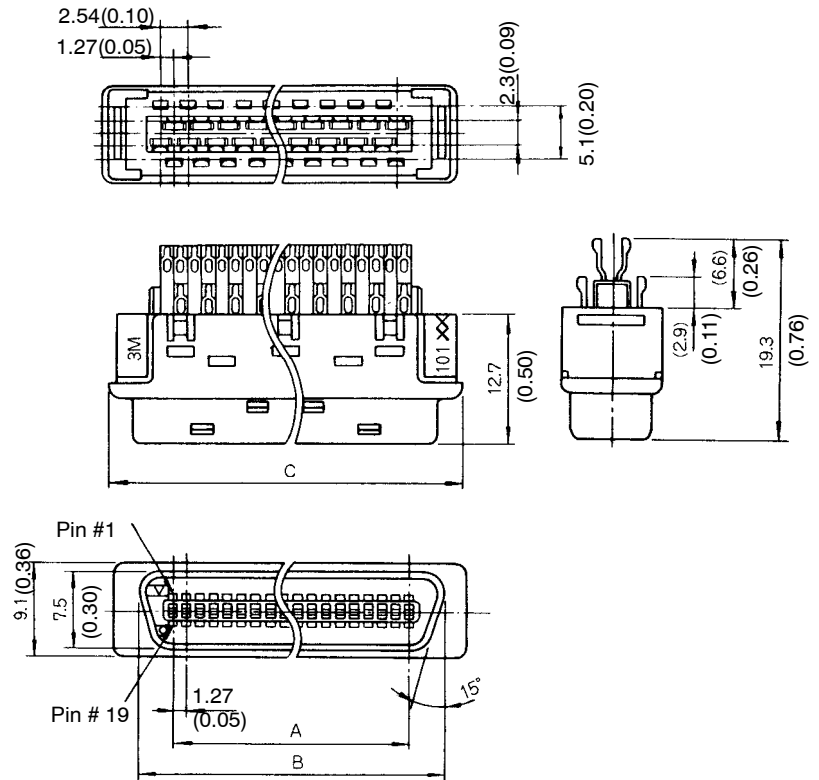

Units: mm (inches)

Connector Type	A	B	C
10136-3000VE	21.59 (0.85)	27.8 (1.09)	32.2 (1.27)

- Case

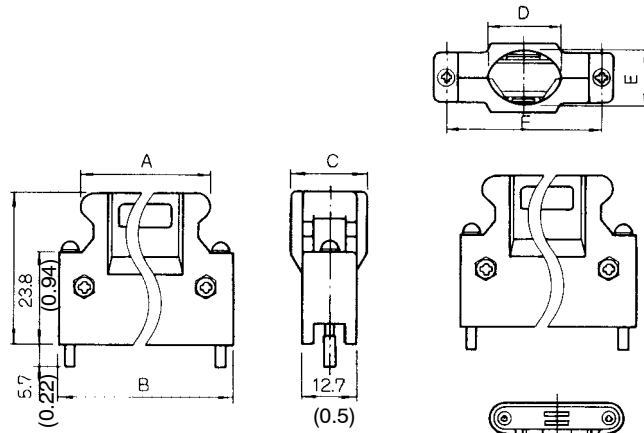

For -52A0

Diagram of Assembled Connector (for reference)

Units: mm (inches)

Connect or Type	Case Type	A	B	C	D	E	F
10136-3000VE	10336-52 A0-008	32.2 (1.27)	43.5 (1.71)	18.0 (0.71)	17.0 (0.67)	14.0 (0.55)	37.6 (1.48)

5

2) The 1CN connector type is shown below.

Connector Type	Application	Connector Part List			
		Connector		Case	
		Type	Qty	Type	Qty
DP9420007	I/O connector for 1CN	10136-3000V E*	1	10336-52A0-008*	1

* Manufactured by 3M.

5.6.8 Connector Terminal Block Converter Unit

- 1) A connector terminal block converter unit comprises a 1CN connector 0.5 m (1.64 ft) cable.
The terminal block numbers match the Servopack 1CN connector numbers.

- Connector Terminal Block Converter Unit Type: JUSP-TA36P

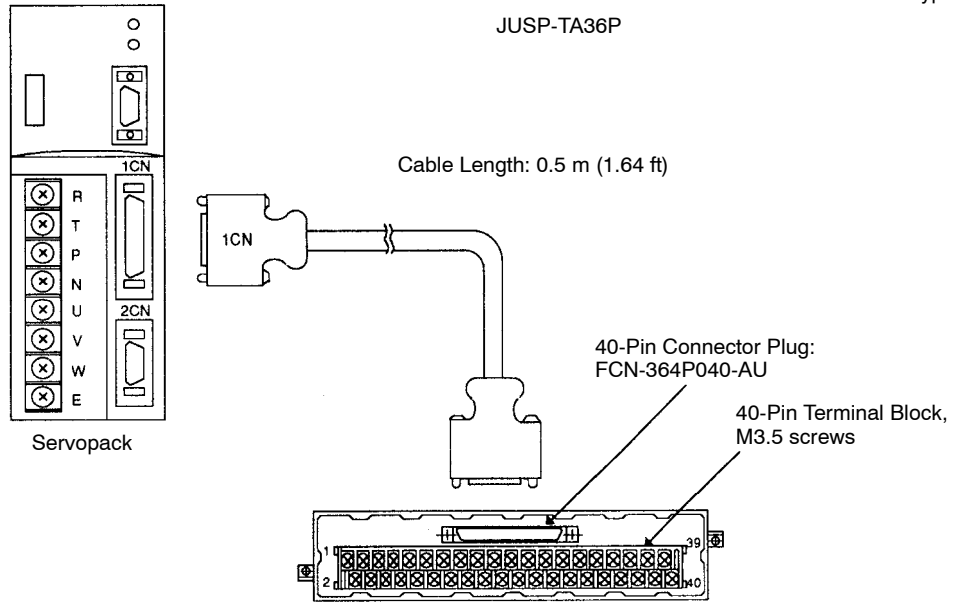

2) The relationships between terminal block pin numbers and signal names are shown in the table below.

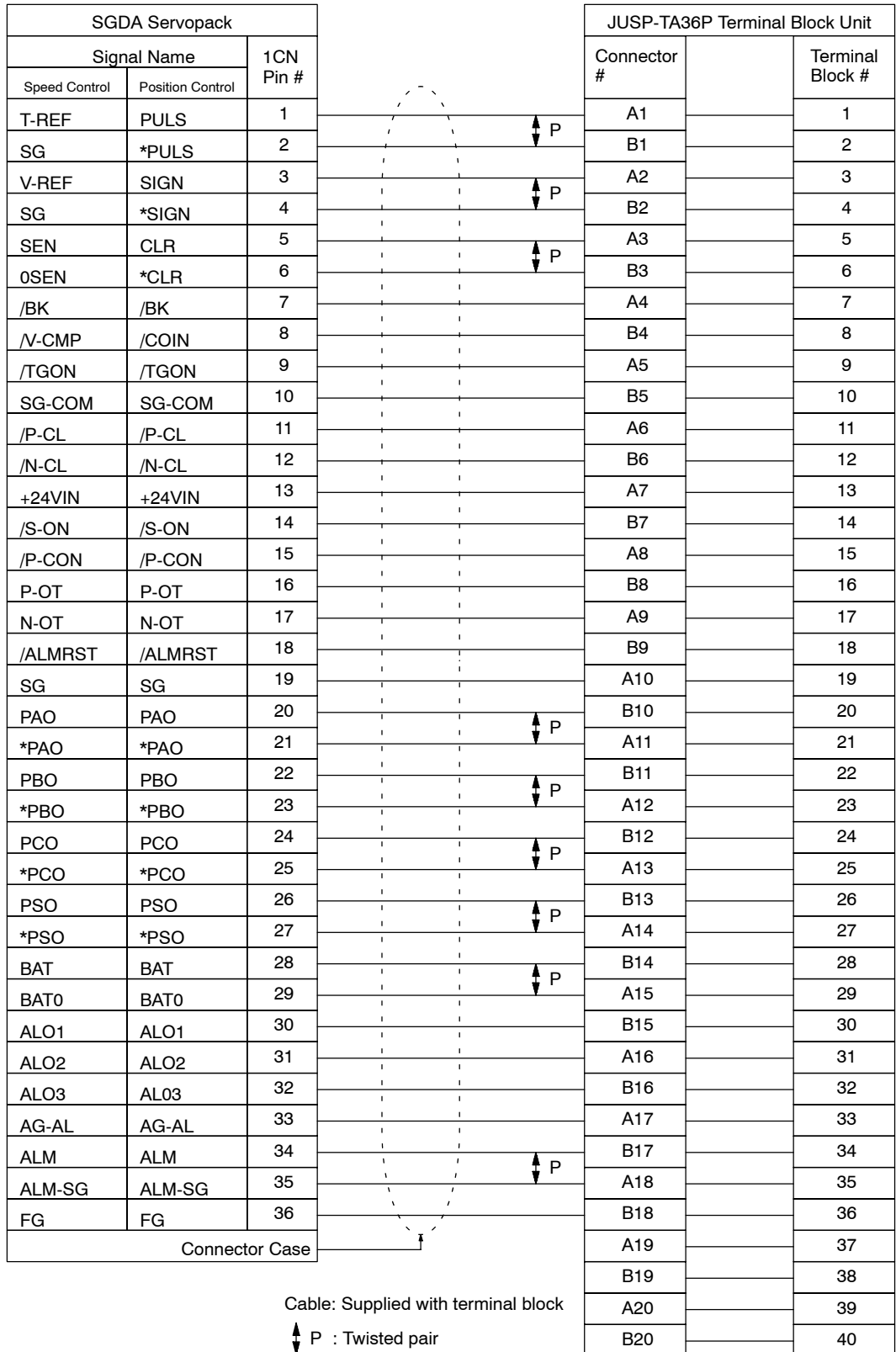

5.6.9 Cable With 1CN Connector and One End Without Connector

- 1) Use a cable with no connector at the host controller end. The loose wires are marked with labels with terminal numbers indicated.

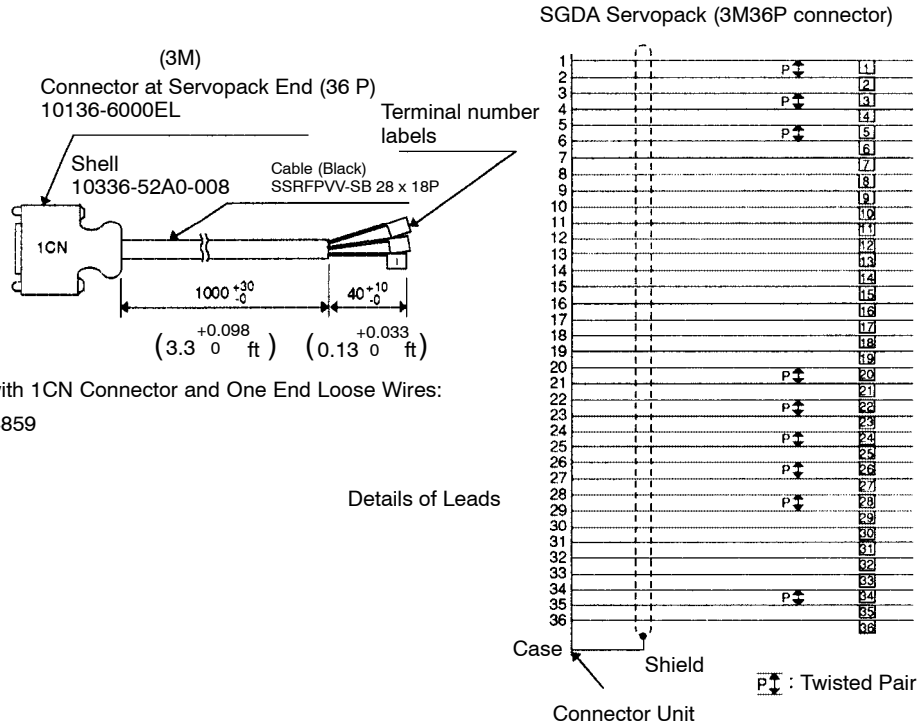

- Cable with 1CN Connector and One End Loose Wires: DE9404859

Details of Leads

5.6.10 Circuit Breaker

- 1) The customer should purchase a circuit breaker (MCCB) of appropriate capacity.

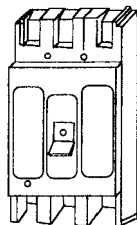

- Recommended Product

Ground fault detector for motor protection manufactured by Mitsubishi Electric Co. Ltd.
 Type: MN50-CF
 Rated Current: 7.1 A, 10 A, 16 A, 25 A, 32 A, 45A

Use to protect the power lines.

5.6.11 Noise Filter

1) Select the noise filter from the following three types according to the Servopack capacity.

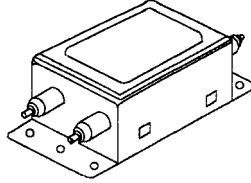

Install to eliminate external noise from the power lines.

Servopack Capacity	Noise Filter Type
30W(0.04 HP),50W(0.07HP),100W(0.13HP),200W(0.27HP)	LF-205A
200W(0.27HP)(100V),400W(0.53HP)	LF-210
300W(0.40HP)(100V),750W(1.01HP)	LF-220

• Dimensional Diagrams

- LF-205A (Single-phase 200 VAC Class, 5 A)

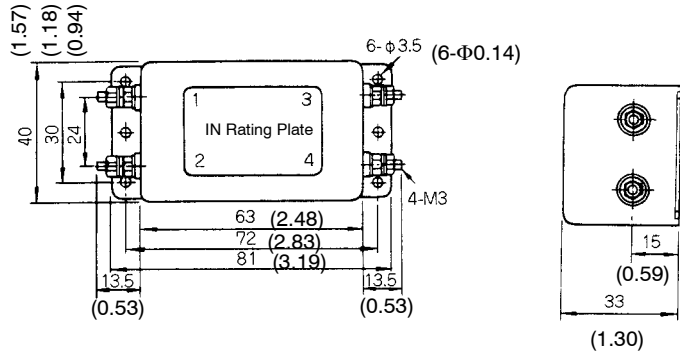

- LF-210 (Single-phase 200 VAC Class, 10 A)

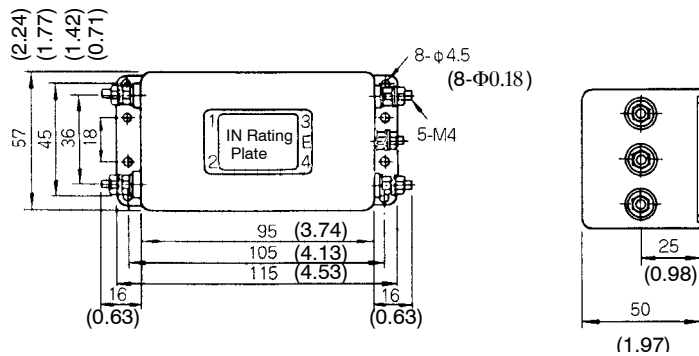

- LF-220 (Single-phase 200 VAC Class, 20 A)

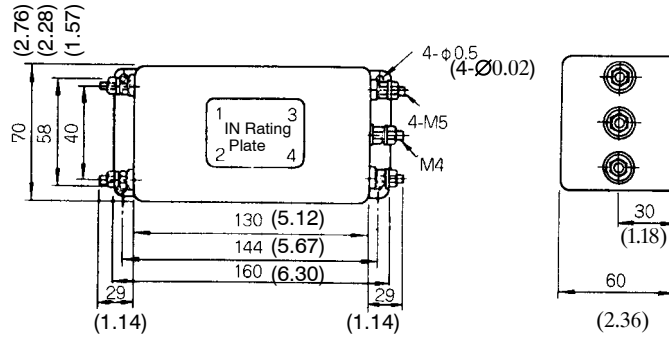

5.6.12 Magnetic Contactor

- 1) Use one 30 A magnetic contactor of the type shown below for a single Σ Series, regardless of capacity. For multiple servo systems, select the magnetic contactor according to the total capacity.

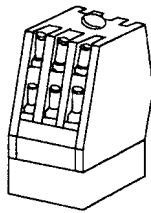

Type: HI-15E5 (30 A)

Turns servo ON and OFF.

(Note) Attach an appropriate surge suppressor to the magnetic contactor.

- Internal Connection Diagram

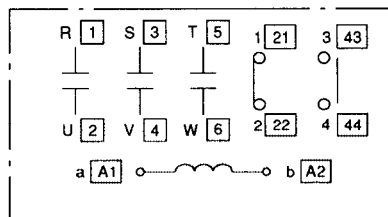

5

• Dimensional Diagram

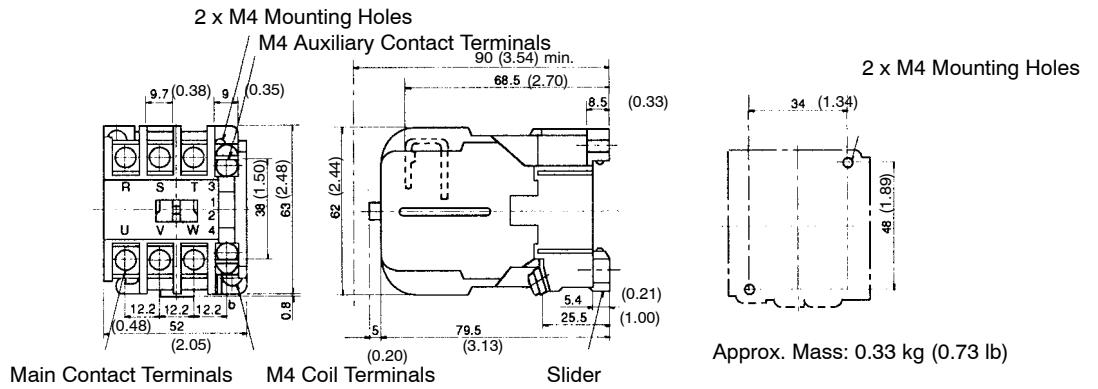

5.6.13 Surge Suppressor

- 1) Attach a surge suppressor to the magnetic contactor to prevent power supply noise and protect contacts.

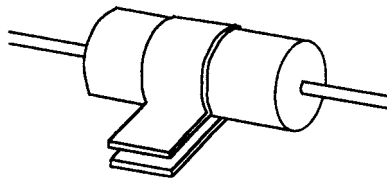

• Recommended Product

Spark Killer manufactured by Okaya Electric Industries Co., Ltd.
 Type: CR50500BA (250 VAC)
 Static Electricity Capacity: 0.5 μ F \pm 20%
 Resistance: 50 Ω (1/2 W) \pm 30%

• Regenerative Unit Specifications

Type	JUSP-RG08 JUSP-RG08C	Remarks
Applicable Servopack	SGDA Servopack	
Regenerative Working Voltage	380Vdc	
Regenerative Processing Current	8Adc	Regenerative Resistance: 50 Ω, 60 W
Error Detection Function	Regenerative resistance disconnection, regenerative transistor fault, overvoltage	
Alarm Output	Normally closed contact (open when protective function operates)	200 V operation OK
Dimensions in mm (inches)	55W × 160H × 130D (2.17W × 6.30H × 5.31D)	

5.6.15 Variable Resistor for Speed Setting

- 1) This variable resistor is used to give speed references by applying the speed reference voltage from the external power supply across 1CN pins #3 and #4.

• Dimensional Drawings

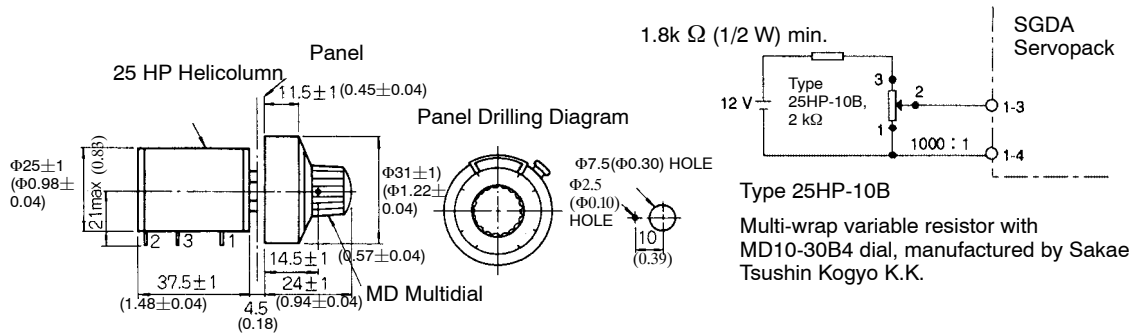

5.6.16 Encoder Signal Converter Unit

- 1) Unit to convert the encoder signal output from the line driver to an open collector output or voltage pulse output.

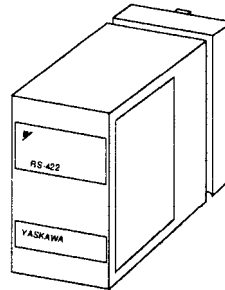

Line Receiver Unit

• Terminal Numbers

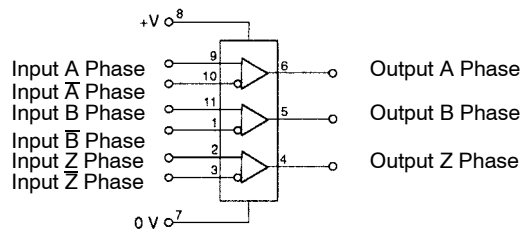

• Dimensional Drawings

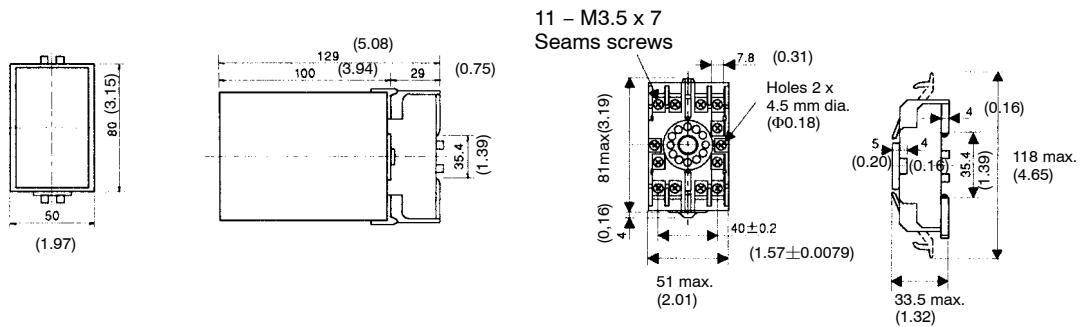

5

2) The encoder signal converter unit specifications are as follows:

Type	Receiver Unit			
Spec.	LRX-01/A1	LRX-01/A2	LRX-01/A3	LRX-01/A4
Power Supply	12 VDC \pm 10%, 100 mA		5 VDC \pm 10%, 100 mA	
Input Signals	Balanced line driver input (RS-422)			
Output Signals	Voltage pulse output	Open collector output	Voltage pulse output	Open collector output
Input Signal Level	Voltage differential \geq 0.3 V, internal termination resistance 100 Ω			
Output Signal Level	H: 10 V min. (1 mA) L: 0.5 V max. (30 mA)	L: 0.5 V max. (30 mA) Withstand voltage: 50 V	H: 3 V min. (1 mA) L: 0.5 V max. (30 mA)	L: 0.5 V max. (30 mA) Withstand voltage: 50 V
Operating Ambient Temperature Range	0 to +60°C			
IC Used	AM26LS32C Receiver IC, or equivalent			

5.6.17 Cables for Connecting PC and Servopack

- 1) Special cables for connecting a PC to a Servopack. Using these cables allows monitoring and setting of user constants with a PC.
PC software is available for these communications. Ask your Yaskawa representative for details. Operate the software as described in the manual supplied.

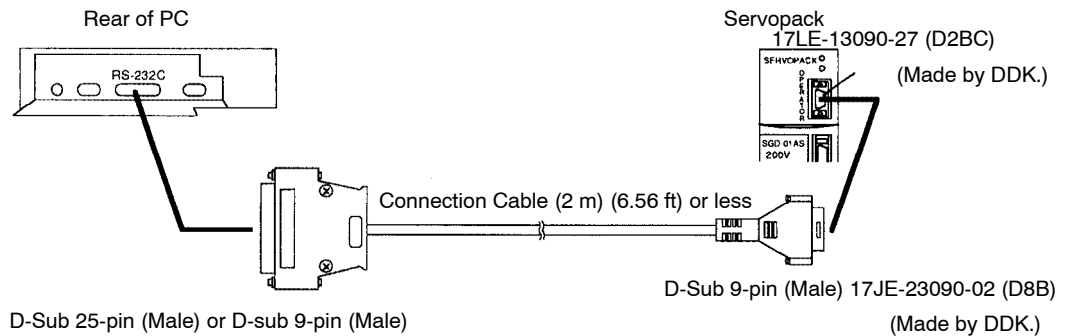

- Dimensional Drawings for Type DE9405258 (for NEC PC)

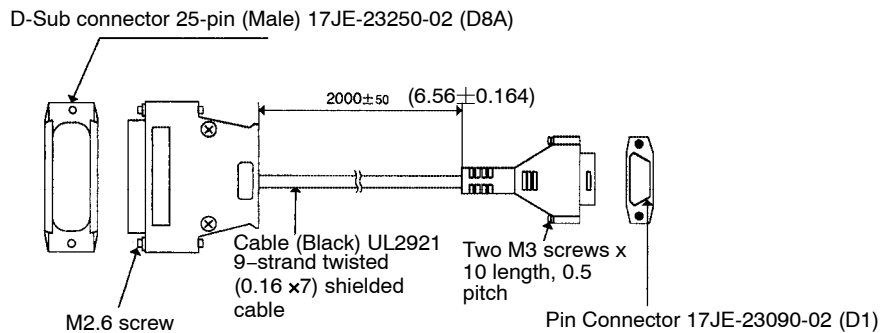

Note: Fold back the cable shielding at each end of the cable and secure it with clamps.

- 2) The communications specifications and connecting-circuit specifications are listed below.

- Baud Rate: 9600 bps
- Number of Bits
 - Start: 1 bit
 - Data: 7 bits
 - Stop: 1 bit
 - Parity: 1 bit (even)
- Synchronization: Start-Stop
- XON/XOFF Control: None
- Shift Control: None

5

- Communications Method: Semi-duplex

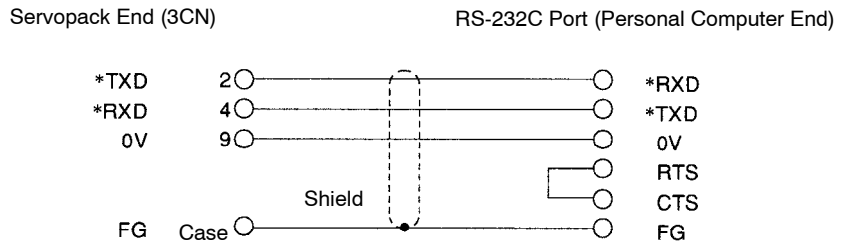

Note: Maximum cable length is 2 m (6.56 ft).

3) Connection is also possible to the RS-422A port. In this case, the connection circuit is as follows:

- Transmission Distance: 30 m (98.4 ft) max.
- Transmission System: RS-422A

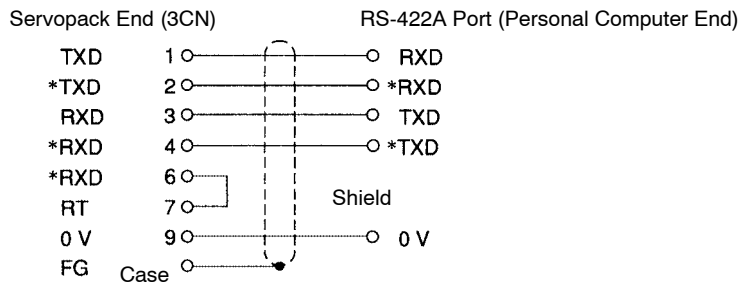

- Terminal Arrangement at Servopack End

Pin #	Signal Name	Signal Circuit Name	Signal Direction
1	TXD	Transmit data (not inverted)	P←S
2	*TXD	Transmit data (inverted)	P←S
3	RXD	Receive data (not inverted)	P→S
4	*RXD	Receive data (inverted)	P→S
5	OPH		#
6	*RXD	Shorting pins 6 and 7 inserts 220 Ω termination resistance between RXD and *RXD.	
7	RT		
8	5VPP		#
9	GND	Signal ground 0 V	

P: Personal computer
 S: Servopack
 #: Terminal not used, leave open.

4) Cable for connecting Servopack and IBM PC (IBM compatible PC)

Use Yaskawa DE9408565 type cable.

• Dimensional Drawings

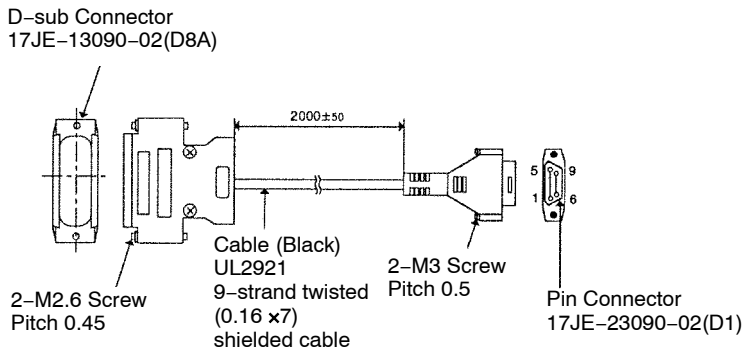

Note: Fold back the cable shielding at each end of the cable and secure it with clamp.

• Connection

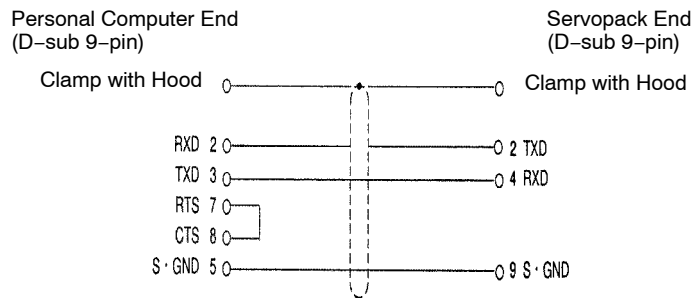

5) Cable for connecting Servopack and NEC PC-98 half-pitch connector

Use Yaskawa DE9408564 type cable.

• Dimensional Drawings

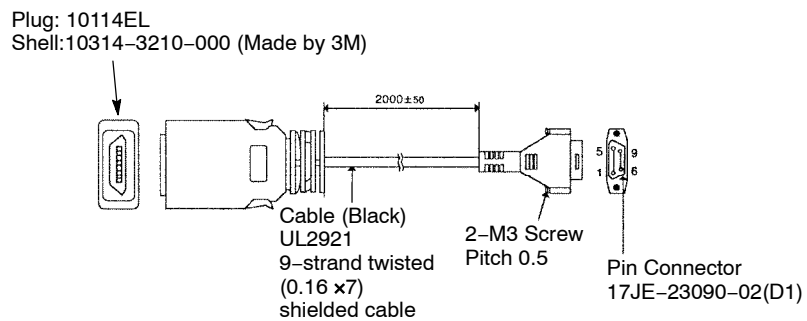

Note: Fold back the cable shielding at each end of the cable and secure it with clamp.

• Connection

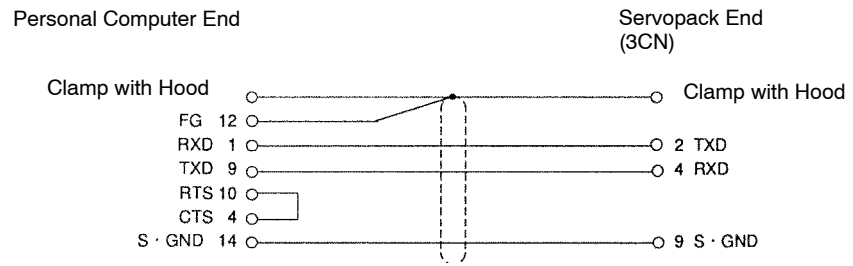

INSPECTION, MAINTENANCE, AND TROUBLESHOOTING

6

This chapter describes the basic inspections and maintenance to be carried out by the customer.

In addition, troubleshooting procedures are described for problems which cause an alarm display and for problems which result in no alarm display.

6.1	Inspection and Maintenance	344
6.1.1	Servomotor	344
6.1.2	Servopack	345
6.1.3	Replacing Battery for Absolute Encoder	346
6.2	Troubleshooting	347
6.2.1	Troubleshooting Problems with Alarm Display	347
6.2.2	Troubleshooting Problems With No Alarm Display	366
6.2.3	Internal Connection Diagram and Instrument Connection Examples	368

6.1 Inspection and Maintenance

This section describes the basic inspections and maintenance for Σ -Series servo drives.

6.1.1	Servomotor	344
6.1.2	Servopack	345
6.1.3	Replacing Battery for Absolute Encoder	346

6.1.1 Servomotor

For inspection and maintenance of servomotors, follow the simple, daily inspection procedures in the table below.

The AC servomotors are brushless. Simple, daily inspection is sufficient. The inspection and maintenance frequencies in the table are only guidelines. Increase or decrease the frequency to suit the operating conditions and environment.

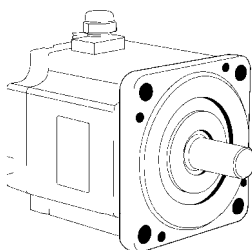

6

Item	Frequency	Procedure	Comments
Vibration and noise	Daily	Touch and listen.	Levels higher than normal?
Appearance	According to degree of contamination	Clean with cloth or compressed air.	
Insulation resistance measurement	Yearly	Disconnect Servopack and test insulation resistance at 500 V. Must exceed 10 M Ω . (See note below)	Contact your Yaskawa representative if the insulation resistance is below 10 M Ω .
Replace oil seal	Every 5,000 hours	Remove servomotor from machine and replace oil seal.	Applies only to motors with oil seal.
Overhaul	Every 20,000 hours or 5 years	Contact your Yaskawa representative.	The customer should not disassemble and clean the servomotor.

Note Measure across the servomotor FG (green/yellow) and the U-phase (red), V-phase (white), or W-phase (blue) power lead.

During inspection and maintenance, do not disassemble the servomotor. If disassembly of the servomotor is required, contact your Yaskawa representative.

6.1.2 Servopack

For inspection and maintenance of the Servopack, follow the inspection procedures in the table below at least once every year.

The Servopack contains highly reliable parts and daily inspection is not required. Carry out the inspections and maintenance in the table below once every year.

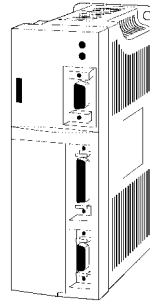

Item	Frequency	Procedure	Remedy
Clean unit interior and circuit boards	Yearly	Check for dust, dirt, and oil on the surfaces.	Clean with compressed air.
Loose screws	Yearly	Check for loose terminal block and connector screws.	Tighten any loose screws.
Defective parts in unit or on circuit boards.	Yearly	Check for discoloration, damage or discontinuities due to heating.	Contact your Yaskawa representative.

Part Replacement Schedule

The following parts are subject to mechanical wear or deterioration over time. To avoid failure, replace these parts at the frequency indicated.

Part	Standard Replacement Period	Replacement Method
Smoothing Capacitor	7 to 8 years	Test. Replace with new part if necessary.
Relays	---	Test. Replace if necessary.
Fuse	10 years	Replace with new part.

Note Operating Conditions:

- Ambient Temperature: annual average 30°C
- Load Factor: 80% max.
- Operation Rate: 20 hours/day max.

6.1.3 Replacing Battery for Absolute Encoder

Battery replacement is only required for servo systems using an absolute encoder.

The battery type recommended below (purchased by the customer) is installed in the host controller to allow the absolute encoder to store position data when the power is turned OFF.

Recommended Battery:

- Lithium Battery
ER 6 V C3, manufactured by Toshiba Battery Co., Ltd. 3.6 V, 2000 mAh
Estimated Life: Approximately 10 years

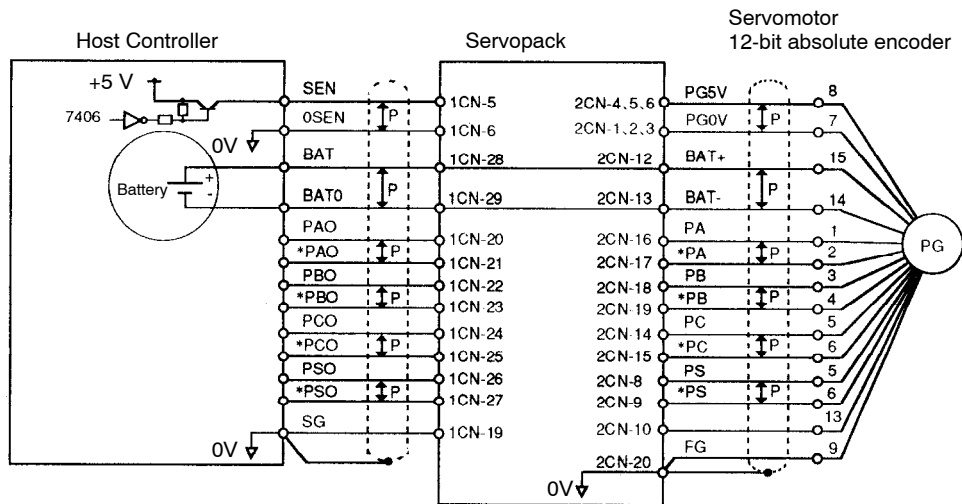
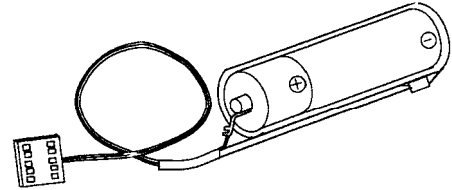

The battery voltage is not internally monitored in the Servopack. Therefore, detect low battery voltage at the host controller.

Minimum required battery voltage is 2.8 V.

Replace the battery according to the following procedure if the battery voltage drops to the minimum required battery voltage. The battery maintains absolute position data stored in the encoder.

Battery Replacement Procedure:

- 1) Turn ON the Servopack and wait at least 3 minutes. The absolute encoder capacitors are charged.
- 2) Replace the battery in the host controller. The Servopack power supply can be ON or OFF during battery replacement.

Note After completing step 1 above, the absolute encoder will function normally for up to 2 days with no battery.

6.2 Troubleshooting

This section describes causes and remedies for problems which cause an alarm display and for problems which result in no alarm display.

6.2.1	Troubleshooting Problems with Alarm Display	347
6.2.2	Troubleshooting Problems With No Alarm Display	366
6.2.3	Internal Connection Diagram and Instrument Connection Examples	368

6.2.1 Troubleshooting Problems with Alarm Display

Refer to the tables below to identify the cause of a problem which causes an alarm display and take the remedy described.

Note that A.99 does not indicate an alarm.

Contact your Yaskawa representative if the problem cannot be solved by the described procedures.

1. Alarm Display and Troubleshooting Table

Display and Outputs

Digital Operator Display and Alarm Name	Alarm Output			
	Alarm Code Output			Alarm Output
	ALO1	ALO2	ALO3	
A.00 Absolute data error	OFF	OFF	OFF	OFF

OFF: Output transistor is OFF
ON: Output transistor is ON

Status When Alarm Occurred

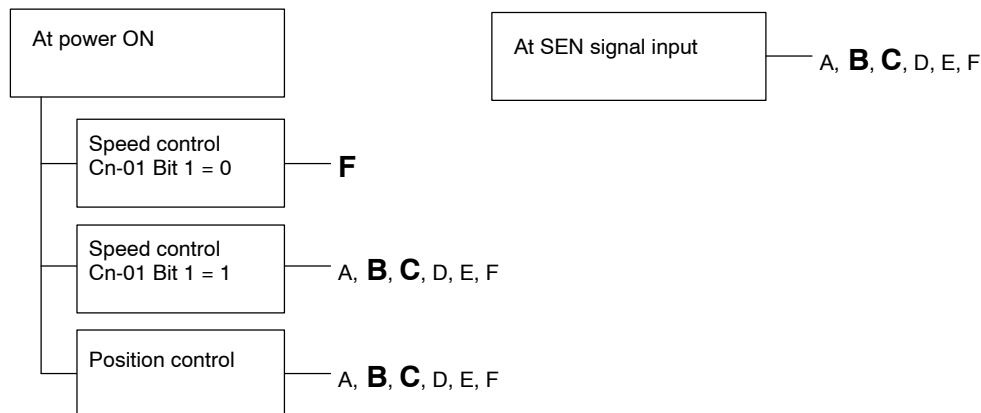

6.2.1 Troubleshooting Problems with Alarm Display cont.

	Cause	Remedy
A	Absolute encoder power not supplied from Servopack.	Use the Servopack power supply for the absolute encoder.
B	Incorrect absolute encoder wiring (PA, PB, RESET, SEN signal (for speed control), etc.)	Check and correct the absolute encoder wiring.
C	Absolute encoder malfunctioned	<ul style="list-style-type: none"> For speed control (Cn-01 Bit 1 = 0), turn SEN signal OFF and back ON. (See note) For speed control (Cn-01 Bit 1 = 1) or position control, turn Servopack power OFF and back ON.
D	Incorrect user constant setting. Incremental encoder used with Cn-01 Bit E set to 1.	Set Cn-01 Bit E to 0.
E	Absolute encoder defective	Replace servomotor.
F	Circuit board (1PWB) defective	Replace Servopack.

Note Alarm A.00 is reset when the power is turned OFF and back ON. It is not reset by the normal alarm reset.

NOTE Resetting SEN Signal

When resetting the SEN signal (i.e., turning it OFF and then back ON) for any reason, keep the SEN signal at the high level for more than 1.3 s before turning it OFF.

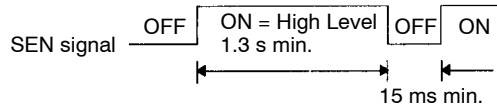

Display and Outputs

Digital Operator Display and Alarm Name	Alarm Output			
	Alarm Code Output			Alarm Output
	ALO1	ALO2	ALO3	
A.02 User constants breakdown	OFF	OFF	OFF	OFF

OFF: Output transistor is OFF
ON: Output transistor is ON

Status When Alarm Occurred



	Cause	Remedy
A	Power turned OFF during parameter write. Alarm occurred next power ON.	Replace Servopack.
B	Circuit board (1PWB) defective	Replace Servopack.

Display and Outputs

Digital Operator Display and Alarm Name	Alarm Output			
	Alarm Code Output			Alarm Output
	ALO1	ALO2	ALO3	
A.04 User constant setting error	OFF	OFF	OFF	OFF

OFF: Output transistor is OFF
ON: Output transistor is ON

Status When Alarm Occurred



	Cause	Remedy
A	An out-of-range user constant was previously set or loaded.	Reset all user constants in range. Otherwise, re-load correct user constants.
B	Circuit board (1PWB) defective	Replace Servopack.

Display and Outputs

Digital Operator Display and Alarm Name	Alarm Output			
	Alarm Code Output			Alarm Output
	ALO1	ALO2	ALO3	
A.10 Overcurrent	ON	OFF	OFF	OFF

OFF: Output transistor is OFF
ON: Output transistor is ON

Status When Alarm Occurred

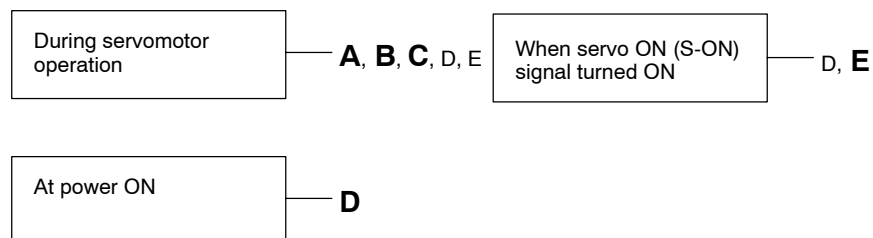

6.2.1 Troubleshooting Problems with Alarm Display cont.

	Cause	Remedy
A	Wiring grounded between Servopack and servomotor.	Check and correct wiring.
B	Servopack ambient temperature exceeds 55°C	Bring Servopack ambient temperature to 55°C Note Alarm cannot be reset while power transistor module temperature exceeds 90°C.
C	Servomotor U, V, or W phase grounded.	Replace servomotor.
D	<ul style="list-style-type: none"> • Circuit board (1PWB) defective • Power transistor defective 	Replace Servopack.
E	Current feedback circuit, power transistor, DB relay, or circuit board defective.	Replace Servopack.

Display and Outputs

Digital Operator Display and Alarm Name	Alarm Output			
	Alarm Code Output			Alarm Output
	ALO1	ALO2	ALO3	
A.31 Position error pulse overflow (position control only)	ON	ON	OFF	OFF

OFF: Output transistor is OFF
ON: Output transistor is ON

Status When Alarm Occurred

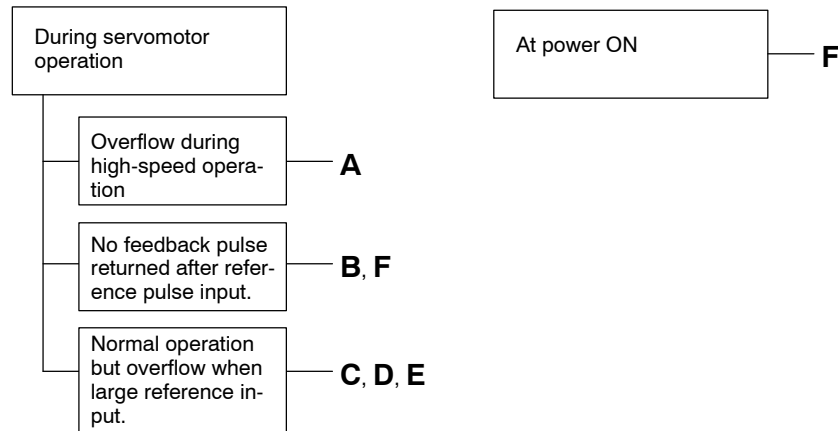

	Cause	Remedy
A	Servomotor wiring incorrect.	Check and correct wiring. (Check A-, B-, C-phase pulses correct at 2CN.)
B	Encoder wiring incorrect (disconnection, shortcircuit, power supply, etc.)	
C	Servopack adjustment incorrect	Increase speed loop gain (Cn-04) and/or position loop gain (Cn-1A).
D	Servomotor overloaded	Reduce load torque and inertia. Otherwise, replace with larger capacity servomotor.
E	Position reference pulse frequency too high	<ul style="list-style-type: none"> • Decrease reference pulse frequency. • Use smoothing function. • Change electronic gear ratio.
F	Circuit board (1PWB) defective.	Replace Servopack.

Display and Outputs

Digital Operator Display and Alarm Name	Alarm Output			
	Alarm Code Output			Alarm Output
	ALO1	ALO2	ALO3	
A.40 Overvoltage	OFF	OFF	ON	OFF

OFF: Output transistor is OFF
ON: Output transistor is ON

Status When Alarm Occurred

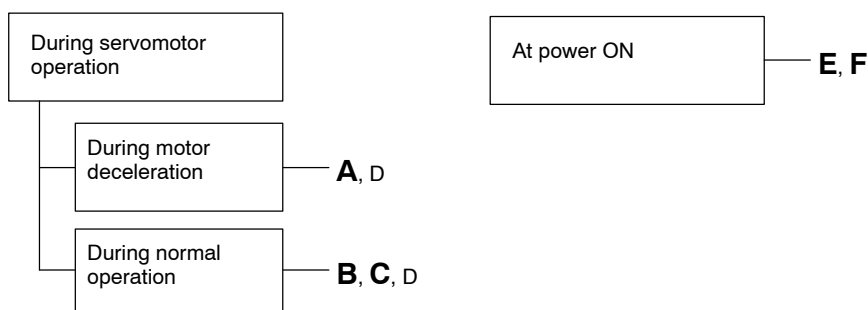

	Cause	Remedy
A	Load inertia high and motor speed too high	<ul style="list-style-type: none"> • Change operating conditions. • Use regenerative unit. • If multiple units are used, connect all P, N terminals in parallel.
B	Load exceeds capacity of regenerative unit	Change operating conditions.
C	Servomotor speed too high	Reduce motor speed.
D	Servopack defective	Replace Servopack.
E	Input voltage too high	Change input voltage to normal value.
F	Circuit board (1PWB) defective.	Replace Servopack.

Display and Outputs

Digital Operator Display and Alarm Name	Alarm Output			
	Alarm Code Output			Alarm Output
	ALO1	ALO2	ALO3	
A.51 Overspeed	ON	OFF	ON	OFF

OFF: Output transistor is OFF
ON: Output transistor is ON

Status When Alarm Occurred

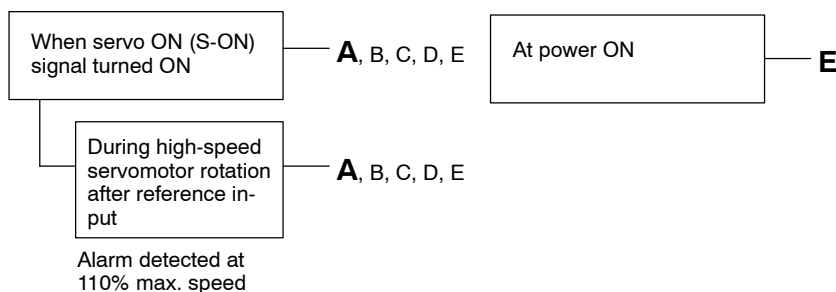

	Cause	Remedy
A	<ul style="list-style-type: none"> Servomotor wiring incorrect. Encoder wiring incorrect (disconnection, shortcircuit, power supply, etc.) 	Check and correct wiring. (Check A-, B-, C-phase pulses correct at 2CN.)
B	Incremental encoder power not supplied from Servopack.	Use the Servopack power supply for the encoder.
C	Noise in encoder wiring.	Separate encoder wiring from main wiring circuits.
D	Incorrect user constant (number of encoder pulses) setting.	Set user constant Cn-11 to the correct number of pulses.
E	Circuit board (1PWB) defective	Replace Servopack.

Display and Outputs

Digital Operator Display and Alarm Name	Alarm Output			
	Alarm Code Output			Alarm Output
	ALO1	ALO2	ALO3	
A.70 Overload	ON	ON	ON	OFF

OFF: Output transistor is OFF

ON: Output transistor is ON

Status When Alarm Occurred

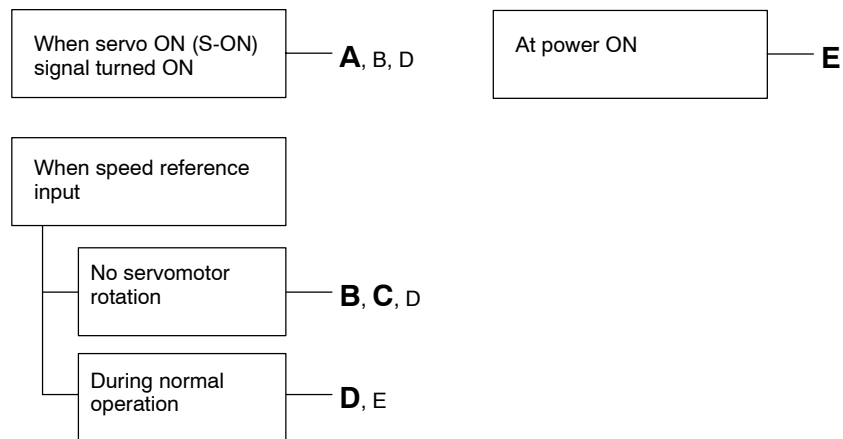

	Cause	Remedy
A	Servomotor wiring incorrect or disconnected	Check wiring and connectors at servomotor.
B	Encoder wiring incorrect or disconnected	Check wiring and connectors at encoder.
C	Load greatly exceeds rated torque	Reduce load torque and inertia. Otherwise, replace with larger capacity servomotor.
D	Incremental encoder power not supplied from Servopack.	Use the Servopack power supply for the encoder.
E	Circuit board (1PWB) defective	Replace Servopack.

Display and Outputs

Digital Operator Display and Alarm Name	Alarm Output			
	Alarm Code Output			Alarm Output
	ALO1	ALO2	ALO3	
A.80 Absolute encoder error (only if absolute encoder is used)	OFF	OFF	OFF	OFF

OFF: Output transistor is OFF
ON: Output transistor is ON

Status When Alarm Occurred

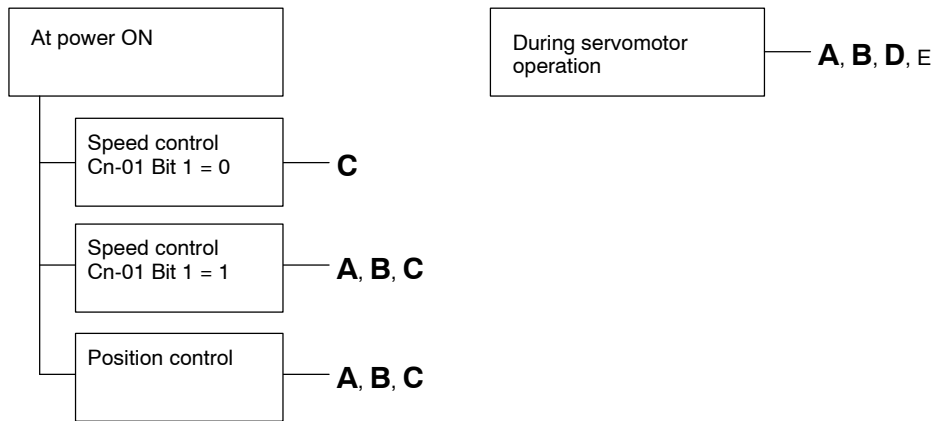

	Cause	Remedy
A	Incorrect absolute encoder wiring (PA, PB, RESET, SEN signal (for speed control), etc.)	Check and correct the absolute encoder wiring.
B	Absolute encoder malfunctioned	<ul style="list-style-type: none"> For speed control (Cn-01 Bit 1 = 0), turn SEN signal OFF and back ON. For speed control (Cn-01 Bit 1 = 1) or position control, turn Servopack power OFF and back ON.
C	Circuit board (1PWB) defective	Replace Servopack.
D	Error occurred in absolute encoder. Another encoder alarm displayed when SEN signal or power supply turned back ON.	<ul style="list-style-type: none"> For speed control (Cn-01 Bit 1 = 0), turn SEN signal OFF and back ON (if servomotor is rotating, first turn servo OFF). For speed control (Cn-01 Bit 1 = 1) or position control, turn Servopack power OFF and back ON.
E	Servopack miscounted pulses (positional displacement) or malfunctioned due to noise.	<ul style="list-style-type: none"> Separate encoder wiring from main wiring circuits. For speed control (Cn-01 Bit 1 = 0), turn SEN signal OFF and back ON (if servomotor is rotating, first turn servo OFF). For speed control (Cn-01 Bit 1 = 1) or position control, turn Servopack power OFF and back ON.

6

Display and Outputs

Digital Operator Display and Alarm Name	Alarm Output			
	Alarm Code Output			Alarm Output
	ALO1	ALO2	ALO3	
A.81 Absolute encoder back-up error (only if absolute encoder is used)	OFF	OFF	OFF	OFF

OFF: Output transistor is OFF
ON: Output transistor is ON

Status When Alarm Occurred

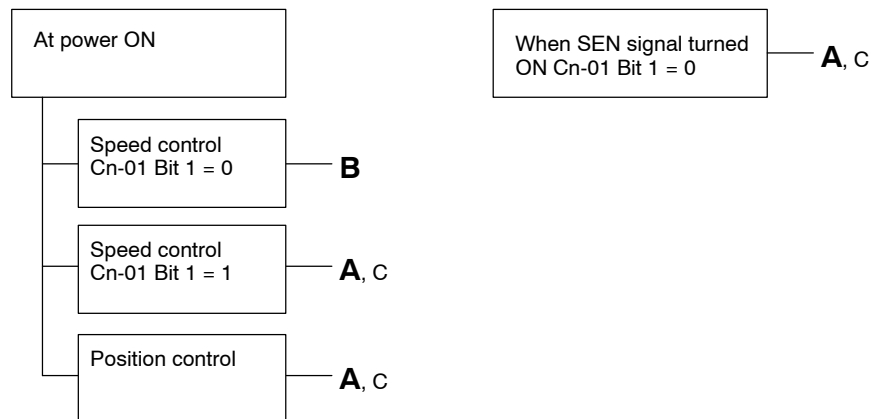

	Cause	Remedy
A	The following power supplied to the absolute encoder all failed: <ul style="list-style-type: none"> • +5 V supply • Battery (ER6V C3) • Internal capacitor 	Follow absolute encoder set-up procedures.
B	Circuit board (1PWB) defective	Replace Servopack.
C	Absolute encoder malfunctioned	Replace servomotor.

Display and Outputs

Digital Operator Display and Alarm Name	Alarm Output			
	Alarm Code Output			Alarm Output
	ALO1	ALO2	ALO3	
A.82 Absolute encoder sum-check error (only if absolute encoder is used)	OFF	OFF	OFF	OFF

OFF: Output transistor is OFF
ON: Output transistor is ON

Status When Alarm Occurred

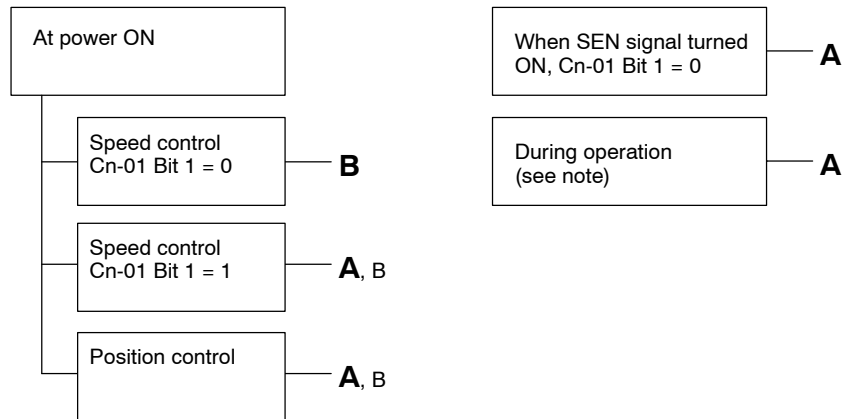

	Cause	Remedy
A	Abnormality during absolute encoder memory check	<ul style="list-style-type: none"> Follow absolute encoder set-up procedures. Replace servomotor if error occurs frequently.
B	Circuit board (1PWB) defective	Replace Servopack.

Note An absolute encoder error (A.80) is given initially if a sum-check error (A.82) is generated during operation.
The sum-check error (A.82) occurs after turning the SEN signal (or Servopack power supply) OFF and back ON.
However, the sum-check error (A.82) does occur during operation if the host controller is receiving the S-phase signal (serial data).

6

Display and Outputs

Digital Operator Display and Alarm Name	Alarm Output			
	Alarm Code Output			Alarm Output
	ALO1	ALO2	ALO3	
A.83 Absolute encoder sum-check error (only if absolute encoder is used)	OFF	OFF	OFF	OFF

OFF: Output transistor is OFF
ON: Output transistor is ON

Status When Alarm Occurred

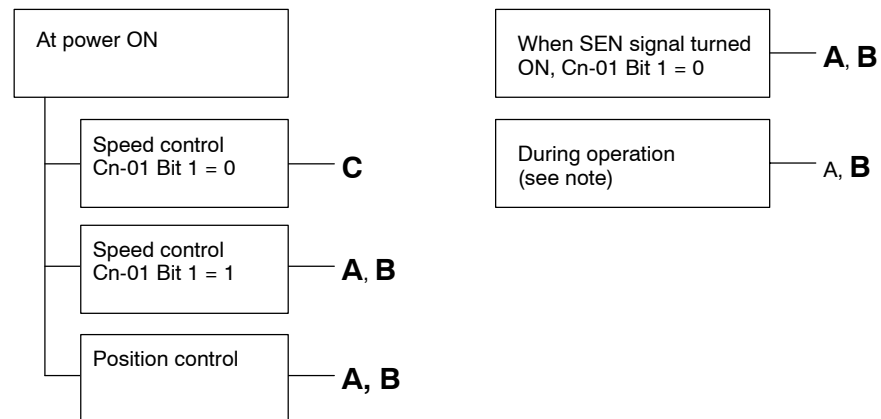

	Cause	Remedy
A	<ul style="list-style-type: none"> Battery not connected Battery connection defective 	Check and correct battery connection.
B	Battery voltage below specified value. Specified value: 2.8 V.	Install new battery and turn SEN signal (or Servopack) ON.
C	Circuit board (1PWB) defective	Replace Servopack.

Note No alarm occurs at the Servopack when a battery error (**A.83**) is generated. The battery error (**A.83**) occurs the next time the SEN signal (or Servopack) turns ON. However, the battery error (**A.83**) can be read during operation if the host controller is receiving the S-phase signal (serial data).

Display and Outputs

Digital Operator Display and Alarm Name	Alarm Output			
	Alarm Code Output			Alarm Output
	ALO1	ALO2	ALO3	
A.84 Absolute encoder data error (only if absolute encoder is used)	OFF	OFF	OFF	OFF

OFF: Output transistor is OFF
ON: Output transistor is ON

Status When Alarm Occurred

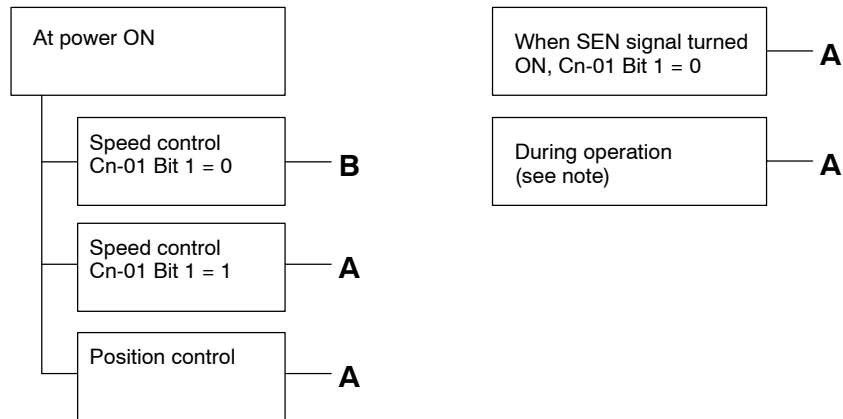

	Cause	Remedy
A	Absolute encoder malfunctioned	<ul style="list-style-type: none"> For speed control (Cn-01 Bit 1 = 0), turn SEN signal OFF and back ON. For speed control (Cn-01 Bit 1 = 1) or position control, turn Servopack power OFF and back ON. Replace servomotor if error occurs frequently.
B	Circuit board (1PWB) defective	Replace Servopack.

Note No alarm occurs at the Servopack when a data error (A.84) is generated. The data error (A.84) occurs the next time the SEN signal (or Servopack) turns ON. However, the data error (A.84) can be read during operation if the host controller is receiving the S-phase signal (serial data).

Display and Outputs

Digital Operator Display and Alarm Name	Alarm Output			
	Alarm Code Output			Alarm Output
	ALO1	ALO2	ALO3	
A.85 Absolute encoder overspeed (only if absolute encoder is used)	OFF	OFF	OFF	OFF

OFF: Output transistor is OFF

ON: Output transistor is ON

Status When Alarm Occurred

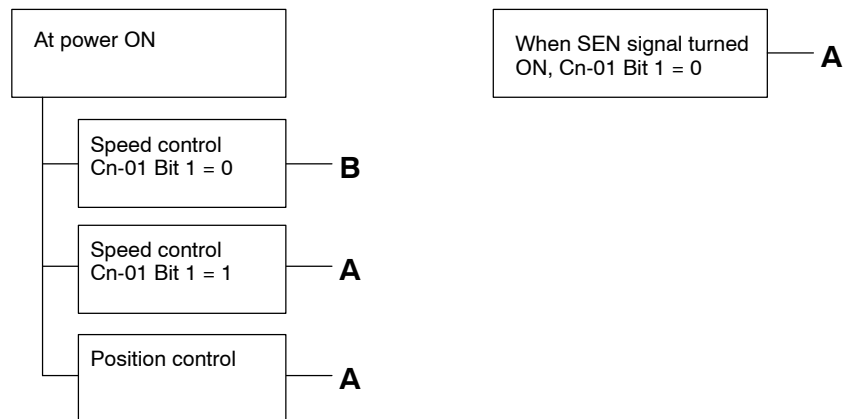

	Cause	Remedy
A	Absolute encoder turned ON at a speed exceeding 400 r/min.	Turn ON encoder power supply (or SEN signal or Servopack power supply) at a speed not exceeding 400 r/min.
B	Circuit board (1PWB) defective	Replace Servopack.

6.2.1 Troubleshooting Problems with Alarm Display cont.

Display and Outputs

Digital Operator Display and Alarm Name	Alarm Output			
	Alarm Code Output			Alarm Output
	ALO1	ALO2	ALO3	
A.b1 Reference input read error (for speed/torque control only)	OFF	OFF	OFF	OFF

OFF: Output transistor is OFF
ON: Output transistor is ON

Status When Alarm Occurred



	Cause	Remedy
A	Part malfunctioned in reference read-in unit (A/D converter, etc.).	Reset alarm and restart operation.
B	Part defective in reference read-in unit (A/D converter, etc.).	Replace Servopack.
C	Circuit board (1PWB) defective	Replace Servopack.

Display and Outputs

Digital Operator Display and Alarm Name	Alarm Output			
	Alarm Code Output			Alarm Output
	ALO1	ALO2	ALO3	
A.C1 Servo overrun	ON	OFF	ON	OFF

OFF: Output transistor is OFF
ON: Output transistor is ON

Status When Alarm Occurred

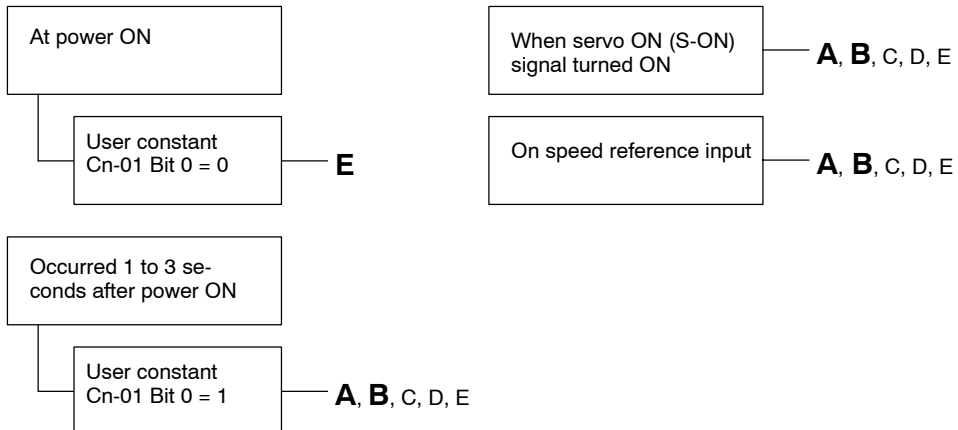

6

	Cause	Remedy
A	Servomotor wiring incorrect or disconnected	Check wiring and connectors at servomotor.
B	Encoder wiring incorrect or disconnected	Check wiring and connectors at encoder.
C	Incremental encoder power not supplied from Servopack.	Use the Servopack power supply for the encoder.
D	Encoder defective	Replace servomotor.
E	Circuit board (1PWB) defective	Replace Servopack.

Display and Outputs

Digital Operator Display and Alarm Name	Alarm Output			
	Alarm Code Output			Alarm Output
	ALO1	ALO2	ALO3	
A.C2 Encoder phase detection error	ON	OFF	ON	OFF

OFF: Output transistor is OFF

ON: Output transistor is ON

Status When Alarm Occurred

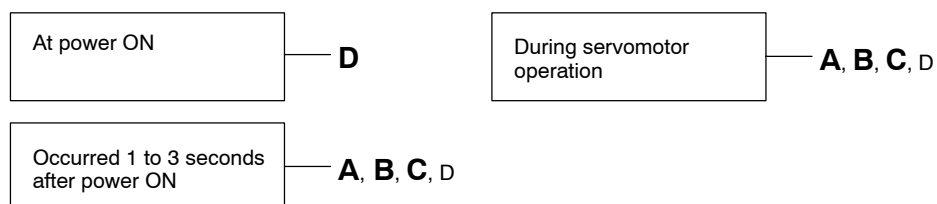

	Cause	Remedy
A	Noise in encoder wiring.	Separate encoder wiring from main wiring circuits.
B	Encoder wiring incorrect or poor connection	Check wiring and connectors at encoder.
C	Encoder defective	Replace servomotor.
D	Circuit board (1PWB) defective	Replace Servopack.

Display and Outputs

Digital Operator Display and Alarm Name	Alarm Output			
	Alarm Code Output			Alarm Output
	ALO1	ALO2	ALO3	
A.C3 Encoder A-, B-phase discontinuity	ON	OFF	ON	OFF

OFF: Output transistor is OFF
ON: Output transistor is ON

Status When Alarm Occurred

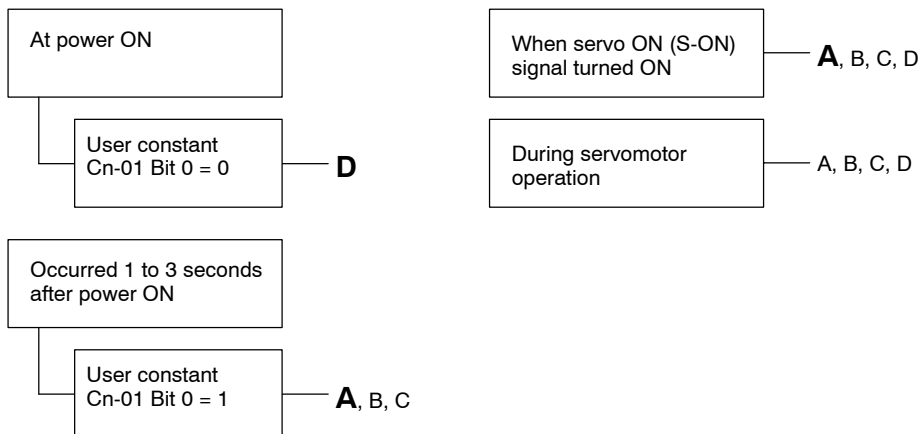

	Cause	Remedy
A	Encoder wiring incorrect or poor connection	Check wiring and connectors at encoder.
B	Noise in encoder wiring.	Separate encoder wiring from main wiring circuits.
C	Encoder defective	Replace servomotor.
D	Circuit board (1PWB) defective	Replace Servopack.

6

Display and Outputs

Digital Operator Display and Alarm Name	Alarm Output			
	Alarm Code Output			Alarm Output
	ALO1	ALO2	ALO3	
A.C4 Encoder C-phase discontinuity	ON	OFF	ON	OFF

OFF: Output transistor is OFF

ON: Output transistor is ON

Status When Alarm Occurred

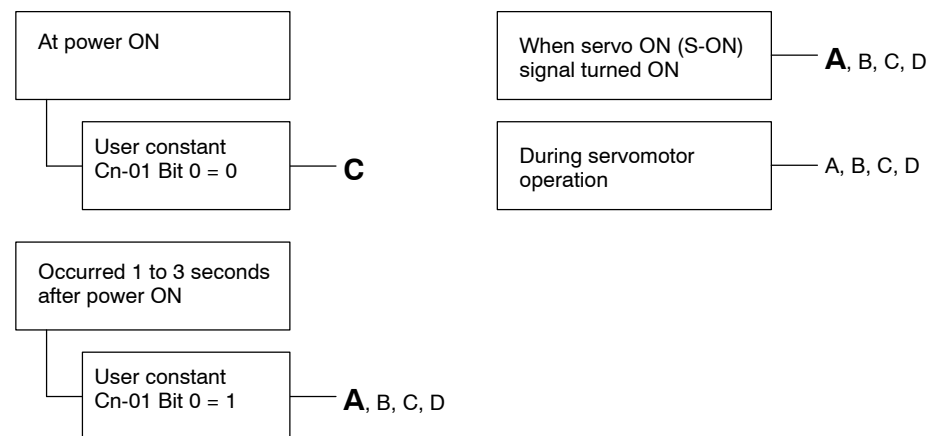

	Cause	Remedy
A	Encoder wiring incorrect or poor connection	Check wiring and connectors at encoder.
B	Noise in encoder wiring.	Separate encoder wiring from main wiring circuits.
C	Encoder defective	Replace servomotor.
D	Circuit board (1PWB) defective	Replace Servopack.

6.2.1 Troubleshooting Problems with Alarm Display cont.

Display and Outputs

Digital Operator Display and Alarm Name	Alarm Output			
	Alarm Code Output			Alarm Output
	ALO1	ALO2	ALO3	
A.F3 Power loss error	OFF	ON	OFF	OFF

OFF: Output transistor is OFF
ON: Output transistor is ON

Status When Alarm Occurred



	Cause	Remedy
A	Time between turning power OFF and back ON was shorter than the power holding time.	After turning power OFF, wait more than the power holding time (6 to 15 s, according to type) before turning the power back ON.
B	If any of the following power supply conditions are met during motor operation: <ul style="list-style-type: none"> • Complete power failure : half cycle of supply frequency • Voltage drop: full cycle of supply frequency Note Because of detector lag and detector margin, power loss of 30 to 55 ms does not cause an alarm.	Check the power supply. Terms <ul style="list-style-type: none"> • Complete power failure=Power failure where voltage drops to zero. • Voltage drop=Power failure where voltage drops, but not to zero.

Display and Outputs

Digital Operator Display and Alarm Name	Alarm Output			
	Alarm Code Output			Alarm Output
	ALO1	ALO2	ALO3	
CPF00 Digital operator transmission error 1	Not specified			

Note This alarm is not stored in alarm trace-back function memory.

Status When Alarm Occurred

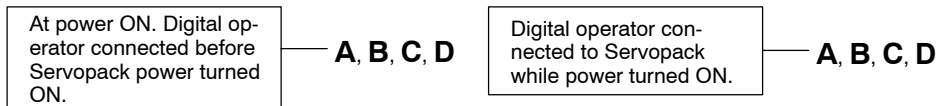

	Cause	Remedy
A	Cable defective or poor contact between digital operator and Servopack.	<ul style="list-style-type: none"> • Check connector connections. • Replace cable.
B	Malfunction due to external noise	Separate digital operator and cable from noise source.
C	Digital operator defective	Replace digital operator.
D	Servopack defective	Replace Servopack.

6

Display and Outputs

Digital Operator Display and Alarm Name	Alarm Output			
	Alarm Code Output			Alarm Output
	ALO1	ALO2	ALO3	
CPF01 Digital operator transmission error 2	Not specified			

Note This alarm is not stored in alarm trace-back function memory.

Status When Alarm Occurred

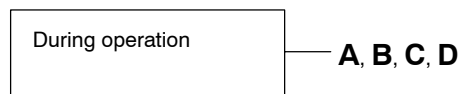

	Cause	Remedy
A	Cable defective or poor contact between digital operator and Servopack.	<ul style="list-style-type: none"> • Check connector connections. • Replace cable.
B	Malfunction due to external noise	Separate digital operator and cable from noise source.
C	Digital operator defective	Replace digital operator.
D	Servopack defective	Replace Servopack.

Display and Outputs

Digital Operator Display and Alarm Name	Alarm Output			
	Alarm Code Output			Alarm Output
	ALO1	ALO2	ALO3	
A.99	OFF	OFF	OFF	ON

OFF: Output transistor is OFF
ON: Output transistor is ON

Status When Alarm Occurred

Indicates normal operation. Not an alarm.

6.2.2 Troubleshooting Problems With No Alarm Display

Refer to the tables below to identify the cause of a problem which causes no alarm display and take the remedy described.

Turn OFF the servo system power supply before commencing the shaded procedures.

Contact your Yaskawa representative if the problem cannot be solved by the described procedures.

Troubleshooting Table No Alarm Display

Symptom	Cause	Inspection	Remedy
Servomotor does not start	Power not connected	Check voltage across R and T.	Correct the power circuit.
	Loose connection	Check terminals of connectors (1CN, 2CN).	Tighten any loose parts.
	Connector (1CN) external wiring incorrect	Check connector (1CN) external wiring	Refer to connection diagram and correct wiring.
	Servomotor or encoder wiring disconnected.		Reconnect wiring
	Overloaded	Run under no load.	Reduce load or replace with larger capacity servomotor.
	Speed/position references not input	Check input pins # 1 to 4 of connector 1CN.	Correctly input speed/position references.
	S-ON is turned OFF	Cn-01 Bit 0 is 0.	Turn S-ON input ON.
	P-CON input function setting incorrect	Check user constants Cn-01 Bits A, B.	Refer to Subsection 3.2.1 and set user constants to match application.
	Reference pulse mode selection incorrect.	Refer to Subsection 3.2.2.	Select correct user constants Cn-02 Bits 3, 4, 5.
	Encoder type differs from user constant setting.	Incremental or absolute encoder?	Set user constants Cn-01 Bit E to the encoder type used.
	P-OT and N-OT inputs are turned OFF.	(If Cn-01 Bits 2, 3 are 0)	Turn P-OT and N-OT input signals ON.
	CLR input is turned ON	Check status of error counter clear input.	Turn CLR input OFF.
SEN input is turned OFF.	Absolute encoder used with Cn-01 Bit 1 set to 0.	Turn SEN input ON.	
Servomotor moves instantaneously, then stops	Number of encoder pulses differs from user constant setting.	2048 pulses/revolution or 1024 pulses/revolution	Set the user constant (Cn-11) to match the number of encoder pulses.
	Servomotor or encoder wiring incorrect.		Refer to Subsection 3.8.8 and correct wiring.
Suddenly stops during operation and will not restart	Alarm reset signal (ALM-RST) is turned ON because an alarm occurred.		Remove cause of alarm. Turn alarm reset signal (ALM-RST) from ON to OFF.
Servomotor speed unstable	Wiring connection to motor defective	Check connection of power lead (U, V, and W phase) and encoder connectors.	Tighten any loose terminals or connectors.

6

Symptom	Cause	Inspection	Remedy
Servomotor vibrates at approximately 200 to 400 Hz.	Speed loop gain value too high.		Reduce speed loop gain (Cn-04) preset value.
	Speed/position reference input lead too long.		Minimize length of speed/position reference input lead, with impedance not exceeding several hundred ohms
	Speed/position reference input lead is bundled with power cables.		Separate reference input lead at least 30 cm from power cables.
High rotation speed overshoot on starting and stopping.	Speed loop gain value too high.		Reduce speed loop gain (Cn-04) preset value.
Servomotor overheated	Ambient temperature too high	Measure servomotor ambient temperature.	Reduce ambient temperature to 40°C max.
	Servomotor surface dirty	Visual check	Clean dust and oil from motor surface.
	Overloaded	Run under no load.	Reduce load or replace with larger capacity servomotor.
Abnormal noise	Mechanical mounting incorrect	Servomotor mounting screws loose?	Tighten mounting screws.
		Coupling not centered?	Center coupling.
		Coupling unbalanced?	Balance coupling.
	Bearing defective	Check noise and vibration near bearing.	Consult your Yaskawa representative if defective.
	Machine causing vibrations	Foreign object intrusion, damage or deformation of sliding parts of machine.	Consult with machine manufacturer.
Speed reference 0 V but servomotor rotates.	Speed reference voltage offset applied	---	Refer to Subsections 4.2.4 and 4.2.5 and adjust reference offset.

6.2.3 Internal Connection Diagram and Instrument Connection Examples

The SGDA Servopack internal connection diagram and instrument connection examples are given below.
Refer to these diagrams during inspection and maintenance.

1) Internal Connection Diagram (for speed/torque control and position control)

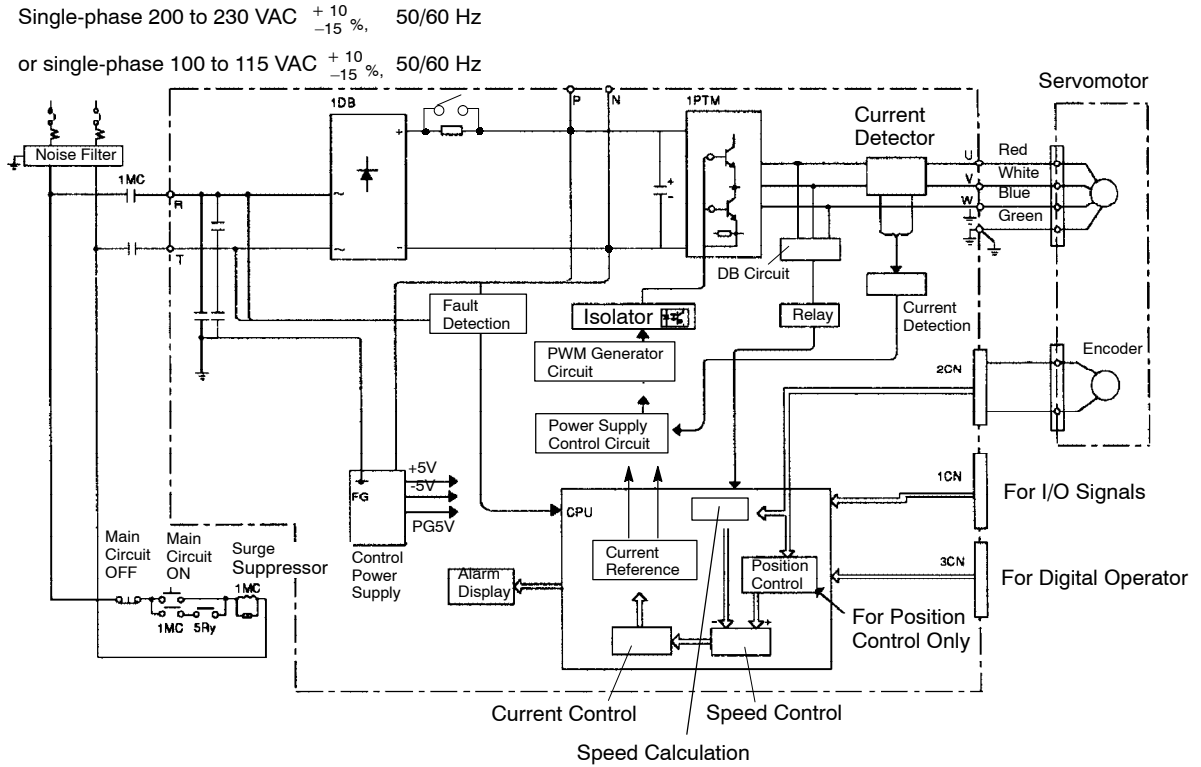

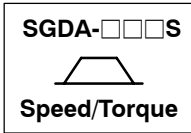

2) Instrument Connection Examples – Speed/Torque Control

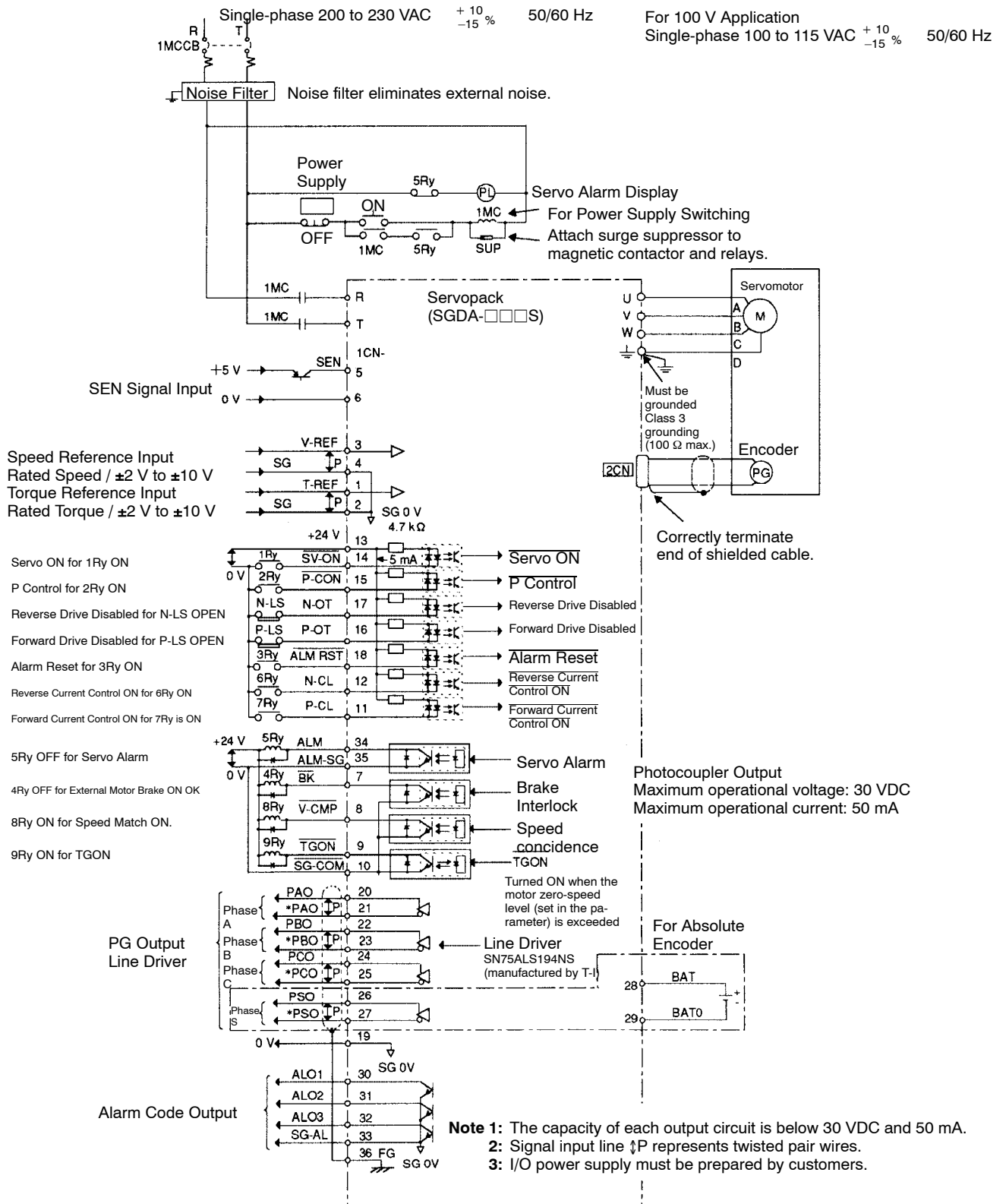

6.2.3 Internal Connection Diagram and Instrument Connection Examples cont.

3) Instrument Connection Examples – Position Control

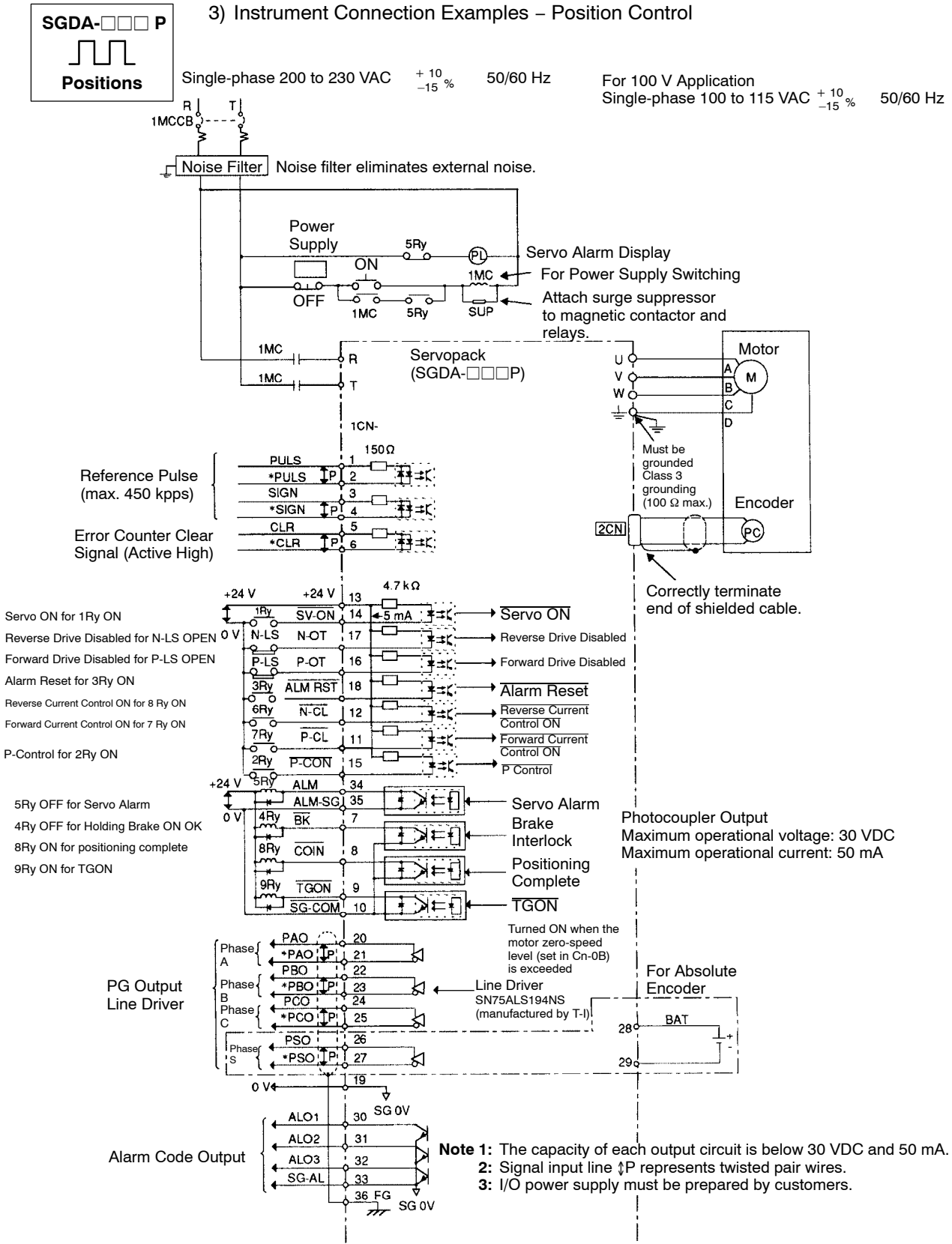

6

Appendix **A**

Differences Between SGDA and SGD Servopacks

A

The SGDA Servopack external dimensions, connectors, connector cables, and peripheral devices are all identical to the SGD Servopack.

Therefore, the customer can replace an existing SGD Servopack to obtain the enhanced performance and functions of the SGDA Servopack, as described on the following pages, without changing wiring or installed dimensions.

DIFFERENCES BETWEEN SGDA AND SGD SERVOPACKS

Comparison of the SGDA Servopack with the SGD Servopack shows the following improvements in performance and functions.

Item	SGDA Servopack		SGD Servopack
Speed Loop Frequency Characteristics	250 Hz		150 Hz
Servo Gain Compensation (See note 1)	Yes		No
Auto Tuning	7-stage settings		3-stage settings
Serial Communications Features	User constant setting/editing Reference to all monitored values Auto-tuning Alarm trace-back confirmation		User constant setting/editing
Multi-axis Communications	Yes (However, 1:1 communications when axis address is set.)		No
100 V, 300 W Version	Yes (External dimensions identical to 200 V, 750 W version)		No
Applicable Servomotors	Both SGM and SGMP servomotors Either servomotor type can be used by changing user constant (memory switch) setting. No Servopack change required.		SGM servomotors. Servopack must be changed to use SGMP servomotor. SGMP-compatible Servopack Types
Torque Feed Forward (See note 2)	Yes	Torque feed forward and torque restriction with analog references cannot be used simultaneously.	No
Torque Restriction with Analog References (See note 2)	Yes	Settings identical for forward and reverse.	No
Reference Pulse Input Unit Filter Selection (See note 3)	Yes	Select according to output form of the customer's controller (line driver or open collector).	None
External Reference Receive During Contact Input Speed Control	Possible		Not possible
Reference Pulse Inhibit	Yes	Switch the P-CON signal with the user constant settings.	No
Reference Pulse Value Display (See note 3)	Possible (Monitor mode Un-09)		Not possible

- Note**
- 1) Material is being prepared on speed loop servo gain compensation.
 - 2) Speed control type only.
 - 3) Position control type only.

Appendix B

Servo Adjustment

B

This appendix presents the basic rules for Σ -Series AC Servopack gain adjustment, describes various adjustment techniques, and gives some preset values as guidelines.

B.1	Σ-Series AC Servopack Gain Adjustment	374
B.1.1	Σ -Series AC Servopacks and Gain Adjustment Methods	374
B.1.2	Basic Rules for Gain Adjustment	375
B.2	Adjusting a Speed-control Servopack	376
B.2.1	Adjusting Using Auto-tuning	376
B.2.2	Manual Adjustment	377
B.3	Adjusting a Position-control Servopack	380
B.3.1	Adjusting Using Auto-tuning	380
B.3.2	Manual Adjustment	381
B.4	Gain Setting References	385
B.4.1	Guidelines for Gain Settings According to Load Inertia Ratio	385

B.1 Σ -Series AC Servopack Gain Adjustment

This section gives some basic information required to adjust the servo system.

B.1.1	Σ -Series AC Servopacks and Gain Adjustment Methods	374
B.1.2	Basic Rules for Gain Adjustment	375

B.1.1 Σ -Series AC Servopacks and Gain Adjustment Methods

1) Five types of Σ -Series AC Servopack are available: SGD, SGDB, DR1, DR2, and the current SGDA.

The adjustment method is basically identical for each Servopack type, except that auto-tuning is not available for some types.

The SGDA, SGD, SGDB and DR2 Servopacks allow both manual adjustment by the conventional method of observing the machine response and automatic adjustment using the internal auto-tuning function. The DR1 Servopack does not offer auto-tuning.

2) The main user constants changed by the customer to adjust the servo system include the following:

- Cn-04 (Speed Loop Gain)
- Cn-05 (Speed Loop Integration Time Constant)
- Cn-17 (Torque Reference Filter Time Constant)
- Cn-1A (Position Loop Gain)

In a speed-control Servopack (where speed references are applied as analog voltages), the position loop is controlled by the host controller, so the position loop gain is normally adjusted at the host controller.

If adjustment is not possible at the host controller, the same adjustment can be achieved using Cn-03 (Speed Reference Gain), but the servomotor may not reach maximum speed for some preset values of this user constant.

A simple block diagram of the servo system is shown below.

Servo System Block Diagram

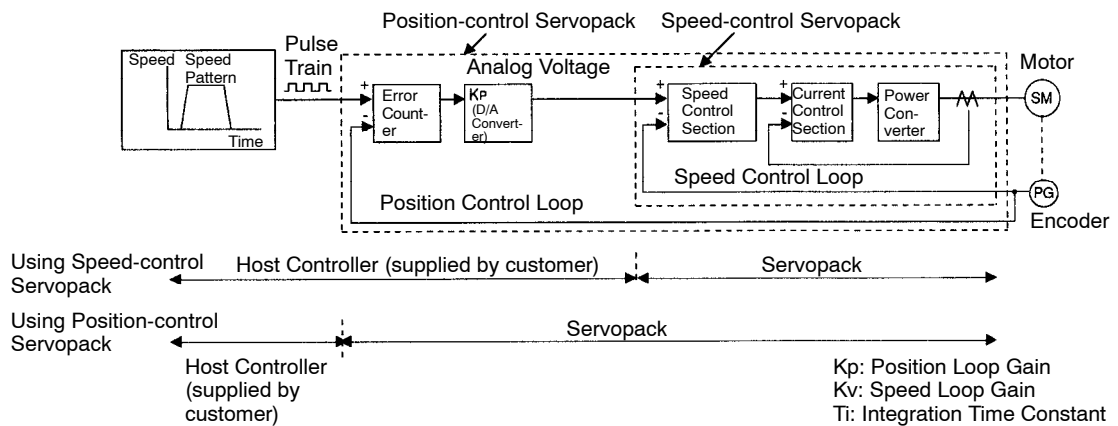

Note: A position-control Servopack has no D/A converter for speed reference output. This conversion is handled by internal calculations.

B.1.2 Basic Rules for Gain Adjustment

- 1) The servo system comprises three feedback systems: position loop, speed loop, and current loop. The response must increase from outer loop to inner loop (see Servo System Block Diagram, above). The response deteriorates and oscillates if this principle is not obeyed.
The customer cannot adjust the current loop. Sufficient response is assured for the current loop.
The customer can adjust the position loop gain and speed loop gain, as well as the speed loop integration time constant and torque reference filter.
- 2) The position loop and speed loop must be adjusted to provide a balanced response. In particular, if the position loop gain only is increased (adjustment with Cn-03 at the Servopack if position loop gain adjustment is not possible at the host controller), the speed references oscillate and the result is increased, oscillating position control times.
If the position loop gain (or Cn-03) is increased, the speed loop gain (Cn-04) must be similarly increased.
If the mechanical system starts to oscillate after the position loop gain and speed loop gain are increased, do not increase the gains further.
- 3) The position loop gain should not normally be increased above the characteristic frequency of the mechanical system.
For example, the harmonic gears used in an articulated robot form a structure with extremely poor rigidity and a characteristic frequency of approximately 10 to 20 Hz. This type of machine allows a position loop gain of only 10 to 20 (1/sec).
Conversely, the characteristic frequency of a precision machine tool such as a chip moulder or IC bonder exceeds 70 Hz, allowing a position loop gain exceeding 70 (1/sec) for some machines.
Therefore, although the response of the servo system (controller, servo driver, motor, detectors, etc.) is an important factor where good response is required, it is also important to improve the rigidity of the mechanical system.
- 4) In cases where the position loop response is greater than or equal to the speed loop response and linear acceleration or deceleration is attempted, the poor speed loop response and follow-up cause an accumulation of position loop errors and result in increased output of speed references from the position loop.
The motor moves faster and overshoots as a result of increased speed references, and the position loop tends to decrease the speed references. However, the poor motor follow-up due to the poor speed loop response results in oscillating speed references, as shown in the diagram below.
If this problem occurs, reduce the position loop gain or increase the speed loop gain to eliminate the speed reference oscillations.

Speed Reference Output with Unbalanced Position Loop Gain and Speed Loop Gain

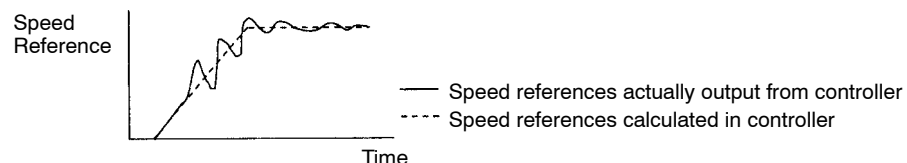

B.2 Adjusting a Speed-control Servopack

This section gives examples of adjusting the gains of a speed-control Servopack manually and using auto-tuning.

B.2.1	Adjusting Using Auto-tuning	376
B.2.2	Manual Adjustment	377

B.2.1 Adjusting Using Auto-tuning

The DR1 Servopack does not offer auto-tuning.

1) Important Points About Auto-tuning

a) Speed During Auto-tuning

Auto-tuning may not function correctly if the speed is too low. Set the speed to approximately 500 r/min.

Set the speed with the user constant Cn-10 (Jog speed).

b) Selecting Machine Rigidity

If the machine rigidity is unknown, select the rigidity according to the following standards.

Drive Method	Machine Rigidity	
	SGDA, SGDB, DR2	SGD
Ball screw, direct	3 (C-003) to 7 (C-007)	High/medium response
Ball screw, with reduction gears	2 (C-002) to 3 (C-003)	Medium response
Timing belt	1 (C-001) to 3 (C-003)	Low/medium response
Chain	1 (C-001) to 2 (C-002)	Low response
Wave reduction gears*	1 (C-001) to 2 (C-002)	Low response

* Product name: Harmonic Drive

Select the machine rigidity level for SGDA, SGDB and DR2 according to the table.

Level	Rigidity
7 (C-007)	High
6 (C-006)	:
5 (C-005)	:
4 (C-004)	:
3 (C-003)	Medium
2 (C-002)	:
1 (C-001)	Low

Auto-tuning may not end if high response is selected for a low-rigidity machine or low response is selected for a high-rigidity machine.
If this occurs, halt the auto-tuning and change the machine rigidity selection.

2) If Auto-tuning is Unsuccessful

Auto-tuning may be unsuccessful (the end of auto-tuning not displayed) for machines with large play or extremely low rigidity.

Similarly, auto-tuning may be unsuccessful for a machine with high load inertia (exceeding 15 to 30 times the motor moment of inertia).

In these cases, use conventional manual adjustment.

Even if auto-tuning is successful for a machine with large fluctuations in load inertia or load torque, vibrations or noise may still occur in some positions.

3) Response During Operation is Unsatisfactory after Auto-tuning

Auto-tuning sets the gain and integration time constant with some safety margin (to avoid oscillations). This can result in positioning times.

In particular, the target position may not be reached if low response is selected, because the machine does not move in response to the final minute references. An excessively high setting of the integration time constant (Cn-05) during auto-tuning is one cause of this problem.

If response is slow after auto-tuning, the speed loop gain cannot be manually increased very much before oscillation starts.

In this case, manually reduce the integration time constant while observing the machine behavior to ensure oscillation does not occur.

Auto-tuning does not set the torque reference filter (Cn-17) or speed reference gain (Cn-03).

B.2.2 Manual Adjustment

1) The role of each user constant is briefly described below.

a) Speed Loop Gain (Cn-04)

This user constant sets the speed loop response.

The response is improved by setting this user constant to the maximum value in the range which does not cause vibrations in the mechanical system.

The following formula relates the speed loop gain to the load inertia.

$$\text{Speed Loop Gain } K_v \text{ [Hz]} = \frac{2}{\frac{GD_L^2}{GD_M^2} + 1} \times (\text{Cn-04 Preset value})$$

GD_L^2 : Motor Axis Converted Load Inertia

GD_M^2 : Motor Moment of Inertia

b) Speed Loop Integration Time Constant (Cn-05)

The speed loop has an integration element to allow response to micro-inputs.

This integration element can produce a delay in the servo system, and the positioning setting time increases and response becomes slower as the time constant increases. However, the integration time constant must be increased to prevent machine vibration if the load inertia is large or the mechanical system includes a element that is prone to vibration.

The following formula calculates a guideline value.

$$T_i \geq 2.3 \times \frac{1}{2\pi \times K_v}$$

Ti: Integration Time Constant (sec)

Kv: Speed Loop Gain (Hz) (calculated above)

c) Torque Reference Filter Time Constant (Cn-17)

When a ball screw is used, torsional resonance may occur which increases the pitch of the vibration noise.

This vibration can sometimes be overcome by increasing the torque reference filter time constant.

However, this filter will produce a delay in the servo system, just like the integration time constant, and its value should not be increased more than necessary.

d) Speed Reference Gain (Cn-03)

Changing the speed reference gain (Cn-03) changes the position loop gain an equivalent amount. That is, reducing the speed reference gain is equivalent to reducing the position loop gain and increasing it is equivalent to increasing the position loop gain. Use this user constant (Cn-03) in the following circumstances:

- No position loop gain adjustment at host controller (including cases where fine adjustment not possible by changing number of D/A converter bits)
- Clamping the speed reference output range to specific speeds

Normally leave at the factory setting.

NOTE For a speed-control SGD or SGDA Servopack or for speed control SGDB or DR2 Servopack, the position loop gain (Cn-1A) is valid in zero-clamp mode only. The position loop gain (Cn-1A) user constant is always invalid for a DR1 Servopack. For normal control, change the position loop gain at the host controller or adjust the speed reference gain (Cn-03) in the Servopack. Changing Cn-1A does not change the position loop gain.

2) Adjustment Procedure

- a) Set the position loop gain at the host controller to a low value and increase the speed loop gain (Cn-04) within the range that no abnormal noise or vibration occurs. If adjustment of the position loop gain is not possible at the host controller, reduce the speed reference gain (Cn-03).
- b) Slightly reduce the speed loop gain from the value at step 1, and increase the position loop gain at the host controller in the range that no overshooting or vibration occurs.

If adjustment of the position loop gain is not possible at the host controller, increase the speed reference gain (Cn-03).

- c) Determine the speed loop integration time constant (Cn-05), by observing the positioning setting time and vibrations in the mechanical system.
The positioning setting time may become excessive if the speed loop integration time constant (Cn-05) is too large.
- d) It is not necessary to change the torque reference filter time constant (Cn-17) unless torsional resonance occurs in the machine shafts.
Torsional resonance may be indicated by a high vibration noise. Adjust the torque reference filter time constant (Cn-17) to reduce the vibration noise.
- e) Finally, fine adjustment of the position gain, speed gain, and integration time constant is required to determine the optimum point for step response.

B.3 Adjusting a Position-control Servopack

This section gives examples of adjusting the gains of a position-control Servopack manually and using auto-tuning.

B.3.1	Adjusting Using Auto-tuning	380
B.3.2	Manual Adjustment	381

B.3.1 Adjusting Using Auto-tuning

The DR1 Servopack does not offer auto-tuning.

1) Important Points About Auto-tuning

a) Speed During Auto-tuning

Auto-tuning may not function correctly if the speed is too low. Set the speed to approximately 500 r/min.

Set the speed with the user constant Cn-10 (Jog speed).

b) Selecting Machine Rigidity

If the machine rigidity is unknown, select the rigidity according to the following standards.

Drive Method	Machine Rigidity	
	SGDA, SGDB, DR2	SGD
Ball screw, direct	3 (C-003) to 7 (C-007)	High/medium response
Ball screw, with reduction gears	2 (C-002) to 3 (C-003)	Medium response
Timing belt	1 (C-001) to 3 (C-003)	Low/medium response
Chain	1 (C-001) to 2 (C-002)	Low response
Wave reduction gears*	1 (C-001) to 2 (C-002)	Low response

* Product name: Harmonic Drive

Select the machine rigidity level for SGDA, SGDB and DR2 according to the table.

Level	Rigidity
7 (C-007)	High
6 (C-006)	:
5 (C-005)	:
4 (C-004)	:
3 (C-003)	Medium
2 (C-002)	:
1 (C-001)	Low

Auto-tuning may not end if high response is selected for a low-rigidity machine or low response is selected for a high-rigidity machine.
If this occurs, halt the auto-tuning and change the machine rigidity selection.

2) If Auto-tuning is Unsuccessful

Auto-tuning may be unsuccessful (the end of auto-tuning not displayed) for machines with large play or extremely low rigidity.
Similarly, auto-tuning may be unsuccessful for a machine with high load inertia (exceeding 15 to 30 times the motor moment of inertia).
In these cases, use conventional manual adjustment.
Even if auto-tuning is successful for a machine with large fluctuations in load inertia or load torque, vibrations or noise may still occur in some positions.

3) Response During Operation is Unsatisfactory after Auto-tuning

Auto-tuning sets the gain and integration time constant with some safety margin (to avoid oscillations). This can result in positioning times.
In particular, the target position may not be reached if low response is selected, because the machine does not move in response to the final minute references. An excessively high setting of the integration time constant (Cn-05) during auto-tuning is one cause of this problem.
If response is slow after auto-tuning, the speed loop gain cannot be manually increased very much before vibration starts.
In this case, manually reduce the integration time constant while observing the machine behavior to ensure oscillation does not occur.
Auto-tuning does not set the torque reference filter (Cn-17).

B.3.2 Manual Adjustment

1) The role of each user constant is briefly described below.

a) Speed Loop Gain (Cn-04)

This user constant sets the speed loop response.
The response is improved by setting this user constant to the maximum value in the range which does not cause vibrations in the mechanical system.
The following formula relates the speed loop gain to the load inertia.

$$\text{Speed Loop Gain } K_v \text{ [Hz]} = \frac{2}{\frac{GD_L^2}{GD_M^2} + 1} \times (\text{Cn-04 Preset value})$$

GD_L^2 : Motor Axis Converted Load Inertia

GD_M^2 : Motor Moment of Inertia

b) Speed Loop Integration Time Constant (Cn-05)

The speed loop has an integration element to allow response to micro-inputs.

This integration element can produce a delay in the servo system, and the positioning setting time increases and response becomes slower as the time constant increases. However, the integration time constant must be increased to prevent machine vibration if the load inertia is large or the mechanical system includes a vibration elements. The following formula calculates a guideline value.

$$T_i \geq 2.3 \times \frac{1}{2\pi \times K_v}$$

Ti: Integration Time Constant (sec)

Kv: Speed Loop Gain (Hz) (calculated above)

c) Torque Reference Filter Time Constant (Cn-17)

When a ball screw is used, torsional resonance may occur which increases the pitch of the vibration noise.

These vibrations can sometimes be overcome by increasing the torque reference filter time constant.

However, this filter can produce a delay in the servo system, as is the integration time constant, and its value should not be increased more than necessary.

d) Position Loop Gain

The position loop gain user constant sets the servo system response.

The higher the position loop gain is set, the better the response and shorter the positioning times.

To enable a high setting of the position loop gain, increase the machine rigidity and raise the machine characteristic frequency.

Increasing the position loop gain only to improve the response can result in oscillating response of the overall servo system, that is, the speed references output from the position loop oscillate. Therefore, also increase the speed loop gain while observing the response.

2) Adjustment Procedure

- a) Set the position loop gain to a low value and increase the speed loop gain (Cn-04) within the range that no abnormal noise or oscillation occurs.
- b) Slightly reduce the speed loop gain from the value at step 1, and increase the position loop gain in the range that no overshooting or vibration occurs.
- c) Determine the speed loop integration time constant (Cn-05), by observing the positioning set time and vibrations in the mechanical system.
The positioning set time may become excessive if the speed loop integration time constant (Cn-05) is too large.
- d) It is not necessary to change the torque reference time constant (Cn-17) unless torsional resonance occurs in the machine shafts.
Torsional resonance may be indicated by a high vibration noise. Adjust the torque reference filter time constant to reduce the vibration noise.
- e) Finally, fine adjustment of the position gain, speed gain, and integration time constant is required to determine the optimum point for step response, etc.

3) Functions to Improve Response

The mode switch, feed-forward, and bias functions improve response.

However, they are not certain to improve response and may even worsen it in some cases. Follow the points outlined below and observe the actual response while making adjustments.

a) Mode Switch

The mode switch improves the transition characteristics when the torque references become saturated during acceleration or deceleration.

Above the set level, the speed loop control switches from PI (proportional/integral) control to P (proportional) control.

b) Feed-forward Function

Use feed-forward to improve the response speed. However, feed-forward may be ineffective in systems where a sufficiently high value of position loop gain is not possible.

Follow the procedure below to adjust the feed-forward amount (Cn-1D).

(7) Adjust the speed loop and position loop, as described above.

(8) Gradually increase the feed-forward amount (Cn-1D), such that the positioning complete ($\overline{\text{COIN}}$) signal is output early.

At this point, ensure that the positioning complete ($\overline{\text{COIN}}$) signal breaks up (alternately turns ON/OFF) and that the speed does not overshoot. These problems can arise if the feed-forward is set too high.

For all types of Servopack except DR1, a primary delay filter can be applied to feed-forward. This filter can be used to correct breakup (alternatingly turning ON/OFF) of the positioning complete ($\overline{\text{COIN}}$) signal or speed overshoot arising when feed-forward is activated.

c) Bias Function

When the lag pulses in the error counter exceeds the positioning complete width (Cn-1B), the bias amount (Cn-1C) is added to the error counter output (speed reference). If the lag pulses in the error counter lies within the positioning complete width (Cn-1B), the bias amount (Cn-1C) is no longer added.

This reduces the number of pulses in the error counter and shortens the positioning time.

The motor speed becomes unstable if the bias amount is too large.

Observe the response during adjustment as the optimum value depends on the load, gain, and positioning complete width.

Set Cn-0C to zero (0) when the bias is not used.

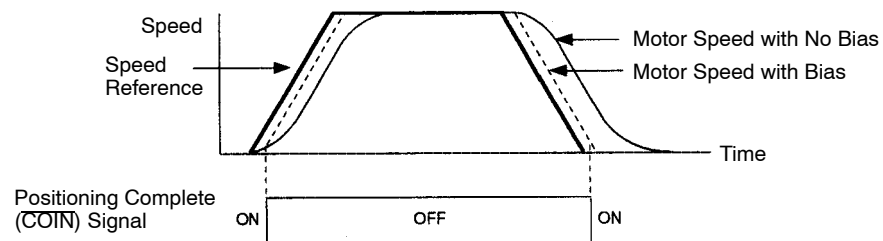
Bias Function

SERVO ADJUSTMENT

B.3.2 Manual Adjustmentcont.

The adjustment procedures described above are common for all Yaskawa digital AC Servopacks. However, not all functions are available on each Servopack. Consult the technical specifications of your Servopack for details.

The adjustment procedures are also identical for conventional analog servos. However, in this case, the adjustments are made using potentiometers instead of the user constants.

B

B.4 Gain Setting References

■ This section presents tables of load inertia values for reference when adjusting the gain.

B.4.1 Guidelines for Gain Settings According to Load Inertia Ratio 385

B.4.1 Guidelines for Gain Settings According to Load Inertia Ratio

1) Adjustment guidelines are given below according to the rigidity of the mechanical system and load inertia. Use these values as guidelines when adjusting according to the procedures described above.

These values are given as guidelines only. Oscillations and poor response may occur inside the specified value ranges. Observe the response (waveform) when optimizing the adjustment.

Higher gains are possible for machines with high rigidity.

a) Machines with High Rigidity

Ball Screw, Direct Drive Machines

Example: Chip moulder, IC bonder, precision machine tools

Load/Inertia Ratio (GD_L^2/GD_M^2)	Position Loop Gain (Cn-1A) [1/s]	Speed Loop Gain (Cn-04) [Hz]	Speed Loop Integration Time Constant (Cn-05) [ms]
1 x	50 to 70	50 to 70	5 to 20 Slightly increase for inertia ratio of 20 x, or greater.
3 x		100 to 140	
5 x		150 to 200	
10 x		270 to 380	
15 x		400 to 560	
20 x		500 to 730	
30 x		700 to 1100	

For an inertia ratio of 10 x, or greater, slightly reduce the position loop gain and speed loop gain below the values shown and set the integration time constant to a higher value before starting the adjustment.

As the inertia ratio increases, set the position loop gain and speed loop gain to the lower limit of the range of values specified. Conversely, increase the speed loop integration time constant.

b) Machines with Medium Rigidity

Machines driven by ball screw through reduction gears, or machines directly driven by long ball screws.

Example: General machine tools, orthogonal robots, conveyors



SERVO ADJUSTMENT

B.4.1 Guidelines for Gain Settings According to Load Inertia Ratio cont.

Load/Inertia Ratio (GD_L^2/GD_M^2)	Position Loop Gain (Cn-1A) [1/s]	Speed Loop Gain (Cn-04) [Hz]	Speed Loop Integration Time Constant (Cn-05) [ms]
1 x	30 to 50	30 to 50	10 to 40 Slightly increase for inertia ratio of 20 x, or greater.
3 x		60 to 100	
5 x		90 to 150	
10 x		160 to 270	
15 x		240 to 400	
20 x		310 to 520	
30 x		450 to 770	

For an inertia ratio of 10 x, or greater, slightly reduce the position loop gain and speed loop gain below the values shown and set the integration time constant to a higher value before starting the adjustment.

As the inertia ratio increases, set the position loop gain and speed loop gain to the lower limit of the range of values specified. Conversely, increase the speed loop integration time constant.

c) Machines with Low Rigidity

Machines driven by timing belts, chains or wave reduction gears (product name: Harmonic Drive).

Example: Conveyors, articulated robots

Load/Inertia Ratio (GD_L^2/GD_M^2)	Position Loop Gain (Cn-1A) [1/s]	Speed Loop Gain (Cn-04) [Hz]	Speed Loop Integration Time Constant (Cn-05) [ms]
1 x	10 to 20	10 to 20	50 to 120 Slightly increase for inertia ratio of 20 x, or greater.
3 x		20 to 40	
5 x		30 to 60	
10 x		50 to 110	
15 x		80 to 160	
20 x		100 to 210	
30 x		150 to 310	

For an inertia ratio of 10 x, or greater, slightly reduce the position loop gain and speed loop gain below the values shown and set the integration time constant to a higher value before starting the adjustment.

As the inertia ratio increases, set the position loop gain and speed loop gain to the lower limit of the range of values specified. Conversely, increase the speed loop integration time constant.

- 2) When a speed-control Servopack is used, set the position loop gain at the host controller. If the position loop gain cannot be set at the host controller, adjust the Servopack speed reference gain (Cn-03).

The position loop gain (Cn-1A) of a speed-control Servopack is valid in zero-clamp mode only.

The position loop gain is determined from the following relationship.

$$K_p = \frac{VS}{\epsilon}$$

K_p [1/s]: Position loop gain

VS [PPS]: Steady speed reference

ϵ : (pulse): Steady error

(The number of pulses in the error counter at steady speed.)

Appendix C

List of I/O Signals

This appendix lists I/O signal terminals (connector 1CN) on Servopacks which connect to a host controller or external circuit.

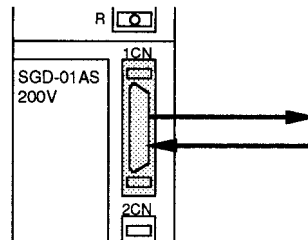

- NOTE**
- 1) The meanings of some signals for speed/torque control and position control are different. Always refer to the correct list for the Servopack type.
 - 2) Refer to *Chapter 3* for details of how to use I/O signals.
 - 3) Note that the functions of I/O signal terminals differ according to the memory switch (Cn-01, Cn-02) settings.

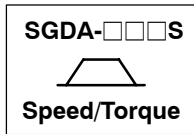

List of Input Signals for Speed/Torque Control (1)

1CN Terminal No.

Specifications	Standard Specifications	Absolute Encoder	Torque Limit Output	Zero-clamp	Contact Input Speed Control		Speed Control with Torque Restriction by Analog Voltage Reference
					Cn-02 Bit 2 = 1	Cn-02 Bit 2 = 1	
Memory Switch Setting	Standard Setting	Cn-01 Bit E = 1	Cn-01 Bit 4 = 1	Cn-01 Bit A = 1 Bit B = 0	Cn-01 Bit B = 0	Cn-01 Bit B = 1	Cn-02 Bit F = 1
1	--- (Unused)						T-REF Torque limit input 3.2.9
2	--- (Unused)						SG-T Signal ground for torque limit input 3.2.6
3	V-REF Speed reference input 3.2.1				--- (Unused)	V-REF Speed reference	V-REF Speed reference 3.2.9
4	SG-V Signal ground for speed reference input				--- (Unused)	SG-V Signal ground for speed reference 3.2.6	SG-V Signal ground for speed reference
5	--- (Unused)	SEN Sensor ON 3.8.5					
6	--- (Unused)	0SEN Signal ground for sensor ON signal					
7	BK Brake interlock output 3.4.4						
8	V-CMP Speed coincidence output 3.7.4						
9	TGON Running output 3.7.5		TGON Torque limit detection 3.1.3				
10	SG-COM Signal ground common 3.2.4						
11	P-CL Forward rotation torque limit 3.1.3					P-CL Contact input speed control 1	P-CL Contact input speed control 1 3.2.6
12	N-CL Reverse rotation torque limit 3.1.3				3.2.6	N-CL Contact input speed control 2	N-CL Contact input speed control 2 3.2.6

Specifications	Standard Specifications	Absolute Encoder	Torque Limit Output	Zero-clamp	Contact Input Speed Control	Speed Control with Torque Restriction by Analog Voltage Reference	
Memory Switch Setting	Standard Setting	Cn-01 Bit E = 1	Cn-01 Bit 4 = 1	Cn-01 Bit A = 1 Bit B = 0	Cn-02 Bit 2 = 1		Cn-02 Bit F = 1
					Cn-01 Bit B = 0	Cn-01 Bit B = 1	
13	+24VIN I/O power supply	3.2.4					
14	S-ON Servo ON	3.7.2					
15	P-CON Proportional control	3.2.1		P-CON Zero-clamp operation reference	P-CON Rotation direction reference	P-CON Rotation direction reference	
16	P-OT Forward rotation prohibited	3.1.2		3.4.3	3.2.6	3.2.6	
17	N-OT Reverse rotation prohibited	3.1.2					
18	ALMRST Alarm reset	3.7.1					
19	SG-PG Signal ground for PG signal output	3.2.3					
20	PAO Phase A	3.2.3					
21	*PAO Phase \bar{A}						
22	PBO Phase B						
23	*PBO Phase \bar{B}						
24	PCO Phase C						
25	*PCO Phase \bar{C}						
26	--- (Unused)	PSO Phase S output	3.8.5				
27	--- (Unused)	*PSO Phase \bar{S} output					
28	--- (Unused)	BAT Backup battery (+) input	3.8.5				
29	--- (Unused)	BAT0 Backup battery 0 V input	3.8.5				

1CN Terminal No.



Note Information described in the “Standard Specifications” column is also applicable to blank columns.
 Number “x.x.x” in box represents a section number corresponding to each signal name. For example, 3.2.1 represents Section 3.2.1.

LIST OF I/O SIGNALS

1CN Terminal No.	Specifications	Standard Specifications	Absolute Encoder	Torque Limit Output	Zero-clamp	Contact Input Speed Control		Speed Control with Torque Restriction by Analog Voltage Reference
	Memory Switch Setting	Standard Setting	Cn-01 Bit E = 1	Cn-01 Bit 4 = 1	Cn-01 Bit A = 1 Bit B = 0	Cn-02 Bit 2 = 1		Cn-02 Bit F = 1
						Cn-01 Bit B = 0	Cn-01 Bit B = 1	
30	ALO1	Alarm code output						
31	ALO2	Alarm code output						
32	ALO3	Alarm code output						
33	SG-AL	Signal ground for alarm code output	3.7.1					
34	ALM	Alarm output	3.7.1					
35	ALM-SG	Signal ground for alarm output						
36	FG	Frame ground	3.2.3					

Note Information described in the “Standard Specifications” column is also applicable to blank columns.
 Number “x.x.x” in box represents a section number corresponding to each signal name. For example, 3.2.1 represents Section 3.2.1.

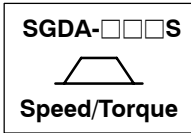

List of Input Signals for Speed/Torque Control (2)

1CN Terminal No.	Specifications	Standard Specifications	Speed Control with Torque Feed-forward	Torque Control I	Torque Control II			
	Memory Switch Setting	Standard Setting	Cn-01 Bit F = 1	Cn-01 Bit A = 0, B = 1	Cn-01 Bit A = 1, B = 1			
					P-CON = OFF	P-CON = ON		
					Cn-01 Bit F = 0, Cn-02 Bit F = 0	Cn-01 Bit F = 0, Cn-02 Bit F = 1	Cn-01 Bit F = 1, Cn-02 Bit F = 0 or 1	
1	---	(Unused)	T-REF Torque feed-forward reference 3.2.8	T-REF Torque reference 3.1.3	T-REF Torque reference 3.2.7	---	T-REF Torque limit value 3.2.7	T-REF Torque feed-forward reference
2	---	(Unused)	SG-T Signal ground for torque feed-forward reference 3.2.8	SG-T Signal ground for torque reference 3.1.3	SG-T Signal ground for torque reference 3.2.7	---	SG-T Signal ground for torque limit value 3.2.7	SG-T Signal ground for torque feed-forward reference
3	V-REF Speed reference input 3.2.1	V-REF Speed reference 3.2.8	---	(Unused)	V-REF Speed limit value 3.2.7	V-REF Speed reference 3.2.7	V-REF Speed reference 3.2.7	V-REF Speed reference
4	SG-V Signal ground for speed reference input 3.2.1	SG-V Signal ground for speed reference 3.2.8	---	(Unused)	SG-V Signal ground for speed limit value 3.2.7	SG-V Signal ground for speed reference 3.2.7	SG-V Signal ground for speed reference 3.2.7	SG-V Signal ground for speed reference
5	---	(Unused)						
6	---	(Unused)						
7	BK Brake interlock output 3.4.4							
8	V-CMP Speed coincidence output 3.7.4							
9	TGON Running output 3.7.5							
10	SG-COM Signal ground common 3.2.4							
11	P-CL Forward rotation torque limit 3.1.3							
12	N-CL Reverse rotation torque limit 3.1.3							

Note Information described in the “Standard Specifications” column is also applicable to blank columns.
 Number “x.x.x” in box represents a section number corresponding to each signal name. For example, **3.2.1** represents Section 3.2.1.



LIST OF I/O SIGNALS

Specifications	Standard Specifications	Speed Control with Torque Feed-forward	Torque Control I	Torque Control II			
				Cn-01 Bit A = 1, B = 1			
Memory Switch Setting	Standard Setting	Cn-01 Bit F = 1	Cn-01 Bit A = 0, B = 1	P-CON = OFF	P-CON = ON		
Memory Switch Setting				---	Cn-01 Bit F = 0, Cn-02 Bit F = 0	Cn-01 Bit F = 0, Cn-02 Bit F = 1	Cn-01 Bit F = 1, Cn-02 Bit F = 0 or 1
13	+24VIN I/O power supply	3.2.4					
14	S-ON Servo ON	3.7.2					
15	P-CON Proportional control	3.2.1					
16	P-OT Forward rotation prohibited	3.1.2					
17	N-OT Reverse rotation prohibited	3.1.2					
18	ALMRST Alarm reset	3.7.1					
19	SG-PG Signal ground for PG signal output	3.2.3					
20	PAO Phase A	3.2.3					
21	*PAO Phase \bar{A}						
22	PBO Phase B						
23	*PBO Phase \bar{B}						
24	PCO Phase C						
25	*PCO Phase \bar{C}						
26	---						
27	---						
28	---						
29	---						

1CN Terminal No.



Specifications	Standard Specifications	Speed Control with Torque Feed-forward	Torque Control I	Torque Control II			
				Cn-01 Bit A = 1, B = 1			
Memory Switch Setting	Standard Setting	Cn-01 Bit F = 1	Cn-01 Bit A = 0, B = 1	P-CON = OFF	P-CON = ON		
				---	Cn-01 Bit F = 0, Cn-02 Bit F = 0	Cn-01 Bit F = 0, Cn-02 Bit F = 1	Cn-01 Bit F = 1, Cn-02 Bit F = 0 or 1
				30	ALO1 Alarm code output		
31	ALO2 Alarm code output						
32	ALO3 Alarm code output						
33	SG-AL Signal ground for alarm code output						
34	ALM Alarm output						
35	ALM-SG Signal ground for alarm output						
36	FG Frame ground						

1CN Terminal No.



Note Information described in the “Standard Specifications” column is also applicable to blank columns.

Number “x.x.x” in box represents a section number corresponding to each signal name. For example, **3.2.1** represents Section 3.2.1.



List of I/O Signals for Position Control

Specifications	Standard Specifications		Absolute Encoder	Torque Limit Output	Contact Input Speed Control		CCW Pulse + CW Pulse Reference	90° Different Two-phase Pulse Reference	
	Memory Switch Setting	Standard Setting			Cn-01 Bit E = 1	Cn-01 Bit 4 = 1			Cn-02 Bit 2 = 1 Cn-01 Bit F = 0
1CN Terminal No.	1	PULS	Reference pulse input	3.2.2		---	PULS Reference pulse input	PULS Forward rotation (CCW) reference pulse input	PULS Phase A reference pulse input
	2	*PULS				*PULS Reference pulse input	*PULS Forward rotation (CCW) reference pulse input	*PULS Phase A reference pulse input	
	3	SIGN	Reference sign input			---	SIGN Reference pulse input	SIGN Reverse rotation (CW) reference pulse input	SIGN Phase B reference pulse input
	4	*SIGN				*SIGN Reference pulse input	*SIGN Reverse rotation (CW) reference pulse input	*SIGN Phase B reference pulse input	
5	CLR	Error counter clear signal input	3.2.2						
6	*CLR								3.4.4
7	BK	Brake interlock output		3.7.3					
8	COIN	Positioning complete signal							

C

Specifications	Standard Specifications	Absolute Encoder	Torque Limit Output	Contact Input Speed Control		CCW Pulse + CW Pulse Reference	90° Different Two-phase Pulse Reference
Memory Switch Setting	Standard Setting	Cn-01 Bit E = 1	Cn-01 Bit 4 = 1	Cn-02 Bit 2 = 1 Cn-01 Bit F = 0	Cn-02 Bit 2 = 1 Cn-01 Bit F = 1	Cn-02 Bits 5, 4, 3 = 0, 0, 1	Cn-02 Bits 5, 4, 3 = 0, 1, 0 (x 1 multiplication) = 0, 1, 1 (x 2 multiplication) = 1, 0, 0 (x 4 multiplication)
1CN Terminal No.	9	TGON Running output 3.7.5	TGON Torque limit output 3.1.3				
	10	SG-COM Signal ground common 3.2.4					
	11	P-CL Forward rotation torque limit 3.1.3	3.2.6	P-CL Contact input speed control mode 1 3.2.6	P-CL Contact input speed control mode 1 3.2.6		
	12	N-CL Reverse rotation torque limit 3.1.3	3.2.6	N-CL Contact input speed control mode 2 3.2.6	N-CL Contact input speed control mode 2 3.2.6		
	13	+24VIN I/O power supply 3.2.4					
	14	S-ON Servo ON 3.7.2					
	15	P-CON Proportional control 3.2.1	3.2.6	P-CON Rotation direction command at contact input speed control mode 3.2.6	P-CON Rotation direction command at contact input speed control mode 3.2.6		
16	P-OT Forward rotation prohibited 3.1.2						



Note Information described in the “Standard Specifications” column is also applicable to blank columns.

Number “x.x.x” in box represents a section number corresponding to each signal name. For example, 3.2.1 represents Section 3.2.1.

LIST OF I/O SIGNALS

Specifications	Standard Specifications	Absolute Encoder	Torque Limit Output	Contact Input Speed Control		CCW Pulse + CW Pulse Reference	90° Different Two-phase Pulse Reference
Memory Switch Setting	Standard Setting	Cn-01 Bit E = 1	Cn-01 Bit 4 = 1	Cn-02 Bit 2 = 1 Cn-01 Bit F = 0	Cn-02 Bit 2 = 1 Cn-01 Bit F = 1	Cn-02 Bits 5, 4, 3 = 0, 0, 1	Cn-02 Bits 5, 4, 3 = 0, 1, 0 (x 1 multiplication) = 0, 1, 1 (x 2 multiplication) = 1, 0, 0 (x 4 multiplication)
17	N-OT Reverse rotation prohibited	3.1.2					
18	ALMRST Alarm reset	3.7.1					
19	SG-PG Signal ground for PG signal output	3.2.3					
20	PAO Phase A	3.2.3					
21	*PAO Phase \bar{A}						
22	PBO Phase B						
23	*PBO Phase \bar{B}						
24	PCO Phase C						
25	*PCO Phase \bar{C}						

1CN Terminal No.



Note Information described in the “Standard Specifications” column is also applicable to blank columns.
 Number “x.x.x” in box represents a section number corresponding to each signal name. For example, **3.2.1** represents Section 3.2.1.

Specifications	Standard Specifications		Absolute Encoder	Torque Limit Output	Contact Input Speed Control		CCW Pulse + CW Pulse Reference	90° Different Two-phase Pulse Reference
Memory Switch Setting	Standard Setting		Cn-01 Bit E = 1	Cn-01 Bit 4 = 1	Cn-02 Bit 2 = 1 Cn-01 Bit F = 0	Cn-02 Bit 2 = 1 Cn-01 Bit F = 1	Cn-02 Bits 5, 4, 3 = 0, 0, 1	Cn-02 Bits 5, 4, 3 = 0, 1, 0 (x 1 multiplication) = 0, 1, 1 (x 2 multiplication) = 1, 0, 0 (x 4 multiplication)
26	--- (Unused)		PSO Phase S output	3.8.5				
27	--- (Unused)		*PSO Phase \bar{S} output					
28	--- (Unused)		BAT Backup battery (+) input		3.8.5			
29	--- (Unused)		BAT0 Backup battery (-) input		3.8.5			
30	ALO1	Alarm code output			3.7.1			
31	ALO2							
32	ALO3							
33	SG-AL Signal ground for alarm code output							
34	ALM Alarm output			3.7.1				
35	ALM-SG Signal ground for alarm output							
36	FG Frame ground			3.2.3				

1CN Terminal No.



Note Information described in the “Standard Specifications” column is also applicable to blank columns.

Number “x.x.x” in box represents a section number corresponding to each signal name. For example, **3.2.1** represents Section 3.2.1.

Appendix D

List of User Constants

- Σ -Series Servopacks provide many functions, and have parameters called “user constants” to allow the user to select each function and perform fine adjustment. This appendix lists these user constants.
- User constants are divided into the following two types:

1) Memory switch Cn-01, Cn-02	Each bit of this switch is turned ON or OFF to select a function.
5) User constant setting Cn-03 and later	A numerical value such as a torque limit value or speed loop gain is set in this constant.

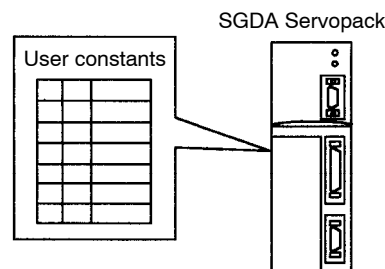

- NOTE**
- 1) Some user constants for speed/torque control and position control are different. Always refer to the correct list of user constants for the Servopack type.
 - 2) Refer to *Chapter 3* for details of how to use user constants.
 - 3) For details of how to set user constants, refer to *Section 4.1.5 Operation in User Constant Setting Mode*

LIST OF USER CONSTANTS

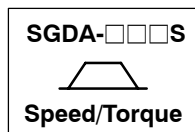

For Speed/Torque Control (SGDA-□□□S)

List of User Constants (User Constant Setting)

Category	User Constant No.	Code	Name	Unit	Lower Limit	Upper Limit	Factory Setting	Remarks
	Cn-00	Not a user constant. (Cn-00 is used to select special mode for digital operator.)						
	Cn-01	Memory switch (see on page 404.)						See note 1
	Cn-02	Memory switch (see on page 405.)						See note 1
Gain Related Constants	Cn-03	VREFGN	Speed reference gain	(r/min)/V	0	2162	500	
	Cn-04	LOOPHZ	Speed loop gain	Hz	1	2000	80	See note 2
	Cn-05	PITIME	Speed loop integration time constant	ms	2	10000	20	See note 2
	Cn-1A	POSGN	Position loop gain	1/s	1	500	40	See note 2 and 3
Torque Related Constants	Cn-13	TCRFGN	Torque reference gain	(0.1 V/rated torque)	10	100	30	
	Cn-06	EMGTRQ	Emergency stop torque	%	0	Maximum torque	Maximum torque	
	Cn-08	TLMTF	Forward rotation torque limit	%	0	Maximum torque	Maximum torque	
	Cn-09	TLMTR	Reverse rotation torque limit	%	0	Maximum torque	Maximum torque	
	Cn-14	TCRLMT	Speed limit for torque control I	r/min	0	Maximum speed	Maximum speed	
	Cn-17	TRQFIL	Torque reference filter time constant	100 μs	0	250	4	
	Cn-18	CLMIF	Forward external torque limit	%	0	Maximum torque	100	
	Cn-19	CLMIR	Reverse external torque limit	%	0	Maximum torque	100	
Sequence Related Constants	Cn-07	SFSACC	Soft start time (acceleration)	ms	0	10000	0	See note 4
	Cn-23	SFSDEC	Soft start time (deceleration)	ms	0	10000	0	See note 4
	Cn-0B	TGONLY	Zero-speed level	r/min	1	Maximum speed	20	
	Cn-0F	ZCLVL	Zero-clamp level	r/min	0	16383	10	
	Cn-12	BRKTIM	Time delay from brake reference until servo OFF	10 ms	0	50	0	
	Cn-15	BRKSPD	Speed level for brake reference output during motor operation	r/min	0	Maximum speed	100	
	Cn-16	BRKWAI	Output timing of brake reference during motor operation	10 ms	10	100	50	

Category	User Constant No.	Code	Name	Unit	Lower Limit	Upper Limit	Factory Setting	Remarks
	Cn-22	VCMPV	Speed coincidence signal output range	r/min	0	100	10	
Pulse Related Constants	Cn-0A	PGRAT	Dividing ratio setting	P/R	16	32768	2048	See note 1
	Cn-11	PULSNO	Number of encoder pulses	P/R	513	32768	2048	See note 1
Other Constants	Cn-0C	TRQMSW	Mode switch (torque reference)	%	0	Maximum torque	200	
	Cn-0D	REFMSW	Mode switch (speed reference)	r/min	0	Maximum speed	0	
	Cn-0E	ACCMSW	Mode switch (acceleration reference)	10 (r/min)/s	0	3000	0	
	Cn-10	JOGSPD	Jog speed	r/min	0	Maximum speed	500	
	Cn-1F	SPEED1	1st speed (contact input speed control)	r/min	0	Maximum speed	100	
	Cn-20	SPEED2	2nd speed (contact input speed control)	r/min	0	Maximum speed	200	
	Cn-21	SPEED3	3rd speed (contact input speed control)	r/min	0	Maximum speed	300	
	Cn-28	NFBCC	Speed loop compensation constant	---	0	100	0	
Cn-29	AXISNO	Axis address	---	0	14	0		

: User constants that must be always set

- Note**
- 1) After changing the setting, always turn the power OFF, then ON. This makes the new setting valid.
 - 2) Automatically set by autotuning function
 - 3) Valid only when zero-clamp function is used
 - 4) To use soft start function, always set both Cn-07 and Cn-23.

D

List of User Constants (Memory Switch Setting) (1)

	User Constant No.	Bit No.	Setting		Factory Setting	
Input signal enable/disable	Cn-01	0	0	1	0	
			Uses servo ON input ($\overline{S-ON}$).	Does not use servo ON input ($\overline{S-ON}$). Servo is always ON.		
		1	0	0	1	0
				Uses SEN signal input (SEN) when absolute encoder is used.	Does not use SEN signal input (SEN) when absolute encoder is used. Servopack automatically treats signal voltage as high level.	
		2	0	0	1	0
				Uses forward rotation prohibited input (P-OT).	Does not use forward rotation prohibited input (P-OT). Forward rotation is always possible.	
3	0	0	1	0		
		Uses reverse rotation prohibited input ($\overline{N-OT}$).	Does not use reverse rotation prohibited input ($\overline{N-OT}$). Reverse rotation is always possible.			
TGON signal switching	4	0	0	1	0	
			Uses TGON signal (TGON) as running output.	Uses TGON signal (TGON) as torque limit output.		
Operation performed at recovery from power loss	5	0	0	1	0	
			Remains in servo alarm status at recovery from power loss.	Automatically resets servo alarm status at recovery from power loss.		
Sequence selection at alarm condition	6	0	0	1	0	
			Stops the motor by applying dynamic brake when an alarm arises.	Causes the motor to coast to a stop when an alarm arises.		
	7	0	0	1	1	
			When an alarm arises, stops the motor by applying dynamic brake and then releases dynamic brake.	When an alarm arises, stops the motor by applying dynamic brake but does not release dynamic brake.		
	8	0	0	1	0	
Stops the motor according to bit 6 setting when overtravel is detected (P-OT, N-OT).			Decelerates the motor to a stop by applying the torque specified in Cn-06 when overtravel is detected (P-OT, N-OT).			
9	0	0	1	0		
		When overtravel is detected (P-OT, N-OT), decelerates the motor to a stop by applying the torque specified in Cn-06 and then turns the servo OFF.	When overtravel is detected (P-OT, N-OT), decelerates the motor to a stop by applying the torque specified in Cn-06 and then performs zero-clamp.			
Control mode selection	B•A	0•0	0•1	1•0	1•1	0•0
		Speed control	Speed control with zero-clamp function	Torque control I	Torque control II	
Mode switch selection	D•C	0•0	0•1	1•0	1•1	0•0
		Uses internal torque reference as a condition. (Level setting: Cn-0C)	Uses speed reference as a condition. (Level setting: Cn-0D)	Uses acceleration as a condition. (Level setting: Cn-0E)	Does not use mode switch function.	

	User Constant No.	Bit No.	Setting		Factory Setting
			0	1	
Encoder selection	Cn-01	E	0	1	0
			Uses incremental encoder.		
Torque feed-forward function		F	0	1	0
			Does not use torque feed-forward function.		
Rotation direction selection	Cn-02	0	0	1	0
			Defines counterclockwise (CCW) rotation as forward rotation.		
Home position error processing selection		1	0	1	0
			Detects home position error (when absolute encoder is used).		
Contact input speed control		2	0	1	0
			Does not use contact input speed control.		

Note For the Cn-01 and Cn-02 memory switches, always turn the power OFF and then ON after changing the setting. This makes the new setting valid.

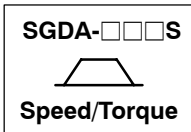

For Speed/Torque Control (SGDA-□□□S)

List of User Constants (Memory Switch Setting) (2)

	User Constant No.	Bit No.	Setting		Factory Setting
			0	1	
Reserved	Cn-02	5•4•3•7•6	Reserved (not to be set)		0
Motor selection		8	0	1	*
			SGM motor		
Reserved		A•9	Reserved (not to be set)		0
Integration time constant setting unit		B	0	1	0
			1 ms		
Torque reference filter type		C	0	1	0
			Primary		
Reserved		E•D	Reserved (not to be set)		0
Torque reference input selection		F	0	1	0
	Uses torque reference or torque feed-forward reference.		Uses analog voltage reference as torque limit input.		

The factory setting depends on the Servopack type as shown below.

Servopack Type	Factory Setting
SGDA-□□□S	0
SGDA-□□□SP	1

Note For the Cn-01 and Cn-02 memory switches, always turn the power OFF and then ON after changing the setting. This makes the new setting valid.

D

LIST OF USER CONSTANTS

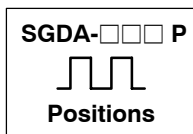

For Position Control (SGDA-□□□P)

List of User Constants (User Constant Setting)

Category	User Constant No.	Code	Name	Unit	Lower Limit	Upper Limit	Factory Setting	Remarks
	Cn-00	Not a user constant. (Cn-00 is used to select special mode for digital operator.)						
	Cn-01	Memory switch (see on page 408.)						
	Cn-02	Memory switch (see on page 410.)						
Gain Related Constants	Cn-04	LOOPHZ	Speed loop gain	Hz	1	2000	80	See note 2
	Cn-05	PITIME	Speed loop integration time constant	ms	2	10000	20	See note 2
	Cn-1A	POSGN	Position loop gain	1/s	1	500	40	See note 2
	Cn-1C	BIASLV	Bias	r/min	0	450	0	
	Cn-1D	FFGN	Feed-forward	%	0	100	0	
	Cn-26	ACCTME	Position reference acceleration/deceleration time constant	100 μs	0	640	0	
	Cn-27	FFFILT	Feed-forward reference filter	100 μs	0	640	0	
Torque Related Constants	Cn-06	EMGTRQ	Emergency stop torque	%	0	Maximum torque	Maximum torque	
	Cn-08	TLMTF	Forward rotation torque limit	%	0	Maximum torque	Maximum torque	
	Cn-09	TLMTR	Reverse rotation torque limit	%	0	Maximum torque	Maximum torque	
	Cn-17	TRQFIL	Torque reference filter time constant	100 μs	0	250	4	
	Cn-18	CLMIF	Forward external torque limit	%	0	Maximum torque	100	
	Cn-19	CLMIR	Reverse external torque limit	%	0	Maximum torque	100	
Sequence Related Constants	Cn-07	SFSACC	Soft start time (acceleration)	ms	0	10000	0	See note 4
	Cn-23	SFSDEC	Soft start time (deceleration)	ms	0	10000	0	See note 4
	Cn-0B	TGONLV	Zero-speed level	r/min	1	Maximum speed	20	
	Cn-12	BRKTIM	Time delay from brake reference until servo OFF	10 ms	0	50	0	
	Cn-15	BRKSPD	Speed level for brake reference output during motor operation	r/min	0	Maximum speed	100	

Category	User Constant No.	Code	Name	Unit	Lower Limit	Upper Limit	Factory Setting	Remarks
Sequence Related Constants	Cn-16	BRKWAI	Output timing of brake reference during motor operation	10 ms	10	100	50	
	Cn-1B	COINLV	Positioning complete range	Reference unit	0	250	7	
Pulse Related Constants	Cn-0A	PGRAT	Dividing ratio setting	P/R	16	32768	2048	See note 1
	Cn-11	PULSNO	Number of encoder pulses	P/R	513	32768	2048	See note 1
	Cn-24	RATB	Electronic gear ratio (numerator)		1	65535	4	See note 3
	Cn-25	RATA	Electronic gear ratio (denominator)		1	65535	1	See note 3
Other Constants	Cn-0C	TRQMSW	Mode switch (torque reference)	%	0	Maximum torque	200	
	Cn-0D	REFMSW	Mode switch (speed reference)	r/min	0	Maximum speed	0	
	Cn-0E	ACCMSW	Mode switch (acceleration reference)	10 (r/min)/s	0	3000	0	
	Cn-0F	ERPMSW	Mode switch (error pulse)	Reference unit	0	10000	10000	
	Cn-10	JOGSPD	Jog speed	r/min	0	Maximum speed	500	
	Cn-1E	OVERLV	Overflow	256 reference unit	1	32767	1024	
	Cn-1F	SPEED1	1st speed (contact input speed control)	r/min	0	Maximum speed	100	
	Cn-20	SPEED2	2nd speed (contact input speed control)	r/min	0	Maximum speed	200	
	Cn-21	SPEED3	3rd speed (contact input speed control)	r/min	0	Maximum speed	300	
	Cn-28	NFBCC	Speed loop compensation constant	---	0	100	0	
	Cn-29	AXISNO	Axis address	---	0	14	0	

 : User constants that must be always set

- Note**
- 1) After changing the setting, always turn the power OFF, then ON. This makes the new setting valid.
 - 2) Automatically set by autotuning function
 - 3) The following restriction applies to electronic gear ratio (Cn-24 and Cn-25):

$$0.01 \leq \frac{B(Cn-24)}{A(Cn-25)} \leq 100$$

- 4) The soft-start function is valid during the jog operation or when the contact input speed control mode is selected. The function is invalid during pulse command operations.

D

LIST OF USER CONSTANTS



For Position Control (SGDA-□□□P)

List of User Constants (Memory Switch Setting)

	User Constant No.	Bit No.	Setting		Factory Setting
Input signal enable/disable	Cn-01	0	0	1	0
			Uses servo ON input (S-ON).	Does not use servo ON input (S-ON). Servo is always ON.	
		1	Reserved (not to be set)		0
		2	0	1	0
			Uses forward rotation prohibited input (P-OT).	Does not use forward rotation prohibited input (P-OT). Forward rotation is always possible.	
		3	0	1	0
Uses reverse rotation prohibited input (N-OT).	Does not use reverse rotation prohibited input (N-OT). Reverse rotation is always possible.				
TGON signal switching	4	0	1	0	
		Uses TGON signal (TGON) as running output.	Uses TGON signal (TGON) as torque limit output.		
Operation performed at recovery from power loss	5	0	1	0	
		Remains in servo alarm status at recovery from power loss.	Automatically resets servo alarm status at recovery from power loss.		
Sequence selection at alarm condition	6	0	1	0	
		Stops the motor by applying dynamic brake when an alarm arises.	Causes the motor to coast to a stop when an alarm arises.		
	7	0	1	1	
		When an alarm arises, stops the motor by applying dynamic brake and then releases dynamic brake.	When an alarm arises, stops the motor by applying dynamic brake but does not release dynamic brake.		
	8	0	1	0	
Stops the motor according to bit 6 setting when overtravel is detected (P-OT, N-OT).		Decelerates the motor to a stop by applying the torque specified in Cn-06 when overtravel is detected (P-OT, N-OT).			
9	0	1	0		
	When overtravel is detected (P-OT, N-OT), decelerates the motor to a stop by applying the torque specified in Cn-06 and then turns the servo OFF.	When overtravel is detected (P-OT, N-OT), decelerates the motor to a stop by applying the torque specified in Cn-06 and then performs zero-clamp.			

D

	User Constant No.	Bit No.	Setting				Factory Setting
Operation performed at servo OFF	Cn-01	A	0		1		0
			Clears error pulse when servo is turned OFF.		Does not clear error pulse when servo is turned OFF.		
Mode switch selection		B	0		1		0
			Uses mode switch function as set in bits D and C of Cn-01.		Does not use mode switch function.		
Encoder selection		D•C	0•0	0•1	1•0	1•1	0•0
					Uses internal torque reference as a condition. (Level setting: Cn-0C)		
			Uses acceleration as a condition. (Level setting: Cn-0E)		Uses error pulse as a condition. (Level setting: Cn-0F)		
Internal speed selection*1		E	0		1		0
			Uses incremental encoder.		Uses absolute encoder.		
INHIBIT function	F	0		1		0	
		Stops the motor when both contact signals P-CL and N-CL are OFF.		Receives pulse reference when both contact signals P-CL and N-CL are OFF.			
Rotation direction selection	0	0		1		0	
		Defines counterclockwise (CCW) rotation as forward rotation.		Defines clockwise (CW) rotation as forward rotation (reverse rotation mode).			
Home position error processing selection	1	0		1		0	
		Detects home position error (when absolute encoder is used).		Does not detect home position error.			
Contact input speed control	2	0		1		0	
		Does not use contact input speed control.		Uses contact input speed control.			
Reference pulse form selection	5•4•3	0•0•0	0•0•1	0•1•0	0•1•1	1•0•0	0•0•0
		Sign + Pulse	CW + CCW	Phase A + Phase B (x 1 multiplication)	Phase A + Phase B (x 2 multiplication)	Phase A + Phase B (x 4 multiplication)	
Reserved	7•6	Reserved (not to be used)				0	
Motor selection	8	0		1		See note 2	
		SGM motor		SGMP motor			

D

LIST OF USER CONSTANTS

	User Constant No.	Bit No.	Setting		Factory Setting
Error counter clear signal	Cn-02	A	0	1	0
			Clears the error counter when an error counter clear signal is at high level.	Clears the error counter when the leading edge of an error counter clear signal rises.	
Integration time constant setting unit		B	0	1	0
			1 ms	0.01 ms	
Torque reference filter		C	0	1	0
			Primary	Secondary	
Reference pulse logic		D	0	1	0
			Does not invert reference pulse logic.	Inverts reference pulse logic.	
Others		E	0	1	0
			Displays position error Un-08 in x 1 reference units while in monitor mode.	Displays position error Un-08 in x 100 reference units while in monitor mode.	
		F	0	1	0
Line driver (Maximum reference pulse frequency: 450 kpps)	Open collector (Maximum reference pulse frequency: 200 kpps)				

D

: User constants that must be always set

NOTE For the Cn-01 and Cn-02 memory switches, always turn the power OFF and then ON after changing the setting. This makes the new setting valid.

- Note**
- 1) Internal speed selection is valid only when bit 2 of Cn-02 is set to "1."
 - 2) The factory setting depends on the Servopack type as shown below.

Servopack Type	Factory Setting
SGDA-□□□P	0
SGDA-□□□PP	1

Appendix E

List of Alarm Displays

- SGDA Servopack allows up to 10 last alarms to be displayed at a digital operator. This function is called a traceback function.

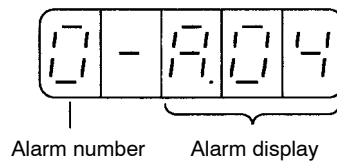

- This appendix provides the name and meaning of each alarm display.
- For details of how to display an alarm, refer to the following section:
4.2.1 Operation in Alarm Trace-back Mode
- For the cause of each alarm and the action to be taken, refer to the following section:
6.2.1 Troubleshooting Problems with Alarm Display

Alarm Display

Alarm Display on Digital Operator	Alarm Output				Alarm Name	Meaning	Remarks
	Alarm Code Output			ALM Output			
	ALO1	AL02	AL03				
A.00	OFF	OFF	OFF	OFF	Absolute data error	Absolute data fails to be received, or received absolute data is abnormal.	For absolute encoder only
A.02	OFF	OFF	OFF	OFF	User constant breakdown	Checksum results of user constants are abnormal.	
A.04	OFF	OFF	OFF	OFF	User constant setting error	The user constant setting is outside the allowable setting range.	
A.10	ON	OFF	OFF	OFF	Overcurrent	An overcurrent flowed through the power transistor.	
A.31	ON	ON	OFF	OFF	Position error pulse overflow	Position error pulse has exceeded the value set in user constant Cn-1E (overflow).	For position control only
A.40	OFF	OFF	ON	OFF	Overvoltage	The main circuit voltage for motor operation has become too high.	
A.51	ON	OFF	ON	OFF	Overspeed	Motor speed has exceeded 4950 r/min.	
A.70	ON	ON	ON	OFF	Overload	Rated torque was exceeded during continuous operation.	
A.80	OFF	OFF	OFF	OFF	Absolute encoder error	The number of pulses per absolute encoder revolution is abnormal.	For absolute encoder only
A.81	OFF	OFF	OFF	OFF	Absolute encoder backup error	All three power supplies for the absolute encoder (+5 V, battery and internal capacitor) have failed.	For absolute encoder only
A.82	OFF	OFF	OFF	OFF	Absolute encoder checksum error	The checksum results of absolute encoder memory is abnormal.	For absolute encoder only
A.83	OFF	OFF	OFF	OFF	Absolute encoder battery error	Battery voltage for the absolute encoder is abnormal.	For absolute encoder only

OFF: Output transistor is OFF

ON: Output transistor is ON



Checksum

An automatic check function for a set of data such as user constants. It stores the sum of user constant data, recalculates the sum at specific timing, and then checks whether the stored value matches the recalculated value. This function is a simple method of checking whether a set of data is correct.

Alarm Display on Digital Operator	Alarm Output				Alarm Name	Meaning	Remarks
	Alarm Code Output			ALM Output			
	ALO1	AL02	AL03				
A.84	OFF	OFF	OFF	OFF	Absolute encoder data error	Received absolute data is abnormal.	For absolute encoder only
A.85	OFF	OFF	OFF	OFF	Absolute encoder overspeed	The motor was running at a speed exceeding 400 r/min when the absolute encoder was turned ON.	For absolute encoder only
A.61	OFF	OFF	OFF	OFF	Reference input read error	Servopack CPU failed to detect reference input.	For speed/torque control
A.C1	ON	OFF	ON	OFF	Servo overrun detected	The servomotor (encoder) ran out of control.	
A.C2	ON	OFF	ON	OFF	Encoder output phase error	Phases A, B and C output by the encoder are abnormal.	
A.C3	ON	OFF	ON	OFF	Encoder A-, B-phase disconnection	Wiring in encoder phase A or B is disconnected.	
A.C4	ON	OFF	ON	OFF	Encoder C-phase disconnection	Wiring in encoder phase C is disconnected.	
A.F3	OFF	ON	OFF	OFF	Power loss error	A power interruption exceeding one cycle occurred in AC power supply.	
CPF00	Undefined				Digital operator transmission error 1	Digital operator fails to communicate with Servopack even five seconds after power is turned ON.	These alarms are not stored in alarm traceback memory.
CPF01	Undefined				Digital operator transmission error 2	Transmission error has occurred five consecutive times.	
A.99	OFF	OFF	OFF	ON	Not an error	Normal operation status	

OFF: Output transistor is OFF

ON: Output transistor is ON

E

INDEX

Number

- 1CN connector
 - dimensional drawings, 326
 - specifications, 326
- 1CN connector kit, 27

A

- absolute data
 - exchange sequence, 151
 - transmitting sequence, 152
- absolute value detection system, 148
- AC servomotor sizing software, 145
- alarm, display, list, 412
- alarm code output, 125
- alarm output signals, wiring, 125
- alarm signal circuit, test run, 39
- alarm traceback data, 134
 - clearing, 202
- alarm traceback mode, 183
- alarms
 - display, 156
 - troubleshooting, 347
 - Servo, resetting using Digital Operator, 169
 - servo, reset, 169
- alignment, 20
 - radial load, 20
 - thrust load, 20
- autotuning, 191
 - adjustment of position control Servopacks, 380
 - adjustment of speed-control Servopacks, 376
 - precautions, 194
- autotuning function, 114
 - Digital Operators, 189

B

- battery, 150
 - absolute encoder, 325
 - replacement, absolute encoder, 346
- bits, turning ON and OFF, 177
- brake power supply, 26
 - dimensional drawings, 318

- internal circuit, 319
- specifications, 318

C

- cables, 136
 - encoders
 - dimensional drawings, 320
 - specifications, 320
 - for connecting PC and Servopack, 338
 - motor
 - connectors, 315
 - dimensional drawings, 311
 - specifications, 311
 - specifications, 308
 - tension, 136
- comparators, 9
- connections
 - contact input signal terminals, 77
 - contact output signal terminals, 78
 - I/O signal terminals, Servopack, 30
- connector kits, 314
 - dimension drawings, 314
 - specifications, 314
- connector terminal block conversion unit, 27
- connectors
 - 1CN, test run, 39
 - 2CN, reverse rotation mode, 55
 - absolute encoder, 164
 - Digital Operator, 166
 - encoder cables, 314
 - incremental encoder, 163
 - motor cables, 315
 - standard-type motor without brake, 165
 - standard-type motor with brake, 165
 - terminal layouts, 161
 - Servopack position control, 162
 - Servopack speed/torque control, 161
- contact input signal terminalsconnections, 77
- contact input speed control function, 83
 - motor speeds, 84
 - prohibiting, 64
 - soft start time, 84
- contact output signal terminalsconnections, 78
- controlled systems
 - components, 6
 - meaning, 5

D

- deceleration stop mode, 58

- detectors
 - encoders, 8
 - meaning, 5
- Digital Operators, 14, 27
 - alarm traceback mode, 183
 - autotuning, 189
 - connection, 168
 - dimensional drawings, 291
 - mode selection, 170
 - monitor mode, 179
 - status display mode, 171
 - user constant setting mode, 174
 - motor operation, 186
 - selection, 215
 - flowchart, 216
 - servo alarm reset, 169
 - simple motor check, 186
 - test run, 40
- dimensional diagrams, noise filter, 331
- dimensional drawings, 246
 - 1CN connector, 326
 - brake power supply, 318
 - cables, encoders, 320
 - connector kits, 314
 - Digital Operators, 291
 - Encoder Signal Converter Unit, 336
 - magnetic contactor, 332
 - motor cables, 311
 - regenerative unit, 334
 - Servomotors, 246–280
 - Servopacks, 289
 - variable resistors, 335
- dividing, 73
- drive systems, 6
- dynamic brake, 105
 - stop mode, 59

E

- electronic gear function, 79
 - setting, 79
- electronic gear ratio, 79
 - for different load mechanisms, 82
 - load travel distance per revolution of load shaft in reference units, 80
 - machine specifications, 79
 - number of encoder pulses for the SGM Servomotor, 79
 - reference unit, 80
- encoder output, 73
 - signals, divided, 73

- encoder pulses, number per revolution, 102
- Encoder Signal Converter Unit
 - dimensional drawings, 336
 - specifications, 336
- encoders
 - absolute, 8, 148
 - battery, 325
 - battery replacement, 346
 - home position error detection, 157
- cables
 - connectors, 314
 - dimensional drawings, 320
 - specifications, 320
- extending cables, 157
- incremental, 8
 - specification, 75
- error counter, clearing, 72
- external torque limit, 62
- external torque limit input, 63
 - forward, 63
 - reverse, 63

F

- feed-forward control, 116
- feedback control, meaning, 3
- fuse, 138

G

- gain
 - adjustment, 112, 114
 - AC Servopack, 374
 - setting references, load inertia ratio, 385
- ground wire, 136
- ground-fault interrupter, 17
- grounding, 17
 - wiring, 139

H

- high-voltage lines, Servopacks, 159
- holding brake, 107
 - electrical specifications
 - 100-VAC SGM Servomotors, 226
 - 100-VAC SGMP Servomotors, 230
 - 200-VAC SGM Servomotors, 218
 - 200-VAC SGMP Servomotors, 223
- home position error detection, 157

host controllers, 5, 10, 27

hot start, 240

I

I/O signal terminals

connections, 30

list

position control, 396

speed/torque control, 390

impact resistance, 233

In-rush Current, 245

input pulse multiply function, 71

input signal terminals

alarm reset, 128

battery, 75

error counter clear input, 72

forward external torque limit input, 63

forward rotation prohibited, 56

I/O power supply, 77

motor rotation direction, 86

proportional/integral control, 68

reference pulse input, 70

reference sign input, 70

reverse external torque limit input, 63

reverse rotation prohibited, 56

SEN signal input, 75

servo ON, 128

signal ground for speed reference input, 65, 91

signal ground for torque reference input, 91

speed reference input, 65, 91

speed selection, 85

torque reference input, 91

torque/speed changeover, 92

zero-clamp speed control, 106

inspection, 344, 345

Servomotors, 344

Servopacks, 345

installation, 18

servomotor, alignment, 20

Servomotors, 19

Servopacks, 22

internal torque limit, 59

J

jog speed, 101

L

limit switch, 56

overtravel limit function, 56

load inertia, 241

gain settings, 385

loads

allowable radial load, 232

allowable thrust load, 232

M

machine data table, 211

machine rigidity, 190

selection, 194

magnetic contactor, 26

dimensional drawings, 332

internal connection diagram, 332

specifications, 332

maintenance, 344, 345

Servomotors, 344

Servopacks, 345

MCCB, 26, 137, 138, 330

mechanical tolerance, 233

memory switches

see user constants

mode selection, Digital Operators, 170

mode switch, 118

detection points

error pulse, 121

motor acceleration, 120

speed reference, 120

torque reference, 119

molded-case circuit breaker

see⇒MCCB

monitor mode, 179

motor

checking, Digital Operators, 186

operation, Digital Operators, 186

type check, 203

N

N-OT input signal, 57

noise control, 17

filter, 26, 137

dimensional diagrams, 331

installation, 140

specifications, 331

wiring, 138

O

order lists, 299

output phase, form, 75
absolute encoder, 75
incremental encoder, 75

output signal terminals
alarm code output, 126
brake interlock output, 108
encoder output, 74, 75
frame ground, 75
output signal ground common, 78, 109
positioning complete output, 130
running output, 132
servo alarm output, 126
signal ground for alarm code output, 126
signal ground for encoder output, 75
signal ground for servo alarm output, 126
speed coincidence output, 131
torque limit output, 60

overhanging load
precautions, 17
Servomotors, 244

overload, characteristics, Servopacks, 240

overtravel limit function, 56
limit switch, 56

P

P-OT input signal, 57

peripheral devices
selection, 293
flowchart, 294
specifications, 308
wiring, 25

personal computer, 27

position references, inputs, 69
line driver output, 69
open collector output, 69

positioning complete signal, 129

positioning time, minimizing, 114

power amplifiers, 9

Power Loss, 245

power loss, 134

power ratings, 11

precautions, 16

pressure control, 88

proportional control, 116

proportional/integral control, 9, 116
signal, 68

protective sequence, 125

pulse dividing ratio, 76

R

radial load, 20

ratings

100-VAC SGM Servomotors, 225
100-VAC SGMP Servomotors, 228
200-VAC SGM Servomotors, 217
200-VAC SGMP Servomotors, 221
SGDA Servopacks, 235
for position control, 238

reference offset, 196

automatic adjustment, 104, 113, 196
manual adjustment, 104, 113

reference pulse

form, 70

input

allowable voltage level, 72
timing, 72

reference pulse inhibit function, 97

reference pulse input filter selection function, 99

regenerative unit, 26, 144

connection, 146
dimensional drawings, 334
specifications, 334

residual voltage, precautions, 16

reverse rotation mode, 54, 55

2CN connector, 55
user constant, 55

rotation, 57

forward, prohibiting, 57
reverse, prohibiting, 57

running output signal, 132

S

SEN signal, 149

servo amplifiers, 9
meaning, 5

servo drive, meaning, 4

- servo mechanisms
 - illustration, 5
 - meaning, 2
 - servo OFF, 58
 - servo ON input signal, 128
 - Servomotors, 344
 - 100-VAC SGM ratings, 225
 - 100-VAC SGM specifications, 225
 - 100-VAC SGM torque-motor speed characteristics, 227
 - 100-VAC SGMP ratings, 228
 - 100-VAC SGMP specifications, 228
 - 100-VAC SGMP torque-motor speed characteristics, 231
 - 200-VAC SGM ratings, 217
 - 200-VAC SGM specifications, 217
 - 200-VAC SGM torque-motor speed characteristics, 220
 - 200-VAC SGMP ratings, 221
 - 200-VAC SGMP specifications, 221
 - 200-VAC SGMP torque-motor speed characteristics, 224
 - AC, 7
 - induction, 7
 - synchronous, 7
 - components, 7
 - DC, 7
 - dimensional drawings, 246–280
 - inspection, 344
 - installation, 19
 - maintenance, 344
 - meaning, 4, 5
 - overhanging load, 244
 - selection, 207
 - flowchart, 209
 - machine data table, 211
 - setting the type, 103
 - test run, 39
- Servopacks, 345
- AC, gain adjustment, 374
 - differences between SGDA and SGD, 372
 - dimensional drawings, 289
 - high-voltage lines, 159
 - inspection, 345
 - installation, 22
 - instrument connection examples, 368
 - internal connection diagram, 368
 - maintenance, 345
 - meaning, 4
 - overload characteristics, 240
 - position control
 - autotuning, 380
 - manual adjustment, 381
 - ratings, 235
 - for position control, 238
 - selection, 213
 - flowchart, 214
 - specifications, 235
 - for position control, 238
 - speed-control
 - autotuning, 376
 - manual adjustment, 377
 - test run, 42
- servos
- alarm output, 125
 - alarm reset, 169
 - control systems, meaning, 4
 - gain adjustment, 112, 114
 - meaning, 3
- smoothing function, 112
 - position reference acceleration/deceleration time constant, 112
- soft start function, 87, 111
- software, version check, 204
- specifications
- 100-VAC SGM Servomotors, 225
 - 100-VAC SGMP Servomotors, 228
 - 1CN connector, 326
 - 200-VAC SGM Servomotors, 217
 - 200-VAC SGMP Servomotors, 221
 - brake power supply, 318
 - cables, 308
 - encoders, 320
 - connector kits, 314
 - home position pulse, 154
 - incremental pulse, 154
 - magnetic contactor, 332
 - noise filter, 331
 - peripheral devices, 308
 - regenerative unit, 334
 - serial data, 154
 - SGDA Servopacks, 235
 - for position control, 238
- speed bias, 117
- speed coincidence output signal, 131
- speed control, 67
 - zero-clamp, 67
- Speed Loop Compensation Function, 124
- speed reference offset, manual adjustment mode, 199
- speed references, 65
 - gain, 68
 - inputs, 65
- starting time, 241
- status display mode, 171
- stop mode, setting, 104

stop torque, 58
stopping time, 241
supply voltages, precautions, 16
surge suppressor, 333

T

tension control, 88
terminals
 standard-type motor without brake, 165
 standard-type motor with brake, 165
test run, 37
 minimum user constants, 48
 motor alone, 39
 motor connected to the machine, 44
 position control from the host controller, 47
 servomotor with brake, 46
thrust load, 20
torque control, 59, 88
torque feed-forward function, 94
torque limit
 input signals, 64
 output signal, 60
 value, 96
torque reference filter time constant, 113
torque restriction function, 62
 by analog voltage reference, 95
 torque limit value, 62
troubleshooting
 alarm display, 347
 without alarm display, 366

U

user constant setting mode, 174
user constants, 55, 57, 64
 bias, 117
 brake signal output timing during motor operation, 110
 brake signal speed level output during motor operation, 110
 contact input speed control function, 64
 contact input speed control selection, 64, 83
 control mode selection, 66
 dividing ratio setting, 76, 155
 dividing ratio settings, 74
 electronic gear ratio, 81
 emergency stop torque, 58

encoder type selection, 75, 102, 149
error counter clear signal selection, 72
feed-forward gain, 116
forward external torque limit, 63
forward rotation torque limit, 59
jog speed, 101
list
 position control, 406
 speed/torque control, 402
mode switch ON/OFF, 121
mode switch selection, 122
motor selection, 103
motor speeds, 84
N-OT input signal, 57
number of encoder pulses, 102, 150
operation at recovery from power loss, 134
operation when motor stops after overtravel, 57
operation when motor stops after servo OFF, 58
overflow, 115
PI/P changeover, 116
position loop gain, 115
positioning complete range, 130
P-OT input signal, 57
reference pulse form selection, 70
reference pulse inhibit function, 97
reference pulse input filter selection function, 99
reverse external torque limit, 63
reverse rotation mode, 55
reverse rotation torque limit, 59
rotation direction selection, 55
SEN input signal, 149
servo ON input signal, 129
soft start time, 84, 111
speed coincidence signal output width, 131
speed limit for torque control I, 93
speed loop gain, 115
speed loop integration time constant, 115
speed reference gain, 68, 93
stopping motor at servo OFF, 58, 105
stopping the motor at overtravel, 57
TGON output signal selection, 61, 133
time delay from brake signal output to servo OFF, 109
torque control, 88
torque feed-forward function selection, 94
torque reference filter time constant, 113
torque reference gain, 93, 95, 96
torque restriction by analog voltage reference, 95
zero-clamp speed control, 106
zero-speed level, 133
zero-clamp level, 107

V

variable resistordimensional drawings, 335
vibration class, 234

vibration resistance, 233
voltage resistance test, 17

W

wiring, 25, 28, 55, 136
 grounding, 139
 main circuit, 28
 more than one servo drive, 143

noise control, 138
peripheral devices, 25
precautions, 16, 136
shorting, 2CN connector, 55

Z

zero-clamp function, 68, 106

Σ Series SGM/SGMP/SGDA USER'S MANUAL

IRUMA BUSINESS CENTER

480, Kamifujisawa, Iruma, Saitama 358-8555, Japan
Phone 81-42-962-5696 Fax 81-42-962-6138

YASKAWA ELECTRIC AMERICA, INC.

2121 Norman Drive South, Waukegan, IL 60085, U.S.A.
Phone 1-847-887-7000 Fax 1-847-887-7370

MOTOMAN INC. HEADQUARTERS

805 Liberty Lane West Carrollton, OH 45449, U.S.A.
Phone 1-937-847-6200 Fax 1-937-847-6277

YASKAWA ELÉTRICO DO BRASIL COMÉRCIO LTD.A.

Avenida Fagundes Filho, 620 Bairro Saude-Sao Paulo-SP, Brazil CEP: 04304-000
Phone 55-11-5071-2552 Fax 55-11-5581-8795

YASKAWA ELECTRIC EUROPE GmbH

Am Kronberger Hang 2, 65824 Schwalbach, Germany
Phone 49-6196-569-300 Fax 49-6196-569-398

Motoman Robotics Europe AB

Box 504 S38525 Torsås, Sweden
Phone 46-486-48800 Fax 46-486-41410

Motoman Robotec GmbH

Kammerfeldstraße 1, 85391 Allershausen, Germany
Phone 49-8166-90-100 Fax 49-8166-90-103

YASKAWA ELECTRIC UK LTD.

1 Hunt Hill Orchardton Woods Cumbernauld, G68 9LF, United Kingdom
Phone 44-1236-735000 Fax 44-1236-458182

YASKAWA ELECTRIC KOREA CORPORATION

Kipa Bldg #1201, 35-4 Youido-dong, Yeongdungpo-Ku, Seoul 150-010, Korea
Phone 82-2-784-7844 Fax 82-2-784-8495

YASKAWA ELECTRIC (SINGAPORE) PTE. LTD.

151 Lorong Chuan, #04-01, New Tech Park Singapore 556741, Singapore
Phone 65-6282-3003 Fax 65-6289-3003

YASKAWA ELECTRIC (SHANGHAI) CO., LTD.

4F No.18 Aona Road, Waigaoqiao Free Trade Zone, Pudong New Area, Shanghai 200131, China
Phone 86-21-5866-3470 Fax 86-21-5866-3869

YATEC ENGINEERING CORPORATION

4F., No.49 Wu Kong 6 Rd, Wu-Ku Industrial Park, Taipei, Taiwan
Phone 886-2-2298-3676 Fax 886-2-2298-3677

YASKAWA ELECTRIC (HK) COMPANY LIMITED

Rm. 2909-10, Hong Kong Plaza, 186-191 Connaught Road West, Hong Kong
Phone 852-2803-2385 Fax 852-2547-5773

BEIJING OFFICE

Room No. 301 Office Building of Beijing International Club, 21
Jianguomenwai Avenue, Beijing 100020, China
Phone 86-10-6532-1850 Fax 86-10-6532-1851

TAIPEI OFFICE

9F, 16, Nanking E. Rd., Sec. 3, Taipei, Taiwan
Phone 886-2-2502-5003 Fax 886-2-2505-1280

SHANGHAI YASKAWA-TONGJI M & E CO., LTD.

27 Hui He Road Shanghai China 200437
Phone 86-21-6553-6060 Fax 86-21-5588-1190

BEIJING YASKAWA BEIKE AUTOMATION ENGINEERING CO., LTD.

30 Xue Yuan Road, Haidian, Beijing P.R. China Post Code: 100083
Phone 86-10-6233-2782 Fax 86-10-6232-1536

SHOUGANG MOTOMAN ROBOT CO., LTD.

7, Yongchang-North Street, Beijing Economic Technological Investment & Development Area,
Beijing 100076, P.R. China
Phone 86-10-6788-0551 Fax 86-10-6788-2878



YASKAWA ELECTRIC CORPORATION

YASKAWA

In the event that the end user of this product is to be the military and said product is to be employed in any weapons systems or the manufacture thereof, the export will fall under the relevant regulations as stipulated in the Foreign Exchange and Foreign Trade Regulations. Therefore, be sure to follow all procedures and submit all relevant documentation according to any and all rules, regulations and laws that may apply.

Specifications are subject to change without notice for ongoing product modifications and improvements.

MANUAL NO. TSE-S800-15C

© Printed in Japan July 2002 95-7

02-5 ①

592-185,592-284

94-C23-043L, 94-C71-064L