

CR2330

■ Dimensions(mm)

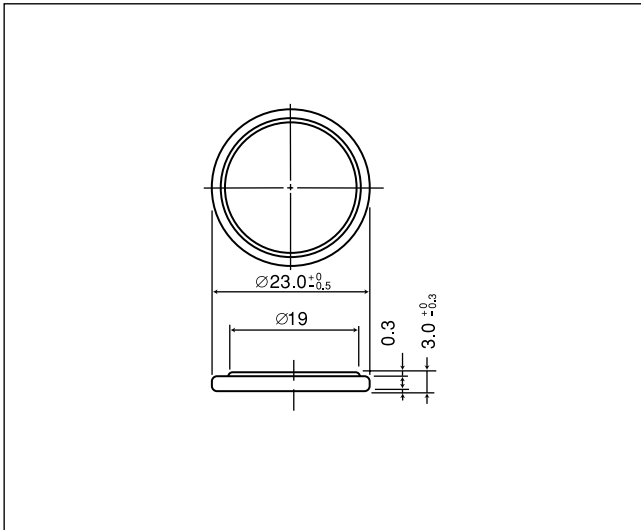

■ Specification

Nominal voltage(V)	3
Nominal capacity(mAh)	265
Continuous drain(mA)	0.2
Operating temperature(°C)	-30 to +60

■ Discharge temperature characteristics



■ Operating voltage vs. load resistance(voltage at 50% discharge depth)



■ Capacity vs. load resistance



CR2354

■ Dimensions(mm)

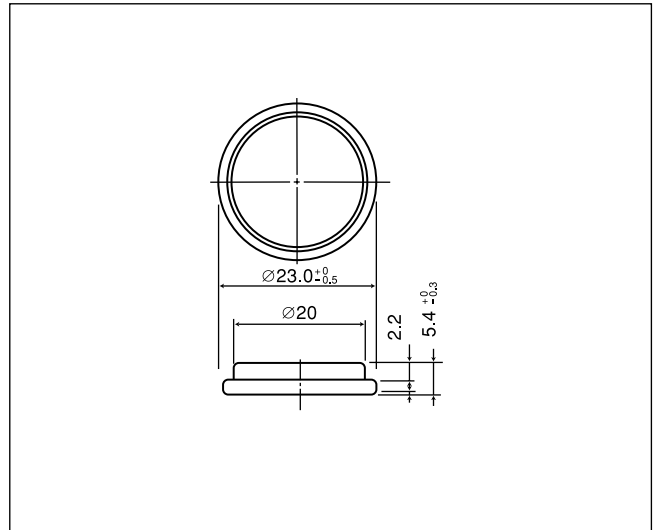

■ Specification

Nominal voltage(V)	3
Nominal capacity(mAh)	560
Continuous drain(mA)	0.2
Operating temperature(°C)	-30 to +60

■ Discharge temperature characteristics



■ Operating voltage vs. load resistance(voltage at 50% discharge depth)



■ Capacity vs. load resistance

