

### Block Diagram

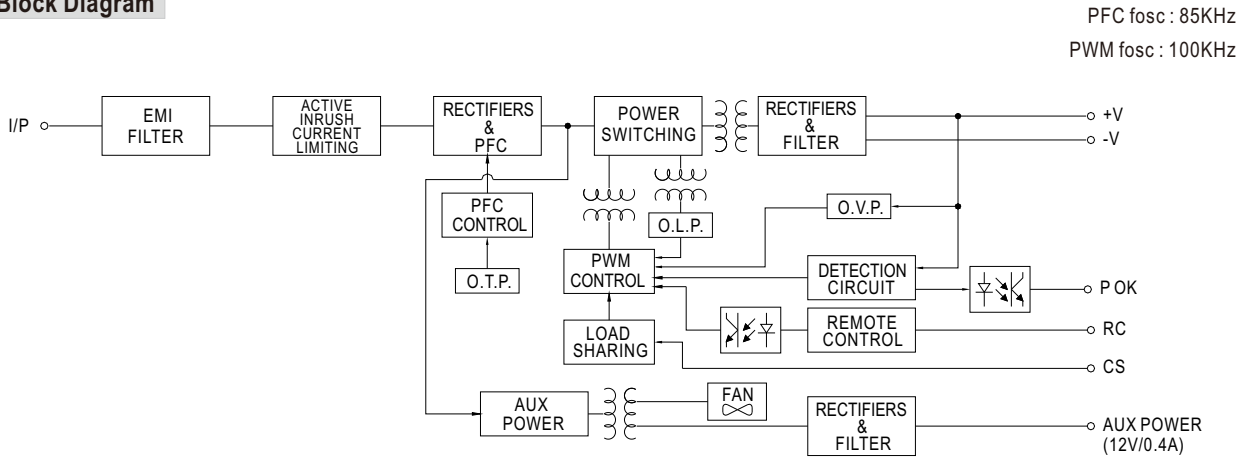

### Static Characteristics

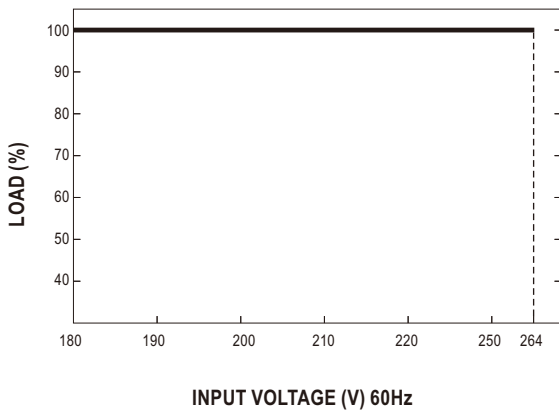

### Derating Curve

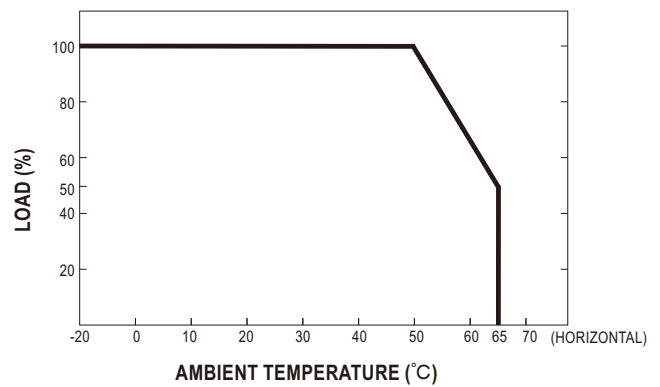

### Efficiency vs Load (400V Model)

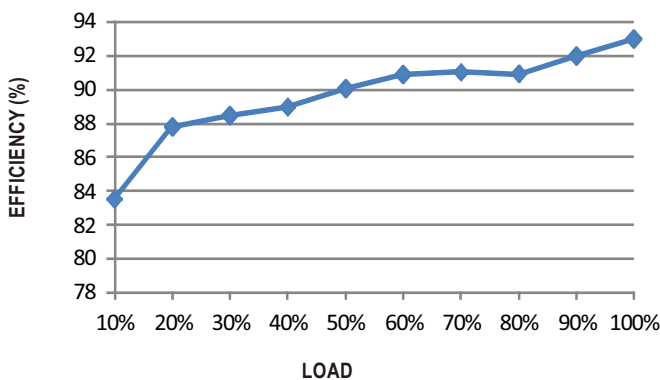

※ The curve above is measured at 230VAC.

## DRIVING METHODS OF LED MODULE

※ I-V Operating Area

◎ CSP-3000-120

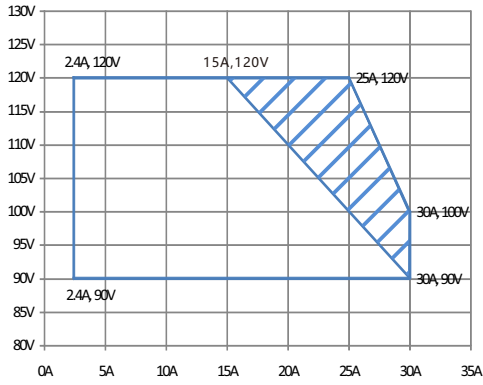

▨ Recommended High Performance Region □ Allowed Operational Region

◎ CSP-3000-250

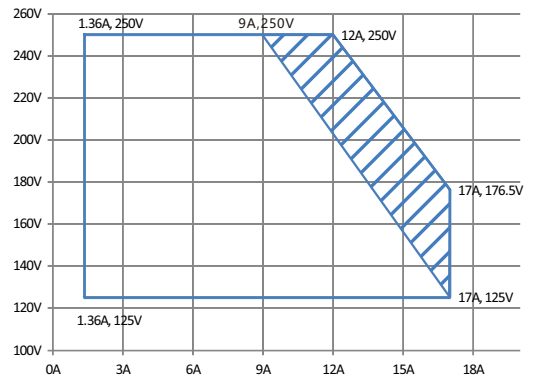

▨ Recommended High Performance Region □ Allowed Operational Region

◎ CSP-3000-400

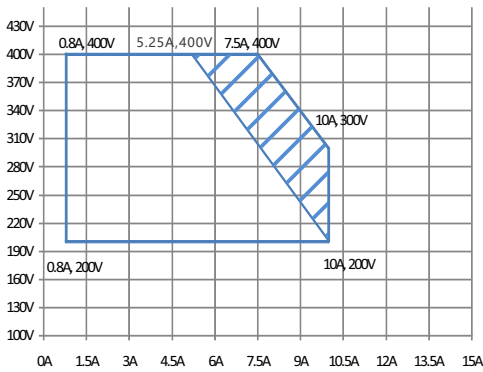

▨ Recommended High Performance Region □ Allowed Operational Region