

Clearance

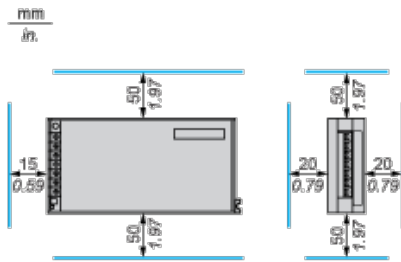

Mounting Way

Mounting on Vertical Plane

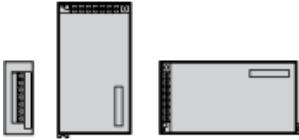

Mounting on Horizontal Plane



Direct Mounting by 2 M4 x 20 Screws

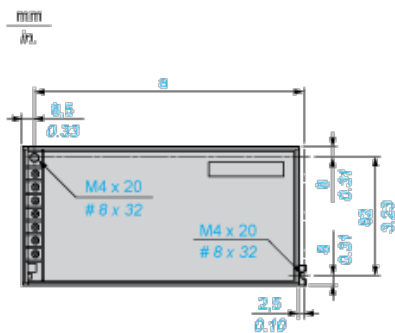

Dimensions in mm

a
194

Dimensions in in

a
7.64

Mounting on the Back on ABL 1A01 Reversible Bracket by Three 4 mm Diameter Screws

mm
in.

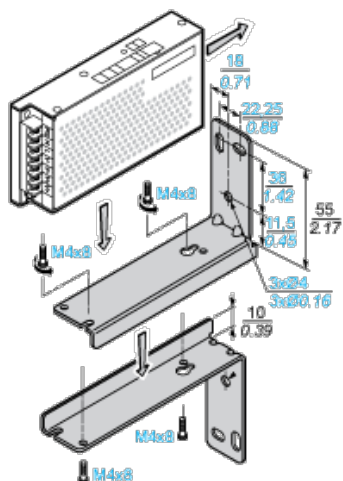

Mounting on ABL 1A02 Clip-on Mounting on 35 mm Rail

mm
in.

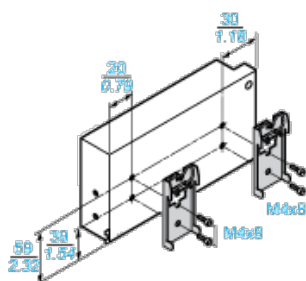

Mounting by the Back

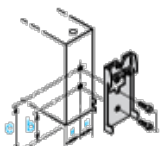

Dimensions in mm

b	c
38	58

Dimensions in in.

b	c
1.50	2.28

Internal Wiring Diagram

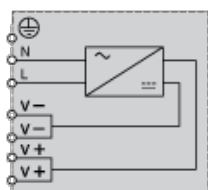

Series or Parallel Connection