

IGBT MODULE (L series)

■ Features

- High Speed Switching
- Low Saturation Voltage
- Voltage Drive

■ Applications

- Inverter for Motor Drive
- AC and DC Servo Drive Amplifier
- Uninterruptible Power Supply
- Industrial Machines, such as Welding Machines

■ Maximum Ratings and Characteristics

● Absolute Maximum Ratings

Items	Symbols	Ratings	Units
Collector-Emitter Voltage	V _{CEs}	1200	V
Gate-Emitter Voltage	V _{GES}	±20	V
Collector Current	Continuous	I _C	25
	1ms	I _C pulse	50
	Continuous	-I _C	25
	1ms	-I _C pulse	50
Max. Power Dissipation	P _C	250	W
Operating Temperature	T _j	+150	°C
Storage Temperature	T _{stg}	-40 to +125	°C
Isolation Voltage	AC. 1min.	V _{is}	2500
Screw Torque	Mounting *1		3.5

● Electrical Characteristics (T_j=25°C unless otherwise specified)

Items	Symbols	Test Conditions	Min.	Typ.	Max.	Units
Zero Gate Voltage Collector Current	I _{CEs}	V _{GE} =0V V _{CE} =1200V T _j =25°C			1.0	mA
		V _{GE} =0V V _{CE} =1200V T _j =125°C			-	mA
Gate-Emitter Leakage Current	I _{GES}	V _{CE} =0V V _{GE} =±20V			100	nA
Gate-Emitter Threshold Voltage	V _{GE(th)}	V _{CE} =20V I _C =25mA	3.0		6.0	V
Collector-Emitter Saturation Voltage	V _{CE(sat)}	V _{GE} =15V I _C =25A		2.7	3.5	V
Input Capacitance	C _{ies}	V _{GE} =0V		4500		pF
Output Capacitance	C _{oes}	V _{CE} =10V		-		
Reverse Transfer Capacitance	C _{res}	f=1MHz		-		
Turn-on Time	t _{on}	V _{CC} =600V		0.5	0.8	μs
	t _r	I _C =25A		0.3	0.6	
Turn-off Time	t _{off}	V _{GE} =±15V		0.8	1.5	
	t _f	R _G =50Ω		0.3	0.5	
Diode Forward On-Voltage	V _F	I _F =25A V _{GE} =0V			2.5	V
Reverse Recovery Time	t _{rr}	I _F =25A -di/dt=75A/μs V _{GE} =-10V		200	350	ns

● Thermal Characteristics

Items	Symbols	Test Conditions	Min.	Typ.	Max.	Units
Thermal Resistance	R _{th(j-c)}	IGBT			0.50	°C/W
	R _{th(j-c)}	Diode			1.00	
	R _{th(c-f)}	With Thermal compound		0.05		

■ Outline Drawings

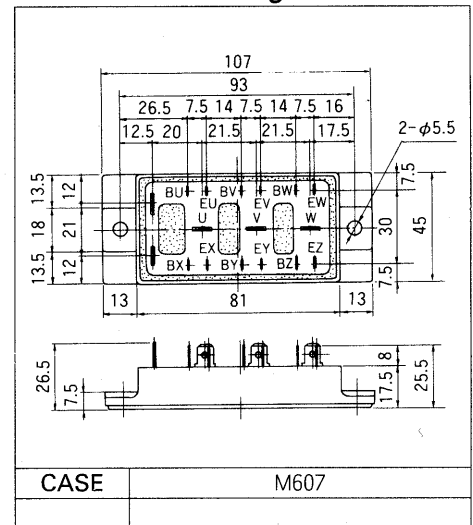

■ Equilavelent Circuit Schematic

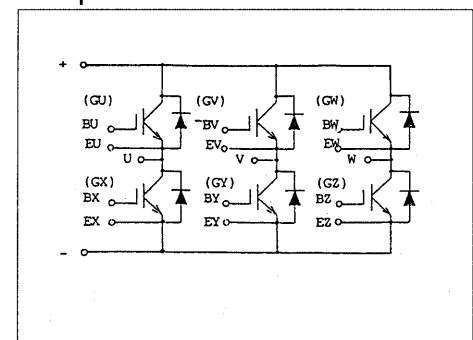

*1 Recommendable Value 2.5 ~ 3.5 N·m (M5)

■ Characteristics

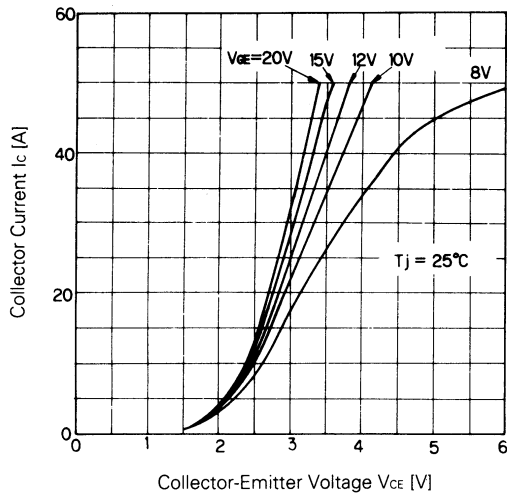

Collector Current vs. Collector-Emitter Voltage

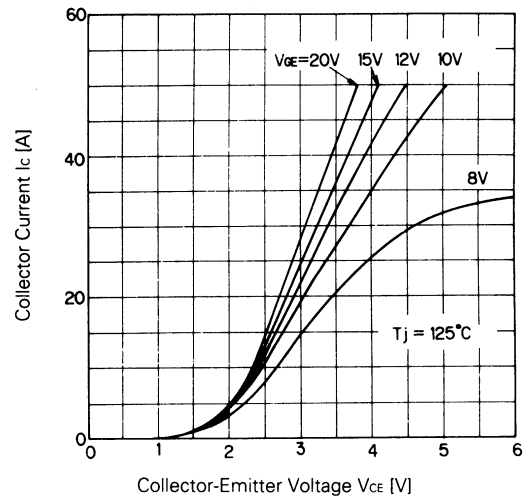

Collector Current vs. Collector-Emitter Voltage

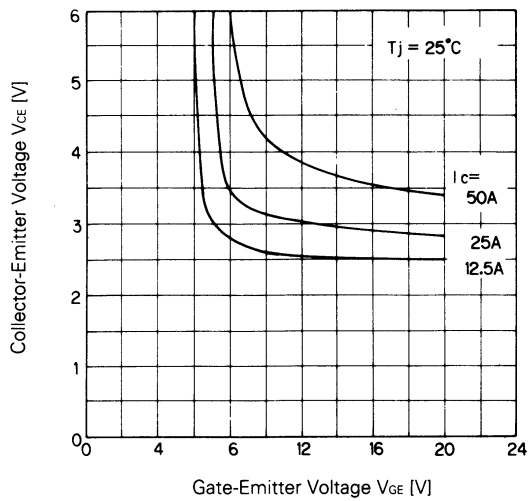

Collector-Emitter Voltage vs. Gate-Emitter Voltage

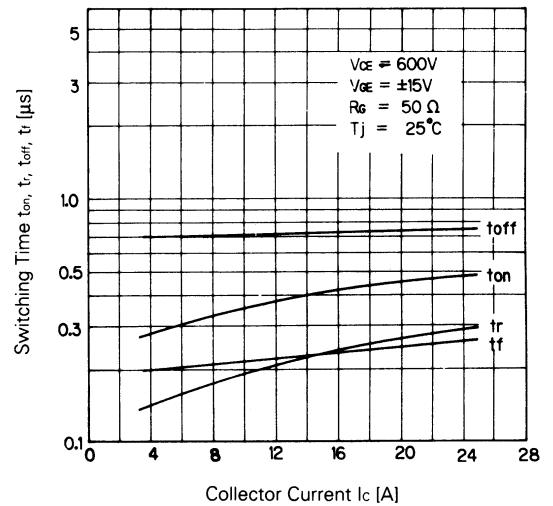

Switching Time

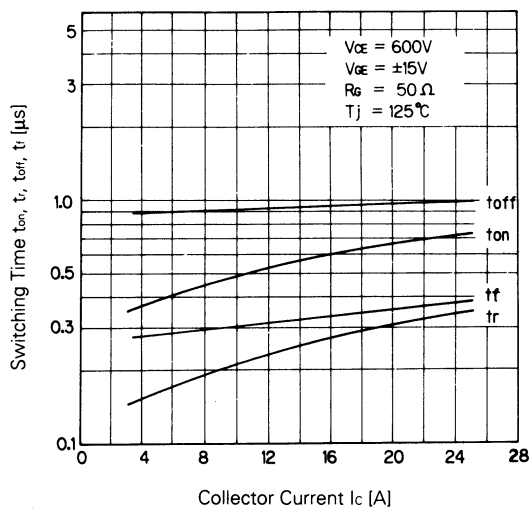

Switching Time

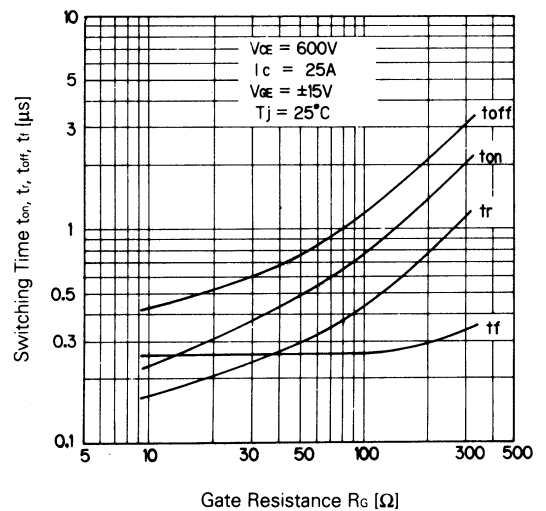

Switching Time-Gate Resistance

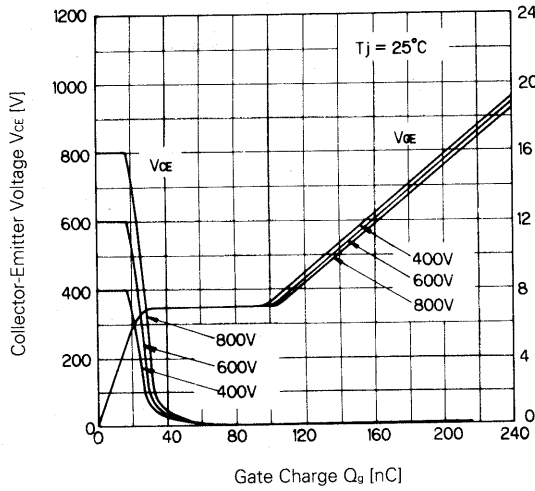

Dynamic Input Characteristic

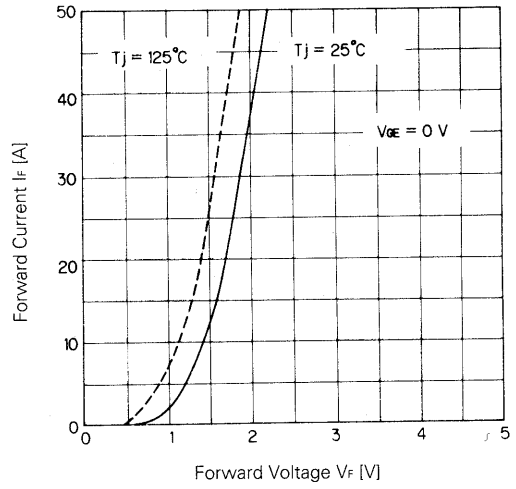

Forward Voltage of Free Wheel Diode

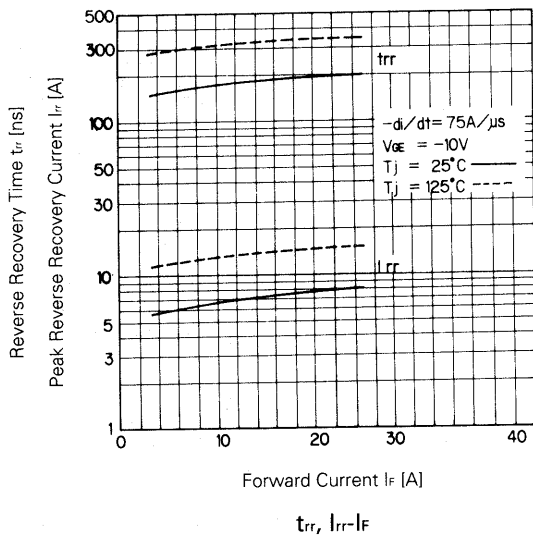

t_{rr}, I_{rr} - I_f

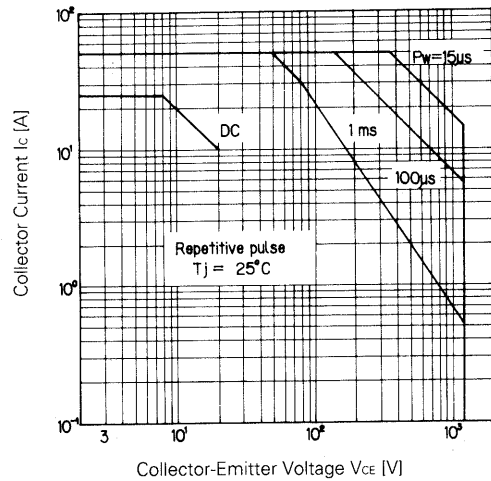

Safe Operating Area

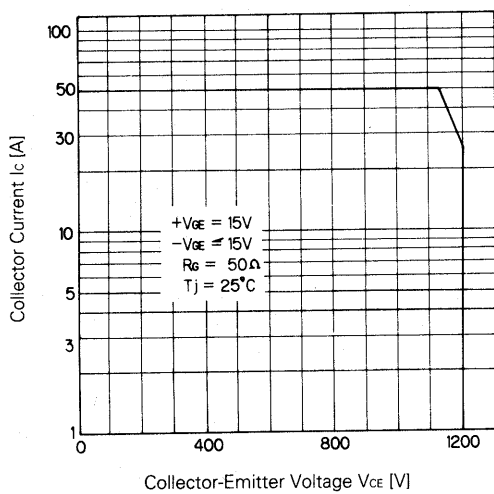

Reverse Biased Safe Operating Area

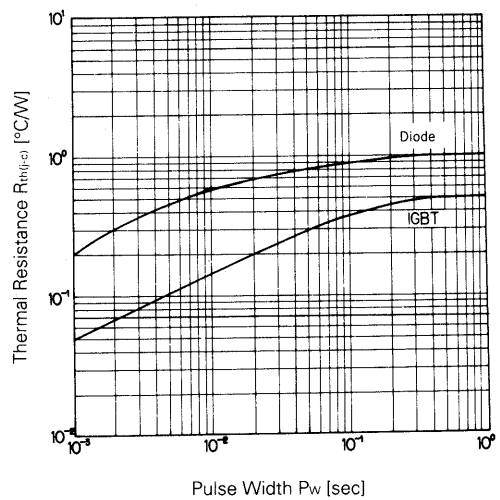

Transient Thermal Resistance

For more information, contact:

Collmer Semiconductor, Inc.

P.O. Box 702708

Dallas, TX 75370

972-733-1700

972-381-9991 Fax

<http://www.collmer.com>

This datasheet has been download from:

www.datasheetcatalog.com

Datasheets for electronics components.