

Automation Panel 5000

User's manual

Version: **1.10 (March 2018)**
Model no.: **MAAP5000-ENG**

Translation of the original manual

The values and specifications listed in this manual are current as of its publication. We reserve the right to change the contents of this manual without notice. Bernecker + Rainer Industrie-Elektronik Ges.m.b.H. is not liable for technical/editorial errors and/or any incomplete information in this manual. In addition, Bernecker + Rainer Industrie-Elektronik Ges.m.b.H. shall not be liable for any incidental or consequential damages in connection with or arising from the furnishing, performance or use of the product(s) in this documentation. Software names, hardware names and trademarks are registered by their respective companies.

Chapter 1: General information

Chapter 2: Technical data

Chapter 3: Commissioning

Chapter 4: Software

Chapter 5: Standards and certifications

Chapter 6: Accessories

Chapter 7: Servicing and maintenance

Appendix A

Chapter 1 General information.....	8
1 Manual history.....	9
2 Safety guidelines.....	11
2.1 Intended use.....	11
2.2 Protection against electrostatic discharge.....	11
2.2.1 Packaging.....	11
2.2.2 Guidelines for proper ESD handling.....	11
2.3 Policies and procedures.....	11
2.4 Transport and storage.....	12
2.5 Installation.....	12
2.6 Operation.....	12
2.6.1 Protection against touching electrical parts.....	12
2.6.2 Environmental conditions - Dust, moisture, corrosive gases.....	12
2.6.3 Viruses and dangerous programs.....	13
2.7 Environmentally friendly disposal.....	13
2.7.1 Separation of materials.....	13
2.8 Security concept.....	13
2.9 Third-party software updates.....	13
2.10 Administrator accounts.....	13
3 Organization of safety notices.....	14
4 Guidelines.....	14
5 Overview.....	15
 Chapter 2 Technical data.....	 17
1 Introduction.....	17
1.1 About this user's manual.....	17
1.2 Easy customization.....	17
1.3 Description of individual modules.....	18
1.3.1 Panels.....	18
1.3.2 Link modules.....	18
1.3.3 Mounting units.....	18
1.3.4 Flanges.....	19
1.3.5 Expansion units.....	19
1.3.6 Handles.....	19
1.4 System components / Configuration.....	20
1.4.1 Configuration.....	20
2 Complete system.....	22
2.1 Connection options.....	22
2.1.1 SDL operation.....	22
2.1.2 DVI operation.....	24
2.1.3 SDL3 mode.....	25
2.1.4 SDL4 operation.....	26
2.2 Mechanical properties.....	27
2.2.1 Dimensions.....	27
2.2.2 Mounting orientations.....	36
2.2.3 Weight.....	37
2.3 Environmental characteristics.....	39
2.3.1 Temperature specifications.....	39
2.3.2 Relative humidity.....	43
2.3.3 Vibration.....	43
2.3.4 Shock.....	43
2.3.5 Protection.....	44
2.4 Electrical characteristics.....	45
2.4.1 +24 VDC power supply.....	45
2.4.2 Power calculation.....	46
2.4.3 Block diagrams.....	47
2.5 SDL/DVI receiver - 5DLSDL.1001-00 device interfaces.....	48

2.5.1 Overview.....	48
2.5.2 +24 VDC power supply.....	49
2.5.3 Panel In interface.....	50
2.5.4 USB interfaces.....	52
2.5.5 USB In interface.....	53
2.5.6 COM serial interface.....	53
2.5.7 Brightness controls.....	53
2.6 5DLSD3.1001-00 SDL3 receiver - Device interfaces.....	54
2.6.1 Overview.....	54
2.6.2 +24 VDC power supply.....	55
2.6.3 SDL3 In interface.....	56
2.6.4 SDL3 In LEDs.....	56
2.6.5 USB interfaces.....	57
2.7 5DLSD4.1001-00 SDL4 receiver - Device interfaces.....	58
2.7.1 Overview.....	58
2.7.2 +24 VDC power supply.....	59
2.7.3 SDL4 In interface.....	60
2.7.4 SDL4 In LEDs.....	60
2.7.5 USB interfaces.....	61
2.8 Equipping panels with expansion units.....	62
2.8.1 Button/Switching elements.....	62
2.8.2 Button, switch and LED configuration.....	62
2.8.3 USB interface.....	65
2.8.4 Button/Switch interface.....	66
3 Individual components.....	67
3.1 Panels.....	67
3.1.1 5AP5120.1505-000.....	67
3.1.2 5AP5120.1906-000.....	70
3.1.3 5AP5130.156B-000.....	72
3.1.4 5AP5130.156C-000.....	74
3.1.5 5AP5130.185B-000.....	76
3.1.6 5AP5130.185C-000.....	78
3.1.7 5AP5130.215C-000.....	80
3.1.8 5AP5130.240C-000.....	82
3.1.9 5AP5230.156B-000.....	84
3.1.10 5AP5230.156C-000.....	87
3.1.11 5AP5230.185B-000.....	90
3.1.12 5AP5230.185C-000.....	93
3.1.13 5AP5230.215C-000.....	96
3.1.14 5AP5230.215I-000.....	99
3.1.15 5AP5230.240C-000.....	102
3.2 Link modules.....	105
3.2.1 5DLSD4.1001-00.....	105
3.2.2 5DLSD3.1001-00.....	107
3.2.3 5DLSDL.1001-00.....	109
3.3 Mounting units.....	111
3.3.1 5ACCMA00.0000-000.....	111
3.3.2 5ACCMA00.0001-000.....	112
3.3.3 5ACCMA00.0002-000.....	114
3.3.4 5ACCMA01.0100-000.....	116
3.4 Flange.....	117
3.4.1 5ACCFL00.0000-000.....	117
3.4.2 5ACCFL00.0200-000.....	119
3.5 Expansion units.....	120
3.5.1 5ACCKP00.xxxx-000.....	120
3.5.2 5ACCKP01.xxxx-000.....	122
3.5.3 5ACCKP04.xxxx-000.....	124

3.6 Handles.....	127
3.6.1 5ACC HD0x.xxxx-000.....	127
Chapter 3 Commissioning.....	129
1 Installation.....	129
1.1 Important information concerning installation/commissioning.....	129
1.2 Automation Panel 5000 - Installation.....	131
1.2.1 Installation with flange.....	131
1.3 Removing the mounting unit cover.....	134
1.4 Removing the link module.....	135
1.5 Installing the 5ACCFL00.0000-000 rotary flange.....	136
1.6 Removing the swing arm mounting unit.....	138
1.7 Installing the swing arm mounting unit.....	140
1.8 Removing the VESA mounting unit.....	142
1.9 Installing the VESA mounting unit.....	143
1.10 Installing the handles.....	144
1.11 Removing the expansion unit / expansion cover.....	145
1.12 Installing the expansion unit / expansion cover.....	147
1.13 Installing operating elements on the expansion cover.....	148
1.14 Replacing colored lenses.....	150
2 Connecting to the power grid.....	151
2.1 Installing the DC power cable.....	151
2.1.1 Wiring.....	151
2.2 Connecting the power supply to a B&R device.....	152
2.3 Functional ground - Grounding concept.....	153
3 Cable connections.....	154
3.1 Connecting with SDL cables.....	154
4 Switching on the device for the first time.....	155
4.1 General information before switching on the device.....	155
4.2 Switching on the Automation Panel.....	155
5 Touch screen calibration.....	156
5.1 Single-touch (analog resistive).....	156
5.1.1 Windows 10 IoT Enterprise 2016 LTSB.....	156
5.1.2 Windows 10 IoT Enterprise 2015 LTSB.....	156
5.1.3 Windows Embedded 8.1 Industry Pro.....	156
5.1.4 Windows 7 Professional / Ultimate.....	156
5.1.5 Windows Embedded Standard 7 Embedded / Premium.....	156
5.1.6 Windows XP Professional.....	156
5.1.7 Windows Embedded Standard 2009.....	156
5.2 Multi-touch (projected capacitive - PCT).....	157
5.2.1 Windows 10 IoT Enterprise 2016 LTSB.....	157
5.2.2 Windows 10 IoT Enterprise 2015 LTSB.....	157
5.2.3 Windows Embedded 8.1 Industry Pro.....	157
5.2.4 Windows 7 Professional / Ultimate.....	157
5.2.5 Windows Embedded Standard 7 Premium.....	157
6 Adjusting the display brightness.....	158
6.1 Adjusting in SDL / SDL3 / SDL4 mode.....	158
6.2 Adjusting in DVI mode.....	158
Chapter 4 Software.....	159
1 Upgrade information.....	159
1.1 Upgrading the firmware on the Automation Panel.....	159
2 Multi-touch drivers.....	159
3 Automation Runtime.....	160
3.1 General information.....	160
3.2 System requirements.....	160
4 B&R Automation Device Interface (ADI) Control Center.....	161

4.1 Functions.....	161
4.2 Installation.....	162
5 B&R Automation Device Interface (ADI) Development Kit.....	163
6 B&R Automation Device Interface (ADI) .NET SDK.....	164
7 B&R Key Editor.....	165
8 B&R KCF Editor.....	166
9 HMI Service Center.....	167
9.1 5SWUTI.0001-000.....	167
9.1.1 General information.....	167
9.1.2 Order data.....	167
Chapter 5 Standards and certifications.....	168
1 Standards and guidelines.....	168
1.1 CE marking.....	168
1.2 EMC directive.....	168
2 Certifications.....	169
2.1 UL certification.....	169
2.2 GOST-R.....	169
2.3 EAC.....	169
2.4 KC.....	169
2.5 RCM.....	170
Chapter 6 Accessories.....	171
1 Power connectors.....	171
1.1 0TB103.9x.....	171
1.1.1 General information.....	171
1.1.2 Order data.....	171
1.1.3 Technical data.....	171
2 USB flash drives.....	173
2.1 5MMUSB.xxxx-01.....	173
2.1.1 General information.....	173
2.1.2 Order data.....	173
2.1.3 Technical data.....	173
2.1.4 Temperature/Humidity diagram.....	174
2.2 5MMUSB.032G-02.....	175
2.2.1 General information.....	175
2.2.2 Order data.....	175
2.2.3 Technical data.....	175
2.2.4 Temperature/Humidity diagram.....	176
3 Cables.....	177
3.1 DVI cables.....	177
3.1.1 5CADVI.0xxx-00.....	177
3.2 SDL cables.....	180
3.2.1 5CASDL.0xxx-00.....	180
3.3 SDL cables with 45° male connector.....	183
3.3.1 5CASDL.0xxx-01.....	183
3.4 SDL flex cables.....	186
3.4.1 5CASDL.0xxx-03.....	186
3.5 SDL3/SDL4 cables.....	190
3.5.1 5CASD3.xxxx-00.....	190
3.6 USB cables.....	194
3.6.1 5CAUSB.00xx-00.....	194
3.7 RS232 cables.....	196
3.7.1 9A0014.xx.....	196
Chapter 7 Servicing and maintenance.....	198
1 Cleaning.....	198

2 Tips for extending the service life of the display.....	199
2.1 Backlight.....	199
2.1.1 How can the service life of backlights be extended?.....	199
2.2 Image persistence.....	199
2.2.1 What causes image persistence?.....	199
2.2.2 How can image persistence be reduced?.....	199
3 Pixel errors.....	199
4 Repairs, complaints and replacement parts.....	199

Appendix A 200

1 Abbreviations.....	200
2 Viewing angles.....	200
3 Chemical resistance.....	201
3.1 Autotex panel overlay (polyester).....	202
3.2 Coated aluminum front.....	202
3.3 Touch screen.....	203
4 Features.....	204
4.1 Pushbutton RAFIX 22 FS+, 1.30.270.021/2300.....	204
4.2 Pushbutton RAFIX 22 FS+, 1.30.270.021/2500.....	204
4.3 Pushbutton RAFIX 22 FS+, 1.30.270.021/2600.....	204
4.4 Selector switch RAFIX 22 FS+, 1.30.272.102/2200.....	204
4.5 Key switch RAFIX 22 FS+, 1.30.255.222/0000.....	205
4.6 Emergency stop RAFIX 22 FS+ "Plus 1", 1.30.273.512/0300.....	205
4.7 Switching element RAFIX 22 FS universal, 1.20.126.005/0000.....	205
4.8 Switching element RAFIX 22 FS+ PCB gold, 1.20.126.414/0000.....	205
4.9 5ACCSE00.000x-00x.....	207
4.9.1 5ACCSE00.0000-000.....	207
4.9.2 5ACCSE00.0000-001.....	209
4.9.3 5ACCSE00.0001-000.....	210
4.9.4 5ACCSE00.0002-000.....	211
4.9.5 5ACCSE00.0003-000.....	212
4.9.6 5ACCSE00.0004-000.....	213
4.9.7 5ACCSE00.0005-000.....	214
5 Touch screen.....	215
5.1 5-wire AMT touch screen (single-touch).....	215
5.1.1 Technical data.....	215
5.1.2 Temperature/Humidity diagram.....	215
5.2 3M touch screen (multi-touch generation 3).....	216
5.2.1 Technical data.....	216
5.2.2 Temperature/Humidity diagram.....	216

Chapter 1 • General information

Information:

This user's manual is not intended for end customers! It is the responsibility of the machine manufacturer or system provider to provide the safety guidelines relevant to end customers in the operating instructions for the end customer in the respective local language.

1 Manual history

Version	Date	Change
1.00	2016-06-20	<ul style="list-style-type: none"> • First version
1.05	2016-11-30	<ul style="list-style-type: none"> • Renamed "display units" to "panels". • Updated the following panels: <ul style="list-style-type: none"> ◦ "5AP5120.1505-000" on page 67 ◦ "5AP5120.1906-000" on page 70 ◦ "5AP5230.156B-000" on page 84 ◦ "5AP5130.185B-000" on page 76 ◦ "5AP5230.185B-000" on page 90 ◦ "5AP5130.215C-000" on page 80 ◦ "5AP5230.215I-000" on page 99 • Updated VESA mounting unit "5ACCMA01.0100-000" on page 116. • Updated the following expansion units to 5ACCKP01.xxxx-000: <ul style="list-style-type: none"> ◦ 5ACCKP01.156B-000 ◦ 5ACCKP01.185B-000 ◦ 5ACCKP01.215I-000 • Updated the following expansion covers to 5ACCKP00.xxxx-000: <ul style="list-style-type: none"> ◦ 5ACCKP00.156B-000 ◦ 5ACCKP00.185B-000 ◦ 5ACCKP00.215I-000 • Updated the following handles to 5ACCHD0x.xxxx-000: <ul style="list-style-type: none"> ◦ 5ACCHD00.1505-000 ◦ 5ACCHD00.185B-000 ◦ 5ACCHD00.1906-000 ◦ 5ACCHD00.215C-000 ◦ 5ACCHD01.156B-000 ◦ 5ACCHD01.185B-000 ◦ 5ACCHD01.215I-000 • Updated section "Installation" on page 129. • Updated data in sections "Mechanical properties", "Environmental characteristics" and "Electrical characteristics". • Updated the following features: <ul style="list-style-type: none"> ◦ "5ACCSE00.0000-000" on page 207 ◦ "5ACCSE00.0001-000" on page 210 ◦ "5ACCSE00.0002-000" on page 211 ◦ "5ACCSE00.0003-000" on page 212 ◦ "5ACCSE00.0004-000" on page 213 ◦ "5ACCSE00.0005-000" on page 214
1.06	2017-10-25	<ul style="list-style-type: none"> • Documented expansion units "5ACCKP04.xxxx-000" on page 124. • Documented mounting unit "5ACCMA00.0002-000" on page 114. • Documented feature "5ACCSE00.0000-001" on page 209. • Renamed "emergency switch-off" to "emergency stop". • Updated the following sections: <ul style="list-style-type: none"> ◦ "Touch screen calibration" on page 156 ◦ "Features" on page 204 ◦ "Multi-touch drivers" on page 159 • Revised section "Installation" on page 129. • Updated the following sections: <ul style="list-style-type: none"> ◦ "B&R Automation Device Interface (ADI) Control Center" on page 161 ◦ "B&R Automation Device Interface (ADI) Development Kit" on page 163 ◦ "B&R Automation Device Interface (ADI) .NET SDK" on page 164 ◦ "B&R Key Editor" on page 165 ◦ "B&R KCF Editor" on page 166 ◦ "HMI Service Center" on page 167 ◦ "Repairs, complaints and replacement parts" on page 199

Version	Date	Change
1.10	2018-03-15	<ul style="list-style-type: none">• Updated section "Configuration" on page 20.• Updated chapter Technical data.• Updated the following individual components:<ul style="list-style-type: none">◦ "5AP5130.156C-000" on page 74◦ "5AP5130.185C-000" on page 78◦ "5AP5230.156C-000" on page 87◦ "5AP5230.185C-000" on page 93◦ "5DLSD4.1001-00" on page 105• Updated section "Important information concerning installation/commissioning" on page 129.• Updated the following sections:<ul style="list-style-type: none">◦ "Adjusting the display brightness" on page 158◦ "Adjusting in SDL / SDL3 / SDL4 mode" on page 158◦ "Upgrading the firmware on the Automation Panel" on page 159

2 Safety guidelines

2.1 Intended use

Programmable logic controllers (PLCs), operating/monitoring devices (industrial PCs, Power Panels, Mobile Panels, etc.) and uninterruptible power supplies from B&R have been designed, developed and manufactured for conventional use in industrial environments. They were not designed, developed and manufactured for any use involving serious risks or hazards that could lead to death, injury, serious physical impairment or loss of any kind without the implementation of exceptionally stringent safety precautions. In particular, this includes the use of these devices to monitor nuclear reactions in nuclear power plants, in flight control or flight safety systems as well as in the control of mass transportation systems, medical life support systems or weapons systems.

2.2 Protection against electrostatic discharge

Electrical components that can be damaged by electrostatic discharge (ESD) must be handled accordingly.

2.2.1 Packaging

- **Electrical components with a housing**
...do not require special ESD packaging but must be handled properly (see "Electrical components with a housing").
- **Electrical components without a housing**
...are protected by ESD-suitable packaging.

2.2.2 Guidelines for proper ESD handling

Electrical components with a housing

- Do not touch the connector contacts on connected cables.
- Do not touch the contact tips on circuit boards.

Electrical components without a housing

The following points apply in addition to the points listed under "Electrical components with a housing":

- Any persons handling electrical components or devices with installed electrical components must be grounded.
- Components are only permitted to be touched on their narrow sides or front plate.
- Components must always be placed on or stored in a suitable medium (ESD packaging, conductive foam, etc.). Metallic surfaces are not suitable storage surfaces!
- Components must not be subjected to electrostatic discharge (e.g. caused by charged plastics).
- Observe a minimum distance of 10 cm from monitors and television sets.
- Measuring instruments and equipment must be grounded.
- Probe tips of galvanically isolated measuring instruments must be temporarily discharged on suitably grounded surfaces before taking measurements.

Individual components

- ESD protective measures for individual components are thoroughly implemented at B&R (conductive floors, footwear, arm bands, etc.).
- Increased ESD protective measures for individual components are not required for handling B&R products at customer locations.

2.3 Policies and procedures

Electronic devices are never completely failsafe. If the programmable logic controller, operating/monitoring device or uninterruptible power supply fails, the user is responsible for ensuring that other connected devices such as motors are brought to a safe state.

When using programmable logic controllers or operating/monitoring devices as control systems in connection with a Soft PLC (e.g. B&R Automation Runtime or comparable product) or Slot PLC (e.g. B&R LS251 or comparable product), safety precautions relevant to industrial control systems (e.g. the provision of safety devices such as emergency stop, etc.) must be observed in accordance with applicable national and international regulations. This also applies to all other devices connected to the system, such as drives.

All tasks such as the installation, commissioning and servicing of devices are only permitted to be carried out by qualified personnel. Qualified personnel are those familiar with the transport, mounting, installation, commissioning and operation of devices who also have the appropriate qualifications to perform these tasks (e.g. IEC 60364). National accident prevention regulations must be observed.

The safety notices, information about connection conditions (nameplate and documentation) and limit values specified in the technical data must be read carefully before installation and commissioning and are to be observed in all cases.

2.4 Transport and storage

During transport and storage, devices must be protected against undue stress (mechanical loads, temperature, moisture, corrosive atmospheres, etc.).

2.5 Installation

- Devices are not ready for use immediately upon delivery. They must be installed and wired according to the requirements of this documentation in order for EMC limit values to be observed.
- Installation must be performed according to this documentation using suitable equipment and tools.
- Devices are only permitted to be installed by qualified personnel and when the power is switched off. Before installation, voltage to the control cabinet must be switched off and prevented from being switched on again.
- General safety guidelines and national accident prevention regulations must be observed.
- Electrical installation must be carried out in accordance with applicable guidelines (e.g. wire cross sections, fuses, protective ground connections).

2.6 Operation

2.6.1 Protection against touching electrical parts

To operate programmable logic controllers, operating/monitoring devices and uninterruptible power supplies, certain components must carry dangerous voltage levels over 42 VDC. Touching one of these components can result in a life-threatening electric shock. This could lead to death, severe injury or damage to property.

Before switching on programmable logic controllers, operating/monitoring devices or the uninterruptible power supply, it must be ensured that the housing is properly connected to ground (PE rail). Ground connections must also be established when the operating/monitoring device or uninterruptible power supply is connected for test purposes or only being operated for a short period of time!

Before switching on the device, all voltage-carrying components must be securely covered. During operation, all covers must remain closed.

2.6.2 Environmental conditions - Dust, moisture, corrosive gases

The use of operating/monitoring devices (e.g. industrial PCs, Power Panels, Mobile Panels) and uninterruptible power supplies in very dusty environments must be avoided. The collection of dust on devices can affect functionality and may prevent sufficient cooling, especially in systems with active cooling (fans).

The presence of corrosive gases can also result in impaired functionality. In combination with high temperature and humidity, corrosive gases – e.g. with sulfur, nitrogen and chlorine components – can induce chemical reactions that can damage electronic components very quickly. The presence of corrosive gases is indicated by blackened copper surfaces and cable ends on existing installations.

When operated in dusty or moist environments that could potentially impair functionality, operating/monitoring devices such as the Automation Panel and Power Panel are protected on the front against the ingress of dust or moisture when installed properly (e.g. cutout installation). The back of all devices must be protected from the ingress of dust and moisture, however; any collected dust must be removed at suitable intervals.

2.6.3 Viruses and dangerous programs

This system is subject to potential risk each time data is exchanged or software is installed from a data storage device (e.g. diskette, CD-ROM, USB flash drive, etc.), network connection or the Internet. The user is responsible for assessing these risks, implementing preventive measures such as virus protection programs, firewalls, etc. and making sure that software is obtained only from trusted sources.

2.7 Environmentally friendly disposal

All programmable controllers, operating/monitoring devices and uninterruptible power supplies from B&R are designed to minimize harm to the environment as far as possible.

2.7.1 Separation of materials

It is necessary to separate out the different materials so that devices can undergo an environmentally friendly recycling process.

Component	Disposal
Programmable logic controllers Operating/Monitoring devices Uninterruptible power supply Batteries and rechargeable batteries Cables	Electronics recycling
Cardboard/Paper packaging	Paper/Cardboard recycling
Plastic packaging material	Plastic recycling

Table 1: Environmentally friendly disposal

Disposal must take place in accordance with applicable legal regulations.

2.8 Security concept

To protect plants, systems, machines and networks against cyber threats, it is necessary to implement (and continuously maintain) an integrated security concept that is state of the art. B&R products and solutions form only one part of such a concept.

The user is responsible for preventing unauthorized access to his plants, systems, machines and networks. Systems, machines and components should only be connected to the corporate network or Internet if and to the extent necessary and appropriate protective measures (e.g. use of firewalls and network segmentation) have been taken.

B&R products and solutions are constantly being developed further to make them even more secure. B&R strongly recommends that updates be performed as soon as the corresponding updates are available and that only the latest product versions are used. Using outdated or unsupported versions can increase the risk of cyber threats.

2.9 Third-party software updates

This product contains third-party software (e.g. drivers, etc.). B&R only assumes warranty for updates/patches to the third-party software if they have been officially released by B&R. Otherwise, updates/patches are undertaken at your own risk.

2.10 Administrator accounts

A user with administrator rights has extensive access and manipulation options available on the system.

Therefore, make sure that your administrator accounts are adequately secured to prevent unauthorized changes. Use secure passwords and a standard user account for regular operation. Further measures such as the use of security guidelines are to be applied as needed.

3 Organization of safety notices

Safety notices in this manual are organized as follows:

Safety notice	Description
Danger!	Failure to observe these safety guidelines and notices can result in death, severe injury or substantial damage to property.
Warning!	Failure to observe these safety guidelines and notices can result in severe injury or substantial damage to property.
Caution!	Failure to observe these safety guidelines and notices can result in injury or damage to property.
Information:	These instructions are important for avoiding malfunctions.

Table 2: Description of the safety notices used in this documentation

4 Guidelines

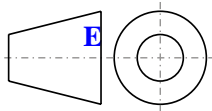

European dimension standards apply to all dimension diagrams.

All dimensions are specified in mm.

Unless otherwise specified, the following general tolerances apply:

Range of nominal size	General tolerance per DIN ISO 2768 (medium)
Up to 6 mm	±0.1 mm
6 to 30 mm	±0.2 mm
30 to 120 mm	±0.3 mm
120 to 400 mm	±0.5 mm
400 to 1000 mm	±0.8 mm

Table 3: Range of nominal sizes

5 Overview

Model number	Short description	Page
Accessories		
0TB103.9	Connector 24 VDC - 3-pin female - Screw clamp terminal block 3.31 mm ²	171
0TB103.91	Connector 24 VDC - 3-pin female - Cage clamp terminal block 3.31 mm ²	171
5SWUTI.0001-000	HMI Service Center USB flash drive - Hardware diagnostic software - For APC810/PPC800 - For APC910/PPC900 - For APC2100/PPC2100 - For APC3100/PPC3100 - For APC51x/PP500 - For Automation Panel 800/900	167
DVI cables		
5CADVI.0018-00	DVI-D cable - 1.8 m	177
5CADVI.0050-00	DVI-D cable - 5 m	177
5CADVI.0100-00	DVI-D cable - 10 m	177
Expansion units		
5ACCKP00.156B-000	AP5000 swing arm expansion option - Expansion cover - For switching elements - 10x cutouts for 22.3 mm switching elements - For panel 5AP5230.156B-000	120
5ACCKP00.185B-000	AP5000 swing arm expansion option - Expansion cover - For switching elements - 11x cutouts for 22.3 mm switching elements - For panel 5AP5230.185B-000	120
5ACCKP00.215C-000	AP5000 swing arm expansion option - Expansion cover - For switching elements - 13x cutouts for 22.3 mm switching elements - For panel 5AP5230.215C-000	120
5ACCKP00.215I-000	AP5000 swing arm expansion option - Expansion cover - For switching elements - 7x cutouts for 22.3 mm switching elements - For panel 5AP5230.215I-000	120
5ACCKP00.240C-000	AP5000 swing arm expansion option - Expansion cover - For switching elements - 14x cutouts for 22.3 mm switching elements - For panel 5AP5230.240C-000	120
5ACCKP01.156B-000	AP5000 swing arm expansion option - Expansion unit - 1x emergency stop - 2x pushbutton (red and green) - 1x selector switch - 1x key switch - 1x front USB interface - For panel 5AP5230.156B-000	122
5ACCKP01.185B-000	AP5000 swing arm expansion option - Expansion unit - 1x emergency stop - 2x pushbutton (red and green) - 1x selector switch - 1x key switch - 1x front USB interface - For panel 5AP5230.185B-000	122
5ACCKP01.215C-000	AP5000 swing arm expansion option - Expansion unit - 1x emergency stop - 2x pushbutton (red and green) - 1x selector switch - 1x key switch - 1x front USB interface - For panel 5AP5230.215C-000	122
5ACCKP01.215I-000	AP5000 swing arm expansion option - Expansion unit - 1x emergency stop - 2x pushbutton (red and green) - 1x selector switch - 1x key switch - 1x front USB interface - For panel 5AP5230.215I-000	122
5ACCKP01.240C-000	AP5000 swing arm expansion option - Expansion unit - 1x emergency stop - 2x pushbutton (red and green) - 1x selector switch - 1x key switch - 1x front USB interface - For panel 5AP5230.240C-000	122
5ACCKP04.156B-000	AP5000 swing arm expansion option - Expansion unit - 1x emergency stop - 3x pushbutton (red, green, blue) - 1x key switch - 1x front USB interface - For panel 5AP5230.156B-000	124
5ACCKP04.185B-000	AP5000 swing arm expansion option - Expansion unit - 1x emergency stop - 3x pushbutton (red, green, blue) - 1x key switch - 1x front USB interface - For panel 5AP5230.185B-000	124
5ACCKP04.215C-000	AP5000 swing arm expansion option - Expansion unit - 1x emergency stop - 3x pushbutton (red, green, blue) - 1x key switch - 1x front USB interface - For panel 5AP5230.215C-000	124
5ACCKP04.215I-000	AP5000 swing arm expansion option - Expansion unit - 1x emergency stop - 3x pushbutton (red, green, blue) - 1x key switch - 1x front USB interface - For panel 5AP5230.215I-000	124
5ACCKP04.240C-000	AP5000 swing arm expansion option - Expansion unit - 1x emergency stop - 3x pushbutton (red, green, blue) - 1x key switch - 1x front USB interface - For panel 5AP5230.240C-000	124
Flange		
5ACCF00.0000-000	AP5000 flange - Swing arm rotary flange - For swing arm mounting unit	117
5ACCF00.0200-000	AP5000 flange - Swing arm flange adapter - For Rittal - For swing arm mounting unit	119
Handles		
5ACCHD00.1505-000	AP5000 swing arm handles - For panel 5AP5120.1505-000	127
5ACCHD00.156B-000	AP5000 swing arm handles - For panel 5AP5130.156B-000	127
5ACCHD00.185B-000	AP5000 swing arm handles - For panel 5AP5130.185B-000	127
5ACCHD00.1906-000	AP5000 swing arm handles - For panel 5AP5120.1906-000	127
5ACCHD00.215C-000	AP5000 swing arm handles - For panel 5AP5130.215C-000	127
5ACCHD00.240C-000	AP5000 swing arm handles - For panel 5AP5130.240C-000	127
5ACCHD01.156B-000	AP5000 swing arm handles - For panel 5AP5230.156B-000	127
5ACCHD01.185B-000	AP5000 swing arm handles - For panel 5AP5230.185B-000	127
5ACCHD01.215C-000	AP5000 swing arm handles - For panel 5AP5230.215C-000	127
5ACCHD01.215I-000	AP5000 swing arm handles - For panel 5AP5230.215I-000	127
5ACCHD01.240C-000	AP5000 swing arm handles - For panel 5AP5230.240C-000	127
Link modules		
5DLS3.1001-00	Automation Panel link module - SDL3 receiver - For Automation Panel 923/933/1000 - For Automation Panel 5000	107
5DLS4.1001-00	Automation Panel link module - SDL4 receiver - For Automation Panel 923/933/1000 - For Automation Panel 5000	105
5DLSL.1001-00	Automation Panel link module - SDL/DVI receiver - For Automation Panel 923/933/1000 - For Automation Panel 5000	109
Mounting units		
5ACCMA00.0000-000	AP5000 swing arm mounting unit	111
5ACCMA00.0001-000	AP5000 swing arm mounting unit - 1x rear USB interface	112
5ACCMA01.0100-000	AP5000 VESA mounting unit IP20	116
Panels		
5AP5120.1505-000	Automation Panel 15.0" XGA TFT - 1024 x 768 pixels (4:3) - Single-touch (analog resistive) - Swing arm mounting - Landscape format - For PPC2100 / link modules	67
5AP5120.1906-000	Automation Panel 19.0" SXGA TFT - 1280 x 1024 pixels (5:4) - Single-touch (analog resistive) - Swing arm mounting - Landscape format - For PPC2100 / link modules	70
5AP5130.156B-000	Automation Panel 15.6" HD TFT - 1366 x 768 pixels (16:9) - Multi-touch (projected capacitive) - Swing arm mounting - Landscape format - For PPC2100 / link modules	72

Model number	Short description	Page
5AP5130.156C-000	Automation Panel 15.6" Full HD TFT - 1920 x 1080 pixels (16:9) - Multi-touch (projected capacitive) - Swing arm mounting - Landscape format - For PPC2100 / PPC2200 / link modules	74
5AP5130.185B-000	Automation Panel 18.5" HD TFT - 1366 x 768 pixels (16:9) - Multi-touch (projected capacitive) - Swing arm mounting - Landscape format - For PPC2100 / link modules	76
5AP5130.185C-000	Automation Panel 18.5" Full HD TFT - 1920 x 1080 pixels (16:9) - Multi-touch (projected capacitive) - Swing arm mounting - Landscape format - For PPC2100 / PPC2200 / link modules	78
5AP5130.215C-000	Automation Panel 21.5" Full HD TFT - 1920 x 1080 pixels (16:9) - Multi-touch (projected capacitive) - Swing arm mounting - Landscape format - For PPC900 / PPC2100 / link modules	80
5AP5130.240C-000	Automation Panel 24.0" Full HD TFT - 1920 x 1080 pixels (16:9) - Multi-touch (projected capacitive) - Swing arm mounting - Landscape format - For PPC900 / PPC2100 / link modules	82
5AP5230.156B-000	Automation Panel 15.6" HD TFT - 1366 x 768 pixels (16:9) - Multi-touch (projected capacitive) - Swing arm mounting - Landscape format - Expansion option - For PPC2100 / link modules	84
5AP5230.156C-000	Automation Panel 15.6" Full HD TFT - 1920 x 1080 pixels (16:9) - Multi-touch (projected capacitive) - Swing arm mounting - Landscape format - Expansion option - For PPC2100 / PPC2200 / link modules	87
5AP5230.185B-000	Automation Panel 18.5" HD TFT - 1366 x 768 pixels (16:9) - Multi-touch (projected capacitive) - Swing arm mounting - Landscape format - Expansion option - For PPC2100 / link modules	90
5AP5230.185C-000	Automation Panel 18.5" Full HD TFT - 1920 x 1080 pixels (16:9) - Multi-touch (projected capacitive) - Swing arm mounting - Landscape format - Expansion option - For PPC2100 / PPC2200 / link modules	93
5AP5230.215C-000	Automation Panel 21.5" Full HD TFT - 1920 x 1080 pixels (16:9) - Multi-touch (projected capacitive) - Swing arm mounting - Landscape format - Expansion option - For PPC900 / PPC2100 / link modules	96
5AP5230.215I-000	Automation Panel 21.5" Full HD TFT - 1920 x 1080 pixels (16:9) - Multi-touch (projected capacitive) - Swing arm mounting - Portrait format - Expansion option - For PPC2100 / link modules	99
5AP5230.240C-000	Automation Panel 24.0" Full HD TFT - 1920 x 1080 pixels (16:9) - Multi-touch (projected capacitive) - Swing arm mounting - Landscape format - Expansion option - For PPC900 / PPC2100 / link modules	102
RS232 cables		
9A0014.02	RS232 extension cable for operation of a remote display unit with touch screen, 1.8 m	196
9A0014.05	RS232 extension cable for operation of a remote display unit with touch screen, 5 m	196
9A0014.10	RS232 extension cable for operation of a remote display unit with touch screen, 10 m	196
SDL cables		
5CASDL.0008-00	SDL cable - 0.8 m	180
5CASDL.0018-00	SDL cable - 1.8 m	180
5CASDL.0050-00	SDL cable - 5 m	180
5CASDL.0100-00	SDL cable - 10 m	180
5CASDL.0150-00	SDL cable - 15 m	180
5CASDL.0200-00	SDL cable - 20 m	180
5CASDL.0250-00	SDL cable - 25 m	180
5CASDL.0300-00	SDL cable - 30 m	180
SDL cables 45° connection		
5CASDL.0018-01	SDL cable - 45 degree connector - 1.8 m	183
5CASDL.0050-01	SDL cable - 45 degree connector - 5 m	183
5CASDL.0100-01	SDL cable - 45 degree connector - 10 m	183
5CASDL.0150-01	SDL cable - 45 degree connector - 15 m	183
SDL cables flex		
5CASDL.0018-03	SDL flex cable - 1.8 m	186
5CASDL.0050-03	SDL flex cable - 5 m	186
5CASDL.0100-03	SDL flex cable - 10 m	186
5CASDL.0150-03	SDL flex cable - 15 m	186
5CASDL.0200-03	SDL flex cable - 20 m	186
5CASDL.0250-03	SDL flex cable - 25 m	186
5CASDL.0300-03	SDL flex cable - 30 m	186
SDL3/SDL4 cables		
5CASD3.0030-00	SDL3/SDL4 cable - 3 m	190
5CASD3.0050-00	SDL3/SDL4 cable - 5 m	190
5CASD3.0100-00	SDL3/SDL4 cable - 10 m	190
5CASD3.0150-00	SDL3/SDL4 cable - 15 m	190
5CASD3.0200-00	SDL3/SDL4 cable - 20 m	190
5CASD3.0300-00	SDL3/SDL4 cable - 30 m	190
5CASD3.0500-00	SDL3/SDL4 cable - 50 m	190
5CASD3.1000-00	SDL3/SDL4 cable - 100 m	190
Swing arm mounting units		
5ACCMA00.0002-000	AP5000 swing arm mounting unit - 2x rear USB interface	114
USB accessories		
5MMUSB.032G-02	USB 3.0 flash drive 32 GB MLC	175
5MMUSB.2048-01	USB 2.0 flash drive 2048 MB B&R	173
5MMUSB.4096-01	USB 2.0 flash drive 4096 MB B&R	173
USB cables		
5CAUSB.0018-00	USB 2.0 connection cable - Type A - type B connector - 1.8 m	194
5CAUSB.0050-00	USB 2.0 connection cable - Type A - type B connector - 5 m	194

Chapter 2 • Technical data

1 Introduction

1.1 About this user's manual

This user's manual contains all relevant information about an operational Automation Panel 5000 flush-mounted device.

This user's manual applies to the modular Automation Panel 5000 product generation. For information about using the Panel PC 2100 in combination with the Automation Panel 5000, see user's manual "Panel PC 2100 swing arm devices (AP5000)".

1.2 Easy customization

The Automation Panel 5000 can be used as a remote panel or part of a Panel PC. This involves equipping it with either a PC unit or a receiver Smart Display Link (SDL/SDL3). Either way, the operator panel itself is identical.



1.3 Description of individual modules

1.3.1 Panels

Panels form the basis of each Automation Panel 5000 and Panel PC 2100 swing arm device with Automation Panel 5000 panel. They consist of a display and touch screen. A variety of display sizes, touch screen technologies, mounting systems and panels with operating elements are available. The panels units can only be operated as a complete system in combination with a link module (Automation Panel 5000) or system unit (Panel PC 2100 swing arm device with Automation Panel 5000 panel).

Single-touch panels start at model number 5AP5120.xxxx-xxx, multi-touch panels start at 5AP5130.xxxx-xxx and multi-touch panels with expansion option start at model number 5AP5230.xxxx-xxx.

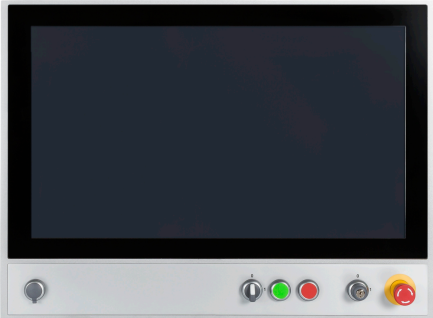

1.3.2 Link modules

Link modules have various graphics interfaces and connections. An Automation Panel is put together by installing a link module onto a panel.

A link module cannot be operated without a panel.



1.3.3 Mounting units

Mounting units are installed on the back of the panel. They serve to protect the installed link module / system unit, enabling IP65, IP20 or IP10 protection for the entire device depending on its variant.

The flange is installed on swing arm mounting unit 5ACCMA00.000x-000. Due to the symmetrical design of the back of the panel, it is possible to install the mounting unit in 2 directions. If a flange is selected for mounting, flange output is possible towards the top or bottom.



The VESA bracket is installed on VESA mounting unit 5ACCMA01.0100-000. If a VESA bracket is selected for mounting, VESA 100 or VESA 75 installation is possible.



1.3.4 Flanges

A flange is installed on the mounting unit and establishes the connection between the Automation Panel or Panel PC and the swing arm system.



1.3.5 Expansion units

Expansion units can be installed on AP5230 panels with expansion option. It is possible to choose between an expansion cover and a standard unit with expansion option. On standard units, the operating elements are already integrated in the expansion unit. Expansion covers have cutouts that can be used to install the desired operating elements at a later time.



1.3.6 Handles

Handles can be installed on the sides of the panel to enable comfortable, ergonomic operation.









1.4 System components / Configuration

Automation Panel 5000 and Panel PC 2100 swing arm (AP5000) systems can be assembled to meet individual requirements and operating conditions. Automation Panel 5000 and Panel PC 2100 swing arm (AP5000) systems are flexible so that an Automation Panel can be converted to a Panel PC, or vice versa.

1.4.1 Configuration

The following individual components are required for an operational Automation Panel 5000:

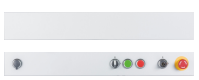
- Panel
- Link module
- Swing arm mounting unit or VESA
- Flange (swing arm mounting unit only)
- Expansion unit (only for AP5230)

Configuration - Base system							
Panels	Select 1						
	Diagonal	Resolution	Touch screen	Keys	Format		
	5120 panels						
	5AP5120.1505-000	15.0"	XGA	Single-touch	No	Landscape	
	5AP5120.1906-000	19.0"	SXGA	Single-touch	No	Landscape	
	5130 panels						
	5AP5130.156B-000	15.6"	HD	Multi-touch	No	Landscape	
	5AP5130.156C-000	15.6"	FHD	Multi-touch	No	Landscape	
	5AP5130.185B-000	18.5"	HD	Multi-touch	No	Landscape	
	5AP5130.185C-000	18.5"	FHD	Multi-touch	No	Landscape	
	5AP5130.215C-000	21.5"	FHD	Multi-touch	No	Landscape	
	5AP5130.240C-000	24.0"	FHD	Multi-touch	No	Landscape	
	5230 panels ¹⁾						
	5AP5230.156B-000	15.6"	HD	Multi-touch	Yes	Landscape	
	5AP5230.156C-000	15.6"	FHD	Multi-touch	Yes	Landscape	
	5AP5230.185B-000	18.5"	HD	Multi-touch	Yes	Landscape	
5AP5230.185C-000	18.5"	FHD	Multi-touch	Yes	Landscape		
5AP5230.215C-000	21.5"	FHD	Multi-touch	Yes	Landscape		
5AP5230.215I-000	21.5"	FHD	Multi-touch	Yes	Portrait		
5AP5230.240C-000	24.0"	FHD	Multi-touch	Yes	Landscape		
Link modules	Select 1						
	5DLSDL.1001-00 SDL/DVI receiver 5D LSD3.1001-00 SDL3 receiver 5D LSD4.1001-00 SDL4 receiver						
Mounting units	Select 1						
	Mounting unit without USB interface 5ACCMA00.0000-000 Mounting unit with USB interface 5ACCMA00.0001-000 Mounting unit with 2x USB interface 5ACCMA00.0002-000 VESA mounting unit 5ACCMA01.0100-000						
Flange ²⁾	Select 1						
	Rotary flange 5ACCF L00.0000-000 Rittal flange adapter 5ACCF L00.0200-000						
Expansion units ¹⁾	Select 1						
	5ACCKP00.156B-000 5ACCKP00.185B-000 5ACCKP00.215C-000 5ACCKP00.215I-000 5ACCKP00.240C-000	5ACCKP01.156B-000 5ACCKP01.185B-000 5ACCKP01.215C-000 5ACCKP01.215I-000 5ACCKP01.240C-000	5ACCKP04.156B-000 5ACCKP04.185B-000 5ACCKP04.215C-000 5ACCKP04.215I-000 5ACCKP04.240C-000				
Handles ³⁾	Select 1						
	5ACCHD00.1505-000 5ACCHD00.156B-000 5ACCHD00.185B-000 5ACCHD00.1906-000 5ACCHD00.215C-000 5ACCHD00.240C-000	5ACCHD01.156B-000 5ACCHD01.185B-000 5ACCHD01.215C-000 5ACCHD01.215I-000 5ACCHD01.240C-000					
Terminal blocks	Select 1						
	Power connectors 0TB103.9 0TB103.91						

- 1) Expansion units can only be combined with AP5230 panels.
- 2) A flange must be selected if a standard mounting unit is used.
- 3) Handles are not factory-installed and must be mounted after delivery.

Figure 1: Automation Panel 5000 - Configuration

2 Complete system

2.1 Connection options

The Automation Panel can be connected to a B&R industrial PC via SDL, DVI SDL3 or SDL4 operations. The connection options described below provide an overview of the operating modes as well as possible limitations.

2.1.1 SDL operation

2.1.1.1 SDL operation - Mode 1

In SDL operating mode 1, all communication between the Automation Panel and B&R industrial PC is handled using a single SDL cable.

In addition to display data, information from the touch screen and matrix keys as well as service and diagnostic data is transferred. The Automation Panel can be installed up to 30 m from the B&R industrial PC. USB 1.1 is also transferred over this distance and fully integrated in SDL. External modules are not necessary for this.

The brightness of the display can be set using the ADI Control Center, for example.

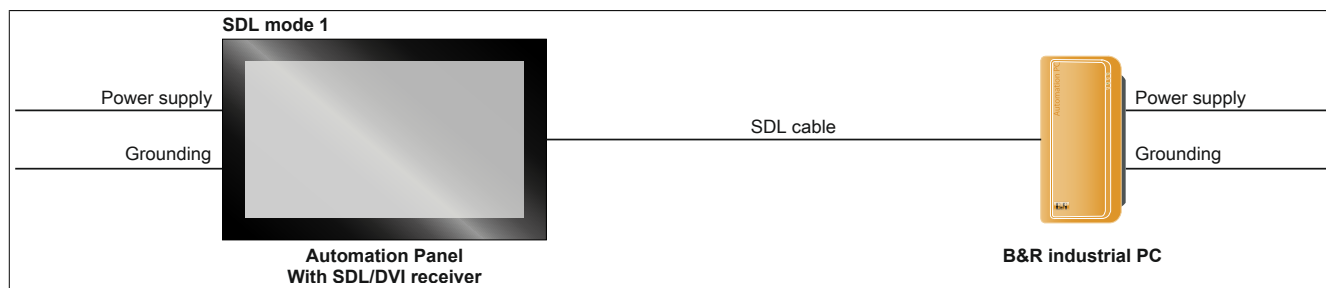

Availability of interfaces on the Automation Panel with SDL/DVI receiver:

Panel In	✓	USB In	✗	Power supply	✓	Brightness controls	✗
USB1, USB2	✓	COM touch screen inter-face	✗	Grounding	✓		

Maximum cable length: 30 m

Requirements

- Automation Panel with SDL/DVI receiver
- B&R industrial PC with SDL interface
- SDL cable

2.1.1.2 SDL operation - Mode 2

In SDL operating mode 2, communication between the Automation Panel and B&R industrial PC is handled using an SDL cable connected to interface "Panel In" and a USB type A/B cable connected to interface "USB In".

In addition to display data, information from the resistive touch screen and matrix keys as well as LED, service and diagnostic data is transferred over the SDL cable. Data from the multi-touch touch screen is transferred over the USB type A/B cable. The Automation Panel can be installed up to 5 m (USB specification) from the B&R industrial PC. USB 2.0 data can be transferred over this distance via the USB type A/B cable. External modules are not necessary for this.

The brightness of the display can be set using the ADI Control Center, for example.

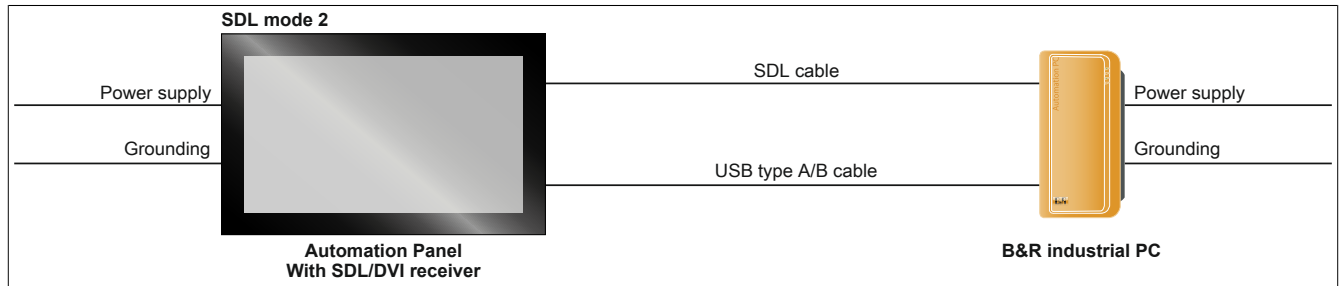

Availability of interfaces on the Automation Panel with SDL/DVI receiver:

Panel In	✓	USB In	✓	USB 2.0	Power supply	✓	Brightness controls	x
USB1, USB2	✓	COM touch screen inter-face	x		Grounding	✓		

Maximum cable length: 5 m

Requirements

- Automation Panel with SDL/DVI receiver
- B&R industrial PC with SDL interface
- SDL cable, USB type A/B cable

2.1.2 DVI operation

In the DVI operating mode, all signals needed to operate the Automation Panel are each transferred over a separate cable. The brightness of the display can be set using the brightness buttons.

2.1.2.1 DVI operation with single-touch Automation Panel

If an Automation Panel with resistive touch screen (single-touch) is operated with DVI, then a DVI cable, USB type A/B cable and RS232 cable must be connected.

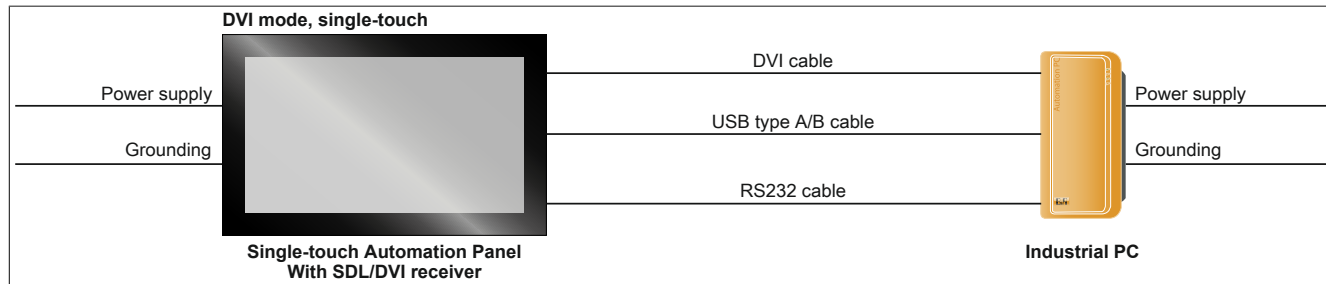

Availability of interfaces on the Automation Panel with SDL/DVI receiver:

Panel In	✓	USB In	✓ USB 2.0	Power supply	✓	Brightness controls	✓
USB1, USB2	✓ USB 2.0	COM touch screen inter-face	✓	Grounding	✓		

Maximum cable length: 5 m

Requirements

- Automation Panel with SDL/DVI receiver
- B&R industrial PC with DVI interface
- DVI cable, USB type A/B cable, RS232 cable

2.1.2.2 DVI mode with multi-touch Automation Panel

If an Automation Panel with PCT touch screen (multi-touch) is operated with DVI, then a DVI cable and USB type A/B cable must be connected.

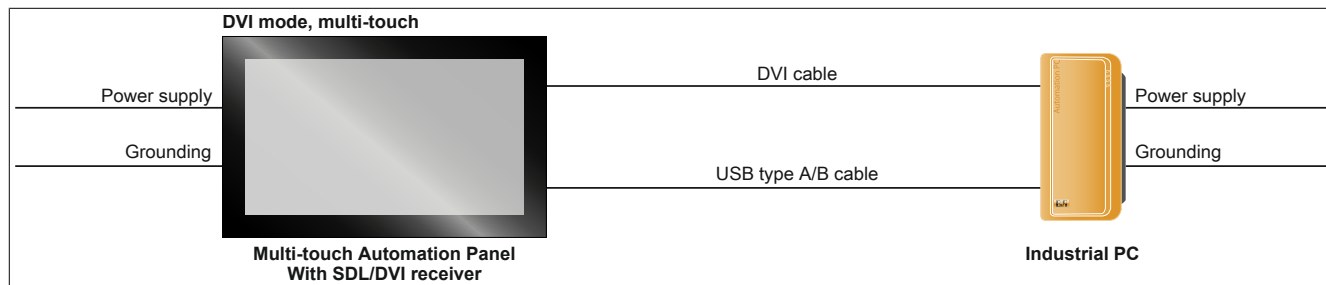

Availability of interfaces on the Automation Panel with SDL/DVI receiver:

Panel In	✓	USB In	✓ USB 2.0	Power supply	✓	Brightness controls	✓
USB1, USB2	✓ USB 2.0	COM touch screen inter-face	x	Grounding	✓		

Maximum cable length: 5 m

Requirements

- Automation Panel with SDL/DVI receiver
- B&R industrial PC with DVI interface
- DVI cable, USB type A/B cable

2.1.2.3 General limitations / Special considerations

- Key and LED data is not transferred.
- Data from operating elements is not transferred.
- Service and diagnostic data is not transferred.
- Maximum cable length is limited to 5 m.
- Upgrading the firmware of Automation Panels is not possible.

2.1.3 SDL3 mode

Smart Display Link 3 (SDL3) technology transfers all communication channels between a B&R industrial PC and panel up to 100 m over a standard Ethernet cable (min. Cat 6a). An RJ45 connector ideal for narrow spaces such as feed-throughs and swing arm system is used to connect to the device.

2.1.3.1 SDL3 mode with SDL3 transmitter

In the SDL3 operating mode with an SDL3 transmitter in the B&R industrial PC, all communication between the Automation Panel and B&R industrial PC is handled using a single SDL3 cable.

In addition to display data, information from the touch screen and matrix keys as well as service and diagnostic data is transferred. The Automation Panel can be installed up to 100 m from the B&R industrial PC. USB 2.0 is also transferred over this distance and fully integrated in SDL3. External modules are not necessary for this.

The brightness of the display can be set using the ADI Control Center.

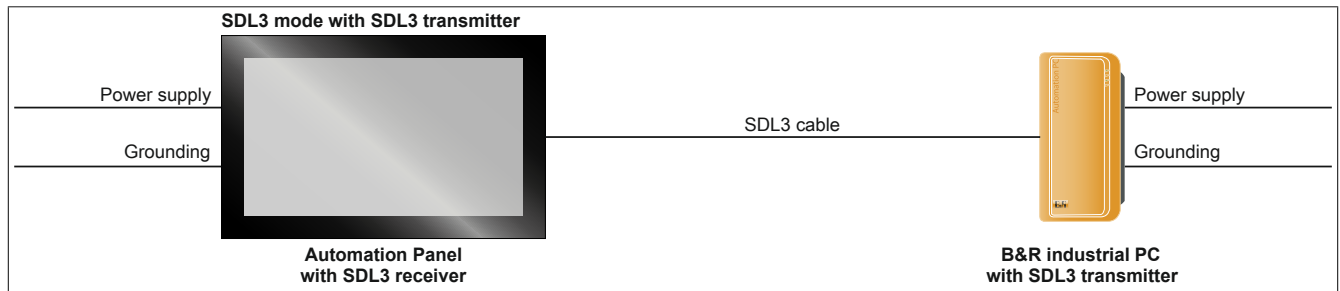

Availability of interfaces on the Automation Panel with SDL3 receiver:

SDL3 interface ✓ USB1, USB2 ✓ USB 2.0 Power supply ✓ Grounding ✓

Maximum cable length of SDL3: 100 m

Requirements

- Automation Panel with SDL3 receiver
- B&R industrial PC with SDL3 interface
- SDL3/SDL4 cable

2.1.3.2 General limitations / Special considerations

- The USB 2.0 transfer rate is limited to 30 Mbit/s with SDL3.
- The SDL3 transmitter constantly emulates a display using EDID data and hot plugging code; this allows DVI-compatible operation. As a result, improperly displayed images are possible during operation with multiple displays. In Windows, a connected panel is registered by the graphics driver even in the following situations:
 - No cable is connected.
 - A connection has not yet been established between the SDL3 link module and the SDL3 transmitter.

These improperly displayed images can be circumvented by making suitable configurations in BIOS or via the graphics driver.

2.1.4 SDL4 operation

Smart Display Link 4 (SDL4) technology transfers all communication channels between a B&R industrial PC and panel up to 100 m over a standard Ethernet cable (min. Cat 6a). An RJ45 connector ideal for narrow spaces such as feed-throughs and swing arm system is used to connect to the device.

2.1.4.1 SDL4 operation with SDL4 transmitter

In the SDL4 operating mode with an SDL4 transmitter in the B&R industrial PC, all communication between the Automation Panel and B&R industrial PC is handled using a single SDL4 cable.

In addition to display data, information from the touch screen and matrix keys as well as service and diagnostic data is transferred. The Automation Panel can be installed up to 100 m from the B&R industrial PC. USB 2.0 is also transferred over this distance and fully integrated in SDL4. External modules are not necessary for this.

The brightness of the display can be set using the ADI Control Center, for example.

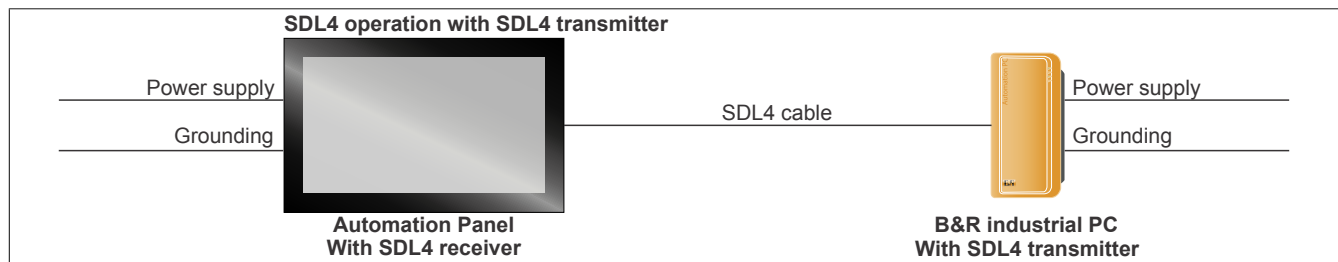

Availability of interfaces on the Automation Panel with SDL4 receiver:

SDL4 interface ✓ USB1, USB2 ✓ USB 2.0 Power supply ✓ Grounding ✓

Maximum cable length of SDL4: 100 m

Requirements

- Automation Panel with SDL4 receiver
- B&R industrial PC with SDL4 interface
- SDL3/SDL4 cable

2.1.4.2 General limitations

- The USB 2.0 transfer rate is limited to 150 Mbit/s with SDL4.
- The SDL4 transmitter constantly emulates a display using EDID data and hot plugging code; this allows DVI-compatible operation. As a result, improperly displayed images are possible during operation with multiple displays. In Windows, a connected panel is registered by the graphics driver even in the following situations:
 - No cable is connected.
 - A connection has not yet been established between the SDL4 link module and SDL4 transmitter.

These improperly displayed images can be circumvented by making suitable configurations in BIOS or via the graphics driver.

2.2 Mechanical properties

2.2.1 Dimensions

Information:

2D and 3D drawings (in DXF and STEP format) can be downloaded from the B&R website (www.br-automation.com).

AP5120/5130 with flange connection on top - Dimensions

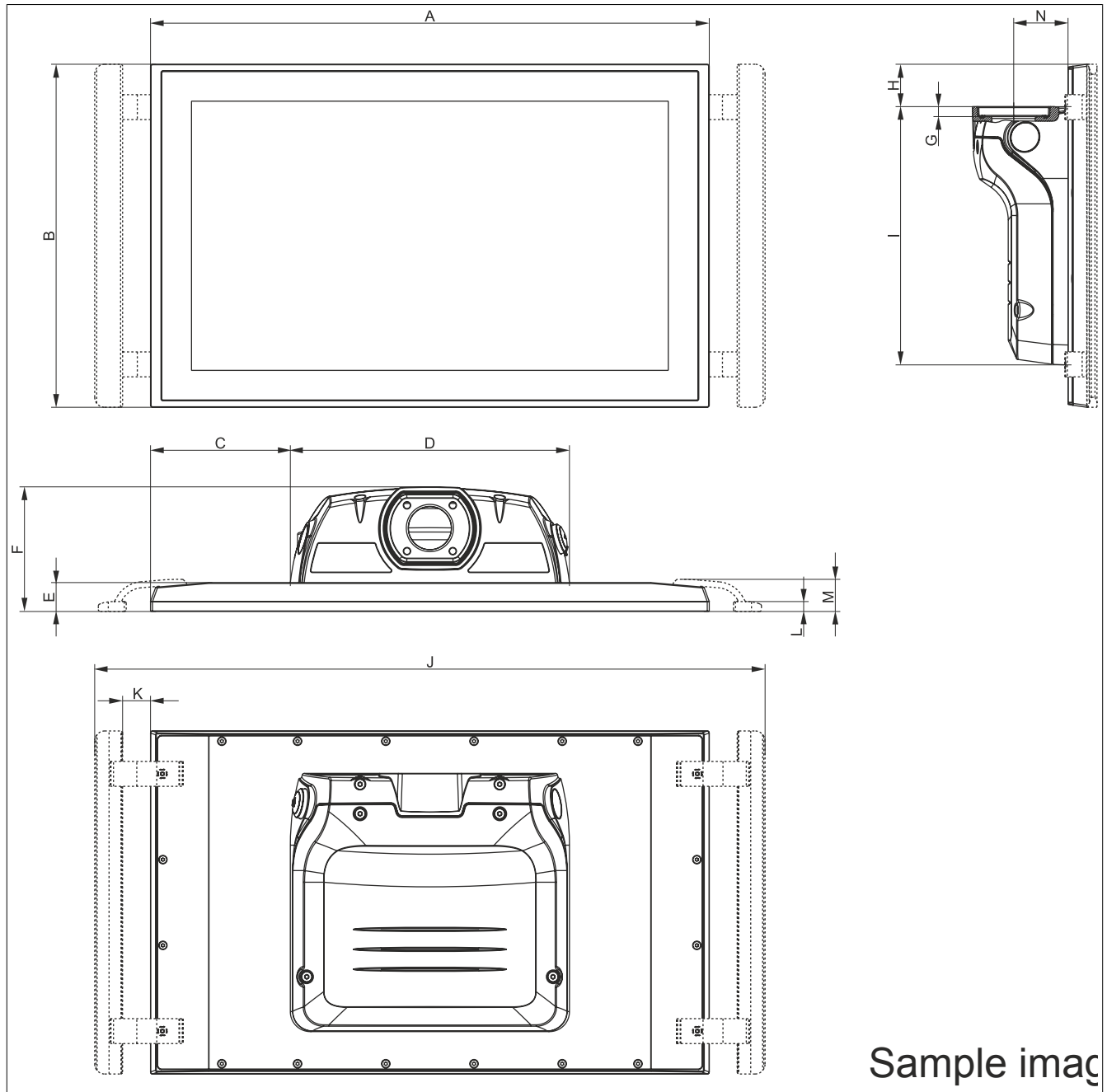

Sample image

Figure 2: AP5120/AP5130 (flange connection on top) with 5ACCMA00.000x-000 and 5ACCHD0x.xxxx-000 - Dimensions

All dimensions are specified in mm.

Display type	Model number	A	B	C	D	E	F	G	H	I	J	K	L	M	N
15.0" single-touch	5AP5120.1505-000	389	299	54.5	280	28	124	10	20	259	501	28	10	32.2	54.5
19.0" single-touch	5AP5120.1906-000	461.2	372	90.6	280	28	124	10	56.5	259	573.2	28	10	32.2	54.5
15.6" multi-touch	5AP5130.156B-000	433	269.5	76.5	280	29	125	10	5.25	259	545	28	10	32.2	54.5
15.6" multi-touch	5AP5130.156C-000	433	269.5	76.5	280	29	125	10	5.25	259	545	28	10	32.2	54.5

Table 4: AP5120/AP5130 - Dimensions

Display type	Model number	A	B	C	D	E	F	G	H	I	J	K	L	M	N
18.5" multi-touch	5AP5130.185B-000	494	306	107	280	29	125	10	23.5	259	606	28	10	32.2	54.5
18.5" multi-touch	5AP5130.185C-000	494	306	107	280	29	125	10	23.5	259	606	28	10	32.2	54.5
21.5" multi-touch	5AP5130.215C-000	560.5	344	140.25	280	29	125	10	42.5	259	672.5	28	10	32.2	54.5
24.0" multi-touch	5AP5130.240C-000	617.5	375	168.75	280	29	125	10	58	259	729.5	28	10	32.2	54.5

Table 4: AP5120/AP5130 - Dimensions

AP5120/5130 with flange connection on bottom - Dimensions

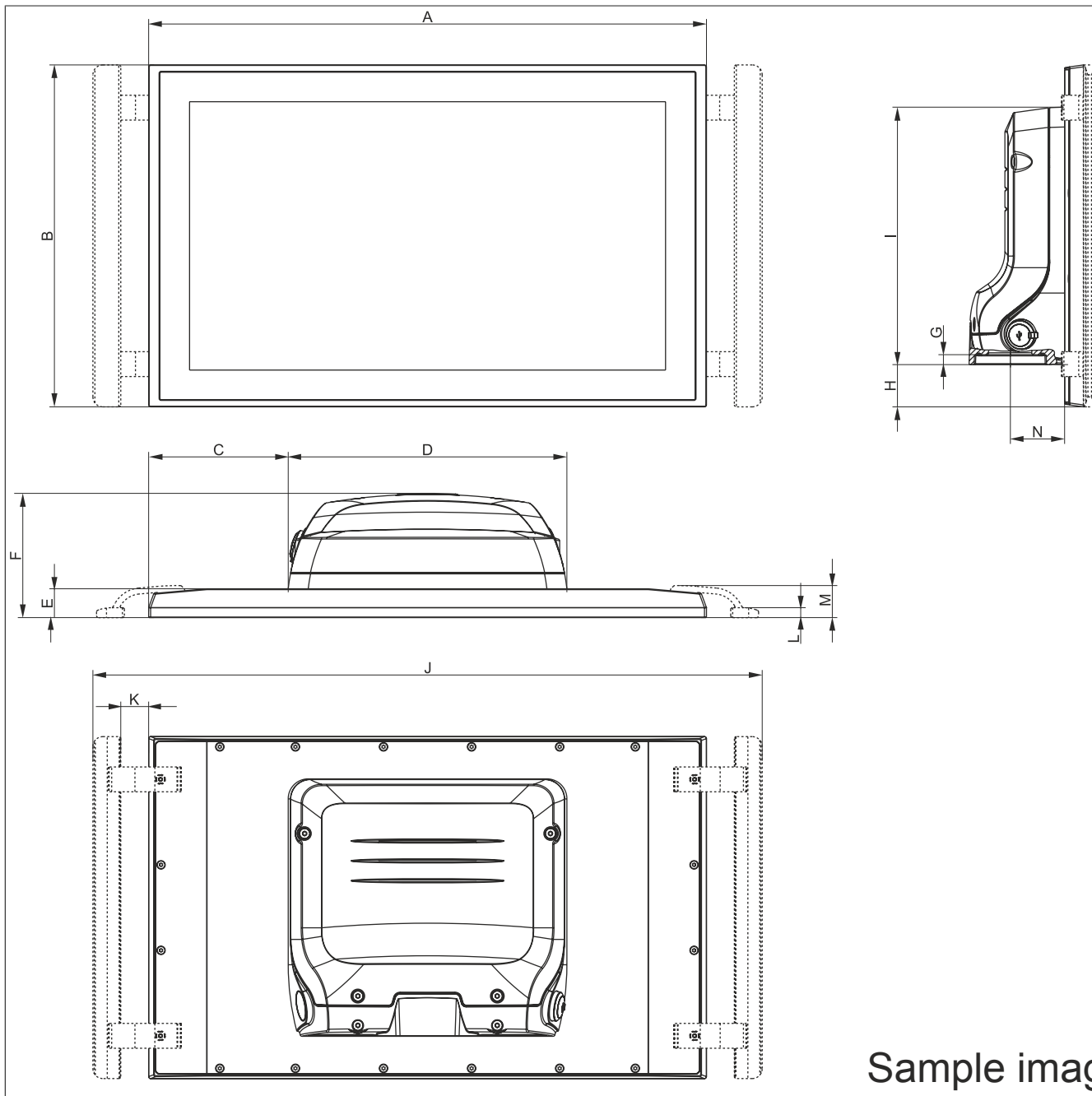

Sample image

Figure 3: AP5120/AP5130 (flange connection on bottom) with 5ACCMA00.000x-000 and 5ACCHD0x.xxxx-000 - Dimensions

All dimensions are specified in mm.

Display type	Model number	A	B	C	D	E	F	G	H	I	J	K	L	M	N
15.0" single-touch	5AP5120.1505-000	389	299	54.5	280	28	124	10	20	259	501	28	10	32.2	54.5
19.0" single-touch	5AP5120.1906-000	461.2	372	90.6	280	28	124	10	56.5	259	573.2	28	10	32.2	54.5
15.6" multi-touch	5AP5130.156B-000	433	269.5	76.5	280	29	125	10	5.25	259	545	28	10	32.2	54.5
15.6" multi-touch	5AP5130.156C-000	433	269.5	76.5	280	29	125	10	5.25	259	545	28	10	32.2	54.5
18.5" multi-touch	5AP5130.185B-000	494	306	107	280	29	125	10	23.5	259	606	28	10	32.2	54.5
18.5" multi-touch	5AP5130.185C-000	494	306	107	280	29	125	10	23.5	259	606	28	10	32.2	54.5
21.5" multi-touch	5AP5130.215C-000	560.5	344	140.25	280	29	125	10	42.5	259	672.5	28	10	32.2	54.5
24.0" multi-touch	5AP5130.240C-000	617.5	375	168.75	280	29	125	10	58	259	729.5	28	10	32.2	54.5

Table 5: AP5120/AP5130 - Dimensions

AP5230 with flange connection on top - Dimensions

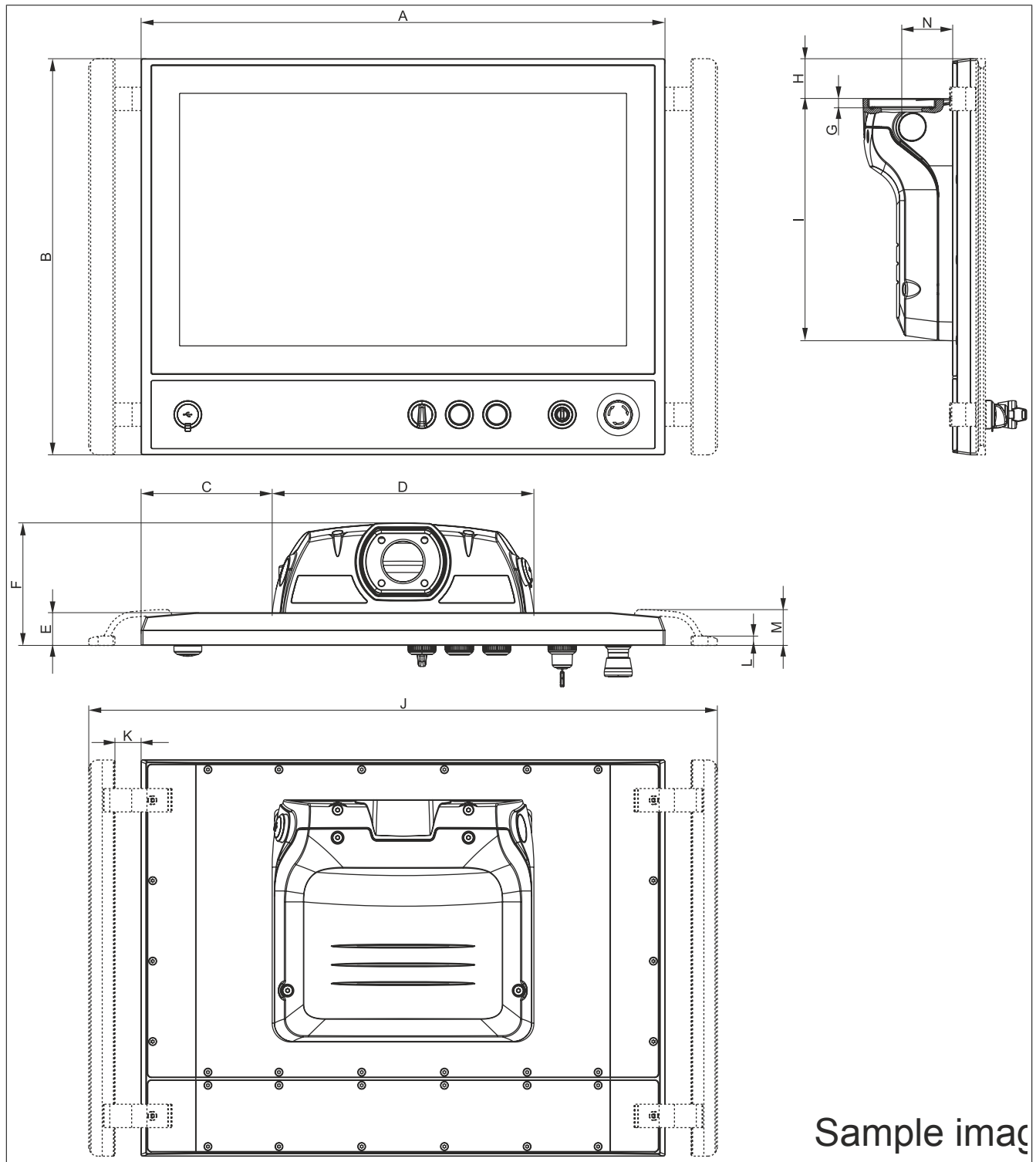

Figure 4: AP5230 (flange connection on top) with 5ACCMA00.000x-000 and 5ACCHD0x.xxxx-000 - Dimensions

All dimensions are specified in mm.

Display type	Model number	A	B	C	D	E	F	G	H	I	J	K	L	M	N
15.6" multi-touch Expansion units	5AP5230.156B-000	433	349	76.5	280	35	131	10	5.25	259	545	28	10	38.2	54.5
15.6" multi-touch Expansion units	5AP5230.156C-000	433	349	76.5	280	35	131	10	5.25	259	545	28	10	38.2	54.5
18.5" multi-touch Expansion units	5AP5230.185B-000	494	385.5	107	280	35	131	10	23.5	259	606	28	10	38.2	54.5

Table 6: AP5230 with flange connection on top - Dimensions

Display type	Model number	A	B	C	D	E	F	G	H	I	J	K	L	M	N
18.5" multi-touch Expansion units	5AP5230.185C-000	494	385.5	107	280	35	131	10	23.5	259	606	28	10	38.2	54.5
21.5" multi-touch Expansion units	5AP5230.215C-000	560.5	423.5	140.25	280	35	131	10	42.5	259	672.5	28	10	38.2	54.5
21.5" multi-touch Expansion units	5AP5230.215I-000	352	632	36	280	35	131	10	146.75	259	464	28	10	39.9	54.5
24.0" multi-touch Expansion units	5AP5230.240C-000	617.5	454.5	168.75	280	35	131	10	58	259	729.5	28	10	38.2	54.5

Table 6: AP5230 with flange connection on top - Dimensions

AP5230 with flange connection on bottom - Dimensions

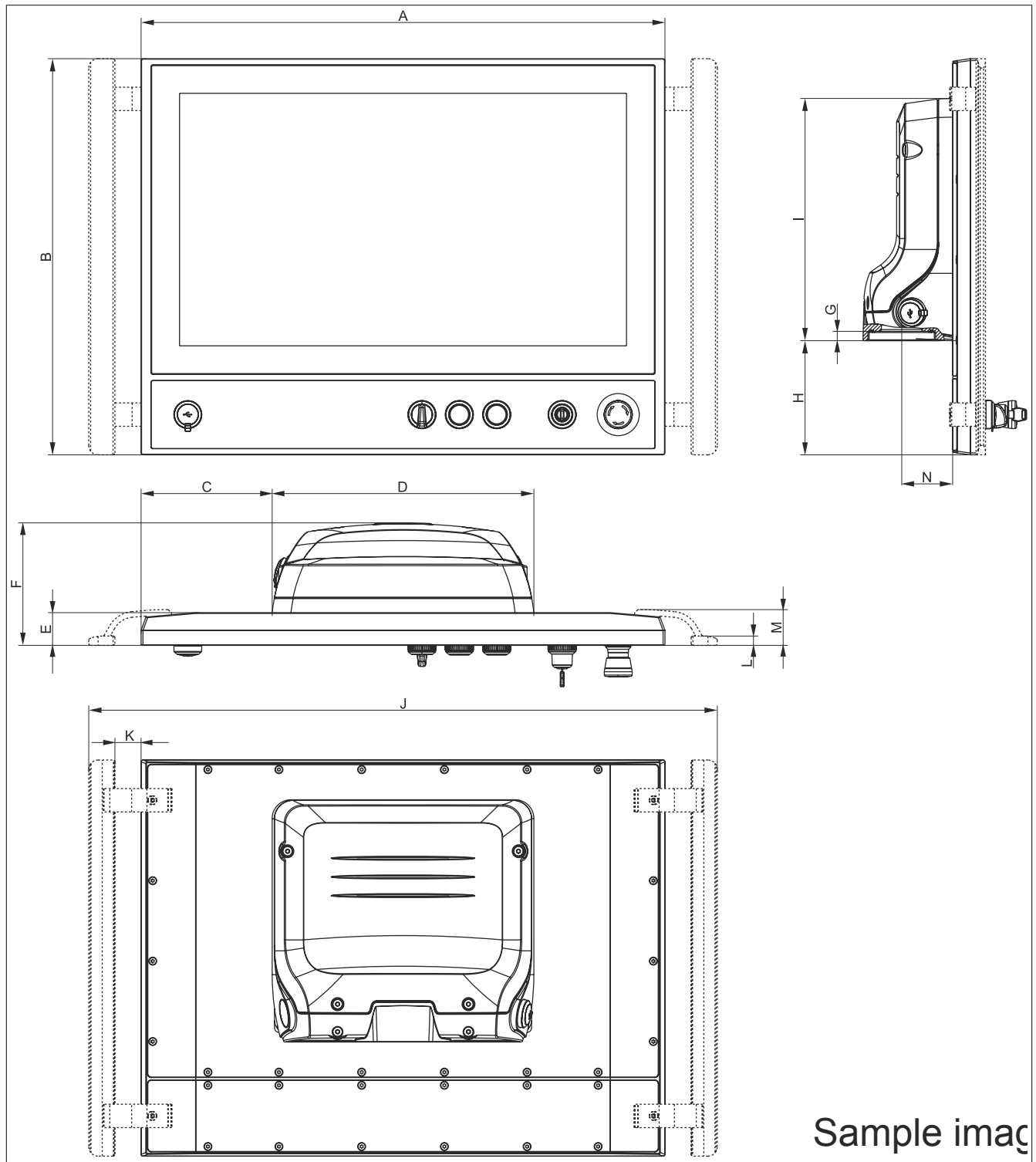

Chapter 2
Technical data

Figure 5: AP5230 (flange connection on bottom) with 5ACCMA00.000x-000 and 5ACCHD0x.xxxx-000 - Dimensions

All dimensions are specified in mm.

Display type	Model number	A	B	C	D	E	F	G	H	I	J	K	L	M	N
15.6" multi-touch Expansion units	5AP5230.156B-000	433	349	76.5	280	35	131	10	84.75	259	545	28	10	38.2	54.5
15.6" multi-touch Expansion units	5AP5230.156C-000	433	349	76.5	280	35	131	10	84.75	259	545	28	10	38.2	54.5
18.5" multi-touch Expansion units	5AP5230.185B-000	494	385.5	107	280	35	131	10	103	259	606	28	10	38.2	54.5

Table 7: AP5230 with flange connection on bottom - Dimensions

Display type	Model number	A	B	C	D	E	F	G	H	I	J	K	L	M	N
18.5" multi-touch Expansion units	5AP5230.185C-000	494	385.5	107	280	35	131	10	103	259	606	28	10	38.2	54.5
21.5" multi-touch Expansion units	5AP5230.215C-000	560.5	423.5	140.25	280	35	131	10	122	259	672.5	28	10	38.2	54.5
21.5" multi-touch Expansion units	5AP5230.215I-000	352	632	36	280	35	131	10	226.25	259	464	28	10	39.9	54.5
24.0" multi-touch Expansion units	5AP5230.240C-000	617.5	454.5	168.75	280	35	131	10	137.5	259	729.5	28	10	38.2	54.5

Table 7: AP5230 with flange connection on bottom - Dimensions

Rotary flange - Dimensions

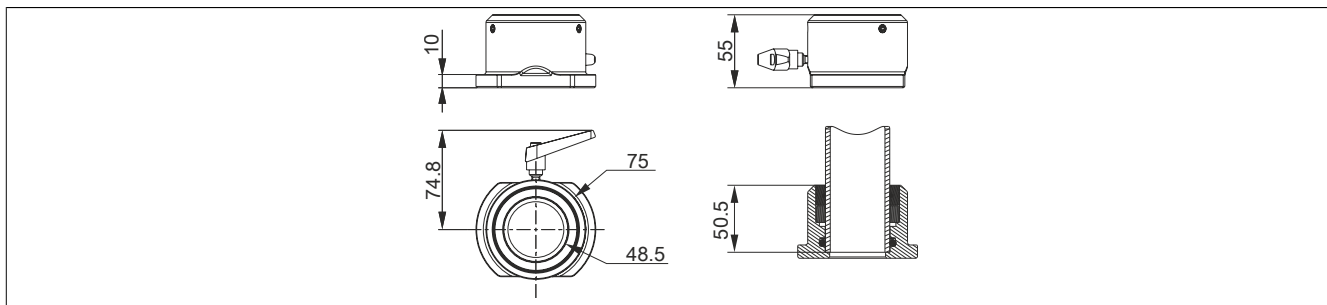

Figure 6: 5ACCFL00.0000-000 rotary flange - Dimensions

Adapter for Rittal flange - Dimensions

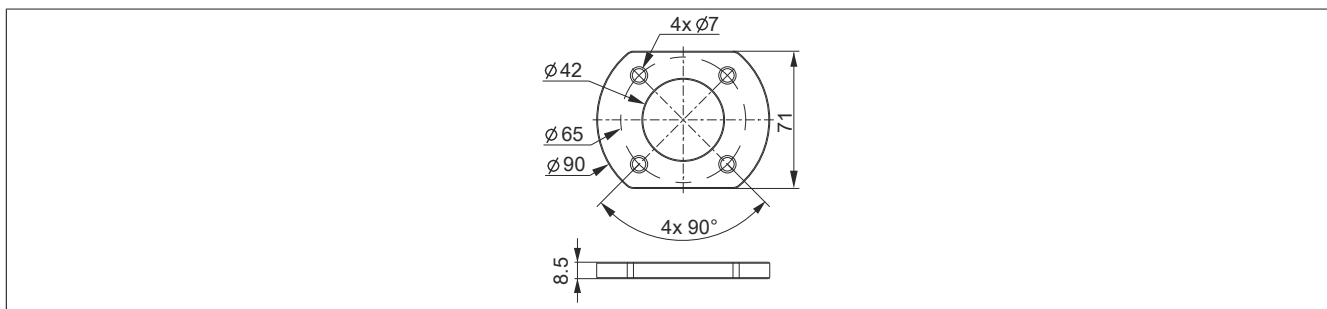

Figure 7: 5ACCFL00.0200-000 - Dimensions

AP5120/5130 VESA connection - Dimensions

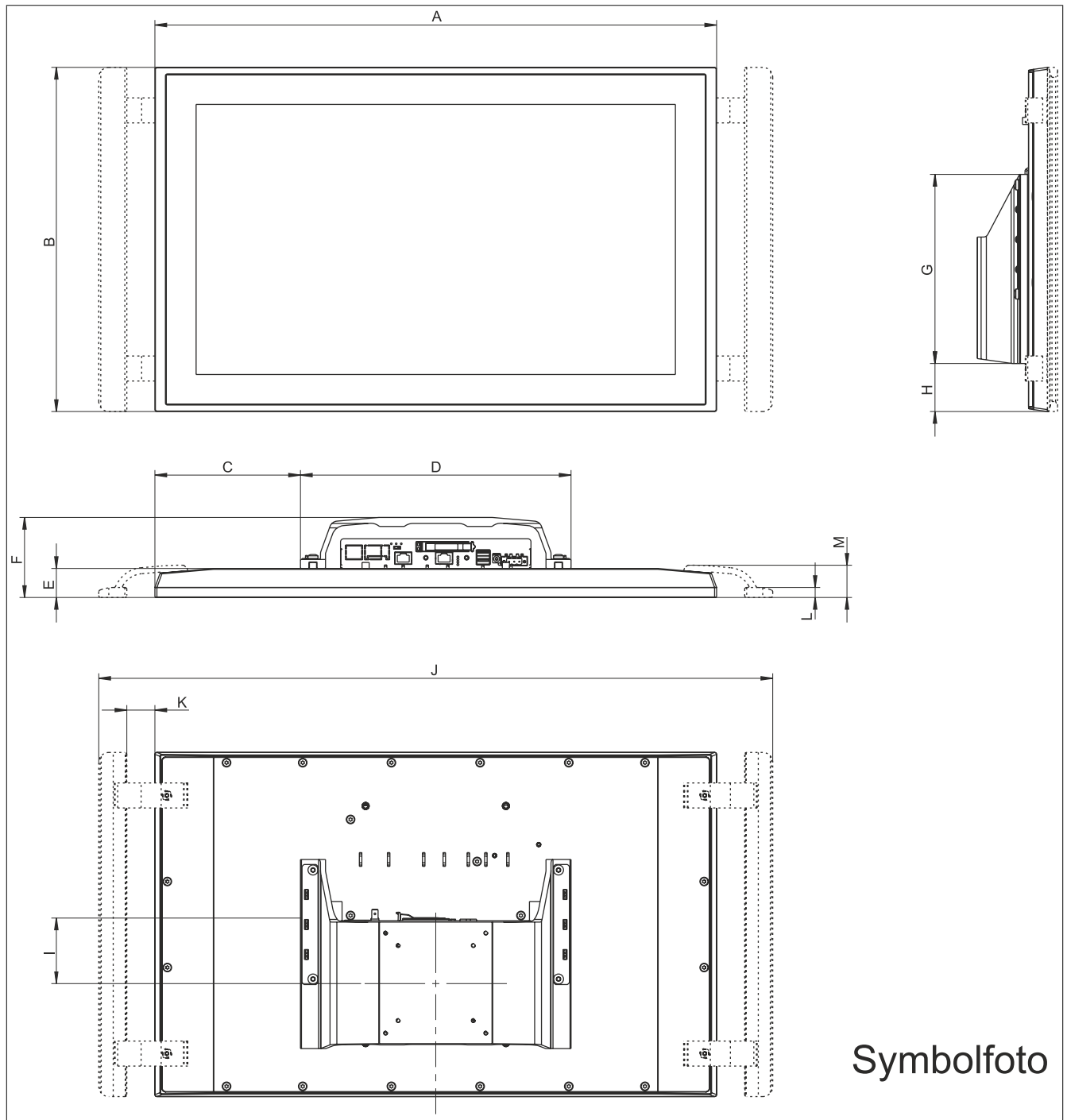

Figure 8: AP5120/AP5130 with 5ACCA01.0100-000 and 5ACCHD0x.xxx-000 - Dimensions

All dimensions are specified in mm.

Display type	Model number	A	B	C	D	E	F	G	H	I	J	K	L	M
15" single-touch	5AP5120.1505-000	389	299	59.5	270	28	79	189	25.5	65.5	501	28	10	32.2
19" single-touch	5AP5120.1906-000	461.2	372	95.6	270	28	79	189	62	65.5	573.2	28	10	32.2
15.6" multi-touch	5AP5130.156B-000	433	269.5	81.5	270	29	80	189	10.75	65.5	545	28	10	32.2
15.6" multi-touch	5AP5130.156C-000	433	269.5	81.5	270	29	80	189	10.75	65.5	545	28	10	32.2
18.5" multi-touch	5AP5130.185B-000	494	306	112	270	29	80	189	29	65.5	606	28	10	32.2
18.5" multi-touch	5AP5130.185C-000	494	306	112	270	29	80	189	29	65.5	606	28	10	32.2
21.5" multi-touch	5AP5130.215C-000	560.5	344	145.25	270	29	80	189	48	65.5	672.5	28	10	32.2
24.0" multi-touch	5AP5130.240C-000	617.5	375	173.75	270	29	80	189	63.5	65.5	729.5	28	10	32.2

Table 8: AP5120/AP5130 VESA - Dimensions

AP5230 VESA connection - Dimensions

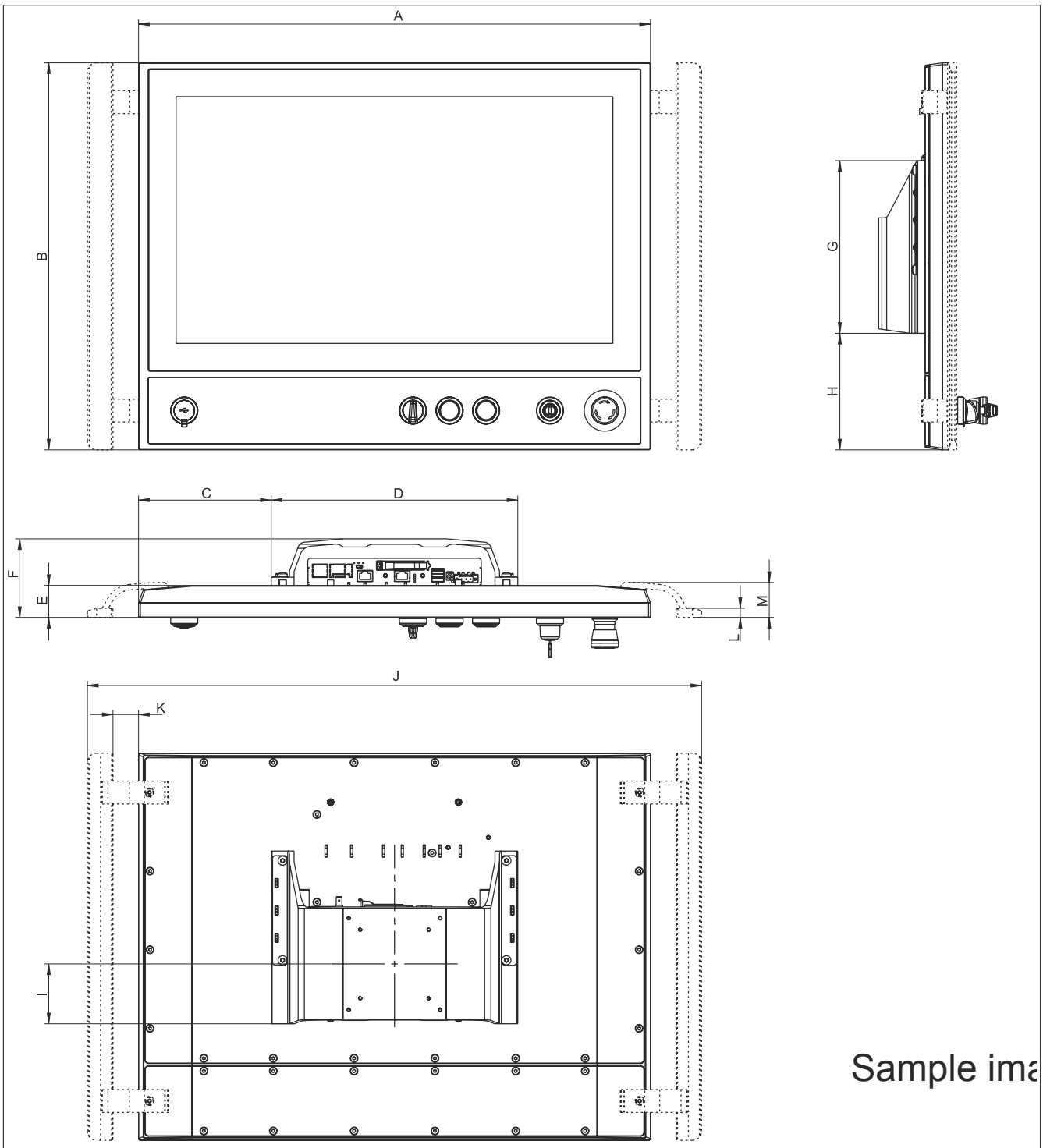

Sample image

Figure 9: AP5120/AP5230 with 5ACCA01.0100-000 and 5ACCHD0x.xxxx-000 - Dimensions

All dimensions are specified in mm.

Display type	Model number	A	B	C	D	E	F	G	H	I	J	K	L	M
15.6" multi-touch Expansion units	5AP5230.156B-000	433	349	81.5	270	35	86	189	90.25	65.5	545	28	10	38.2
15.6" multi-touch Expansion units	5AP5230.156C-000	433	349	81.5	270	35	86	189	90.25	65.5	545	28	10	38.2
18.5" multi-touch Expansion units	5AP5230.185B-000	494	385.5	112	270	35	86	189	108.5	65.5	606	28	10	38.2

Table 9: AP5230 VESA - Dimensions

Display type	Model number	A	B	C	D	E	F	G	H	I	J	K	L	M
18.5" multi-touch Expansion units	5AP5230.185C-000	494	385.5	112	270	35	86	189	108.5	65.5	606	28	10	38.2
21.5" multi-touch Expansion units	5AP5230.215C-000	560.5	423.5	145.25	270	35	86	189	127.5	65.5	672.5	28	10	38.2
21.5" multi-touch Expansion units	5AP5230.215I-000	352	632	41	270	35	86	189	231.75	65.5	464	28	10	39.9
24.0" multi-touch Expansion units	5AP5230.240C-000	617.5	454.5	173.75	270	35	86	189	143	65.5	729.5	28	10	38.2

Table 9: AP5230 VESA - Dimensions

2.2.2 Mounting orientations

Use the adjustment lever on the flange to set the angle of rotation of the Automation Panel between -150° and $+150^\circ$ (variant with mounting unit 5ACCMA00.000x-000).

Caution!

After the angle of rotation has been set, the adjustment lever must be locked into position (approx. 5 Nm).

The screw in the adjustment lever is not permitted to be tightened. Only the adjustment lever can be used to lock into position.

The following diagrams show the approved mounting orientations for Automation Panel 5000 devices with VESA mounting unit 5ACCMA01.0100-000. An AP5000 with VESA is only permitted to be installed as illustrated and described below.

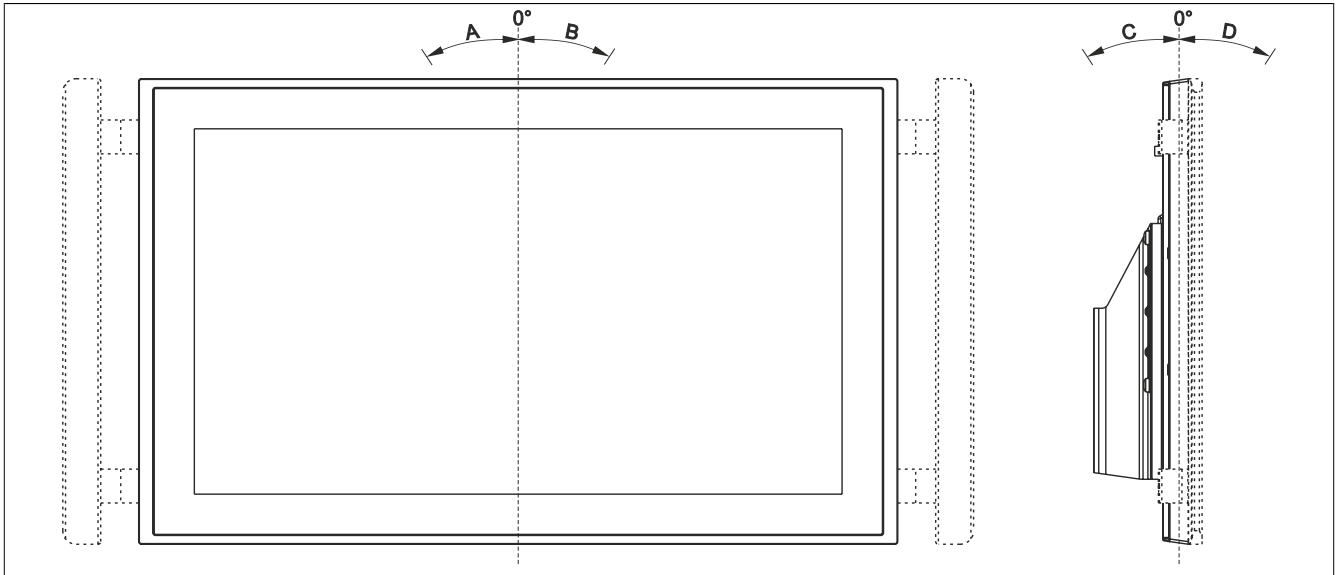

Figure 10: Automation Panel 5000 with VESA - Mounting orientation

Mounting orientation		Ambient temperature limitation
A, B	0° to $\pm 20^\circ$	None
A, B	$\pm 21^\circ$ to $\pm 45^\circ$	5°C .
A, B	$\pm 46^\circ$ to $\pm 90^\circ$	10°C .
C, D	0° to $\pm 20^\circ$	None
C, D	$\pm 21^\circ$ to $\pm 45^\circ$	5°C .
C, D	$\pm 46^\circ$ to $\pm 90^\circ$	10°C .

Table 10: Mounting orientations during operation

2.2.3 Weight

All weights are specified in g (grams).

Display type	Model number	Weight
15" single-touch	5AP5120.1505-000	5200
15.6" multi-touch	5AP5130.156B-000	4700
15.6" multi-touch	5AP5130.156C-000	4700
15.6" multi-touch Expansion option	5AP5230.156B-000	6400
15.6" multi-touch Expansion option	5AP5230.156C-000	6400
18.5" multi-touch	5AP5130.185B-000	6700
18.5" multi-touch	5AP5130.185C-000	6700
18.5" multi-touch Expansion option	5AP5230.185B-000	8300
18.5" multi-touch Expansion option	5AP5230.185C-000	8300
19" single-touch	5AP5120.1906-000	7300
21.5" multi-touch	5AP5130.215C-000	7300
21.5" multi-touch Expansion option	5AP5230.215C-000	8900
21.5" multi-touch Expansion option	5AP5230.215I-000	9600
24.0" multi-touch	5AP5130.240C-000	8500
24.0" multi-touch Expansion option	5AP5230.240C-000	10300

Table 11: AP5000 panels - Weight

Link module type	Model number	Weight
SDL/DVI receiver	5DLSDL.1001-00	538
SDL3 receiver	5DLSD3.1001-00	527
SDL4 receiver	5DLSD4.1001-00	525

Table 12: Link modules - Weight

Mounting unit	Model number	Weight
Swing arm mounting unit without USB	5ACCMA00.0000-000	2500
Swing arm mounting unit with 1x USB	5ACCMA00.0001-000	2500
Swing arm mounting unit with 2x USB	5ACCMA00.0002-000	2500
VESA mounting unit	5ACCMA01.0100-000	700

Table 13: AP5000 mounting units - Weight

Flange	Model number	Weight
Rotary flange	5ACCFL00.0000-000	530
Rittal flange adapter	5ACCFL00.0200-000	93

Table 14: AP5000 flanges - Weight

Extension options	Model number	Weight
15.6" expansion cover	5ACCKP00.156B-000	600
15.6" expansion unit	5ACCKP01.156B-000	800
15.6" expansion unit	5ACCKP04.156B-000	800
18.5" expansion cover	5ACCKP00.185B-000	600
18.5" expansion unit	5ACCKP01.185B-000	900
18.5" expansion unit	5ACCKP04.185B-000	900
21.5" expansion cover	5ACCKP00.215C-000	800
21.5" expansion unit	5ACCKP01.215C-000	1000
21.5" expansion unit	5ACCKP04.215C-000	1000
21.5" expansion cover	5ACCKP00.215I-000	500
21.5" expansion unit	5ACCKP01.215I-000	700
21.5" expansion unit	5ACCKP04.215I-000	700
24.0" expansion cover	5ACCKP00.240C-000	900
24.0" expansion unit	5ACCKP01.240C-000	1100
24.0" expansion unit	5ACCKP04.240C-000	1100

Table 15: AP5000 expansion units - Weight

Handles	Model number	Weight
15" handles for AP5120	5ACCHD00.1505-000	500
15.6" handles for AP5130	5ACCHD00.156B-000	300
15.6" handles for AP5230	5ACCHD01.156B-000	600
18.5" handles for AP5130	5ACCHD00.185B-000	500
18.5" handles for AP5230	5ACCHD01.185B-000	700
19" handles for AP5120	5ACCHD00.1906-000	600

Table 16: AP5000 handles - Weight

Handles	Model number	Weight
21.5" handles for AP5130	5ACCHD00.215C-000	600
21.5" handles for AP5230	5ACCHD01.215C-000	700
21.5" handles for AP5230	5ACCHD01.215I-000	1000
24.0" handles for AP5130	5ACCHD00.240C-000	600
24.0" handles for AP5230	5ACCHD01.240C-000	800

Table 16: AP5000 handles - Weight

2.3 Environmental characteristics

2.3.1 Temperature specifications

Various panels can be combined with various link modules. The many different configurations possible result in varying maximum ambient temperatures, which can be seen in the following table in this section.

Information:

The maximum specified ambient temperatures for operation were determined under worst-case conditions. Experience has shown that higher ambient temperatures can be achieved in typical applications, e.g. in Microsoft Windows. Testing and evaluation in this regard must be performed on-site by the user in each individual case (temperatures can be read in BIOS or using the B&R Control Center, for example).

Information regarding worst-case conditions

- Thermal Analysis Tool (TAT) from Intel for simulating processor load (100% CPU, 100% memory)
- PassMark BurnInTest 7.1 (100% network)
- 2x 1 A USB load
- 100% brightness

2.3.1.1 Maximum ambient temperature for worst-case operation

All values apply to non-condensing operation.

The table refers to the use of panels with a swing arm mounting unit (5ACCMA00.000x-000).

		Link module			Location of sensor(s)
		SDL/DVI 5DLSDL.1001-00	SDL3 5DLS3.1001-00	SDL4 5DLS4.1001-00	
		All temperature values in degrees Celsius (°C) at 500 m above sea level.			
		The maximum ambient temperature is typically derated by 1°C per 1000 meters starting at 500 meters above sea level.			
		Maximum ambient temperature	55	55¹⁾	55
		What else can also be operated at the max. ambient temperature, or is there a limitation?			
Panels	5AP5120.1505-000	✓	✓	✓	Display
	5AP5130.156B-000	✓	50	50	
	5AP5130.156C-000	✓	50	50	
	5AP5230.156B-000	✓	50	50	
	5AP5230.156C-000	✓	50	50	
	5AP5130.185B-000	50	50	50	
	5AP5130.185C-000	✓	50	50	
	5AP5230.185B-000	✓	50	50	
	5AP5230.185C-000	✓	50	50	
	5AP5120.1906-000	✓	50	50	
	5AP5130.215C-000	50	50	50	
	5AP5230.215C-000	✓	50	50	
	5AP5230.215I-000	50	45	45	
	5AP5130.240C-000	45	45	45	
5AP5230.240C-000	50	45	45		
AP5000 expansion units	5ACCKP01.xxxx-000	✓	✓	✓	-
	5ACCKP04.xxxx-000	✓	✓	✓	

1) The maximum ambient temperature for SDL3 link module 5DLS3.1001-00 < Rev. A5 with the corresponding panel is reduced by 5°C.

Table 17: Maximum ambient temperature for worst-case operation

The table refers to the use of panels with a VESA mounting unit (5ACCMA01.0100-000).

		Link module			Location of sensor(s)
		SDL/DVI 5DLSDL.1001-00	SDL3 5DLS3.1001-00	SDL4 5DLS4.1001-00	
All temperature values in degrees Celsius (°C) at 500 m above sea level.					
The maximum ambient temperature is typically derated by 1°C per 1000 meters starting at 500 meters above sea level.					
Maximum ambient temperature		55	55¹⁾	55	
What else can also be operated at the max. ambient temperature, or is there a limitation?					
Panels	5AP5120.1505-000	✓	50	50	Display
	5AP5130.156B-000	✓	✓	✓	
	5AP5130.156C-000	✓	✓	✓	
	5AP5230.156B-000	✓	✓	✓	
	5AP5230.156C-000	✓	✓	✓	
	5AP5130.185B-000	50	50	50	
	5AP5130.185C-000	✓	✓	✓	
	5AP5230.185B-000	50	50	50	
	5AP5230.185C-000	✓	✓	✓	
	5AP5120.1906-000	✓	✓	✓	
	5AP5130.215C-000	50	50	50	
	5AP5230.215C-000	50	50	50	
	5AP5230.215I-000	45	45	45	
	5AP5130.240C-000	45	45	45	
	5AP5230.240C-000	45	45	45	
AP5000 expansion units	5ACCKP01.xxxx-000	✓	✓	✓	-
	5ACCKP04.xxxx-000	✓	✓	✓	-

1) The maximum ambient temperature for SDL3 link module 5DLS3.1001-00 < Rev. A5 with the corresponding panel is reduced by 5°C.

Table 18: Maximum ambient temperature for worst-case operation

2.3.1.2 Minimum ambient temperature for worst-case operation

All values apply to non-condensing operation.

		Link module			Location of sensor(s)
		SDL/DVI 5DLSDL.1001-00	SDL3 5DLS3.1001-00	SDL4 5DLS4.1001-00	
All temperature values in degrees Celsius (°C) at 500 m above sea level.					
The maximum ambient temperature is typically derated by 1°C per 1000 meters starting at 500 meters above sea level.					
Minimum ambient temperature		0	0	0	
What else can also be operated at the min. ambient temperature, or is there a limitation?					
Panels	5AP5120.1505-000	✓	✓	✓	Display
	5AP5130.156B-000	✓	✓	✓	
	5AP5130.156C-000	✓	✓	✓	
	5AP5230.156B-000	✓	✓	✓	
	5AP5230.156C-000	✓	✓	✓	
	5AP5130.185B-000	✓	✓	✓	
	5AP5130.185C-000	✓	✓	✓	
	5AP5230.185B-000	✓	✓	✓	
	5AP5230.185C-000	✓	✓	✓	
	5AP5120.1906-000	✓	✓	✓	
	5AP5130.215C-000	✓	✓	✓	
	5AP5230.215C-000	✓	✓	✓	
	5AP5230.215I-000	✓	✓	✓	
	5AP5130.240C-000	✓	✓	✓	
	5AP5230.240C-000	✓	✓	✓	
AP5000 expansion units	5ACCKP01.xxxx-000	✓	✓	✓	-
	5ACCKP04.xxxx-000	✓	✓	✓	-

Table 19: Minimum ambient temperature for worst-case operation

2.3.1.3 Temperature during storage and transport

The following table provides an overview of the minimum and maximum ambient temperatures for storing and transporting the complete system. Limitations are possible through the use of individual components.

Display type	Model number	Storage	Transport
15" single-touch	5AP5120.1505-000	-25 to 80°C	-25 to 80°C
15.6" multi-touch	5AP5130.156B-000	-25 to 70°C	-25 to 70°C
15.6" multi-touch	5AP5130.156C-000	-20 to 70°C	-20 to 70°C
15.6" multi-touch Expansion option	5AP5230.156B-000	-25 to 70°C	-25 to 70°C
15.6" multi-touch Expansion option	5AP5230.156C-000	-20 to 70°C	-20 to 70°C
18.5" multi-touch	5AP5130.185B-000	-20 to 60°C	-20 to 60°C
18.5" multi-touch	5AP5130.185C-000	-25 to 70°C	-25 to 70°C
18.5" multi-touch Expansion option	5AP5230.185B-000	-20 to 60°C	-20 to 60°C
18.5" multi-touch Expansion option	5AP5230.185C-000	-25 to 70°C	-25 to 70°C
19" single-touch	5AP5120.1906-000	-25 to 70°C	-25 to 70°C
21.5" multi-touch	5AP5130.215C-000	-20 to 60°C	-20 to 60°C
21.5" multi-touch Expansion option	5AP5230.215C-000	-20 to 60°C	-20 to 60°C
21.5" multi-touch Expansion option	5AP5230.215I-000	-20 to 60°C	-20 to 60°C
24.0" multi-touch	5AP5130.240C-000	-25 to 70°C	-25 to 70°C
24.0" multi-touch Expansion option	5AP5230.240C-000	-25 to 70°C	-25 to 70°C

Table 20: AP5000 panels - Ambient temperature during storage and transport

Link module	Model number	Storage	Transport
SDL/DVI receiver	5DLSDL.1001-00	-20 to 60°C	-20 to 60°C
SDL3 receiver	5DLSD3.1001-00	-20 to 60°C	-20 to 60°C
SDL4 receiver	5DLSD4.1001-00	-20 to 60°C	-20 to 60°C

Table 21: Link modules - Ambient temperature during storage and transport

Component	Model number	Storage	Transport
Extension options	5ACCKP01.xxxx-000	-20 to 80°C	-20 to 80°C
	5ACCKP04.xxxx-000	-20 to 80°C	-20 to 80°C

Table 22: Expansion units - Ambient temperature during storage and transport

2.3.1.4 Temperature monitoring

A sensor in the display monitors the temperature of the AP5000 panel. The location of the temperature sensor is illustrated in Fig. 11 "Automation Panel 5000 - Temperature sensor position" on page 42. The values listed in Tab. 23 "Temperature sensor position" on page 42 represent the defined maximum temperature for this measurement point. An alarm is not triggered if this temperature is exceeded.

These temperatures ¹⁾ can be read in various ways in approved operating systems:

- BIOS
- B&R Control Center²⁾
- B&R ADI Development Kit²⁾
- B&R ADI .NET SDK²⁾
- B&R HMI Service Center²⁾
- B&R HMI Diagnose²⁾
- B&R PVI ADI line²⁾
- B&R ADI SNMP Agent²⁾
- Automation Runtime Library²⁾

For applications that do not run in approved operating systems, temperatures can be evaluated using the B&R implementation guide. In addition to the implementation guide, programs in MS-DOS are also available.

2.3.1.5 Temperature sensor positions



Figure 11: Automation Panel 5000 - Temperature sensor position

ADI sensors	Position	Measurement point for	Measurement	Max. specified
Panel	A	Display	Temperature of the display (sensor integrated in panel).	5AP5120.1505-000: 85°C 5AP5130.156B-000: 75°C 5AP5130.156C-000: 80°C 5AP5230.156B-000: 80°C 5AP5230.156C-000: 80°C 5AP5130.185B-000: 80°C 5AP5130.185C-000: 80°C 5AP5230.185B-000: 80°C 5AP5230.185C-000: 80°C 5AP5120.1906-000: 80°C 5AP5130.215C-000: 80°C 5AP5230.215C-000: 80°C 5AP5230.215I-000: 80°C 5AP5130.240C-000: 75°C 5AP5230.240C-000: 75°C

Table 23: Temperature sensor position

¹⁾ The temperature measured approximates the immediate ambient temperature but may also be influenced by neighboring components.

²⁾ Drivers for approved operating systems can be downloaded at no cost from the Downloads section of the B&R website (www.br-automation.com).

2.3.2 Relative humidity

All values apply to non-condensing operation/storage/transport.

Display type	Model number	Operation	Storage	Transport
15" single-touch	5AP5120.1505-000	8 to 90%	8 to 90%	8 to 90%
15.6" multi-touch	5AP5130.156B-000	5 to 90%	5 to 90%	5 to 90%
15.6" multi-touch	5AP5130.156C-000	5 to 90%	5 to 90%	5 to 90%
15.6" multi-touch Expansion option	5AP5230.156B-000	5 to 90%	5 to 90%	5 to 90%
15.6" multi-touch Expansion option	5AP5230.156C-000	5 to 90%	5 to 90%	5 to 90%
18.5" multi-touch	5AP5130.185B-000	5 to 90%	5 to 90%	5 to 90%
18.5" multi-touch	5AP5130.185C-000	5 to 90%	5 to 90%	5 to 90%
18.5" multi-touch Expansion option	5AP5230.185B-000	5 to 90%	5 to 90%	5 to 90%
18.52" multi-touch Expansion option	5AP5230.185C-000	5 to 90%	5 to 90%	5 to 90%
19" single-touch	5AP5120.1906-000	5 to 90%	5 to 90%	5 to 90%
21.5" multi-touch	5AP5130.215C-000	5 to 90%	5 to 90%	5 to 90%
21.5" multi-touch Expansion option	5AP5230.215C-000	5 to 90%	5 to 90%	5 to 90%
21.5" multi-touch Expansion option	5AP5230.215I-000	5 to 90%	5 to 90%	5 to 90%
24.0" multi-touch	5AP5130.240C-000	5 to 90%	5 to 90%	5 to 90%
24.0" multi-touch Expansion option	5AP5230.240C-000	5 to 90%	5 to 90%	5 to 90%

Table 24: AP5000 panels - Relative humidity

All values apply to non-condensing operation/storage/transport.

Link module type	Model number	Operation	Storage	Transport
SDL/DVI receiver	5DLSDL.1001-00	5 to 90%	5 to 95%	5 to 95%
SDL3 receiver	5DLSD3.1001-00	5 to 90%	5 to 95%	5 to 95%
SDL4 receiver	5DLSD4.1001-00	5 to 90%	5 to 95%	5 to 95%

Table 25: Link modules - Humidity

All values apply to non-condensing operation/storage/transport.

Component	Model number	Operation	Storage	Transport
Extension options	5ACCKP01.xxxx-000	5 to 90%	5 to 90%	5 to 90%
	5ACCKP04.xxxx-000	5 to 90%	5 to 90%	5 to 90%

Table 26: Expansion units - Relative humidity

2.3.3 Vibration

The following table provides an overview of the maximum vibration values of the complete system. Limitations are possible through the use of individual components.

	Operation ¹⁾		Storage ¹⁾²⁾	Transport ¹⁾²⁾
	Continuous	Periodic		
Automation Panel 5000	2 to 9 Hz: 1.75 mm amplitude 9 to 200 Hz: 0.5 g	2 to 9 Hz: 3.5 mm amplitude 9 to 200 Hz: 1 g	2 to 8 Hz: 7.5 mm amplitude 8 to 200 Hz: 2 g 200 to 500 Hz: 4 g	2 to 8 Hz: 7.5 mm amplitude 8 to 200 Hz: 2 g 200 to 500 Hz: 4 g

Table 27: Swing arm mounting unit - Vibration

- 1) Testing is performed in accordance with EN 60068-2-6.
- 2) This value applies to a device in its original packaging.

	Operation ¹⁾		Storage ¹⁾²⁾	Transport ¹⁾²⁾
	Continuous			
Automation Panel 5000	2 to 9 Hz: 1.75 mm amplitude 9 to 200 Hz: 0.5 g		2 to 8 Hz: 7.5 mm amplitude 8 to 200 Hz: 2 g 200 to 500 Hz: 4 g	2 to 8 Hz: 7.5 mm amplitude 8 to 200 Hz: 2 g 200 to 500 Hz: 4 g

Table 28: VESA mounting unit - Vibration

- 1) Testing is performed in accordance with EN 60068-2-6.
- 2) This value applies to a device in its original packaging.

2.3.4 Shock

The following table provides an overview of the maximum shock values of the complete system. Limitations are possible through the use of individual components.

	Operation ¹⁾	Storage ¹⁾²⁾	Transport ¹⁾²⁾
Automation Panel 5000	15 g, 11 ms	30 g, 6 ms	30 g, 6 ms

Table 29: Shock

- 1) Testing is performed in accordance with EN 60068-2-27.
 2) This value applies to a device in its original packaging.

2.3.5 Protection

The Automation Panel 5000 offers IP65 protection per EN 60529 on all sides under the following conditions:

- The Automation Panel is installed correctly (see [Automation Panel 5000 - Installation](#)).
- The 5ACCMA00.000x-000 mounting unit is installed correctly.
- All covers and components are installed on the interfaces and slots.
- All environmental conditions are observed.

2.4 Electrical characteristics

2.4.1 +24 VDC power supply

Danger!

This device is only permitted to be supplied by a SELV/PELV power supply or with safety extra-low voltage (SELV) per EN 60950.

The 3-pin male connector required for connecting the power supply is not included in delivery. It can be ordered from B&R using model number 0TB103.9 (screw clamp terminal block) or 0TB103.91 (cage clamp terminal block).

For the pinout, see the following table. The supply voltage is protected internally by a soldered fuse (10 A, fast-acting) to prevent damage to the device in the event of overload (fuse replacement necessary) or if the voltage supply is connected incorrectly (reverse polarity protection → fuse replacement not necessary). The device must be returned to B&R for repairs if the fuse is destroyed in the event of error.

+24 VDC power supply	
Protected against reverse polarity	
Pin	Description
1	+
2	Functional ground
3	-
Model number	Short description
	Terminal blocks
0TB103.9	Male connector 24 V 5.08 3-pin screw clamp terminal block
0TB103.91	Male connector 24 V 5.08 3-pin cage clamp terminal block

3-pin male power supply connector
+24 VDC power supply



Table 30: +24 VDC voltage supply connection

Electrical characteristics	
Nominal voltage	24 VDC ±25%, SELV ¹⁾
Nominal current	Max. 3 A
Overvoltage category in accordance with EN 61131-2	II
Electrical isolation	Yes
Uninterruptible power supply	No

1) EN 60950 requirements must be observed.

2.4.2 Power calculation

In order to calculate the total power of the Automation Panel, the power rating of the display being used must be added to the power rating of the link module being used.

The following specifications are maximum values without additional consumers (USB devices, etc.).

Link module	Model number	Total power consumption of link module
SDL/DVI receiver	5DLSDL.1001-00	Max. 3.6 W without USB consumer Max. 8.6 W with USB consumer
SDL3 receiver	5DLSD3.1001-00	Max. 8.1 W without USB consumer Max. 13.1 W with USB consumer
SDL4 receiver	5DLSD4.1001-00	Max. 8.1 W without USB consumer Max. 13.1 W with USB consumer

Table 31: Link modules - Power calculation

Panel type	Model number	+5 V	3V3	+12 V	Power consumption Total
15" single-touch	5AP5120.1505-000	-	2.1 W	8.9 W	11 W
15.6" multi-touch	5AP5130.156B-000	1.8 W	-	15.6 W	17.4 W
15.6" multi-touch	5AP5130.156C-000	6 W	-	18 W	24 W
15.6" multi-touch Expansion unit	5AP5230.156B-000	1.8 W	-	15.6 W	17.4 W
15.6" multi-touch Expansion unit	5AP5230.156C-000	6 W	-	18 W	24 W
18.5" multi-touch	5AP5130.185B-000	6.1 W	-	10.8 W	16.9 W
18.5" multi-touch	5AP5130.185C-000	7 W	-	18.6 W	24.6 W
18.5" multi-touch Expansion unit	5AP5230.185B-000	6.1 W	-	10.8 W	16.9 W
18.5" multi-touch Expansion unit	5AP5230.185C-000	7 W	-	18.6 W	24.6 W
19" single-touch	5AP5120.1906-000	5 W	-	22 W	27 W
21.5" multi-touch	5AP5130.215C-000	4 W	-	15 W	19 W
21.5" multi-touch Expansion unit	5AP5230.215C-000	4 W	-	15 W	19 W
21.5" multi-touch Expansion unit	5AP5230.215I-000	4 W	-	15 W	19 W
24.0" multi-touch	5AP5130.240C-000	5 W	-	24.5 W	29.5 W
24.0" multi-touch Expansion unit	5AP5230.240C-000	5 W	-	24.5 W	29.5 W

Table 32: AP5000 panels - Power calculation

Expansion units	Model number	+5 V	3V3	+12 V	Power consumption Total
Extension options	5ACCKP01.xxxx-000	0.50 W	0.20 W	-	0.70 W
	5ACCKP04.xxxx-000	0.50 W	0.20 W	-	0.70 W

Table 33: AP5000 expansion units - Power calculation

Example

24.0" panel 5AP5230.240C-000	29.5 W	29.5 W
24.0" 5ACCKP01.240C-000 expansion unit	0.7 W	0.7 W
5DLSDL.1001-00 SDL/DVI receiver	8.6 W (with USB consumer)	8.6 W
Total max.:		38.8 W

2.4.3 Block diagrams

The following block diagram shows the simplified structure of the 5DLSDL.1001-00 SDL/DVI receiver link module.

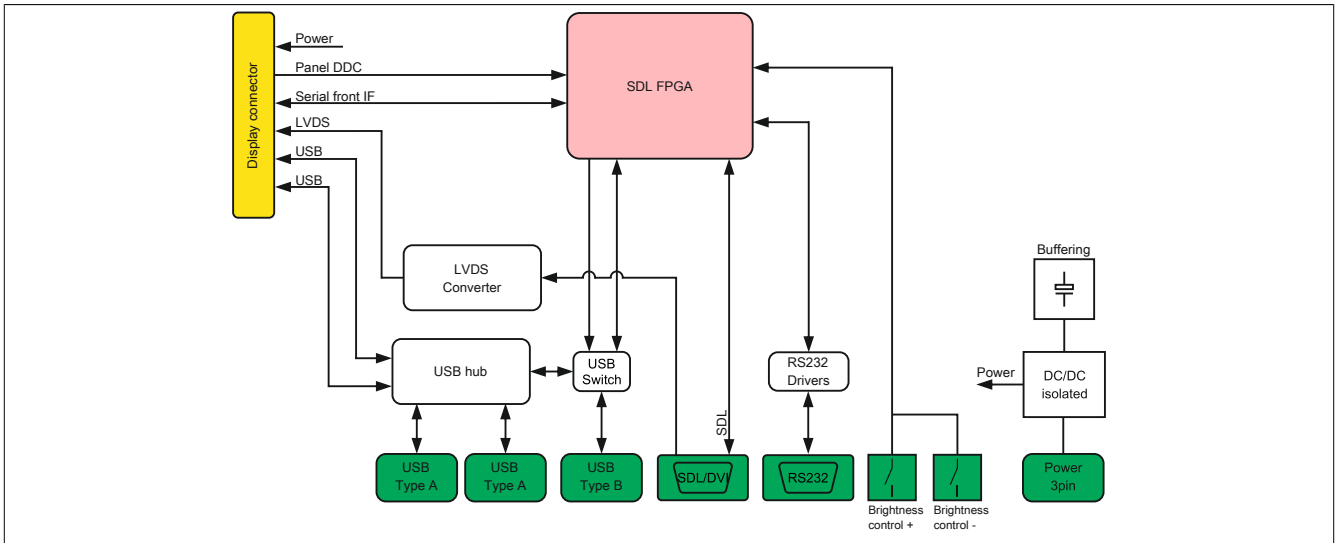

Figure 12: SDL/DVI receiver link module - Block diagram

The following block diagram shows the simplified structure of the 5DLSD3.1001-00 SDL3 receiver link module.

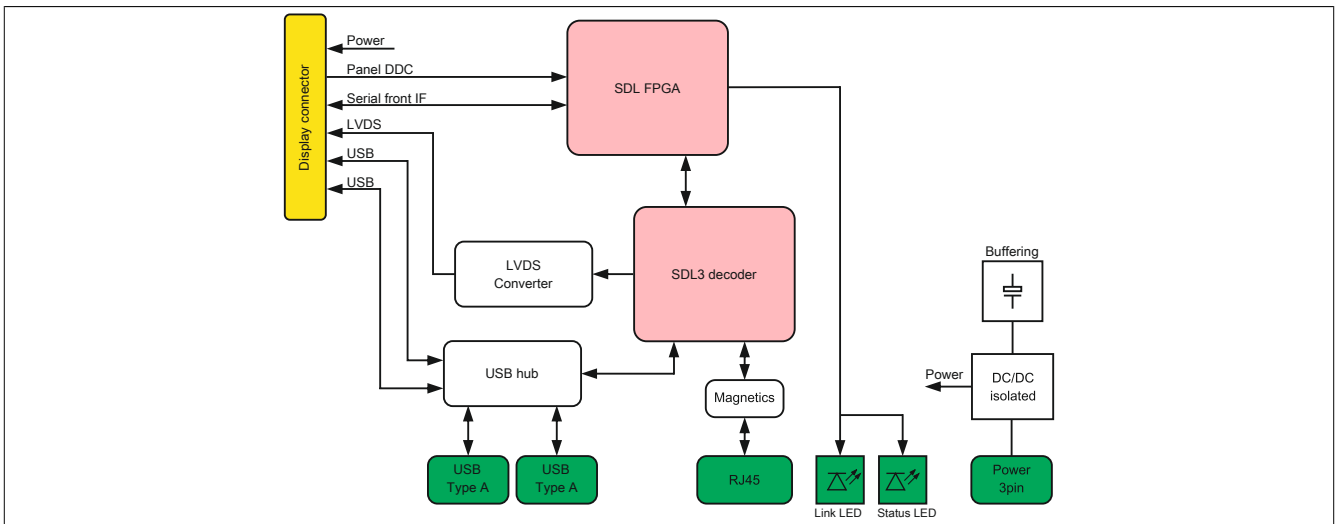

Figure 13: SDL3 receiver link module - Block diagram

The following block diagram shows the simplified structure of the 55DLSD4.1001-00 SDL4 receiver link module.

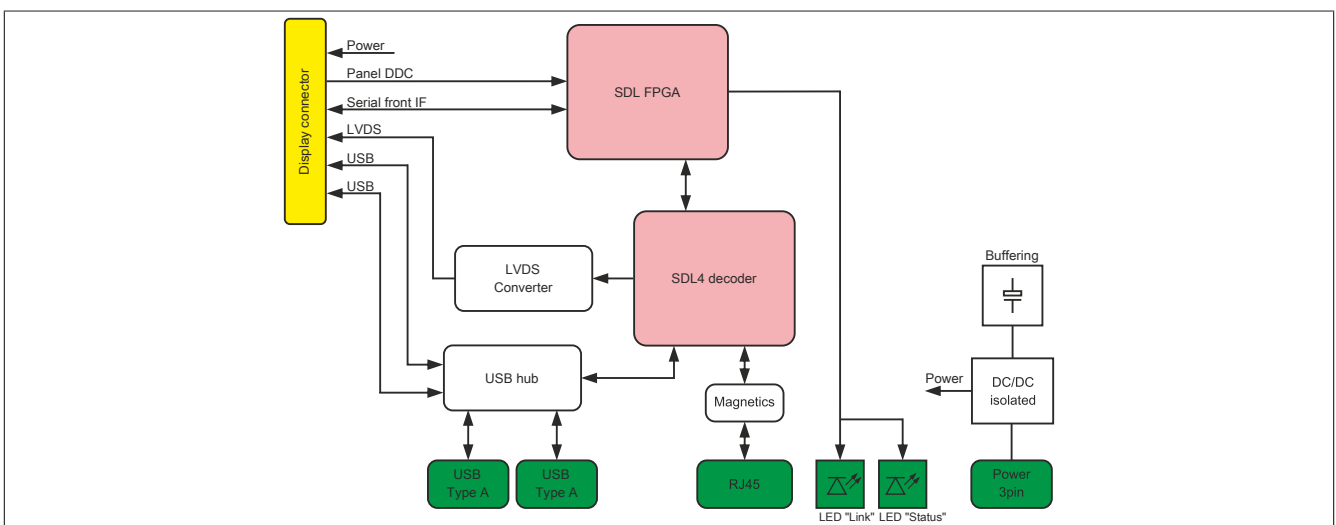

Figure 14: SDL4 receiver link module - Block diagram

2.5 SDL/DVI receiver - 5DLSDL.1001-00 device interfaces

2.5.1 Overview

SDL/DVI receiver interfaces are located on the back of the Automation Panel 5000. To access, the mounting unit on the back must be removed first (see ["Removing the mounting unit cover" on page 134](#)).

Information about SDL/DVI mode can be found in sections ["SDL operation" on page 22](#) and ["DVI operation" on page 24](#).

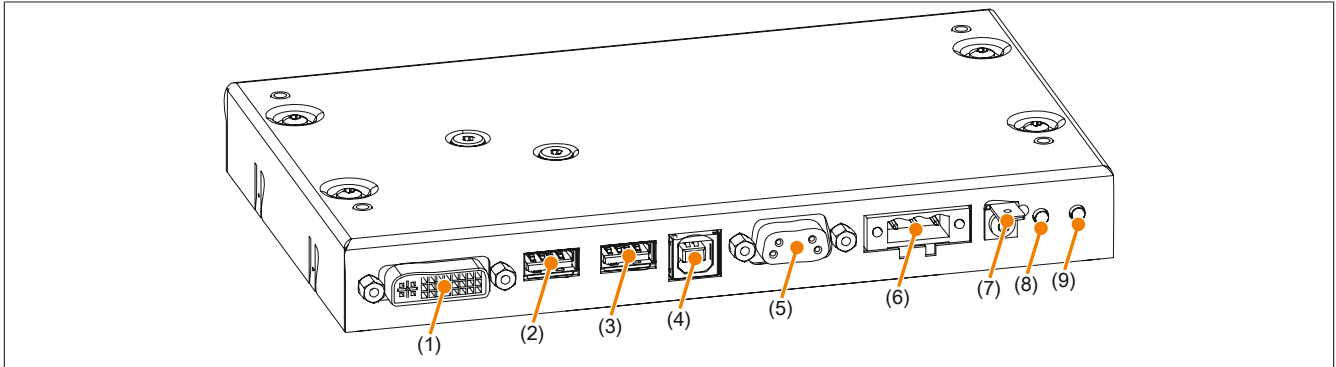

Figure 15: Overview of interfaces - SDL/DVI receiver link module

No.	Type of interface	No.	Type of interface
1	Panel In SDL/DVI	6	24 VDC power
2	USB1	7	Grounding
3	USB2	8	Brightness (DVI) +
4	USB In	9	Brightness (DVI) -
5	COM		

2.5.2 +24 VDC power supply

Danger!

This device is only permitted to be supplied by a SELV/PELV power supply or with safety extra-low voltage (SELV) per EN 60950.

The 3-pin male connector required for connecting the power supply is not included in delivery. It can be ordered from B&R using model number 0TB103.9 (screw clamp terminal block) or 0TB103.91 (cage clamp terminal block).

For the pinout, see the following table. The supply voltage is protected internally by a soldered fuse (10 A, fast-acting) to prevent damage to the device in the event of overload (fuse replacement necessary) or if the voltage supply is connected incorrectly (reverse polarity protection → fuse replacement not necessary). The device must be returned to B&R for repairs if the fuse is destroyed in the event of error.

+24 VDC power supply	
Protected against reverse polarity	
Pin	Description
1	+
2	Functional ground
3	-
Model number	Short description
	Terminal blocks
0TB103.9	Male connector 24 V 5.08 3-pin screw clamp terminal block
0TB103.91	Male connector 24 V 5.08 3-pin cage clamp terminal block

3-pin male power supply connector
+24 VDC power supply



Table 34: +24 VDC voltage supply connection

Electrical characteristics	
Nominal voltage	24 VDC ±25%, SELV ¹⁾
Nominal current	Max. 3 A
Overvoltage category in accordance with EN 61131-2	II
Electrical isolation	Yes
Uninterruptible power supply	No

1) EN 60950 requirements must be observed.

2.5.2.1 Grounding

Caution!

Functional ground (pin 2 of power supply and ground connection) must be kept as short as possible and connected to the largest possible wire cross section at the central grounding point (e.g. the control cabinet or system).

The ground connection is located next to the power supply for the link module.

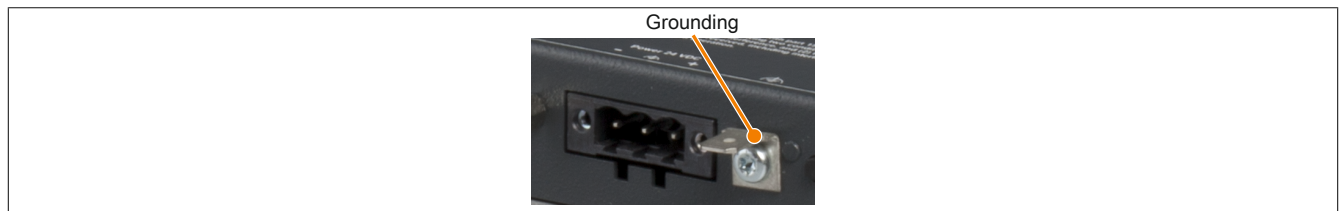

Figure 16: Ground connection

The ground connection must be used, for example, to fasten a copper strip to a central grounding point in the control cabinet or system where the device is installed. The largest possible conductor cross section should be used (at least 2.5 mm²).

2.5.3 Panel In interface

The Panel In interface can be used for SDL or DVI transfer. For more information, see "SDL operation" on page 22 and "DVI operation" on page 24.

Panel In interface - SDL (Smart Display Link) / DVI	
The following overview lists the video signals available on the panel input. For additional details, see the technical data for the link module or panel being used.	
Link module	Video signals
5DLSDL.1001-00	SDL, DVI



Table 35: Panel In interface - SDL, DVI

Information:

The hardware and graphics drivers of approved operating systems support the hot plugging of display devices to the Panel In interface for service purposes. The panel connector is specified for max. 100 connection cycles.

Information:

If a display device with touch screen is connected to the Panel In interface and then disconnected again during operation (hot plugging), it may be necessary to recalibrate the touch screen.

2.5.3.1 Pinout

Pin	Assignment	Description	Pin	Assignment	Description
1	TMDS data 2-	DVI lane 2 (negative)	16	HPD	Hot plug detect
2	TMDS data 2+	DVI lane 2 (positive)	17	TMDS data 0-	DVI lane 0 (negative)
3	TMDS data 2/4 SHIELD	Shield for data pair 2 and 4	18	TMDS data 0+	DVI lane 0 (positive)
4	SDL-	SDL lane (negative)	19	TMDS Data 0/ XUSB1 SHIELD	Shield for data pair 0 and USB1
5	SDL+	SDL lane (positive)	20	XUSB1-	USB lane 1 (negative)
6	DDC clock	DDC-based control signal (clock)	21	XUSB1+	USB lane 1 (positive)
7	DDC data	DDC-based control signal (data)	22	TMDS clock shield	Shield for clock pair
8	N/C	Not connected	23	TMDS clock+	DVI clock (positive)
9	TMDS data 1-	DVI lane 1 (negative)	24	TMDS clock -	DVI clock (negative)
10	TMDS DATA 1+	DVI lane 1 (negative) HDMI clock (positive)	C1	N/C	Not connected
11	TMDS DATA 1/ XUSB0 SHIELD	Shield for data pair 1 and USB0	C2	N/C	Not connected
12	XUSB0-	USB lane 0 (negative)	C3	N/C	Not connected
13	XUSB0+	USB lane 0 (positive)	C4	N/C	Not connected
14	+5 V power	+5 V power supply	C5	N/C	Not connected
15	Ground (return for +5 V, HSync and VSync)	Ground			

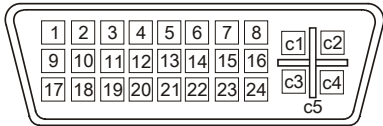

Table 36: DVI interface - Pinout

2.5.3.2 USB transfer in SDL and DVI mode

Information:

The USB transfer rate is limited to USB 1.1 in SDL mode.

In DVI mode, the maximum USB transfer rate depends on the USB interface and USB hub on the industrial PC.

2.5.3.3 Cable lengths and resolutions for SDL transmission

The following table lists the relationship between segment lengths and maximum resolution depending on the SDL cable being used:

SDL cable Segment length [m]	Resolution						
	VGA 640 x 480	SVGA 800 x 600	XGA 1024 x 768	HD 1366 x 768	SXGA 1280 x 1024	UXGA 1600 x 1200	FHD 1920 x 1080
0.8	5CASDL.0008-00	5CASDL.0008-00	5CASDL.0008-00	5CASDL.0008-00	5CASDL.0008-00	5CASDL.0008-00	5CASDL.0008-00
1.8	5CASDL.0018-00	5CASDL.0018-00	5CASDL.0018-00	5CASDL.0018-00	5CASDL.0018-00	5CASDL.0018-00	5CASDL.0018-00
	5CASDL.0018-01	5CASDL.0018-01	5CASDL.0018-01	5CASDL.0018-01	5CASDL.0018-01	5CASDL.0018-01	5CASDL.0018-01
	5CASDL.0018-03	5CASDL.0018-03	5CASDL.0018-03	5CASDL.0018-03	5CASDL.0018-03	5CASDL.0018-03	5CASDL.0018-03
5	5CASDL.0050-00	5CASDL.0050-00	5CASDL.0050-00	5CASDL.0050-00	5CASDL.0050-00	5CASDL.0050-00	5CASDL.0050-00
	5CASDL.0050-01	5CASDL.0050-01	5CASDL.0050-01	5CASDL.0050-01	5CASDL.0050-01	5CASDL.0050-01	5CASDL.0050-01
	5CASDL.0050-03	5CASDL.0050-03	5CASDL.0050-03	5CASDL.0050-03	5CASDL.0050-03	5CASDL.0050-03	5CASDL.0050-03
10	5CASDL.0100-00	5CASDL.0100-00	5CASDL.0100-00	5CASDL.0100-00	5CASDL.0100-00	5CASDL.0100-00	5CASDL.0100-00
	5CASDL.0100-01	5CASDL.0100-01	5CASDL.0100-01	5CASDL.0100-01	5CASDL.0100-01	5CASDL.0100-01	5CASDL.0100-01
	5CASDL.0100-03	5CASDL.0100-03	5CASDL.0100-03	5CASDL.0100-03	5CASDL.0100-03	5CASDL.0100-03	5CASDL.0100-03
15	5CASDL.0150-00	5CASDL.0150-00	5CASDL.0150-00	5CASDL.0150-00	5CASDL.0150-00	-	-
	5CASDL.0150-01	5CASDL.0150-01	5CASDL.0150-01	5CASDL.0150-01	5CASDL.0150-01	-	-
	5CASDL.0150-03	5CASDL.0150-03	5CASDL.0150-03	5CASDL.0150-03	5CASDL.0150-03	-	5CASDL.0150-03
20	5CASDL.0200-00	5CASDL.0200-00	5CASDL.0200-00	5CASDL.0200-00	5CASDL.0200-00	-	-
	5CASDL.0200-03	5CASDL.0200-03	5CASDL.0200-03	5CASDL.0200-03	5CASDL.0200-03	-	5CASDL.0200-03
25	5CASDL.0250-00	5CASDL.0250-00	5CASDL.0250-00	5CASDL.0250-00	-	-	-
	5CASDL.0250-03	5CASDL.0250-03	5CASDL.0250-03	5CASDL.0250-03	-	-	-
30	5CASDL.0300-00	5CASDL.0300-00	-	-	-	-	-
	5CASDL.0300-03	5CASDL.0300-03	-	-	-	-	-

Table 37: Cable lengths and resolutions for SDL transmission

5CASDL.0xxx-01 SDL cables are routed through the swing arm shaft with the straight connector; the 45° connector is used on the industrial PC side.

2.5.3.4 Cable lengths and resolutions for DVI transfer

The following table shows the relationship between segment length and maximum resolution depending on the DVI cable:

DVI cable Segment length [m]	Resolution						
	VGA 640 x 480	SVGA 800 x 600	XGA 1024 x 768	HD 1366 x 768	SXGA 1280 x 1024	UXGA 1600 x 1200	FHD 1920 x 1080
1.8	5CADVI.0018-00	5CADVI.0018-00	5CADVI.0018-00	5CADVI.0018-00	5CADVI.0018-00	5CADVI.0018-00	5CADVI.0018-00
5	5CADVI.0050-00	5CADVI.0050-00	5CADVI.0050-00	5CADVI.0050-00	5CADVI.0050-00	5CADVI.0050-00	5CADVI.0050-00

Table 38: Cable lengths and resolutions for DVI transfer

The maximum cable length for DVI transfer is limited to 5 m due to the USB specification.

2.5.4 USB interfaces

The link module is equipped with a USB 2.0 (Universal Serial Bus) host controller with multiple USB interfaces, 2 of which are accessible externally for the user.

Warning!

Peripheral USB devices can be connected to the USB interfaces. Due to the large number of USB devices available on the market, B&R cannot guarantee their functionality. Functionality is ensured when using the USB devices available from B&R.

Caution!

Because this interface is designed according to general PC specifications, extreme care should be exercised with regard to EMC, cable routing, etc.

USB1, USB2

The USB1 and USB2 interfaces are available for the user to connect USB devices.

Depending on the transfer method (SDL or DVI mode), the transfer rate of the USB1 and USB2 interfaces may be limited. Possible transfer methods are listed in section "Connection options" on page 22.

Transfer method	USB type	Max. cable length
SDL mode 1	USB 1.1	25 m ¹⁾
SDL mode 2	USB 2.0	5 m
DVI mode, single-touch	USB 2.0	5 m
DVI mode, multi-touch	USB 2.0	5 m

1) The max. cable length of 25 m depends on the resolution; see table "Cable lengths and resolutions for SDL transmission" on page 51 for exact specifications.

Universal Serial Bus (USB1, USB2) ¹⁾	
Type	USB 2.0
Design	Type A
Transfer rate	Low speed (1.5 Mbit/s), full speed (12 Mbit/s), high speed (480 Mbit/s)
Current-carrying capacity ²⁾ USB1, USB2	Total max. 1 A
Cable length USB 2.0	Max. 5 m (without hub)

2x USB type A, female

USB1



USB2

Table 39: USB1/USB2 interface

- 1) The interfaces, etc. available on the device or module have been numbered as such for easy identification. This numbering may differ from that used by the particular operating system.
- 2) Each USB interface is protected by a shared, maintenance-free "USB current-limiting circuit breaker" (total max. 1 A).

Front USB interface

Expansion units are equipped with a USB 2.0 interface on the front. For more information, see section "USB interface" on page 65.

USB interface on mounting unit

Mounting unit 5ACCMA00.0001-000 is equipped with a USB 2.0 interface on the side. For more information, see section "USB interface" on page 113.

2.5.5 USB In interface

The USB In interface is a USB 2.0 type B interface that is used to transfer USB data. It must be connected to the USB interface on the output device (e.g. B&R Industrial PC) when using DVI mode or SDL operating mode 2 as the transfer method. Possible transfer methods are listed in section "Connection options" on page 22.

If the interface is connected to an output device (B&R Industrial PC), then USB 2.0 transfer rates are possible on the USB1 and USB2 interfaces.

USB In interface ¹⁾	
Type	USB 2.0
Design	Type B
Transfer rate	Low speed (1.5 Mbit/s), full speed (12 Mbit/s), high speed (480 Mbit/s)
Current-carrying capacity ²⁾	Max. 500 mA
Cable length	Max. 5 m (without hub)

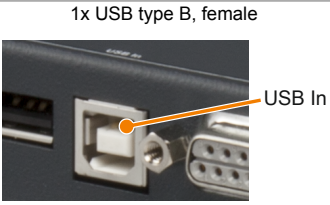

Table 40: USB In interface

- 1) The interfaces, etc. available on the device or module have been numbered as such for easy identification. This numbering may differ from that used by the particular operating system.
- 2) Each USB interface is protected by a maintenance-free "USB current-limiting circuit breaker" (max. 500 mA).

2.5.6 COM serial interface

The serial interface is only available for use with single-touch displays in DVI mode. It is used to transfer data from the resistive touch screen and must be connected to a serial interface on the output device.

COM serial interface ¹⁾	
RS232	
Type	RS232, modem-capable, not electrically isolated
UART	16550-compatible, 16-byte FIFO
Transfer rate	Max. 115 kbit/s
Bus length	Max. 15 m
Pin	Assignment
1	N/C
2	RXD
3	TXD
4	N/C
5	GND
6	N/C
7	RTS
8	CTS
9	N/C

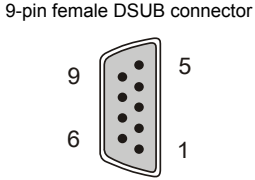

Table 41: COM - Pinout

- 1) The interfaces, etc. available on the device or module have been numbered as such for easy identification. This numbering may differ from that used by the particular operating system.

2.5.7 Brightness controls

The brightness controls can be used to configure the brightness of the backlight on the Automation Panel in DVI mode. These buttons have no effect in SDL mode; in this case, the brightness can be configured in the B&R Control Center, for example.

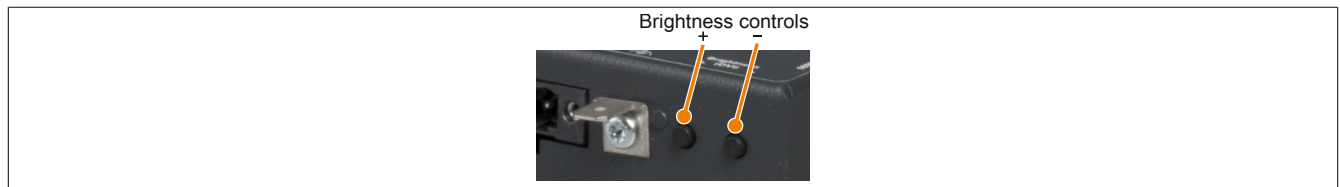

Figure 17: Brightness controls

2.6 5DLSD3.1001-00 SDL3 receiver - Device interfaces

2.6.1 Overview

SDL3 receiver interfaces are located on the back of the Automation Panel 5000. To access, the mounting unit on the back must be removed first (see ["Removing the mounting unit cover"](#) on page 134).

Information about SDL3 mode can be found in section ["SDL3 mode"](#) on page 25.

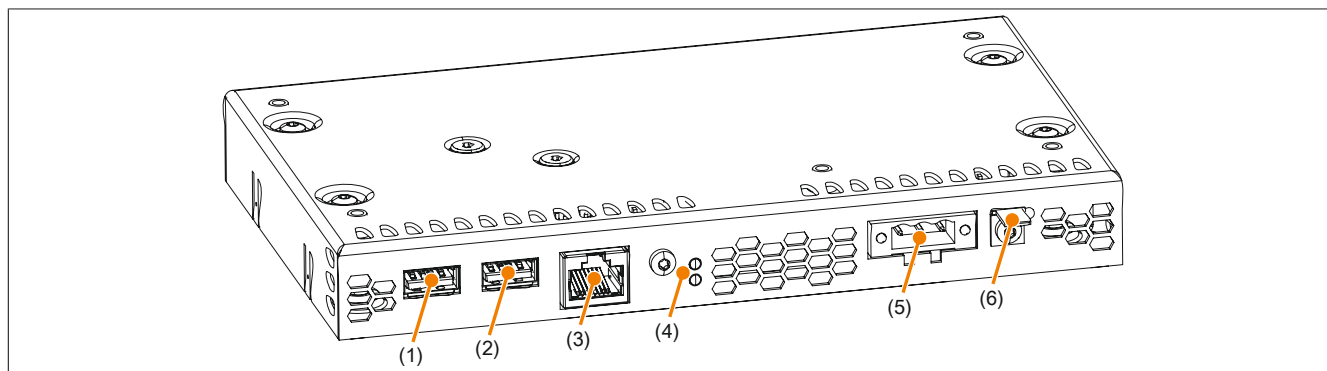

Figure 18: Overview of interfaces - SDL3 receiver link module

No.	Type of interface	No.	Type of interface
1	USB1	4	SDL3 In LEDs
2	USB2	5	24 VDC power
3	SDL3 In	6	Grounding
	"USB interfaces"		"SDL3 In LEDs"
	"USB interfaces"		"+24 VDC power supply"
	"SDL3 In interface"		"Grounding"

2.6.2 +24 VDC power supply

Danger!

This device is only permitted to be supplied by a SELV/PELV power supply or with safety extra-low voltage (SELV) per EN 60950.

The 3-pin male connector required for connecting the power supply is not included in delivery. It can be ordered from B&R using model number 0TB103.9 (screw clamp terminal block) or 0TB103.91 (cage clamp terminal block).

For the pinout, see the following table. The supply voltage is protected internally by a soldered fuse (10 A, fast-acting) to prevent damage to the device in the event of overload (fuse replacement necessary) or if the voltage supply is connected incorrectly (reverse polarity protection → fuse replacement not necessary). The device must be returned to B&R for repairs if the fuse is destroyed in the event of error.

+24 VDC power supply	
Protected against reverse polarity	
Pin	Description
1	+
2	Functional ground
3	-
Model number	Short description
	Terminal blocks
0TB103.9	Male connector 24 V 5.08 3-pin screw clamp terminal block
0TB103.91	Male connector 24 V 5.08 3-pin cage clamp terminal block

3-pin male power supply connector
+24 VDC power supply

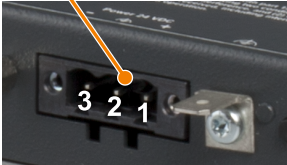

Table 42: +24 VDC voltage supply connection

Electrical characteristics	
Nominal voltage	24 VDC ±25%, SELV ¹⁾
Nominal current	Max. 3 A
Overvoltage category in accordance with EN 61131-2	II
Electrical isolation	Yes
Uninterruptible power supply	No

1) EN 60950 requirements must be observed.

2.6.2.1 Grounding

Caution!

Functional ground (pin 2 of power supply and ground connection) must be kept as short as possible and connected to the largest possible wire cross section at the central grounding point (e.g. the control cabinet or system).

The ground connection is located next to the power supply for the link module.

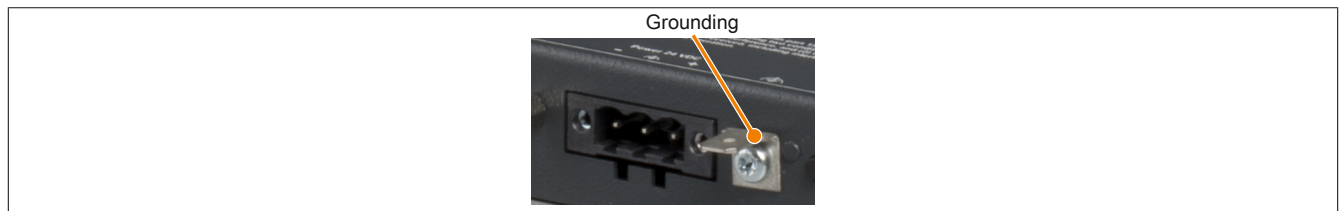

Figure 19: Ground connection

The ground connection must be used, for example, to fasten a copper strip to a central grounding point in the control cabinet or system where the device is installed. The largest possible conductor cross section should be used (at least 2.5 mm²).

2.6.3 SDL3 In interface

The SDL3 In interface is a female RJ45 connector and operated with SDL3 transmission technology. For more information, see section "SDL3 mode" on page 25.

SDL3 In interface - SDL3	
The following overview lists the video signals available on the panel input. For additional details, see the technical data for the link module or panel being used.	
Link module	Video signals
5DLSD3.1001-00	SDL3

Female RJ45 connector

1

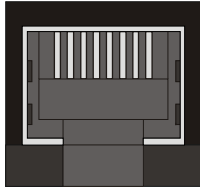

Table 43: SDL3 In interface

Information:

The hardware and graphics drivers of approved operating systems support the hot plugging of display devices to the SDL3 In interface for service purposes. The female RJ45 connector is specified for 500 connection cycles.

Information:

If a display device with touch screen is connected to the SDL3 In interface and then disconnected again during operation (hot plugging), it may be necessary to recalibrate the touch screen.

2.6.3.1 Cable lengths and resolutions for SDL3 transmission

The maximum cable length for SDL3 transfers is 100 m with a B&R SDL3/SDL4 cable (regardless of the panel resolution).

2.6.4 SDL3 In LEDs

The SDL3 In LEDs are located next to the SDL3 In interface.

SDL3 In LEDs			
LED	Color	Status	Function
Link	Yellow	On	Indicates an active SDL3 connection
		Off	No active SDL3 connection
Status	Yellow	On	SDL3 connection established and OK
		Off	No active SDL3 connection
		Blinking	Indicates the SDL3 connection is OK, but a firmware image is corrupt



Table 44: SDL3 In LEDs

2.6.5 USB interfaces

The link module is equipped with a USB 2.0 (Universal Serial Bus) host controller with multiple USB interfaces, 2 of which are accessible externally for the user.

Warning!

Peripheral USB devices can be connected to the USB interfaces. Due to the large number of USB devices available on the market, B&R cannot guarantee their functionality. Functionality is ensured when using the USB devices available from B&R.

Caution!

Because this interface is designed according to general PC specifications, extreme care should be exercised with regard to EMC, cable routing, etc.

USB1, USB2

The USB1 and USB2 interfaces are available for the user to connect USB devices.

Universal Serial Bus (USB1, USB2) ¹⁾	
Type	USB 2.0
Design	Type A
Transfer rate	Low speed (1.5 Mbit/s), full speed (12 Mbit/s), high speed (30 Mbit/s)
Current-carrying capacity ²⁾ USB1, USB2	Total max. 1 A
Cable length USB 2.0	Max. 5 m (without hub)

2x USB type A, female

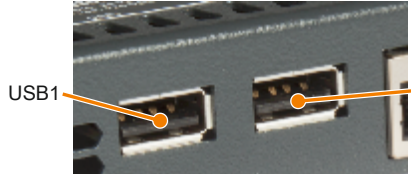

Table 45: USB1/USB2 interface

- 1) The interfaces, etc. available on the device or module have been numbered as such for easy identification. This numbering may differ from that used by the particular operating system.
- 2) The USB interfaces are protected by a shared, maintenance-free "USB current-limiting circuit breaker" (total max. 1 A).

Front USB interface

Expansion units are equipped with a USB 2.0 interface on the front. For more information, see section "[USB interface](#)" on page 65.

USB interface on mounting unit

Mounting unit 5ACCMA00.0001-000 is equipped with a USB 2.0 interface on the side. For more information, see section "[USB interface](#)" on page 113.

2.7 5DLSD4.1001-00 SDL4 receiver - Device interfaces

2.7.1 Overview

SDL4 receiver interfaces are located on the back of the Automation Panel 5000. To access, the mounting unit on the back must be removed first (see ["Removing the mounting unit cover" on page 134](#)).

For information about SDL4 mode, see section ["SDL4 operation" on page 26](#). TBD

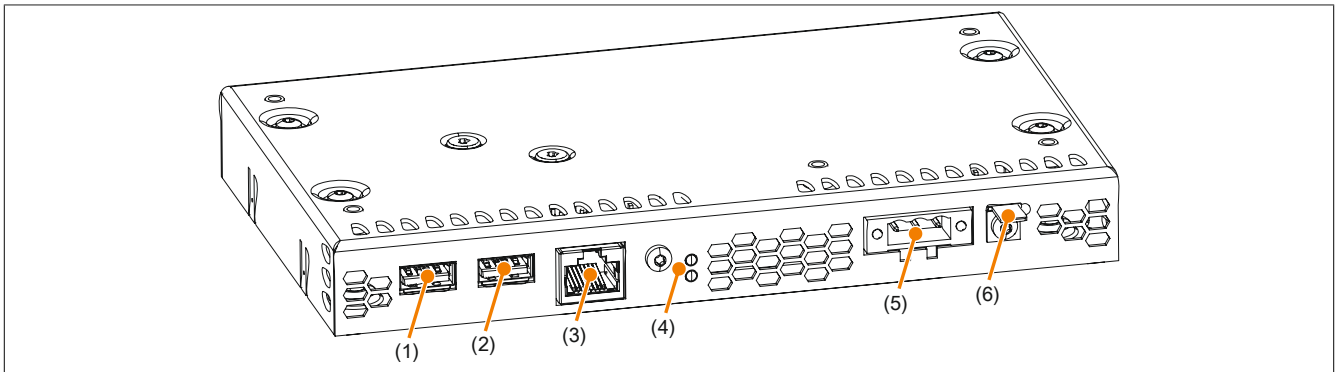

Figure 20: Overview of interfaces - SDL4 receiver link module

No.	Type of interface	No.	Type of interface
1	USB1	4	SDL4 In LEDs
2	USB2	5	24 VDC power
3	SDL4 In	6	Grounding
	"USB interfaces"		"SDL4 In LEDs"
	"USB interfaces"		"+24 VDC power supply"
	"SDL4 In interface"		"Grounding"

2.7.2 +24 VDC power supply

Danger!

This device is only permitted to be supplied by a SELV/PELV power supply or with safety extra-low voltage (SELV) per EN 60950.

The 3-pin male connector required for connecting the power supply is not included in delivery. It can be ordered from B&R using model number 0TB103.9 (screw clamp terminal block) or 0TB103.91 (cage clamp terminal block).

For the pinout, see the following table. The supply voltage is protected internally by a soldered fuse (10 A, fast-acting) to prevent damage to the device in the event of overload (fuse replacement necessary) or if the voltage supply is connected incorrectly (reverse polarity protection → fuse replacement not necessary). The device must be returned to B&R for repairs if the fuse is destroyed in the event of error.

+24 VDC power supply	
Protected against reverse polarity	
Pin	Description
1	+
2	Functional ground
3	-
Model number	Short description
	Terminal blocks
0TB103.9	Male connector 24 V 5.08 3-pin screw clamp terminal block
0TB103.91	Male connector 24 V 5.08 3-pin cage clamp terminal block

3-pin male power supply connector
+24 VDC power supply



Table 46: +24 VDC voltage supply connection

Electrical characteristics	
Nominal voltage	24 VDC ±25%, SELV ¹⁾
Nominal current	Max. 3 A
Overvoltage category in accordance with EN 61131-2	II
Electrical isolation	Yes
Uninterruptible power supply	No

1) EN 60950 requirements must be observed.

2.7.2.1 Grounding

Caution!

Functional ground (pin 2 of power supply and ground connection) must be kept as short as possible and connected to the largest possible wire cross section at the central grounding point (e.g. the control cabinet or system).

The ground connection is located next to the power supply for the link module.

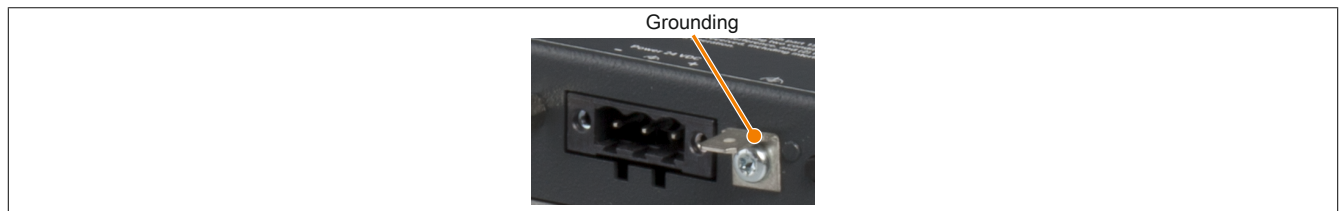

Figure 21: Ground connection

The ground connection must be used, for example, to fasten a copper strip to a central grounding point in the control cabinet or system where the device is installed. The largest possible conductor cross section should be used (at least 2.5 mm²).

2.7.3 SDL4 In interface

The SDL4 In interface is a female RJ45 connector and operated with SDL4 transmission technology. For more information, see section "SDL4 operation" on page 26.

SDL4 In interface - SDL4	
The following overview shows the possible video signals available on the Panel input. For additional details, see the technical data for the link module or panel being used.	
Link module	Video signals
5DLSD4.1001-00	SDL4

RJ45 connector, female

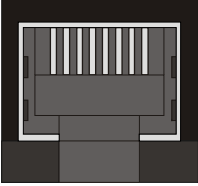

Table 47: SDL4 In interface

Information:

Hot plugging display devices on the SDL4 In interface for service purposes is supported by the hardware and graphics drivers of approved operating systems. The female RJ45 connector is specified for 500 connection cycles.

Information:

If a display device with touch screen is connected to the SDL4 In interface and then disconnected again during operation (hot plugging), it may be necessary to recalibrate the touch screen.

2.7.3.1 Cable lengths and resolutions for SDL4 transfer

The maximum cable length for SDL4 transfers is 100 m with a B&R "SDL3/SDL4 cables" (regardless of the panel resolution).

2.7.4 SDL4 In LEDs

The SDL4 In LEDs are located next to the SDL4 In interface.

SDL4 In LEDs			
LED	Color	Status	Explanation
Link	Yellow	On	Indicates an active SDL4 connection.
		Off	No active SDL4 connection.
Status	Yellow	On	The SDL4 connection is established and OK.
		Off	No active SDL4 connection.
		Blinking	Indicates the SDL4 connection is OK, but a firmware image is corrupt

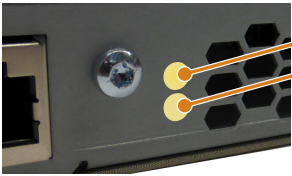

Table 48: SDL4 In LEDs

2.7.5 USB interfaces

The link module is equipped with a Universal Serial Bus 2.0 (USB) host controller with multiple USB interfaces, 2 of which are accessible externally for the user.

Warning!

Peripheral USB devices can be connected to the USB interfaces. Due to the large number of USB devices available on the market, B&R cannot guarantee their functionality. Functionality is ensured when using the USB devices available from B&R.

Caution!

Because this interface is designed according to general PC specifications, extreme care should be taken with regard to EMC, wiring, etc.

USB1, USB2

The USB1 and USB2 interfaces are available for the user to connect USB devices.

Universal Serial Bus (USB1, USB2) ¹⁾	
Type	USB 2.0
Design	Type A
Transfer rate	Low speed (1.5 Mbit/s), full speed (12 Mbit/s), high speed (150 Mbit/s)
Current-carrying capacity ²⁾ USB1, USB2	Total max. 1 A
Cable length USB 2.0	Max. 5 m (without hub)

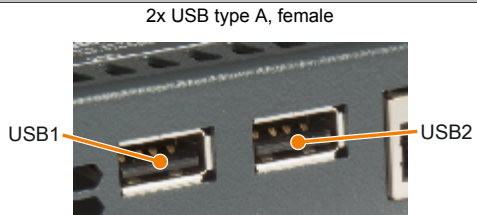

Table 49: USB1/USB2 interface

- 1) The interfaces, etc. available on the device or module have been numbered as such for the purpose of clear differentiation. This numbering may deviate from the numbering used by the respective operating system, however.
- 2) The USB interfaces are protected by a shared maintenance-free "USB current-limiting switch" (total max. 1 A).

Front USB interface

Expansion units are equipped with a USB 2.0 interface on the front. For more information, see section "[USB interface](#)" on page 65.

USB interface on mounting unit

Mounting unit 5ACCMA00.0001-000 is equipped with a USB 2.0 interface on the side. For more information, see section "[USB interface](#)" on page 113.

2.8 Equipping panels with expansion units

Expansion options can be installed on AP5230 panels. There are two types of expansion options:

- Expansion cover
- Expansion unit with operating elements

Expansion covers (5ACCKP00.xxxx-000)

Expansion covers are not equipped by B&R with operating elements. Depending on the variant, 7 to 14 cutouts are available to be equipped with operating elements by the user.

Expansion units with operating elements (5ACCKP01.xxxx-000 and 5ACCKP04.xxxx-000)

Expansion units with operating elements are equipped with a USB interface on the front, green and red pushbuttons, selector switch or blue pushbutton, key switch and emergency stop device. For details, see "Expansion units" on page 120.

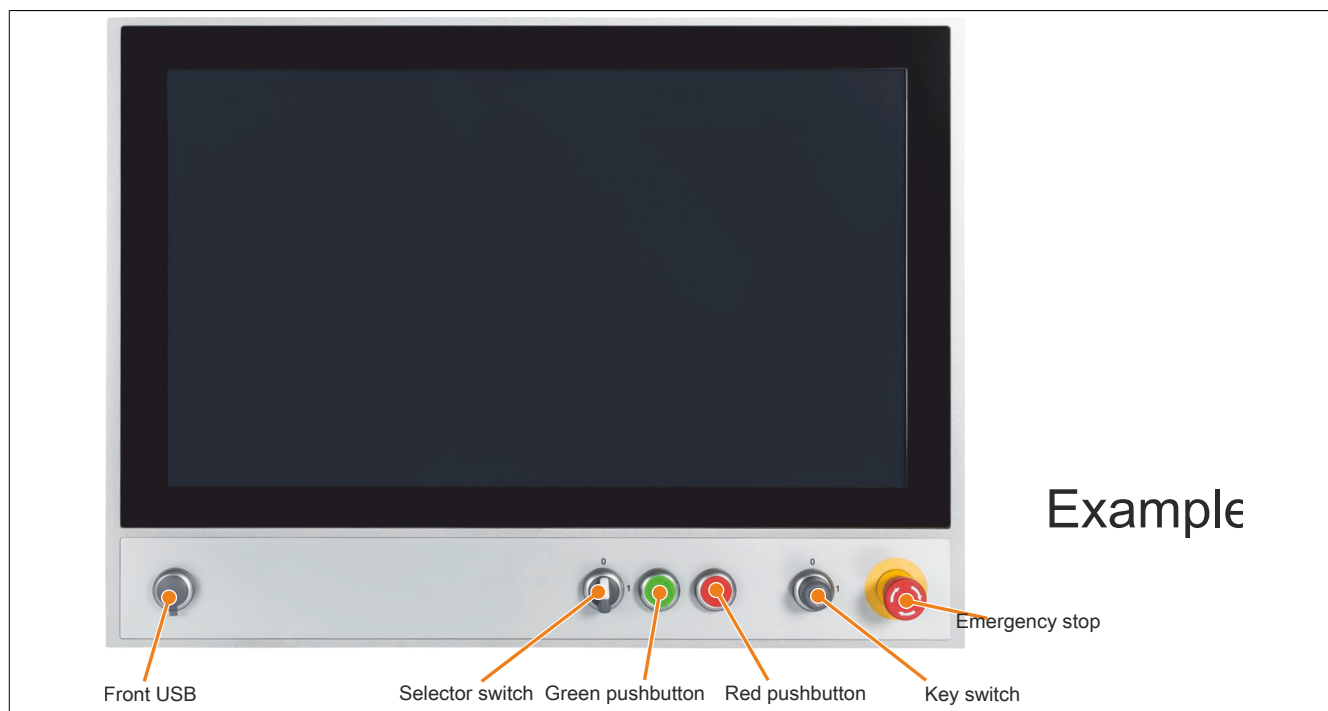

Figure 22: Panel with expansion unit and operating elements - Front view

2.8.1 Button/Switching elements

Button/Switch	Actuating element used	Switching element
Selector switch	"Selector switch RAFIX 22 FS+, 1.30.272.102/2200" on page 204	"Switching element RAFIX 22 FS universal, 1.20.126.005/0000" on page 205
Blue pushbutton	"Pushbutton RAFIX 22 FS+, 1.30.270.021/2600" on page 204	"Switching element RAFIX 22 FS universal, 1.20.126.005/0000" on page 205
Green pushbutton	"Pushbutton RAFIX 22 FS+, 1.30.270.021/2500" on page 204	"Switching element RAFIX 22 FS universal, 1.20.126.005/0000" on page 205
Red pushbutton	"Pushbutton RAFIX 22 FS+, 1.30.270.021/2300" on page 204	"Switching element RAFIX 22 FS universal, 1.20.126.005/0000" on page 205
Key switch	"Key switch RAFIX 22 FS+, 1.30.255.222/0000" on page 205	"Switching element RAFIX 22 FS universal, 1.20.126.005/0000" on page 205
Emergency stop	"Emergency stop RAFIX 22 FS+ "Plus 1", 1.30.273.512/0300" on page 205	"Switching element RAFIX 22 FS+ PCB gold, 1.20.126.414/0000" on page 205

Table 50: Operating elements used

2.8.2 Button, switch and LED configuration

Each button and LED can be individually configured and adapted to the application. Several B&R tools are available for this:

- B&R Key Editor, B&R KCF Editor or B&R Control Center for Windows operating systems
- Visual Components for Automation Runtime

Buttons and LEDs from each panel are processed by the matrix controller in a bit string of 128 bits each.

The positions of buttons and LEDs in the matrix are shown as hardware numbers. The hardware numbers can be read directly on the target system using the B&R Key Editor; B&R KCF Editor or B&R Control Center.

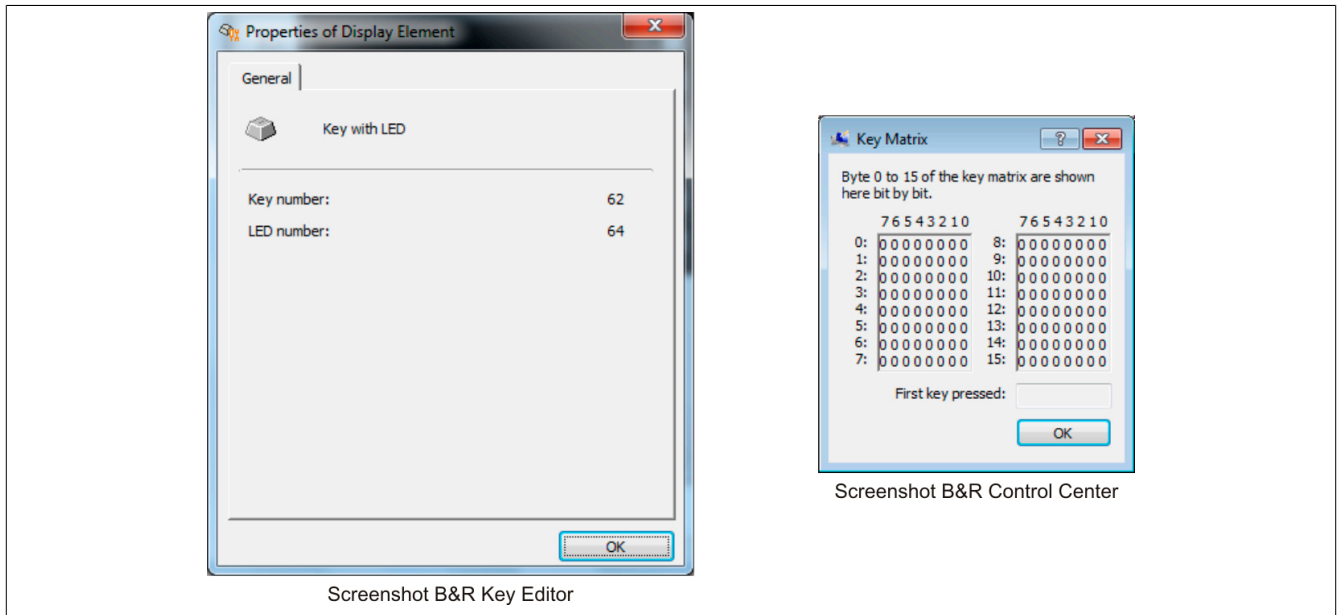
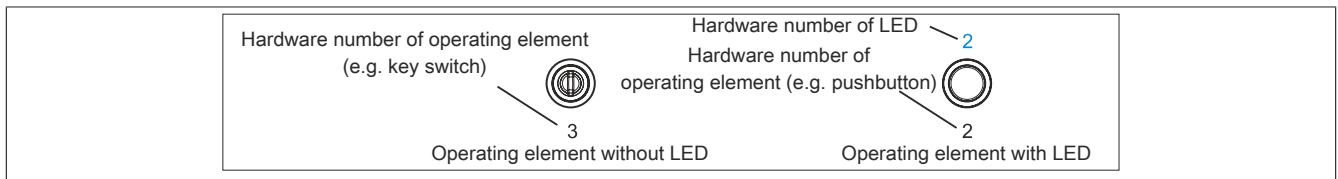

Figure 23: Hardware numbers in the B&R Key Editor and B&R Control Center

The following graphics show the positions of the buttons and LEDs in the matrix. They are represented as follows.



The following configuration applies to the following panels with installed expansion unit 5ACCKP01.xxxx-000 or 5ACCKP04.xxxx-000:

- 5AP5230.156B-000
- 5AP5230.156C-000
- 5AP5230.185B-000
- 5AP5230.185C-000
- 5AP5230.215C-000
- 5AP5230.215I-000
- 5AP5230.240C-000

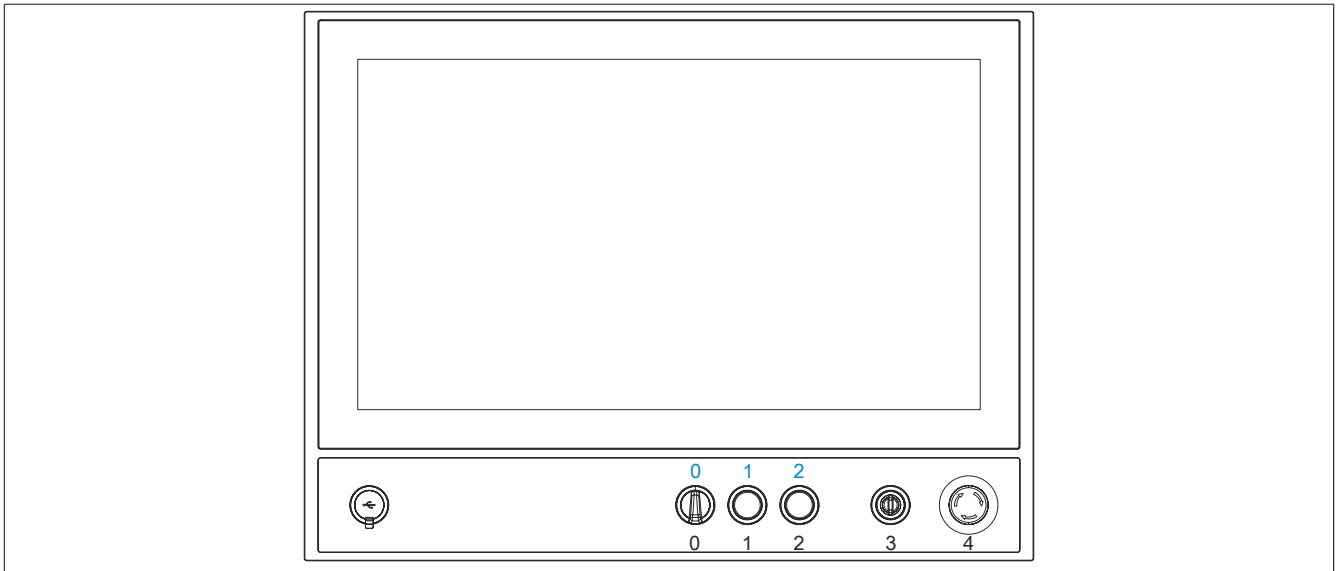

Figure 24: AP5230 (landscape) - Button, switch and LED configuration

2.8.3 USB interface

Panels with expansion options are equipped with a USB 2.0 interface on the front. This is equipped with a protective cover.

Caution!

IP65 protection can only be achieved if the USB protective cover is properly installed.

Warning!

Peripheral USB devices can be connected to the USB interfaces. Due to the large number of USB devices available on the market, B&R cannot guarantee their functionality. Functionality is ensured when using the USB devices available from B&R.

Caution!

Because this interface is designed according to general PC specifications, extreme care should be taken with regard to EMC, wiring, etc.

Front USB

The front USB interface is available to the user for service purposes.

Depending on the transfer method (SDL or DVI mode), the transfer rate of the USB1 and USB2 interfaces may be limited. For possible transfer methods, see section "Connection options" on page 22.

Transfer method	USB type	Max. cable length
SDL mode 1	USB 1.1	25 m
SDL mode 2	USB 2.0	5 m
DVI mode, single-touch	USB 2.0	5 m
DVI mode, multi-touch	USB 2.0	5 m
SDL3 mode	USB 2.0	100 m

Universal Serial Bus (front USB) ¹⁾		1x USB type A, female 
Type	USB 2.0	
Design	Type A	
Transfer rate	Low speed (1.5 Mbit/s), full speed (12 Mbit/s), high speed (480 Mbit/s) ²⁾	
Current-carrying capacity ³⁾ Front USB	Max. 500 mA	
Cable length USB 2.0	<3 m (without hub)	

Table 51: Front USB interface

- 1) The interfaces, etc. available on the device or module have been numbered as such for the purpose of clear differentiation. This numbering may deviate from the numbering used by the respective operating system, however.
- 2) In SDL3 operation: Low speed (1.5 Mbit/s), full speed (12 Mbit/s), high speed (30 Mbit/s).
In SDL4 operation: Low speed (1.5 Mbit/s), full speed (12 Mbit/s), high speed (150 Mbit/s).
- 3) The USB interface is protected by a maintenance-free "USB current-limiting switch" (max. 500 mA).

2.8.4 Button/Switch interface

The button/switch interface can be used to externally wire button and switching elements. It is located inside the panel on the expansion unit. To access, the cover on the back for the expansion option must be removed first (see "Installing the expansion unit / expansion cover" on page 147). Button and switching elements are wired using the 9-pin terminal strip and a screwdriver.

Button/Switch interface			
Pin	Name	Button/Switch	Contact
1	T_Select	Selector switch	(normally open contact)
	T_Blue	Blue pushbutton	(normally open contact)
2	T_Green	Green pushbutton	(normally open contact)
3	T_Red	Red pushbutton	(normally open contact)
4	T_Key	Key switch	(normally open contact)
5	V_Button		Reference potential for pins 1-4
6	NH22	Emergency stop	Normally closed contact pair 1 emergency stop
7	NH21	Emergency stop	Normally closed contact pair 1 emergency stop
8	NH12	Emergency stop	Normally closed contact pair 2 emergency stop
9	NH11	Emergency stop	Normally closed contact pair 2 emergency stop

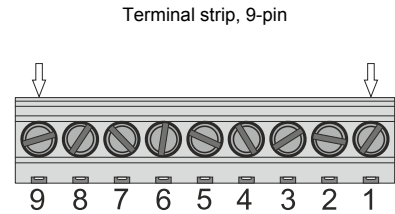

Table 52: Button/Switch interface - Pinout

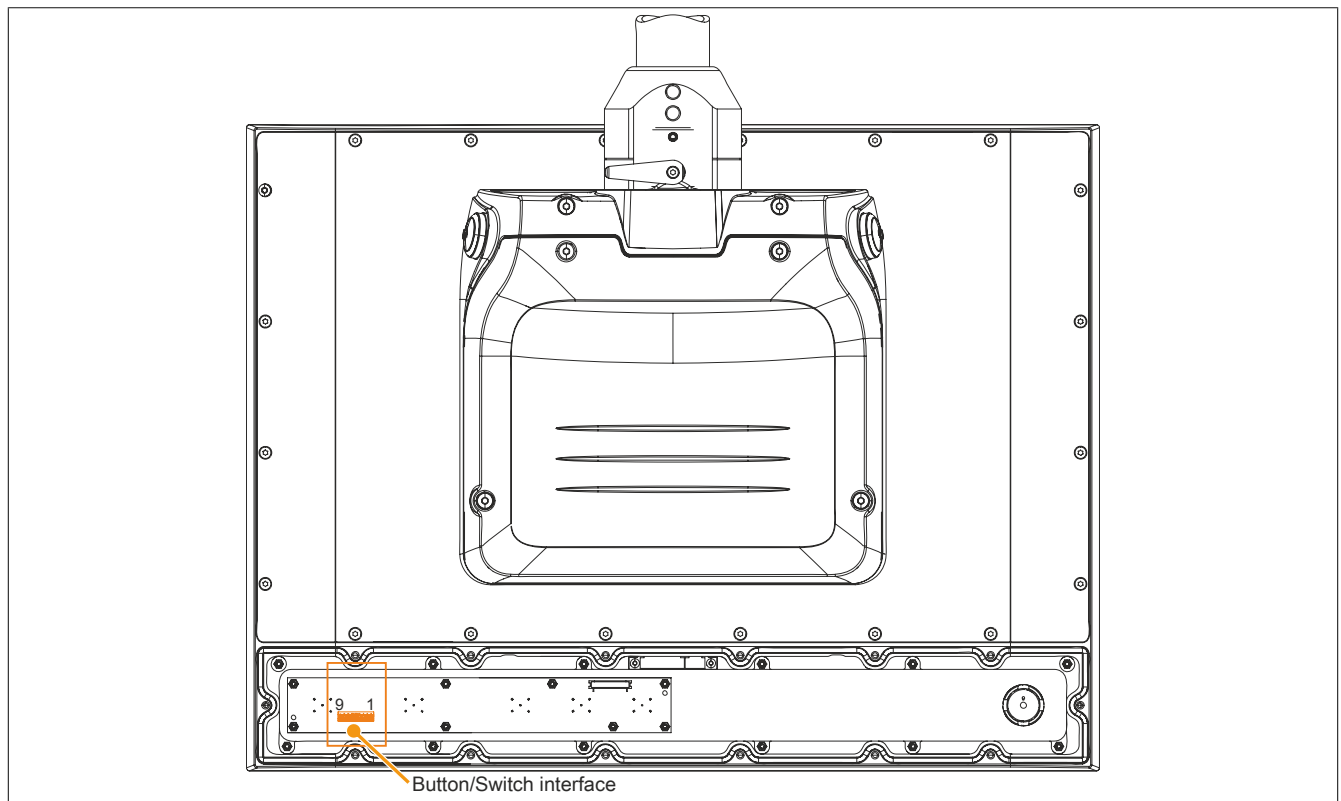

Figure 25: Button/Switch interface

3 Individual components

3.1 Panels

3.1.1 5AP5120.1505-000

3.1.1.1 General information

- 15.0" TFT XGA color display
- Single-touch (analog resistive)
- Flexible swing arm mounting or VESA
- IP65 protection with mounting unit 5ACCMA00.000x-000
- IP20 protection with mounting unit 5ACCMA01.0100-000

3.1.1.2 Order data

Model number	Short description	Figure
	Panels	
5AP5120.1505-000	Automation Panel 15.0" XGA TFT - 1024 x 768 pixels (4:3) - Single-touch (analog resistive) - Swing arm mounting - Landscape format - For PPC2100 / link modules	
	Optional accessories	
	Flange	
5ACCFL00.0000-000	AP5000 flange - Swing arm rotary flange - For swing arm mounting unit	
5ACCFL00.0200-000	AP5000 flange - Swing arm flange adapter - For Rittal - For swing arm mounting unit	
	Handles	
5ACCHD00.1505-000	AP5000 swing arm handles - For panel 5AP5120.1505-000	
	Mounting units	
5ACCMA00.0000-000	AP5000 swing arm mounting unit	
5ACCMA00.0001-000	AP5000 swing arm mounting unit - 1x rear USB interface	
5ACCMA01.0100-000	AP5000 VESA mounting unit IP20	
	Swing arm mounting units	
5ACCMA00.0002-000	AP5000 swing arm mounting unit - 2x rear USB interface	

Table 53: 5AP5120.1505-000 - Order data

3.1.1.3 Technical data

Information:

The following specifications, properties and limit values apply only to this individual component and may deviate from those that apply to the complete system. For the complete system in which this individual component is used, for example, the data specified for that complete system applies.

Model number	5AP5120.1505-000
General information	
B&R ID code	0xE9CB
Certification	
CE	Yes
UL	cULus E115267 Industrial control equipment
Display	
Type	TFT color
Display size	15.0"
Colors	16.7 million
Resolution	XGA, 1024 x 768 pixels
Contrast	700:1
Viewing angles	
Horizontal	Direction R = 80° / Direction L = 80°
Vertical	Direction U = 70° / Direction D = 70°
Backlighting	
Type	LED
Brightness (dimnable)	Typ. 20 to 400 cd/m ²
Half-brightness time ¹⁾	50,000 h

Table 54: 5AP5120.1505-000 - Technical data

Model number	5AP5120.1505-000
Touch screen	
Type	AMT
Technology	Analog, resistive
Controller	B&R, serial, 12-bit
Transmittance	81% ±3%
Operating conditions	
EN 61131 pollution degree	Pollution degree 2
Protection per EN 60529	IP65 with mounting unit 5ACCMA00.000x-000
UL 50 protection	Type 4X indoor with mounting unit 5ACCMA00.000x-000
Mechanical characteristics	
Housing	
Material	Aluminum, coated
Coating	White aluminum
Front	
Frame	Aluminum, coated
Keypad overlay	
Material	Polyester
Dark gray border around display	RAL 7024
Dimensions	
Width	389 mm
Height	299 mm
Weight	5200 g

Table 54: 5AP5120.1505-000 - Technical data

- 1) At an ambient temperature of 25°C. Reducing the brightness by 50% can increase the half-brightness time by approximately 50%.

3.1.1.4 Dimensions

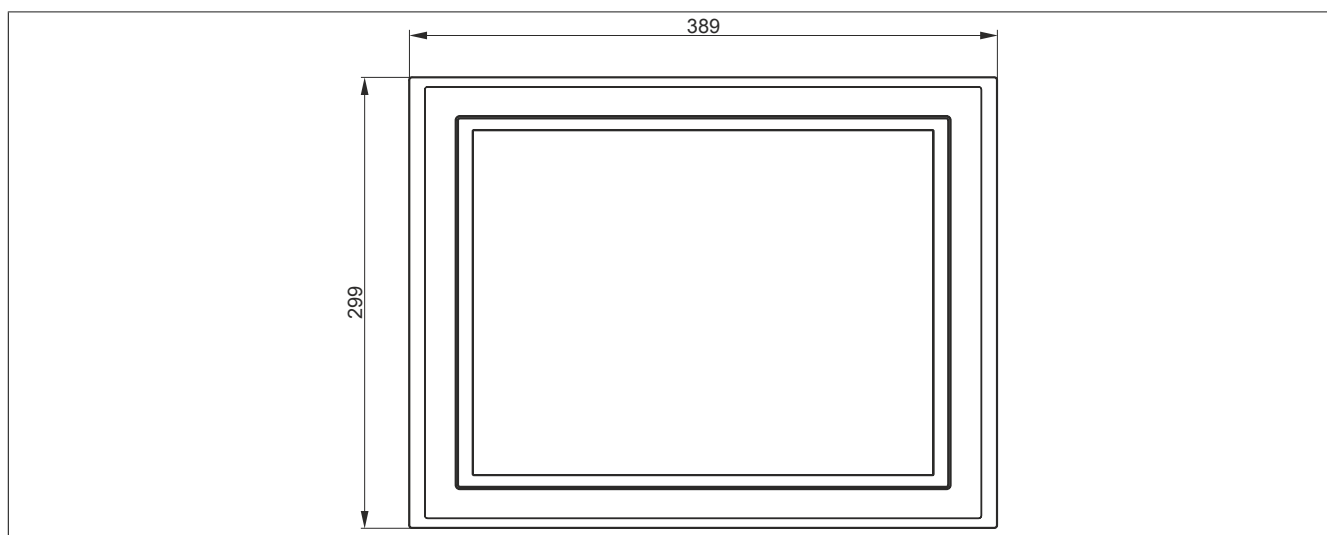

Figure 26: 5AP5120.1505-000 - Dimensions

3.1.1.5 Temperature/Humidity diagram

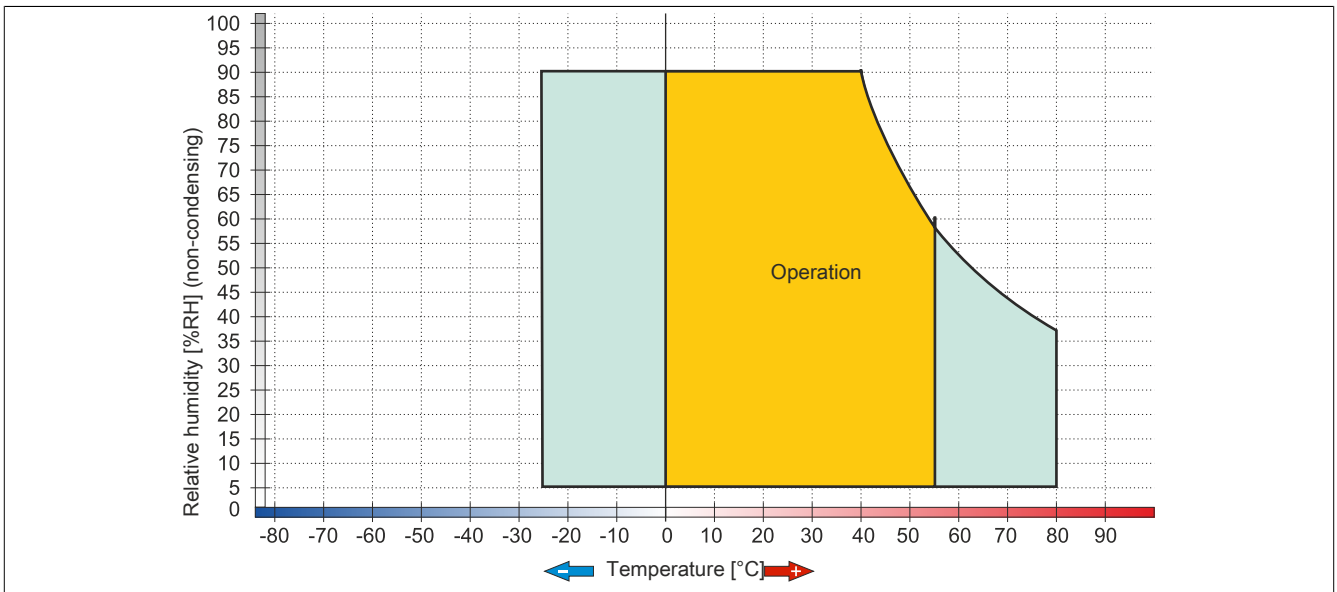

Figure 27: 5AP5120.1505-000 - Temperature/Humidity diagram

3.1.2 5AP5120.1906-000

3.1.2.1 General information

- 19.0" TFT SXGA color display
- Single-touch (analog resistive)
- Flexible swing arm mounting or VESA
- IP65 protection with mounting unit 5ACCMA00.000x-000
- IP20 protection with mounting unit 5ACCMA01.0100-000

3.1.2.2 Order data

Model number	Short description	Figure
	Panels	
5AP5120.1906-000	Automation Panel 19.0" SXGA TFT - 1280 x 1024 pixels (5:4) - Single-touch (analog resistive) - Swing arm mounting - Landscape format - For PPC2100 / link modules	
	Optional accessories	
	Flange	
5ACCFL00.0000-000	AP5000 flange - Swing arm rotary flange - For swing arm mounting unit	
5ACCFL00.0200-000	AP5000 flange - Swing arm flange adapter - For Rittal - For swing arm mounting unit	
	Handles	
5ACCHD00.1906-000	AP5000 swing arm handles - For panel 5AP5120.1906-000	
	Mounting units	
5ACCMA00.0000-000	AP5000 swing arm mounting unit	
5ACCMA00.0001-000	AP5000 swing arm mounting unit - 1x rear USB interface	
5ACCMA01.0100-000	AP5000 VESA mounting unit IP20	
	Swing arm mounting units	
5ACCMA00.0002-000	AP5000 swing arm mounting unit - 2x rear USB interface	

Table 55: 5AP5120.1906-000 - Order data

3.1.2.3 Technical data

Information:

The following specifications, properties and limit values apply only to this individual component and may deviate from those that apply to the complete system. For the complete system in which this individual component is used, for example, the data specified for that complete system applies.

Model number	5AP5120.1906-000
General information	
B&R ID code	0xE9CC
Certification	
CE	Yes
UL	cULus E115267 Industrial control equipment
Display	
Type	TFT color
Display size	19.0"
Colors	16.7 million
Resolution	SXGA, 1280 x 1024 pixels
Contrast	1500:1
Viewing angles	
Horizontal	Direction R = 85° / Direction L = 85°
Vertical	Direction U = 85° / Direction D = 85°
Backlighting	
Type	LED
Brightness (dimnable)	Typ. 35 to 350 cd/m ²
Half-brightness time ¹⁾	70,000 h
Touch screen	
Type	AMT
Technology	Analog, resistive
Controller	B&R, serial, 12-bit
Transmittance	81% ±3%
Operating conditions	
EN 61131 pollution degree	Pollution degree 2
Protection per EN 60529	IP65 with mounting unit 5ACCMA00.000x-000
UL 50 protection	Type 4X indoor with mounting unit 5ACCMA00.000x-000

Table 56: 5AP5120.1906-000 - Technical data

Model number	5AP5120.1906-000
Mechanical characteristics	
Housing	
Material	Aluminum, coated
Coating	White aluminum
Front	
Frame	Aluminum, coated
Keypad overlay	
Material	Polyester
Dark gray border around display	RAL 7024
Dimensions	
Width	461.2 mm
Height	372 mm
Weight	7300 g

Table 56: 5AP5120.1906-000 - Technical data

- At an ambient temperature of 25°C. Reducing the brightness by 50% can increase the half-brightness time by approximately 50%.

3.1.2.4 Dimensions

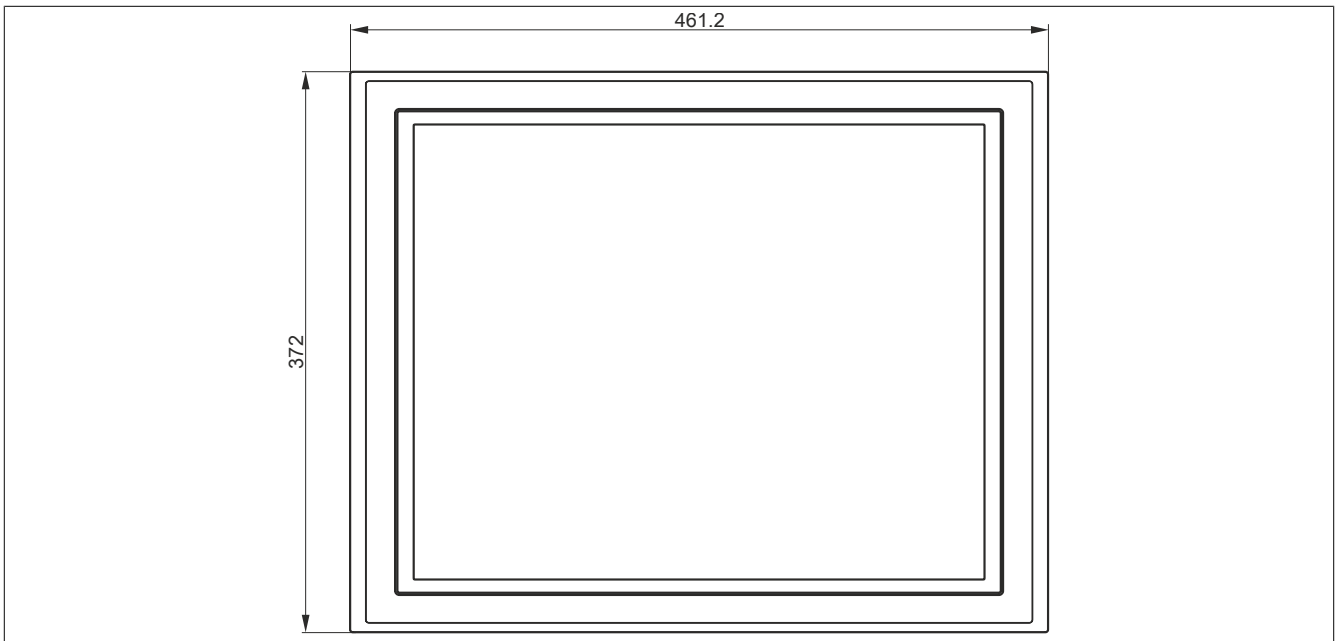

Figure 28: 5AP5120.1906-000 - Dimensions

3.1.2.5 Temperature/Humidity diagram

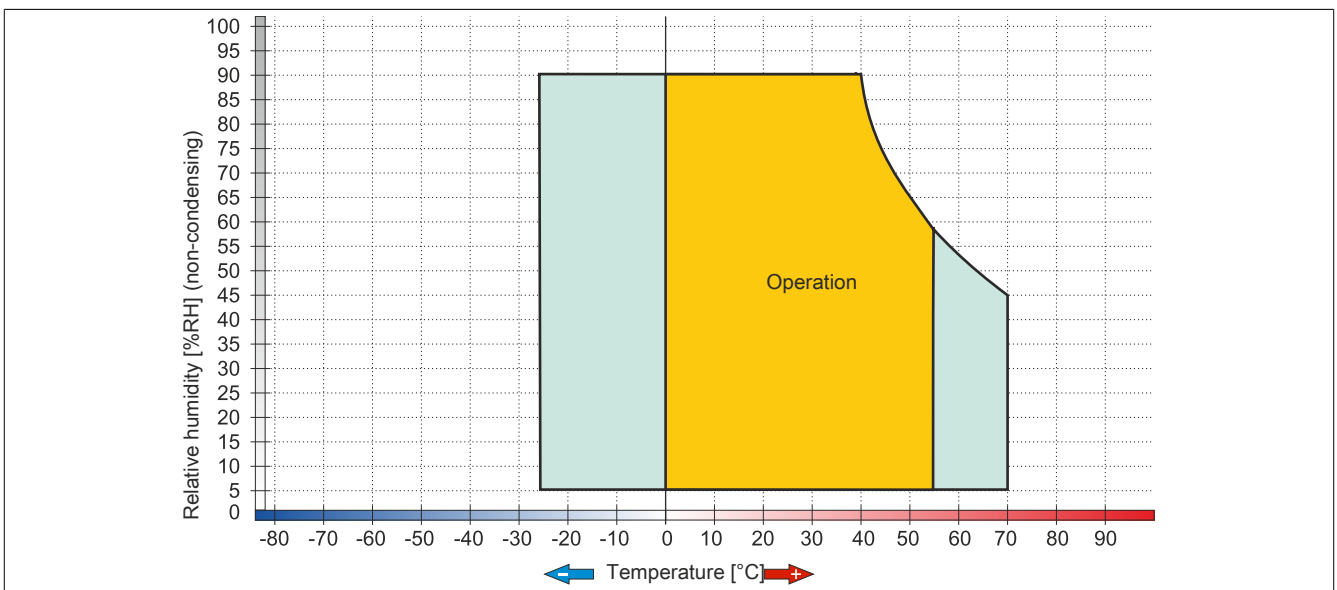

Figure 29: 5AP5120.1906-000 - Temperature/Humidity diagram

3.1.3 5AP5130.156B-000

3.1.3.1 General information

- 15.6" TFT HD color display
- Multi-touch (PCT)
- Flexible swing arm mounting or VESA
- IP65 protection with mounting unit 5ACCMA00.000x-000
- IP10 protection with mounting unit 5ACCMA01.0100-000

3.1.3.2 Order data

Model number	Short description	Figure
	Panels	
5AP5130.156B-000	Automation Panel 15.6" HD TFT - 1366 x 768 pixels (16:9) - Multi-touch (projected capacitive) - Swing arm mounting - Landscape format - For PPC2100 / link modules	
	Optional accessories	
	Flange	
5ACCFL00.0000-000	AP5000 flange - Swing arm rotary flange - For swing arm mounting unit	
5ACCFL00.0200-000	AP5000 flange - Swing arm flange adapter - For Rittal - For swing arm mounting unit	
	Handles	
5ACCHD00.156B-000	AP5000 swing arm handles - For panel 5AP5130.156B-000	
	Mounting units	
5ACCMA00.0000-000	AP5000 swing arm mounting unit	
5ACCMA00.0001-000	AP5000 swing arm mounting unit - 1x rear USB interface	
5ACCMA01.0100-000	AP5000 VESA mounting unit IP20	
	Swing arm mounting units	
5ACCMA00.0002-000	AP5000 swing arm mounting unit - 2x rear USB interface	

Table 57: 5AP5130.156B-000 - Order data

3.1.3.3 Technical data

Information:

The following specifications, properties and limit values apply only to this individual component and may deviate from those that apply to the complete system. For the complete system in which this individual component is used, for example, the data specified for that complete system applies.

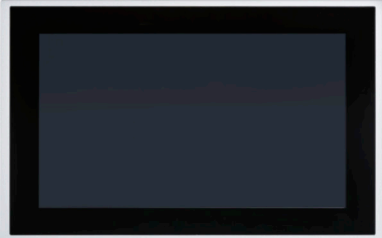
Model number	5AP5130.156B-000
General information	
B&R ID code	0xE9C7
Certification	
CE	Yes
UL	cULus E115267 Industrial control equipment
Display	
Type	TFT color
Display size	15.6"
Colors	16.7 million
Resolution	HD, 1366 x 768 pixels
Contrast	1000:1
Viewing angles	
Horizontal	Direction R = 85° / Direction L = 85°
Vertical	Direction U = 85° / Direction D = 85°
Backlighting	
Type	LED
Brightness (dimnable)	Typ. 40 to 400 cd/m ²
Half-brightness time ¹⁾	70,000 h
Touch screen	
Type	3M
Technology	Projected capacitive touch (PCT)
Controller	3M
Transmittance	>90%
Operating conditions	
EN 61131 pollution degree	Pollution degree 2
Protection per EN 60529	IP65 with mounting unit 5ACCMA00.000x-000
UL 50 protection	Type 4X indoor with mounting unit 5ACCMA00.000x-000

Table 58: 5AP5130.156B-000 - Technical data

Model number	5AP5130.156B-000
Mechanical characteristics	
Housing	
Material	Aluminum, coated
Coating	White aluminum (similar to RAL 9006)
Front	
Frame	Coated aluminum (similar to RAL 9006)
Design	Black
Dimensions	
Width	433 mm
Height	269.5 mm
Weight	4700 g

Table 58: 5AP5130.156B-000 - Technical data

- 1) At an ambient temperature of 25°C. Reducing the brightness by 50% can increase the half-brightness time by approximately 50%.

3.1.3.4 Dimensions

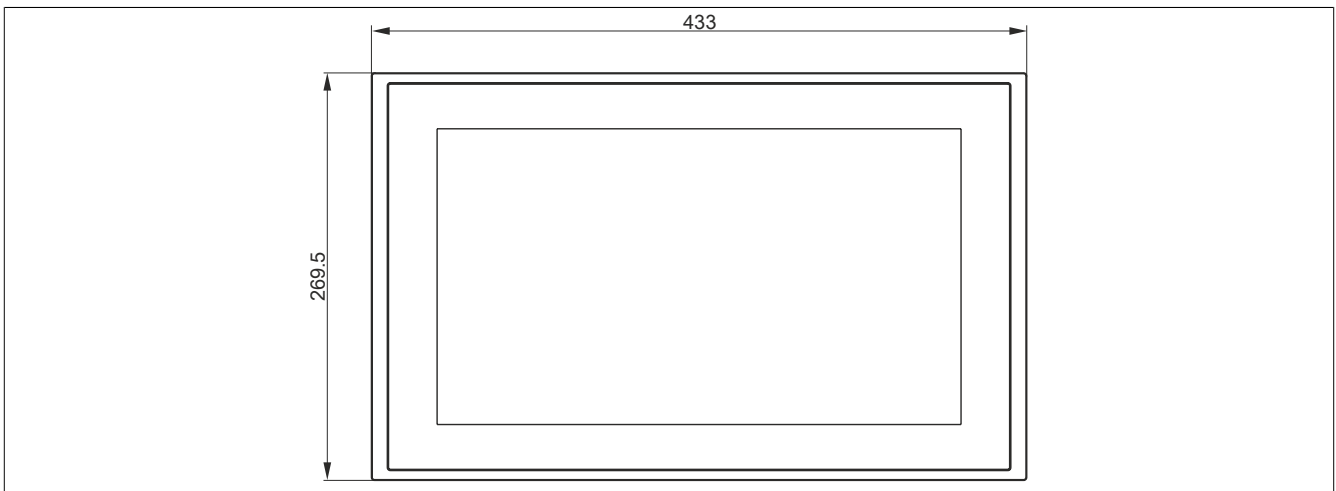

Figure 30: 5AP5130.156B-000 - Dimensions

3.1.3.5 Temperature/Humidity diagram

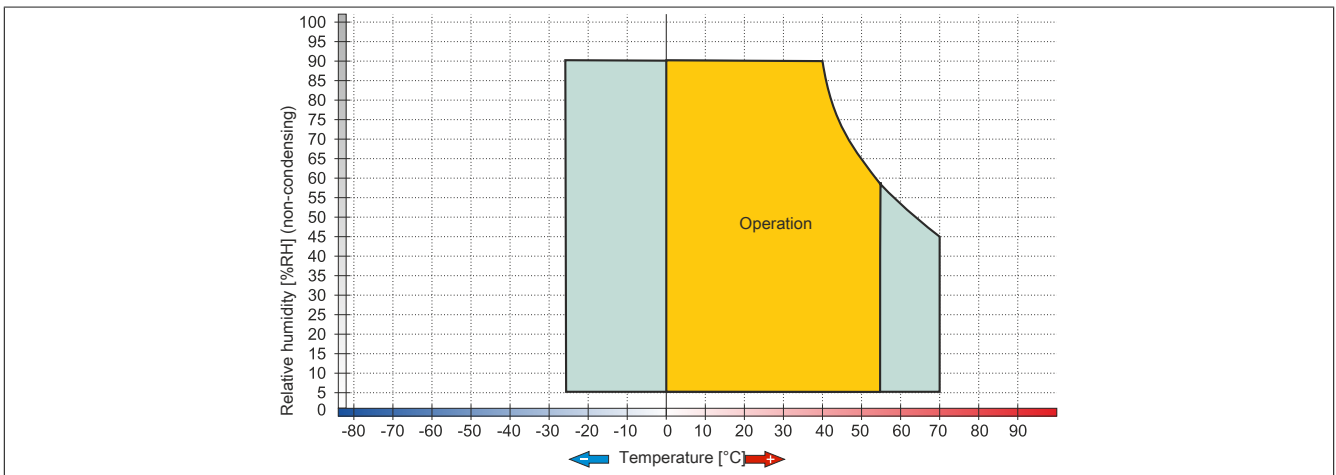

Figure 31: 5AP5130.156B-000 - Temperature/Humidity diagram

3.1.4 5AP5130.156C-000

3.1.4.1 General information

- 15.6" TFT FHD color display
- Multi-touch (PCT)
- Flexible swing arm mounting or VESA
- IP65 protection with mounting unit 5ACCMA00.000x-000
- IP10 protection with mounting unit 5ACCMA01.0100-000

3.1.4.2 Order data

Model number	Short description	Figure
	Panels	
5AP5130.156C-000	Automation Panel 15.6" Full HD TFT - 1920 x 1080 pixels (16:9) - Multi-touch (projected capacitive) - Swing arm mounting - Landscape format - For PPC2100 / PPC2200 / link modules	
	Optional accessories	
	Flange	
5ACCFL00.0000-000	AP5000 flange - Swing arm rotary flange - For swing arm mounting unit	
5ACCFL00.0200-000	AP5000 flange - Swing arm flange adapter - For Rittal - For swing arm mounting unit	
	Handles	
5ACCHD00.156B-000	AP5000 swing arm handles - For panel 5AP5130.156B-000	
	Mounting units	
5ACCMA00.0000-000	AP5000 swing arm mounting unit	
5ACCMA00.0001-000	AP5000 swing arm mounting unit - 1x rear USB interface	
5ACCMA01.0100-000	AP5000 VESA mounting unit IP20	
	Swing arm mounting units	
5ACCMA00.0002-000	AP5000 swing arm mounting unit - 2x rear USB interface	

Table 59: 5AP5130.156C-000 - Order data

3.1.4.3 Technical data

Information:

The following specifications, properties and limit values apply only to this individual component and may deviate from those that apply to the complete system. For the complete system in which this individual component is used, for example, the data specified for that complete system applies.

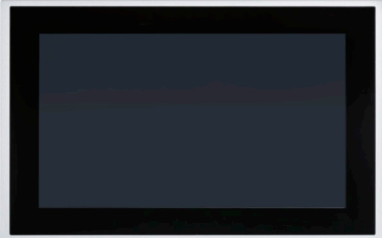
Model number	5AP5130.156C-000
General information	
B&R ID code	0XF24A
Certifications	
CE	Yes
UL	cULus E115267 Industrial control equipment
Display	
Type	TFT color
Diagonal	15.6"
Colors	16.7 million
Resolution	FHD, 1920 x 1080
Contrast	1500:1
Viewing angles	
Horizontal	Direction R = 85° / Direction L = 85°
Vertical	Direction U = 85° / Direction D = 85°
Backlight	
Type	LED
Brightness (dimnable)	Typ. 40 to 400 cd/m ²
Half-brightness time	70,000 h
Touch screen	
Type	3M
Technology	Projected capacitive touch (PCT)
Controller	3M
Transmittance	>90%
Operating conditions	
Pollution degree per EN 61131	Pollution degree 2
Protection per EN 60529	IP65 with mounting unit 5ACCMA00.000x-000
Protection per UL 50	Type 4X indoor with mounting unit 5ACCMA00.000x-000

Table 60: 5AP5130.156C-000 - Technical data

Model number	5AP5130.156C-000
Mechanical characteristics	
Housing	
Material	Aluminum, coated
Coating	White aluminum (similar to RAL 9006)
Front	
Frame	Aluminum (similar to RAL 9006), coated
Design	Black
Dimensions	
Width	433 mm
Height	269.5 mm
Weight	4700 g

Table 60: 5AP5130.156C-000 - Technical data

3.1.4.4 Dimensions

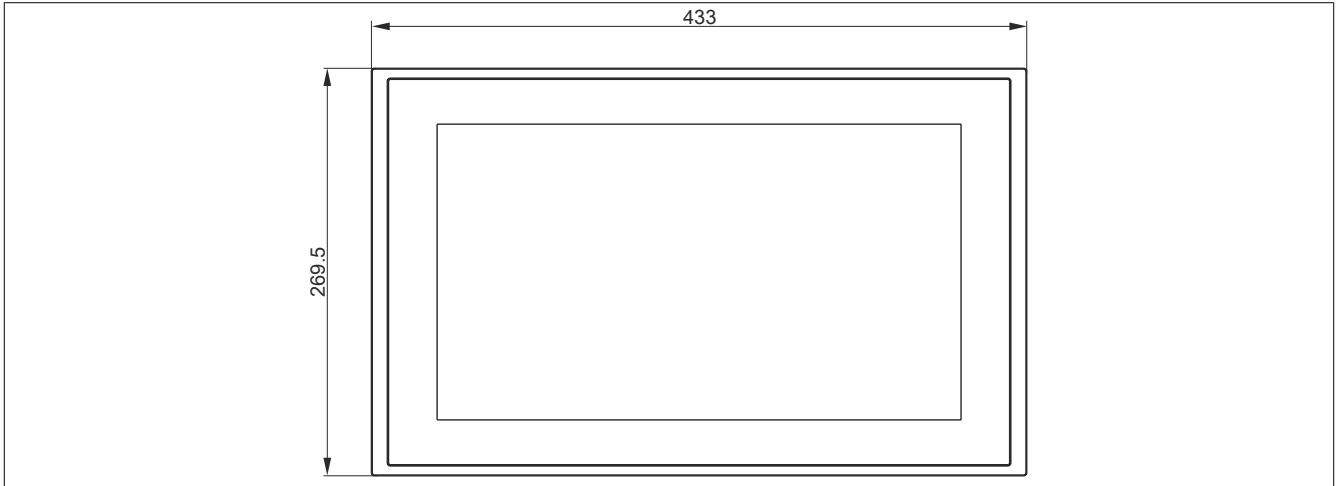

Figure 32: 5AP5130.156C-000 - Dimensions

3.1.4.5 Temperature/Humidity diagram

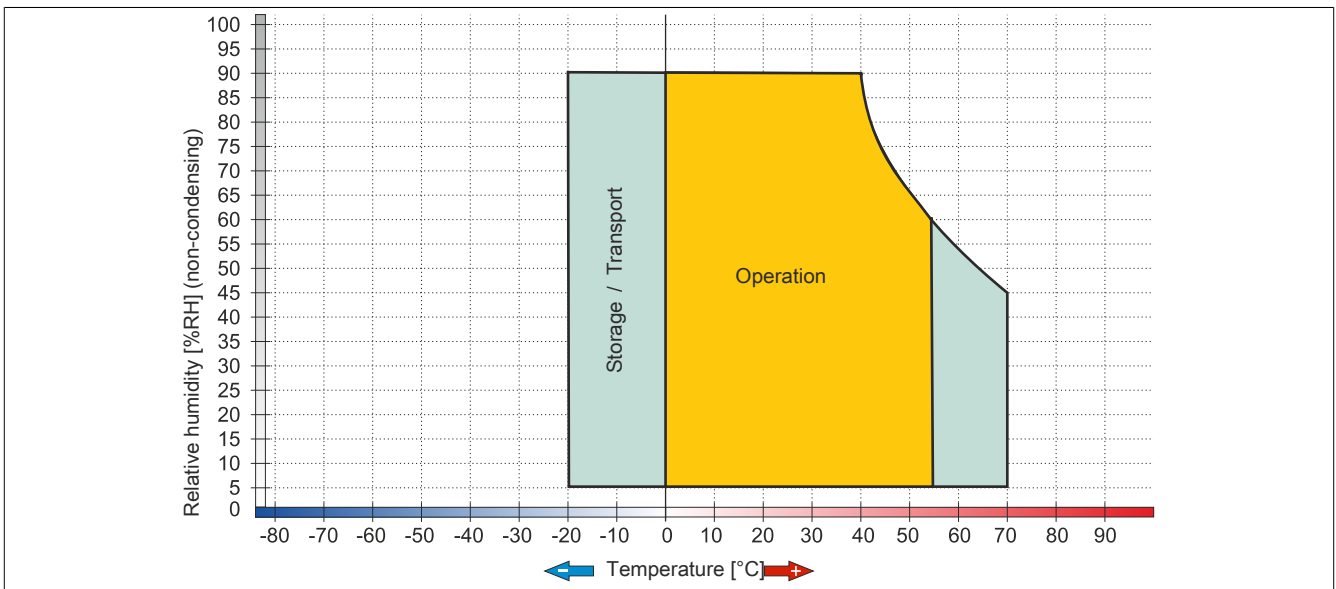

Figure 33: 5AP5130.156C-000 - Temperature/Humidity diagram

3.1.5 5AP5130.185B-000

3.1.5.1 General information

- 18.5" TFT HD color display
- Multi-touch (PCT)
- Flexible swing arm mounting or VESA
- IP65 protection with mounting unit 5ACCMA00.000x-000
- IP10 protection with mounting unit 5ACCMA01.0100-000

3.1.5.2 Order data

Model number	Short description	Figure
	Panels	
5AP5130.185B-000	Automation Panel 18.5" HD TFT - 1366 x 768 pixels (16:9) - Multi-touch (projected capacitive) - Swing arm mounting - Landscape format - For PPC2100 / link modules	
	Optional accessories	
	Flange	
5ACCFL00.0000-000	AP5000 flange - Swing arm rotary flange - For swing arm mounting unit	
5ACCFL00.0200-000	AP5000 flange - Swing arm flange adapter - For Rittal - For swing arm mounting unit	
	Handles	
5ACCHD00.185B-000	AP5000 swing arm handles - For panel 5AP5130.185B-000	
	Mounting units	
5ACCMA00.0000-000	AP5000 swing arm mounting unit	
5ACCMA00.0001-000	AP5000 swing arm mounting unit - 1x rear USB interface	
5ACCMA01.0100-000	AP5000 VESA mounting unit IP20	
	Swing arm mounting units	
5ACCMA00.0002-000	AP5000 swing arm mounting unit - 2x rear USB interface	

Table 61: 5AP5130.185B-000 - Order data

3.1.5.3 Technical data

Information:

The following specifications, properties and limit values apply only to this individual component and may deviate from those that apply to the complete system. For the complete system in which this individual component is used, for example, the data specified for that complete system applies.

Model number	5AP5130.185B-000
General information	
B&R ID code	0xE9C8
Certification	
CE	Yes
UL	cULus E115267 Industrial control equipment
Display	
Type	TFT color
Display size	18.5"
Colors	16.7 million
Resolution	HD, 1366 x 768 pixels
Contrast	1000:1
Viewing angles	
Horizontal	Direction R = 85° / Direction L = 85°
Vertical	Direction U = 80° / Direction D = 80°
Backlighting	
Type	LED
Brightness (dimnable)	Typ. 15 to 300 cd/m ²
Half-brightness time ¹⁾	50,000 h
Touch screen	
Type	3M
Technology	Projected capacitive touch (PCT)
Controller	3M
Transmittance	>90%
Operating conditions	
EN 61131 pollution degree	Pollution degree 2
Protection per EN 60529	IP65 with mounting unit 5ACCMA00.000x-000
UL 50 protection	Type 4X indoor with mounting unit 5ACCMA00.000x-000

Table 62: 5AP5130.185B-000 - Technical data

Model number	5AP5130.185B-000
Mechanical characteristics	
Housing	
Material	Aluminum, coated
Coating	White aluminum (similar to RAL 9006)
Front	
Frame	Coated aluminum (similar to RAL 9006)
Design	Black
Dimensions	
Width	494 mm
Height	306 mm
Weight	6700 g

Table 62: 5AP5130.185B-000 - Technical data

- 1) At an ambient temperature of 25°C. Reducing the brightness by 50% can increase the half-brightness time by approximately 50%.

3.1.5.4 Dimensions

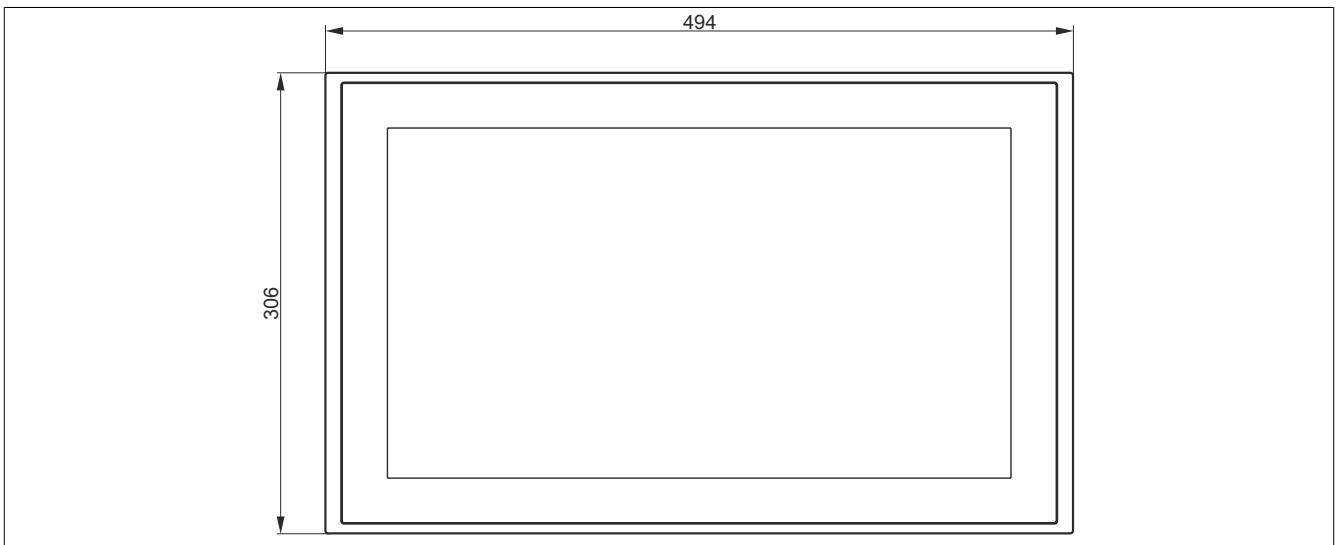

Figure 34: 5AP5130.185B-000 - Dimensions

3.1.5.5 Temperature/Humidity diagram

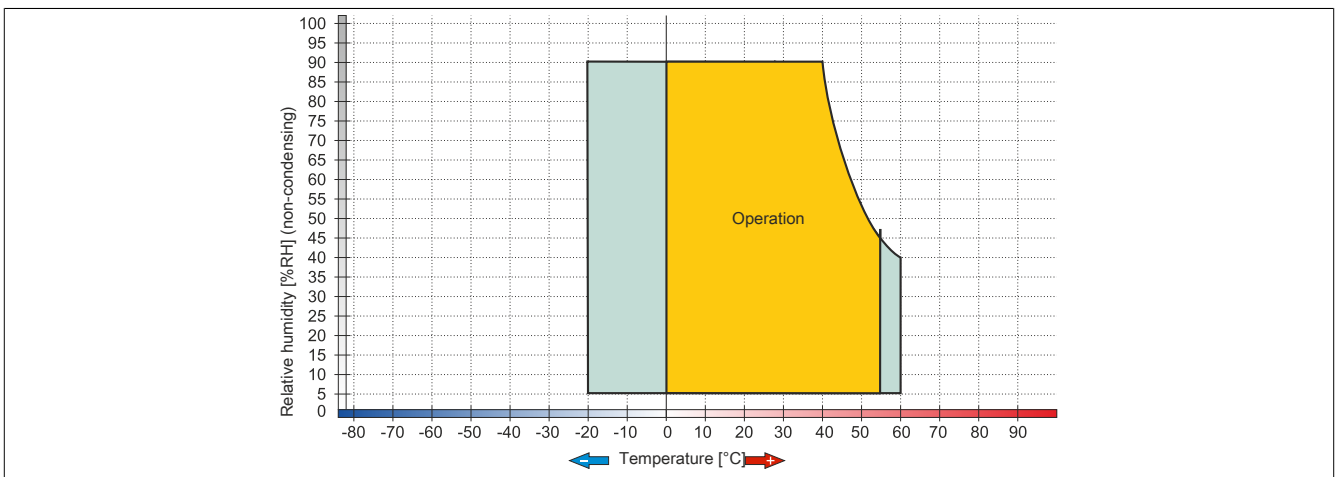

Figure 35: 5AP5130.185B-000 - Temperature/Humidity diagram

3.1.6 5AP5130.185C-000

3.1.6.1 General information

- 18.5" TFT FHD color display
- Multi-touch (PCT)
- Flexible swing arm mounting or VESA
- IP65 protection with mounting unit 5ACCMA00.000x-000
- IP10 protection with mounting unit 5ACCMA01.0100-000

3.1.6.2 Order data

Model number	Short description	Figure
	Panels	
5AP5130.185C-000	Automation Panel 18.5" Full HD TFT - 1920 x 1080 pixels (16:9) - Multi-touch (projected capacitive) - Swing arm mounting - Landscape format - For PPC2100 / PPC2200 / link modules	
	Optional accessories	
	Flange	
5ACCFL00.0000-000	AP5000 flange - Swing arm rotary flange - For swing arm mounting unit	
5ACCFL00.0200-000	AP5000 flange - Swing arm flange adapter - For Rittal - For swing arm mounting unit	
	Handles	
5ACCHD00.185B-000	AP5000 swing arm handles - For panel 5AP5130.185B-000	
	Mounting units	
5ACCMA00.0000-000	AP5000 swing arm mounting unit	
5ACCMA00.0001-000	AP5000 swing arm mounting unit - 1x rear USB interface	
5ACCMA01.0100-000	AP5000 VESA mounting unit IP20	
	Swing arm mounting units	
5ACCMA00.0002-000	AP5000 swing arm mounting unit - 2x rear USB interface	

Table 63: 5AP5130.185C-000 - Order data

3.1.6.3 Technical data

Information:

The following specifications, properties and limit values apply only to this individual component and may deviate from those that apply to the complete system. For the complete system in which this individual component is used, for example, the data specified for that complete system applies.

Model number	5AP5130.185C-000
General information	
B&R ID code	0xF24C
Certifications	
CE	Yes
UL	cULus E115267 Industrial control equipment
Display	
Type	TFT color
Diagonal	18.5"
Colors	16.7 million
Resolution	FHD, 1920 x 1080 pixels
Contrast	1500:1
Viewing angles	
Horizontal	Direction R = 85° / Direction L = 85°
Vertical	Direction U = 85° / Direction D = 85°
Backlight	
Type	LED
Brightness (dimnable)	Typ. 40 to 400 cd/m ²
Half-brightness time	50,000 h
Touch screen	
Type	3M
Technology	Projected capacitive touch (PCT)
Controller	3M
Transmittance	>90%
Operating conditions	
Pollution degree per EN 61131	Pollution degree 2
Protection per EN 60529	IP65 with mounting unit 5ACCMAS00.000x-000
Protection per UL 50	Type 4X indoor with mounting unit 5ACCMAS00.000x-000

Table 64: 5AP5130.185C-000 - Technical data

Model number	5AP5130.185C-000
Mechanical characteristics	
Housing	
Material	Aluminum, coated
Coating	White aluminum (similar to RAL 9006)
Front	
Frame	Aluminum (similar to RAL 9006), coated
Design	Black
Dimensions	
Width	494 mm
Height	306 mm
Weight	6700 g

Table 64: 5AP5130.185C-000 - Technical data

3.1.6.4 Dimensions

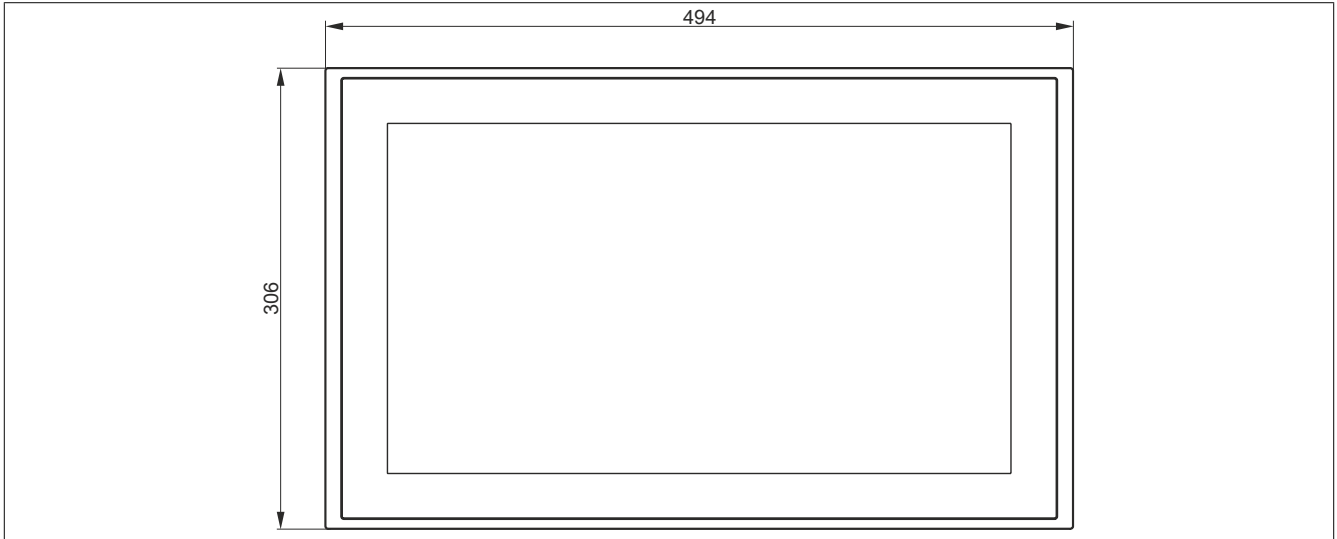

Figure 36: 5AP5130.185C-000 - Dimensions

3.1.6.5 Temperature/Humidity diagram

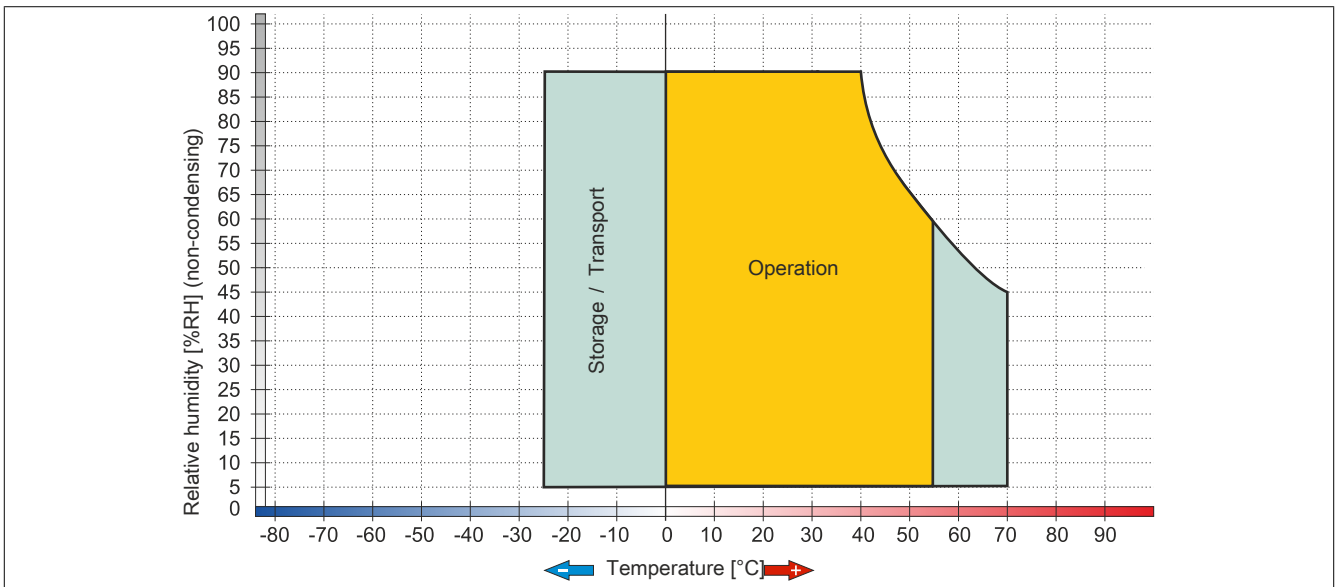

Figure 37: 5AP5130.185C-000 - Temperature/Humidity diagram

3.1.7 5AP5130.215C-000

3.1.7.1 General information

- 21.5" TFT FHD color display
- Multi-touch (PCT)
- Flexible swing arm mounting or VESA
- IP65 protection with mounting unit 5ACCMA00.000x-000
- IP10 protection with mounting unit 5ACCMA01.0100-000

3.1.7.2 Order data

Model number	Short description	Figure
	Panels	
5AP5130.215C-000	Automation Panel 21.5" Full HD TFT - 1920 x 1080 pixels (16:9) - Multi-touch (projected capacitive) - Swing arm mounting - Landscape format - For PPC900 / PPC2100 / link modules	
	Optional accessories	
	Flange	
5ACCFL00.0000-000	AP5000 flange - Swing arm rotary flange - For swing arm mounting unit	
5ACCFL00.0200-000	AP5000 flange - Swing arm flange adapter - For Rittal - For swing arm mounting unit	
	Handles	
5ACCHD00.215C-000	AP5000 swing arm handles - For panel 5AP5130.215C-000	
	Mounting units	
5ACCMA00.0000-000	AP5000 swing arm mounting unit	
5ACCMA00.0001-000	AP5000 swing arm mounting unit - 1x rear USB interface	
5ACCMA01.0100-000	AP5000 VESA mounting unit IP20	
	Swing arm mounting units	
5ACCMA00.0002-000	AP5000 swing arm mounting unit - 2x rear USB interface	

Table 65: 5AP5130.215C-000 - Order data

3.1.7.3 Technical data

Information:

The following specifications, properties and limit values apply only to this individual component and may deviate from those that apply to the complete system. For the complete system in which this individual component is used, for example, the data specified for that complete system applies.

Model number	5AP5130.215C-000
General information	
B&R ID code	0xE9C9
Certification	
CE	Yes
UL	cULus E115267 Industrial control equipment
Display	
Type	TFT color
Display size	21.5"
Colors	16.7 million
Resolution	FHD, 1920 x 1080 pixels
Contrast	5000:1
Viewing angles	
Horizontal	Direction R = 89° / Direction L = 89°
Vertical	Direction U = 89° / Direction D = 89°
Backlighting	
Type	LED
Brightness (dimnable)	Typ. 12.5 to 250 cd/m ²
Half-brightness time ¹⁾	30,000 h
Touch screen	
Type	3M
Technology	Projected capacitive touch (PCT)
Controller	3M
Transmittance	>90%
Operating conditions	
EN 61131 pollution degree	Pollution degree 2
Protection per EN 60529	IP65 with mounting unit 5ACCMA00.000x-000
UL 50 protection	Type 4X indoor with mounting unit 5ACCMA00.000x-000

Table 66: 5AP5130.215C-000 - Technical data

Model number	5AP5130.215C-000
Mechanical characteristics	
Housing	
Material	Aluminum, coated
Coating	White aluminum (similar to RAL 9006)
Front	
Frame	Coated aluminum (similar to RAL 9006)
Design	Black
Dimensions	
Width	560.5 mm
Height	344 mm
Weight	7300 g

Table 66: 5AP5130.215C-000 - Technical data

- 1) At an ambient temperature of 25°C. Reducing the brightness by 50% can increase the half-brightness time by approximately 50%.

3.1.7.4 Dimensions

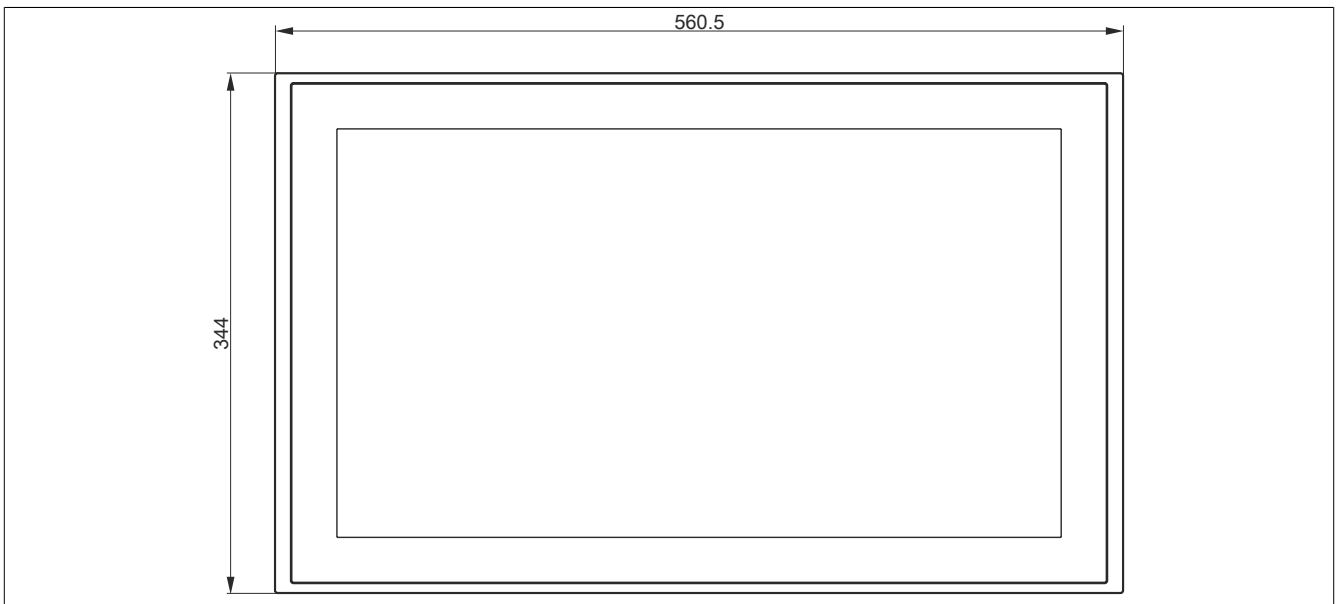

Figure 38: 5AP5130.215C-000 - Dimensions

3.1.7.5 Temperature/Humidity diagram

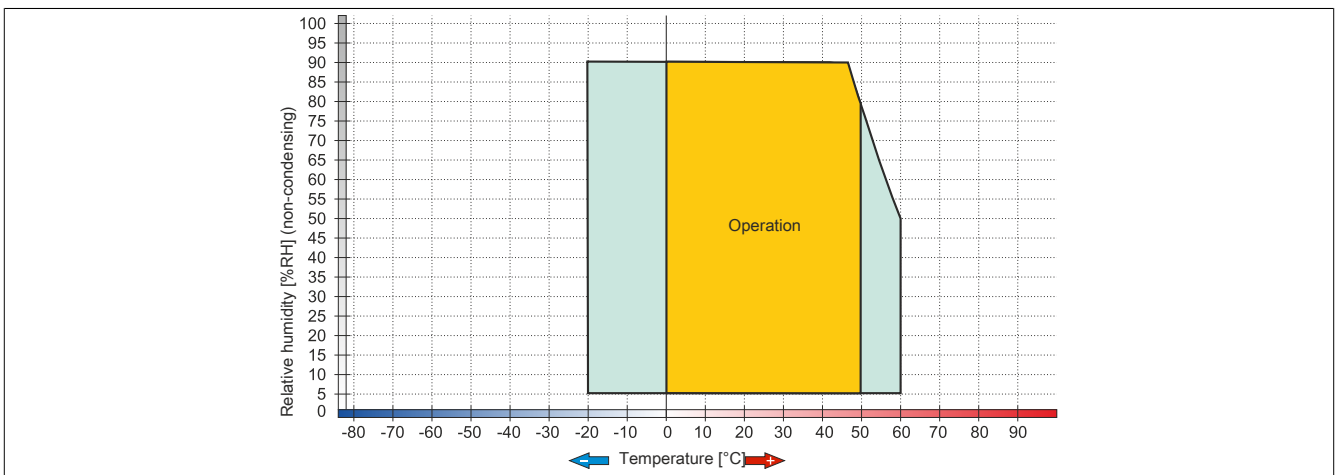

Figure 39: 5AP5130.215C-000 - Temperature/Humidity diagram

3.1.8 5AP5130.240C-000

3.1.8.1 General information

- 24.0" TFT FHD color display
- Multi-touch (PCT)
- Flexible swing arm mounting or VESA
- IP65 protection with mounting unit 5ACCMA00.000x-000
- IP10 protection with mounting unit 5ACCMA01.0100-000

3.1.8.2 Order data

Model number	Short description	Figure
	Panels	
5AP5130.240C-000	Automation Panel 24.0" Full HD TFT - 1920 x 1080 pixels (16:9) - Multi-touch (projected capacitive) - Swing arm mounting - Landscape format - For PPC900 / PPC2100 / link modules	
	Optional accessories	
	Flange	
5ACCFL00.0000-000	AP5000 flange - Swing arm rotary flange - For swing arm mounting unit	
5ACCFL00.0200-000	AP5000 flange - Swing arm flange adapter - For Rittal - For swing arm mounting unit	
	Handles	
5ACCHD00.240C-000	AP5000 swing arm handles - For panel 5AP5130.240C-000	
	Mounting units	
5ACCMA00.0000-000	AP5000 swing arm mounting unit	
5ACCMA00.0001-000	AP5000 swing arm mounting unit - 1x rear USB interface	
5ACCMA01.0100-000	AP5000 VESA mounting unit IP20	
	Swing arm mounting units	
5ACCMA00.0002-000	AP5000 swing arm mounting unit - 2x rear USB interface	

Table 67: 5AP5130.240C-000 - Order data

3.1.8.3 Technical data

Information:

The following specifications, properties and limit values apply only to this individual component and may deviate from those that apply to the complete system. For the complete system in which this individual component is used, for example, the data specified for that complete system applies.

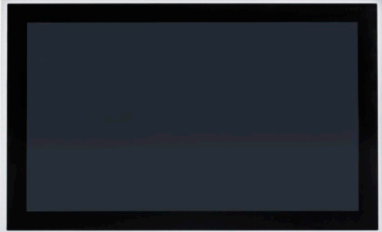
Model number	5AP5130.240C-000
General information	
B&R ID code	0xE9CA
Certification	
CE	Yes
UL	cULus E115267 Industrial control equipment
Display	
Type	TFT color
Display size	24.0"
Colors	16.7 million
Resolution	FHD, 1920 x 1080 pixels
Contrast	5000:1
Viewing angles	
Horizontal	Direction R = 89° / Direction L = 89°
Vertical	Direction U = 89° / Direction D = 89°
Backlighting	
Type	LED
Brightness (dimnable)	Typ. 30 to 300 cd/m ²
Half-brightness time ¹⁾	50,000 h
Touch screen	
Type	3M
Technology	Projected capacitive touch (PCT)
Controller	3M
Transmittance	>90%
Operating conditions	
EN 61131 pollution degree	Pollution degree 2
Protection per EN 60529	IP65 with mounting unit 5ACCMA00.000x-000
UL 50 protection	Type 4X indoor with mounting unit 5ACCMA00.000x-000

Table 68: 5AP5130.240C-000 - Technical data

Model number	5AP5130.240C-000
Mechanical characteristics	
Housing	
Material	Aluminum, coated
Coating	White aluminum (similar to RAL 9006)
Front	
Frame	Coated aluminum (similar to RAL 9006)
Design	Black
Dimensions	
Width	617.5 mm
Height	375 mm
Weight	8500 g

Table 68: 5AP5130.240C-000 - Technical data

- 1) At an ambient temperature of 25°C. Reducing the brightness by 50% can increase the half-brightness time by approximately 50%.

3.1.8.4 Dimensions

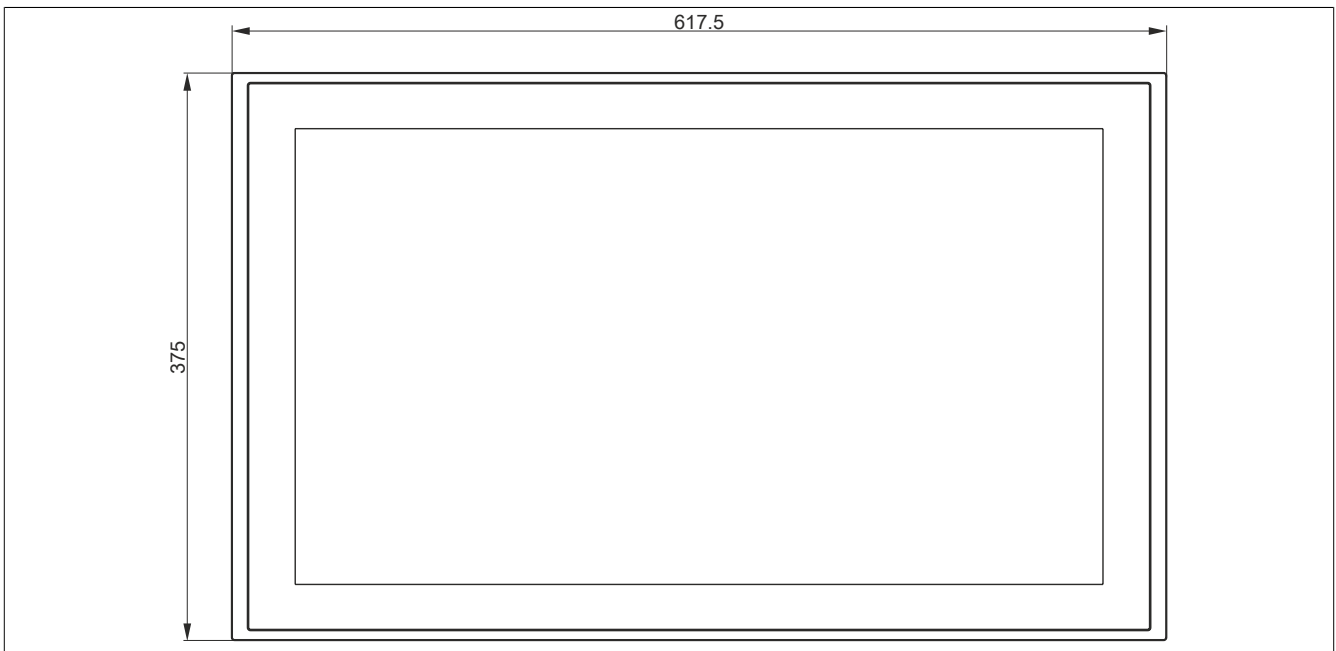

Figure 40: 5AP5130.240C-000 - Dimensions

3.1.8.5 Temperature/Humidity diagram

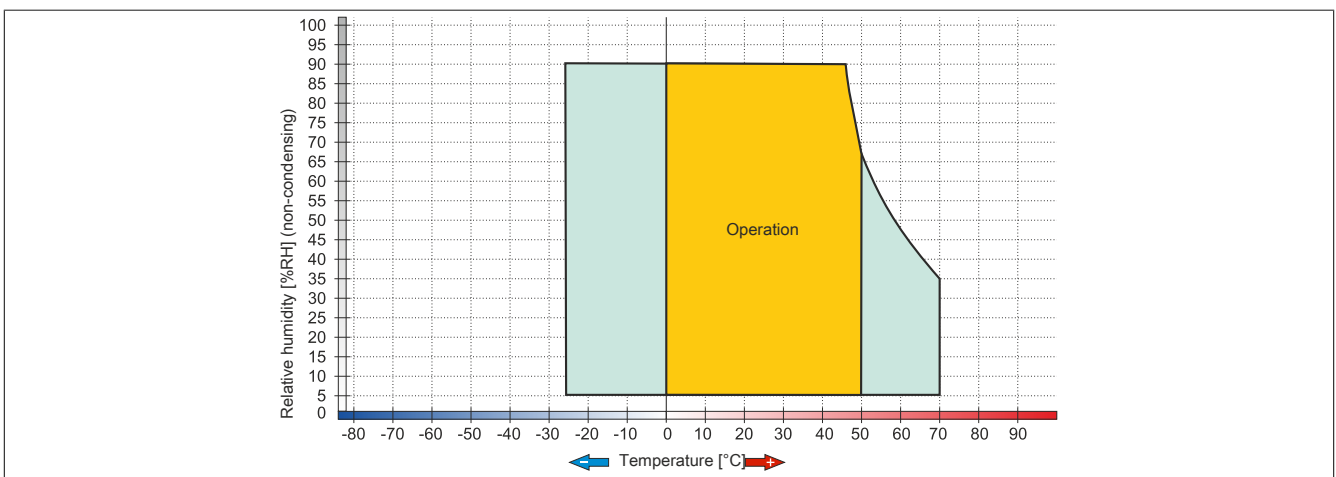

Figure 41: 5AP5130.240C-000 - Temperature/Humidity diagram

3.1.9 5AP5230.156B-000

3.1.9.1 General information

- 15.6" TFT HD color display
- Multi-touch (PCT)
- Possible to install expansion unit
- Flexible swing arm mounting or VESA
- IP65 protection with mounting unit 5ACCMA00.000x-000
- IP10 protection with mounting unit 5ACCMA01.0100-000

3.1.9.2 Order data

Model number	Short description	Figure
	Panels	
5AP5230.156B-000	Automation Panel 15.6" HD TFT - 1366 x 768 pixels (16:9) - Multi-touch (projected capacitive) - Swing arm mounting - Landscape format - Expansion option - For PPC2100 / link modules	
	Optional accessories	
	Expansion units	
5ACCKP00.156B-000	AP5000 swing arm expansion option - Expansion cover - For switching elements - 10x cutouts for 22.3 mm switching elements - For panel 5AP5230.156B-000	
5ACCKP01.156B-000	AP5000 swing arm expansion option - Expansion unit - 1x emergency stop - 2x pushbutton (red and green) - 1x selector switch - 1x key switch - 1x front USB interface - For panel 5AP5230.156B-000	
5ACCKP04.156B-000	AP5000 swing arm expansion option - Expansion unit - 1x emergency stop - 3x pushbutton (red, green, blue) - 1x key switch - 1x front USB interface - For panel 5AP5230.156B-000	
	Flange	
5ACCFL00.0000-000	AP5000 flange - Swing arm rotary flange - For swing arm mounting unit	
5ACCFL00.0200-000	AP5000 flange - Swing arm flange adapter - For Rittal - For swing arm mounting unit	
	Handles	
5ACCHD01.156B-000	AP5000 swing arm handles - For panel 5AP5230.156B-000	
	Mounting units	
5ACCMA00.0000-000	AP5000 swing arm mounting unit	
5ACCMA00.0001-000	AP5000 swing arm mounting unit - 1x rear USB interface	
5ACCMA01.0100-000	AP5000 VESA mounting unit IP20	
	Swing arm mounting units	
5ACCMA00.0002-000	AP5000 swing arm mounting unit - 2x rear USB interface	

Table 69: 5AP5230.156B-000 - Order data

3.1.9.3 Technical data

Information:

The following specifications, properties and limit values apply only to this individual component and may deviate from those that apply to the complete system. For the complete system in which this individual component is used, for example, the data specified for that complete system applies.

Model number	5AP5230.156B-000
General information	
B&R ID code	0xE9F5
Certification	
CE	Yes
UL	cULus E115267 Industrial control equipment
Display	
Type	TFT color
Display size	15.6"
Colors	16.7 million
Resolution	HD, 1366 x 768 pixels
Contrast	1000:1
Viewing angles	
Horizontal	Direction R = 85° / Direction L = 85°
Vertical	Direction U = 85° / Direction D = 85°

Table 70: 5AP5230.156B-000 - Technical data

Model number	5AP5230.156B-000
Backlighting	
Type	LED
Brightness (dimnable)	Typ. 40 to 400 cd/m ²
Half-brightness time ¹⁾	70,000 h
Touch screen	
Type	3M
Technology	Projected capacitive touch (PCT)
Controller	3M
Transmittance	>90%
Operating conditions	
EN 61131 pollution degree	Pollution degree 2
Protection per EN 60529	IP65 with mounting unit 5ACCMA00.000x-000
UL 50 protection	Type 4X indoor with mounting unit 5ACCMA00.000x-000
Mechanical characteristics	
Housing	
Material	Aluminum, coated
Coating	White aluminum (similar to RAL 9006)
Front	
Frame	Coated aluminum (similar to RAL 9006)
Design	Black
Dimensions	
Width	433 mm
Height	349 mm
Weight	6400 g

Table 70: 5AP5230.156B-000 - Technical data

1) At an ambient temperature of 25°C. Reducing the brightness by 50% can increase the half-brightness time by approximately 50%.

3.1.9.4 Dimensions

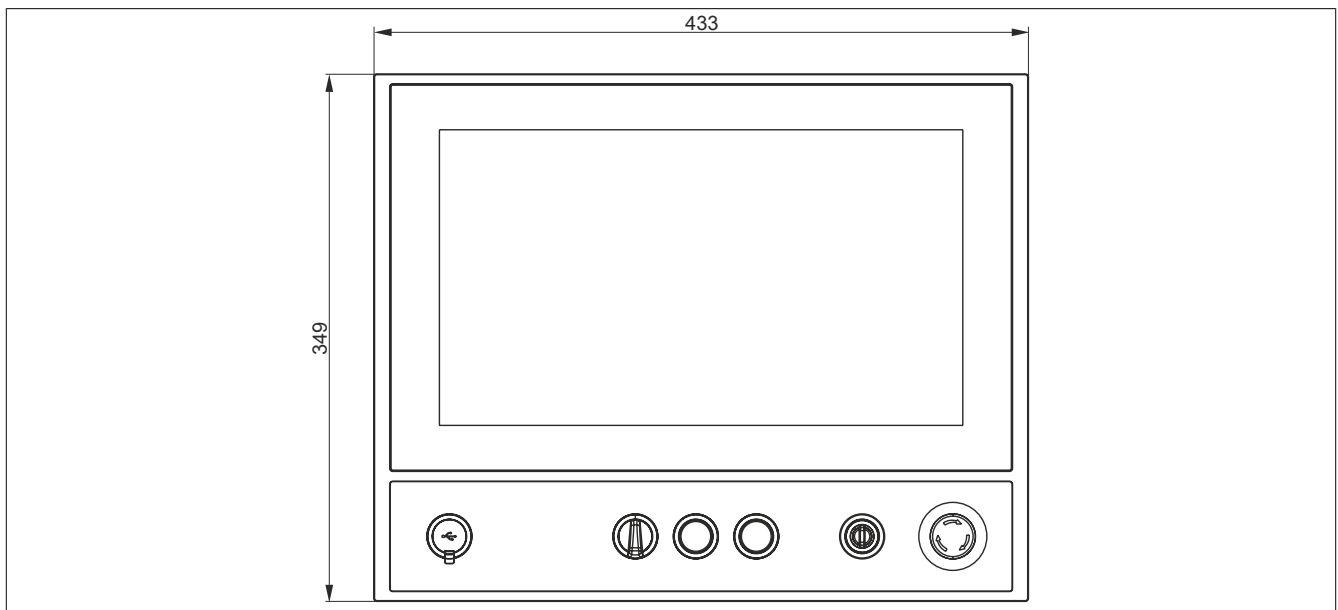

Figure 42: 5AP5230.156B-000 - Dimensions

3.1.9.5 Temperature/Humidity diagram

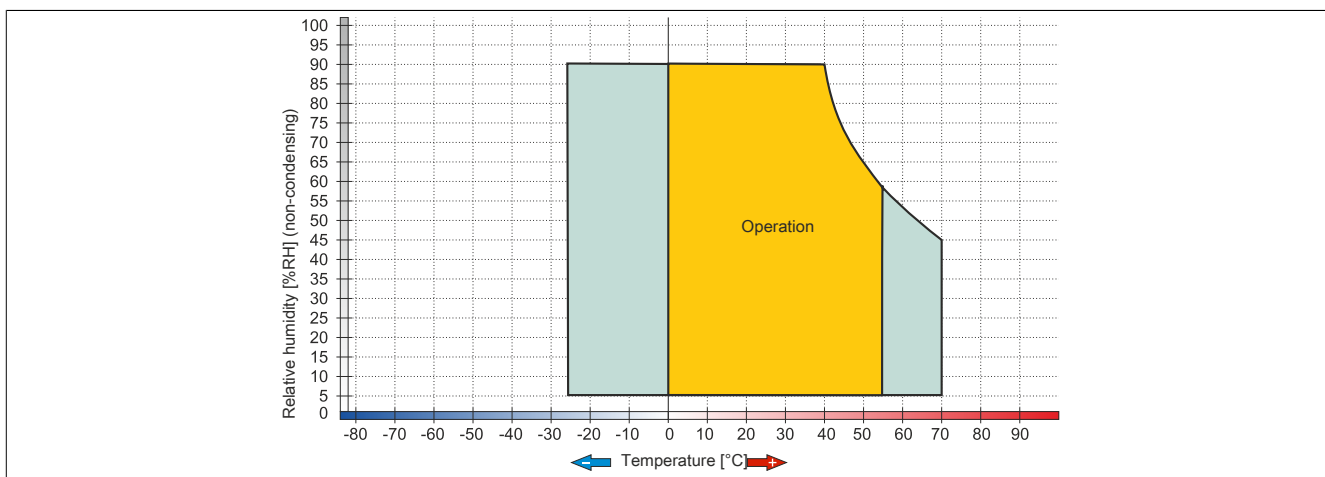

Figure 43: 5AP5230.156B-000 - Temperature/Humidity diagram

3.1.10 5AP5230.156C-000

3.1.10.1 General information

- 15.6" TFT FHD color display
- Multi-touch (PCT)
- Possible to install expansion unit
- Flexible swing arm mounting or VESA
- IP65 protection with mounting unit 5ACCMA00.000x-000
- IP10 protection with mounting unit 5ACCMA01.0100-000

3.1.10.2 Order data

Model number	Short description	Figure
	Panels	
5AP5230.156C-000	Automation Panel 15.6" Full HD TFT - 1920 x 1080 pixels (16:9) - Multi-touch (projected capacitive) - Swing arm mounting - Landscape format - Expansion option - For PPC2100 / PPC2200 / link modules	
	Optional accessories	
	Expansion units	
5ACCKP00.156B-000	AP5000 swing arm expansion option - Expansion cover - For switching elements - 10x cutouts for 22.3 mm switching elements - For panel 5AP5230.156B-000	
5ACCKP01.156B-000	AP5000 swing arm expansion option - Expansion unit - 1x emergency stop - 2x pushbutton (red and green) - 1x selector switch - 1x key switch - 1x front USB interface - For panel 5AP5230.156B-000	
5ACCKP04.156B-000	AP5000 swing arm expansion option - Expansion unit - 1x emergency stop - 3x pushbutton (red, green, blue) - 1x key switch - 1x front USB interface - For panel 5AP5230.156B-000	
	Flange	
5ACCF00.0000-000	AP5000 flange - Swing arm rotary flange - For swing arm mounting unit	
5ACCF00.0200-000	AP5000 flange - Swing arm flange adapter - For Rittal - For swing arm mounting unit	
	Handles	
5ACCHD01.156B-000	AP5000 swing arm handles - For panel 5AP5230.156B-000	
	Mounting units	
5ACCMA00.0000-000	AP5000 swing arm mounting unit	
5ACCMA00.0001-000	AP5000 swing arm mounting unit - 1x rear USB interface	
5ACCMA01.0100-000	AP5000 VESA mounting unit IP20	
	Swing arm mounting units	
5ACCMA00.0002-000	AP5000 swing arm mounting unit - 2x rear USB interface	

Table 71: 5AP5230.156C-000 - Order data

3.1.10.3 Technical data

Information:

The following specifications, properties and limit values apply only to this individual component and may deviate from those that apply to the complete system. For the complete system in which this individual component is used, for example, the data specified for that complete system applies.

Model number	5AP5230.156C-000
General information	
B&R ID code	0xF24B
Certifications	
CE	Yes
UL	cULus E115267 Industrial control equipment
Display	
Type	TFT color
Diagonal	15.6"
Colors	16.7 million
Resolution	FHD, 1920 x 1080 pixels
Contrast	1500:1
Viewing angles	
Horizontal	Direction R = 85° / Direction L = 85°
Vertical	Direction U = 85° / Direction D = 85°

Table 72: 5AP5230.156C-000 - Technical data

Model number	5AP5230.156C-000
Backlight	
Type	LED
Brightness (dimnable)	Typ. 40 to 400 cd/m ²
Half-brightness time	70,000 h
Touch screen	
Type	3M
Technology	Projected capacitive touch (PCT)
Controller	3M
Transmittance	>90%
Operating conditions	
Pollution degree per EN 61131	Pollution degree 2
Protection per EN 60529	IP65 with mounting unit 5ACCMA00.000x-000
Protection per UL 50	Type 4X indoor with mounting unit 5ACCMA00.000x-000
Mechanical characteristics	
Housing	
Material	Aluminum, coated
Coating	White aluminum (similar to RAL 9006)
Front	
Frame	Aluminum (similar to RAL 9006), coated
Design	Black
Dimensions	
Width	433 mm
Height	349 mm
Weight	6400 g

Table 72: 5AP5230.156C-000 - Technical data

3.1.10.4 Dimensions

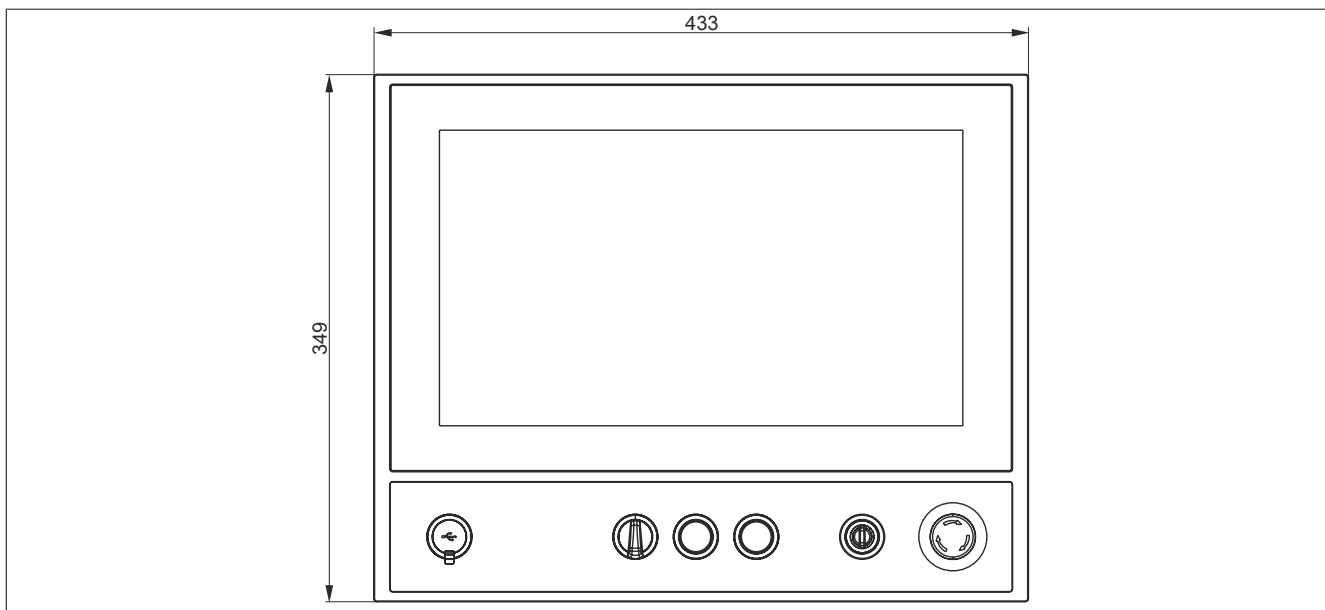

Figure 44: 5AP5230.156C-000 - Dimensions

3.1.10.5 Temperature/Humidity diagram

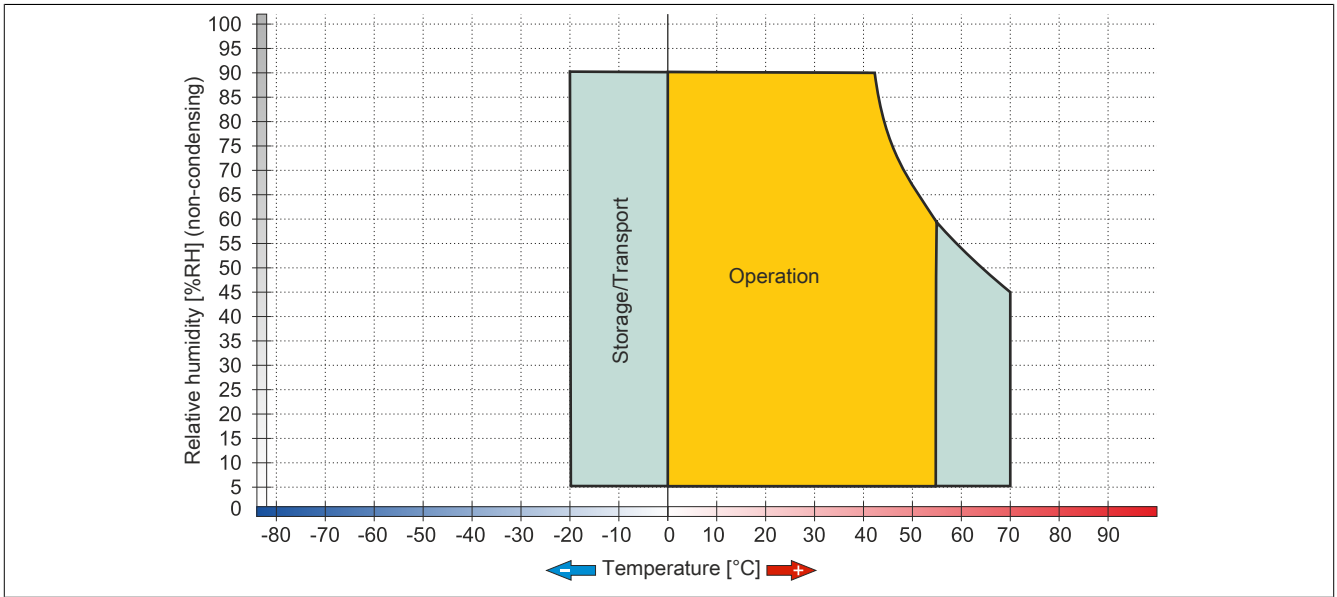

Figure 45: 5AP5230.156C-000 - Temperature/Humidity diagram

3.1.11 5AP5230.185B-000

3.1.11.1 General information

- 18.5" TFT HD color display
- Multi-touch (PCT)
- Possible to install expansion unit
- Flexible swing arm mounting or VESA
- IP65 protection with mounting unit 5ACCMA00.000x-000
- IP10 protection with mounting unit 5ACCMA01.0100-000

3.1.11.2 Order data

Model number	Short description	Figure
	Panels	
5AP5230.185B-000	Automation Panel 18.5" HD TFT - 1366 x 768 pixels (16:9) - Multi-touch (projected capacitive) - Swing arm mounting - Landscape format - Expansion option - For PPC2100 / link modules	
	Optional accessories	
	Expansion units	
5ACCKP00.185B-000	AP5000 swing arm expansion option - Expansion cover - For switching elements - 11x cutouts for 22.3 mm switching elements - For panel 5AP5230.185B-000	
5ACCKP01.185B-000	AP5000 swing arm expansion option - Expansion unit - 1x emergency stop - 2x pushbutton (red and green) - 1x selector switch - 1x key switch - 1x front USB interface - For panel 5AP5230.185B-000	
5ACCKP04.185B-000	AP5000 swing arm expansion option - Expansion unit - 1x emergency stop - 3x pushbutton (red, green, blue) - 1x key switch - 1x front USB interface - For panel 5AP5230.185B-000	
	Flange	
5ACCFL00.0000-000	AP5000 flange - Swing arm rotary flange - For swing arm mounting unit	
5ACCFL00.0200-000	AP5000 flange - Swing arm flange adapter - For Rittal - For swing arm mounting unit	
	Handles	
5ACCHD01.185B-000	AP5000 swing arm handles - For panel 5AP5230.185B-000	
	Mounting units	
5ACCMA00.0000-000	AP5000 swing arm mounting unit	
5ACCMA00.0001-000	AP5000 swing arm mounting unit - 1x rear USB interface	
5ACCMA01.0100-000	AP5000 VESA mounting unit IP20	
	Swing arm mounting units	
5ACCMA00.0002-000	AP5000 swing arm mounting unit - 2x rear USB interface	

Table 73: 5AP5230.185B-000 - Order data

3.1.11.3 Technical data

Information:

The following specifications, properties and limit values apply only to this individual component and may deviate from those that apply to the complete system. For the complete system in which this individual component is used, for example, the data specified for that complete system applies.

Model number	5AP5230.185B-000
General information	
B&R ID code	0xE9F6
Certification	
CE	Yes
UL	cULus E115267 Industrial control equipment
Display	
Type	TFT color
Display size	18.5"
Colors	16.7 million
Resolution	HD, 1366 x 768 pixels
Contrast	1000:1
Viewing angles	
Horizontal	Direction R = 85° / Direction L = 85°
Vertical	Direction U = 80° / Direction D = 80°

Table 74: 5AP5230.185B-000 - Technical data

Model number	5AP5230.185B-000
Backlighting	
Type	LED
Brightness (dimnable)	Typ. 15 to 300 cd/m ²
Half-brightness time ¹⁾	50,000 h
Touch screen	
Type	3M
Technology	Projected capacitive touch (PCT)
Controller	3M
Transmittance	>90%
Inserts	
Expansion unit	Yes
Operating conditions	
EN 61131 pollution degree	Pollution degree 2
Protection per EN 60529	IP65 with mounting unit 5ACCMA00.000x-000
UL 50 protection	Type 4X indoor with mounting unit 5ACCMA00.000x-000
Mechanical characteristics	
Housing	
Material	Aluminum, coated
Coating	White aluminum (similar to RAL 9006)
Front	
Frame	Coated aluminum (similar to RAL 9006)
Design	Black
Dimensions	
Width	494 mm
Height	385.5 mm
Weight	8300 g

Table 74: 5AP5230.185B-000 - Technical data

1) At an ambient temperature of 25°C. Reducing the brightness by 50% can increase the half-brightness time by approximately 50%.

3.1.11.4 Dimensions

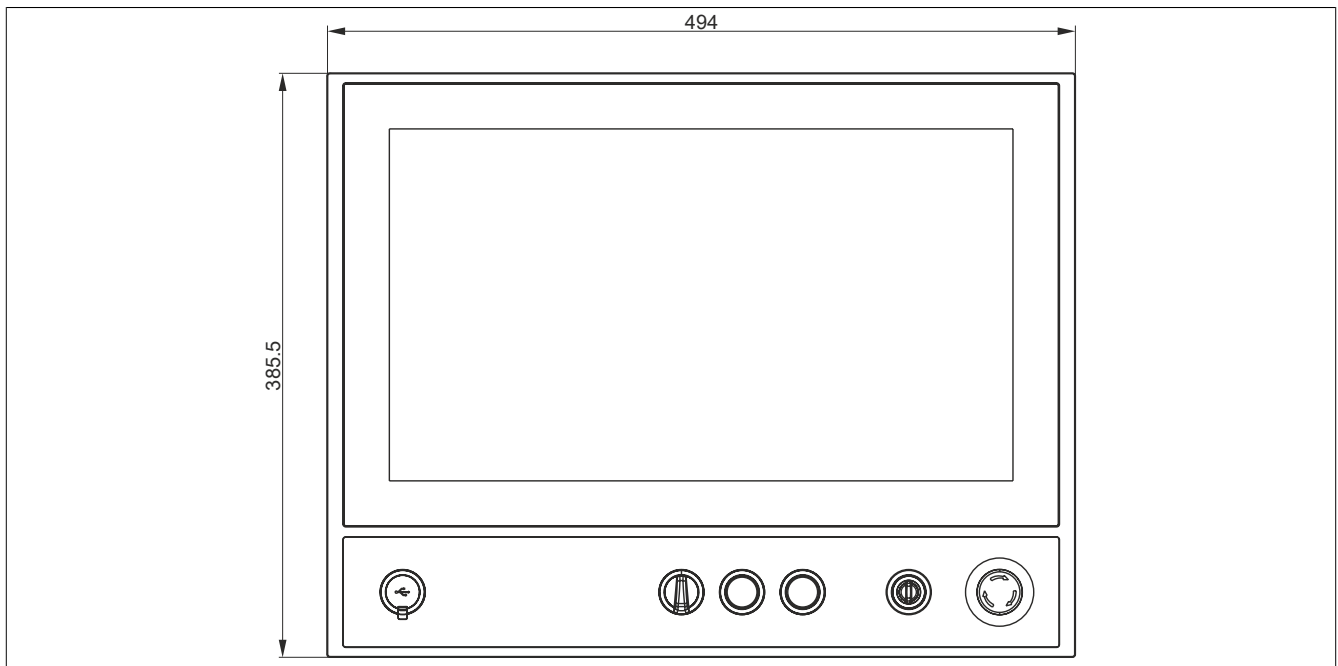

Figure 46: 5AP5230.185B-000 - Dimensions

3.1.11.5 Temperature/Humidity diagram

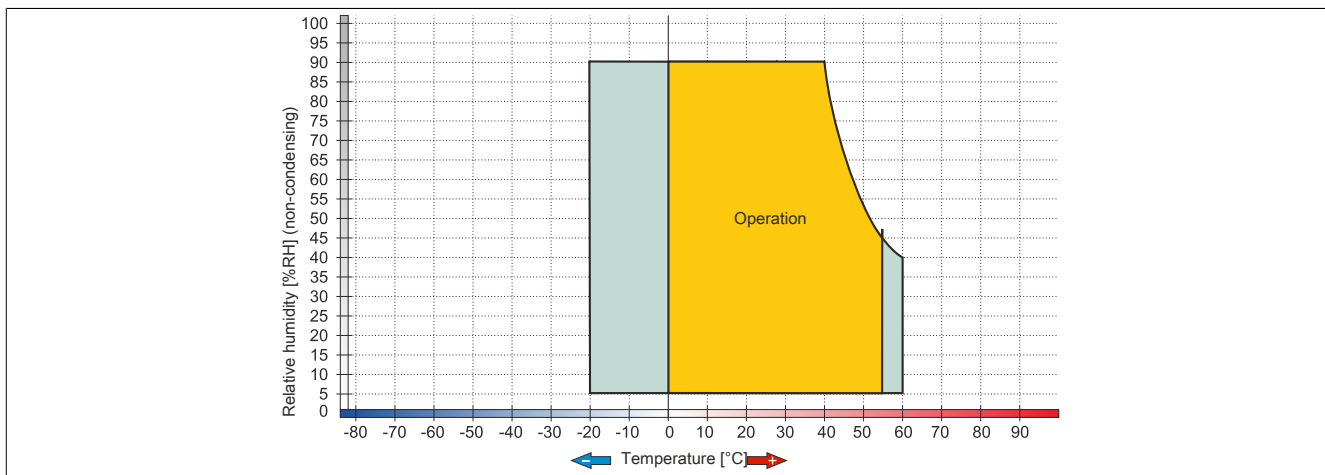

Figure 47: 5AP5230.185B-000 - Temperature/Humidity diagram

3.1.12 5AP5230.185C-000

3.1.12.1 General information

- 18.5" TFT FHD color display
- Multi-touch (PCT)
- Possible to install expansion unit
- Flexible swing arm mounting or VESA
- IP65 protection with mounting unit 5ACCMA00.000x-000
- IP10 protection with mounting unit 5ACCMA01.0100-000

3.1.12.2 Order data

Model number	Short description	Figure
	Panels	
5AP5230.185C-000	Automation Panel 18.5" Full HD TFT - 1920 x 1080 pixels (16:9) - Multi-touch (projected capacitive) - Swing arm mounting - Landscape format - Expansion option - For PPC2100 / PPC2200 / link modules	
	Optional accessories	
	Expansion units	
5ACCKP00.185B-000	AP5000 swing arm expansion option - Expansion cover - For switching elements - 11x cutouts for 22.3 mm switching elements - For panel 5AP5230.185B-000	
5ACCKP01.185B-000	AP5000 swing arm expansion option - Expansion unit - 1x emergency stop - 2x pushbutton (red and green) - 1x selector switch - 1x key switch - 1x front USB interface - For panel 5AP5230.185B-000	
5ACCKP04.185B-000	AP5000 swing arm expansion option - Expansion unit - 1x emergency stop - 3x pushbutton (red, green, blue) - 1x key switch - 1x front USB interface - For panel 5AP5230.185B-000	
	Flange	
5ACCF00.0000-000	AP5000 flange - Swing arm rotary flange - For swing arm mounting unit	
5ACCF00.0200-000	AP5000 flange - Swing arm flange adapter - For Rittal - For swing arm mounting unit	
	Handles	
5ACCHD01.185B-000	AP5000 swing arm handles - For panel 5AP5230.185B-000	
	Mounting units	
5ACCM00.0000-000	AP5000 swing arm mounting unit	
5ACCM00.0001-000	AP5000 swing arm mounting unit - 1x rear USB interface	
5ACCM01.0100-000	AP5000 VESA mounting unit IP20	
	Swing arm mounting units	
5ACCM00.0002-000	AP5000 swing arm mounting unit - 2x rear USB interface	

Table 75: 5AP5230.185C-000 - Order data

3.1.12.3 Technical data

Information:

The following specifications, properties and limit values apply only to this individual component and may deviate from those that apply to the complete system. For the complete system in which this individual component is used, for example, the data specified for that complete system applies.

Model number	5AP5230.185C-000
General information	
B&R ID code	0xF24D
Certifications	
CE	Yes
UL	cULus E115267 Industrial control equipment
Display	
Type	TFT color
Diagonal	18.5"
Colors	16.7 million
Resolution	FHD, 1920 x 1080
Contrast	1500:1
Viewing angles	
Horizontal	Direction R = 85° / Direction L = 85°
Vertical	Direction U = 85° / Direction D = 85°

Table 76: 5AP5230.185C-000 - Technical data

Model number	5AP5230.185C-000
Backlight	
Type	LED
Brightness (dimnable)	Typ. 40 to 400 cd/m ²
Half-brightness time	50,000 h
Touch screen	
Type	3M
Technology	Projected capacitive touch (PCT)
Controller	3M
Transmittance	>90%
Inserts	
Expansion unit	Yes
Operating conditions	
Pollution degree per EN 61131-2	Pollution degree 2
Degree of protection per EN 60529	IP65 with mounting unit 5ACCMA00.000x-000
Protection per UL 50	Type 4X indoor with mounting unit 5ACCMA00.000x-000
Mechanical characteristics	
Housing	
Material	Aluminum, coated
Coating	White aluminum (similar to RAL 9006)
Front	
Frame	Aluminum (similar to RAL 9006)
Design	Black
Dimensions	
Width	494 mm
Height	385.5 mm
Weight	8300 g

Table 76: 5AP5230.185C-000 - Technical data

3.1.12.4 Dimensions

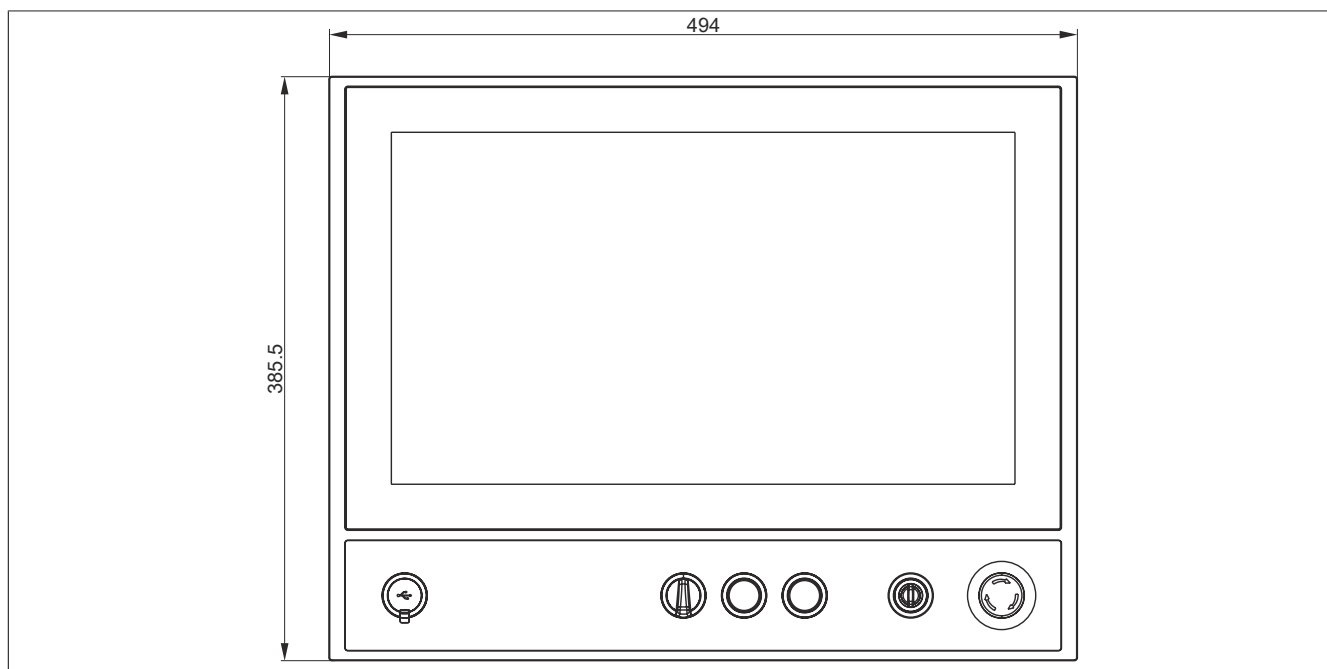

Figure 48: 5AP5230.185C-000

3.1.12.5 Temperature/Humidity diagram

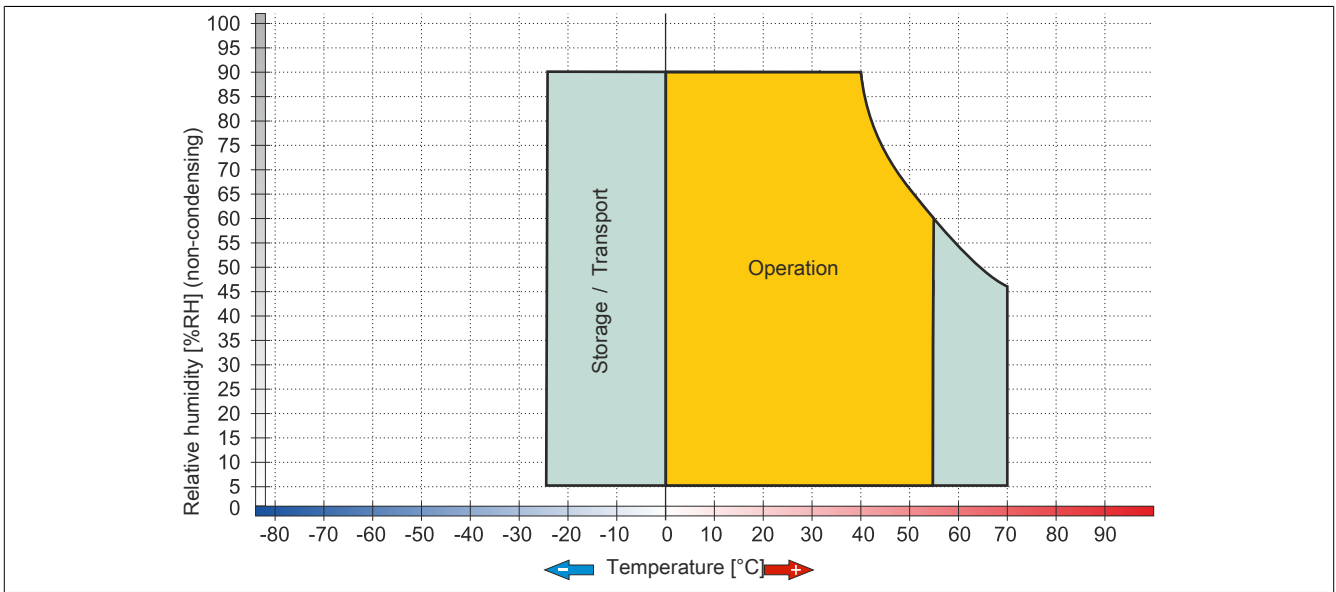

Figure 49: 5AP5230.185C-000 - Temperature/Humidity diagram

3.1.13 5AP5230.215C-000

3.1.13.1 General information

- 21.5" TFT FHD color display
- Multi-touch (PCT)
- Possible to install expansion unit
- Flexible swing arm mounting or VESA
- IP65 protection with mounting unit 5ACCMA00.000x-000
- IP10 protection with mounting unit 5ACCMA01.0100-000

3.1.13.2 Order data

Model number	Short description	Figure
	Panels	
5AP5230.215C-000	Automation Panel 21.5" Full HD TFT - 1920 x 1080 pixels (16:9) - Multi-touch (projected capacitive) - Swing arm mounting - Landscape format - Expansion option - For PPC900 / PPC2100 / link modules	
	Optional accessories	
	Expansion units	
5ACCKP00.215C-000	AP5000 swing arm expansion option - Expansion cover - For switching elements - 13x cutouts for 22.3 mm switching elements - For panel 5AP5230.215C-000	
5ACCKP01.215C-000	AP5000 swing arm expansion option - Expansion unit - 1x emergency stop - 2x pushbutton (red and green) - 1x selector switch - 1x key switch - 1x front USB interface - For panel 5AP5230.215C-000	
5ACCKP04.215C-000	AP5000 swing arm expansion option - Expansion unit - 1x emergency stop - 3x pushbutton (red, green, blue) - 1x key switch - 1x front USB interface - For panel 5AP5230.215C-000	
	Flange	
5ACCFL00.0000-000	AP5000 flange - Swing arm rotary flange - For swing arm mounting unit	
5ACCFL00.0200-000	AP5000 flange - Swing arm flange adapter - For Rittal - For swing arm mounting unit	
	Handles	
5ACCHD01.215C-000	AP5000 swing arm handles - For panel 5AP5230.215C-000	
	Mounting units	
5ACCMA00.0000-000	AP5000 swing arm mounting unit	
5ACCMA00.0001-000	AP5000 swing arm mounting unit - 1x rear USB interface	
5ACCMA01.0100-000	AP5000 VESA mounting unit IP20	
	Swing arm mounting units	
5ACCMA00.0002-000	AP5000 swing arm mounting unit - 2x rear USB interface	

Table 77: 5AP5230.215C-000 - Order data

3.1.13.3 Technical data

Information:

The following specifications, properties and limit values apply only to this individual component and may deviate from those that apply to the complete system. For the complete system in which this individual component is used, for example, the data specified for that complete system applies.

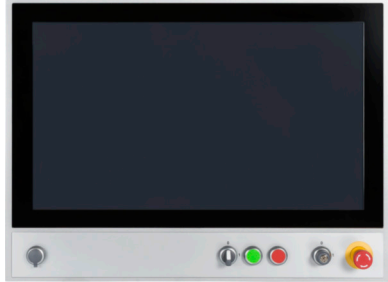
Model number	5AP5230.215C-000
General information	
B&R ID code	0xE9F7
Certification	
CE	Yes
UL	cULus E115267 Industrial control equipment
Display	
Type	TFT color
Display size	21.5"
Colors	16.7 million
Resolution	FHD, 1920 x 1080 pixels
Contrast	5000:1
Viewing angles	
Horizontal	Direction R = 89° / Direction L = 89°
Vertical	Direction U = 89° / Direction D = 89°

Table 78: 5AP5230.215C-000 - Technical data

Model number	5AP5230.215C-000
Backlighting	
Type	LED
Brightness (dimnable)	Typ. 12.5 to 250 cd/m ²
Half-brightness time ¹⁾	30,000 h
Touch screen	
Type	3M
Technology	Projected capacitive touch (PCT)
Controller	3M
Transmittance	>90%
Inserts	
Expansion unit	Yes
Operating conditions	
EN 61131 pollution degree	Pollution degree 2
Protection per EN 60529	IP65 with mounting unit 5ACCMA00.000x-000
UL 50 protection	Type 4X indoor with mounting unit 5ACCMA00.000x-000
Mechanical characteristics	
Housing	
Material	Aluminum, coated
Coating	White aluminum (similar to RAL 9006)
Front	
Frame	Coated aluminum (similar to RAL 9006)
Design	Black
Dimensions	
Width	560.5 mm
Height	423.5 mm
Weight	8900 g

Table 78: 5AP5230.215C-000 - Technical data

1) At an ambient temperature of 25°C. Reducing the brightness by 50% can increase the half-brightness time by approximately 50%.

3.1.13.4 Dimensions

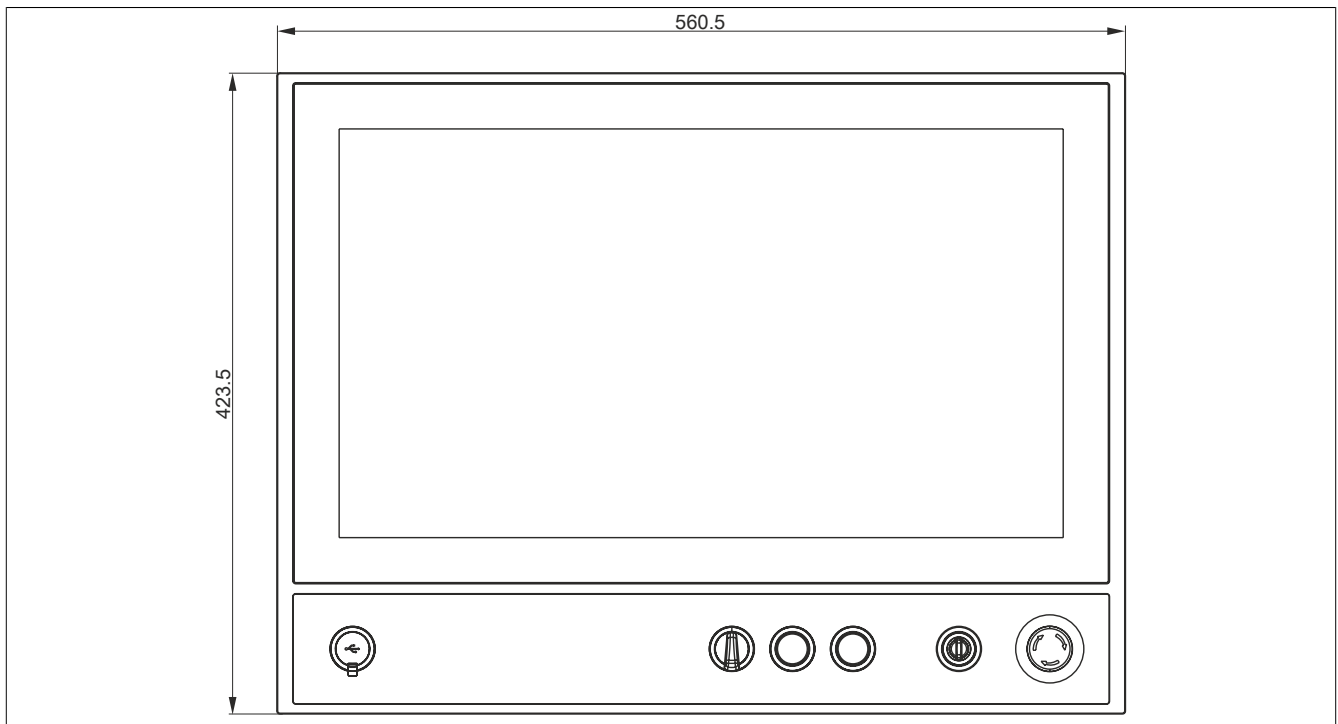

Figure 50: 5AP5230.215C-000 - Dimensions

3.1.13.5 Temp RelativeHumidity

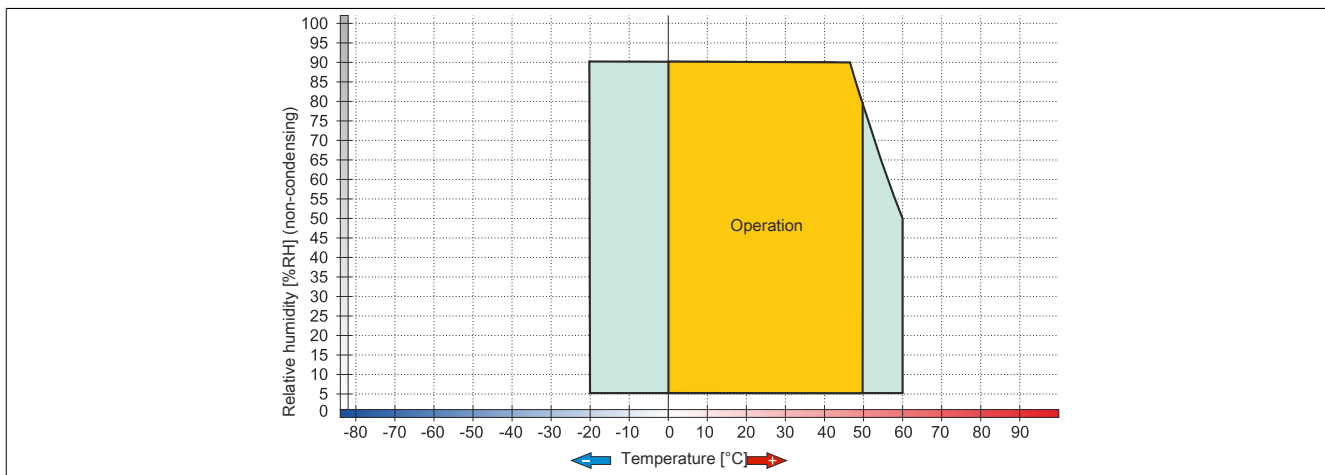

Figure 51: 5AP5230.215C-000 - Temperature/Humidity diagram

3.1.14 5AP5230.215I-000

3.1.14.1 General information

- 21.5" TFT FHD color display
- Multi-touch (PCT)
- Possible to install expansion unit
- Flexible swing arm mounting or VESA
- IP65 protection with mounting unit 5ACCMA00.000x-000
- IP10 protection with mounting unit 5ACCMA01.0100-000

3.1.14.2 Order data

Model number	Short description	Figure
	Panels	
5AP5230.215I-000	Automation Panel 21.5" Full HD TFT - 1920 x 1080 pixels (16:9) - Multi-touch (projected capacitive) - Swing arm mounting - Portrait format - Expansion option - For PPC2100 / link modules	
	Optional accessories	
	Expansion units	
5ACCKP00.215I-000	AP5000 swing arm expansion option - Expansion cover - For switching elements - 7x cutouts for 22.3 mm switching elements - For panel 5AP5230.215I-000	
5ACCKP01.215I-000	AP5000 swing arm expansion option - Expansion unit - 1x emergency stop - 2x pushbutton (red and green) - 1x selector switch - 1x key switch - 1x front USB interface - For panel 5AP5230.215I-000	
5ACCKP04.215I-000	AP5000 swing arm expansion option - Expansion unit - 1x emergency stop - 3x pushbutton (red, green, blue) - 1x key switch - 1x front USB interface - For panel 5AP5230.215I-000	
	Flange	
5ACCFL00.0000-000	AP5000 flange - Swing arm rotary flange - For swing arm mounting unit	
5ACCFL00.0200-000	AP5000 flange - Swing arm flange adapter - For Rittal - For swing arm mounting unit	
	Handles	
5ACCHD01.215I-000	AP5000 swing arm handles - For panel 5AP5230.215I-000	
	Mounting units	
5ACCMA00.0000-000	AP5000 swing arm mounting unit	
5ACCMA00.0001-000	AP5000 swing arm mounting unit - 1x rear USB interface	
5ACCMA01.0100-000	AP5000 VESA mounting unit IP20	
	Swing arm mounting units	
5ACCMA00.0002-000	AP5000 swing arm mounting unit - 2x rear USB interface	

Table 79: 5AP5230.215I-000 - Order data

3.1.14.3 Technical data

Information:

The following specifications, properties and limit values apply only to this individual component and may deviate from those that apply to the complete system. For the complete system in which this individual component is used, for example, the data specified for that complete system applies.

Model number	5AP5230.215I-000
General information	
B&R ID code	0xE9F8
Certification	
CE	Yes
UL	cULus E115267 Industrial control equipment
Display	
Type	TFT color
Display size	21.5"
Colors	16.7 million
Resolution	FHD, 1920 × 1080 pixels
Contrast	5000:1
Viewing angles	
Horizontal	Direction R = 89° / Direction L = 89°
Vertical	Direction U = 89° / Direction D = 89°

Table 80: 5AP5230.215I-000 - Technical data

Model number	5AP5230.215I-000
Backlighting	
Type	LED
Brightness (dimnable)	Typ. 12.5 to 250 cd/m ²
Half-brightness time ¹⁾	30,000 h
Touch screen	
Type	3M
Technology	Projected capacitive touch (PCT)
Controller	3M
Transmittance	>90%
Operating conditions	
EN 61131 pollution degree	Pollution degree 2
Protection per EN 60529	IP65 with mounting unit 5ACCMA00.000x-000
UL 50 protection	Type 4X indoor with mounting unit 5ACCMA00.000x-000
Mechanical characteristics	
Housing	
Material	Aluminum, coated
Coating	White aluminum (similar to RAL 9006)
Front	
Frame	Coated aluminum (similar to RAL 9006)
Design	Black
Dimensions	
Width	352 mm
Height	632 mm
Weight	5400 g

Table 80: 5AP5230.215I-000 - Technical data

1) At an ambient temperature of 25°C. Reducing the brightness by 50% can increase the half-brightness time by approximately 50%.

3.1.14.4 Dimensions

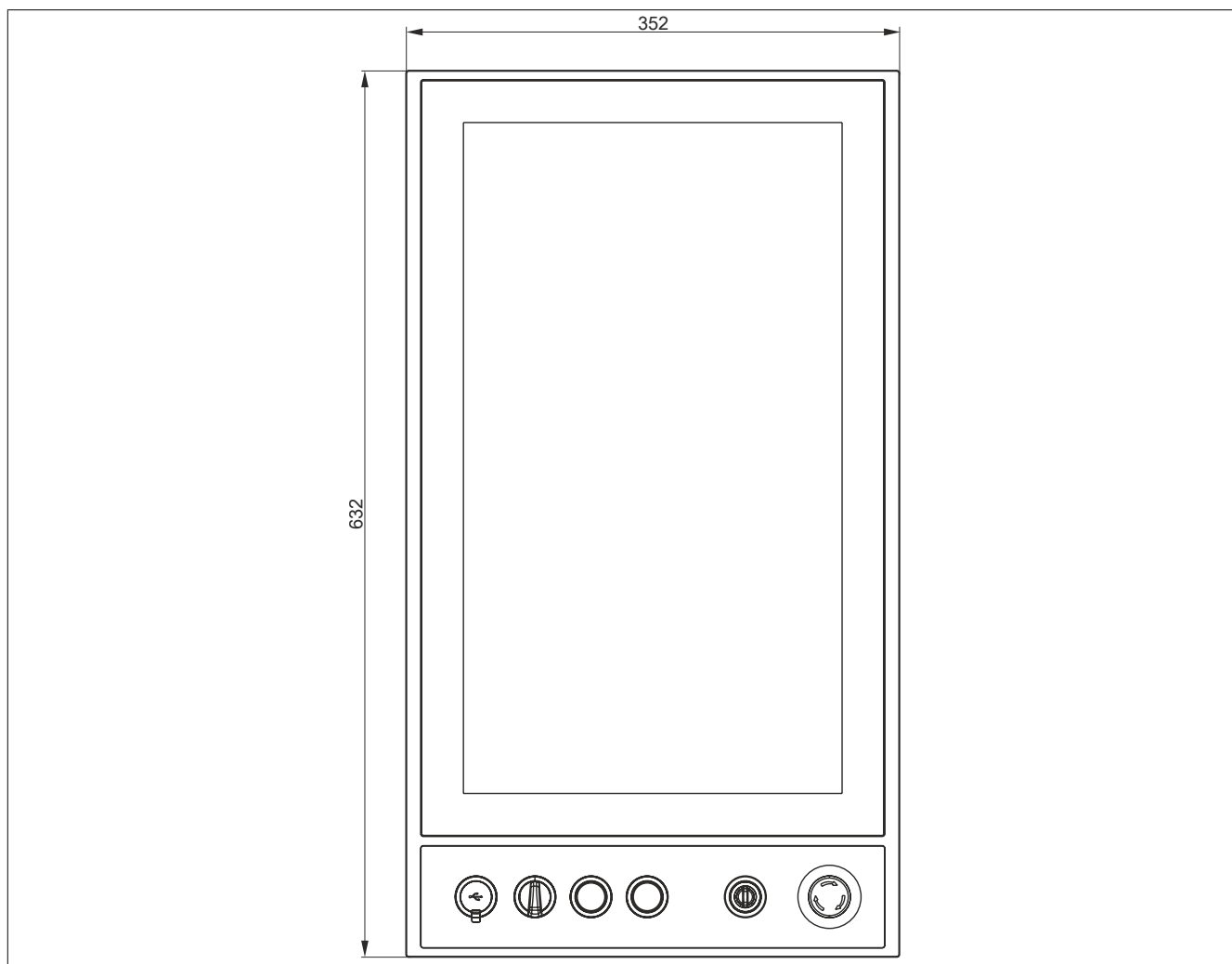

Figure 52: 5AP5230.215I-000 - Dimensions

3.1.14.5 Temperature/Humidity diagram

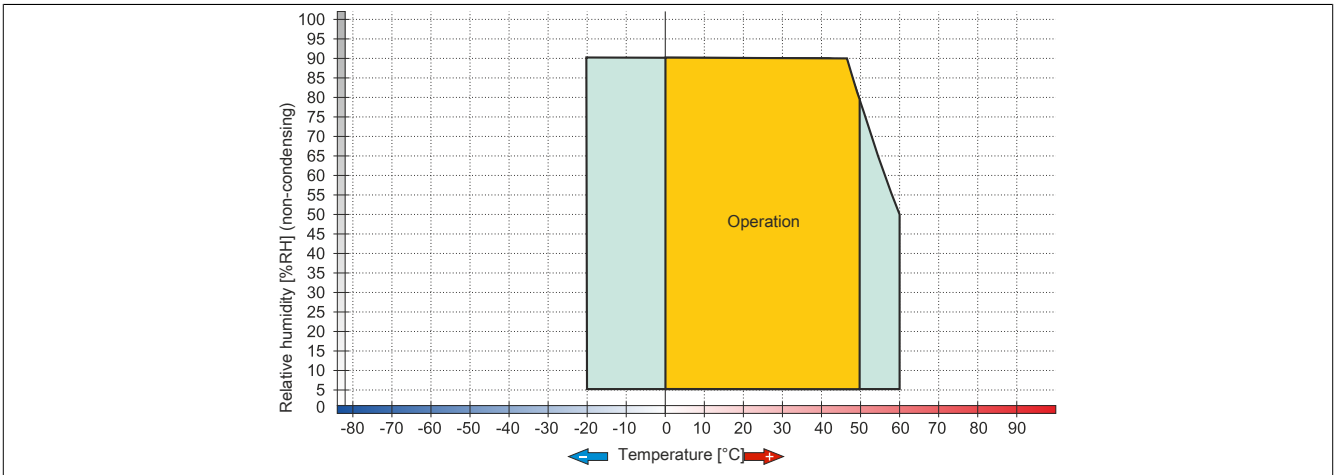

Figure 53: 5AP5230.215I-000 - Temperature/Humidity diagram

3.1.15 5AP5230.240C-000

3.1.15.1 General information

- 24.0" TFT FHD color display
- Multi-touch (PCT)
- Possible to install expansion unit
- Flexible swing arm mounting or VESA
- IP65 protection with mounting unit 5ACCMA00.000x-000
- IP10 protection with mounting unit 5ACCMA01.0100-000

3.1.15.2 Order data

Model number	Short description	Figure
	Panels	
5AP5230.240C-000	Automation Panel 24.0" Full HD TFT - 1920 x 1080 pixels (16:9) - Multi-touch (projected capacitive) - Swing arm mounting - Landscape format - Expansion option - For PPC900 / PPC2100 / link modules	
	Optional accessories	
	Expansion units	
5ACCKP00.240C-000	AP5000 swing arm expansion option - Expansion cover - For switching elements - 14x cutouts for 22.3 mm switching elements - For panel 5AP5230.240C-000	
5ACCKP01.240C-000	AP5000 swing arm expansion option - Expansion unit - 1x emergency stop - 2x pushbutton (red and green) - 1x selector switch - 1x key switch - 1x front USB interface - For panel 5AP5230.240C-000	
5ACCKP04.240C-000	AP5000 swing arm expansion option - Expansion unit - 1x emergency stop - 3x pushbutton (red, green, blue) - 1x key switch - 1x front USB interface - For panel 5AP5230.240C-000	
	Flange	
5ACCFL00.0000-000	AP5000 flange - Swing arm rotary flange - For swing arm mounting unit	
5ACCFL00.0200-000	AP5000 flange - Swing arm flange adapter - For Rittal - For swing arm mounting unit	
	Handles	
5ACCHD01.240C-000	AP5000 swing arm handles - For panel 5AP5230.240C-000	
	Mounting units	
5ACCMA00.0000-000	AP5000 swing arm mounting unit	
5ACCMA00.0001-000	AP5000 swing arm mounting unit - 1x rear USB interface	
5ACCMA01.0100-000	AP5000 VESA mounting unit IP20	
	Swing arm mounting units	
5ACCMA00.0002-000	AP5000 swing arm mounting unit - 2x rear USB interface	

Table 81: 5AP5230.240C-000 - Order data

3.1.15.3 Technical data

Information:

The following specifications, properties and limit values apply only to this individual component and may deviate from those that apply to the complete system. For the complete system in which this individual component is used, for example, the data specified for that complete system applies.

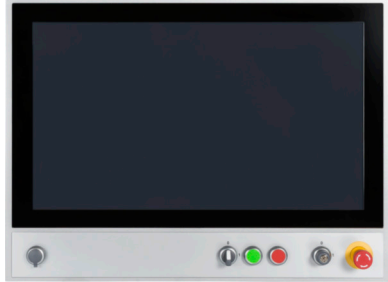
Model number	5AP5230.240C-000
General information	
B&R ID code	0xE9F9
Certification	
CE	Yes
UL	cULus E115267 Industrial control equipment
Display	
Type	TFT color
Display size	24.0"
Colors	16.7 million
Resolution	FHD, 1920 x 1080 pixels
Contrast	5000:1
Viewing angles	
Horizontal	Direction R = 89° / Direction L = 89°
Vertical	Direction U = 89° / Direction D = 89°

Table 82: 5AP5230.240C-000 - Technical data

Model number	5AP5230.240C-000
Backlighting	
Type	LED
Brightness (dimnable)	Typ. 30 to 300 cd/m ²
Half-brightness time ¹⁾	50,000 h
Touch screen	
Type	3M
Technology	Projected capacitive touch (PCT)
Controller	3M
Transmittance	>90%
Inserts	
Expansion unit	Yes
Operating conditions	
EN 61131 pollution degree	Pollution degree 2
Protection per EN 60529	IP65 with mounting unit 5ACCMA00.000x-000
UL 50 protection	Type 4X indoor with mounting unit 5ACCMA00.000x-000
Mechanical characteristics	
Housing	
Material	Aluminum, coated
Coating	White aluminum (similar to RAL 9006)
Front	
Frame	Coated aluminum (similar to RAL 9006)
Design	Black
Dimensions	
Width	617.5 mm
Height	454.5 mm
Weight	10300 g

Table 82: 5AP5230.240C-000 - Technical data

1) At an ambient temperature of 25°C. Reducing the brightness by 50% can increase the half-brightness time by approximately 50%.

3.1.15.4 Dimensions

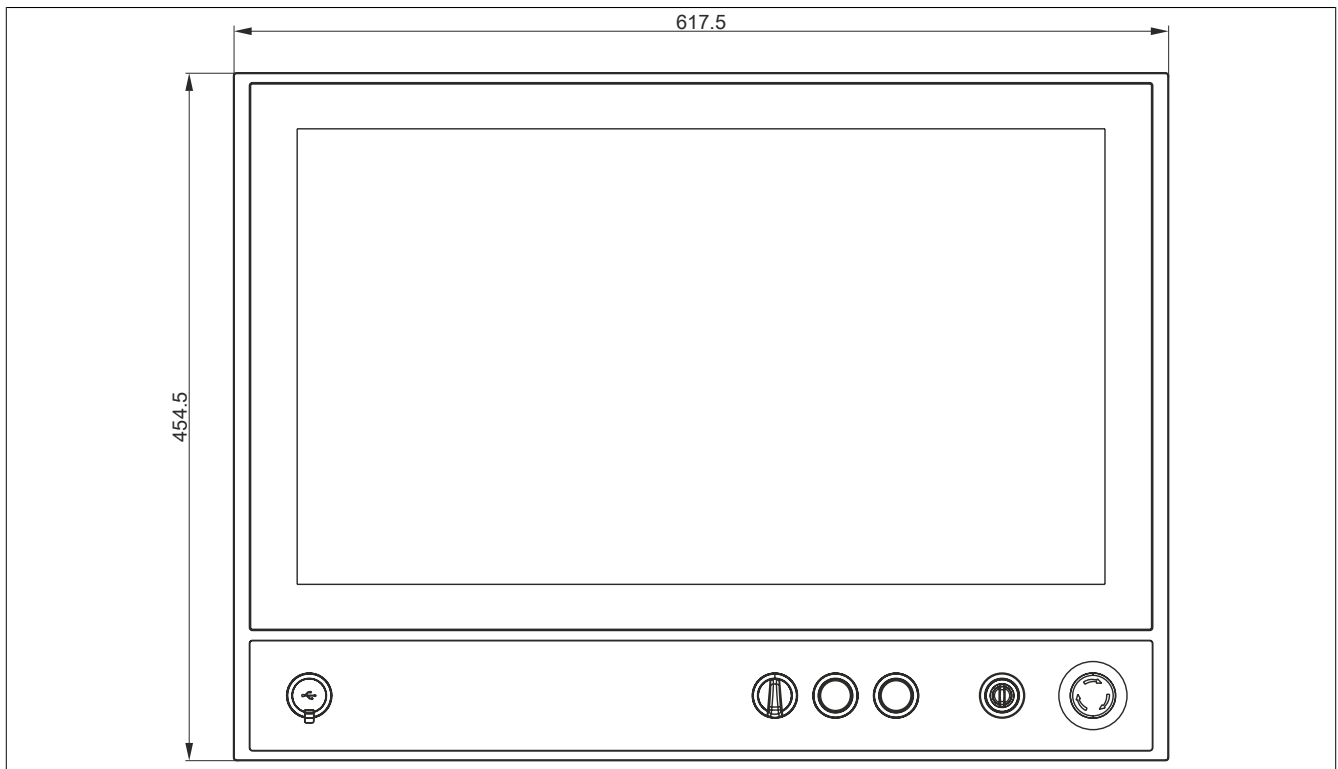

Figure 54: 5AP5230.240C-000 - Dimensions

3.1.15.5 Temperature/Humidity diagram

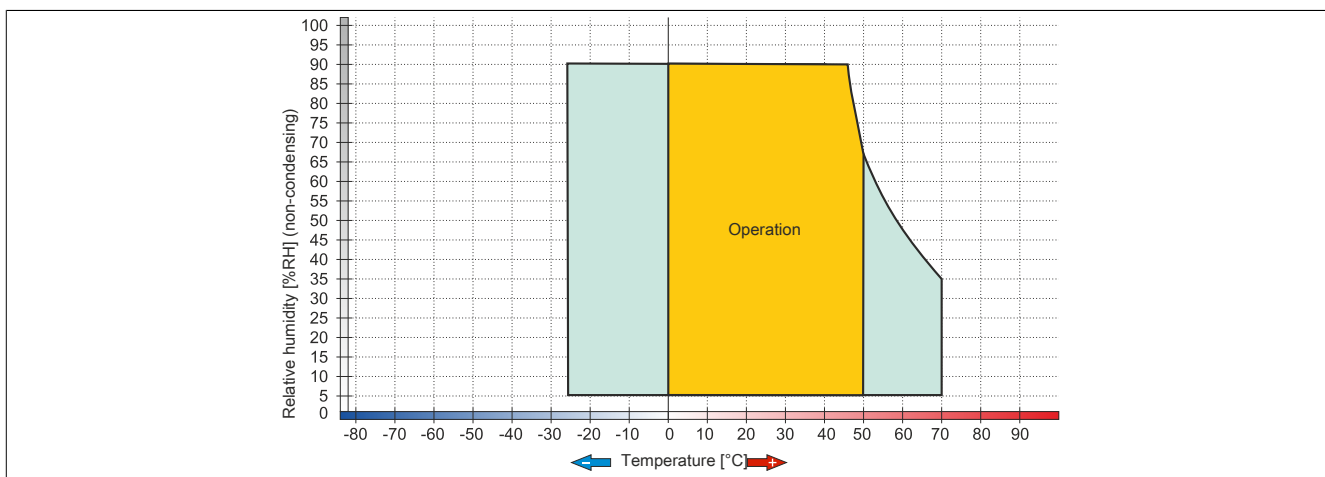

Figure 55: 5AP5230.240C-000 - Temperature/Humidity diagram

3.2 Link modules

3.2.1 5DLSD4.1001-00

3.2.1.1 General information

- Link module for Automation Panel 9x3/1000/5000
- 1x SDL4 Panel In interface
- 2x USB 2.0 type A

3.2.1.2 Order data

Model number	Short description	Figure
	Link modules	
5DLSD4.1001-00	Automation Panel link module - SDL4 receiver - For Automation Panel 923/933/1000 - For Automation Panel 5000	
	Required accessories	
	Terminal blocks	
0TB103.9	Connector 24 VDC - 3-pin female - Screw clamp terminal block 3.31 mm ²	
0TB103.91	Connector 24 VDC - 3-pin female - Cage clamp terminal block 3.31 mm ²	
	Optional accessories	
	SDL3/SDL4 cables	
5CASD3.0030-00	SDL3/SDL4 cable - 3 m	
5CASD3.0050-00	SDL3/SDL4 cable - 5 m	
5CASD3.0100-00	SDL3/SDL4 cable - 10 m	
5CASD3.0150-00	SDL3/SDL4 cable - 15 m	
5CASD3.0200-00	SDL3/SDL4 cable - 20 m	
5CASD3.0300-00	SDL3/SDL4 cable - 30 m	
5CASD3.0500-00	SDL3/SDL4 cable - 50 m	
5CASD3.1000-00	SDL3/SDL4 cable - 100 m	

Table 83: 5DLSD4.1001-00 - Order data

3.2.1.3 Technical data

Information:

The following specifications, properties and limit values apply only to this individual component and may deviate from those that apply to the complete system. For the complete system in which this individual component is used, for example, the data specified for that complete system applies.

Model number	5DLSD4.1001-00
General information	
LED status indicators	Status, Link
B&R ID code	0xECE3
Certifications	
CE	Yes
Interfaces	
USB	
Quantity	2
Type	USB 2.0
Design	2x type A
Transfer rate	Low speed (1.5 Mbit/s), full speed (12 Mbit/s), high speed (150 Mbit/s)
Current-carrying capacity	Total max. 1 A
SDL4 In	
Design	Shielded RJ45
Type	SDL4
Electrical characteristics	
Nominal voltage	24 VDC ±25%, SELV ¹⁾
Nominal current	Max. 3 A
Overvoltage category per EN 61131-2	II
Electrical isolation	Yes
Operating conditions	
Pollution degree per EN 61131-2	Pollution degree 2

Table 84: 5DLSD4.1001-00 - Technical data

Model number	5DLSD4.1001-00
Mechanical characteristics	
Dimensions	
Width	190 mm
Height	110 mm
Depth	23.6 mm
Weight	525 g

Table 84: 5DLSD4.1001-00 - Technical data

- 1) EN 60950 requirements must be observed; see section "+24 VDC power supply" of the user's manual.

3.2.2 5DLSD3.1001-00

3.2.2.1 General information

- Link module for Automation Panel 9x3/1000/5000
- 1x SDL3 Panel In interface
- 2x USB 2.0 type A

3.2.2.2 Order data

Model number	Short description	Figure
	Link modules	
5DLSD3.1001-00	Automation Panel link module - SDL3 receiver - For Automation Panel 923/933/1000 - For Automation Panel 5000	
	Required accessories	
	Terminal blocks	
0TB103.9	Connector 24 VDC - 3-pin female - Screw clamp terminal block 3.31 mm ²	
0TB103.91	Connector 24 VDC - 3-pin female - Cage clamp terminal block 3.31 mm ²	
	Optional accessories	
	SDL3/SDL4 cables	
5CASD3.0030-00	SDL3/SDL4 cable - 3 m	
5CASD3.0050-00	SDL3/SDL4 cable - 5 m	
5CASD3.0100-00	SDL3/SDL4 cable - 10 m	
5CASD3.0150-00	SDL3/SDL4 cable - 15 m	
5CASD3.0200-00	SDL3/SDL4 cable - 20 m	
5CASD3.0300-00	SDL3/SDL4 cable - 30 m	
5CASD3.0500-00	SDL3/SDL4 cable - 50 m	
5CASD3.1000-00	SDL3/SDL4 cable - 100 m	

Table 85: 5DLSD3.1001-00 - Order data

3.2.2.3 Technical data

Information:

The following specifications, properties and limit values apply only to this individual component and may deviate from those that apply to the complete system. For the complete system in which this individual component is used, for example, the data specified for that complete system applies.

Model number	5DLSD3.1001-00
General information	
LED status indicators	Status, Link
B&R ID code	0xE3FC
Certifications	
CE	Yes
UL	cULus E115267 Industrial control equipment
HazLoc	cULus HazLoc E180196 Industrial control equipment for hazardous locations Class I, Division 2, Groups ABCD, T4 ¹⁾
Interfaces	
USB	
Quantity	2
Type	USB 2.0
Design	2x type A
Transfer rate	Low speed (1.5 Mbit/s), full speed (12 Mbit/s), high speed (30 Mbit/s)
Current-carrying capacity	Total max. 1 A
SDL3 In	
Design	Shielded RJ45
Type	SDL3
Electrical characteristics	
Nominal voltage	24 VDC ±25%, SELV ²⁾
Nominal current	Max. 3 A
Overvoltage category per EN 61131-2	II
Electrical isolation	Yes
Operating conditions	
Pollution degree per EN 61131-2	Pollution degree 2

Table 86: 5DLSD3.1001-00 - Technical data

Model number	5DLSD3.1001-00
Mechanical characteristics	
Dimensions	
Width	190 mm
Height	110 mm
Depth	23.6 mm
Weight	527 g

Table 86: 5DLSD3.1001-00 - Technical data

- 1) Yes, although applies only if all components installed within the complete system have this certification and the complete system itself carries the corresponding mark.
- 2) EN 60950 requirements must be observed, see section "+24 VDC power supply" in the user's manual.

3.2.3 5DLSDL.1001-00

3.2.3.1 General information

- Link module for Automation Panel 9x3/1000/5000
- 1x SDL/DVI Panel In interface
- 2x USB 2.0 type A
- 1x USB In (USB type B)
- 1x RS232 interface
- Display brightness buttons

3.2.3.2 Order data

Model number	Short description	Figure
	Link modules	
5DLSDL.1001-00	Automation Panel link module - SDL/DVI receiver - For Automation Panel 923/933/1000 - For Automation Panel 5000	
	Required accessories	
	Terminal blocks	
0TB103.9	Connector 24 VDC - 3-pin female - Screw clamp terminal block 3.31 mm ²	
0TB103.91	Connector 24 VDC - 3-pin female - Cage clamp terminal block 3.31 mm ²	

Table 87: 5DLSDL.1001-00 - Order data

3.2.3.3 Technical data

Information:

The following specifications, properties and limit values apply only to this individual component and may deviate from those that apply to the complete system. For the complete system in which this individual component is used, for example, the data specified for that complete system applies.

Model number	5DLSDL.1001-00
General information	
B&R ID code	0xE1A4
Brightness buttons	Yes ¹⁾
Certifications	
CE	Yes
UL	cULus E115267 Industrial control equipment
HazLoc	cULus HazLoc E180196 Industrial control equipment for hazardous locations Class I, Division 2, Groups ABCD, T4 ²⁾
DNV GL	Temperature: B (0 - 55°C) Humidity: B (up to 100%) Vibration: A (0.7 g) EMC: B (Bridge and open deck) ³⁾
GOST-R	Yes
Interfaces	
COM	
Type	RS232, modem supported, not electrically isolated
Design	DSUB, 9-pin, female
UART	16550-compatible, 16-byte FIFO
Max. baud rate	115 kbit/s
USB	
Quantity	3 (2x Type A; 1x Type B)
Type	USB 2.0 ⁴⁾
Design	2x type A 1x type B
Transfer rate	Low speed (1.5 Mbit/s), full speed (12 Mbit/s), high speed (480 Mbit/s)
Current-carrying capacity	Total max. 1 A ⁵⁾
Panel In	
Design	DVI-D
Type	SDL/DVI
Electrical characteristics	
Nominal voltage	24 VDC ±25%, SELV ⁶⁾
Nominal current	Max. 3 A
Overvoltage category per EN 61131-2	II

Table 88: 5DLSDL.1001-00 - Technical data

Model number	5DLSDL.1001-00
Electrical isolation	Yes
Operating conditions	
Pollution degree per EN 61131-2	Pollution degree 2
Mechanical characteristics	
Dimensions	
Width	190 mm
Height	110 mm
Depth	23.6 mm
Weight	538 g

Table 88: 5DLSDL.1001-00 - Technical data

- 1) The brightness controls can be used to configure the brightness of the backlight on the Automation Panel in DVI mode.
- 2) Yes, although applies only if all components installed in the complete system have this certification and the complete system bears the corresponding mark.
- 3) Yes, although applies only if all components installed in the complete system have this certification and are listed on the associated DNV GL certificate for the product family.
- 4) In "SDL mode 1", USB 1.1 transfer rates are the highest possible.
- 5) For the 2 USB type A female connectors.
- 6) EN 60950 requirements must be observed; see section "+24 VDC power supply" of the user's manual.

3.3 Mounting units

3.3.1 5ACCMA00.0000-000

3.3.1.1 General information

The mounting unit is installed on the back of the panel. It protects the installed link module / system unit, enabling IP65 protection for the complete system. The flange is installed on the mounting unit. Due to the symmetrical design of the back of the panel, it is possible to install the mounting unit in 2 directions. If a flange is selected for mounting, flange output is possible towards the top or bottom.

- Protects the installed link module / system unit
- For swing arm mounting with flange
- IP65 protection

3.3.1.2 Order data

Model number	Short description	Figure
	Mounting units	
5ACCMA00.0000-000	AP5000 swing arm mounting unit	
	Optional accessories	
	Flange	
5ACCFL00.0000-000	AP5000 flange - Swing arm rotary flange - For swing arm mounting unit	
5ACCFL00.0200-000	AP5000 flange - Swing arm flange adapter - For Rittal - For swing arm mounting unit	

Table 89: 5ACCMA00.0000-000 - Order data

3.3.1.3 Technical data

Information:

The following specifications, properties and limit values apply only to this individual component and may deviate from those that apply to the complete system. For the complete system in which this individual component is used, for example, the data specified for that complete system applies.

Model number	5ACCMA00.0000-000
General information	
Certification	
CE	Yes
UL	cULus E115267 Industrial control equipment
Operating conditions	
EN 61131 pollution degree	Pollution degree 2
Protection per EN 60529	IP65 ¹⁾
UL 50 protection	Type 4X indoor ¹⁾
Mechanical characteristics	
Housing	
Material	Aluminum, coated
Coating	White aluminum (similar to RAL 9006)
Installation	Swing arm (with flange)
Dimensions	
Width	280 mm
Height	259 mm
Depth	96 mm
Weight	2500 g

Table 90: 5ACCMA00.0000-000 - Technical data

1) Only with proper installation on the panel and proper installation on the swing arm.

3.3.2 5ACCMA00.0001-000

3.3.2.1 General information

The mounting unit is installed on the back of the panel. It protects the installed link module / system unit, enabling IP65 protection for the complete system. The flange is installed on the mounting unit. Due to the symmetrical design of the back of the panel, it is possible to install the mounting unit in 2 directions. If a flange is selected for mounting, flange output is possible towards the top or bottom.

A USB interface is available on the side of the mounting unit for service purposes.

- Protects the installed link module / system unit
- For swing arm mounting with flange
- USB 2.0 interface
- IP65 protection

3.3.2.2 Order data

Model number	Short description	Figure
5ACCMA00.0001-000	AP5000 swing arm mounting unit - 1x rear USB interface	
	Optional accessories	
	Flange	
5ACCFL00.0000-000	AP5000 flange - Swing arm rotary flange - For swing arm mounting unit	
5ACCFL00.0200-000	AP5000 flange - Swing arm flange adapter - For Rittal - For swing arm mounting unit	

Table 91: 5ACCMA00.0001-000 - Order data

3.3.2.3 Technical data

Information:

The following specifications, properties and limit values apply only to this individual component and may deviate from those that apply to the complete system. For the complete system in which this individual component is used, for example, the data specified for that complete system applies.

Model number	5ACCMA00.0001-000
General information	
Certification	
CE	Yes
UL	cULus E115267 Industrial control equipment
Interfaces	
USB	
Quantity	1
Type	USB 2.0
Design	Type A
Transfer rate	Low speed (1.5 Mbit/s), full speed (12 Mbit/s), high speed (30 Mbit/s)
Current-carrying capacity	Max. 500 mA
Operating conditions	
EN 61131 pollution degree	Pollution degree 2
Protection per EN 60529	IP65 ¹⁾
UL 50 protection	Type 4X indoor ¹⁾
Mechanical characteristics	
Housing	
Material	Aluminum, coated
Coating	White aluminum (similar to RAL 9006)
Installation	Swing arm (with flange)
Dimensions	
Width	280 mm
Height	259 mm
Depth	96 mm
Weight	2500 g

Table 92: 5ACCMA00.0001-000 - Technical data

1) Only with proper installation on the panel and proper installation on the swing arm.

3.3.2.4 USB interface

The mounting unit is equipped with a USB 2.0 interface. This is equipped with a protective cover.

Caution!

IP65 protection can only be achieved if the USB protective cover is properly installed.

Warning!

Peripheral USB devices can be connected to the USB interfaces. Due to the large number of USB devices available on the market, B&R cannot guarantee their functionality. Functionality is ensured when using the USB devices available from B&R.

Caution!

Because this interface is designed according to general PC specifications, extreme care should be taken with regard to EMC, wiring, etc.

USB interface on mounting unit

The USB interface is available to the user for service purposes.

Information:

In the default configuration, the USB interface is the USB1 interface on the link module.

Depending on the transfer method (SDL or DVI mode), the transfer rate of the USB1 and USB2 interfaces may be limited. For possible transfer methods, see section "Connection options" on page 22.

Transfer method	USB type	Max. cable length
SDL mode 1	USB 1.1	25 m
SDL mode 2	USB 2.0	5 m
DVI mode, single-touch	USB 2.0	5 m
DVI mode, multi-touch	USB 2.0	5 m
SDL3 mode	USB 2.0	100 m

Universal Serial Bus (USB on mounting unit) ¹⁾		
Type	USB 2.0	1x USB type A, female 
Design	Type A	
Transfer rate	Low speed (1.5 Mbit/s), full speed (12 Mbit/s), high speed (480 Mbit/s) ²⁾	
Current-carrying capacity ³⁾ Front USB	Max. 500 mA	
Cable length USB 2.0	<3 m (without hub)	

Table 93: USB interface

- 1) The interfaces, etc. available on the device or module have been numbered as such for the purpose of clear differentiation. This numbering may deviate from the numbering used by the respective operating system, however.
- 2) In SDL3 operation: Low speed (1.5 Mbit/s), full speed (12 Mbit/s), high speed (30 Mbit/s).
- 3) The USB interface is protected by a maintenance-free "USB current-limiting switch" (max. 500 mA).

3.3.3 5ACCMA00.0002-000

3.3.3.1 General information

The mounting unit is installed on the back of the panel. It protects the installed link module / system unit, enabling IP65 protection for the complete system. The flange is installed on the mounting unit. Due to the symmetrical design of the back of the panel, it is possible to install the mounting unit in 2 directions. If a flange is selected for mounting, flange output is possible towards the top or bottom.

2 USB interfaces are available on the side of the mounting unit for service purposes.

- Protects the installed link module / system unit
- For swing arm mounting with flange
- 2x USB 2.0 interface
- IP65 protection

3.3.3.2 Order data

Model number	Short description	Figure
	Swing arm mounting units	
5ACCMA00.0002-000	AP5000 swing arm mounting unit - 2x rear USB interface	
	Optional accessories	
	Flange	
5ACCFL00.0000-000	AP5000 flange - Swing arm rotary flange - For swing arm mounting unit	
5ACCFL00.0200-000	AP5000 flange - Swing arm flange adapter - For Rittal - For swing arm mounting unit	

Table 94: 5ACCMA00.0002-000 - Order data

3.3.3.3 Technical data

Information:

The following specifications, properties and limit values apply only to this individual component and may deviate from those that apply to the complete system. For the complete system in which this individual component is used, for example, the data specified for that complete system applies.

Model number	5ACCMA00.0002-000
General information	
Certification	
CE	Yes
UL	cULus E115267 Industrial control equipment
Interfaces	
USB	
Quantity	2
Type	USB 2.0
Design	Type A
Transfer rate	Low speed (1.5 Mbit/s), full speed (12 Mbit/s), high speed (30 Mbit/s)
Current-carrying capacity	Max. 500 mA
Operating conditions	
EN 61131 pollution degree	Pollution degree 2
Protection per EN 60529	IP65 ¹⁾
UL 50 protection	Type 4X indoor ¹⁾
Mechanical characteristics	
Housing	
Material	Aluminum, coated
Coating	White aluminum (similar to RAL 9006)
Installation	Swing arm (with flange)
Dimensions	
Width	280 mm
Height	259 mm
Depth	96 mm
Weight	2500 g

Table 95: 5ACCMA00.0002-000 - Technical data

1) Only with proper installation on the panel and proper installation on the swing arm.

3.3.3.4 USB interface

The mounting unit is equipped with 2 USB 2.0 interfaces. They are equipped with a protective cover.

Caution!

IP65 protection can only be achieved if the USB protective cover is properly installed.

Warning!

Peripheral USB devices can be connected to the USB interfaces. Due to the large number of USB devices available on the market, B&R cannot guarantee their functionality. Functionality is ensured when using the USB devices available from B&R.

Caution!

Because this interface is designed according to general PC specifications, extreme care should be taken with regard to EMC, wiring, etc.

USB interface on mounting unit

The USB interfaces are available to the user for service purposes.

Information:

In the default configuration, the USB interfaces are the USB1 and USB2 interfaces on the link module.

Depending on the transfer method (SDL or DVI mode), the transfer rate of the USB1 and USB2 interfaces may be limited. For possible transfer methods, see section "Connection options" on page 22.

Transfer method	USB type	Max. cable length
SDL mode 1	USB 1.1	25 m
SDL mode 2	USB 2.0	5 m
DVI mode, single-touch	USB 2.0	5 m
DVI mode, multi-touch	USB 2.0	5 m
SDL3 mode	USB 2.0	100 m

Universal Serial Bus (USB on mounting unit) ¹⁾		
Type	USB 2.0	1x USB type A, female 
Design	Type A	
Transfer rate	Low speed (1.5 Mbit/s), full speed (12 Mbit/s), high speed (480 Mbit/s) ²⁾	
Current-carrying capacity ³⁾ Front USB	Max. 500 mA	
Cable length USB 2.0	<3 m (without hub)	

Table 96: USB interface

- 1) The interfaces, etc. available on the device or module have been numbered as such for the purpose of clear differentiation. This numbering may deviate from the numbering used by the respective operating system, however.
- 2) In SDL3 operation: Low speed (1.5 Mbit/s), full speed (12 Mbit/s), high speed (30 Mbit/s).
- 3) The USB interface is protected by a maintenance-free "USB current-limiting switch" (max. 500 mA).

3.3.4 5ACCMA01.0100-000

3.3.4.1 General information

The mounting unit is installed on the back of the panel. It protects the installed link module / system unit. The VESA bracket is installed on the mounting unit. If a VESA bracket is selected for mounting, VESA 100 or VESA 75 installation is possible.

- Protects the installed link module / system unit
- For installation with VESA bracket
- IP20 protection with 5AP5120.xxxx-000
- IP10 protection with 5AP5130.xxxx-000 and 5AP5230.xxxx-000

3.3.4.2 Order data

Model number	Short description	Figure
	Mounting units	
5ACCMA01.0100-000	AP5000 VESA mounting unit IP20	

Table 97: 5ACCMA01.0100-000 - Order data

3.3.4.3 Technical data

Information:

The following specifications, properties and limit values apply only to this individual component and may deviate from those that apply to the complete system. For the complete system in which this individual component is used, for example, the data specified for that complete system applies.

Model number	5ACCMA01.0100-000
General information	
Certification	
CE	Yes
UL	cULus E115267 Industrial control equipment
Operating conditions	
EN 61131 pollution degree	Pollution degree 2
Protection per EN 60529	IP10 ¹⁾
UL 50 protection	Type 1 ¹⁾
Mechanical characteristics	
Housing	
Material	Aluminum, coated
Coating	White aluminum (similar to RAL 9006)
Installation	VESA
Dimensions	
Width	270 mm
Height	189 mm
Depth	51 mm
Weight	900 g

Table 98: 5ACCMA01.0100-000 - Technical data

1) Only with proper installation on the panel.

3.4 Flange

3.4.1 5ACCFL00.0000-000

3.4.1.1 General information

The rotary flange is installed on the mounting unit and designed for swing arm systems with 48 mm shaft diameter. The range of rotation is -150° to $+150^{\circ}$.

- Rotary flange
- Range of rotation 150° to $+150^{\circ}$
- Stepless adjustment of range of rotation
- For swing arm systems with 48 mm shaft diameter

3.4.1.2 Order data

Model number	Short description	Figure
	Flange	
5ACCFL00.0000-000	AP5000 flange - Swing arm rotary flange - For swing arm mounting unit	

Table 99: 5ACCFL00.0000-000 - Order data

3.4.1.3 Technical data

Information:

The following specifications, properties and limit values apply only to this individual component and may deviate from those that apply to the complete system. For the complete system in which this individual component is used, for example, the data specified for that complete system applies.

Model number	5ACCFL00.0000-000
General information	
Certification	
CE	Yes
UL	cULus E115267 Industrial control equipment
Operating conditions	
EN 61131 pollution degree	Pollution degree 2
Mechanical characteristics	
Material	Coated aluminum (similar to RAL 9006)
Dimensions	
Height	55 mm
Diameter	75 mm (outer diameter) 48.5 mm (inner diameter)
Weight	530 g

Table 100: 5ACCFL00.0000-000 - Technical data

3.4.1.4 Dimensions

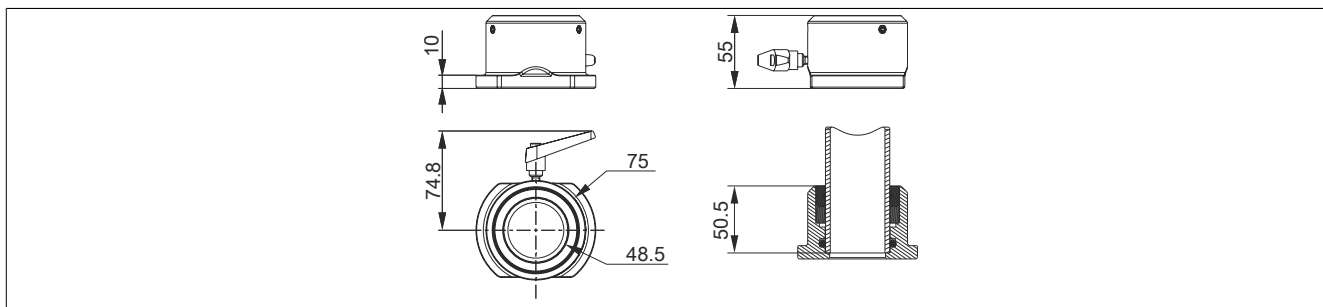

Figure 56: 5ACCFL00.0000-000 - Dimensions

3.4.2 5ACCFL00.0200-000

3.4.2.1 General information

The adapter is installed on the mounting unit and designed for the installation of Rittal coupling CP40 (steel).

- Adapter for Rittal coupling CP40 (steel)

Rittal coupling "CP 40" (steel, 90 x 71 mm) must be used for installation.

3.4.2.2 Order data

Model number	Short description	Figure
5ACCFL00.0200-000	AP5000 flange - Swing arm flange adapter - For Rittal - For swing arm mounting unit	

Table 101: 5ACCFL00.0200-000 - Order data

3.4.2.3 Technical data

Information:

The following specifications, properties and limit values apply only to this individual component and may deviate from those that apply to the complete system. For the complete system in which this individual component is used, for example, the data specified for that complete system applies.

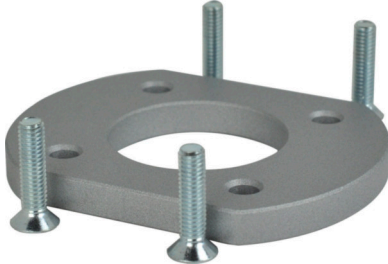
Model number	5ACCFL00.0200-000
General information	
Certification	
CE	Yes
UL	cULus E115267 Industrial control equipment
Operating conditions	
EN 61131 pollution degree	Pollution degree 2
Mechanical characteristics	
Material	Aluminum, coated
Dimensions	
Height	8.5 mm
Diameter	90 mm (outer diameter) 42 mm (inner diameter)
Weight	93 g

Table 102: 5ACCFL00.0200-000 - Technical data

3.4.2.4 Dimensions

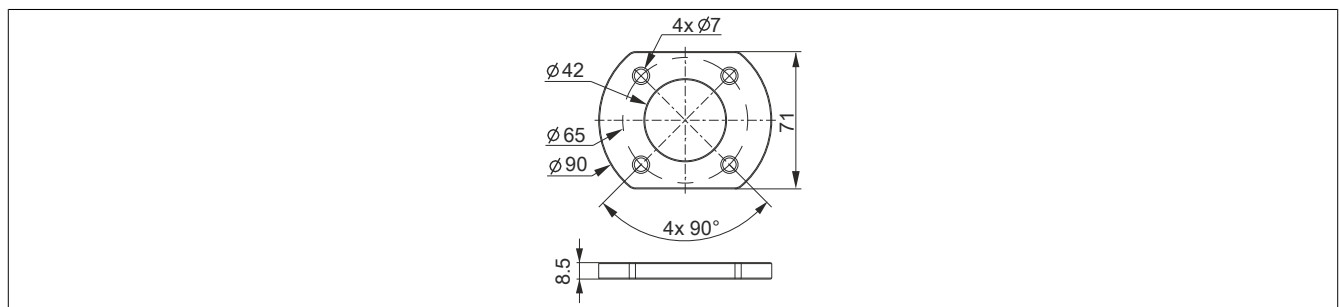

Figure 57: 5ACCFL00.0200-000 - Dimensions

3.5 Expansion units

For more information regarding expansion units and operating elements, see section "Equipping panels with expansion units" on page 62.

3.5.1 5ACCKP00.xxxx-000

3.5.1.1 General information

5ACCKP00.xxxx-000 expansion units are expansion covers that can be installed on the Automation Panel 5230. Depending on the variant, 7 to 14 cutouts are available to be equipped with operating elements.

For specifications regarding the operating and switching elements used by B&R, see section "Features" under "5ACCSE00.000x-00x" on page 207.

Information:

The maximum installation depth of operating and switching elements is 26 mm at the thinnest point and 30 mm at the thickest point.

3.5.1.2 Order data

Model number	Short description	Figure
Expansion units		
5ACCKP00.156B-000	AP5000 swing arm expansion option - Expansion cover - For switching elements - 10x cutouts for 22.3 mm switching elements - For panel 5AP5230.156B-000	
5ACCKP00.185B-000	AP5000 swing arm expansion option - Expansion cover - For switching elements - 11x cutouts for 22.3 mm switching elements - For panel 5AP5230.185B-000	
5ACCKP00.215C-000	AP5000 swing arm expansion option - Expansion cover - For switching elements - 13x cutouts for 22.3 mm switching elements - For panel 5AP5230.215C-000	
5ACCKP00.215I-000	AP5000 swing arm expansion option - Expansion cover - For switching elements - 7x cutouts for 22.3 mm switching elements - For panel 5AP5230.215I-000	
5ACCKP00.240C-000	AP5000 swing arm expansion option - Expansion cover - For switching elements - 14x cutouts for 22.3 mm switching elements - For panel 5AP5230.240C-000	
Optional accessories		
Operating elements		
5ACCSE00.0000-000	RAFIX 22 FS+ pushbutton - With 5 replaceable colored lenses - No color, red, green, blue, yellow - Normally open contact - Illuminated with white LED	
5ACCSE00.0000-001	RAFIX 22 FS+ Drucktaster - mit 5 tauschbaren Farbblenden - farblos, rot, grün, blau, gelb - Öffner Kontakt - beleuchtet mit weißer LED	
5ACCSE00.0001-000	RAFIX 22 FS emergency stop button	
5ACCSE00.0002-000	RAFIX 22 FS key switch 2x90°	
5ACCSE00.0003-000	RAFIX 22 FS key switch 1x90°	
5ACCSE00.0004-000	RAFIX 22 FS+ selector switch 1-90°	
5ACCSE00.0005-000	RAFIX FS 22+ USB IP65 400 mm	

Table 103: 5ACCKP00.156B-000, 5ACCKP00.185B-000, 5ACCKP00.215C-000, 5ACCKP00.215I-000, 5ACCKP00.240C-000 - Order data

3.5.1.3 Technical data

Information:

The following specifications, properties and limit values apply only to this individual component and may deviate from those that apply to the complete system. For the complete system in which this individual component is used, for example, the data specified for that complete system applies.

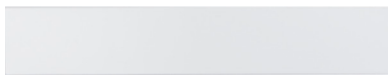
Model number	5ACCKP00.156B-000	5ACCKP00.185B-000	5ACCKP00.215C-000	5ACCKP00.215I-000	5ACCKP00.240C-000
General information					
Certification					
CE	Yes				
UL	cULus E115267 Industrial control equipment				

Table 104: 5ACCKP00.156B-000, 5ACCKP00.185B-000, 5ACCKP00.215C-000, 5ACCKP00.215I-000, 5ACCKP00.240C-000 - Technical data

Model number	5ACCKP00.156B-000	5ACCKP00.185B-000	5ACCKP00.215C-000	5ACCKP00.215I-000	5ACCKP00.240C-000
Features					
Optional operating elements					
Quantity	10	11	13	7	14
Operating conditions					
EN 61131 pollution degree	Pollution degree 2				
Mechanical characteristics					
Material	Steel sheet				
Weight	600 g	800 g	500 g	900 g	

Table 104: 5ACCKP00.156B-000, 5ACCKP00.185B-000, 5ACCK-
P00.215C-000, 5ACCKP00.215I-000, 5ACCKP00.240C-000 - Technical data

3.5.2 5ACCKP01.xxxx-000

3.5.2.1 General information

5ACCKP01.xxxx-000 expansion units are equipped with a wide range of operating elements as well as an interface (e.g. USB). They can be installed on the Automation Panel 5230.

- Expansion units
- Front USB interface
- Green and red pushbuttons
- Selector switch
- Key switch
- Emergency stop

3.5.2.2 Order data

Model number	Short description	Figure
	Expansion units	
5ACCKP01.156B-000	AP5000 swing arm expansion option - Expansion unit - 1x emergency stop - 2x pushbutton (red and green) - 1x selector switch - 1x key switch - 1x front USB interface - For panel 5AP5230.156B-000	
5ACCKP01.185B-000	AP5000 swing arm expansion option - Expansion unit - 1x emergency stop - 2x pushbutton (red and green) - 1x selector switch - 1x key switch - 1x front USB interface - For panel 5AP5230.185B-000	
5ACCKP01.215C-000	AP5000 swing arm expansion option - Expansion unit - 1x emergency stop - 2x pushbutton (red and green) - 1x selector switch - 1x key switch - 1x front USB interface - For panel 5AP5230.215C-000	
5ACCKP01.215I-000	AP5000 swing arm expansion option - Expansion unit - 1x emergency stop - 2x pushbutton (red and green) - 1x selector switch - 1x key switch - 1x front USB interface - For panel 5AP5230.215I-000	
5ACCKP01.240C-000	AP5000 swing arm expansion option - Expansion unit - 1x emergency stop - 2x pushbutton (red and green) - 1x selector switch - 1x key switch - 1x front USB interface - For panel 5AP5230.240C-000	

Table 105: 5ACCKP01.156B-000, 5ACCKP01.185B-000, 5ACCKP01.215C-000, 5ACCKP01.215I-000, 5ACCKP01.240C-000 - Order data

3.5.2.3 Technical data

Information:

The following specifications, properties and limit values apply only to this individual component and may deviate from those that apply to the complete system. For the complete system in which this individual component is used, for example, the data specified for that complete system applies.

Model number	5ACCKP01.156B-000	5ACCKP01.185B-000	5ACCKP01.215C-000	5ACCKP01.215I-000	5ACCKP01.240C-000
General information					
Certification					
CE	Yes				
Interfaces					
USB					
Quantity	1				
Type	USB 2.0				
Design	Type A				
Transfer rate	Low speed (1.5 Mbit/s), full speed (12 Mbit/s), high speed (480 Mbit/s)				
Current-carrying capacity	500 mA				
Features					
Pushbuttons					
Quantity	2 (green, red)				
Type	RAFIX 22 FS+, 1.30.270.021/2500 (green), 1.30.270.021/2300 (red)				
Contact element	Momentary				
Selector switch					
Quantity	1				
Type	RAFIX 22 FS+, 1.30.272.102/2200				
Contact element	Maintained				

Table 106: 5ACCKP01.156B-000, 5ACCKP01.185B-000, 5ACCKP01.215C-000, 5ACCKP01.215I-000, 5ACCKP01.240C-000 - Technical data

Model number	5ACCKP01.156B-000	5ACCKP01.185B-000	5ACCKP01.215C-000	5ACCKP01.215I-000	5ACCKP01.240C-000
Key switch					
Quantity	1				
Type	RAFIX 22 FS 1.30.255.222/0000				
Contact element	Maintained				
Emergency stop					
Quantity	1				
Type	RAFIX 22 FS+, Plus 1, 1.30.273.512/0300				
Contact element	Maintained				
Operating conditions					
EN 61131 pollution degree	Pollution degree 2				
Mechanical characteristics					
Material	Steel sheet				
Weight	800 g	900 g	1000 g	700 g	1100 g

Table 106: 5ACCKP01.156B-000, 5ACCKP01.185B-000, 5ACCKP01.215C-000, 5ACCKP01.215I-000, 5ACCKP01.240C-000 - Technical data

3.5.3 5ACCKP04.xxxx-000

3.5.3.1 General information

5ACCKP04.xxxx-000 expansion units are equipped with a wide range of operating elements as well as an interface (e.g. USB). They can be installed on the Automation Panel 5230.

- Expansion units
- Front USB interface
- Blue, green and red pushbuttons
- Key switch
- Emergency stop

3.5.3.2 Order data

Model number	Short description	Figure
	Expansion units	
5ACCKP04.156B-000	AP5000 swing arm expansion option - Expansion unit - 1x emergency stop - 3x pushbutton (red, green, blue) - 1x key switch - 1x front USB interface - For panel 5AP5230.156B-000	
5ACCKP04.185B-000	AP5000 swing arm expansion option - Expansion unit - 1x emergency stop - 3x pushbutton (red, green, blue) - 1x key switch - 1x front USB interface - For panel 5AP5230.185B-000	
5ACCKP04.215C-000	AP5000 swing arm expansion option - Expansion unit - 1x emergency stop - 3x pushbutton (red, green, blue) - 1x key switch - 1x front USB interface - For panel 5AP5230.215C-000	
5ACCKP04.215I-000	AP5000 swing arm expansion option - Expansion unit - 1x emergency stop - 3x pushbutton (red, green, blue) - 1x key switch - 1x front USB interface - For panel 5AP5230.215I-000	
5ACCKP04.240C-000	AP5000 swing arm expansion option - Expansion unit - 1x emergency stop - 3x pushbutton (red, green, blue) - 1x key switch - 1x front USB interface - For panel 5AP5230.240C-000	

Table 107: 5ACCKP04.156B-000, 5ACCKP04.185B-000, 5ACCKP04.215C-000, 5ACCKP04.215I-000, 5ACCKP04.240C-000 - Order data

3.5.3.3 Technical data

Information:

The following specifications, properties and limit values apply only to this individual component and may deviate from those that apply to the complete system. For the complete system in which this individual component is used, for example, the data specified for that complete system applies.

Model number	5ACCKP04.156B-000	5ACCKP04.185B-000	5ACCKP04.215C-000	5ACCKP04.215I-000	5ACCKP04.240C-000
General information					
Certification					
CE	Yes				
Interfaces					
USB					
Quantity	1				
Type	USB 2.0				
Design	Type A				
Transfer rate	Low speed (1.5 Mbit/s), full speed (12 Mbit/s), high speed (480 Mbit/s)				
Current-carrying capacity	500 mA				
Features					
Pushbuttons					
Quantity	3 (blue, green, red)				
Type	RAFIX 22 FS+, 1.30.270.021/2600 (blue), 1.30.270.021/2500 (green), 1.30.270.021/2300 (red)				
Contact element	Momentary				
Key switch					
Quantity	1				
Type	RAFIX 22 FS 1.30.255.222/0000				
Contact element	Maintained				
Emergency stop					
Quantity	1				
Type	RAFIX 22 FS+, Plus 1, 1.30.273.512/0300				
Contact element	Maintained				

Table 108: 5ACCKP04.156B-000, 5ACCKP04.185B-000, 5ACCKP04.215C-000, 5ACCKP04.215I-000, 5ACCKP04.240C-000 - Technical data

Model number	5ACCKP04.156B-000	5ACCKP04.185B-000	5ACCKP04.215C-000	5ACCKP04.215I-000	5ACCKP04.240C-000
Operating conditions					
EN 61131 pollution degree	Pollution degree 2				
Mechanical characteristics					
Material	Steel sheet				
Weight	800 g	900 g	1000 g	700 g	1100 g

Table 108: 5ACCKP04.156B-000, 5ACCKP04.185B-000, 5ACCK-
P04.215C-000, 5ACCKP04.215I-000, 5ACCKP04.240C-000 - Technical data

3.5.3.4 USB interface

The expansion unit is equipped with a USB 2.0 interface. This is equipped with a protective cover.

Caution!

IP65 protection can only be achieved if the USB protective cover is properly installed.

Warning!

Peripheral USB devices can be connected to the USB interfaces. Due to the large number of USB devices available on the market, B&R cannot guarantee their functionality. Functionality is ensured when using the USB devices available from B&R.

Caution!

Because this interface is designed according to general PC specifications, extreme care should be taken with regard to EMC, wiring, etc.

The USB interface is available to the user for service purposes.

Information:

In the default configuration, the USB interface takes up the USB1 interface on the link module, though this can vary depending on the defined configuration.

Depending on the transfer method (SDL or DVI mode), the transfer rate of the USB1 and USB2 interfaces may be limited. For possible transfer methods, see section "Connection options" on page 22.

Transfer method	USB type	Max. cable length
SDL mode 1	USB 1.1	25 m ¹⁾
SDL mode 2	USB 2.0	5 m
DVI mode, single-touch	USB 2.0	5 m
DVI mode, multi-touch	USB 2.0	5 m
SDL3 mode	USB 2.0	100 m

1) The max. cable length of 25 m depends on the resolution; see table "Cable lengths and resolutions for SDL transmission" on page 51 for exact specifications.

Universal Serial Bus (USB on expansion unit) ¹⁾	
Type	USB 2.0
Design	Type A
Transfer rate	Low speed (1.5 Mbit/s), full speed (12 Mbit/s), high speed (480 Mbit/s) ²⁾
Current-carrying capacity ³⁾ Front USB	Max. 500 mA
Cable length USB 2.0	<3 m (without hub)
	1x USB type A, female
	

Table 109: USB interface

- 1) The interfaces, etc. available on the device or module have been numbered as such for the purpose of clear differentiation. This numbering may deviate from the numbering used by the respective operating system, however.
- 2) In SDL3 operation: Low speed (1.5 Mbit/s), full speed (12 Mbit/s), high speed (30 Mbit/s).
- 3) The USB interface is protected by a maintenance-free "USB current-limiting switch" (max. 500 mA).

3.6 Handles

3.6.1 5ACCHD0x.xxxx-000

3.6.1.1 General information

Handles can be installed on the side of the panel to improve its ergonomic properties and ease of use.

Handles are not factory-installed and must be mounted after delivery. For information about installation, see section "Installing the handles" on page 144.

3.6.1.2 Order data

Model number	Short description	Figure
	Handles	
5ACCHD00.1505-000	AP5000 swing arm handles - For panel 5AP5120.1505-000	
5ACCHD00.156B-000	AP5000 swing arm handles - For panel 5AP5130.156B-000	
5ACCHD00.185B-000	AP5000 swing arm handles - For panel 5AP5130.185B-000	
5ACCHD00.1906-000	AP5000 swing arm handles - For panel 5AP5120.1906-000	
5ACCHD00.215C-000	AP5000 swing arm handles - For panel 5AP5130.215C-000	
5ACCHD00.240C-000	AP5000 swing arm handles - For panel 5AP5130.240C-000	
5ACCHD01.156B-000	AP5000 swing arm handles - For panel 5AP5230.156B-000	
5ACCHD01.185B-000	AP5000 swing arm handles - For panel 5AP5230.185B-000	
5ACCHD01.215C-000	AP5000 swing arm handles - For panel 5AP5230.215C-000	
5ACCHD01.215I-000	AP5000 swing arm handles - For panel 5AP5230.215I-000	
5ACCHD01.240C-000	AP5000 swing arm handles - For panel 5AP5230.240C-000	

Table 110: 5ACCHD00.1505-000, 5ACCHD00.156B-000, 5ACCHD00.185B-000, 5ACCHD00.1906-000, 5ACCHD00.215C-000, 5ACCHD00.240C-000, 5ACCHD01.156B-000, 5ACCHD01.185B-000, 5ACCHD01.215C-000, 5ACCHD01.215I-000, 5ACCHD01.240C-000 - Order data

3.6.1.3 Technical data

Information:

The following specifications, properties and limit values apply only to this individual component and may deviate from those that apply to the complete system. For the complete system in which this individual component is used, for example, the data specified for that complete system applies.

Model number	5ACCHD00.1505-000	5ACCHD00.156B-000	5ACCHD00.185B-000	5ACCHD00.1906-000	5ACCHD00.215C-000	5ACCHD00.240C-000
General information						
Certification	Yes					
CE						
UL	cULus E115267 Industrial control equipment					
Operating conditions						
EN 61131 pollution degree	Pollution degree 2					
Mechanical characteristics						
Material	Aluminum, coated					
Coating	White aluminum					
Dimensions						
Height	299 mm	269.5 mm	306 mm	372 mm	344 mm	375 mm
Weight	500 g	300 g	500 g	600 g		

Table 111: 5ACCHD00.1505-000, 5ACCHD00.156B-000, 5ACCHD00.185B-000, 5ACCHD00.1906-000, 5ACCHD00.215C-000, 5ACCHD00.240C-000 - Technical data

Model number	5ACCHD01.156B-000	5ACCHD01.185B-000	5ACCHD01.215C-000	5ACCHD01.215I-000	5ACCHD01.240C-000
General information					
Certification	Yes				
CE					
UL	cULus E115267 Industrial control equipment				
Operating conditions					
EN 61131 pollution degree	Pollution degree 2				
Mechanical characteristics					
Material	Aluminum, coated				

Table 112: 5ACCHD01.156B-000, 5ACCHD01.185B-000, 5ACCHD01.215C-000, 5ACCHD01.215I-000, 5ACCHD01.240C-000 - Technical data

Technical data • Individual components

Model number	5ACCHD01.156B-000	5ACCHD01.185B-000	5ACCHD01.215C-000	5ACCHD01.215I-000	5ACCHD01.240C-000
Coating	White aluminum				
Dimensions					
Height	349 mm	385.5 mm	423.5 mm	632 mm	454.5 mm
Weight	600 g	700 g		1000 g	800 g

Table 112: 5ACCHD01.156B-000, 5ACCHD01.185B-000, 5ACCHD01.215C-000, 5ACCHD01.215I-000, 5ACCHD01.240C-000 - Technical data

3.6.1.4 Content of delivery

- 2x handles
- 4x Torx screws (T20)

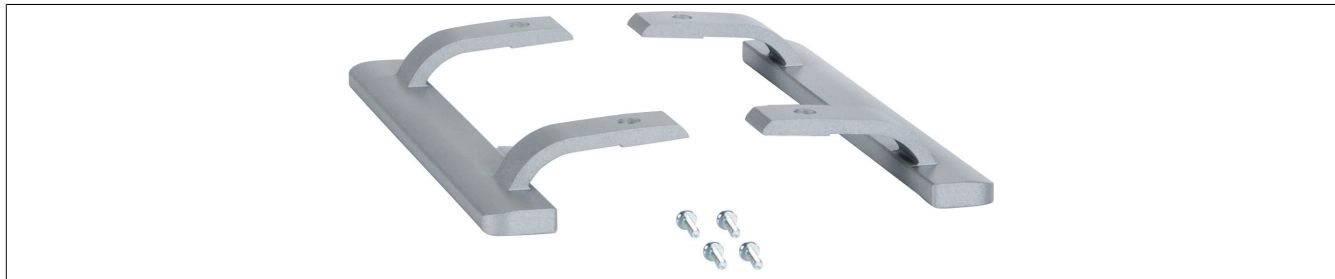

Figure 58: 5ACCHD0x.xxxx-000 - Content of delivery

Chapter 3 • Commissioning

1 Installation

Danger!

- All power supplies must be disconnected before removing device covers or components and installing/removing accessories, hardware or cables.
- The power cable must be disconnected from the device and from the power supply.
- All covers, components, accessories, hardware and cables must be installed or connected before the device can be connected to the power supply and switched on.

1.1 Important information concerning installation/commissioning

- Checking the delivery
 - When receiving the delivery, check the packaging for any visible transport damage.
 - Any visible transport damage must be documented and reported immediately, or the damage must be confirmed by the shipping/delivery company.
 - Keep the original packaging in the event that goods must be reshipped.

Information:

If a device is transported or stored without packaging, it is unprotected against all environmental factors such as impacts, vibration, pressure, moisture, etc. Damaged packaging indicates that environmental conditions have already heavily affected and possibly damaged the device.

This can result in malfunctions on the device, machine or manufacturing system.

- Check the packaging contents and any ordered optional accessories for completeness and damage.
- If the packaging contents are incomplete, damaged or do not match your order, inform your local sales office or B&R headquarters immediately.

Danger!

A damaged device is subject to unpredictable properties and states. The unintentional installation or operation of a damaged device must be prevented. The damaged device must be marked as such and removed from the productive environment or sent immediately for repairs.

- The environmental conditions must be observed, see "[Environmental characteristics](#)".

Caution!

Before the device is put into service, it must slowly be acclimated to room temperature! Subjecting it to thermal radiation is not permitted. If transported at low temperatures or if there are large temperature fluctuations, the device is not permitted to be subjected to any type of moisture. Moisture can cause short circuits in the electrical circuits and damages the device.

- You must observe the permissible mounting orientations when installing the device, see "[Mounting orientations](#)".

Caution!

When installed at an angle, the convection of air through the device is reduced, which decreases the maximum permissible ambient temperature for operation. If sufficient external cooling is present when the device is installed at an angle, the limit of the maximum permissible ambient temperature must be checked in each case. Otherwise, the device can become damaged and the certifications and warranty for the device nullified.

- The requirements for device standards and certifications must be observed - see "[Standards and certifications](#)".
- The device is only certified for operation in enclosed rooms.
- The device is not permitted to be subjected to direct sunlight.
- Ventilation holes are not permitted to be covered.
- The swing arm system must be able to hold four times the total weight of the device.

Caution!

In the event of insufficient load-carrying capacity of the installation surface, inadequate mounting or improper mounting materials, the device may fall and become damaged.

- The device is not permitted to be positioned next to other heat sources that could cause overheating.
- When connecting cables (DVI, SDL, USB, etc.), the bend radius must be taken into account.
- When connecting built-in or connected peripherals, the instructions in the documentation of the peripheral device must be followed.

Caution!

Built-in or connected peripherals (e.g. a USB drive) are not permitted to bring any voltage into the device. Energy regeneration is generally not permitted and can damage the device.

- The device must be installed in a position that minimizes glare on the screen.
- The device must be installed such that viewing is optimized for the user.
- Loss of seal

Caution!

- **The gasket must be inspected before initial installation, subsequent installation as well as at regular intervals appropriate to the requirements of the operating environment.**
- **Replace the entire device if visible scratches, cracks, collected dirt or excessive wear is detected during inspection.**
- **Do not unnecessarily stretch the gasket.**
- **Avoid contact between the gasket and the corners and edges of the frame.**
- **It is important to ensure that the gasket is completely inserted into the installation notch.**
- **The housing components must be secured using the specified tightening torque.**

Failure to follow these instructions can result in damage to property.

1.2 Automation Panel 5000 - Installation

The Automation Panel 5000 is installed on the swing arm system using a rotary flange.

1.2.1 Installation with flange

Information:

Before installing the Automation Panel on a swing arm system, ensure that the sealing ring is installed on the flange. In addition, only the flange has to be installed on the Automation Panel. For the defined procedure, see section "[Installing the 5ACCFL00.0000-000 rotary flange](#)" on page 136.

An outer diameter of 47.5 to 48.4 mm is permitted for the swing arm shaft. The end of the swing arm shaft that connects with the flange must be beveled at a 45° angle and deburred.

- The sealing ring must be placed in the groove of the compression ring. Slide the rotary swivel and compression ring onto the swing arm shaft and fasten them using the 3 M6 headless screws (hex recess, size 3) with a tightening torque of 5 Nm. Make sure that the rings are installed so that the rotary swivel (with catch) is inserted into the flange first. The orientation of the rotary swivel should be taken into account (see "[Feeding cables through the swing arm shaft](#)" on page 132). The distance from the bottom edge of the swing arm shaft and the bottom edge of the rotary swivel must be 21.5 mm \pm 0.5 mm (corresponds to a distance of 19 mm \pm 0.5 mm from the bottom edge of the swing arm shaft to the ring catch). Free space between the two rings is not permitted.

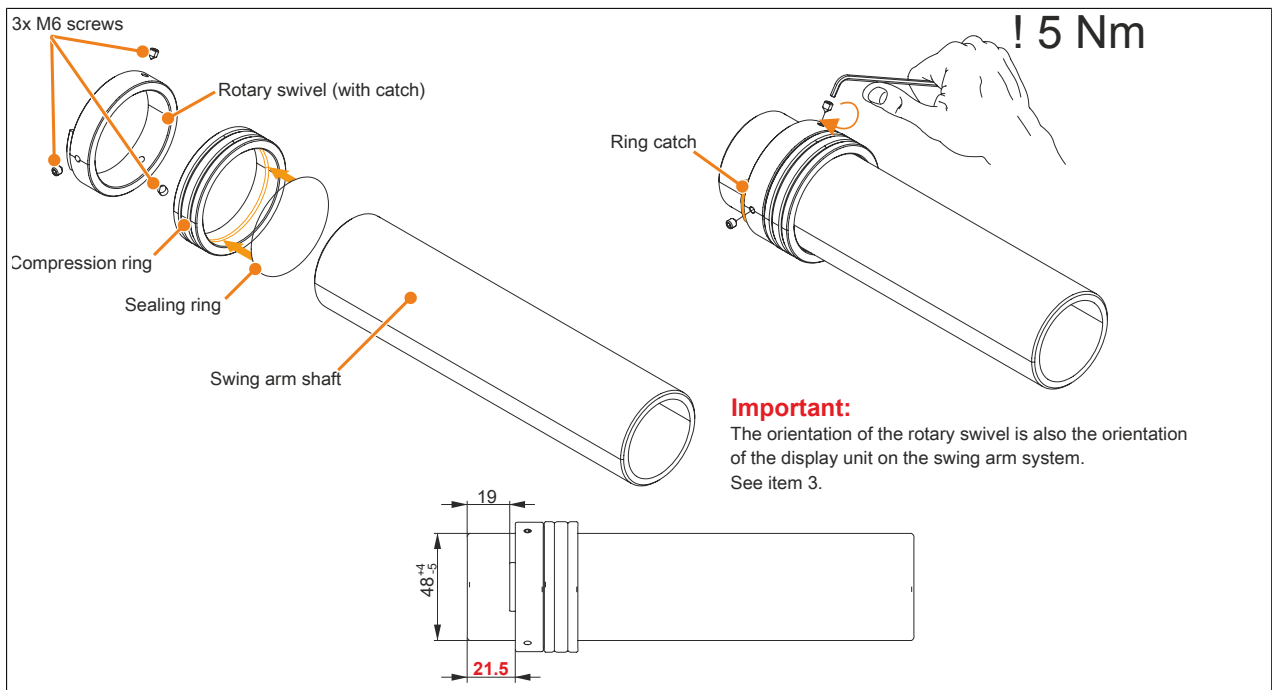

Figure 59: Installing the rings on the swing arm shaft

Warning!

The headless screws are equipped with a special screw locking mechanism and only designed to be used once. New headless screws must be used if removing and reinstalling.

Warning!

The distance between the bottom edge of the swing arm shaft and the bottom edge of the rotary swivel must be 21.5 mm \pm 0.5 mm. If this measurement is not observed, then the Automation Panel will not be sufficiently stable.

2. Feed the necessary cables through the swing arm shaft. The type of cables that must be used depends on the type of connection. For more information, see section "Connection options" on page 22.

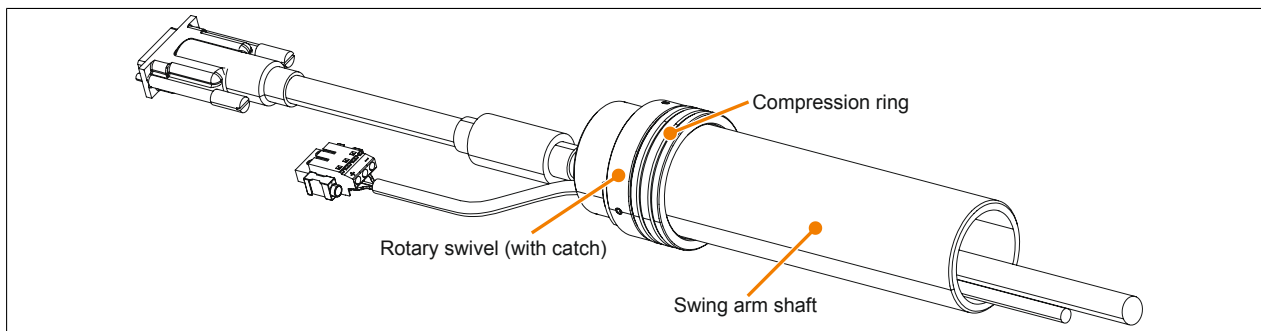

Figure 60: Feeding cables through the swing arm shaft

3. Connect the Automation Panel to the swing arm system. The rings must be installed in such a way that the ring catch of the rotary swivel points forward towards the panel. The Automation Panel has been installed correctly if the upper ring is flush with the flange. Fasten the assembly to the swing arm shaft using the 3 M6 headless screws (hex recess, size 3) with a tightening torque of 5 Nm.

Installation on a swing arm system is possible from the top or bottom depending on how the mounting unit is installed on the panel and the resulting position of the flange output.

Caution!

After the angle of rotation has been set, the adjustment lever must be locked into position (approx. 5 Nm).

The screw in the adjustment lever is not permitted to be tightened. Only the adjustment lever can be used to lock into position.

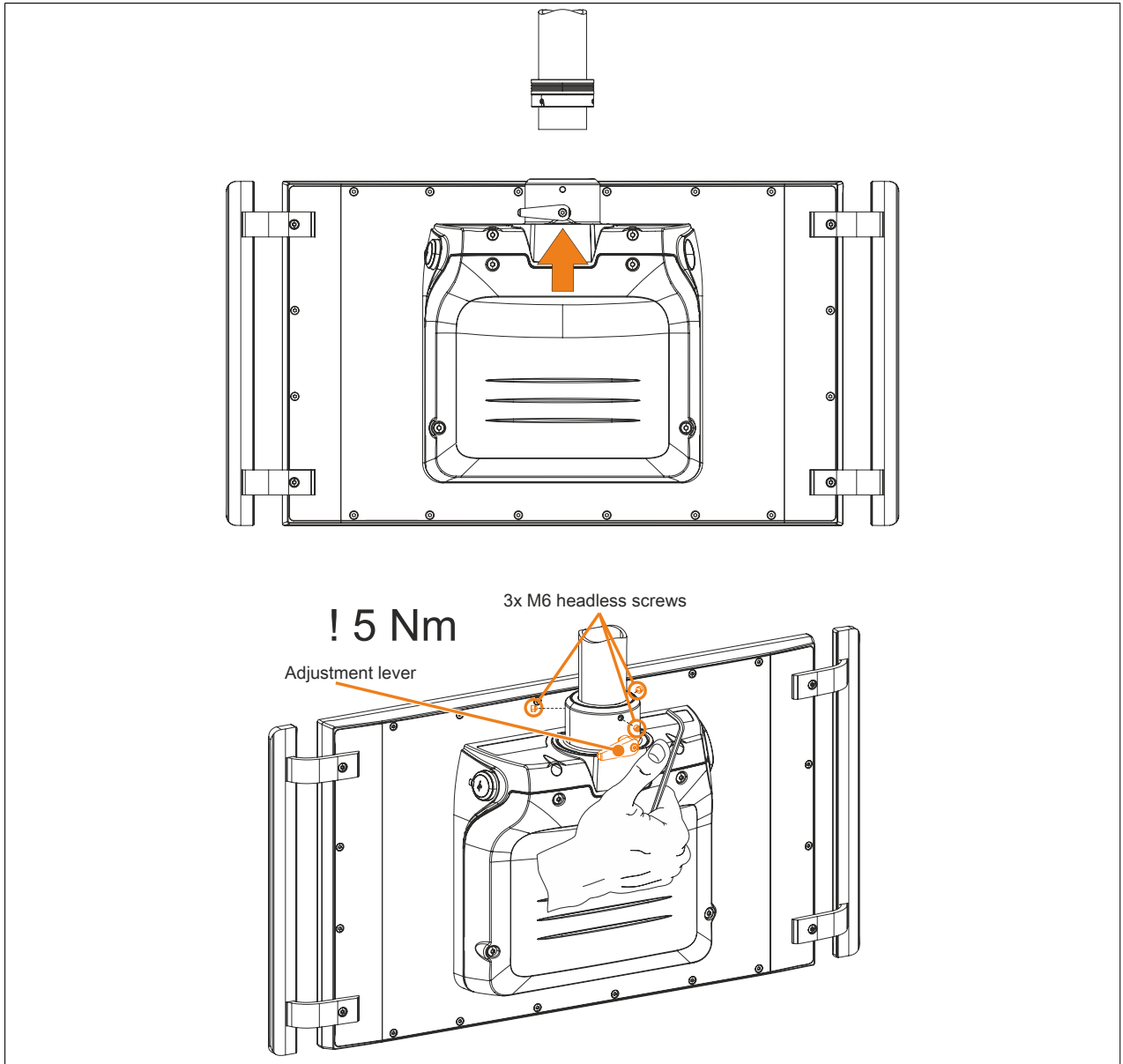

Figure 61: Installing the Automation Panel 5000

1.3 Removing the mounting unit cover

1. Disconnect the power supply to the Automation Panel (disconnect the power cable). Isolate the system from all potential sources of electrical power!
2. Discharge any electrostatic charge on the ground connection.
3. Remove the Torx screws (T25) indicated in the following image. Insert a flat-blade screwdriver into the slot from the side and remove the cover. Avoid causing irreparable damage to the gasket.

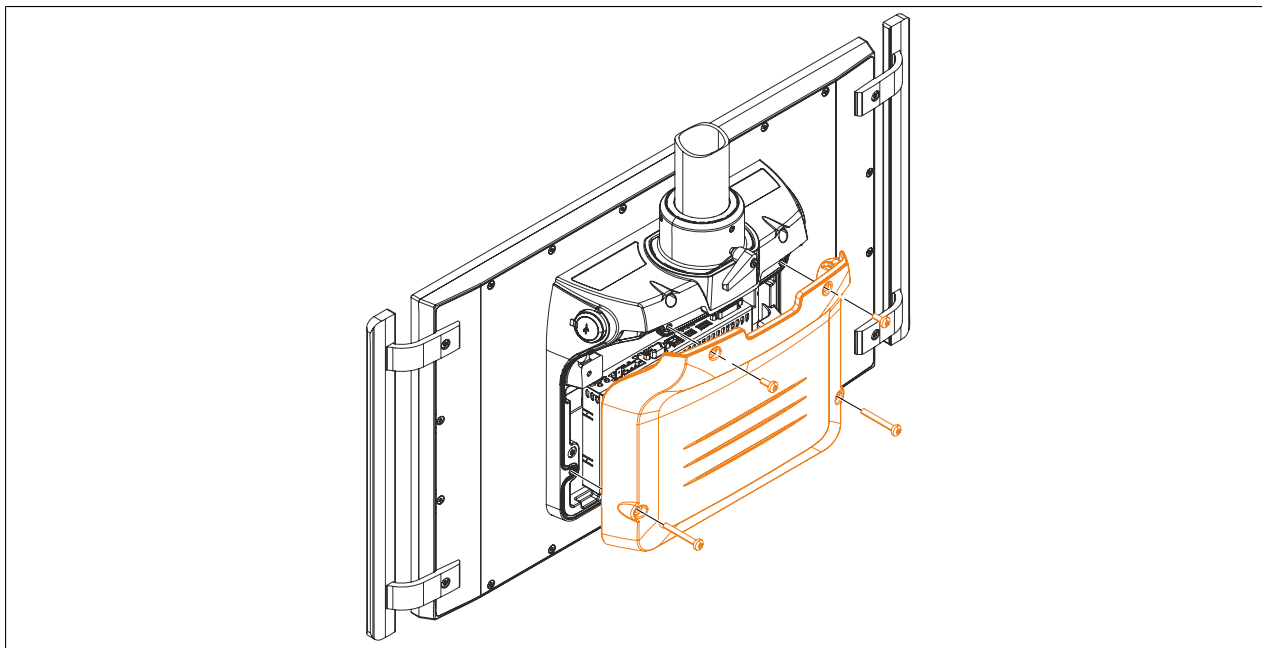

Figure 62: Removing the mounting unit cover

4. Replace the mounting unit cover with the 4 Torx screws removed earlier (tightening torque of the M5x12 screws: 3.5 Nm, for the M5x40 screws: 9.75 Nm). The cover must be installed correctly to ensure IP65 protection.

1.4 Removing the link module

The following requirements must be met:

- All connected cables must be disconnected.
 - The Automation Panel must no longer be installed on the swing arm system.
1. Disconnect the power supply to the Automation Panel (disconnect the power cable). Isolate the system from all potential sources of electrical power!
 2. Discharge any electrostatic charge on the ground connection.
 3. Place the Automation Panel on a clean, flat surface.
 4. Remove the Torx screws (T10) indicated in the following image.

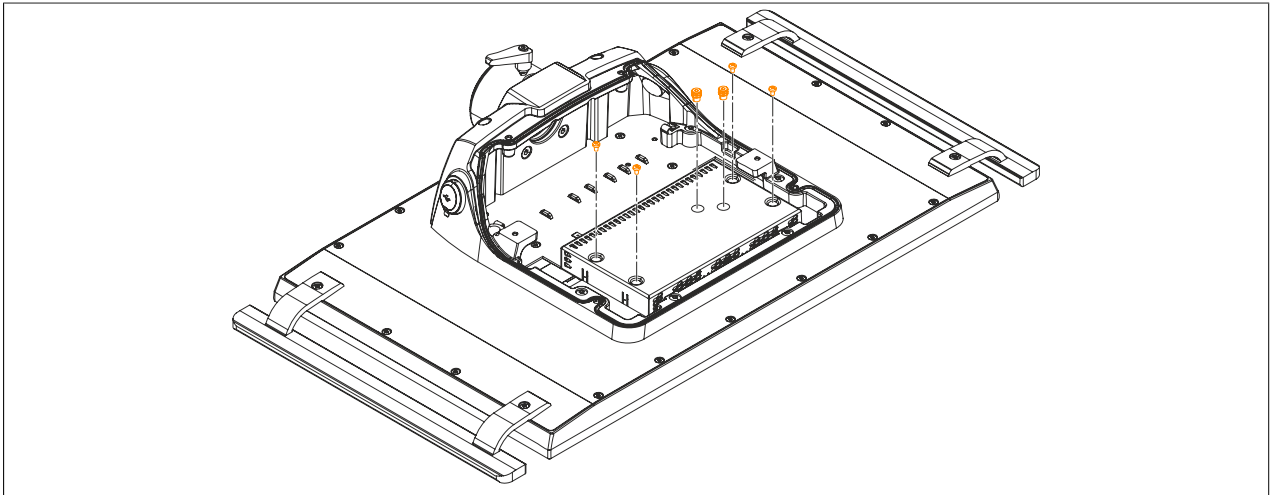

Figure 63: Removing the Torx screws

5. Pull firmly and evenly to remove the link module.

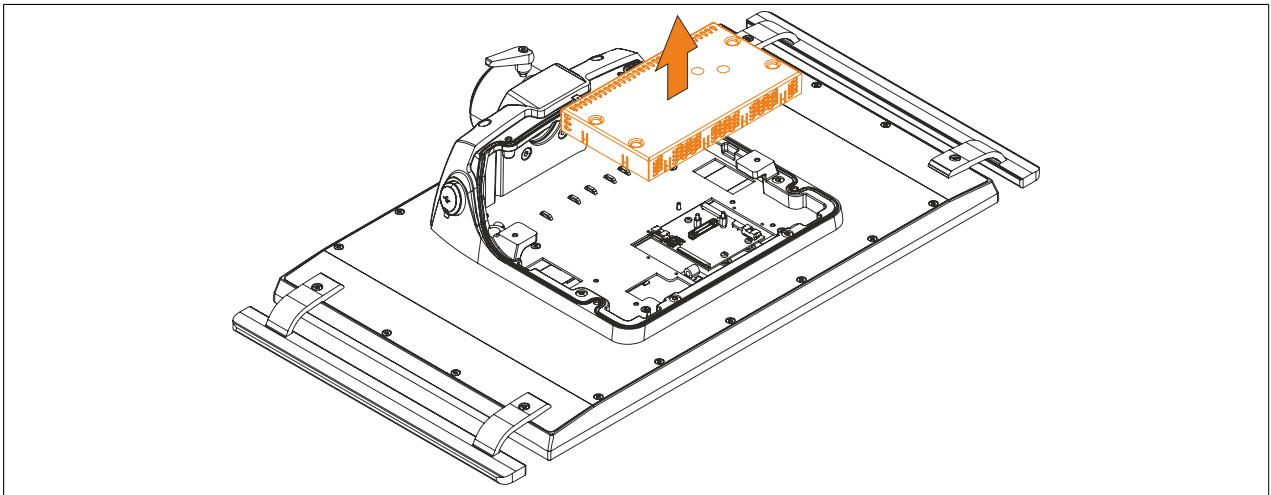

Figure 64: Removing the link module

6. The link module can now be replaced by following these steps in reverse order. The maximum tightening torque of the Torx screws (T10) is 0.5 Nm.

1.5 Installing the 5ACCFL00.0000-000 rotary flange

The following requirements must be met:

- All connected cables must be disconnected.
 - The Automation Panel must no longer be installed on the swing arm system.
1. Disconnect the power supply to the Automation Panel (disconnect the power cable). Isolate the system from all potential sources of electrical power!
 2. Discharge any electrostatic charge on the ground connection.
 3. Place the Automation Panel on a clean, flat surface.
 4. Remove the Torx screws (T25) indicated in the following image. Insert a flat-blade screwdriver into the slot from the side and remove the cover. Avoid causing irreparable damage to the gasket.

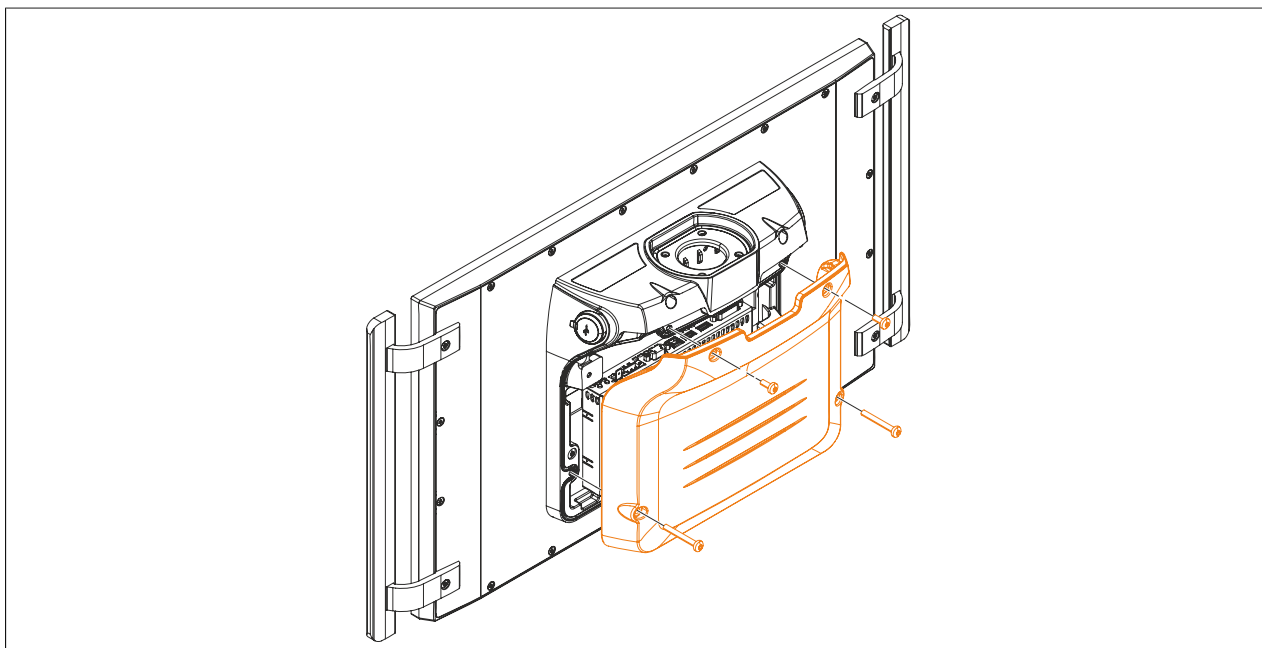

Figure 65: Removing the mounting unit cover

5. The link module must be removed before the rotary flange can be installed. To do so, perform the steps provided in section "[Removing the link module](#)" on page 135 in reverse order.
6. Check whether the sealing ring is inserted in the rotary flange. If the sealing ring is not installed in the rotary flange, it must be inserted into the sealing recess.

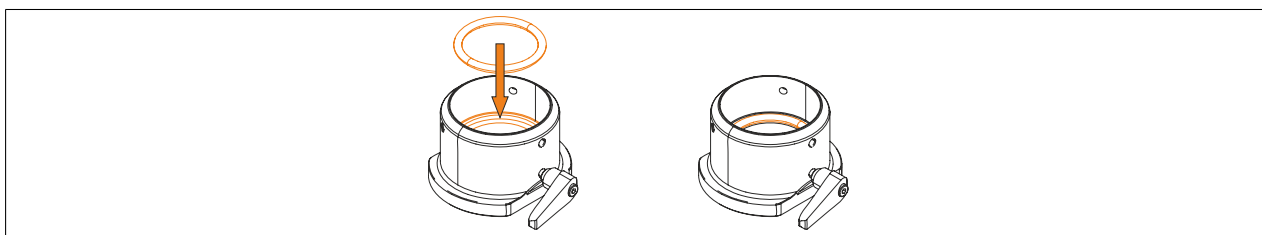

Figure 66: Inserting the sealing ring

- Place the rotary flange in the intended opening on the mounting unit with the adjustment lever pointing towards the mounting unit. Fasten it to the mounting unit using the 4 provided Torx screws (T30) with a tightening torque of 12 Nm.

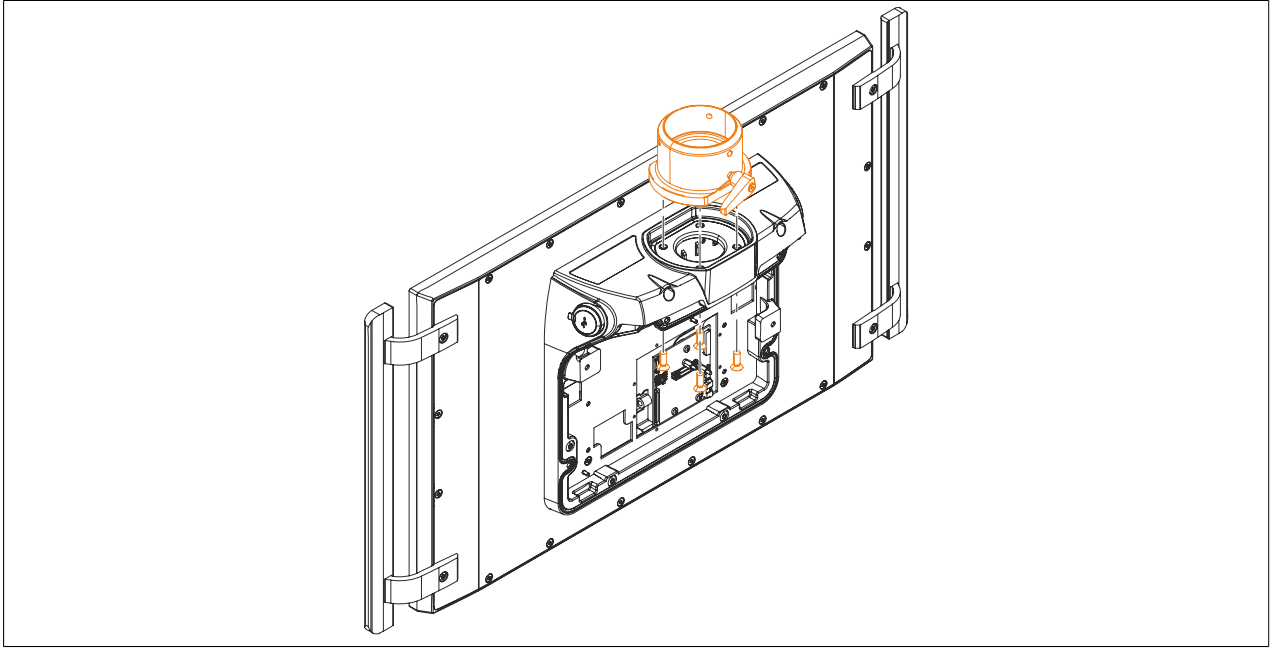

Figure 67: Mounting the flange

1.6 Removing the swing arm mounting unit

The mounting unit can be rotated 180°, which makes it possible to install on a swing arm system from above or below.

The following requirements must be met:

- All connected cables must be disconnected.
 - The Automation Panel must no longer be installed on the VESA or swing arm system.
1. Disconnect the power supply to the Automation Panel (disconnect the power cable). Isolate the system from all potential sources of electrical power!
 2. Discharge any electrostatic charge on the ground connection.
 3. Place the Automation Panel on a clean, flat surface.
 4. Remove the mounting unit cover by following the steps provided in section "[Removing the mounting unit cover](#)" on page 134.
 5. Remove the 8 Torx screws used to fasten the mounting unit to the Automation Panel (T25: 2x M5x65, 6x M5x12).

Caution!

Loss of seal

- **The gasket must be inspected before initial installation, subsequent installation as well as at regular intervals appropriate to the requirements of the operating environment.**
- **Replace the entire device if visible scratches, cracks, collected dirt or excessive wear is detected during inspection.**
- **Do not unnecessarily stretch the gasket.**
- **Avoid contact between the gasket and the corners and edges of the frame.**
- **It is important to ensure that the gasket is completely inserted into the installation notch.**
- **The housing components must be secured using the specified tightening torque.**

Failure to follow these instructions can result in damage to property.

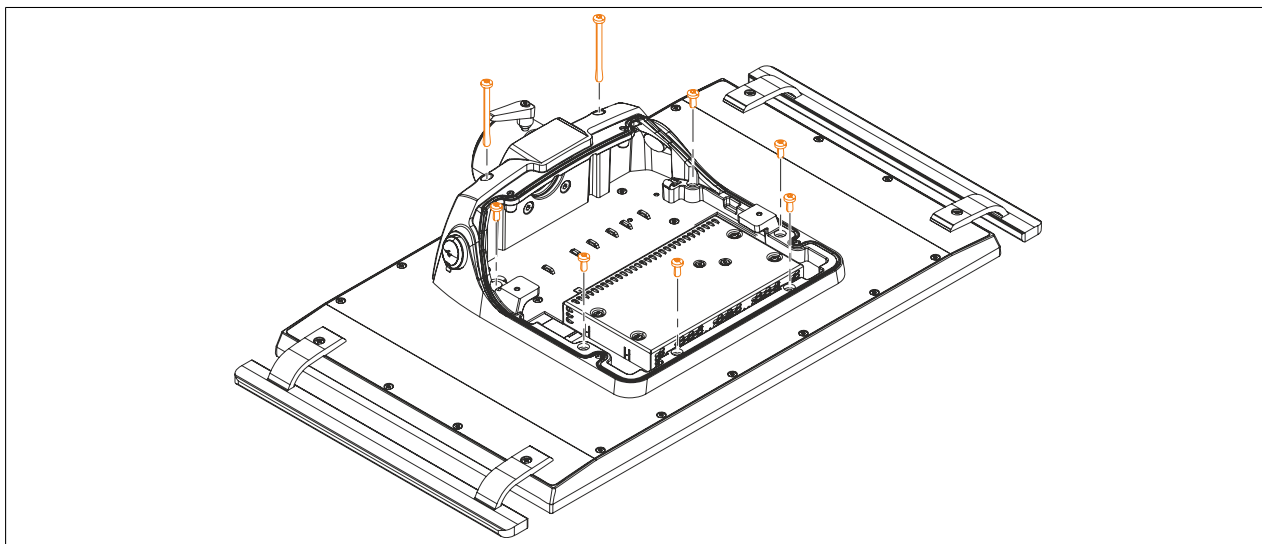

Figure 68: Removing the Torx screws

Warning!

The M5x65 screws are equipped with a special screw locking mechanism and only designed to be used once. New screws must be used if removing and reinstalling.

6. Pull evenly to remove the mounting unit from the panel.

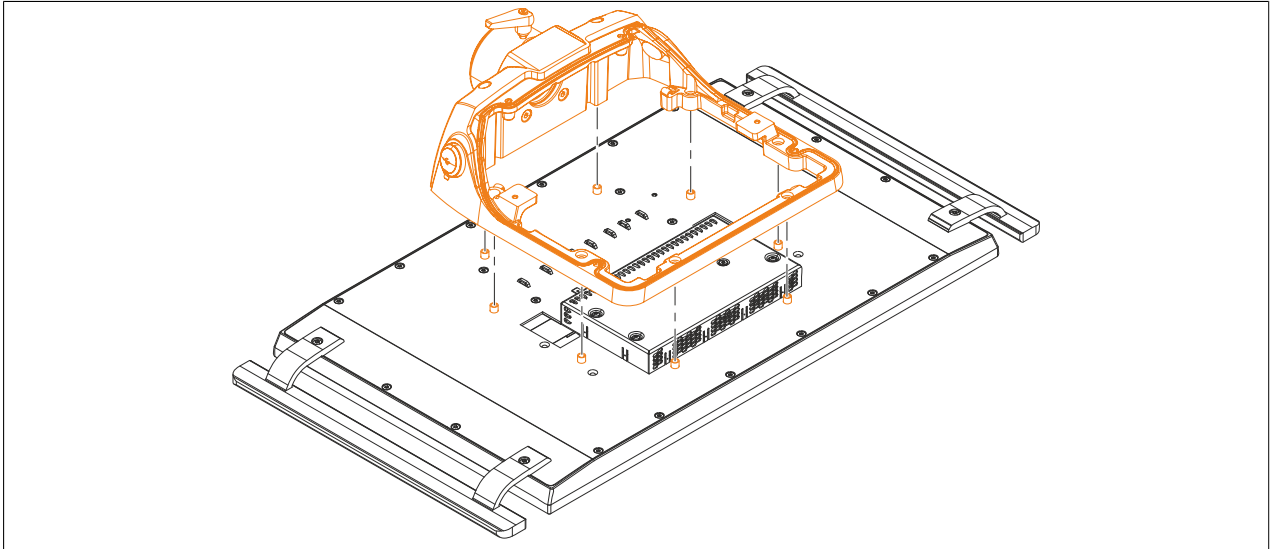

Figure 69: Removing/Installing the mounting unit on the panel

1.7 Installing the swing arm mounting unit

The mounting unit can be rotated 180°, which makes it possible to install on a swing arm system from above or below.

The following requirements must be met:

- All connected cables must be disconnected.
 - The Automation Panel must no longer be installed on the VESA or swing arm system.
1. Disconnect the power supply to the Automation Panel (disconnect the power cable). Isolate the system from all potential sources of electrical power!
 2. Discharge any electrostatic charge on the ground connection.
 3. Place the Automation Panel on a clean, flat surface.
 4. Place the mounting unit on the panel. The openings in the mounting unit must be lined up with the mounting pins on the panel.

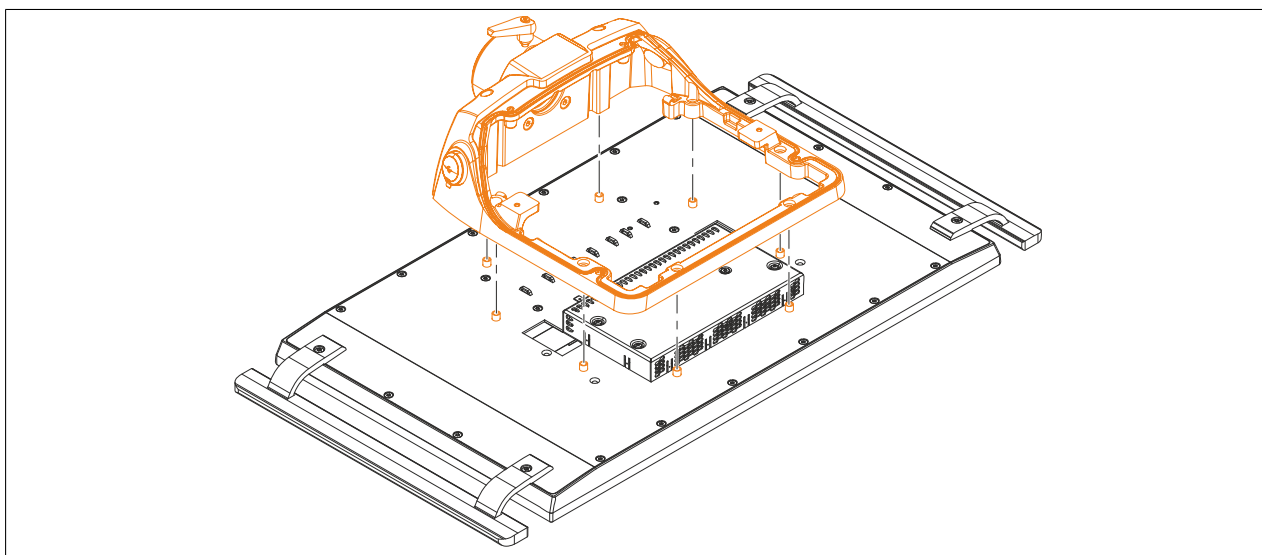

Figure 70: Place the mounting unit on the panel.

5. Install the mounting unit on the panel using the 8 provided Torx screws (T25: 2x M5x65, 6x M5x12). The tightening torque for each is 3.5 Nm.

Caution!

Loss of seal

- The gasket must be inspected before initial installation, subsequent installation as well as at regular intervals appropriate to the requirements of the operating environment.
- Replace the entire device if visible scratches, cracks, collected dirt or excessive wear is detected during inspection.
- Do not unnecessarily stretch the gasket.
- Avoid contact between the gasket and the corners and edges of the frame.
- It is important to ensure that the gasket is completely inserted into the installation notch.
- The housing components must be secured using the specified tightening torque.

Failure to follow these instructions can result in damage to property.

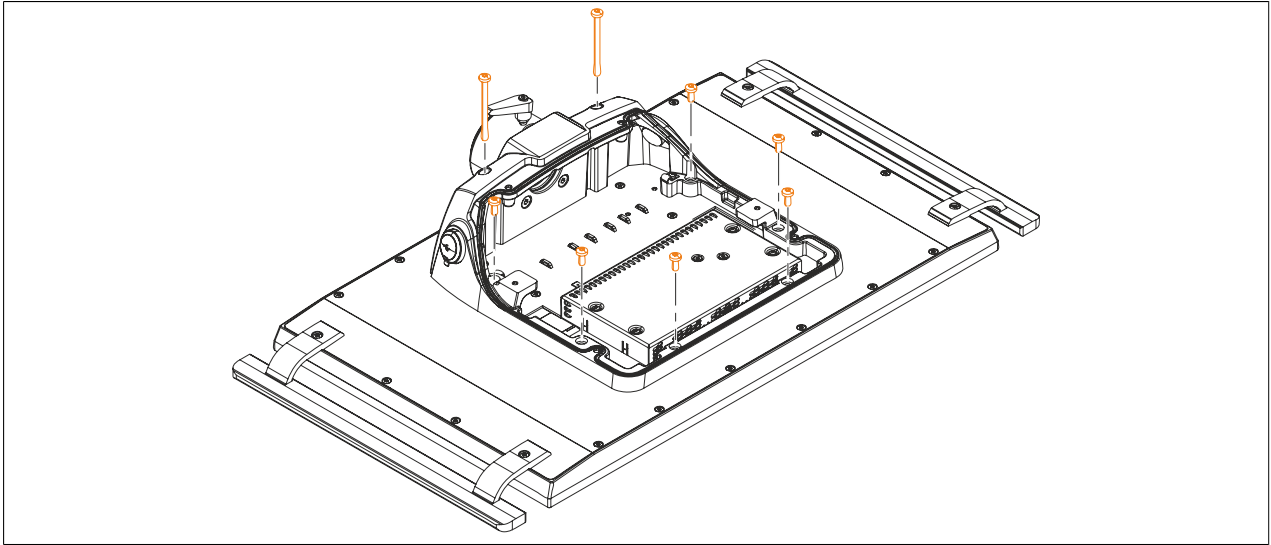

Figure 71: Tightening the Torx screws

Warning!

The M5x65 screws are equipped with a special screw locking mechanism and only designed to be used once. New screws must be used if removing and reinstalling.

6. Install the cover for the mounting unit by performing the steps provided in section "[Removing the mounting unit cover](#)" on page 134 in reverse order.

1.8 Removing the VESA mounting unit

The following requirements must be met:

- All connected cables must be disconnected.
 - The Automation Panel must no longer be installed on the VESA bracket.
1. Disconnect the power supply to the Automation Panel (disconnect the power cable). Isolate the system from all potential sources of electrical power!
 2. Discharge any electrostatic charge on the ground connection.
 3. Place the Automation Panel on a clean, flat surface.
 4. Remove the 4 Torx screws (T25: 4x M5x10) and 2 metal pieces (intended for cable strain relief) used to fasten the mounting unit to the Automation Panel.

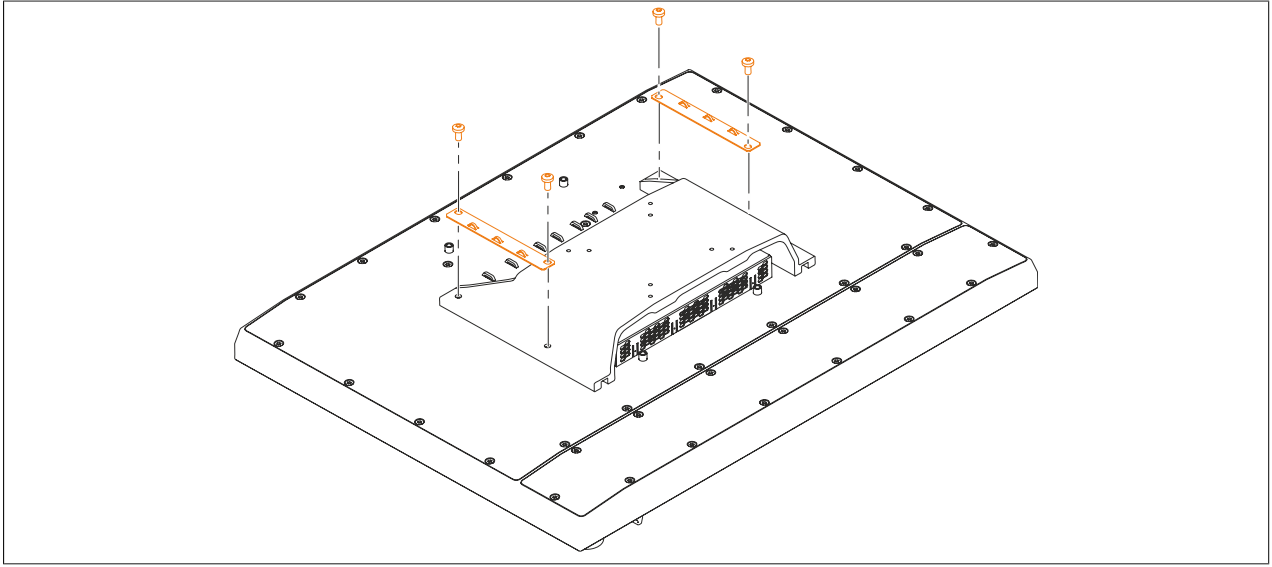

Figure 72: Removing the Torx screws

5. Pull evenly to remove the mounting unit from the panel.

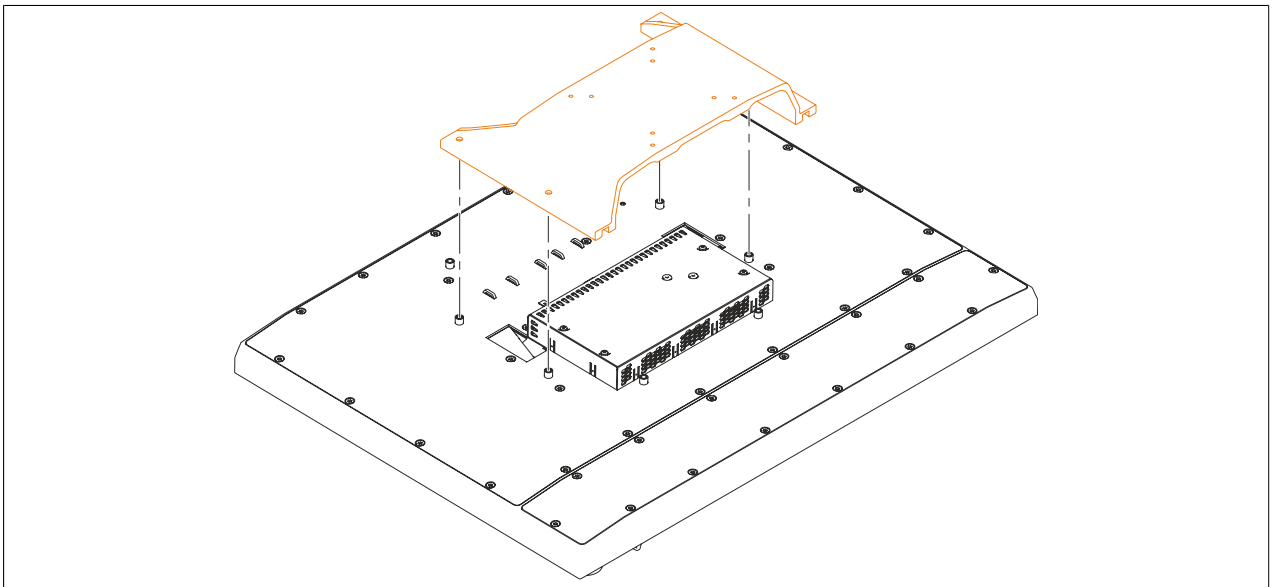

Figure 73: Removing/Installing the mounting unit on the panel

1.9 Installing the VESA mounting unit

The following requirements must be met:

- All connected cables must be disconnected.
 - The Automation Panel must no longer be installed on the VESA bracket.
1. Disconnect the power supply to the Automation Panel (disconnect the power cable). Isolate the system from all potential sources of electrical power!
 2. Discharge any electrostatic charge on the ground connection.
 3. Place the Automation Panel on a clean, flat surface.
 4. Place the mounting unit on the panel. The openings in the mounting unit must be lined up with the mounting pins on the panel.

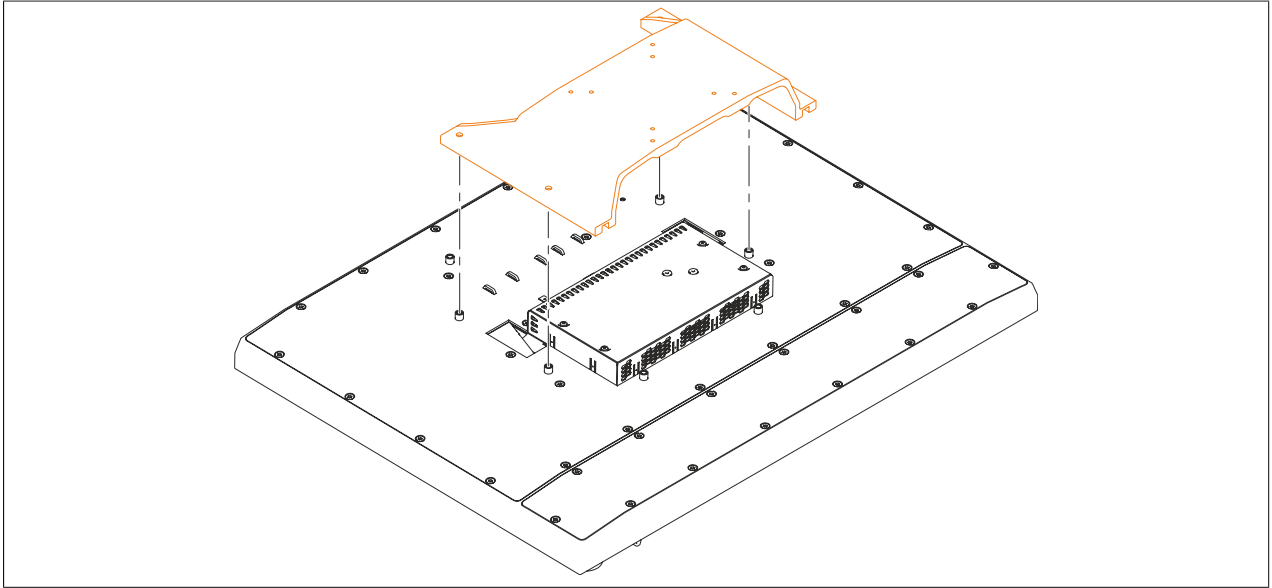

Figure 74: Place the mounting unit on the panel.

5. Install the mounting unit on the panel using the 4 provided Torx screws (T25: 4x M5x10) and 2 metal pieces (intended for cable strain relief). The tightening torque for each is 3.5 Nm. Follow the order shown in the following image.

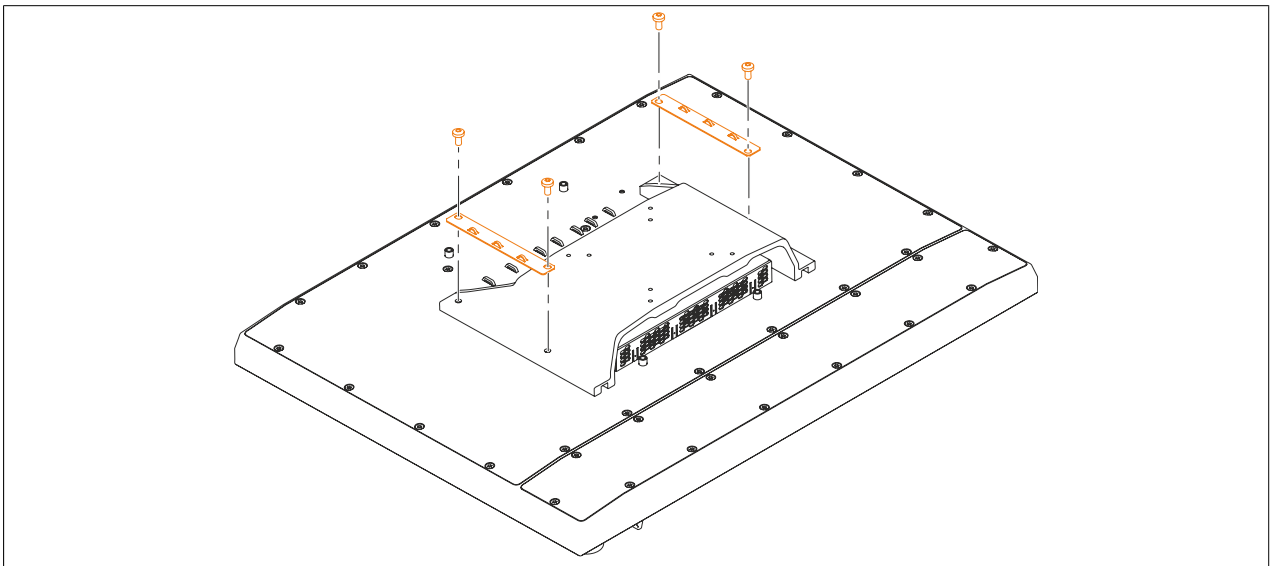

Figure 75: Tightening the Torx screws

6. 4 Torx screws (T20: 4x M4x10) and 6x cable ties are included in delivery for fastening the Automation Panel to a VESA bracket. Observe the installation notes from the manufacturer.

1.10 Installing the handles

The following requirements must be met:

- All connected cables must be disconnected.
 - The Automation Panel must no longer be installed on the VESA or swing arm system.
1. Disconnect the power supply to the Automation Panel (disconnect the power cable). Isolate the system from all potential sources of electrical power!
 2. Discharge any electrostatic charge on the ground connection.
 3. Place the Automation Panel on a clean, flat surface.
 4. Remove the top and bottom Torx screws (T20) on the side of the panel.

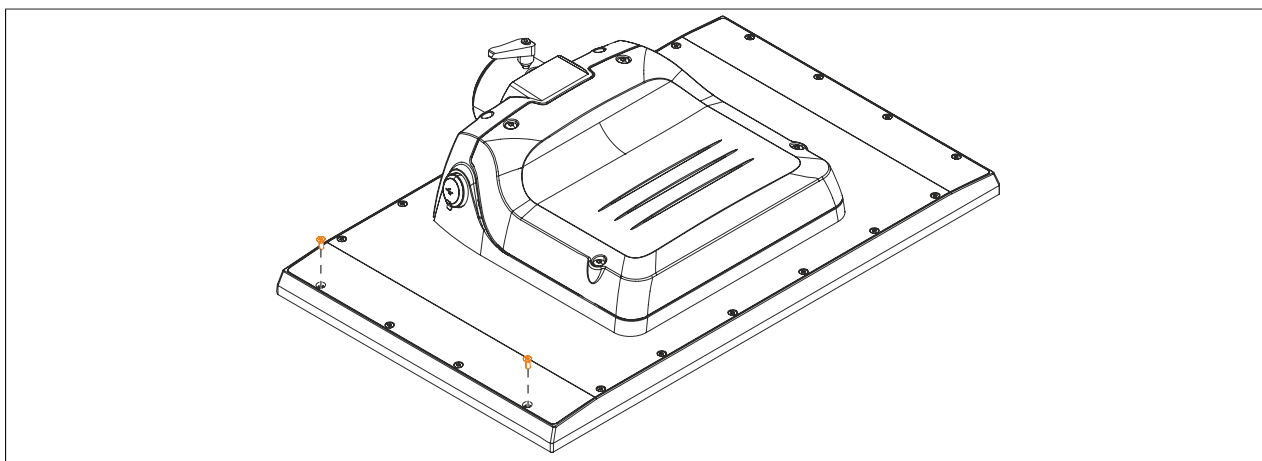

Figure 76: Removing the Torx screws

5. Insert the provided Torx screws (T20) through the handle and tighten with max. tightening torque of 1.24 Nm.

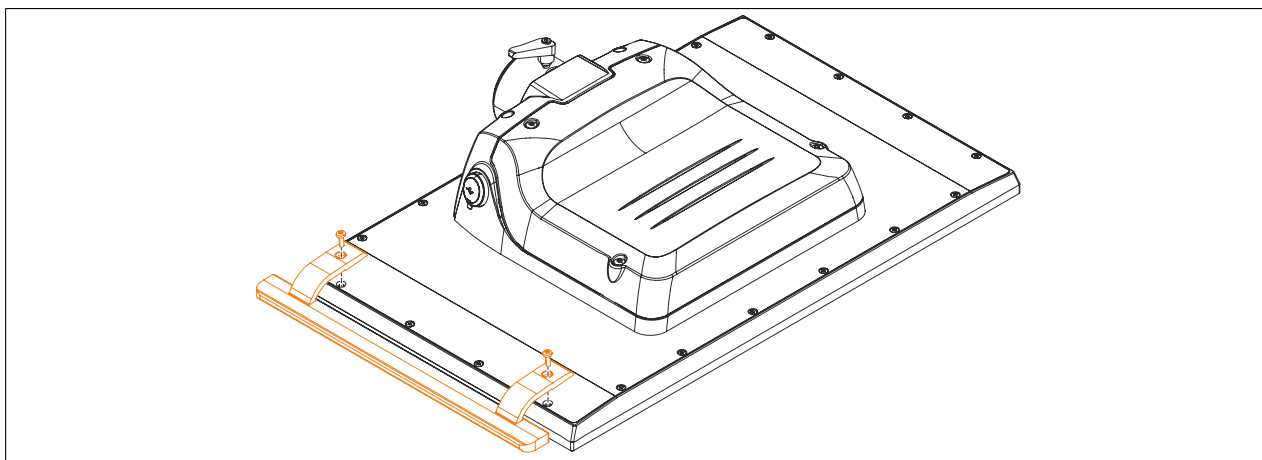

Figure 77: Installing the handles

1.11 Removing the expansion unit / expansion cover

The following requirements must be met:

- All connected cables must be disconnected.
 - The Automation Panel must no longer be installed on the VESA or swing arm system.
1. Disconnect the power supply to the Automation Panel (disconnect the power cable). Isolate the system from all potential sources of electrical power!
 2. Discharge any electrostatic charge on the ground connection.
 3. Place the Automation Panel on a clean, flat surface.
 4. Remove the back cover of the panel by removing the 14 Torx screws (T20).

Caution!

Loss of seal

- The gasket must be inspected before initial installation, subsequent installation as well as at regular intervals appropriate to the requirements of the operating environment.
- Replace the entire device if visible scratches, cracks, collected dirt or excessive wear is detected during inspection.
- Do not unnecessarily stretch the gasket.
- Avoid contact between the gasket and the corners and edges of the frame.
- It is important to ensure that the gasket is completely inserted into the installation notch.
- The housing components must be secured using the specified tightening torque.

Failure to follow these instructions can result in damage to property.

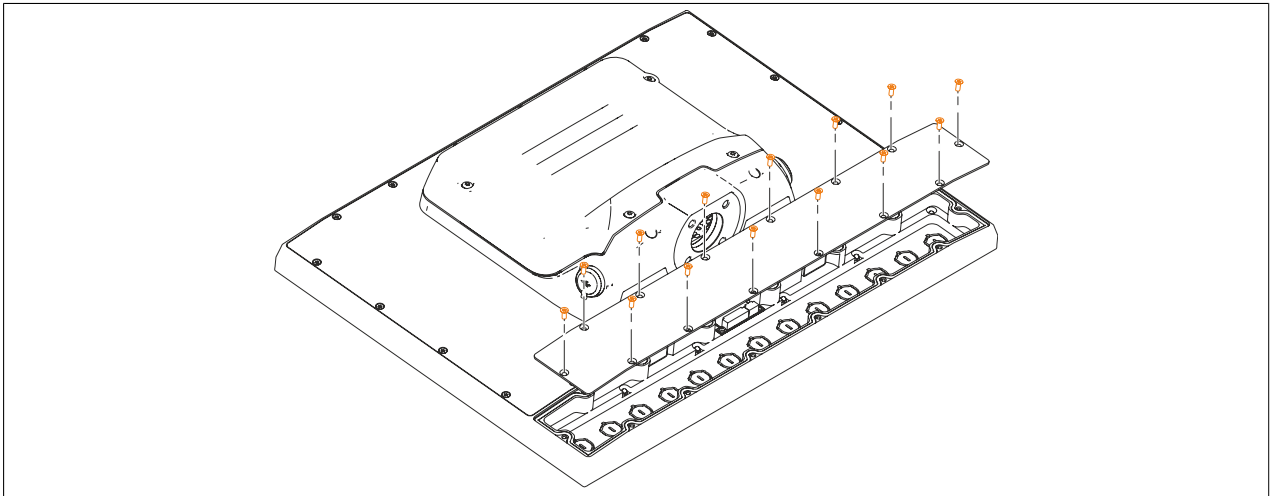

Figure 78: Removing the back cover

5. If an expansion unit is installed, the cables for the circuit board and front USB interface must be disconnected from the panel's circuit board.

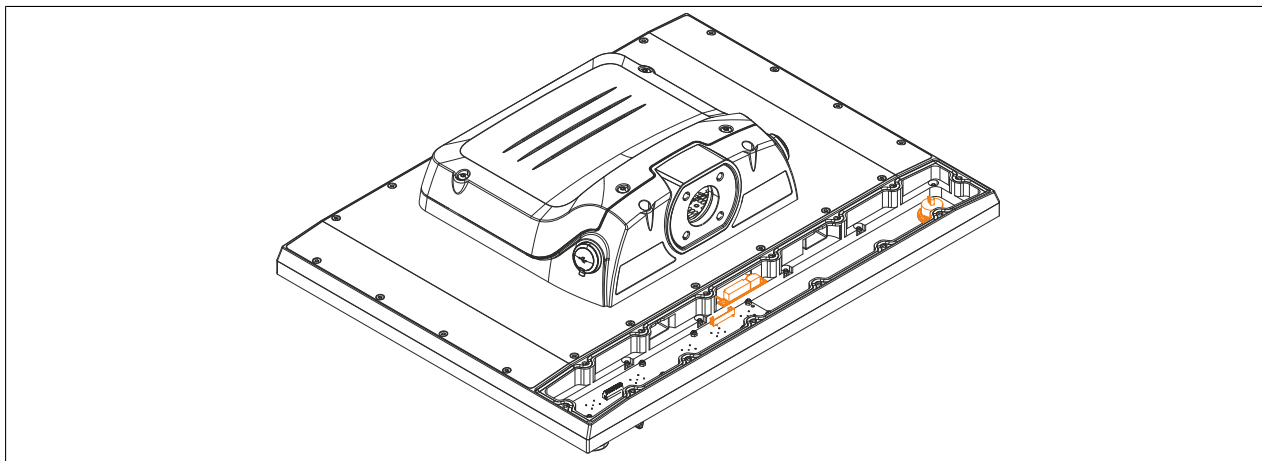

Figure 79: Disconnecting the cables for the expansion unit

6. Remove the 12 nuts (M3) indicated in the following image and remove the expansion unit / expansion cover from the panel.

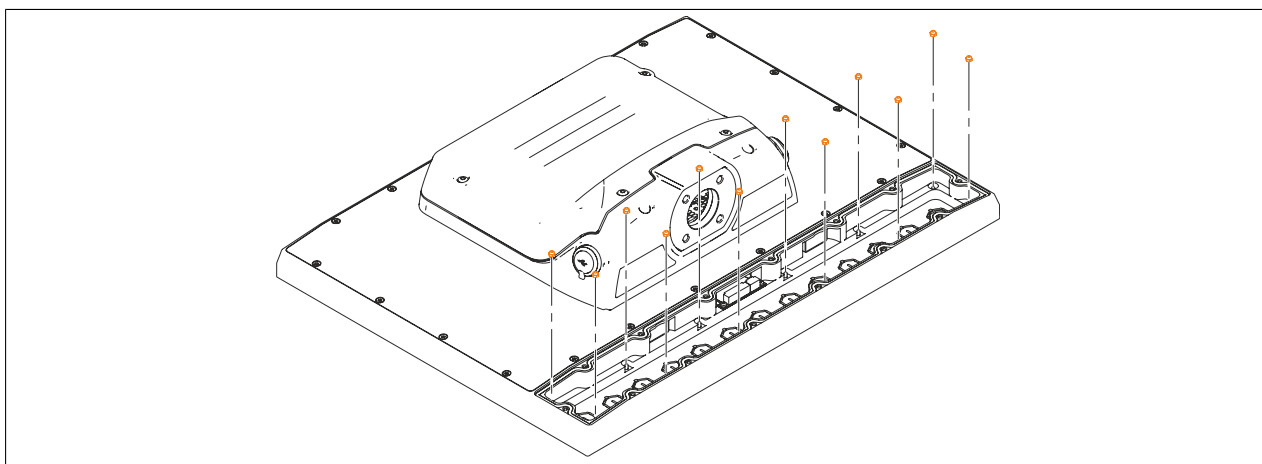

Figure 80: Removing the nuts

1.12 Installing the expansion unit / expansion cover

The following requirements must be met:

- All connected cables must be disconnected.
 - The Automation Panel must no longer be installed on the VESA or swing arm system.
1. Disconnect the power supply to the Automation Panel (disconnect the power cable). Isolate the system from all potential sources of electrical power!
 2. Discharge any electrostatic charge on the ground connection.
 3. Place the Automation Panel on a clean, flat surface.
 4. Insert the front of the expansion unit / expansion cover into the panel. Secure to the back with the 12 nuts (M3). The tightening torque for each is 0.55 Nm.
 5. Connect the cables for the circuit board and front USB interface to the terminal strips on the panel's circuit board.

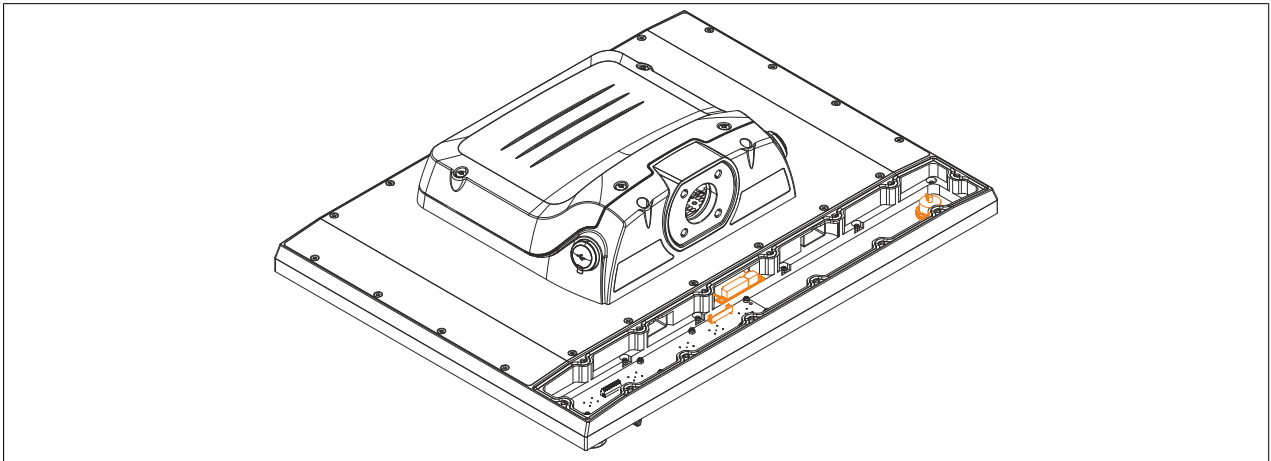

Figure 81: Connecting the cables for the expansion unit to the panel's circuit board

6. If necessary, wire the operating elements.
 - For information about wiring operating elements on the expansion unit, see section "[Button/Switch interface](#)" on page 66.
 - For information about wiring or installing operating elements on the expansion cover, see section "[Installing operating elements on the expansion cover](#)" on page 148.
7. Install the back cover with the 14 Torx screws (T20). The tightening torque for each is 2.3 Nm.

Caution!

Loss of seal

- The gasket must be inspected before initial installation, subsequent installation as well as at regular intervals appropriate to the requirements of the operating environment.
- Replace the entire device if visible scratches, cracks, collected dirt or excessive wear is detected during inspection.
- Do not unnecessarily stretch the gasket.
- Avoid contact between the gasket and the corners and edges of the frame.
- It is important to ensure that the gasket is completely inserted into the installation notch.
- The housing components must be secured using the specified tightening torque.

Failure to follow these instructions can result in damage to property.

1.13 Installing operating elements on the expansion cover

The following requirements must be met:

- All connected cables must be disconnected.
- The Automation Panel must no longer be installed on the VESA or swing arm system.

B&R recommends the following operating elements for proper installation and operation:

- RAFIX 22 FS series
- RAFIX 22 FS+ series
- SHORTRON series

The corresponding manufacturer specifications must be observed when installing operating elements.

1. Disconnect the power supply to the Automation Panel (disconnect the power cable). Isolate the system from all potential sources of electrical power!
2. Discharge any electrostatic charge on the ground connection.
3. Place the Automation Panel on a clean, flat surface.
4. If an expansion unit is installed, it must first be removed. To do so, follow the instructions in section "[Removing the expansion unit / expansion cover](#)" on page 145.
5. If an expansion unit is not installed, then one needs to be installed. To do so, follow the instructions in section "[Installing the expansion unit / expansion cover](#)" on page 147.

Information:

The following steps can only be performed after an expansion cover has been installed in the Automation Panel 5000.

6. Cut through the panel overlay from the inside with a sharp object (e.g. scalpel) along the outer edges of the 3 curved cutout areas.



Figure 82: Cut the panel overlay along the cutout areas

7. Carefully cut the panel overlay at the notch for the anti-twist lock.

- Cut through the panel overlay along the outer edges of the middle cutout with a scalpel.

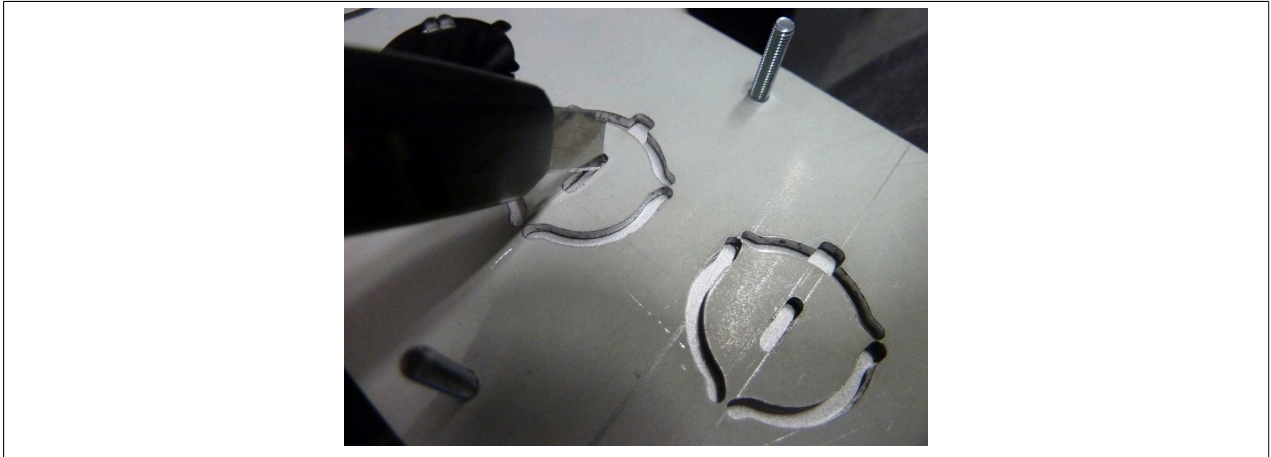

Figure 83: Cutting two parallel slits

- Push through the cutout for the operating element with a flat-blade screwdriver.

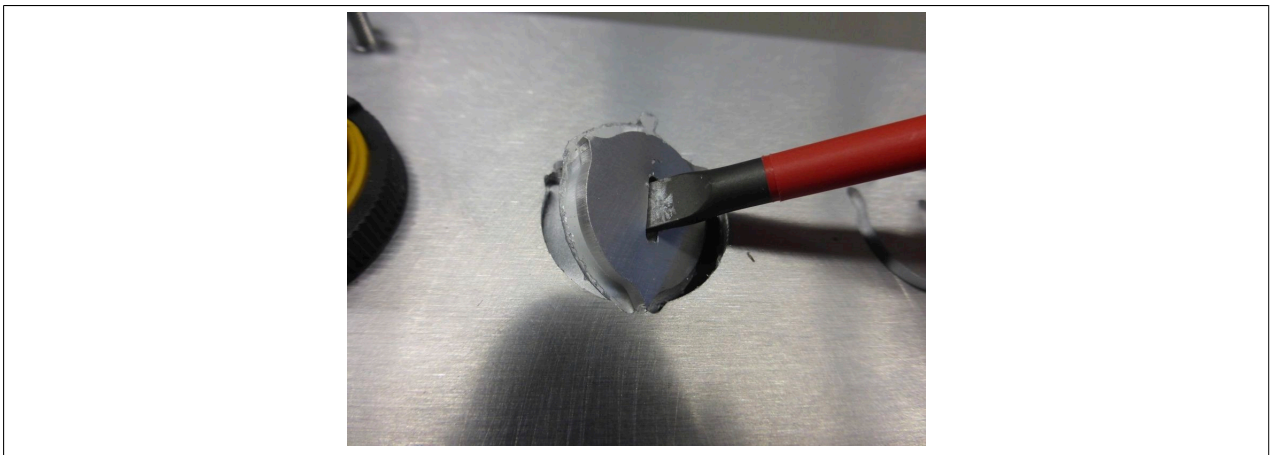

Figure 84: Breaking through the cutout for the operating element from the inside

- Cut the panel overlay so that it is flush with the edge of the steel plate.

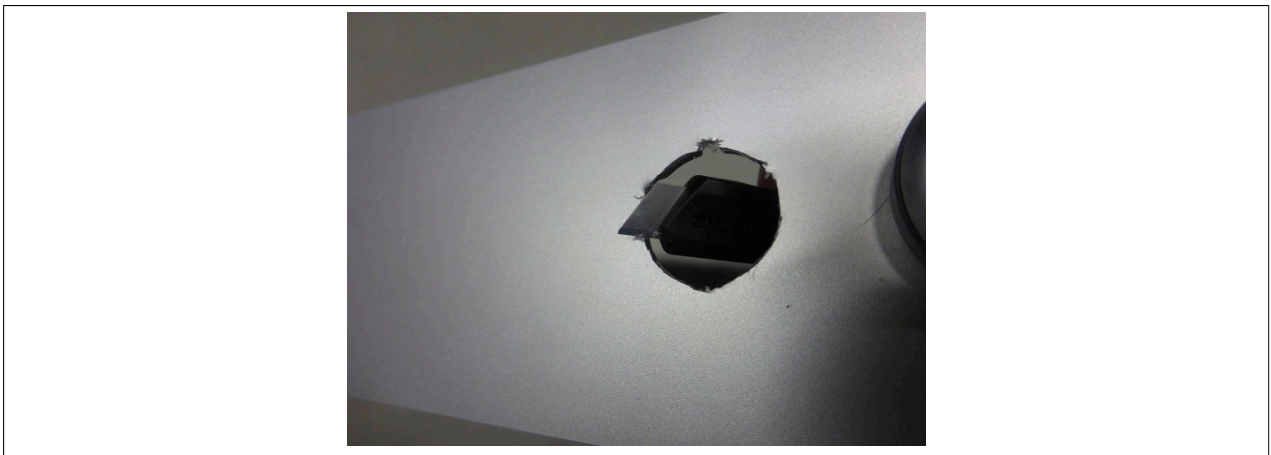

Figure 85: Cutting the panel overlay so it is flush

- Operating elements can now be installed on the expansion cover.

For specifications regarding the operating and switching elements used by B&R, see section ["Features" on page 204](#).

1.14 Replacing colored lenses

1. Place the colored lens on the operating element. Press the notches on the colored lens into the 4 large openings of the pushbutton.



2. If required, the colored lens can be removed using a sharp object.

Refer to the manufacturer guidelines for additional information about installing operating elements.

2 Connecting to the power grid

Danger!

- All power supplies must be disconnected before removing device covers or components and installing/removing accessories, hardware or cables.
- The power cable must be disconnected from the device and from the power supply.
- All covers, components, accessories, hardware and cables must be installed or connected before the device can be connected to the power supply and switched on.

2.1 Installing the DC power cable

Danger!

All power supplies to the B&R industrial PC and B&R Automation Panel must be interrupted. Before connecting the DC power cable, it is necessary to check whether it has been disconnected from the power source (e.g. power supply).

2.1.1 Wiring

The DC power cable must be installed in the terminal block (power supply connector) as shown in the image below. Wires with a cross section of 0.75 mm² to 1.5 mm² and wire end sleeves must be used.

Installing screw clamp terminal block 0TB103.9

Fasten the wires with wire end sleeves into the terminal contacts ② as shown in the image below and tighten the screw clamp terminals ① with a screwdriver (max. tightening torque 0.4 Nm).

Observe the pinout of the power supply connection on the device during wiring!

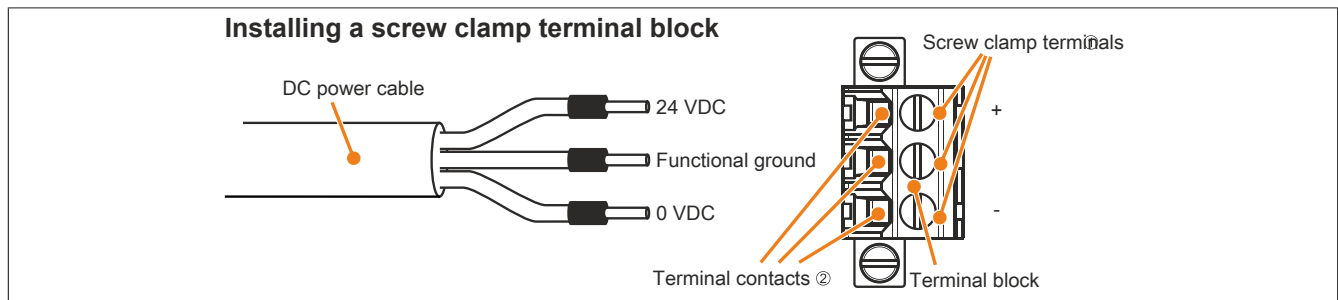

Figure 86: Installing a screw clamp terminal block

Installing cage clamp terminal block 0TB103.91

Insert a screwdriver into the cage clamp terminals ① and secure the wires with wire end sleeves in the terminal contacts ② as shown in the image below. Close the terminal contact by removing the screwdriver.

Observe the pinout of the power supply connection on the device during wiring!

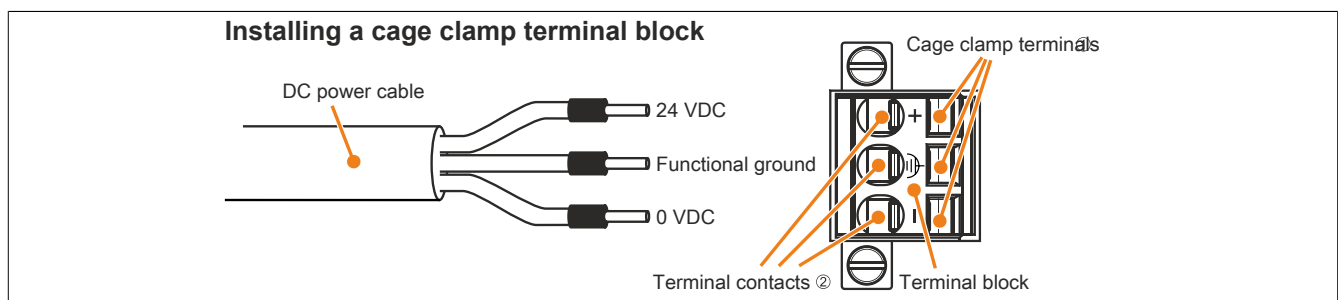

Figure 87: Installing a cage clamp terminal block

2.2 Connecting the power supply to a B&R device

Danger!

The power supply to the B&R device must be completely interrupted. Before connecting the power cable, it is necessary to check whether it has been disconnected from the power source (e.g. power supply).

1. Discharge any electrostatic charge on the housing or ground connection.
2. Connect the power supply connector to the B&R device and tighten the mounting screws (max. tightening torque 0.5 Nm).

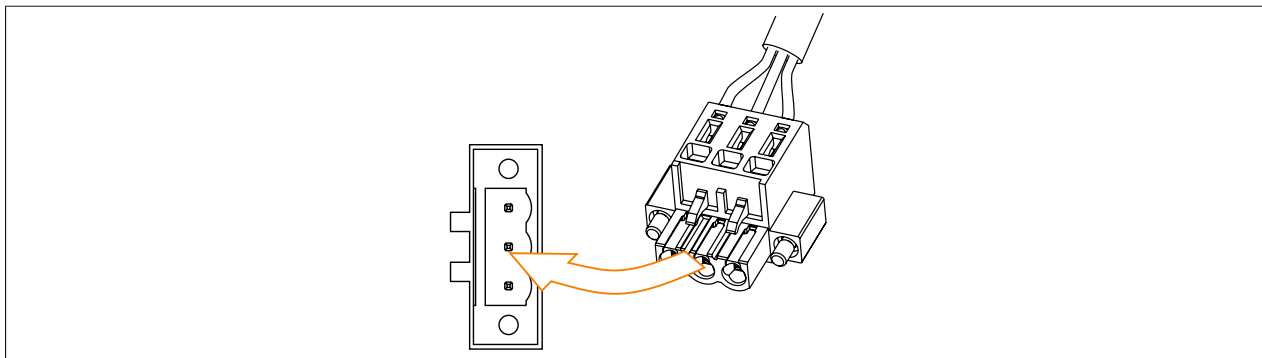

Figure 88: Connecting the power supply connector to a B&R device

2.3 Functional ground - Grounding concept

Functional ground is a current path of low impedance between electrical circuits and ground. It is used to improve immunity to interference, for example, and not necessarily as a protective measure. It therefore serves only to conduct interference, not to provide any kind of protection against electric shock.

This device comes equipped with 2 functional ground connections:

- Power supply
- Ground connection

To ensure the safe conductance of electrical interference, the following points must be observed:

- The device must be connected to the central grounding point in the control cabinet using the shortest route possible.
- A cable with a minimum cross section of 2.5 mm^2 per connection must be used. If a cable with wire end sleeves is connected to terminal block 0TB103.9 or 0TB103.91, then a cable with maximum 1.5 mm^2 per connection is possible.
- Observe the line shielding concept. All data cables connected to the device must be shielded.

The following symbol is used to indicate functional ground on the B&R device: 

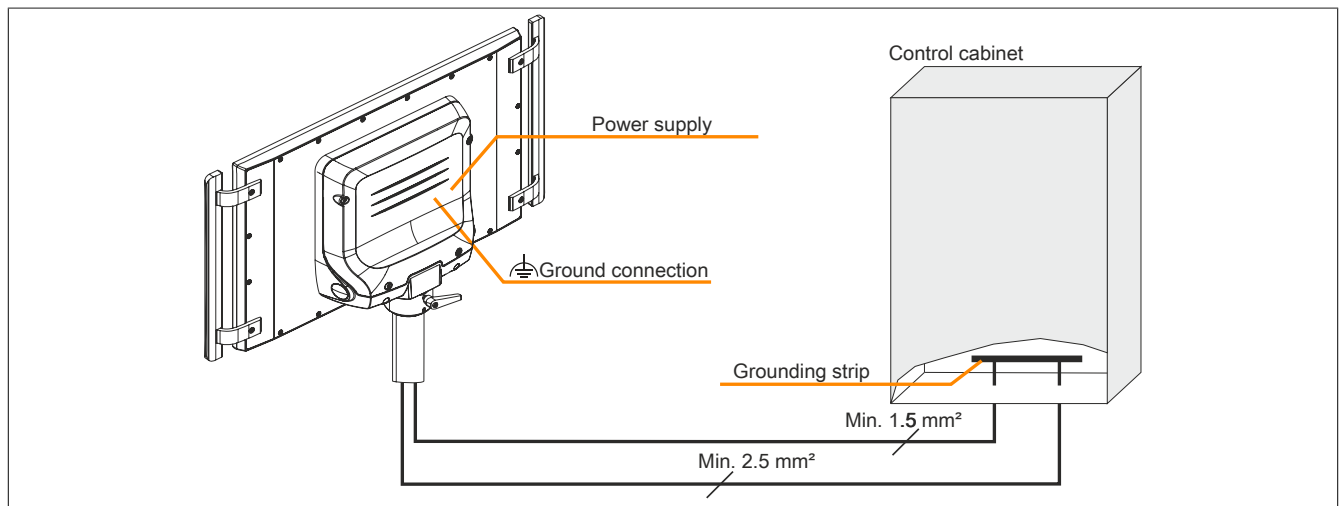

Figure 89: Automation Panel 5000 - Grounding concept

3 Cable connections

The bend radius specifications must be taken into account when installing or connecting cables.

Information:

The maximum tightening torque for the locating screws is 0.5 Nm.

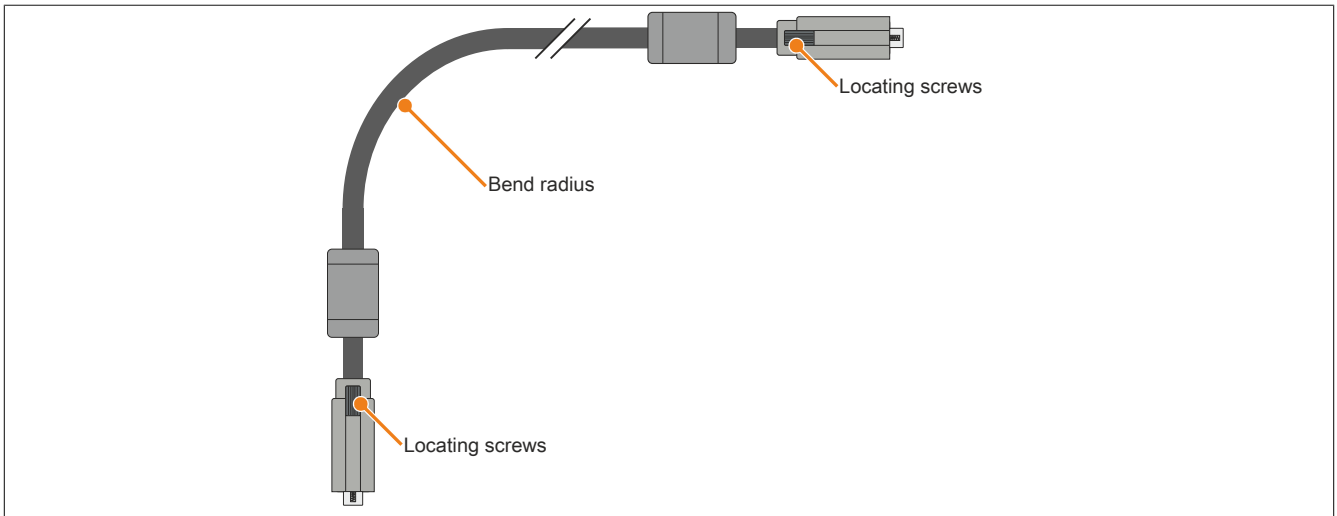

Figure 90: Bend radius - Cable connection

Information:

For the specified bend radius, see the technical data for the respective cable.

3.1 Connecting with SDL cables

It is possible to use 5CASDL.0xxx-00 SDL cables, 5CASDL.0xxx-01 SDL cables with 45° connector and 5CASDL.0xxx-03 SDL flex cables for the Automation Panel 5000 with SDL receiver.

4 Switching on the device for the first time

4.1 General information before switching on the device

Checklist

The following items must be checked before the device is put into service for the first time:

- Have the installation notes specified in "Installation" on page 129 been observed?
- Have the permissible environmental conditions for the device been taken into account?
- Is the power supply connected correctly, and have the values been checked?
- Is the ground cable connected correctly to the ground connection?
- The device must first be put into service before additional hardware is installed.

Caution!

Before the device is put into service, it must slowly be acclimated to room temperature! Subjecting it to thermal radiation is not permitted.

If transported at low temperatures or if there are large temperature fluctuations, the device is not permitted to be subjected to any type of moisture.

Moisture can cause short circuits in the electrical circuits and damages the device.

Requirements

The following requirements must be fulfilled before the device is switched on for the first time:

- The protective film has been removed from the panel.
- The functional ground connections must be kept as short as possible and connected to the central grounding point using the largest possible wire cross section.
- All connection cables must be connected correctly.
- A USB keyboard and USB mouse are connected (optional).
- An Automation PC or Panel PC is connected (via DVI, SDL, SDL3 or SDL4).

4.2 Switching on the Automation Panel

Procedure

1. Connect and switch on the voltage supply (e.g. power supply).
2. The device is operational.

5 Touch screen calibration

B&R touch screen devices are equipped with a B&R touch controller that supports hardware calibration. This means that devices are pre-calibrated when delivered. This is a beneficial property when replacing devices of the same model or type since the new device does not require recalibration. Nevertheless, calibrating the device is still recommended in order to achieve the best results and to better adapt the touch screen to the user's preferences.

5.1 Single-touch (analog resistive)

5.1.1 Windows 10 IoT Enterprise 2016 LTSC

After starting Windows 10 IoT Enterprise 2016 LTSC on a Panel PC for the first time, the appropriate touch screen driver is installed automatically.

On all other devices, the touch screen driver must be subsequently installed to operate the touch screen. The appropriate driver is available for download in the Downloads section of the B&R website (www.br-automation.com).

5.1.2 Windows 10 IoT Enterprise 2015 LTSC

After starting Windows 10 IoT Enterprise 2015 LTSC on the Panel PC for the first time, the corresponding touch screen driver is installed automatically.

On all other devices, the touch screen driver must be subsequently installed to operate the touch screen. The appropriate driver is available for download in the Downloads section of the B&R website (www.br-automation.com).

5.1.3 Windows Embedded 8.1 Industry Pro

After starting Windows Embedded 8.1 Industry Pro on the Panel PC for the first time, the corresponding touch screen driver is installed automatically.

On all other devices, the touch screen driver must be subsequently installed to operate the touch screen. The appropriate driver is available for download in the Downloads section of the B&R website (www.br-automation.com).

5.1.4 Windows 7 Professional / Ultimate

After installing Windows 7 on the device, the touch screen driver must be installed in order to operate the touch screen. The appropriate driver is available for download in the Downloads section of the B&R website (www.br-automation.com).

5.1.5 Windows Embedded Standard 7 Embedded / Premium

A touch screen driver will be installed automatically if a touch controller is detected during the Windows Embedded Standard 7 installation.

The touch screen driver must be installed manually if a touch controller was not detected when installing Windows Embedded Standard 7 or if an Automation Panel has been connected after installation. The appropriate driver is available for download in the Downloads section of the B&R website (www.br-automation.com).

5.1.6 Windows XP Professional

After installing Windows XP Professional on the device, the touch screen driver must be installed in order to operate the touch screen. The appropriate driver is available for download in the Downloads section of the B&R website (www.br-automation.com).

5.1.7 Windows Embedded Standard 2009

After starting Windows Embedded Standard 2009 on the Panel PC or Power Panel for the first time (first boot agent), the corresponding touch screen driver is installed automatically.

On all other devices, the touch screen driver must be subsequently installed to operate the touch screen. The appropriate driver is available for download in the Downloads section of the B&R website (www.br-automation.com).

5.2 Multi-touch (projected capacitive - PCT)

5.2.1 Windows 10 IoT Enterprise 2016 LTSC

Microsoft multi-touch drivers are installed when Windows 10 IoT Enterprise 2016 LTSC is installed on the device. After the successful installation of Windows 10 IoT Enterprise 2016 LTSC, the device is immediately ready for operation.

5.2.2 Windows 10 IoT Enterprise 2015 LTSC

Microsoft multi-touch drivers are installed when Windows 10 IoT Enterprise 2015 LTSC is installed on the device. Once the installation of Windows 10 IoT Enterprise 2015 LTSC has completed, the device can be operated immediately.

5.2.3 Windows Embedded 8.1 Industry Pro

Microsoft multi-touch drivers are installed when Windows Embedded 8.1 Industry Pro is installed on the device. Once the installation of Windows Embedded 8.1 Industry Pro has completed, the device can be operated immediately.

5.2.4 Windows 7 Professional / Ultimate

Microsoft multi-touch drivers are installed when Windows 7 is installed on the device. Once the installation of Windows 7 has completed, the device can be operated immediately.

5.2.5 Windows Embedded Standard 7 Premium

Microsoft multi-touch drivers are installed when Windows Embedded Standard 7 Premium is installed on the device. Once the installation of Windows Embedded Standard 7 Premium has completed, the device can be operated immediately.

6 Adjusting the display brightness

In SDL, SDL3 or SDL4 mode, the brightness of the display can be configured using the Control Center on the connected B&R industrial PC, for example. In DVI mode, the brightness can only be controlled using the two brightness controls provided on the SDL/DVI receiver.

6.1 Adjusting in SDL / SDL3 / SDL4 mode

1. Open the **Control Center** in the Control Panel.
2. Select the **Display** tab.
3. Select the Automation Panel from the list.
4. Set the desired brightness using the slider control.

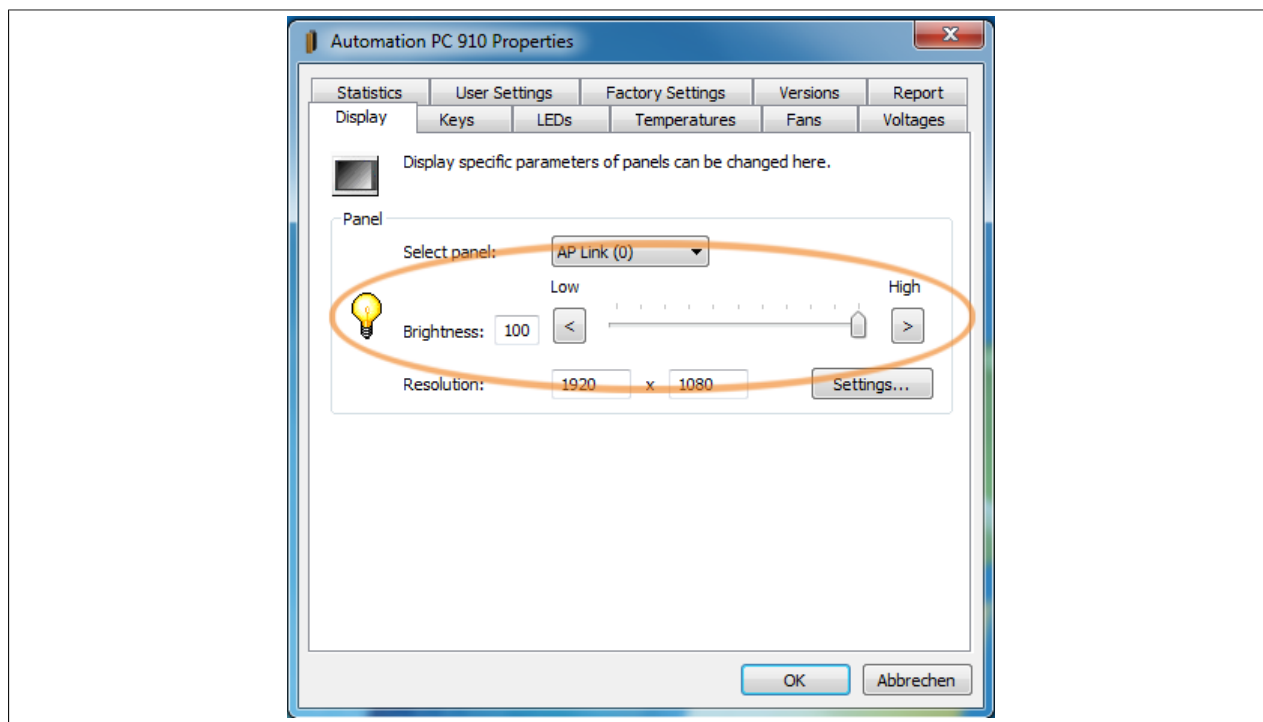

Figure 91: Adjusting the display brightness

Information:

Changes to these settings are displayed online but are only applied by the system (and applied during the next restart) if the Control Center is closed with **OK**.

The configured brightness is separate from the value configured in BIOS Setup, i.e. the value in BIOS is used until Windows boots. The value from BIOS is only applied the first time the Control Center is launched.

6.2 Adjusting in DVI mode

1. Use the two brightness controls on the SDL/DVI receiver to set the brightness.

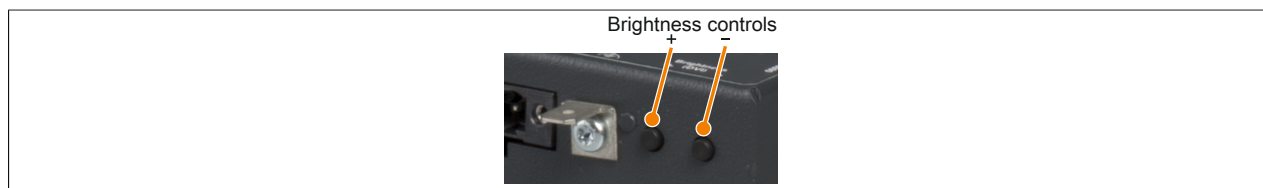

Figure 92: Brightness controls

Chapter 4 • Software

1 Upgrade information

Warning!

The BIOS and firmware on B&R devices must be kept current. New versions can be downloaded from the B&R website (www.br-automation.com).

1.1 Upgrading the firmware on the Automation Panel

The "Firmware upgrade (Automation Panel, SDL3 Converter)" software makes it possible to update the firmware for multiple controllers (SDLR, SDL3R, SDL4R, SDL3 Converter) depending on how the system is designed.

The latest firmware upgrade is available in the Downloads section of the B&R website (www.br-automation.com).

Caution!

The PC is not permitted to be switched off or reset while performing an update!

2 Multi-touch drivers

Multi-touch panels are approved as human-interface devices (i.e. multi-touch support from the operating system) for the following operating systems:

- Windows 10 IoT Enterprise 2016 LTSC
- Windows 10 IoT Enterprise 2015 LTSC
- Windows Embedded 8.1 Industry Pro
- Windows 7 Professional/Ultimate
- Windows Embedded Standard 7 Premium
- B&R Linux 8 and 9

No guarantee can be made regarding multi-touch or single-touch operation, compatibility and functionality when using other operating systems and/or individual touch screen drivers.

3 Automation Runtime

3.1 General information

An integral component of Automation Studio is the Automation Runtime real-time operating system. This real-time operating system is the software kernel that allows applications to run on a target system.

- Guaranteed highest possible performance for the hardware being used
- Runs on all B&R target systems
- Makes the application hardware-independent
- Easy portability of applications between B&R target systems
- Deterministic behavior guaranteed by cyclic system
- Configurable jitter tolerance in all task classes
- Supports all relevant programming language such as IEC 61131-3 and C
- Extensive function library conforming to IEC 61131-3 as well as the expanded B&R Automation library
- Integrated into Automation NET. Access to all networks and bus systems via function calls or the Automation Studio™ configuration

B&R Automation Runtime is fully embedded in the corresponding target system (the hardware where Automation Runtime is installed). It allows application programs to access I/O systems (e.g. via the fieldbus) and other devices (interfaces, networks, etc.).

3.2 System requirements

The following software versions (or higher) are required to operate Automation Runtime (ARemb and ARwin) with an Automation Panel 5000:

- ARemb upgrade AR K4.10 and Automation Studio V4.2.5

4 B&R Automation Device Interface (ADI) Control Center

The Automation Device Interface (ADI) makes it possible to access specific functions of B&R devices. In Windows, the settings for these devices can be viewed and modified using the B&R Control Center in the Control Panel.

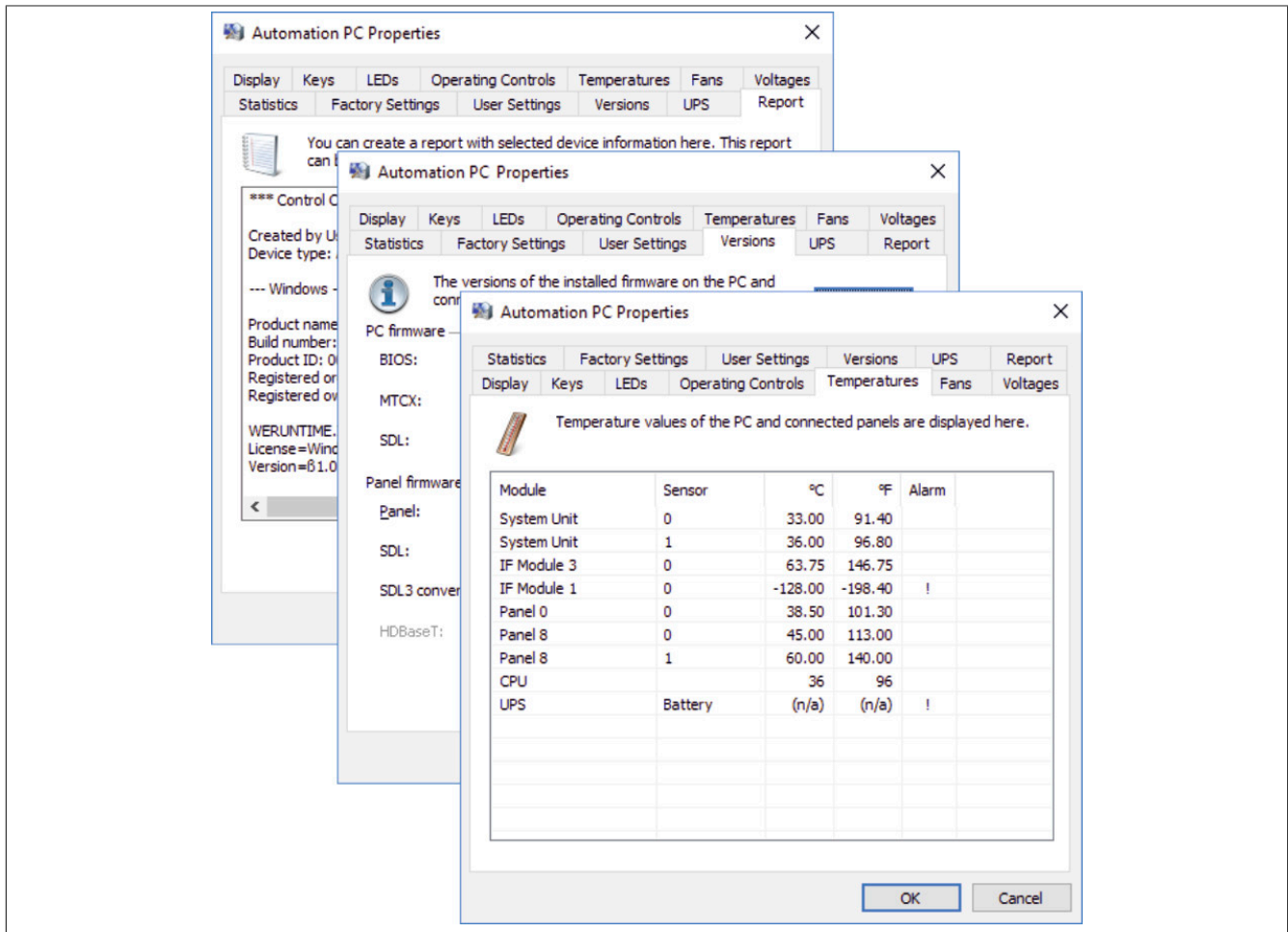

Figure 93: ADI Control Center screenshots - Examples

Information:

The temperature and voltage values (e.g. CPU temperature, core voltage, battery voltage) displayed represent uncalibrated values for informational purposes. They cannot be used to draw conclusions about possible hardware alarms or error states. The hardware components being used include automatic diagnostic functions in the event of error.

4.1 Functions

Information:

The functions provided by the Control Center depend on the device family.

- Changing display-specific parameters
- Reading device-specific keys
- Updating the key configuration
- Enabling device-specific LEDs on a membrane keypad or keys
- Reading and calibrating control devices (e.g. key switches, handwheels, joysticks, potentiometers)
- Reading temperatures, fan speeds, statistical data and switch positions
- Reading operating hours (power-on hours)
- Reading user settings and factory settings
- Reading software versions
- Updating and backing up BIOS and firmware
- Creating reports about the current system (support assistance)

- Setting the SDL equalizer value when adjusting SDL cables
- Changing the user serial ID

For a detailed description of the Control Center, see Automation Help or the user documentation (depends on the version).

4.2 Installation

The B&R Automation Device Interface (ADI) driver (also includes the Control Center) and user documentation can be downloaded at no cost from the Downloads section of the B&R website (www.br-automation.com).

Information:

The ADI driver is included in most B&R Windows operating systems; it can also be installed on demand.

If a more current ADI driver version exists (see the Downloads section of the B&R website), it can be installed later. Note that the write filter must be disabled during installation.

5 B&R Automation Device Interface (ADI) Development Kit

This software can be used to access B&R Automation Device Interface (ADI) functions directly from Windows applications created in Microsoft Visual Studio, for example.

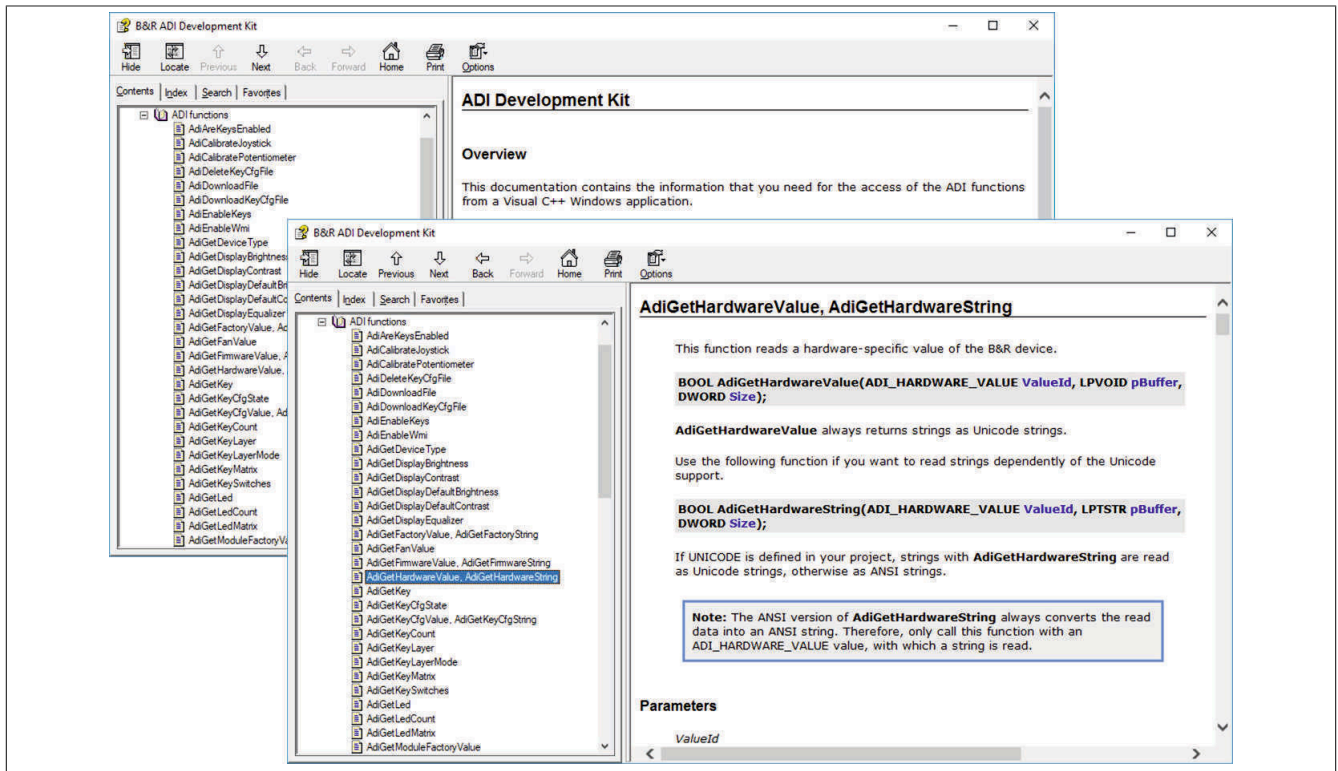

Figure 94: ADI Development Kit Screenshots (Symbolbild)

Features:

- Header files and import libraries
- Help files
- Sample projects
- ADI DLL (for testing applications if no ADI driver is installed)

The appropriate ADI driver must be installed for the specified product family. The ADI driver is already included in the embedded operating system images from B&R.

For a detailed description of how to use ADI functions, see Automation Help.

The B&R Automation Device Interface (ADI) Development Kit can be downloaded at no cost from the Downloads section of the B&R website (www.br-automation.com).

6 B&R Automation Device Interface (ADI) .NET SDK

This software can be used to access B&R Automation Device Interface (ADI) functions directly from .NET applications created in Microsoft Visual Studio.

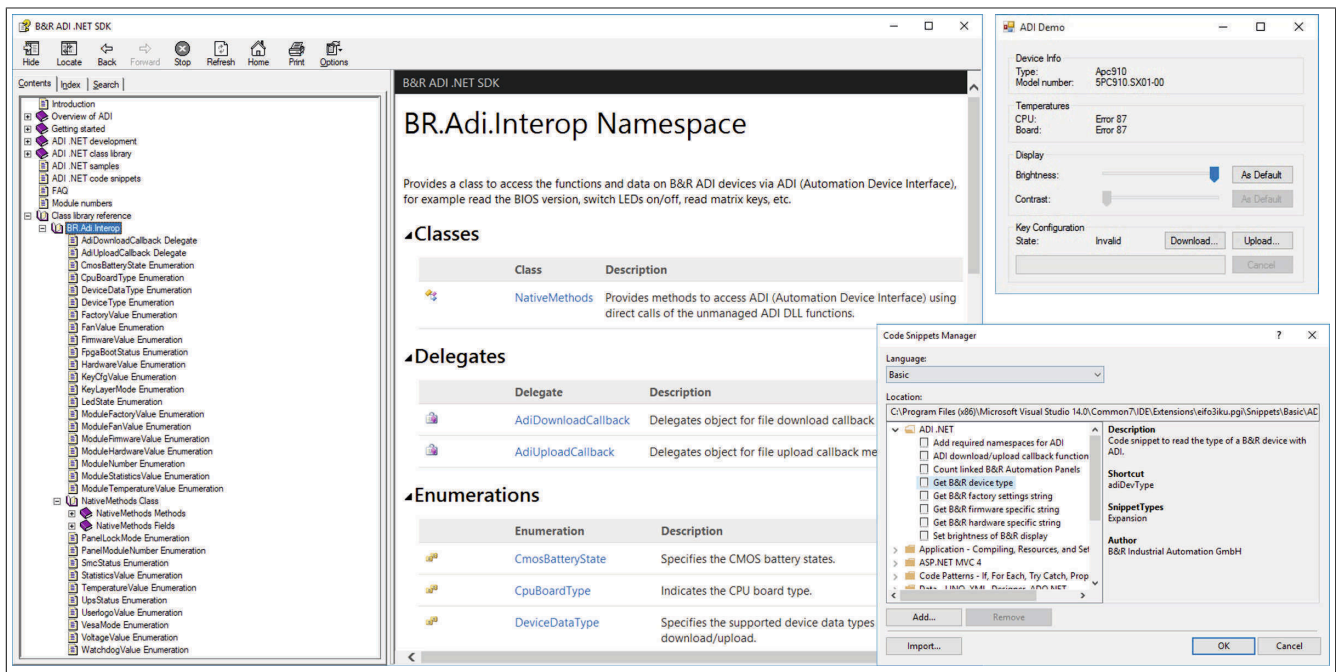

Figure 95: ADI .NET SDK screenshots

Features:

- ADI .NET class library
- Help files (the help documentation is in English)
- Sample projects and code snippets.
- ADI DLL (for testing applications if no ADI driver is installed).

The appropriate ADI driver must be installed for the specified product family. The ADI driver is already included in the embedded operating system images from B&R.

For a detailed description of how to use ADI functions, see Automation Help.

The ADI .NET SDK can be downloaded at no cost from the Downloads section of the B&R website (www.br-automation.com).

7 B&R Key Editor

A common panel requirement is to adapt function keys and LEDs directly to the application software. The B&R Key Editor makes this individual adaptation to the application quick and easy.

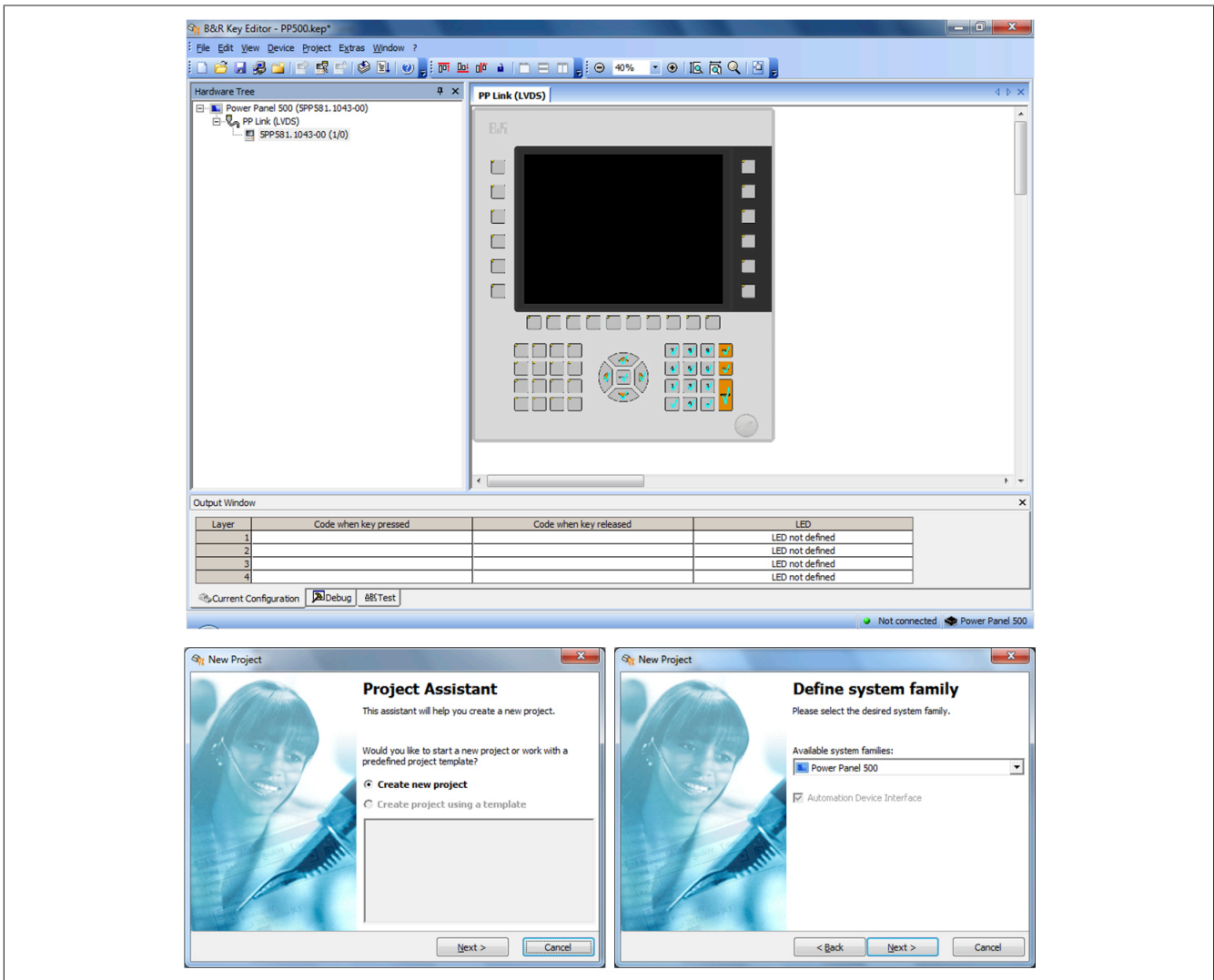

Figure 96: B&R Key Editor screenshots

Features:

- Configuration of normal keyboard keys (A, B, C, etc.)
- Keyboard shortcuts (CTRL+C, SHIFT+DEL, etc.) using a single key
- Special key functions (change brightness, etc.)
- Assignment of functions to LEDs (HDD access, power, etc.)
- 4 assignments possible per key (using layers)
- Configuration of the panel locking time when connecting multiple Automation Panel devices to Automation PCs and Panel PCs.

For a detailed guide on configuring keys and LEDs as well as installing the key configuration on the target system, see the help documentation for the B&R Key Editor. The B&R Key Editor and its help documentation can be downloaded at no cost from the Downloads section of the B&R website (www.br-automation.com).

8 B&R KCF Editor

The B&R KCF Editor can be used as a simple alternative to B&R Key Editor. This tool also allows function keys and LEDs to be adapted to the application software. Unlike the B&R Key Editor, operation takes place in a simple Windows dialog box instead of on a visual representation of the device. This makes it possible to use the B&R KCF Editor for devices that are not yet supported by the B&R Key Editor. The B&R KCF Editor is a portable application and can be launched on the target device without prior installation (directly from a USB flash drive, for example). An installed ADI driver is required to use the software's full range of functions.

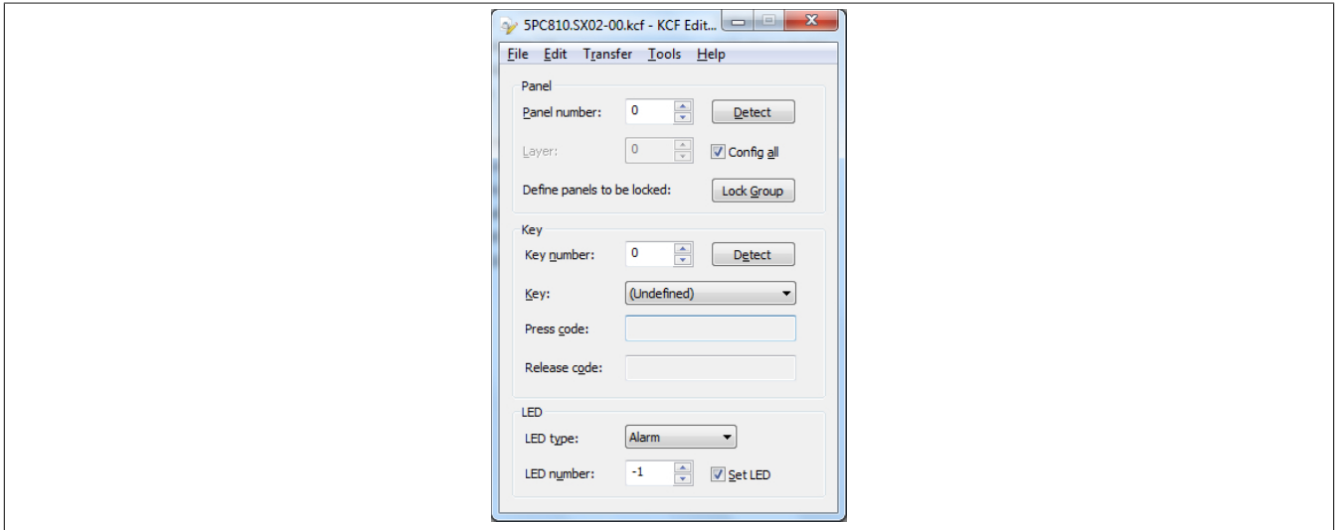

Figure 97: B&R KCF Editor V1.0 screenshot

Features

- Configuration of normal keyboard keys (A, B, C, etc.)
- Special key functions (change brightness, etc.)
- Assignment of functions to LEDs (HDD access, power, etc.)
- 4 assignments possible per key (using layers)
- Configuration of the panel locking time when connecting multiple Automation Panel devices to B&R PCs.
- Exporting and importing configurations (INI files)
- Saving configurations as a report (text file)

Additional features if the B&R KCF Editor is executed on the target device³⁾

- Panel and key detection
- LED test
- Configuration uploads/downloads

³⁾ The ADI driver must be installed on the B&R PC to use these features.

9 HMI Service Center

9.1 5SWUTI.0001-000

9.1.1 General information

The HMI Service Center is software for testing B&R industrial PCs and Automation Panels. Various categories such as COM interfaces, network connectivity and SRAM are tested.

The test system consists of a USB flash drive with an installed Windows PE operating system and the HMI Service Center.

For details about the HMI Service Center, see the HMI Service Center user's manual. This can be downloaded at no cost from the B&R website (www.br-automation.com).

9.1.2 Order data

Model number	Short description	Figure
	Accessories	
5SWUTI.0001-000	HMI Service Center USB flash drive - Hardware diagnostic software - For APC810/PPC800 - For APC910/PPC900 - For APC2100/PPC2100 - For APC3100/PPC3100 - For APC51x/PP500 - For Automation Panel 800/900	

Table 113: 5SWUTI.0001-000 - Order data

Chapter 5 • Standards and certifications

1 Standards and guidelines

1.1 CE marking



All guidelines applicable to the product and their harmonized EN standards are fulfilled.

1.2 EMC directive

These products meet the requirements of EU directive "Electromagnetic compatibility 2014/30/EU" and are designed for industrial use:

EN 61131-2:2007	Programmable logic controllers - Part 2: Equipment requirements and tests
EN 61000-6 -2:2005	Electromagnetic compatibility (EMC) - Part 6-2: Generic standards - Immunity for industrial environments
EN 61000-6 -4:2007	Electromagnetic compatibility (EMC) - Part 6-4: Generic standards - Emission standard for industrial environments

Information:

Declarations of conformity are available on the B&R website under [Downloads - Certificates - Declarations of conformity](#).

2 Certifications

Danger!

A complete system can only receive certification if **ALL** of the individual components installed therein have the corresponding certifications. If an individual component is used that **DOES NOT** have a corresponding certification, then the complete system also **DOES NOT** have certification.

Products and services from B&R comply with applicable standards. This includes international standards from organizations such as ISO, IEC and CENELEC, as well as national standards from organizations such as UL, CSA, FCC, VDE, ÖVE, etc. We are committed to ensuring the reliability of our products in industrial environments.

Information:

Applicable certifications for the respective product are available on the website, under section "Certifications" of the technical data in the user's manual or in the associated certificates.

2.1 UL certification



Products with this mark are tested by Underwriters Laboratories and listed as "industrial control equipment". This mark is valid for the USA and Canada and simplifies the certification of your machines and manufacturing systems in this economic region.

Underwriters Laboratories (UL) per standard UL 508
Canadian (CSA) standard per C22.2 No. 142-M1987

UL certificates are available on the B&R website under [Downloads - Certificates - UL](#).

Ind.Cont.Eq.
E115267

2.2 GOST-R



Products with this mark are tested by an accredited testing laboratory and permitted for import to the Russian Federation (based on EU compliance).

2.3 EAC



Products with this mark are tested by an accredited testing laboratory and permitted for import to the Eurasian Economic Union (based on EU compliance).

2.4 KC



Products with this mark are tested by an accredited testing laboratory and permitted for import to the Korean market (based on EU compliance).

2.5 RCM



Products with this mark are tested by an accredited testing laboratory and certified by the ACMA. This mark is valid in Australia/Oceania and simplifies the certification of your machines and systems in this economic region (based on EU compliance).

Chapter 6 • Accessories

The functionality of the following accessories has been tested and approved by B&R in connection with this device. Nevertheless, there may be possible limitations with regard to operation with other individual components as part of the complete system. For the operation of the complete system, all individual specifications of the components must be observed.

All components listed in this manual have been subjected to extensive system and compatibility testing and approved accordingly. B&R cannot guarantee the functionality of non-approved accessories.

1 Power connectors

1.1 0TB103.9x

1.1.1 General information

This 1-row, 3-pin 0TB103 terminal block is used for the power supply.

1.1.2 Order data

Model number	Short description	Figure
	Accessories	
0TB103.9	Connector 24 VDC - 3-pin female - Screw clamp terminal block 3.31 mm ²	
0TB103.91	Connector 24 VDC - 3-pin female - Cage clamp terminal block 3.31 mm ²	

Table 114: 0TB103.9, 0TB103.91 - Order data

1.1.3 Technical data

Information:

The following specifications, properties and limit values apply only to this accessory and may deviate from those that apply to the complete system. For the complete system in which this accessory is installed, for example, the data specified for that complete system applies.

Model number	0TB103.9	0TB103.91
General information		
Certification	Yes	
CE	cULus E115267	
UL	Industrial control equipment	
HazLoc	cULus HazLoc E180196 Industrial control equipment for hazardous locations Class I, Division 2, Groups ABCD, T4 ¹⁾	
DNV GL	Temperature: B (0 - 55°C) Humidity: B (up to 100%) Vibration: A (0.7 g) EMC: B (Bridge and open deck) ²⁾	
Terminal block		
Note	Protected against vibration by the screw flange Nominal values per UL	
Number of pins	3 (female)	
Type of terminal block	Screw clamp terminal block	Cage clamp terminal block ³⁾
Cable type	Only copper wires (no aluminum wires!)	
Distance between contacts	5.08 mm	

Table 115: 0TB103.9, 0TB103.91 - Technical data

Model number	0TB103.9	0TB103.91
Connection cross section		
AWG wire	26 to 14 AWG	26 to 12 AWG
Wire end sleeves with plastic covering		0.20 to 1.50 mm ²
Solid wires		0.20 to 2.50 mm ²
Fine strand wires	0.20 to 1.50 mm ²	0.20 to 2.50 mm ²
With wire end sleeves		0.20 to 1.50 mm ²
Tightening torque	0.4 Nm	-
Electrical characteristics		
Nominal voltage		300 V
Nominal current ⁴⁾		10 A / contact
Contact resistance		≤5 mΩ
Operating conditions		
EN 61131 pollution degree		Pollution degree 2

Table 115: 0TB103.9, 0TB103.91 - Technical data

- 1) Yes, although applies only if all components installed in the complete system have this certification and the complete system bears the corresponding mark.
- 2) Yes, although applies only if all components installed in the complete system have this certification and are listed on the associated DNV GL certificate for the product family.
- 3) Cage clamp terminal blocks cannot be used side-by-side.
- 4) The respective limit data for the I/O modules must be taken into account.

2 USB flash drives

2.1 5MMUSB.xxxx-01

2.1.1 General information

USB flash drives are easily exchangeable data storage devices. Because of their high-speed data transfer (USB 2.0), USB flash drives are ideal for use as portable storage media. Without additional drivers ("hot plugging", except in Windows 98SE), the USB flash drive is immediately registered as a drive for reading and writing data.

Information:

Due to the large number of USB flash drives available on the market as well as their short product lifecycle, we reserve the right to provide alternative products. The following measures may therefore be necessary in order to also boot from these USB flash drives:

- The USB flash drive must be reformatted or in some cases also repartitioned (set partition as active).
- The USB flash drive must be in the first position of the BIOS boot order; alternatively, the IDE controllers can be disabled in BIOS. This can be avoided in most cases if command "fdisk / mbr" is additionally executed on the USB flash drive.

2.1.2 Order data

Model number	Short description	Figure
	USB accessories	
5MMUSB.2048-01	USB 2.0 flash drive 2048 MB B&R	
5MMUSB.4096-01	USB 2.0 flash drive 4096 MB B&R	

Table 116: 5MMUSB.2048-01, 5MMUSB.4096-01 - Order data

2.1.3 Technical data

Information:

The following specifications, properties and limit values apply only to this accessory and may deviate from those that apply to the complete system. For the complete system in which this accessory is installed, for example, the data specified for that complete system applies.

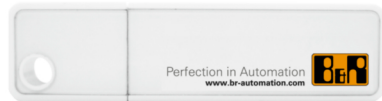
Model number	5MMUSB.2048-01	5MMUSB.4096-01
General information		
Capacity	2 GB	4 GB
LED status indicators	1 LED (green) ¹⁾	
MTBF	>3,000,000 hours	
Type	USB 1.1, USB 2.0	
Maintenance	None	
Default file system	FAT32	
Certification		
CE	Yes	
GOST-R	Yes	
Interfaces		
USB		
Type	USB 1.1, USB 2.0	
Connection	To any USB type A interface	
Transfer rate	Low speed (1.5 Mbit/s), full speed (12 Mbit/s), high speed (480 Mbit/s)	
Sequential reading	Full speed max. 1 MB/s, high speed max. 32 MB/s	
Sequential writing	Full speed max. 0.9 MB/s, high speed max. 23 MB/s	
Endurance		
SLC flash	Yes	
Data retention	>10 years	
Data reliability	<1 unrecoverable error per 10 ¹⁴ bits read	
Connection cycles	>1500	

Table 117: 5MMUSB.2048-01, 5MMUSB.4096-01 - Technical data

Model number	5MMUSB.2048-01	5MMUSB.4096-01
Support		
Operating systems		
Windows 7		Yes
Windows XP Professional		Yes
Windows XP Embedded		Yes
Windows ME		Yes
Windows 2000		Yes
Windows CE 5.0		Yes
Windows CE 4.2		Yes
Electrical characteristics		
Current consumption	Max. 500 µA in sleep mode, max. 120 mA read/write	
Environmental conditions		
Temperature		
Operation	0 to 70°C	
Storage	-50 to 100°C	
Transport	-50 to 100°C	
Relative humidity		
Operation	85%, non-condensing	
Storage	85%, non-condensing	
Transport	85%, non-condensing	
Vibration		
Operation	20 to 2000 Hz: 20 g (peak)	
Storage	20 to 2000 Hz: 20 g (peak)	
Transport	20 to 2000 Hz: 20 g (peak)	
Shock		
Operation	Max. 1500 g (peak)	
Storage	Max. 1500 g (peak)	
Transport	Max. 1500 g (peak)	
Elevation		
Operation	Max. 3048 m	
Storage	Max. 12192 m	
Transport	Max. 12192 m	
Mechanical characteristics		
Dimensions		
Width	17.97 mm	
Length	67.85 mm	
Height	8.35 mm	

Table 117: 5MMUSB.2048-01, 5MMUSB.4096-01 - Technical data

1) Indicates data transfer (receiving and transmitting).

2.1.4 Temperature/Humidity diagram

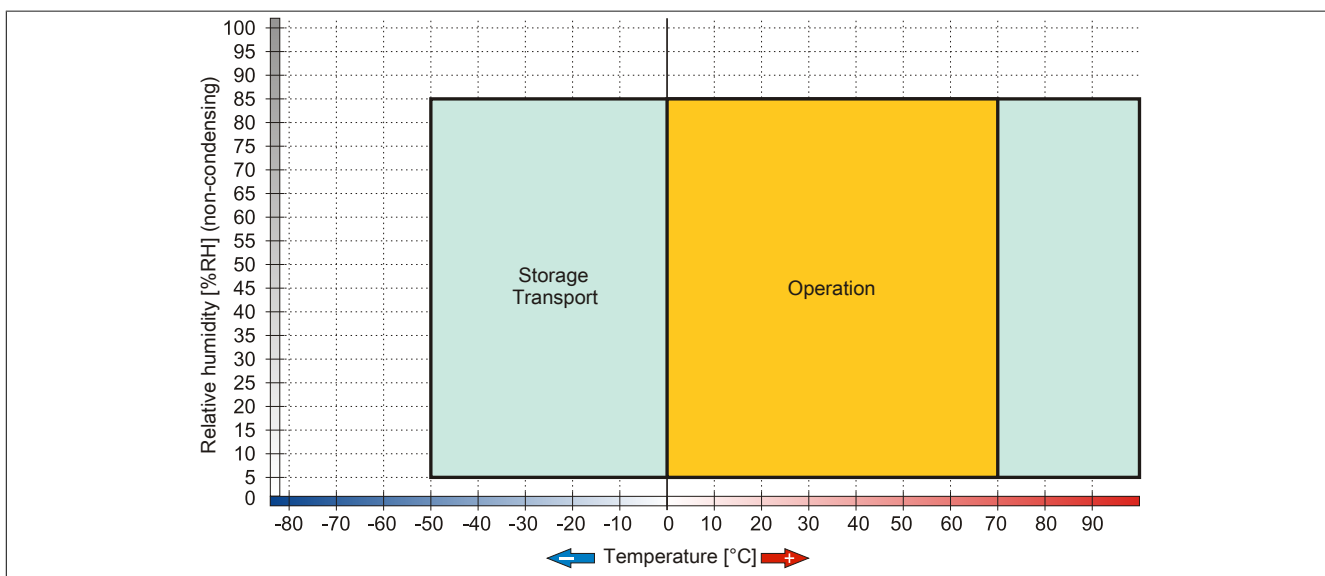

Figure 98: 5MMUSB.xxxx-01 - Temperature/Humidity diagram

2.2 5MMUSB.032G-02

2.2.1 General information

USB flash drives are easily exchangeable data storage devices. Because of their high-speed data transfer (USB 3.0), USB flash drives are ideal for use as portable storage media. Without additional drivers ("hot plugging", except in Windows 98SE), the USB flash drive is immediately registered as a drive for reading and writing data. USB 3.0 (XHCI) is supported starting with Windows 7 (USB 3.0 driver required).

Information:

Due to the large number of USB flash drives available on the market as well as their short product lifecycle, we reserve the right to provide alternative products. The following measures may therefore be necessary in order to also boot from these USB flash drives:

- The USB flash drive must be reformatted or in some cases also repartitioned (set partition as active).
- The USB flash drive must be in the first position of the BIOS boot order; alternatively, the IDE controllers can be disabled in BIOS. This can be avoided in most cases if command "fdisk / mbr" is additionally executed on the USB flash drive.

2.2.2 Order data

Model number	Short description	Figure
	USB accessories	
5MMUSB.032G-02	USB 3.0 flash drive 32 GB MLC	

Table 118: 5MMUSB.032G-02 - Order data

2.2.3 Technical data

Information:

The following specifications, properties and limit values apply only to this accessory and may deviate from those that apply to the complete system. For the complete system in which this accessory is installed, for example, the data specified for that complete system applies.

Model number	5MMUSB.032G-02
General information	
Capacity	32 GB
LED status indicators	1 LED (green) ¹⁾
MTBF	>3,000,000 hours
Type	USB 2.0, USB 3.0
Maintenance	None
Certification	
CE	Yes
Interfaces	
USB	
Type	USB 2.0, USB 3.0
Connection	To any USB type A interface
Transfer rate	High speed (480 Mbit/s) to SuperSpeed (4 Gbit/s)
Sequential reading	USB 3.0 max. 100 MB/s
Sequential writing	USB 3.0 max. 50 MB/s
Endurance	
MLC flash	Yes
Data reliability	<1 unrecoverable error per 10 ¹⁴ bits read
Connection cycles	>1500
Electrical characteristics	
Current consumption	Max. 67 mA in sleep mode, max. 122 mA read, max. 141 mA write
Environmental conditions	
Temperature	
Operation	0 to 70°C
Storage	-55 to 95°C
Transport	-55 to 95°C

Table 119: 5MMUSB.032G-02 - Technical data

Model number	5MMUSB.032G-02
Relative humidity	
Operation	10 to 95%, non-condensing
Storage	10 to 95%, non-condensing
Transport	10 to 95%, non-condensing
Vibration	
Operation	7 to 2000 Hz: 20 g
Storage	7 to 2000 Hz: 20 g
Transport	7 to 2000 Hz: 20 g
Shock	
Operation	1500g, 0.5 ms
Storage	1500g, 0.5 ms
Transport	1500g, 0.5 ms
Elevation	
Operation	Max. 3048 m
Storage	Max. 12192 m
Transport	Max. 12192 m
Mechanical characteristics	
Dimensions	
Width	16.58 mm
Length	48.30 mm
Height	7.60 mm
Weight	10 g
Manufacturer information	
Manufacturer	Innodisk
Manufacturer's product ID	DEUA1-32G161BCH88 (USB drive 3ME)

Table 119: 5MMUSB.032G-02 - Technical data

1) Indicates data transfer (receiving and transmitting).

2.2.4 Temperature/Humidity diagram

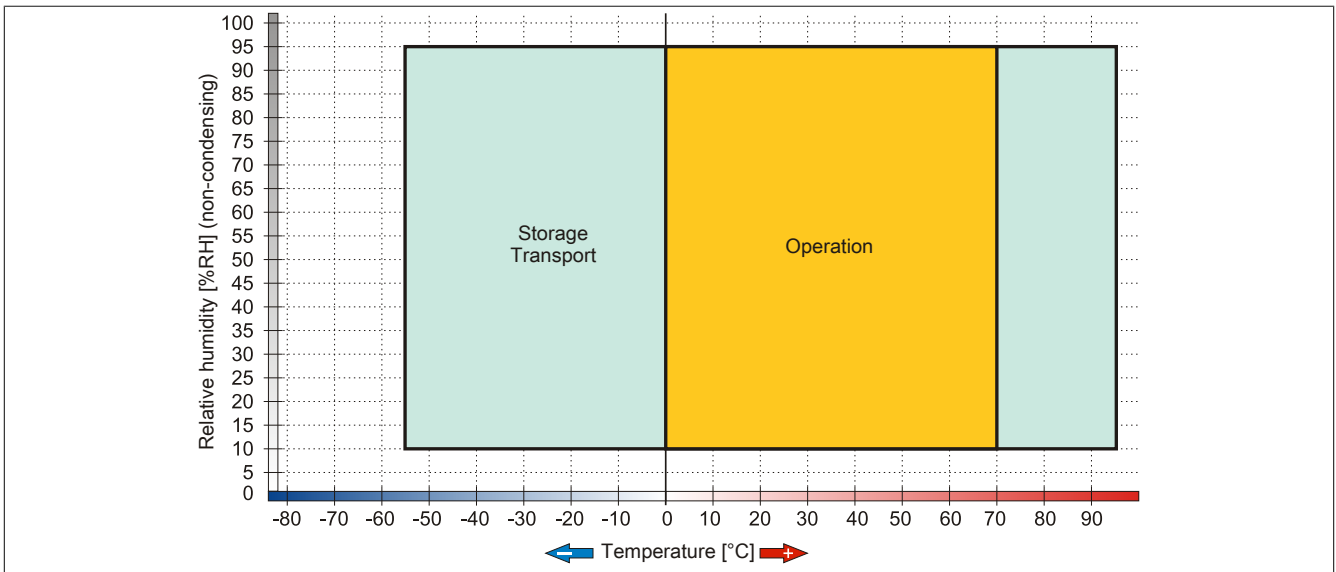

Figure 99: 5MMUSB.032G-02 - Temperature/Humidity diagram

3 Cables

3.1 DVI cables

3.1.1 5CADVI.0xxx-00

3.1.1.1 General information

5CADVI.0xxx-00 DVI cables are designed for use in fixed installations.

Caution!

The cable is only permitted to be connected or disconnected when the power is switched off.

3.1.1.2 Order data

Model number	Short description	Figure
	DVI cables	
5CADVI.0018-00	DVI-D cable - 1.8 m	
5CADVI.0050-00	DVI-D cable - 5 m	
5CADVI.0100-00	DVI-D cable - 10 m	

Table 120: 5CADVI.0018-00, 5CADVI.0050-00, 5CADVI.0100-00 - Order data

3.1.1.3 Technical data

Information:

The following specifications, properties and limit values apply only to this accessory and may deviate from those that apply to the complete system. For the complete system in which this accessory is installed, for example, the data specified for that complete system applies.

Model number	5CADVI.0018-00	5CADVI.0050-00	5CADVI.0100-00
General information			
Certifications			
CE	Yes		
UL	cULus E115267 Industrial control equipment		
DNV GL	Temperature: B (0 - 55°C) Humidity: B (up to 100%) Vibration: A (0.7 g) EMC: B (Bridge and open deck) ¹⁾		
GOST-R	Yes		
Cable construction			
Wire cross section	28 AWG		
Shield	Individual cable pairs, entire cable		
Complete shielding	Tinned copper braiding, optical coverage >86%		
Outer jacket			
Material	PVC		
Color	Beige		
Labeling	AWM STYLE 20276 80°C 30 V VW1 DVI DIGITAL SINGLE LINK DER AN		
Connector			
Type	2x DVI-D (18+1), male		
Connection cycles	100		
Locating screw tightening torque	Max. 0.5 Nm		
Electrical characteristics			
Conductor resistance	Max. 237 Ω/km		
Insulation resistance	Min. 100 MΩ/km		
Operating conditions			
Pollution degree per EN 61131	Pollution degree 2		
Mechanical characteristics			
Dimensions			
Length	1.8 m ±50 mm	5 m ±80 mm	10 m ±100 mm
Diameter	Max. 8.5 mm		
Bend radius	≥5x cable diameter (male connector - ferrite bead and ferrite bead - ferrite bead)		
Weight	Approx. 260 g	Approx. 460 g	Approx. 790 g

Table 121: 5CADVI.0018-00, 5CADVI.0050-00, 5CADVI.0100-00 - Technical data

1) Yes, although applies only if all components installed in the complete system have this certification and are listed on the associated DNV GL certificate for the product family.

3.1.1.4 Bend radius specifications

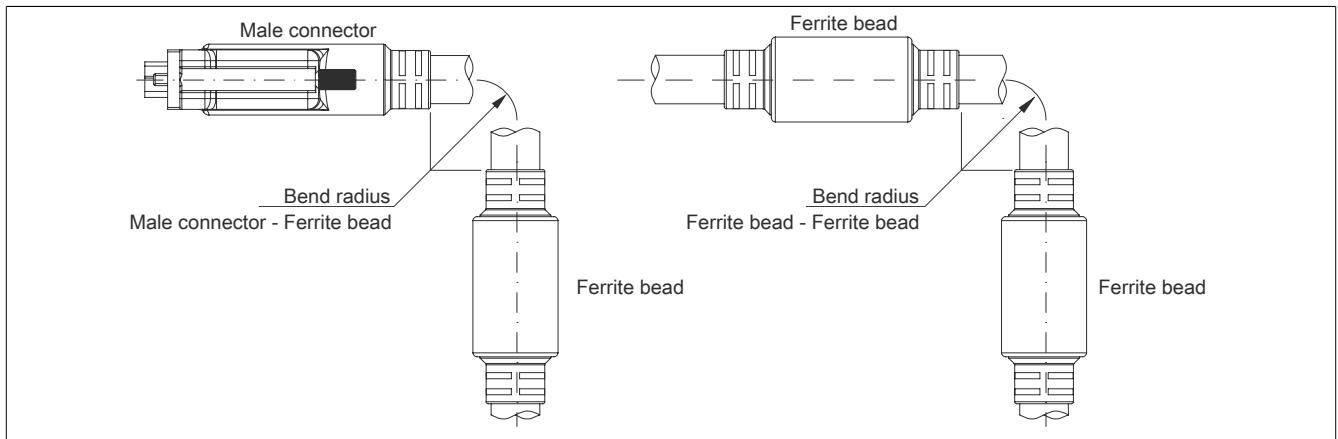

Figure 100: Bend radius specifications

3.1.1.5 Dimensions

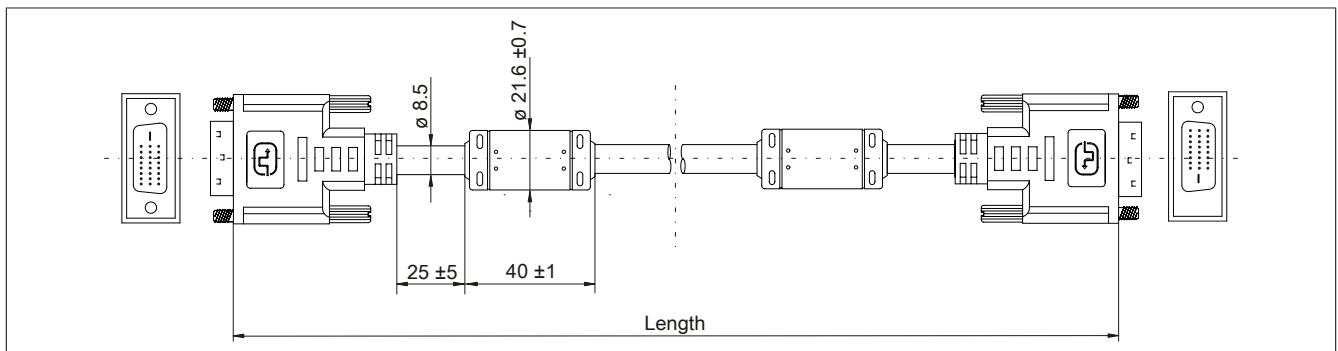

Figure 101: 5CADVI.0xxx-00 - Dimensions

3.1.1.6 Cable pinout

Warning!

If a field-assembled cable is desired, it must be wired according to this pinout.

If a field-assembled cable is used, B&R cannot make any guarantee as to its functionality. Functionality is only ensured with cables provided by B&R.

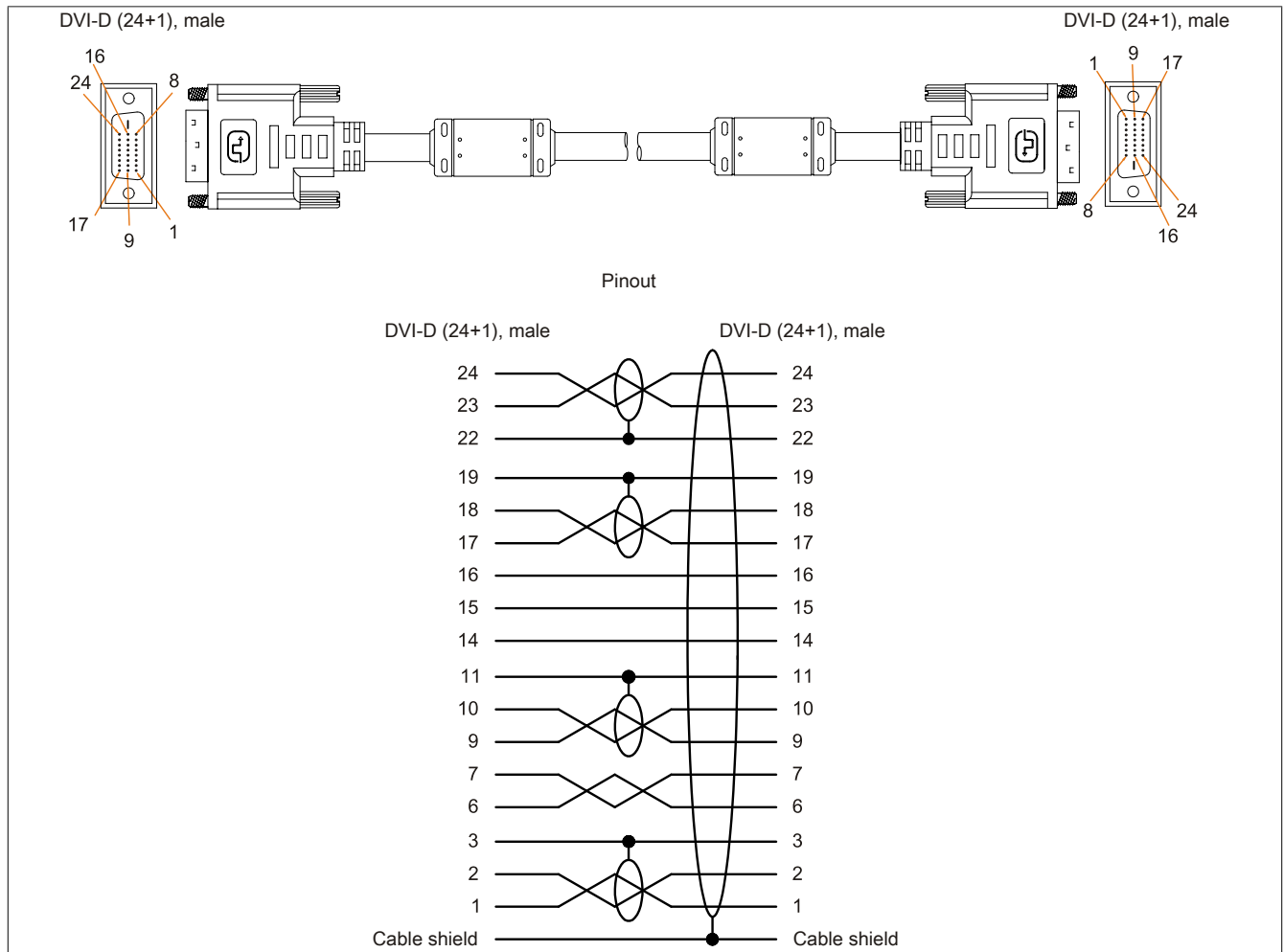

Figure 102: 5CADVI.0xxx-00 - Pinout

3.2 SDL cables

3.2.1 5CASDL.0xxx-00

3.2.1.1 General information

5CASDL.0xxx-00 SDL cables are designed for use in fixed installations. 5CASDL.0xxx-03 SDL flex cables are required for flexible installations (e.g. swing arm systems).

Caution!

The cable is only permitted to be connected or disconnected when the power is switched off.

3.2.1.2 Order data

Model number	Short description	Figure
	SDL cables	
5CASDL.0008-00	SDL cable - 0.8 m	
5CASDL.0018-00	SDL cable - 1.8 m	
5CASDL.0050-00	SDL cable - 5 m	
5CASDL.0100-00	SDL cable - 10 m	
5CASDL.0150-00	SDL cable - 15 m	
5CASDL.0200-00	SDL cable - 20 m	
5CASDL.0250-00	SDL cable - 25 m	
5CASDL.0300-00	SDL cable - 30 m	

Table 122: 5CASDL.0008-00, 5CASDL.0018-00, 5CASDL.0050-00, 5CASDL.0100-00, 5CASDL.0150-00, 5CASDL.0200-00, 5CASDL.0250-00, 5CASDL.0300-00 - Order data

3.2.1.3 Technical data

Information:

The following specifications, properties and limit values apply only to this accessory and may deviate from those that apply to the complete system. For the complete system in which this accessory is installed, for example, the data specified for that complete system applies.

Model number	5CASDL.0008-00	5CASDL.0018-00	5CASDL.0050-00	5CASDL.0100-00	5CASDL.0150-00	5CASDL.0200-00	5CASDL.0250-00	5CASDL.0300-00
General information								
Certification								
CE	Yes							
UL	cULus E115267 Industrial control equipment							
HazLoc	cULus HazLoc E180196 Industrial control equipment for hazardous locations Class I, Division 2, Groups ABCD, T4 ¹⁾							
DNV GL	Temperature: B (0 - 55°C) Humidity: B (up to 100%) Vibration: A (0.7 g) EMC: B (Bridge and open deck) ²⁾							
GOST-R	-	Yes						
Cable construction								
Wire cross section	28 AWG				24 AWG			
Shield	Individual cable pairs, entire cable							
Complete shielding	Tinned copper braiding, optical coverage >85%							
Outer sheathing								
Material	PVC							
Color	Black							
Labeling	E74020-C (UL) AWM STYLE 20176 80°C 30 V VW-1 DVI DIGITAL LINK							
Connector								
Type	2x DVI-D (24+1), male							
Connection cycles	100							
Contacts	Gold-plated							
Mechanical protection	Metal cover with crimped strain relief							
Locating screw tightening torque	Max. 0.5 Nm							
Electrical characteristics								
Conductor resistance								
24 AWG	-				≤93 Ω/km			
28 AWG	≤237 Ω/km				-			

Table 123: 5CASDL.0008-00, 5CASDL.0018-00, 5CASDL.0050-00, 5CASDL.0100-00, 5CASDL.0150-00, 5CASDL.0200-00, 5CASDL.0250-00, 5CASDL.0300-00 - Technical data

Model number	5CASDL.0008-00	5CASDL.0018-00	5CASDL.0050-00	5CASDL.0100-00	5CASDL.0150-00	5CASDL.0200-00	5CASDL.0250-00	5CASDL.0300-00
Insulation resistance	Min. 10 MΩ/km							
Operating conditions								
EN 61131 pollution degree	Pollution degree 2							
Mechanical characteristics								
Dimensions								
Length	0.8 m ±25 mm	1.8 m ±30 mm	5 m ±30 mm	10 m ±50 mm	15 m ±100 mm	20 m ±100 mm	25 m ±100 mm	30 m ±100 mm
Diameter	Typ. 8.6 ±0.2 mm Max. 9 mm			Typ. 11 ±0.2 mm Max. 11.5 mm				
Bend radius	≥5x cable diameter (male connector - ferrite bead and ferrite bead - ferrite bead)							
Flexibility	Limited flexibility, valid for ferrite bead - ferrite bead (tested 100 cycles with 5x cable diameter, 20 cycles/minute)							
Weight	Approx. 206 g	Approx. 300 g	Approx. 580 g	Approx. 1500 g	Approx. 2250 g	Approx. 2880 g	Approx. 4800 g	Approx. 5520 g

Table 123: 5CASDL.0008-00, 5CASDL.0018-00, 5CASDL.0050-00, 5CASDL.0100-00, 5CASDL.0150-00, 5CASDL.0200-00, 5CASDL.0250-00, 5CASDL.0300-00 - Technical data

- 1) Yes, although applies only if all components installed in the complete system have this certification and the complete system bears the corresponding mark.
- 2) Yes, although applies only if all components installed in the complete system have this certification and are listed on the associated DNV GL certificate for the product family.

3.2.1.4 Bend radius specifications

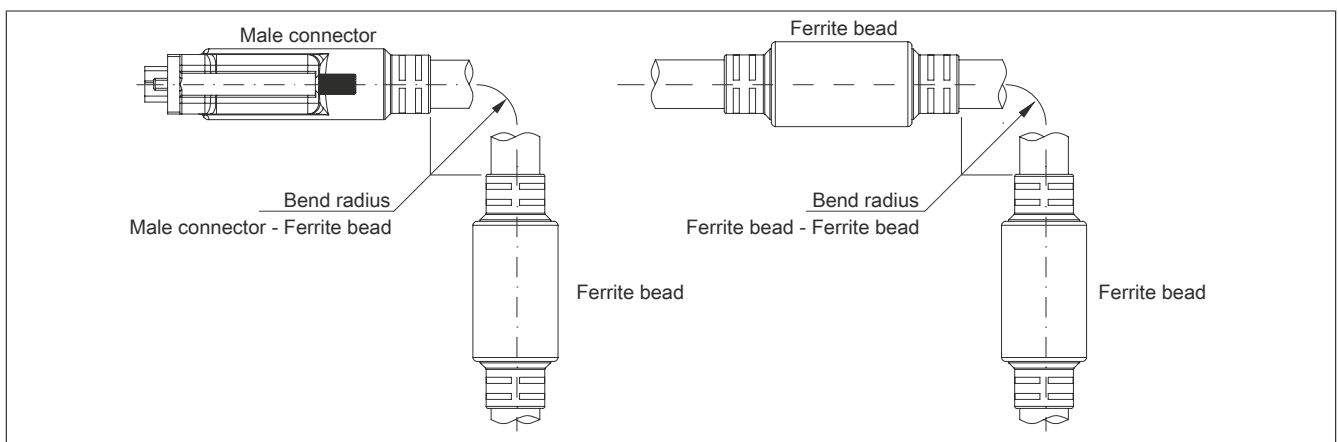

Figure 103: Bend radius specifications

3.2.1.5 Dimensions

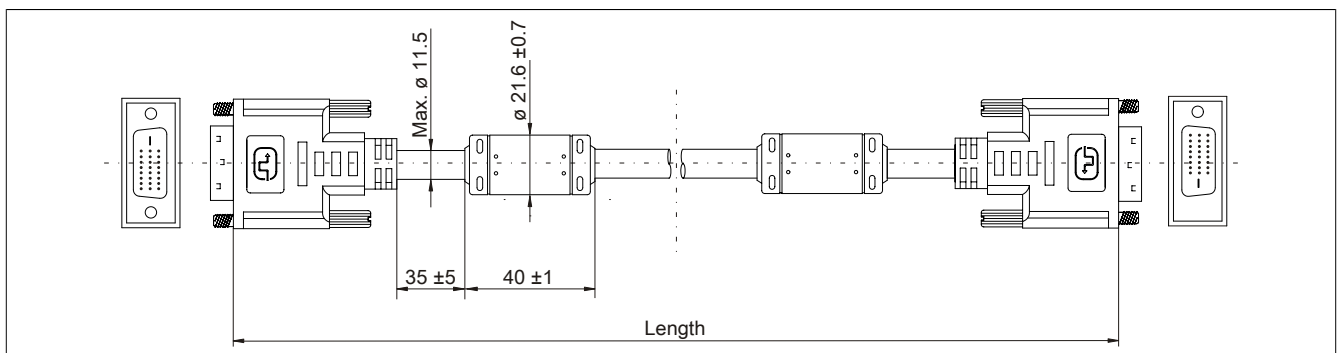

Figure 104: 5CASDL.0xxx-00 - Dimensions

3.2.1.6 Cable pinout

Warning!

If a field-assembled cable is desired, it must be wired according to this pinout.

If a field-assembled cable is used, B&R cannot make any guarantee as to its functionality. Functionality is only ensured with cables provided by B&R.

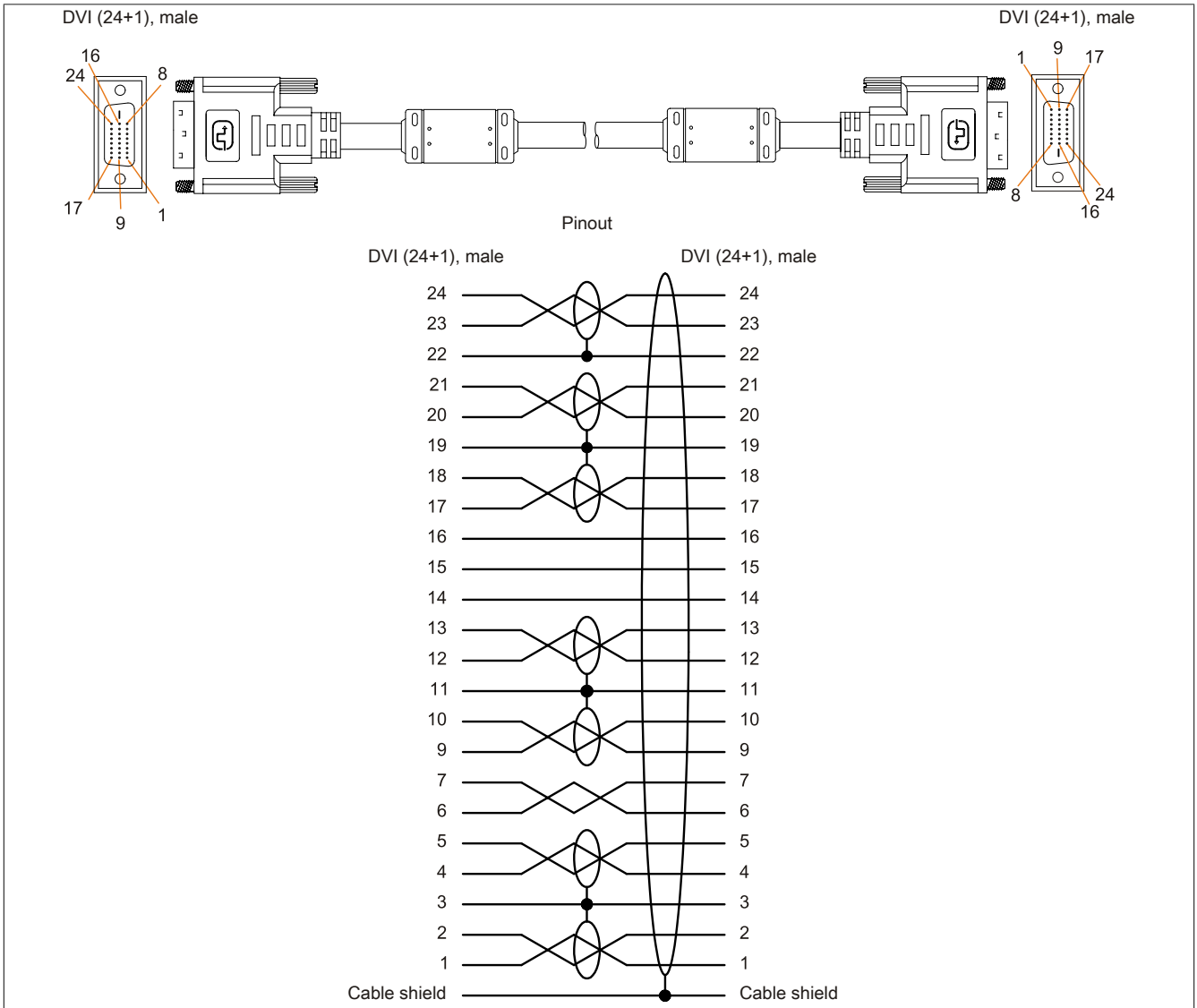

Figure 105: 5CASDL.0xxx-00 - Pinout

3.3 SDL cables with 45° male connector

3.3.1 5CASDL.0xxx-01

3.3.1.1 General information

5CASDL.0xxx-01 SDL cables with 45° connector are designed for use in fixed installations.

Caution!

The cable is only permitted to be connected or disconnected when the power is switched off.

3.3.1.2 Order data

Model number	Short description	Figure
	SDL cables 45° connection	
5CASDL.0018-01	SDL cable - 45 degree connector - 1.8 m	
5CASDL.0050-01	SDL cable - 45 degree connector - 5 m	
5CASDL.0100-01	SDL cable - 45 degree connector - 10 m	
5CASDL.0150-01	SDL cable - 45 degree connector - 15 m	

Table 124: 5CASDL.0018-01, 5CASDL.0050-01, 5CASDL.0100-01, 5CASDL.0150-01 - Order data

3.3.1.3 Technical data

Information:

The following specifications, properties and limit values apply only to this accessory and may deviate from those that apply to the complete system. For the complete system in which this accessory is installed, for example, the data specified for that complete system applies.

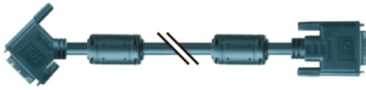
Model number	5CASDL.0018-01	5CASDL.0050-01	5CASDL.0100-01	5CASDL.0150-01
General information				
Certifications				
CE	Yes			
UL	cULus E115267 Industrial control equipment			
HazLoc	cULus HazLoc E180196 Industrial control equipment for hazardous locations			
DNV GL	Class I, Division 2, Groups ABCD, T4 ¹⁾ Temperature: B (0 - 55°C) Humidity: B (up to 100%) Vibration: A (0.7 g) EMC: B (Bridge and open deck) ²⁾			
GOST-R	Yes			
Cable construction				
Wire cross section	28 AWG		24 AWG	
Shield	Individual cable pairs, entire cable			
Complete shielding	Tinned copper braiding, optical coverage >85%			
Outer jacket				
Material	PVC			
Color	Black			
Connector				
Type	2x DVI-D (24+1), male			
Connection cycles	100			
Contacts	Gold-plated			
Mechanical protection	Metal cover with crimped strain relief			
Locating screw tightening torque	Max. 0.5 Nm			
Electrical characteristics				
Conductor resistance				
24 AWG	-		≤93 Ω/km	
28 AWG	≤237 Ω/km		-	
Insulation resistance	Min. 10 MΩ/km			
Operating conditions				
Pollution degree per EN 61131	Pollution degree 2			
Mechanical characteristics				
Dimensions				
Length	1.8 m ±30 mm	5 m ±50 mm	10 m ±100 mm	15 m ±100 mm
Diameter	Max. 9 mm		Max. 11.5 mm	

Table 125: 5CASDL.0018-01, 5CASDL.0050-01, 5CASDL.0100-01, 5CASDL.0150-01 - Technical data

Model number	5CASDL.0018-01	5CASDL.0050-01	5CASDL.0100-01	5CASDL.0150-01
Bend radius	$\geq 5 \times$ cable diameter (male connector - ferrite bead and ferrite bead - ferrite bead)			
Fixed installation	$\geq 5 \times$ cable diameter (male connector - ferrite bead and ferrite bead - ferrite bead)			
Flexibility	Limited flexibility, valid for ferrite bead - ferrite bead (tested 100 cycles with 5x cable diameter, 20 cycles/minute)			
Weight	Approx. 300 g	Approx. 590 g	Approx. 2800 g	Approx. 2860 g

Table 125: 5CASDL.0018-01, 5CASDL.0050-01, 5CASDL.0100-01, 5CASDL.0150-01 - Technical data

- 1) Yes, although applies only if all components installed in the complete system have this certification and the complete system bears the corresponding mark.
- 2) Yes, although applies only if all components installed in the complete system have this certification and are listed on the associated DNV GL certificate for the product family.

3.3.1.4 Bend radius specifications

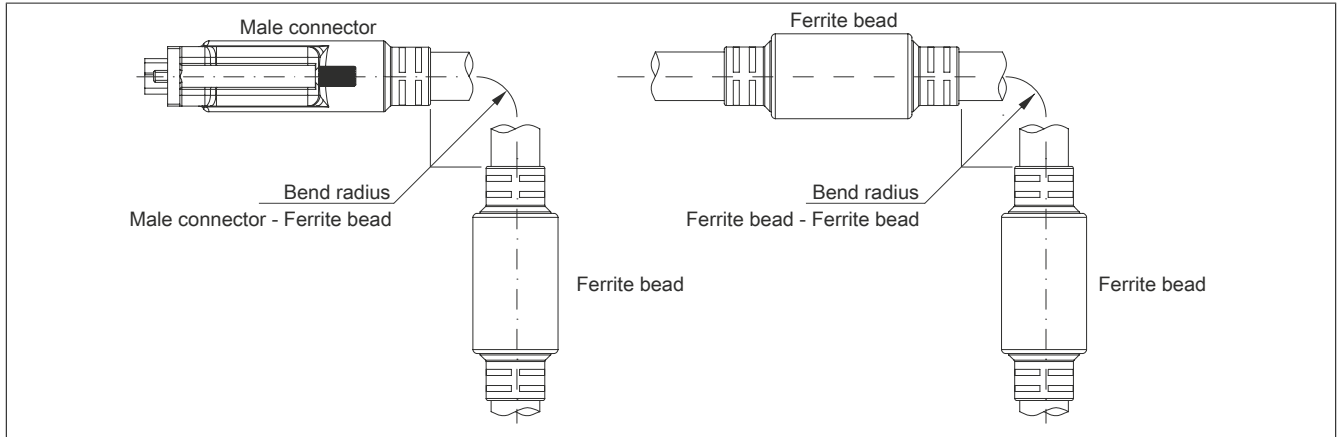

Figure 106: Bend radius specifications

3.3.1.5 Dimensions

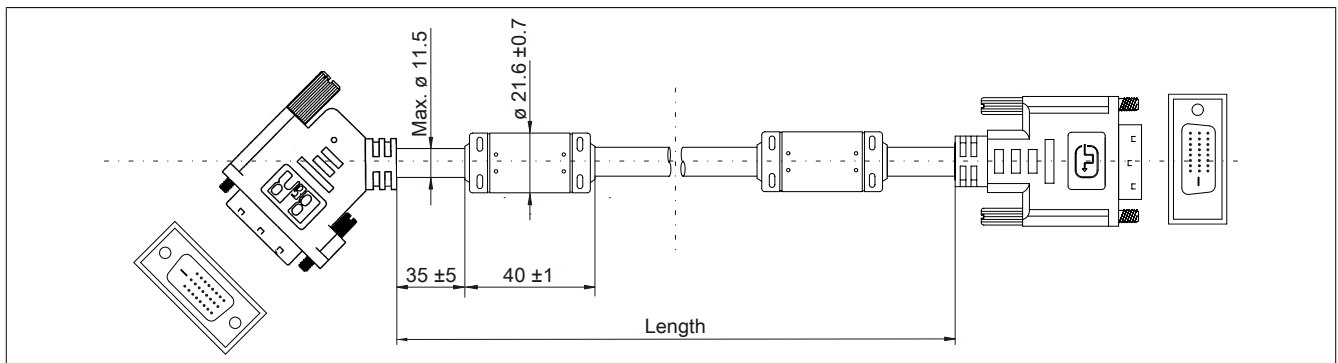

Figure 107: 5CASDL.0xxx-01 - Dimensions

3.3.1.6 Cable pinout

Warning!

If a field-assembled cable is desired, it must be wired according to this pinout.

If a field-assembled cable is used, B&R cannot make any guarantee as to its functionality. Functionality is only ensured with cables provided by B&R.

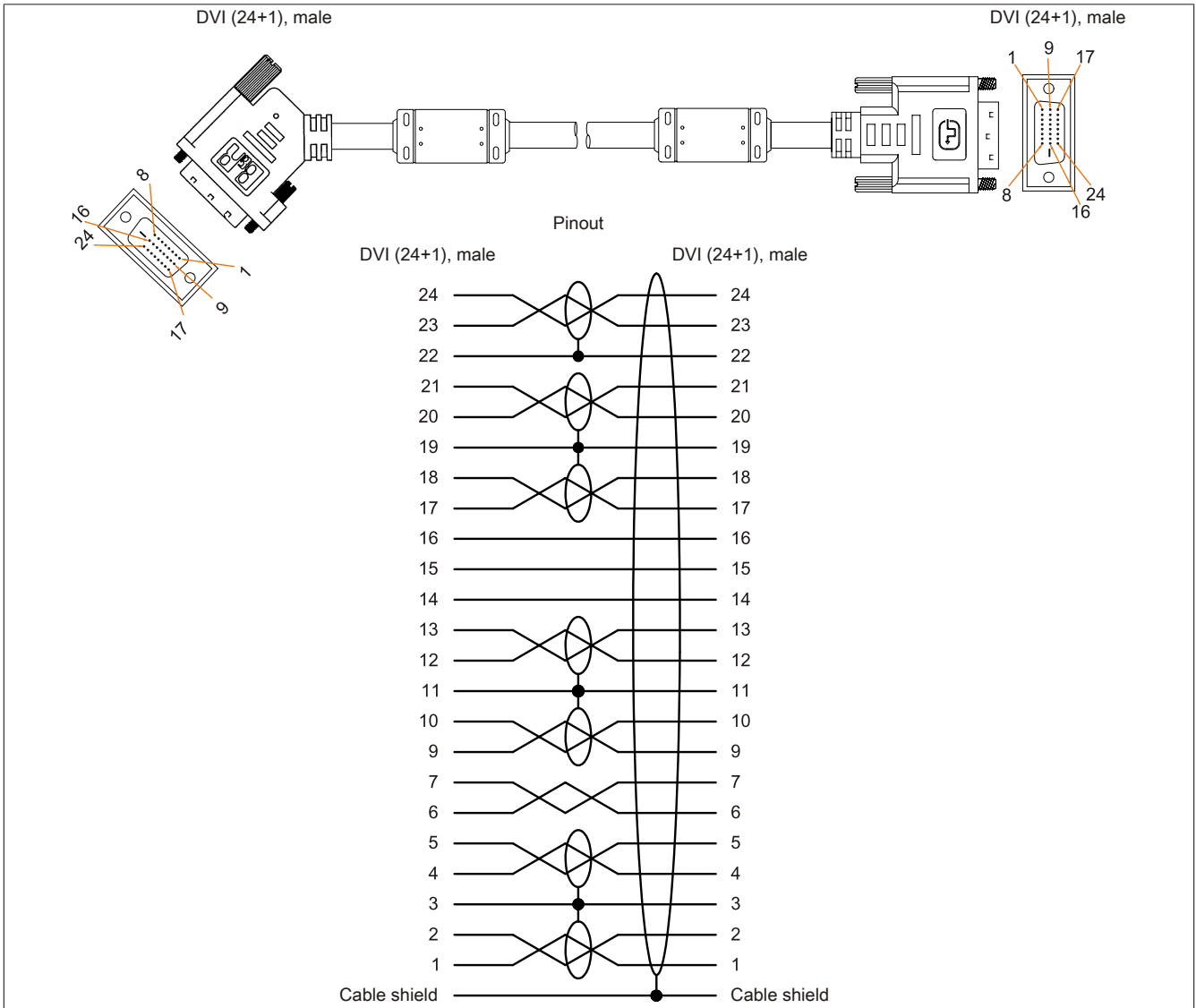

Figure 108: 5CASDL.0xxx-01 - Pinout

3.4 SDL flex cables

3.4.1 5CASDL.0xxx-03

3.4.1.1 General information

5CASDL.0xxx-03 SDL flex cables are designed for use in both fixed and flexible installations (e.g. swing arm systems).

Caution!

The cable is only permitted to be connected or disconnected when the power is switched off.

3.4.1.2 Order data

Model number	Short description	Figure
	SDL cables flex	
5CASDL.0018-03	SDL flex cable - 1.8 m	
5CASDL.0050-03	SDL flex cable - 5 m	
5CASDL.0100-03	SDL flex cable - 10 m	
5CASDL.0150-03	SDL flex cable - 15 m	
5CASDL.0200-03	SDL flex cable - 20 m	
5CASDL.0250-03	SDL flex cable - 25 m	
5CASDL.0300-03	SDL flex cable - 30 m	

Table 126: 5CASDL.0018-03, 5CASDL.0050-03, 5CASDL.0100-03, 5CASDL.0150-03, 5CASDL.0200-03, 5CASDL.0250-03, 5CASDL.0300-03 - Order data

3.4.1.3 Technical data

Information:

The following specifications, properties and limit values apply only to this accessory and may deviate from those that apply to the complete system. For the complete system in which this accessory is installed, for example, the data specified for that complete system applies.

Model number	5CASDL.0018-03	5CASDL.0050-03	5CASDL.0100-03	5CASDL.0150-03	5CASDL.0200-03	5CASDL.0250-03	5CASDL.0300-03
General information							
Certifications							
CE	Yes						
UL	cULus E115267 Industrial control equipment						
HazLoc	cULus HazLoc E180196 Industrial control equipment for hazardous locations Class I, Division 2, Groups ABCD, T4 ¹⁾						
DNV GL	Temperature: B (0 - 55°C) Humidity: B (up to 100%) Vibration: A (0.7 g) EMC: B (Bridge and open deck) ²⁾						
GOST-R	Yes						
Cable construction							
Wire cross section	24 AWG (control wires) 26 AWG (DVI, USB, data)						
Properties	Silicone- and halogen-free						
Shield	Individual cable pairs, entire cable						
Complete shielding	Aluminum-clad foil and tinned copper braiding						
Outer jacket							
Material	Special semi-matte TMPU						
Color	Black						
Labeling	(B&R) SDL cable (UL) AWM 20236 80°C 30 V E 63216						
Connector							
Type	2x DVI-D (24+1), male						
Connection cycles	Min. 200						
Contacts	Gold-plated						
Mechanical protection	Metal cover with crimped strain relief						
Locating screw tightening torque	Max. 0.5 Nm						
Electrical characteristics							
Operating voltage	≤30 V						

Table 127: 5CASDL.0018-03, 5CASDL.0050-03, 5CASDL.0100-03, 5CASDL.0150-03, 5CASDL.0200-03, 5CASDL.0250-03, 5CASDL.0300-03 - Technical data

Model number	5CASDL.0018-03	5CASDL.0050-03	5CASDL.0100-03	5CASDL.0150-03	5CASDL.0200-03	5CASDL.0250-03	5CASDL.0300-03
Test voltage							
Wire/Wire	1 kV						
Wire/Shield	0.5 kV						
Wave impedance	100 ±10 Ω						
Conductor resistance							
24 AWG	≤95 Ω/km						
26 AWG	≤145 Ω/km						
Insulation resistance	>200 MΩ/km						
Operating conditions							
Pollution degree per EN 61131	Pollution degree 2						
Approbation	UL AWM 20236 80°C 30 V						
Flame-retardant	Per UL 758 (cable vertical flame test)						
Oil and hydrolysis resistance	Per VDE 0282-10						
Environmental conditions							
Temperature							
Storage	-20 to 80°C						
Fixed installation	-20 to 80°C						
Flexible installation	-5 to 60°C						
Mechanical characteristics							
Dimensions							
Length	1.8 m ±20 mm	5 m ±45 mm	10 m ±90 mm	15 m ±135 mm	20 m ±180 mm	25 m ±225 mm	30 m ±270 mm
Diameter	Max. 12 mm						
Bend radius							
Fixed installation	≥3.5x cable diameter						
Flexible installation	≥15x cable diameter (ferrite bead - ferrite bead)						
Flexibility	Flexible, applies to ferrite bead - ferrite bead (tested 300000 cycles with 15x cable diameter, 4800 cycles/hour)						
Drag chain data							
Flex cycles	300,000						
Speed	4800 cycles/hour						
Bend radius	180 mm, 15x cable diameter						
Hub	460 mm						
Weight	Approx. 460 g	Approx. 1020 g	Approx. 1940 g	Approx. 2840 g	Approx. 3740 g	Approx. 4560 g	Approx. 5590 g
Tension							
During operation	≤50 N						
During installation	≤400 N						

Table 127: 5CASDL.0018-03, 5CASDL.0050-03, 5CASDL.0100-03, 5CASDL.0150-03, 5CASDL.0200-03, 5CASDL.0250-03, 5CASDL.0300-03 - Technical data

- 1) Yes, although applies only if all components installed in the complete system have this certification and the complete system bears the corresponding mark.
- 2) Yes, although applies only if all components installed in the complete system have this certification and are listed on the associated DNV GL certificate for the product family.

3.4.1.4 Bend radius specifications

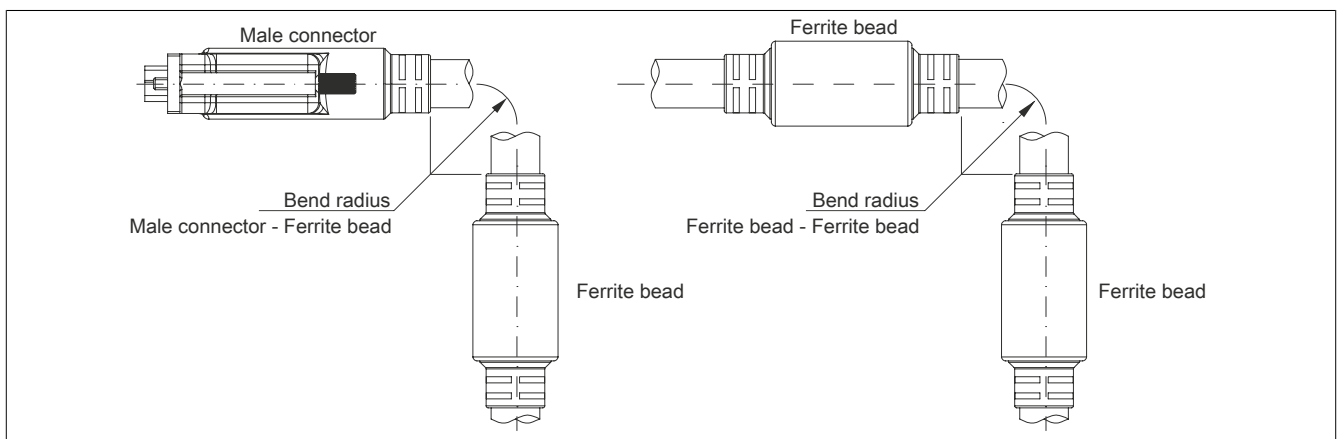

Figure 109: Bend radius specifications

3.4.1.5 Dimensions

All dimensions are specified in mm.

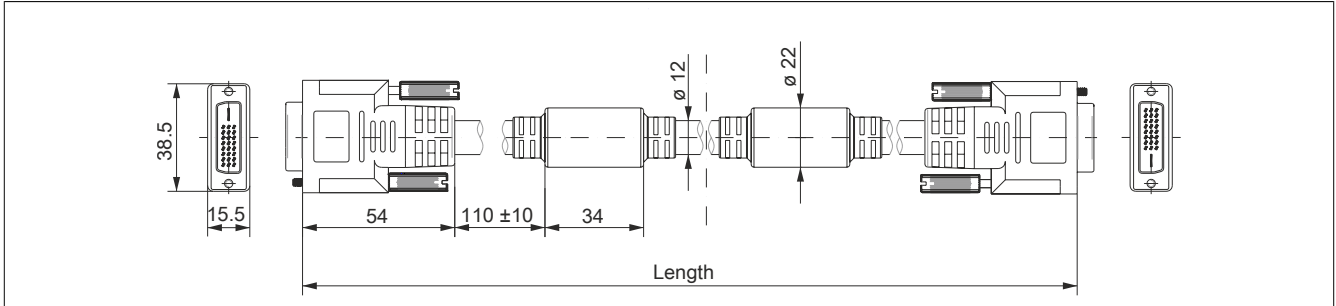

Figure 110: 5CASDL.0xxx-03 ≥Rev. E0 - Dimensions

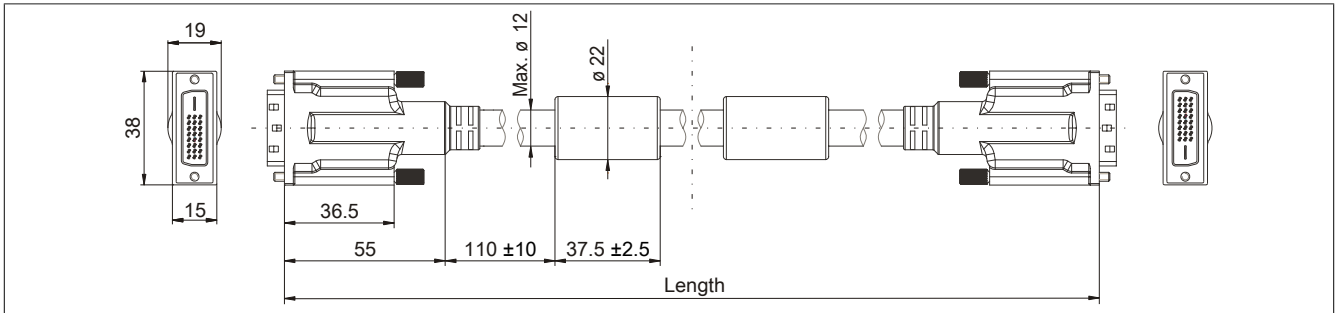

Figure 111: 5CASDL.0xxx-03 ≤Rev. D0 - Dimensions

3.4.1.6 Construction

Element	Assignment	Cross section	
DVI	TMDS data 0	26 AWG	
	TMDS data 1	26 AWG	
	TMDS data 2	26 AWG	
	TMDS cycle	26 AWG	
USB	XUSB0	26 AWG	
	XUSB1	26 AWG	
Data	SDL	26 AWG	
Control wires	DDC cycle	24 AWG	
	DDC data	24 AWG	
	+5 V	24 AWG	
	Ground	24 AWG	
	Hot plug detect	24 AWG	

Table 128: 5CASDL.0xxx-03 SDL flex cables - Construction

3.4.1.7 Cable pinout

Warning!

If a field-assembled cable is desired, it must be wired according to this pinout.

If a field-assembled cable is used, B&R cannot make any guarantee as to its functionality. Functionality is only ensured with cables provided by B&R.

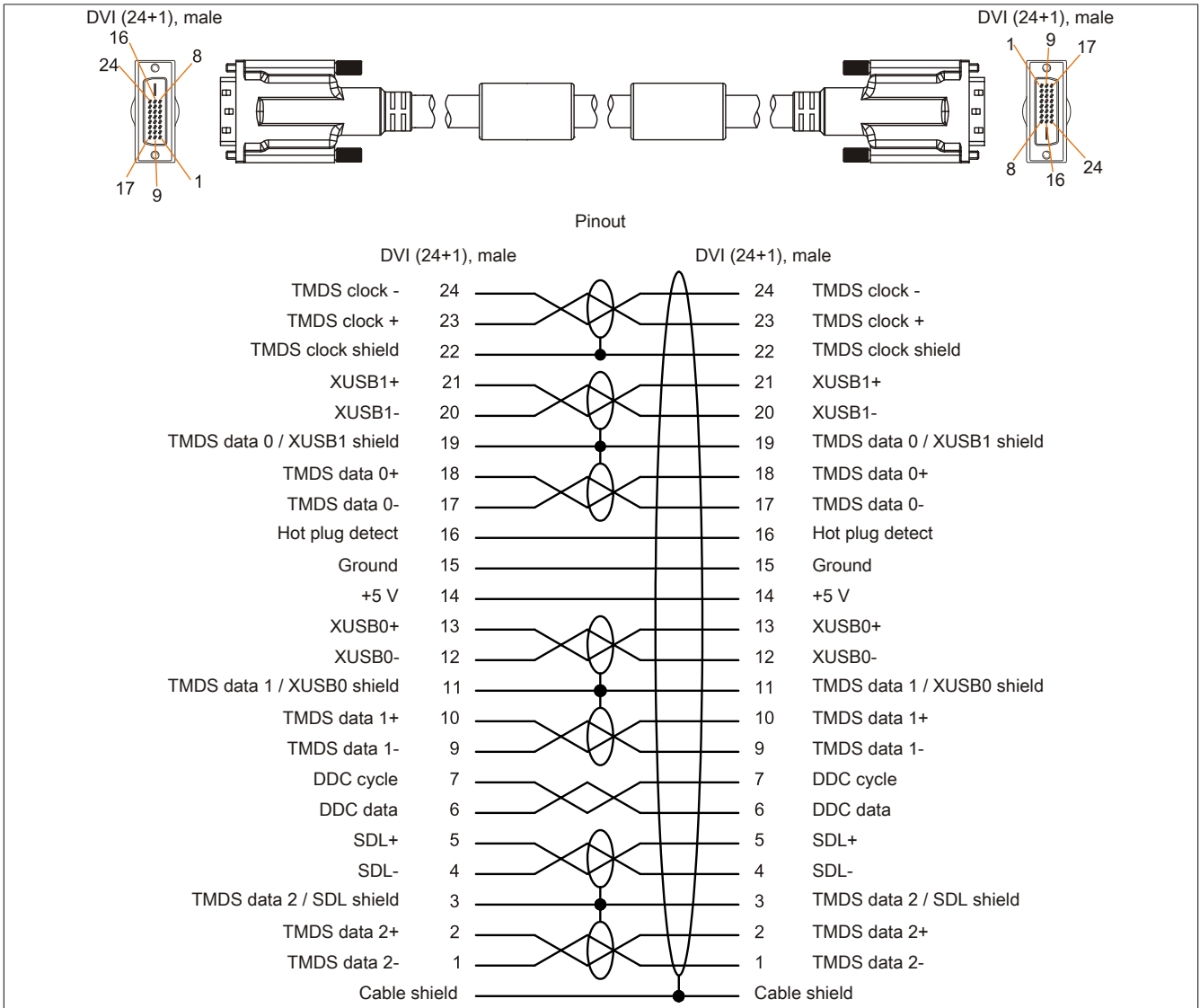

Figure 112: 5CASDL.0xxx-03 - Pinout

3.5 SDL3/SDL4 cables

3.5.1 5CASD3.xxxx-00

3.5.1.1 General information

5CASD3.xxxx-00 SDL3/SDL4 cables are designed to transfer SDL3/SDL4 data and simplify cable installation. The RJ45 connector allows these cables to be connected in very narrow spaces, for example in swing arm shafts.

Caution!

The cable is only permitted to be connected or disconnected when the power is switched off.

3.5.1.2 Order data

Model number	Short description	Figure
	SDL3/SDL4 cables	
5CASD3.0030-00	SDL3/SDL4 cable - 3 m	
5CASD3.0050-00	SDL3/SDL4 cable - 5 m	
5CASD3.0100-00	SDL3/SDL4 cable - 10 m	
5CASD3.0150-00	SDL3/SDL4 cable - 15 m	
5CASD3.0200-00	SDL3/SDL4 cable - 20 m	
5CASD3.0300-00	SDL3/SDL4 cable - 30 m	
5CASD3.0500-00	SDL3/SDL4 cable - 50 m	
5CASD3.1000-00	SDL3/SDL4 cable - 100 m	

Table 129: 5CASD3.0030-00, 5CASD3.0050-00, 5CASD3.0100-00, 5CASD3.0150-00, 5CASD3.0200-00, 5CASD3.0300-00, 5CASD3.0500-00, 5CASD3.1000-00 - Order data

3.5.1.3 Technical data

Information:

The following specifications, properties and limit values apply only to this accessory and may deviate from those that apply to the complete system. For the complete system in which this accessory is installed, for example, the data specified for that complete system applies.

Model number	5CASD3.0030-00	5CASD3.0050-00	5CASD3.0100-00	5CASD3.0150-00	5CASD3.0200-00	5CASD3.0300-00	5CASD3.0500-00	5CASD3.1000-00	
General information									
Certifications	Yes								
CE	Yes								
UL	cULus E115267 Industrial control equipment								
HazLoc	cULus HazLoc E180196 Industrial control equipment for hazardous locations Class I, Division 2, Groups ABCD, T4 ¹⁾			cULus HazLoc E180196 Industrial control equipment for hazardous locations Class I, Division 2, Groups ABCD, T4 ²⁾		cULus HazLoc E180196 Industrial control equipment for hazardous locations Class I, Division 2, Groups ABCD, T4 ¹⁾		cULus HazLoc E180196 Industrial control equipment for hazardous locations Class I, Division 2, Groups ABCD, T4 ²⁾	
Cable construction									
Wire cross section	4x 2x 26/7 AWG				4x 2x 23/1 AWG				
Properties	Flame-resistant, halogen-free, lead-free			Flame-retardant, halogen-free, lead-free		Flame-resistant, halogen-free, lead-free		Flame-retardant, halogen-free, lead-free	

Table 130: 5CASD3.0030-00, 5CASD3.0050-00, 5CASD3.0100-00, 5CASD3.0150-00, 5CASD3.0200-00, 5CASD3.0300-00, 5CASD3.0500-00, 5CASD3.1000-00 - Technical data

Model number	5CASD3.0030-00	5CASD3.0050-00	5CASD3.0100-00	5CASD3.0150-00	5CASD3.0200-00	5CASD3.0300-00	5CASD3.0500-00	5CASD3.1000-00		
Outer jacket										
Material	Polyurethane (PUR)									
Color	Yellow, RAL 1021									
Labeling	HARTING INDUSTRIAL CABLE S/ FTP CAT 6A PUR 4x 2x 26/7 AWG				HARTING INDUSTRIAL CABLE S/ FTP CAT 6A PUR 4x2x-AWG26/7		HARTING INDUSTRIAL INSTALLATION CABLE S/FTP CAT 7 PUR 4x 2x 23/1 AWG		HARTING INDUSTRIAL INSTALLATION CABLE S/ FTP CAT 7 PUR 4x2x-AWG23/1	
Lines										
Wire insulation	Polyethylene (PE)									
Wire colors	Green/White-green, orange/white-orange, blue/white-blue, brown/white-brown									
Shield	Aluminum foil and braided wire shield made of tinned copper wires									
Type	Unprotected copper wire, 4x 2x 26/7 AWG				Unprotected copper wire, 4x 2x 23/1 AWG					
Connector										
Type	2x RJ45, male									
Connection cycles	Min. 750									
Contacts	8									
Electrical characteristics ³⁾										
Operating voltage	≤100 V				≤125 V					
Conductor resistance	≤290 Ω/km				≤75 Ω/km					
Wave impedance	100 ±5 Ω (at 100 MHz)									
Transfer properties	Category 6A / Class EA up to 500 MHz in accordance with ISO/IEC 11801 (EN 50173-1), ISO/IEC 24702 (EN 50173-3)				Category 6A / Class EA up to 500 MHz per ISO/IEC 11801 (EN 50173-1), ISO/IEC 24702 (EN 50173-3)		Category 7 / Class F up to 600 MHz in accordance with ISO/IEC 11801 (EN 50173-1), ISO/IEC 24702 (EN 50173-3)		Category 7 / Class F up to 600 MHz per ISO/IEC 11801 (EN 50173-1), ISO/IEC 24702 (EN 50173-3)	
Insulation resistance	≥500 MΩ/km				≥5 GΩ/km					
Operating conditions										
Pollution degree per EN 61131-2	Pollution degree 2									
Flame-retardant	IEC 60332-1-2									
Oil and hydrolysis resistance	EN 60811-2-1 (90°C / 7x24 h)									
Degree of protection per EN 60529										
Cables	IP20									
RJ45 connector	IP20, only when connected properly				IP20, only when properly connected		IP20, only when connected properly		IP20, only when properly connected	
Environmental conditions										
Temperature										
Storage	-40 to 70°C									
Fixed installation	-40 to 70°C									
Flexible installation	-40 to 70°C				-10 to 50°C					
Mechanical characteristics										
Dimensions										
Length	3 m	5 m	10 m	15 m	20 m	30 m	50 m	100 m		
Diameter	6.7 mm				8.3 mm					
Bend radius										
Fixed installation	≥5x diameter				≥4x diameter					
Flexible installation	≥10x diameter				≥8x diameter					
Weight	250 g		500 g	700 g	950 g	2150 g	3500 g	6950 g		
Tension										
During operation	≤70 N				≤110 N					
During installation	≤70 N				≤110 N					

Table 130: 5CASD3.0030-00, 5CASD3.0050-00, 5CASD3.0100-00, 5CASD3.0150-00, 5CASD3.0200-00, 5CASD3.0300-00, 5CASD3.0500-00, 5CASD3.1000-00 - Technical data

- 1) Yes, although applies only if all components installed within the complete system have this certification and the complete system itself carries the corresponding mark.
- 2) Yes, although applies only if all components installed in the complete system have this certification and the complete system bears the corresponding mark.
- 3) At an ambient temperature of 20°C.

3.5.1.4 Bend radius specifications

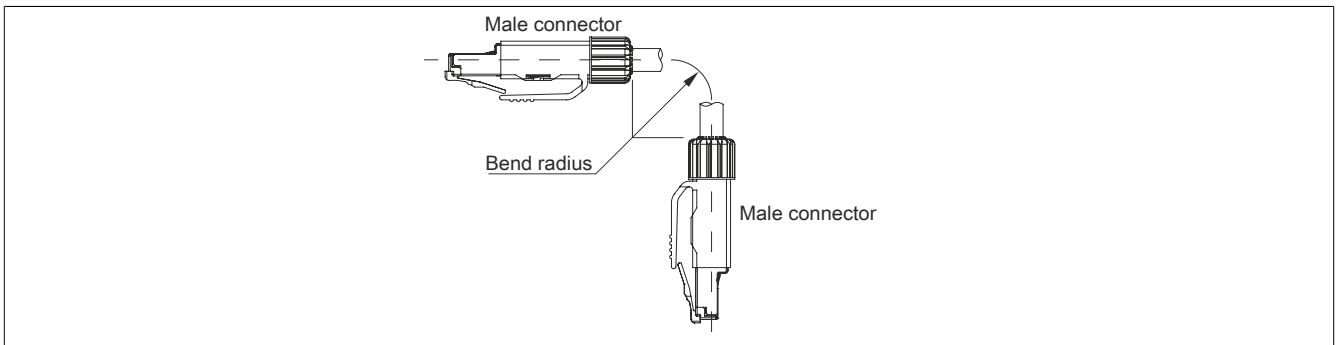

Figure 113: SDL3/SDL4 bending radius specification

3.5.1.5 Dimensions

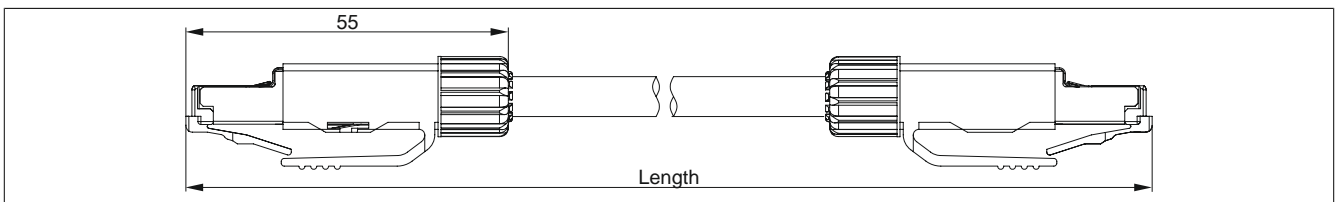

Figure 114: 5CASD3.xxxx-00 - Dimensions

3.5.1.6 Cable pinout

Warning!

If a field-assembled cable is desired, it must be wired according to this pinout.

If a field-assembled cable is used, B&R cannot make any guarantee as to its functionality. Functionality is only ensured with cables provided by B&R.

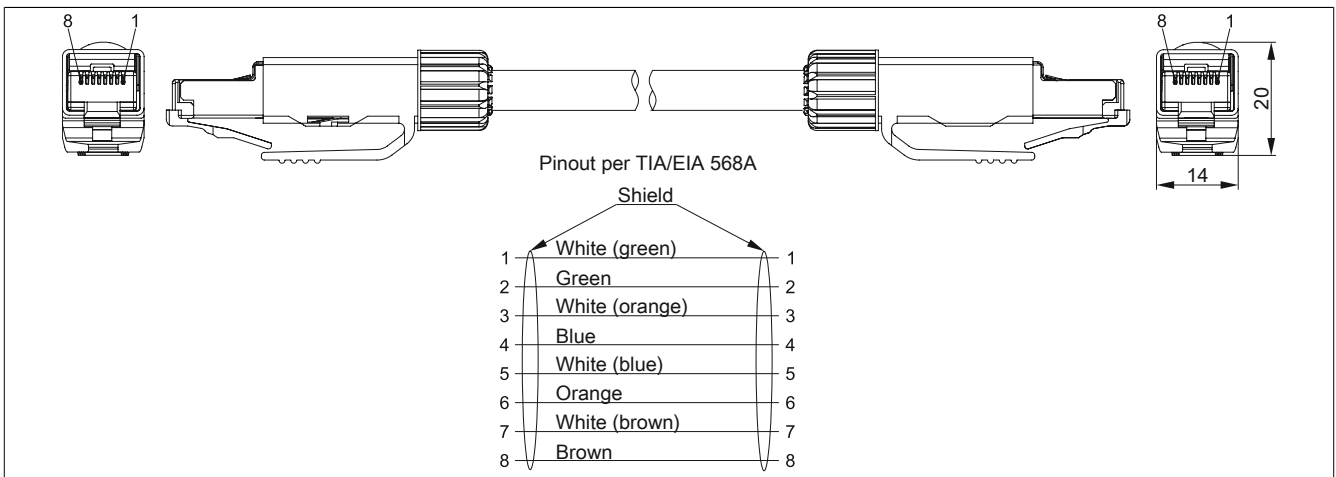

Figure 115: 5CASD3.xxxx-00 - Pinout

3.5.1.7 Wiring

The following information and figure apply when using a field-assembled cable that is not directly connected to a B&R device, but to an RJ45 network interface (e.g. patch panel).

Wiring must meet category 6a (Cat 6a) or category 7 (Cat 7) requirements. Exceeding the maximum total length of 100 m is not permitted.

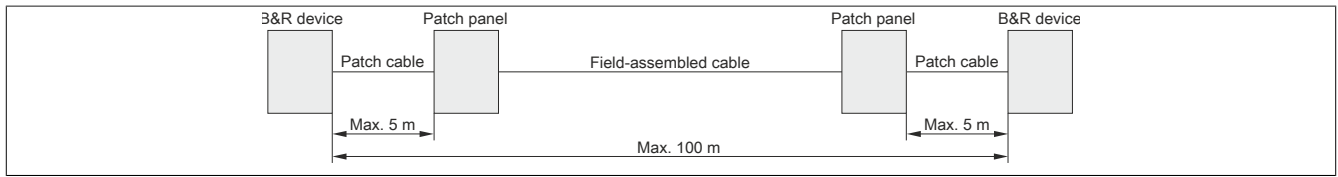

Figure 116: Wiring with a field-assembled cable

3.6 USB cables

3.6.1 5CAUSB.00xx-00

3.6.1.1 General information

USB cables are designed for a USB 2.0 transfer rate.

3.6.1.2 Order data

Model number	Short description	Figure
	USB cables	
5CAUSB.0018-00	USB 2.0 connection cable - Type A - type B connector - 1.8 m	
5CAUSB.0050-00	USB 2.0 connection cable - Type A - type B connector - 5 m	

Table 131: 5CAUSB.0018-00, 5CAUSB.0050-00 - Order data

3.6.1.3 Technical data

Information:

The following specifications, properties and limit values apply only to this accessory and may deviate from those that apply to the complete system. For the complete system in which this accessory is installed, for example, the data specified for that complete system applies.

Model number	5CAUSB.0018-00	5CAUSB.0050-00
General information		
Certifications		
CE	Yes	
UL	cULus E115267 Industrial control equipment	
DNV GL	Temperature: B (0 - 55°C) Humidity: B (up to 100%) Vibration: A (0.7 g) EMC: B (Bridge and open deck) ¹⁾	
GOST-R	Yes	
Cable construction		
Wire cross section	24, 28 AWG	
Shield	Entire cable	
Outer jacket		
Color	Beige	
Connector		
Type	USB type A male and USB type B male	
Operating conditions		
Pollution degree per EN 61131	Pollution degree 2	
Mechanical characteristics		
Dimensions		
Length	1.8 m ±30 mm	5 m ±50 mm
Diameter	Max. 5 mm	
Bend radius	Min. 100 mm	

Table 132: 5CAUSB.0018-00, 5CAUSB.0050-00 - Technical data

1) Yes, although applies only if all components installed in the complete system have this certification and are listed on the associated DNV GL certificate for the product family.

3.6.1.4 Cable pinout

Warning!

If a field-assembled cable is desired, it must be wired according to this pinout.

If a field-assembled cable is used, B&R cannot make any guarantee as to its functionality. Functionality is only ensured with cables provided by B&R.

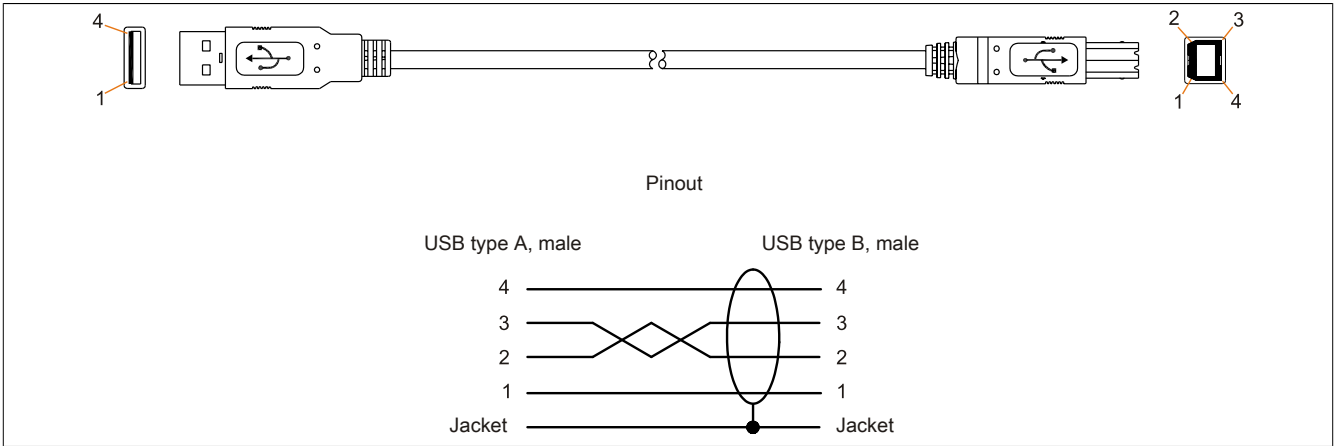

Figure 117: 5CAUSB.00xx-00 USB cables - Pinout

3.7 RS232 cables

3.7.1 9A0014.xx

3.7.1.1 General information

RS232 cables are used as extension cables between two RS232 interfaces.

3.7.1.2 Order data

Model number	Short description	Figure
	RS232 cables	
9A0014.02	RS232 extension cable for operation of a remote display unit with touch screen, 1.8 m	
9A0014.05	RS232 extension cable for operation of a remote display unit with touch screen, 5 m	
9A0014.10	RS232 extension cable for operation of a remote display unit with touch screen, 10 m	

Table 133: 9A0014.02, 9A0014.05, 9A0014.10 - Order data

3.7.1.3 Technical data

Information:

The following specifications, properties and limit values apply only to this accessory and may deviate from those that apply to the complete system. For the complete system in which this accessory is installed, for example, the data specified for that complete system applies.

Model number	9A0014.02	9A0014.05	9A0014.10
General information			
Certification		Yes	
CE		Yes	
GOST-R	-		Yes
Cable construction			
Wire cross section		26 AWG	
Shield		Entire cable	
Outer sheathing			
Color		Beige	
Connector			
Type		9-pin DSUB connector, male/female	
Locating screw tightening torque		Max. 0.5 Nm	
Operating conditions			
EN 61131 pollution degree		Pollution degree 2	
Mechanical characteristics			
Dimensions			
Length	1.8 m ±50 mm	5 m ±80 mm	10 m ±100 mm
Diameter		Max. 5 mm	
Bend radius		Min. 70 mm	

Table 134: 9A0014.02, 9A0014.05, 9A0014.10 - Technical data

3.7.1.4 Cable pinout

Warning!

If a field-assembled cable is desired, it must be wired according to this pinout.

If a field-assembled cable is used, B&R cannot make any guarantee as to its functionality. Functionality is only ensured with cables provided by B&R.

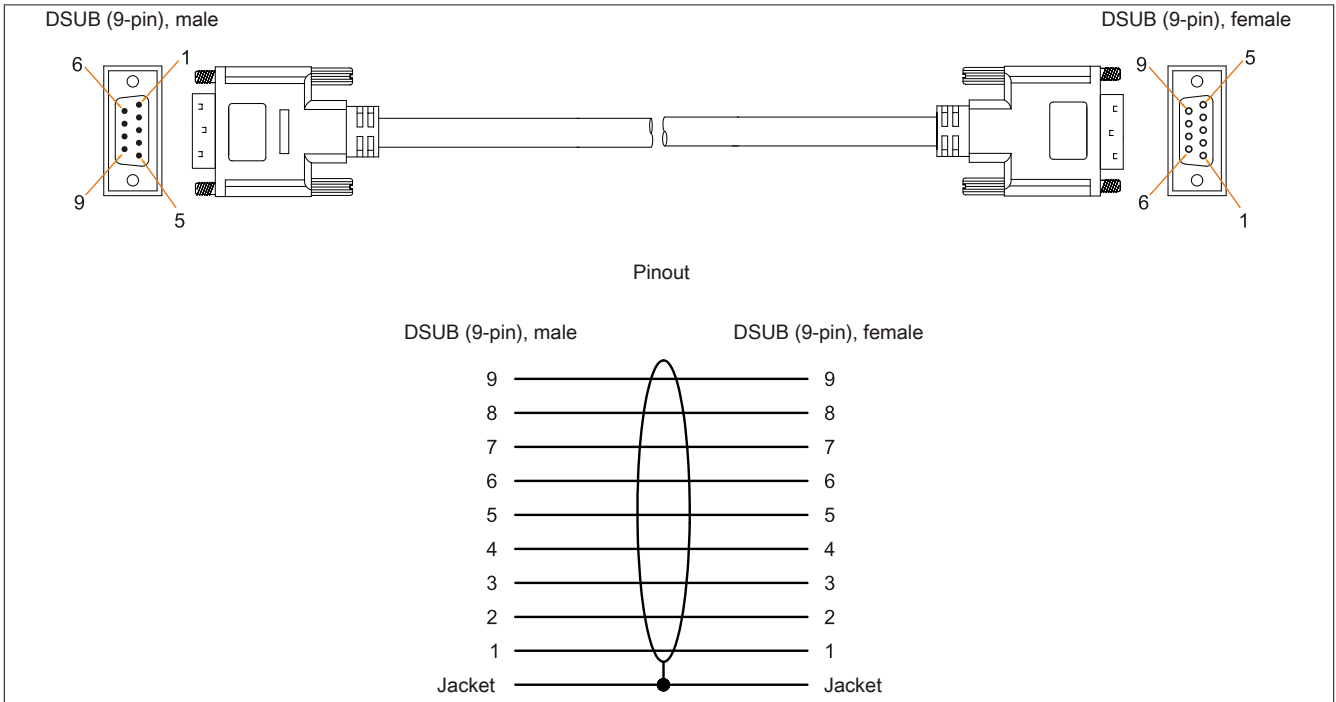

Figure 118: 9A0014.xx RS232 cables - Pinout

Chapter 7 • Servicing and maintenance

This chapter describes the servicing/maintenance work that is possible to be carried out by a trained and qualified end user.

Information:

Only components approved by B&R are permitted to be used for maintenance and repair work.

1 Cleaning

Danger!

The device is only permitted to be cleaned when power is switched off in order to prevent unintended functions from being triggered by touching the touch screen or pressing keys.

Use a moist cloth to clean the device. Only use water with detergent, a screen cleaning agent or alcohol (ethanol) to moisten the cleaning cloth. Apply the cleaning agent to the cloth beforehand; do not spray it directly on the device! Never use aggressive solvents, chemicals, scouring agents, pressurized air or steam-jet air ejectors.

Information:

Displays with a touch screen should be cleaned at regular intervals.

2 Tips for extending the service life of the display

2.1 Backlight

The service life of the backlight is specified by its "half-brightness time". An operating time of 50,000 would mean that the display would still retain 50% of its brightness after this time.

2.1.1 How can the service life of backlights be extended?

- Setting the display brightness to the lowest value that is still comfortable for the eyes
- Using dark images
- Reducing the brightness by 50% can increase the half-brightness time by approximately 50%.

2.2 Image persistence

Image persistence refers to the "burning in" of a static image on a display after being displayed for a prolonged period of time. This not only occurs with static images, however. Image persistence is also referred to in the technical literature as burn-in effect, image retention, memory effect, memory sticking or ghost image.

There are basically 2 types:

- Area type: This type is characterized by a dark gray image. The effect disappears if the display is switched off for a long period of time.
- Line type: Can result in permanent damage.

2.2.1 What causes image persistence?

- Static images
- No screensaver
- Sharp transitions in contrast (e.g. black/white)
- High ambient temperatures
- Operation outside of specifications

2.2.2 How can image persistence be reduced?

- Constantly switching between static and dynamic images
- Avoiding excessive brightness differences between foreground and background elements
- Using colors with similar brightness
- Using complementary colors in consecutive images
- Using screensavers

3 Pixel errors

Information:

Displays may contain defective pixels (pixel errors) that result from the manufacturing process. They are not grounds for initiating a complaint or warranty claim.

4 Repairs, complaints and replacement parts

Danger!

The unauthorized opening or repair of the device can result in injury and/or extensive damage to property. Therefore, do not attempt to perform repairs yourself. Repairs are only permitted to be performed by authorized qualified personnel at the place of manufacture.

To process a repair/complaint, please create a repair order or complaint using the B&R Material Return Portal on the B&R website at www.br-automation.com.

Appendix A

1 Abbreviations

Abbreviation	Stands for	Description
NC	Normally closed	Normally closed relay contact.
	Not connected	Used in pinout descriptions if a terminal or pin is not connected on the module side.
ND	Not defined	In technical data tables, this stands for a value that is not defined. This may be because a cable manufacturer does not provide a value for certain technical data, for example.
NO	Normally open	Normally open relay contact.
TBD	To be defined	Used in technical data tables when there is currently no value for specific technical data. The value will be provided at a later point in time.

Table 135: Abbreviations used in this user's manual

2 Viewing angles

For the viewing angle values of display types (R, L, U, D), see the technical data of the individual components.

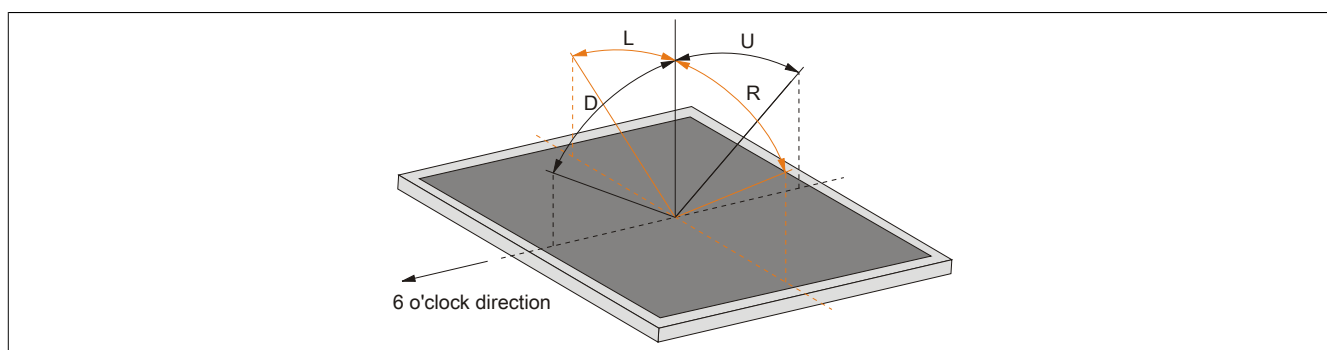

3 Chemical resistance

Single-touch panels are manufactured with the Autotex panel overlay:



Figure 119: Single-touch panel with Autotex panel overlay

Multi-touch panels feature an edge-to-edge glass surface.

3.1 Autotex panel overlay (polyester)

Unless otherwise specified, the panel overlay is resistant to exposure to the following chemicals for up to 24 hours with no visible signs of damage per DIN 42115 Part 2:

- Acetaldehyde
- Acetone
- Acetonitrile
- Aliphatic hydrocarbons
- Alkali carbonate
- Formic acid <50%
- Ammonia <40%
- Amyl acetate
- Ethanol
- Ether
- Gasoline
- Bichromate
- Potassium
- Cutting oil
- Brake fluid
- Butylcellosolve
- Sodium hypochlorite <20%
- Cyclohexanol
- Cyclohexanone
- Decon
- Diacetone alcohol
- Dibutyl phthalate
- Diesel
- Diethyl ether
- Diethyl phthalate
- Dioxan
- Dowandol
- DRM/PM
- Iron chloride (FeCl₂)
- Iron chloride (FeCl₃)
- Acetic acid <50%
- Ethyl acetate
- Linseed oil
- Aviation fuel
- Formaldehyde 37 to 42%
- Glycerine
- Glycol
- Isophorone
- Isopropanol
- Potassium hydroxide
- Potassium carbonate
- Methanol
- Methylisobutylketone
- MIBK
- Sodium bisulphate
- Sodium carbonate
- Caustic soda <40%
- N-Butyl acetate
- Paraffin oil
- Phosphoric acid <30%
- Blown castor oil
- Nitric acid <10%
- Hydrochloric acid <36%
- Sea water
- Sulphuric acid <10%
- Silicon oil
- Tenside
- Turpentine oil replacement
- Toluene
- Triacetin
- Trichloroacetic acid <50%
- Trichloroethane
- White spirits
- Washing agents
- Water
- Hydrogen peroxide <25%
- Fabric conditioner
- Xylene

The panel overlay is resistant to exposure to glacial acetic acid for less than one hour without visible damage per DIN 42115 Part 2.

3.2 Coated aluminum front

Unless otherwise specified, the coated aluminum front is resistant to exposure to the following chemicals for up to 24 hours with no visible signs of damage per DIN 42115 Part 2:

- Formic acid <50%
- Ammonia <40%
- Brake fluid
- Hydrogen chloride <10%
- Diesel
- Acetic acid <50%
- Transmission fluid
- Lactic acid <10%
- Isopropanol
- Coolant <4%
- Sodium hydroxide <40%
- Petroleum
- Phosphoric acid <25%
- Saline <10%
- Sulphuric acid <25%
- Sidolin
- Skydrol

The coated aluminum front is not resistant to the following chemicals:

- Acetone
- Ethyl acetate

3.3 Touch screen

AMT touch screen (single-touch)

Unless otherwise specified, the AMT touch screen is resistant to exposure to the following chemicals for up to 1 hour (at 25°C) with no visible changes:

- Acetone
- Ammonia-based glass cleaner
- Beer
- Unleaded gasoline
- Chemical cleaning agents
- Hydrogen chloride <6%
- Coca-Cola
- Diesel
- Dimethylbenzene
- Vinegar
- Ethanol
- Antifreeze
- Transmission fluid
- Household cleaning agents
- Hexane
- n-hexane
- Isopropanol
- Coffee
- Methylbenzene
- Methylene chloride
- Methyl ethyl ketone
- Mineral spirits
- Motor oil
- Nitric acid <70%
- Salt solution <5% tea
- Turpentine
- Lubricants
- Sulphuric acid <40%
- Cooking oil

3M touch screen (multi-touch)

Unless otherwise specified, the 3M touch screen is resistant to exposure to the following chemicals for up to 24 hours without visible changes per ASTM D 1308-02 and ASTM F 1598-95:

- Acetone
- Ammonia <5%
- Gasoline
- Beer
- Lead
- Brake fluid
- Hydrogen chloride <6%
- Coca-Cola
- Dimethylbenzene
- Ethanol
- Rubber cement
- Isopropanol
- Coffee
- Ink
- Lipstick
- Lysol
- Methylbenzene
- Methyl ethyl ketone
- Naphtha
- Nitric acid <70%
- Lubricants
- Sulphuric acid <40%
- Stamping ink
- Tea
- Trichloroethylene
- Water
- White wine vinegar
- Windex Original

4 Features

4.1 Pushbutton RAFIX 22 FS+, 1.30.270.021/2300

Pushbutton 1.30.270.021/2300		Example image 
Manufacturer	RAFI	
Type	RAFIX 22 FS+	
Manufacturer number	1.30.270.021/2300	
Quantity	1	
Illumination	Red	
Contact function	Momentary	
Service life	1,000,000	
B10 value	1,300,000	

Table 136: Pushbutton 1.30.270.021/2300

4.2 Pushbutton RAFIX 22 FS+, 1.30.270.021/2500

Pushbutton 1.30.270.021/2500		Example image 
Manufacturer	RAFI	
Type	RAFIX 22 FS+	
Manufacturer number	1.30.270.021/2500	
Quantity	1	
Illumination	Green	
Contact function	Momentary	
Service life	1,000,000	
B10 value	1,300,000	

Table 137: Pushbutton 1.30.270.021/2500

4.3 Pushbutton RAFIX 22 FS+, 1.30.270.021/2600

Pushbutton 1.30.270.021/2600		Example image 
Manufacturer	RAFI	
Type	RAFIX 22 FS+	
Manufacturer number	1.30.270.021/2600	
Quantity	1	
Illumination	Blue	
Contact function	Momentary	
Service life	1,000,000	
B10 value	1,300,000	

Table 138: Pushbutton 1.30.270.021/2600

4.4 Selector switch RAFIX 22 FS+, 1.30.272.102/2200

Selector switch 1.30.272.102/2200		Example image 
Manufacturer	RAFI	
Type	RAFIX 22 FS+	
Manufacturer number	1.30.272.102/2200	
Quantity	1	
Illumination	White	
Contact function	Maintained	
Angle of rotation	1 x 90°, L form	
Service life	300,000	
B10 value	400,000	

Table 139: Selector switch 1.30.272.102/2200

4.5 Key switch RAFIX 22 FS+, 1.30.255.222/0000

Key switch 1.30.255.222/0000		Example image 
Manufacturer	RAFI	
Type	RAFIX 22 FS+	
Manufacturer number	1.30.255.222/0000	
Quantity	1	
Contact function	Maintained	
Number of possible closings	500	
Angle of rotation	1 x 90°, L form	
Key removal position	0+1	
Service life	50,000 maintained / 30,000 key removal switching cycles	
B10 value	65,000 maintained / 40,000 key removal switching cycles	

Table 140: Key switch 1.30.255.222/0000

4.6 Emergency stop RAFIX 22 FS+ "Plus 1", 1.30.273.512/0300

Emergency stop 1.30.273.512/0300		Example image 
Manufacturer	RAFI	
Type	RAFIX 22 FS+ emergency stop button "Plus 1"	
Manufacturer number	1.30.273.512/0300	
Quantity	1	
Contact function	Maintained	
Resetting	By rotating to the right	
Service life	50,000	
B10 value	65,000	

Table 141: Emergency stop 1.30.273.512/0300

4.7 Switching element RAFIX 22 FS universal, 1.20.126.005/0000

Switching element 1.20.126.005/0000		Example image 
Manufacturer	RAFI	
Type	RAFIX 22 FS+ - universal, 2 S	
Manufacturer number	1.20.126.005/0000	
Quantity	1	
Contact system	Self-cleaning bridge contact	
Contacts	2 normally open contacts	
Normally closed contact positive opening operation per IEC 947-5-1	Yes	
Connection	Connector 2.8x0.8 mm	
Service life	1,000,000 at 10 mA / 24 VDC	
B10 value	1,300,000	
Min. AC/DC operating voltage	5 V	
Max. AC/DC operating voltage	35 V	
Min. AC/DC operating current	1 mA	
Max. AC/DC operating current	100 mA	
Max. switching capacity	250 mW	

Table 142: Switching element 1.20.126.005/0000

4.8 Switching element RAFIX 22 FS+ PCB gold, 1.20.126.414/0000

Switching element 1.20.126.414/0000		Example image
Manufacturer	RAFI	
Type	RAFIX 22 FS+ - PCB gold, emergency stop "Plus 1"	
Manufacturer number	1.20.126.414/0000	
Quantity	1	
Contact system	Self-cleaning bridge contact	
Contacts	2 normally closed contacts + 1 alarm contact*	

Table 143: Switching element 1.20.126.414/0000

Switching element 1.20.126.414/0000	
Normally closed contact with positive separation per IEC 60947-5-1	Yes
Connection	Connector 2.8x0.8 mm
Service life	50,000 at 10 mA / 24 VDC
B10 value	65,000
Min. AC/DC operating voltage	5 V
Max. AC/DC operating voltage	35 V
Min. AC/DC operating current	1 mA
Max. AC/DC operating current	100 mA
Max. switching capacity	250 mW



Table 143: Switching element 1.20.126.414/0000

4.9 5ACCSE00.000x-00x

B&R recommends RAFIX operating and switching elements with model number 5ACCSE00.000x-00x for use on expansion covers.

RAFIX operating and switching elements with model number 5ACCSE00.000x-00x must be ordered separately.

4.9.1 5ACCSE00.0000-000

General information

- 1x pushbutton
- 1x colored lens (no color, red, yellow, green, blue)
- 1x switching element
- 1x LED

4.9.1.1 Pushbutton RAFIX 22 FS+, 1.30.270.921/2200

Pushbutton 1.30.270.921/2200		Example image 
Manufacturer	RAFI	
Type	RAFIX 22 FS+	
Manufacturer number	1.30.270.921/2200	
Quantity	1	
Form of lens	Flat lens	
Contact function	Momentary	
Service life	1,000,000	
B10 value	1,300,000	

Table 144: Pushbutton 1.30.270.921/2200

4.9.1.2 Colored lens RAFIX 22 FS+, 5.49.263.062/1000

Colored lens 5.49.263.062/1000		Example image 
Manufacturer	RAFI	
Type	RAFIX 22 FS+	
Manufacturer number	5.49.263.062/1000	
Quantity	1	
Form of lens	Flat lens	
Lens color	Colorless	

Table 145: Colored lens 5.49.263.062/1000

4.9.1.3 Colored lens RAFIX 22 FS+, 5.49.263.062/1300

Colored lens 5.49.263.062/1300		Example image 
Manufacturer	RAFI	
Type	RAFIX 22 FS+	
Manufacturer number	5.49.263.062/1300	
Quantity	1	
Form of lens	Flat lens	
Lens color	Red	

Table 146: Colored lens 5.49.263.062/1300

4.9.1.4 Colored lens RAFIX 22 FS+, 5.49.263.062/1400

Colored lens 5.49.263.062/1400		Example image 
Manufacturer	RAFI	
Type	RAFIX 22 FS+	
Manufacturer number	5.49.263.062/1400	
Quantity	1	
Form of lens	Flat lens	
Lens color	Yellow	

Table 147: Colored lens 5.49.263.062/1400

4.9.1.5 Colored lens RAFIX 22 FS+, 5.49.263.062/1500

Colored lens 5.49.263.062/1500		Example image 
Manufacturer	RAFI	
Type	RAFIX 22 FS+	
Manufacturer number	5.49.263.062/1500	
Quantity	1	
Form of lens	Flat lens	
Lens color	Green	

Table 148: Colored lens 5.49.263.062/1500

4.9.1.6 Colored lens RAFIX 22 FS+, 5.49.263.062/1600

Colored lens 5.49.263.062/1600		Example image 
Manufacturer	RAFI	
Type	RAFIX 22 FS+	
Manufacturer number	5.49.263.062/1600	
Quantity	1	
Form of lens	Flat lens	
Lens color	Blue	

Table 149: Colored lens 5.49.263.062/1600

4.9.1.7 Switching element RAFIX FS, 1.20.126.102/9000

Switching element 1.20.126.102/9000		Example image 
Manufacturer	RAFI	
Type	RAFIX FS	
Manufacturer number	1.20.126.102/9000	
Quantity	1	
Contact system	Self-cleaning bridge contact	
Contacts	1 normally open contact	
Normally closed contact positive opening operation per IEC 947-5-1	Yes	
Connection	Connector 2.8x0.8 mm	
Lamp	LED clip	
Service life	1,000,000	
B10 value	1,300,000	
Min. AC/DC operating voltage	5 V	
Max. AC/DC operating voltage	35 V	
Min. AC/DC operating current	1 mA	
Max. AC/DC operating current	100 mA	
Max. switching capacity	250 mW	

Table 150: Switching element 1.20.126.102/9000

4.9.2 5ACCSE00.0000-001

General information

- 1x pushbutton
- 1x colored lens (no color, red, yellow, green, blue)
- 1x switching element
- 1x LED

4.9.2.1 Pushbutton RAFIX 22 FS+, 1.30.270.921/2200

Pushbutton 1.30.270.921/2200		Example image 
Manufacturer	RAFI	
Type	RAFIX 22 FS+	
Manufacturer number	1.30.270.921/2200	
Quantity	1	
Form of lens	Flat lens	
Contact function	Momentary	
Service life	1,000,000	
B10 value	1,300,000	

Table 151: Pushbutton 1.30.270.921/2200

4.9.2.2 Colored lens RAFIX 22 FS+, 5.49.263.062/1000

Colored lens 5.49.263.062/1000		Example image 
Manufacturer	RAFI	
Type	RAFIX 22 FS+	
Manufacturer number	5.49.263.062/1000	
Quantity	1	
Form of lens	Flat lens	
Lens color	Colorless	

Table 152: Colored lens 5.49.263.062/1000

4.9.2.3 Colored lens RAFIX 22 FS+, 5.49.263.062/1300

Colored lens 5.49.263.062/1300		Example image 
Manufacturer	RAFI	
Type	RAFIX 22 FS+	
Manufacturer number	5.49.263.062/1300	
Quantity	1	
Form of lens	Flat lens	
Lens color	Red	

Table 153: Colored lens 5.49.263.062/1300

4.9.2.4 Colored lens RAFIX 22 FS+, 5.49.263.062/1400

Colored lens 5.49.263.062/1400		Example image 
Manufacturer	RAFI	
Type	RAFIX 22 FS+	
Manufacturer number	5.49.263.062/1400	
Quantity	1	
Form of lens	Flat lens	
Lens color	Yellow	

Table 154: Colored lens 5.49.263.062/1400

4.9.2.5 Colored lens RAFIX 22 FS+, 5.49.263.062/1500

Colored lens 5.49.263.062/1500		Example image 
Manufacturer	RAFI	
Type	RAFIX 22 FS+	
Manufacturer number	5.49.263.062/1500	
Quantity	1	
Form of lens	Flat lens	
Lens color	Green	

Table 155: Colored lens 5.49.263.062/1500

4.9.2.6 Colored lens RAFIX 22 FS+, 5.49.263.062/1600

Colored lens 5.49.263.062/1600		Example image 
Manufacturer	RAFI	
Type	RAFIX 22 FS+	
Manufacturer number	5.49.263.062/1600	
Quantity	1	
Form of lens	Flat lens	
Lens color	Blue	

Table 156: Colored lens 5.49.263.062/1600

4.9.2.7 Switching element RAFIX FS, 1.20.126.101/9000

Switching element 1.20.126.101/9000		Example image 
Manufacturer	RAFI	
Type	RAFIX FS	
Manufacturer number	1.20.126.101/9000	
Quantity	1	
Contact system	Self-cleaning bridge contact	
Contacts	1 normally closed contact	
Normally closed contact positive opening operation per IEC 947-5-1	Yes	
Connection	Connector 2.8x0.8 mm	
Lamp	LED clip	
Service life	1,000,000	
B10 value	1,300,000	
Min. AC/DC operating voltage	5 V	
Max. AC/DC operating voltage	35 V	
Min. AC/DC operating current	1 mA	
Max. AC/DC operating current	100 mA	
Max. switching capacity	250 mW	

Table 157: Switching element 1.20.126.101/9000

4.9.3 5ACCSE00.0001-000

General information

- 1x emergency stop button
- 1x switching element

4.9.3.1 Emergency stop RAFIX 22 FS+ "Plus 1", 1.30.273.512/0300

Emergency stop 1.30.273.512/0300		Example image 
Manufacturer	RAFI	
Type	RAFIX 22 FS+ emergency stop button "Plus 1"	
Manufacturer number	1.30.273.512/0300	
Quantity	1	
Contact function	Maintained	
Resetting	By rotating to the right	
Service life	50,000	
B10 value	65,000	

Table 158: Emergency stop 1.30.273.512/0300

4.9.3.2 Switching element RAFIX 22 FS+ "Plus 1", 1.20.126.514/0000

Switching element 1.20.126.514/0000		Example image
Manufacturer	RAFI	
Type	RAFIX 22 FS+ "Plus 1"	
Manufacturer number	1.20.126.514/0000	
Quantity	1	
Contact system	Self-cleaning bridge contact	
Contacts	2 normally closed contact + 1 normally open contact	
Normally closed contact with positive separation per IEC 60947-5-1	Yes	

Table 159: Switching element 1.20.126.514/0000

Switching element 1.20.126.514/0000		
Connection	Connector 2.8x0.8 mm	
Service life	50,000 at 10 mA / 24 VDC	
B10 value	65,000	
Min. AC/DC operating voltage	5 V	
Max. AC/DC operating voltage	42 V	
Min. AC/DC operating current	1 mA	
Max. AC/DC operating current	100 mA	
Max. switching capacity	250 mW	

Table 159: Switching element 1.20.126.514/0000

4.9.4 5ACCSE00.0002-000

General information

- 1x key switch
- 1x switching element

4.9.4.1 Key switch RAFIX 22 FS+, 1.30.255.432/0000

Key switch 1.30.255.432/0000		Example image
Manufacturer	RAFI	
Type	RAFIX 22 FS+	
Manufacturer number	1.30.255.432/0000	
Quantity	1	
Contact function	Maintained	
Number of possible closings	500	
Angle of rotation	2x 90°	
Key removal position	0+1+2	
Service life	50,000 maintained / 30,000 key removal switching cycles	
B10 value	65,000 maintained / 40,000 key removal switching cycles	

Table 160: Key switch 1.30.255.432/0000

4.9.4.2 Switching element RAFIX 22 FS, 1.20.126.105/9000

Switching element 1.20.126.105/9000		Example image
Manufacturer	RAFI	
Type	RAFIX 22 FS	
Manufacturer number	1.20.126.105/9000	
Quantity	1	
Contact system	Self-cleaning bridge contact	
Contacts	2 normally open contacts	
Normally closed contact positive opening operation per IEC 947-5-1	Yes	
Connection	Connector 2.8x0.8 mm	
Service life	1,000,000	
Min. AC/DC operating voltage	5 V	
Max. AC/DC operating voltage	35 V	
Min. AC/DC operating current	1 mA	
Max. AC/DC operating current	100 mA	
Max. switching capacity	250 mW	

Table 161: Switching element 1.20.126.105/9000

4.9.5 5ACCSE00.0003-000

- 1x key switch
- 1x switching element

4.9.5.1 Key switch RAFIX 22 FS+, 1.30.255.222/0000

Key switch 1.30.255.222/0000		Example image
Manufacturer	RAFI	
Type	RAFIX 22 FS+	
Manufacturer number	1.30.255.222/0000	
Quantity	1	
Contact function	Maintained	
Number of possible closings	500	
Angle of rotation	1 x 90°, L form	
Key removal position	0+1	
Service life	50,000 maintained / 30,000 key removal switching cycles	
B10 value	65,000 maintained / 40,000 key removal switching cycles	

Table 162: Key switch 1.30.255.222/0000

4.9.5.2 Switching element RAFIX 22 FS, 1.20.126.103/9000

Switching element 1.20.126.103/9000		Example image
Manufacturer	RAFI	
Type	RAFIX 22 FS	
Manufacturer number	1.20.126.103/9000	
Quantity	1	
Contact system	Self-cleaning bridge contact	
Contacts	1 normally closed contact + 1 normally open contact	
Connection	Connector 2.8x0.8 mm	
Service life	1,000,000 at 10 mA / 24 VDC	
Min. AC/DC operating voltage	5 V	
Max. AC/DC operating voltage	42 V	
Min. AC/DC operating current	1 mA	
Max. AC/DC operating current	100 mA	
Max. switching capacity	250 mW	

Table 163: Switching element 1.20.126.103/9000

4.9.6 5ACCSE00.0004-000

General information

- 1x selector switch
- 1x switching element

4.9.6.1 Selector switch RAFIX 22 FS+, 1.30.272.102/2200

Selector switch 1.30.272.102/2200		Example image
Manufacturer	RAFI	
Type	RAFIX 22 FS+	
Manufacturer number	1.30.272.102/2200	
Quantity	1	
Illumination	White	
Contact function	Maintained	
Angle of rotation	1 x 90°, L form	
Service life	300,000	
B10 value	400,000	

Table 164: Selector switch 1.30.272.102/2200

4.9.6.2 Switching element RAFIX FS, 1.20.126.102/9000

Switching element 1.20.126.102/9000		Example image
Manufacturer	RAFI	
Type	RAFIX FS	
Manufacturer number	1.20.126.102/9000	
Quantity	1	
Contact system	Self-cleaning bridge contact	
Contacts	1 normally open contact	
Normally closed contact positive opening operation per IEC 947-5-1	Yes	
Connection	Connector 2.8x0.8 mm	
Lamp	LED clip	
Service life	1,000,000	
B10 value	1,300,000	
Min. AC/DC operating voltage	5 V	
Max. AC/DC operating voltage	35 V	
Min. AC/DC operating current	1 mA	
Max. AC/DC operating current	100 mA	
Max. switching capacity	250 mW	

Table 165: Switching element 1.20.126.102/9000

4.9.7 5ACCSE00.0005-000

4.9.7.1 USB extension RAFIX 22 FS+, 9.30.279.003/0700

Caution!

IP65 protection can only be achieved if the USB protective cover is properly installed.

Caution!

Because this interface is designed according to general PC specifications, extreme care should be taken with regard to EMC, wiring, etc.

USB extension 9.30.279.003/0700	
Manufacturer	RAFI
Type	RAFIX 22 FS+
Manufacturer number	9.30.279.003/0700
Design	Type A
Transfer rate	Low speed (1.5 Mbit/s), full speed (12 Mbit/s), high speed (480 Mbit/s) ¹⁾
Current-carrying capacity ²⁾ USB extension	Max. 500 mA
Cable length USB 2.0	400 mm
	1x USB 2.0, type A, female



Table 166: USB extension 9.30.279.003/0700

- 1) In SDL3 operation: Low speed (1.5 Mbit/s), full speed (12 Mbit/s), high speed (30 Mbit/s).
- 2) The USB interface is protected by a maintenance-free "USB current-limiting switch" (max. 500 mA).

5 Touch screen

5.1 5-wire AMT touch screen (single-touch)

5.1.1 Technical data

Information:

The following specifications, properties and limit values apply only to this individual component and may deviate from those that apply to the complete system. For the complete system in which this individual component is used, for example, the data specified for that complete system applies.

Product ID	5-wire AMT touch screen
General information	
Certifications	
CE	Yes
c-UL-us	Yes
Manufacturer	AMT
Technology	Analog, resistive
Release pressure	<1 N
Light transmission	81% ±3%
Environmental conditions	
Temperature	
Operation	- 20 to 70°C
Storage	- 40 to 80°C
Transport	- 40 to 80°C
Relative humidity	
Operation	90% at max. 50°C
Storage	90% RH at max. 60°C for 504 hours
Transport	90% RH at max. 60°C for 504 hours
Operating conditions	
Service life	36 million touch operations at the same position (release pressure: 250 g, interval: 2x per second)
Activation	Finger, pointer, credit card, glove
Drivers	Touch screen drivers for approved operating systems are available for download in the Downloads section of the B&R website (www.br-automation.com).

Table 167: 5-wire AMT touch screen - Technical data

5.1.2 Temperature/Humidity diagram

All values apply to non-condensing operation.

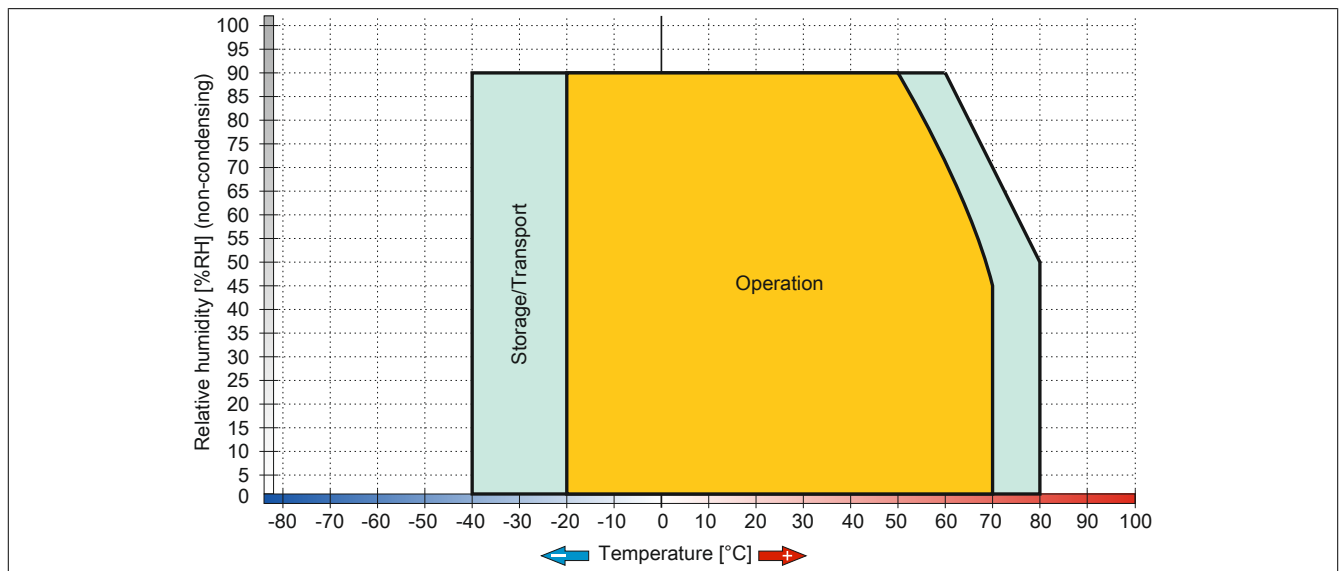

Figure 120: 5-wire AMT touch screen - Temperature/Humidity diagram

5.2 3M touch screen (multi-touch generation 3)

5.2.1 Technical data

Information:

The following specifications, properties and limit values apply only to this individual component and may deviate from those that apply to the complete system. For the complete system in which this individual component is used, for example, the data specified for that complete system applies.

Product ID	3M touch screen	
General information		
Certifications		
CE	Yes	
Manufacturer	3M	
Technology	Projected capacitive touch (PCT)	
Light transmission	>90%	
Anti-reflective coating	Optical/Gloss=80	
Environmental conditions		
Temperature		
Operation	-10 to 70°C	
Storage	-40 to 70°C	
Transport	-40 to 70°C	
Relative humidity		
Operation	Up to 90% at max. 35°C, for >35°C see diagram	
Storage	Up to 90% at max. 35°C, for >35°C see diagram	
Transport	Up to 90% at max. 35°C, for >35°C see diagram	
Operating conditions		
Activation	Finger, thin glove, 3M Smart Pen	

Table 168: 3M touch screen - Technical data

5.2.2 Temperature/Humidity diagram

All values apply to non-condensing operation/storage/transport.

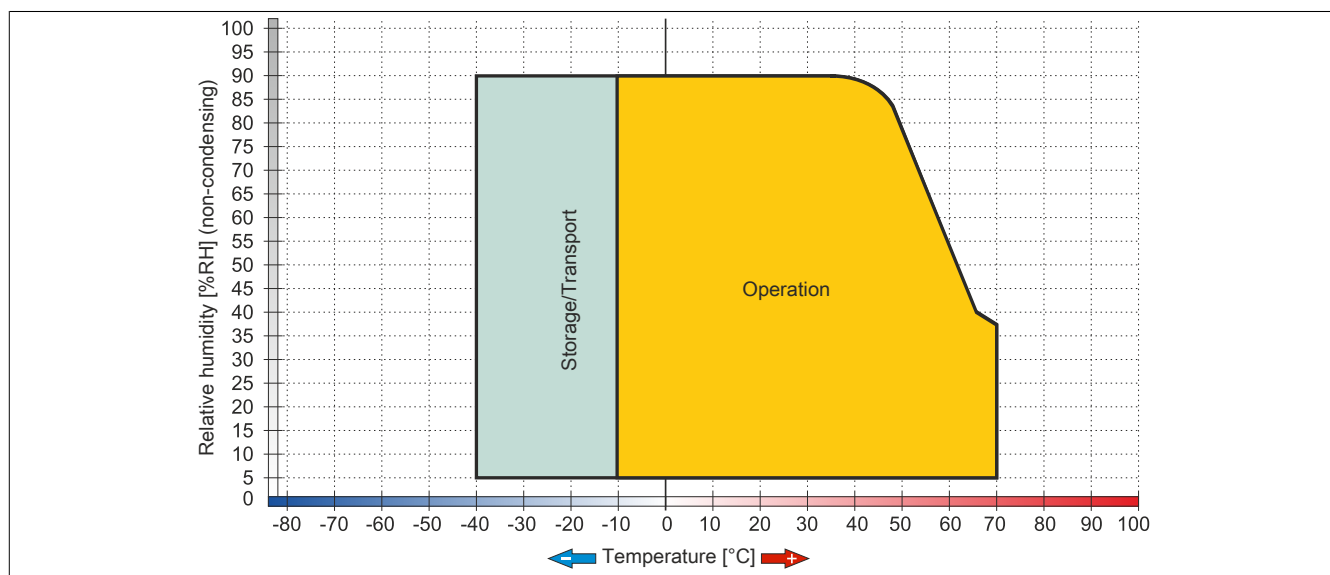

Figure 121: 3M touch screen - Temperature/Humidity diagram

Figure 1:	Automation Panel 5000 - Configuration.....	21
Figure 2:	AP5120/AP5130 (flange connection on top) with 5ACCMA00.000x-000 and 5AC-CHD0x.xxxx-000 - Dimensions.....	27
Figure 3:	AP5120/AP5130 (flange connection on bottom) with 5ACCMA00.000x-000 and 5AC-CHD0x.xxxx-000 - Dimensions.....	28
Figure 4:	AP5230 (flange connection on top) with 5ACCMA00.000x-000 and 5ACCHD0x.xxxx-000 - Dimensions.....	29
Figure 5:	AP5230 (flange connection on bottom) with 5ACCMA00.000x-000 and 5ACCHD0x.xxxx-000 - Dimensions.....	31
Figure 6:	5ACCFL00.0000-000 rotary flange - Dimensions.....	32
Figure 7:	5ACCFL00.0200-000 - Dimensions.....	32
Figure 8:	AP5120/AP5130 with 5ACCMA01.0100-000 and 5ACCHD0x.xxxx-000 - Dimensions.....	33
Figure 9:	AP5120/AP5230 with 5ACCMA01.0100-000 and 5ACCHD0x.xxxx-000 - Dimensions.....	34
Figure 10:	Automation Panel 5000 with VESA - Mounting orientation.....	36
Figure 11:	Automation Panel 5000 - Temperature sensor position.....	42
Figure 12:	SDL/DVI receiver link module - Block diagram.....	47
Figure 13:	SDL3 receiver link module - Block diagram.....	47
Figure 14:	SDL4 receiver link module - Block diagram.....	47
Figure 15:	Overview of interfaces - SDL/DVI receiver link module.....	48
Figure 16:	Ground connection.....	49
Figure 17:	Brightness controls.....	53
Figure 18:	Overview of interfaces - SDL3 receiver link module.....	54
Figure 19:	Ground connection.....	55
Figure 20:	Overview of interfaces - SDL4 receiver link module.....	58
Figure 21:	Ground connection.....	59
Figure 22:	Panel with expansion unit and operating elements - Front view.....	62
Figure 23:	Hardware numbers in the B&R Key Editor and B&R Control Center.....	63
Figure 24:	AP5230 (landscape) - Button, switch and LED configuration.....	64
Figure 25:	Button/Switch interface.....	66
Figure 26:	5AP5120.1505-000 - Dimensions.....	68
Figure 27:	5AP5120.1505-000 - Temperature/Humidity diagram.....	69
Figure 28:	5AP5120.1906-000 - Dimensions.....	71
Figure 29:	5AP5120.1906-000 - Temperature/Humidity diagram.....	71
Figure 30:	5AP5130.156B-000 - Dimensions.....	73
Figure 31:	5AP5130.156B-000 - Temperature/Humidity diagram.....	73
Figure 32:	5AP5130.156C-000 - Dimensions.....	75
Figure 33:	5AP5130.156C-000 - Temperature/Humidity diagram.....	75
Figure 34:	5AP5130.185B-000 - Dimensions.....	77
Figure 35:	5AP5130.185B-000 - Temperature/Humidity diagram.....	77
Figure 36:	5AP5130.185C-000 - Dimensions.....	79
Figure 37:	5AP5130.185C-000 - Temperature/Humidity diagram.....	79
Figure 38:	5AP5130.215C-000 - Dimensions.....	81
Figure 39:	5AP5130.215C-000 - Temperature/Humidity diagram.....	81
Figure 40:	5AP5130.240C-000 - Dimensions.....	83
Figure 41:	5AP5130.240C-000 - Temperature/Humidity diagram.....	83
Figure 42:	5AP5230.156B-000 - Dimensions.....	85
Figure 43:	5AP5230.156B-000 - Temperature/Humidity diagram.....	86
Figure 44:	5AP5230.156C-000 - Dimensions.....	88
Figure 45:	5AP5230.156C-000 - Temperature/Humidity diagram.....	89
Figure 46:	5AP5230.185B-000 - Dimensions.....	91
Figure 47:	5AP5230.185B-000 - Temperature/Humidity diagram.....	92
Figure 48:	5AP5230.185C-000.....	94
Figure 49:	5AP5230.185C-000 - Temperature/Humidity diagram.....	95
Figure 50:	5AP5230.215C-000 - Dimensions.....	97
Figure 51:	5AP5230.215C-000 - Temperature/Humidity diagram.....	98
Figure 52:	5AP5230.215I-000 - Dimensions.....	100
Figure 53:	5AP5230.215I-000 - Temperature/Humidity diagram.....	101
Figure 54:	5AP5230.240C-000 - Dimensions.....	103

Figure 55:	5AP5230.240C-000 - Temperature/Humidity diagram.....	104
Figure 56:	5ACCFL00.0000-000 - Dimensions.....	118
Figure 57:	5ACCFL00.0200-000 - Dimensions.....	119
Figure 58:	5ACCHD0x.xxxx-000 - Content of delivery.....	128
Figure 59:	Installing the rings on the swing arm shaft.....	131
Figure 60:	Feeding cables through the swing arm shaft.....	132
Figure 61:	Installing the Automation Panel 5000.....	133
Figure 62:	Removing the mounting unit cover.....	134
Figure 63:	Removing the Torx screws.....	135
Figure 64:	Removing the link module.....	135
Figure 65:	Removing the mounting unit cover.....	136
Figure 66:	Inserting the sealing ring.....	136
Figure 67:	Mounting the flange.....	137
Figure 68:	Removing the Torx screws.....	138
Figure 69:	Removing/Installing the mounting unit on the panel.....	139
Figure 70:	Place the mounting unit on the panel.....	140
Figure 71:	Tightening the Torx screws.....	141
Figure 72:	Removing the Torx screws.....	142
Figure 73:	Removing/Installing the mounting unit on the panel.....	142
Figure 74:	Place the mounting unit on the panel.....	143
Figure 75:	Tightening the Torx screws.....	143
Figure 76:	Removing the Torx screws.....	144
Figure 77:	Installing the handles.....	144
Figure 78:	Removing the back cover.....	145
Figure 79:	Disconnecting the cables for the expansion unit.....	146
Figure 80:	Removing the nuts.....	146
Figure 81:	Connecting the cables for the expansion unit to the panel's circuit board.....	147
Figure 82:	Cut the panel overlay along the cutout areas.....	148
Figure 83:	Cutting two parallel slits.....	149
Figure 84:	Breaking through the cutout for the operating element from the inside.....	149
Figure 85:	Cutting the panel overlay so it is flush.....	149
Figure 86:	Installing a screw clamp terminal block.....	151
Figure 87:	Installing a cage clamp terminal block.....	151
Figure 88:	Connecting the power supply connector to a B&R device.....	152
Figure 89:	Automation Panel 5000 - Grounding concept.....	153
Figure 90:	Bend radius - Cable connection.....	154
Figure 91:	Adjusting the display brightness.....	158
Figure 92:	Brightness controls.....	158
Figure 93:	ADI Control Center screenshots - Examples.....	161
Figure 94:	ADI Development Kit Screenshots (Symbolbild).....	163
Figure 95:	ADI .NET SDK screenshots.....	164
Figure 96:	B&R Key Editor screenshots.....	165
Figure 97:	B&R KCF Editor V1.0 screenshot.....	166
Figure 98:	5MMUSB.xxxx-01 - Temperature/Humidity diagram.....	174
Figure 99:	5MMUSB.032G-02 - Temperature/Humidity diagram.....	176
Figure 100:	Bend radius specifications.....	178
Figure 101:	5CADVI.0xxx-00 - Dimensions.....	178
Figure 102:	5CADVI.0xxx-00 - Pinout.....	179
Figure 103:	Bend radius specifications.....	181
Figure 104:	5CASDL.0xxx-00 - Dimensions.....	181
Figure 105:	5CASDL.0xxx-00 - Pinout.....	182
Figure 106:	Bend radius specifications.....	184
Figure 107:	5CASDL.0xxx-01 - Dimensions.....	184
Figure 108:	5CASDL.0xxx-01 - Pinout.....	185
Figure 109:	Bend radius specifications.....	187
Figure 110:	5CASDL.0xxx-03 ≥Rev. E0 - Dimensions.....	188
Figure 111:	5CASDL.0xxx-03 ≤Rev. D0 - Dimensions.....	188

Figure 112:	5CASDL.0xxx-03 - Pinout.....	189
Figure 113:	SDL3/SDL4 bending radius specification.....	192
Figure 114:	5CASD3.xxxx-00 - Dimensions.....	192
Figure 115:	5CASD3.xxxx-00 - Pinout.....	192
Figure 116:	Wiring with a field-assembled cable.....	193
Figure 117:	5CAUSB.00xx-00 USB cables - Pinout.....	195
Figure 118:	9A0014.xx RS232 cables - Pinout	197
Figure 119:	Single-touch panel with Autotex panel overlay.....	201
Figure 120:	5-wire AMT touch screen - Temperature/Humidity diagram.....	215
Figure 121:	3M touch screen - Temperature/Humidity diagram.....	216

Table 1:	Environmentally friendly disposal.....	13
Table 2:	Description of the safety notices used in this documentation.....	14
Table 3:	Range of nominal sizes.....	14
Table 4:	AP5120/AP5130 - Dimensions.....	27
Table 5:	AP5120/AP5130 - Dimensions.....	28
Table 6:	AP5230 with flange connection on top - Dimensions.....	29
Table 7:	AP5230 with flange connection on bottom - Dimensions.....	31
Table 8:	AP5120/AP5130 VESA - Dimensions.....	33
Table 9:	AP5230 VESA - Dimensions.....	34
Table 10:	Mounting orientations during operation.....	36
Table 11:	AP5000 panels - Weight.....	37
Table 12:	Link modules - Weight.....	37
Table 13:	AP5000 mounting units - Weight.....	37
Table 14:	AP5000 flanges - Weight.....	37
Table 15:	AP5000 expansion units - Weight.....	37
Table 16:	AP5000 handles - Weight.....	37
Table 17:	Maximum ambient temperature for worst-case operation.....	39
Table 18:	Maximum ambient temperature for worst-case operation.....	40
Table 19:	Minimum ambient temperature for worst-case operation.....	40
Table 20:	AP5000 panels - Ambient temperature during storage and transport.....	41
Table 21:	Link modules - Ambient temperature during storage and transport.....	41
Table 22:	Expansion units - Ambient temperature during storage and transport.....	41
Table 23:	Temperature sensor position.....	42
Table 24:	AP5000 panels - Relative humidity.....	43
Table 25:	Link modules - Humidity.....	43
Table 26:	Expansion units - Relative humidity.....	43
Table 27:	Swing arm mounting unit - Vibration.....	43
Table 28:	VESA mounting unit - Vibration.....	43
Table 29:	Shock.....	44
Table 30:	+24 VDC voltage supply connection.....	45
Table 31:	Link modules - Power calculation.....	46
Table 32:	AP5000 panels - Power calculation.....	46
Table 33:	AP5000 expansion units - Power calculation.....	46
Table 34:	+24 VDC voltage supply connection.....	49
Table 35:	Panel In interface - SDL, DVI.....	50
Table 36:	DVI interface - Pinout.....	50
Table 37:	Cable lengths and resolutions for SDL transmission.....	51
Table 38:	Cable lengths and resolutions for DVI transfer.....	51
Table 39:	USB1/USB2 interface.....	52
Table 40:	USB In interface.....	53
Table 41:	COM - Pinout.....	53
Table 42:	+24 VDC voltage supply connection.....	55
Table 43:	SDL3 In interface.....	56
Table 44:	SDL3 In LEDs.....	56
Table 45:	USB1/USB2 interface.....	57
Table 46:	+24 VDC voltage supply connection.....	59
Table 47:	SDL4 In interface.....	60
Table 48:	SDL4 In LEDs.....	60
Table 49:	USB1/USB2 interface.....	61
Table 50:	Operating elements used.....	62
Table 51:	Front USB interface.....	65
Table 52:	Button/Switch interface - Pinout.....	66
Table 53:	5AP5120.1505-000 - Order data.....	67
Table 54:	5AP5120.1505-000 - Technical data.....	67
Table 55:	5AP5120.1906-000 - Order data.....	70
Table 56:	5AP5120.1906-000 - Technical data.....	70
Table 57:	5AP5130.156B-000 - Order data.....	72

Table 58:	5AP5130.156B-000 - Technical data.....	72
Table 59:	5AP5130.156C-000 - Order data.....	74
Table 60:	5AP5130.156C-000 - Technical data.....	74
Table 61:	5AP5130.185B-000 - Order data.....	76
Table 62:	5AP5130.185B-000 - Technical data.....	76
Table 63:	5AP5130.185C-000 - Order data.....	78
Table 64:	5AP5130.185C-000 - Technical data.....	78
Table 65:	5AP5130.215C-000 - Order data.....	80
Table 66:	5AP5130.215C-000 - Technical data.....	80
Table 67:	5AP5130.240C-000 - Order data.....	82
Table 68:	5AP5130.240C-000 - Technical data.....	82
Table 69:	5AP5230.156B-000 - Order data.....	84
Table 70:	5AP5230.156B-000 - Technical data.....	84
Table 71:	5AP5230.156C-000 - Order data.....	87
Table 72:	5AP5230.156C-000 - Technical data.....	87
Table 73:	5AP5230.185B-000 - Order data.....	90
Table 74:	5AP5230.185B-000 - Technical data.....	90
Table 75:	5AP5230.185C-000 - Order data.....	93
Table 76:	5AP5230.185C-000 - Technical data.....	93
Table 77:	5AP5230.215C-000 - Order data.....	96
Table 78:	5AP5230.215C-000 - Technical data.....	96
Table 79:	5AP5230.215I-000 - Order data.....	99
Table 80:	5AP5230.215I-000 - Technical data.....	99
Table 81:	5AP5230.240C-000 - Order data.....	102
Table 82:	5AP5230.240C-000 - Technical data.....	102
Table 83:	5DLSD4.1001-00 - Order data.....	105
Table 84:	5DLSD4.1001-00 - Technical data.....	105
Table 85:	5DLSD3.1001-00 - Order data.....	107
Table 86:	5DLSD3.1001-00 - Technical data.....	107
Table 87:	5DLSDL.1001-00 - Order data.....	109
Table 88:	5DLSDL.1001-00 - Technical data.....	109
Table 89:	5ACCMA00.0000-000 - Order data.....	111
Table 90:	5ACCMA00.0000-000 - Technical data.....	111
Table 91:	5ACCMA00.0001-000 - Order data.....	112
Table 92:	5ACCMA00.0001-000 - Technical data.....	112
Table 93:	USB interface.....	113
Table 94:	5ACCMA00.0002-000 - Order data.....	114
Table 95:	5ACCMA00.0002-000 - Technical data.....	114
Table 96:	USB interface.....	115
Table 97:	5ACCMA01.0100-000 - Order data.....	116
Table 98:	5ACCMA01.0100-000 - Technical data.....	116
Table 99:	5ACCFL00.0000-000 - Order data.....	117
Table 100:	5ACCFL00.0000-000 - Technical data.....	117
Table 101:	5ACCFL00.0200-000 - Order data.....	119
Table 102:	5ACCFL00.0200-000 - Technical data.....	119
Table 103:	5ACCKP00.156B-000, 5ACCKP00.185B-000, 5ACCKP00.215C-000, 5ACCKP00.215I-000, 5ACCKP00.240C-000 - Order data.....	120
Table 104:	5ACCKP00.156B-000, 5ACCKP00.185B-000, 5ACCKP00.215C-000, 5ACCKP00.215I-000, 5ACCKP00.240C-000 - Technical data.....	120
Table 105:	5ACCKP01.156B-000, 5ACCKP01.185B-000, 5ACCKP01.215C-000, 5ACCKP01.215I-000, 5ACCKP01.240C-000 - Order data.....	122
Table 106:	5ACCKP01.156B-000, 5ACCKP01.185B-000, 5ACCKP01.215C-000, 5ACCKP01.215I-000, 5ACCKP01.240C-000 - Technical data.....	122
Table 107:	5ACCKP04.156B-000, 5ACCKP04.185B-000, 5ACCKP04.215C-000, 5ACCKP04.215I-000, 5ACCKP04.240C-000 - Order data.....	124
Table 108:	5ACCKP04.156B-000, 5ACCKP04.185B-000, 5ACCKP04.215C-000, 5ACCKP04.215I-000, 5ACCKP04.240C-000 - Technical data.....	124
Table 109:	USB interface.....	126

Table 110:	5ACCHD00.1505-000, 5ACCHD00.156B-000, 5ACCHD00.185B-000, 5ACCHD00.1906-000, 5ACCHD00.215C-000, 5ACCHD00.240C-000, 5ACCHD01.156B-000, 5ACCHD01.185B-000, 5ACCHD01.215C-000, 5ACCHD01.215I-000, 5ACCHD01.240C-000 - Order data.....	127
Table 111:	5ACCHD00.1505-000, 5ACCHD00.156B-000, 5ACCHD00.185B-000, 5ACCHD00.1906-000, 5ACCHD00.215C-000, 5ACCHD00.240C-000 - Technical data.....	127
Table 112:	5ACCHD01.156B-000, 5ACCHD01.185B-000, 5ACCHD01.215C-000, 5ACCHD01.215I-000, 5ACCHD01.240C-000 - Technical data.....	127
Table 113:	5SWUTI.0001-000 - Order data.....	167
Table 114:	0TB103.9, 0TB103.91 - Order data.....	171
Table 115:	0TB103.9, 0TB103.91 - Technical data.....	171
Table 116:	5MMUSB.2048-01, 5MMUSB.4096-01 - Order data.....	173
Table 117:	5MMUSB.2048-01, 5MMUSB.4096-01 - Technical data.....	173
Table 118:	5MMUSB.032G-02 - Order data.....	175
Table 119:	5MMUSB.032G-02 - Technical data.....	175
Table 120:	5CADVI.0018-00, 5CADVI.0050-00, 5CADVI.0100-00 - Order data.....	177
Table 121:	5CADVI.0018-00, 5CADVI.0050-00, 5CADVI.0100-00 - Technical data.....	177
Table 122:	5CASDL.0008-00, 5CASDL.0018-00, 5CASDL.0050-00, 5CASDL.0100-00, 5CASDL.0150-00, 5CASDL.0200-00, 5CASDL.0250-00, 5CASDL.0300-00 - Order data.....	180
Table 123:	5CASDL.0008-00, 5CASDL.0018-00, 5CASDL.0050-00, 5CASDL.0100-00, 5CASDL.0150-00, 5CASDL.0200-00, 5CASDL.0250-00, 5CASDL.0300-00 - Technical data.....	180
Table 124:	5CASDL.0018-01, 5CASDL.0050-01, 5CASDL.0100-01, 5CASDL.0150-01 - Order data.....	183
Table 125:	5CASDL.0018-01, 5CASDL.0050-01, 5CASDL.0100-01, 5CASDL.0150-01 - Technical data..	183
Table 126:	5CASDL.0018-03, 5CASDL.0050-03, 5CASDL.0100-03, 5CASDL.0150-03, 5CASDL.0200-03, 5CASDL.0250-03, 5CASDL.0300-03 - Order data.....	186
Table 127:	5CASDL.0018-03, 5CASDL.0050-03, 5CASDL.0100-03, 5CASDL.0150-03, 5CASDL.0200-03, 5CASDL.0250-03, 5CASDL.0300-03 - Technical data.....	186
Table 128:	5CASDL.0xxx-03 SDL flex cables - Construction.....	188
Table 129:	5CASD3.0030-00, 5CASD3.0050-00, 5CASD3.0100-00, 5CASD3.0150-00, 5CASD3.0200-00, 5CASD3.0300-00, 5CASD3.0500-00, 5CASD3.1000-00 - Order data.....	190
Table 130:	5CASD3.0030-00, 5CASD3.0050-00, 5CASD3.0100-00, 5CASD3.0150-00, 5CASD3.0200-00, 5CASD3.0300-00, 5CASD3.0500-00, 5CASD3.1000-00 - Technical data.....	190
Table 131:	5CAUSB.0018-00, 5CAUSB.0050-00 - Order data.....	194
Table 132:	5CAUSB.0018-00, 5CAUSB.0050-00 - Technical data.....	194
Table 133:	9A0014.02, 9A0014.05, 9A0014.10 - Order data.....	196
Table 134:	9A0014.02, 9A0014.05, 9A0014.10 - Technical data.....	196
Table 135:	Abbreviations used in this user's manual.....	200
Table 136:	Pushbutton 1.30.270.021/2300.....	204
Table 137:	Pushbutton 1.30.270.021/2500.....	204
Table 138:	Pushbutton 1.30.270.021/2600.....	204
Table 139:	Selector switch 1.30.272.102/2200.....	204
Table 140:	Key switch 1.30.255.222/0000.....	205
Table 141:	Emergency stop 1.30.273.512/0300.....	205
Table 142:	Switching element 1.20.126.005/0000.....	205
Table 143:	Switching element 1.20.126.414/0000.....	205
Table 144:	Pushbutton 1.30.270.921/2200.....	207
Table 145:	Colored lens 5.49.263.062/1000.....	207
Table 146:	Colored lens 5.49.263.062/1300.....	207
Table 147:	Colored lens 5.49.263.062/1400.....	207
Table 148:	Colored lens 5.49.263.062/1500.....	208
Table 149:	Colored lens 5.49.263.062/1600.....	208
Table 150:	Switching element 1.20.126.102/9000.....	208
Table 151:	Pushbutton 1.30.270.921/2200.....	209
Table 152:	Colored lens 5.49.263.062/1000.....	209
Table 153:	Colored lens 5.49.263.062/1300.....	209
Table 154:	Colored lens 5.49.263.062/1400.....	209
Table 155:	Colored lens 5.49.263.062/1500.....	209
Table 156:	Colored lens 5.49.263.062/1600.....	210
Table 157:	Switching element 1.20.126.101/9000.....	210

Table 158:	Emergency stop 1.30.273.512/0300.....	210
Table 159:	Switching element 1.20.126.514/0000.....	210
Table 160:	Key switch 1.30.255.432/0000.....	211
Table 161:	Switching element 1.20.126.105/9000.....	211
Table 162:	Key switch 1.30.255.222/0000.....	212
Table 163:	Switching element 1.20.126.103/9000.....	212
Table 164:	Selector switch 1.30.272.102/2200.....	213
Table 165:	Switching element 1.20.126.102/9000.....	213
Table 166:	USB extension 9.30.279.003/0700.....	214
Table 167:	5-wire AMT touch screen - Technical data.....	215
Table 168:	3M touch screen - Technical data.....	216

0TB103.9.....	171
0TB103.91.....	171
5ACCFL00.0000-000.....	117
5ACCFL00.0200-000.....	119
5ACCHD00.1505-000.....	127
5ACCHD00.156B-000.....	127
5ACCHD00.185B-000.....	127
5ACCHD00.1906-000.....	127
5ACCHD00.215C-000.....	127
5ACCHD00.240C-000.....	127
5ACCHD01.156B-000.....	127
5ACCHD01.185B-000.....	127
5ACCHD01.215C-000.....	127
5ACCHD01.215I-000.....	127
5ACCHD01.240C-000.....	127
5ACCKP00.156B-000.....	120
5ACCKP00.185B-000.....	120
5ACCKP00.215C-000.....	120
5ACCKP00.215I-000.....	120
5ACCKP00.240C-000.....	120
5ACCKP01.156B-000.....	122
5ACCKP01.185B-000.....	122
5ACCKP01.215C-000.....	122
5ACCKP01.215I-000.....	122
5ACCKP01.240C-000.....	122
5ACCKP04.156B-000.....	124
5ACCKP04.185B-000.....	124
5ACCKP04.215C-000.....	124
5ACCKP04.215I-000.....	124
5ACCKP04.240C-000.....	124
5ACCMA00.0000-000.....	111
5ACCMA00.0001-000.....	112
5ACCMA00.0002-000.....	114
5ACCMA01.0100-000.....	116
5AP5120.1505-000.....	67
5AP5120.1906-000.....	70
5AP5130.156B-000.....	72
5AP5130.156C-000.....	74
5AP5130.185B-000.....	76
5AP5130.185C-000.....	78
5AP5130.215C-000.....	80
5AP5130.240C-000.....	82
5AP5230.156B-000.....	84
5AP5230.156C-000.....	87
5AP5230.185B-000.....	90
5AP5230.185C-000.....	93
5AP5230.215C-000.....	96
5AP5230.215I-000.....	99
5AP5230.240C-000.....	102
5CADVI.0018-00.....	177
5CADVI.0050-00.....	177
5CADVI.0100-00.....	177
5CASD3.0030-00.....	190
5CASD3.0050-00.....	190
5CASD3.0100-00.....	190
5CASD3.0150-00.....	190
5CASD3.0200-00.....	190
5CASD3.0300-00.....	190
5CASD3.0500-00.....	190
5CASD3.1000-00.....	190
5CASDL.0008-00.....	180
5CASDL.0018-00.....	180

5CASDL.0018-01.....	183
5CASDL.0018-03.....	186
5CASDL.0050-00.....	180
5CASDL.0050-01.....	183
5CASDL.0050-03.....	186
5CASDL.0100-00.....	180
5CASDL.0100-01.....	183
5CASDL.0100-03.....	186
5CASDL.0150-00.....	180
5CASDL.0150-01.....	183
5CASDL.0150-03.....	186
5CASDL.0200-00.....	180
5CASDL.0200-03.....	186
5CASDL.0250-00.....	180
5CASDL.0250-03.....	186
5CASDL.0300-00.....	180
5CASDL.0300-03.....	186
5CAUSB.0018-00.....	194
5CAUSB.0050-00.....	194
5DLSD3.1001-00.....	107
5DLSD4.1001-00.....	105
5DLSDL.1001-00.....	109
5MMUSB.032G-02.....	175
5MMUSB.2048-01.....	173
5MMUSB.4096-01.....	173
5SWUTI.0001-000.....	167
9A0014.02.....	196
9A0014.05.....	196
9A0014.10.....	196

5	
5ACCFL00.0200-000.....	119
5ACCMA00.0002-000.....	114
A	
Accessories.....	171
ADI.....	161
.NET SDK.....	164
Development Kit.....	163
Adjusting the display brightness.....	158
Administrator accounts.....	13
Automation Panel 5000 - Installation.....	131
Automation Runtime.....	160
B	
B&R Automation Device Interface.....	161
B&R Control Center.....	161
B&R KCF Editor.....	166
B&R Key Editor.....	165
Backlight.....	53
Bend radius.....	154
Bend radius specifications.....	154
Block diagrams.....	47
Brightness.....	53
Brightness controls.....	53
Button.....	62
Button/Switch interface.....	66
C	
Cable connections.....	154
Cable lengths.....	51, 51
Cables.....	177
DVI.....	177
RS232.....	196
SDL.....	180
SDL3.....	190
SDL flex.....	186
SDL with 45° male connector.....	183
USB.....	194
CE marking.....	168
Certifications.....	169, 169, 170
EAC.....	169
GOST-R.....	169
UL.....	169
Chemical resistance.....	201
Cleaning.....	198
COM.....	53
Complaints.....	199
Complete system.....	22
Conduct interference.....	153
Configuration.....	20
Control Center.....	161
Creating reports.....	161
D	
DC power cable.....	151

Defective pixels.....	199
Dimensions.....	27, 28, 29, 31, 33, 34, 27, 28, 29, 31, 33, 34
Dimension standards.....	14
Display brightness.....	158
Disposal.....	13, 13
DVI cables.....	177
DVI mode	
With multi-touch Automation Panel.....	24
DVI operation.....	24
With single-touch Automation Panel.....	24
DVI transfer.....	51, 51

E

EAC.....	169
Electrical characteristics.....	45
Block diagrams.....	47
Power calculation.....	46
Electromagnetic compatibility.....	168
EMC directive.....	168
Emergency stop.....	62, 205
Environmental characteristics.....	39
Maximum ambient temperature for worst-case operation.....	39
Minimum ambient temperature for worst-case operation.....	40
Protection.....	44
Relative humidity.....	43
Shock.....	43
Temperature during storage and transport.....	41
Temperature monitoring.....	42
Temperature sensor positions.....	42
Temperature specifications.....	39
Vibration.....	43
ESD.....	11
Electrical components with a housing.....	11
Electrical components without a housing.....	11
Individual components.....	11
Packaging.....	11
Expansion unit.....	19, 20

F

Flange.....	19, 20, 117
Functional ground.....	49, 55, 59, 153

G

General tolerance.....	14
GOST-R.....	169
Gosudarstwenny standard.....	169
Ground connection.....	49, 55, 59
Grounding.....	49, 55, 59, 153
Guidelines.....	14

H

Handles.....	127
HMI Service Center.....	167

I

Image persistence.....	199
------------------------	-----

Immunity to interference.....	153
Installation	
Automation Panel with flange.....	131
Expansion unit / expansion cover.....	147
Handles.....	144
Link module.....	135
Mounting unit.....	134
Operating elements on the expansion cover.....	148
Panel PC with flange.....	131
Rotary flange.....	136
Swing arm mounting unit.....	140
VESA mounting unit.....	143
Installing the DC power cable.....	151
Interfaces	
+24 VDC power supply.....	45, 49, 55, 59
Button/Switch.....	66
Grounding.....	49, 55, 59
Panel In.....	50
SDL3 In.....	56
SDL4 In.....	60
USB.....	52, 57, 65
USB In interface.....	53
K	
KC.....	169
KCF Editor.....	166
Key Editor.....	165
Key switch.....	62, 205, 212
L	
LEDs.....	56, 60
Link module.....	18, 20
Link modules.....	105
M	
Mechanical characteristics	
Dimensions.....	27
Mounting orientations.....	36
Weight.....	37
Mechanical properties.....	27
Mounting orientations.....	36, 36
Mounting unit.....	18, 111
Multi-touch.....	157
Multi-touch drivers.....	159
Multi-touch generation 3.....	216
P	
Panel.....	18, 20
Panel In interface.....	50
Panel overlay.....	202
Panel PC 2100 swing arm devices.....	17
Panels.....	67
Pixel errors.....	199
Power calculation.....	46, 46
Power connectors.....	171
Power grid connection	
DC power cable.....	151
Power rating.....	46

Power supply.....	45, 49, 55, 59
Proper ESD handling.....	11
Protection.....	44
Pushbutton.....	62

R

RCM.....	170
Removal	
Expansion unit / expansion cover.....	145
Swing arm mounting unit.....	138
VESA mounting unit.....	142
Removing the mounting unit cover.....	134
Repairs.....	199
Replacement parts.....	199
Resolution for DVI transfer.....	51
RS232 cables.....	196

S

Safety guidelines.....	11, 13
Environmental conditions.....	11
Environmentally friendly disposal.....	13
Installation.....	12
Intended use.....	11
Operation.....	12
Policies and procedures.....	11
Protection against electrostatic discharge.....	11
Separation of materials.....	13
Transport and storage.....	12
Screen burn-in.....	199
SDL3/SDL4 cables.....	190
SDL3 In interface.....	56
SDL3 In LEDs.....	56
SDL3 mode.....	25
With SDL3 transmitter.....	25
SDL3 resolution.....	56
SDL4 In interface.....	60
SDL4 In LEDs.....	60
SDL cables.....	180
SDL cables with 45° male connector.....	183
SDL flex cables.....	186
SDL operation.....	22
Mode 1.....	22
Mode 2.....	23
SDL resolution.....	51
SDL transmission.....	51, 51
Security concept.....	13
Selector switch.....	62, 204, 213
Serial interface.....	53
Service Center.....	167
Service life of the display.....	199
Single-touch.....	215
Software versions.....	161
Standards and guidelines.....	168
Swing arm mounting unit.....	20
Switch.....	62
Switching element.....	62
Switching on the device for the first time.....	155

T

Third-party software updates.....	13
Total power.....	46
Touch screen.....	215, 216
Touch screen calibration.....	156

U

UL certification.....	169
Unit.....	120
Universal Serial Bus 2.0.....	61
Upgrade	
Firmware.....	159
Upgrade information.....	159
Upgrading the firmware.....	159
USB.....	61
USB 2.0.....	52, 57, 65, 113, 115, 126
USB cables.....	194
USB flash drive.....	173
USB In interface.....	53
USB interface.....	65
USB interfaces.....	52, 57, 61
User serial ID.....	162

V

VESA.....	20
Video signal.....	50, 56, 60
Viewing angles.....	200

W

Wiring.....	151
-------------	-----