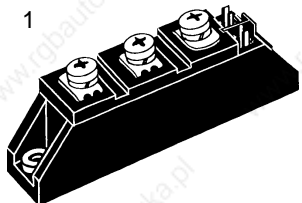
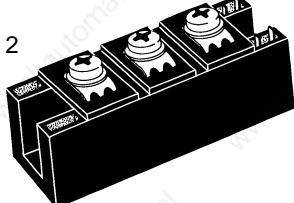
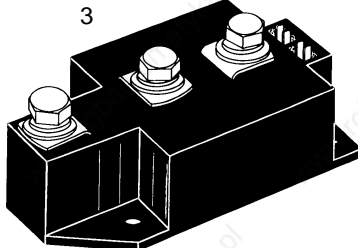
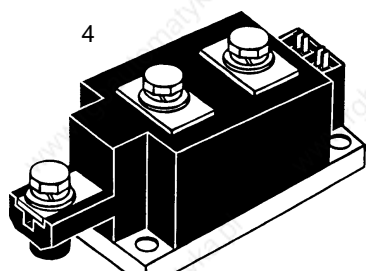
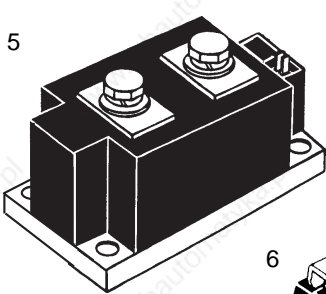
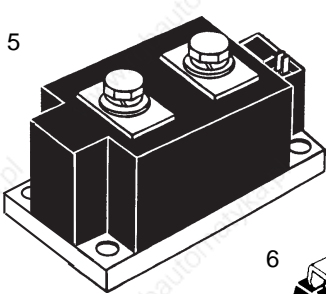
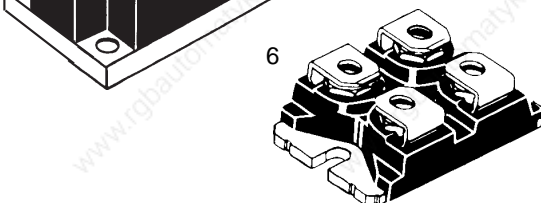

Package style	I _{TAVM} I _{FAVM} A	V _{RRM} / V _{DRM} (V)						Type	Page	
		800	1200	1400	1600	1800	2000			2200
Thyristor Modules										
	25	●	●	●	●			MCC 19	E2 - 2	
	21			●	●			MCC 21 <i>new</i>	E2 - 6	
	32	●	●	●	●			MCC 26	E2 - 8	
	51	●	●	●	●	●		MCC 44	E2 - 14	
	60	●	●	●	●	●		MCC 56	E2 - 18	
	64				●	●		MCC 60 <i>new</i>	E2 - 22	
	115	●	●	●	●	●		MCC 72	E2 - 24	
	104					●	●	MCC 94	E2 - 28	
	116	●	●	●	●			MCC 95	E2 - 30	
	130	●	●	●	●			MCC 122 <i>new</i>	E2 - 34	
	130	●	●	●	●			MCC 132	E2 - 36	
	165					●	●	MCC 161	E2 - 40	
	190	●	●	●	●			MCC 162	E2 - 42	
	203		●	●	●			MCC 170	E2 - 46	
	250	●	●	●	●			MCC 220	E2 - 50	
	240					●	●	MCC 224	E2 - 54	
	221		●	●	●	●		MCC 225	E2 - 58	
	287	●	●	●	●	●		MCC 250	E2 - 62	
	250		●	●	●			MCC 255	E2 - 66	
	320	●	●	●	●	●		MCC 310	E2 - 70	
	320		●	●	●	●		MCC 312	E2 - 74	
	464					●	●	MCO 450	E2 - 78	
	560		●	●	●	●		MCO 500	E2 - 82	
	600					●	●	MCO 600	E2 - 82	
	Thyristor / Diode Modules									
	32	●	●	●	●			MCD 26	E2 - 8	
	38		●	●	●			MCD 40	E2 - 12	
	51	●	●	●	●	●		MCD 44	E2 - 14	
	64	●	●	●	●	●		MCD 56	E2 - 18	
	64		600					MDC 56 <i>new</i>	E2 - 18	
	115	●	●	●	●	●		MCD 72	E2 - 24	
	104						●	●	MCD 94	E2 - 28
	116	●	●	●	●			MCD 95	E2 - 30	
	130	●	●	●	●			MCD 132	E2 - 36	
	165						●	●	MCD 161	E2 - 40
	190	●	●	●	●			MCD 162	E2 - 42	
	240					●	●	MCD 224 <i>new</i>	E2 - 54	
	250	●	●	●	●			MCD 220	E2 - 50	
	221		●	●	●	●		MCD 225	E2 - 58	
	287	●	●	●	●	●		MCD 250	E2 - 62	
	250		●	●	●	●		MCD 255	E2 - 66	
	320	●	●	●	●	●		MCD 310	E2 - 70	
	320		●	●	●	●		MCD 312	E2 - 74	
Recommended RC snubber network									E2 - 88	
Peak reverse recovery current									E2 - 88	

See also section E1
page 1 Discrete Thyristors

Recommended RC snubber network
Peak reverse recovery current

E2 - 88
E2 - 88

Thyristor Modules

$$I_{TRMS} = 2 \times 40 \text{ A}$$

$$I_{TAVM} = 2 \times 25 \text{ A}$$

$$V_{RRM} = 800\text{-}1600 \text{ V}$$

V_{RSM}	V_{RRM}	Type	
V_{DSM}	V_{DRM}	Version 1 B	Version 8 B
V	V		
900	800	MCC 19-08io1 B	MCC 19-08io8 B
1300	1200	MCC 19-12io1 B	MCC 19-12io8 B
1500	1400	MCC 19-14io1 B	MCC 19-14io8 B
1700	1600	MCC 19-16io1 B	MCC 19-16io8 B

TO-240 AA

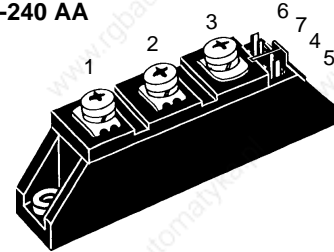

Symbol	Test Conditions	Maximum Ratings	
I_{TRMS}	$T_{VJ} = T_{VJM}$	40	A
I_{TAVM}	$T_C = 58^\circ\text{C}; 180^\circ \text{ sine}$	25	A
	$T_C = 85^\circ\text{C}; 180^\circ \text{ sine}$	18	A
I_{TSM}	$T_{VJ} = 45^\circ\text{C};$ $V_R = 0$	$t = 10 \text{ ms (50 Hz), sine}$ $t = 8.3 \text{ ms (60 Hz), sine}$	400 A 420 A
	$T_{VJ} = T_{VJM}$ $V_R = 0$	$t = 10 \text{ ms (50 Hz), sine}$ $t = 8.3 \text{ ms (60 Hz), sine}$	350 A 370 A
$\int i^2 dt$	$T_{VJ} = 45^\circ\text{C}$ $V_R = 0$	$t = 10 \text{ ms (50 Hz), sine}$ $t = 8.3 \text{ ms (60 Hz), sine}$	800 A ² s 730 A ² s
	$T_{VJ} = T_{VJM}$ $V_R = 0$	$t = 10 \text{ ms (50 Hz), sine}$ $t = 8.3 \text{ ms (60 Hz), sine}$	600 A ² s 570 A ² s
$(di/dt)_{cr}$	$T_{VJ} = T_{VJM}$ $f = 50 \text{ Hz}, t_p = 200 \mu\text{s}$ $V_D = 2/3 V_{DRM}$ $I_G = 0.45 \text{ A}$ $di_G/dt = 0.45 \text{ A}/\mu\text{s}$	repetitive, $I_T = 45 \text{ A}$	150 A/ μs
		non repetitive, $I_T = I_{TAVM}$	500 A/ μs
$(dv/dt)_{cr}$	$T_{VJ} = T_{VJM};$ $R_{GK} = \infty; \text{ method 1 (linear voltage rise)}$	$V_{DR} = 2/3 V_{DRM}$	1000 V/ μs
P_{GM}	$T_{VJ} = T_{VJM}$ $I_T = I_{TAVM}$	$t_p = 30 \mu\text{s}$ $t_p = 300 \mu\text{s}$	10 W 5 W
P_{GAV}			0.5 W
V_{RGM}			10 V
T_{VJ}			-40...+125 °C
T_{VJM}			125 °C
T_{stg}			-40...+125 °C
V_{ISOL}	50/60 Hz, RMS $I_{ISOL} \leq 1 \text{ mA}$	$t = 1 \text{ min}$ $t = 1 \text{ s}$	3000 V~ 3600 V~
M_d	Mounting torque (M5) Terminal connection torque (M5)		2.5-4.0/22-35 Nm/lb.in. 2.5-4.0/22-35 Nm/lb.in.
Weight	Typical including screws		90 g

Version 1 B

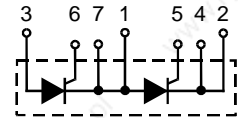

Version 8 B

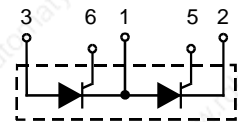

Features

- International standard package, JEDEC TO-240 AA
- Direct copper bonded Al₂O₃ -ceramic base plate
- Planar passivated chips
- Isolation voltage 3600 V~
- UL registered, E 72873
- Gate-cathode twin pins for version 1B

Applications

- DC motor control
- Softstart AC motor controller
- Light, heat and temperature control

Advantages

- Space and weight savings
- Simple mounting with two screws
- Improved temperature and power cycling
- Reduced protection circuits

Data according to IEC 60747 and refer to a single thyristor unless otherwise stated. IXYS reserves the right to change limits, test conditions and dimensions

Symbol	Test Conditions	Characteristic Values
I_{RRM}, I_{DRM}	$T_{VJ} = T_{VJM}; V_R = V_{RRM}; V_D = V_{DRM}$	3 mA
V_T	$I_T = 80 \text{ A}; T_{VJ} = 25^\circ\text{C}$	2.05 V
V_{T0}	For power-loss calculations only ($T_{VJ} = 125^\circ\text{C}$)	0.85 V
r_T		18 mΩ
V_{GT}	$V_D = 6 \text{ V}; T_{VJ} = 25^\circ\text{C}$	1.5 V
	$T_{VJ} = -40^\circ\text{C}$	1.6 V
I_{GT}	$V_D = 6 \text{ V}; T_{VJ} = 25^\circ\text{C}$	100 mA
	$T_{VJ} = -40^\circ\text{C}$	200 mA
V_{GD}	$T_{VJ} = T_{VJM}; V_D = 2/3 V_{DRM}$	0.2 V
I_{GD}		10 mA
I_L	$T_{VJ} = 25^\circ\text{C}; t_p = 10 \mu\text{s}; V_D = 6 \text{ V}$ $I_G = 0.45 \text{ A}; di_G/dt = 0.45 \text{ A}/\mu\text{s}$	450 mA
I_H	$T_{VJ} = 25^\circ\text{C}; V_D = 6 \text{ V}; R_{GK} = \infty$	200 mA
t_{gd}	$T_{VJ} = 25^\circ\text{C}; V_D = 1/2 V_{DRM}$ $I_G = 0.45 \text{ A}; di_G/dt = 0.45 \text{ A}/\mu\text{s}$	2 μs
t_q	$T_{VJ} = T_{VJM}; I_T = 20 \text{ A}, t_p = 200 \mu\text{s}; -di/dt = 10 \text{ A}/\mu\text{s}$ $V_R = 100 \text{ V}; dv/dt = 20 \text{ V}/\mu\text{s}; V_D = 2/3 V_{DRM}$	typ. 150 μs
Q_S	$T_{VJ} = T_{VJM}; I_T = 25 \text{ A}, -di/dt = 0.64 \text{ A}/\mu\text{s}$	50 μC
I_{RM}		6 A
R_{thJC}	per thyristor; DC current	1.3 K/W
	per module	} other values see Fig. 8/9
R_{thJK}	per thyristor; DC current	
	per module	1.5 K/W
		0.75 K/W
d_s	Creepage distance on surface	12.7 mm
d_A	Strike distance through air	9.6 mm
a	Maximum allowable acceleration	50 m/s ²

Optional accessories for module-type MCC 19 version 1 B

Keyed gate/cathode twin plugs with wire length = 350 mm, gate = yellow, cathode = red

Type ZY 200L (L = Left for pin pair 4/5) } UL 758, style 1385,

Type ZY 200R (R = right for pin pair 6/7) } CSA class 5851, guide 460-1-1

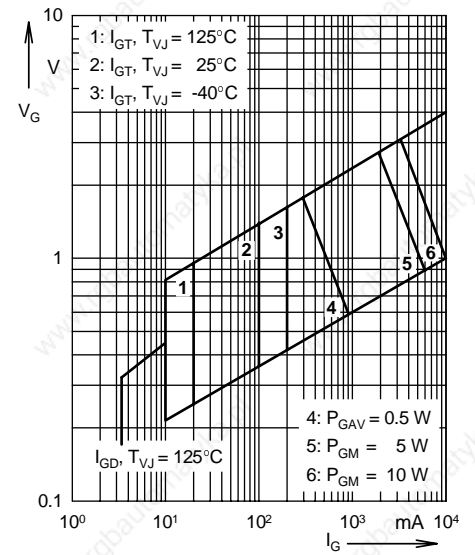

Fig. 1 Gate trigger characteristics

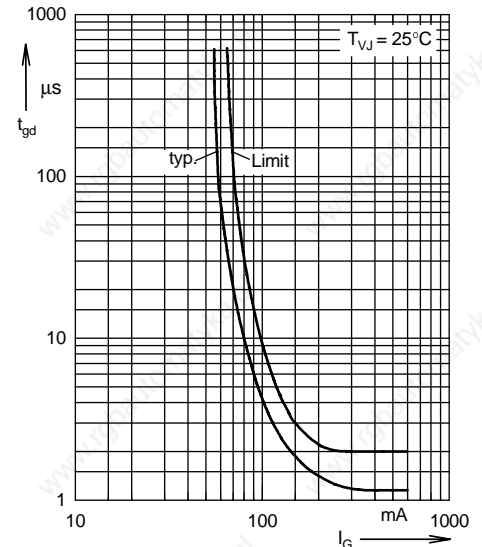
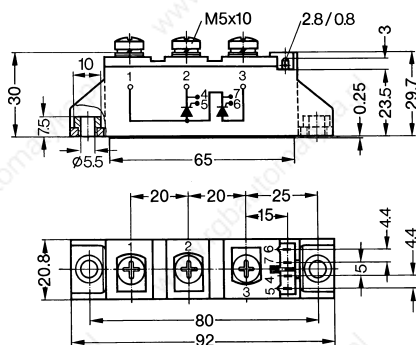

Fig. 2 Gate trigger delay time

Dimensions in mm (1 mm = 0.0394")

Version 1 B



Version 8 B

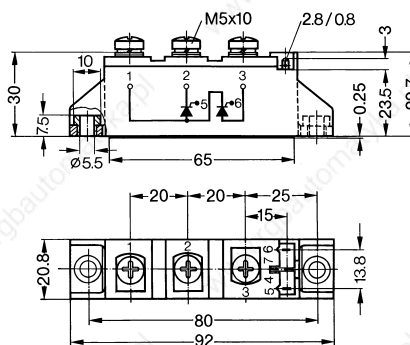

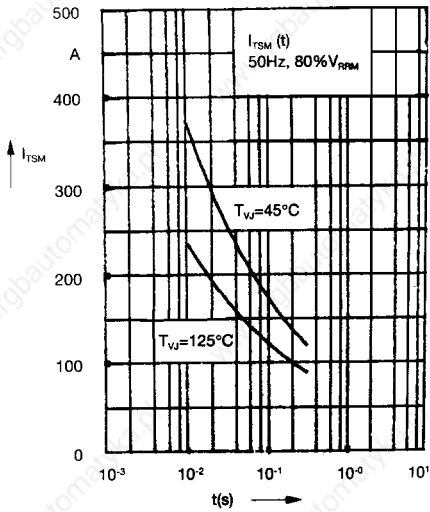

Fig. 3 Surge overload current
 I_{TSM} : Crest value, t : duration

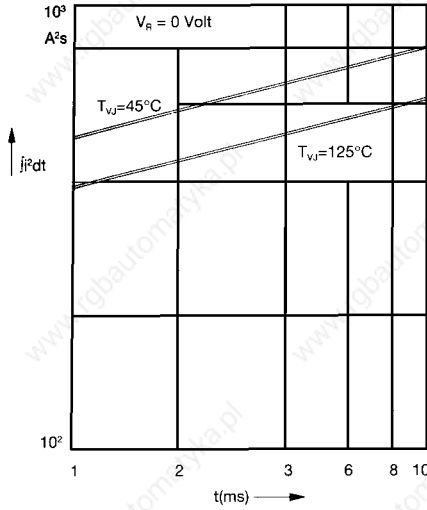

Fig. 4 $\int i^2 dt$ versus time (1-10 ms)

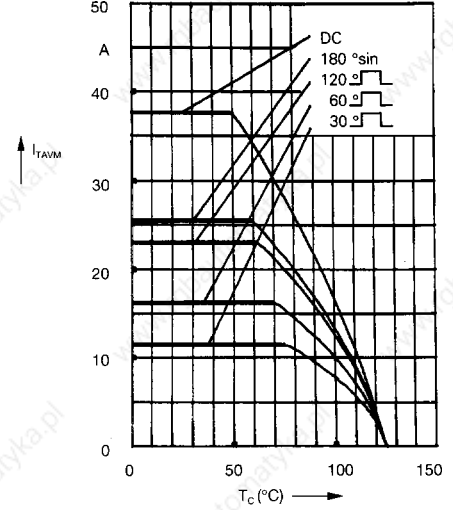

Fig. 4a Maximum forward current at case temperature

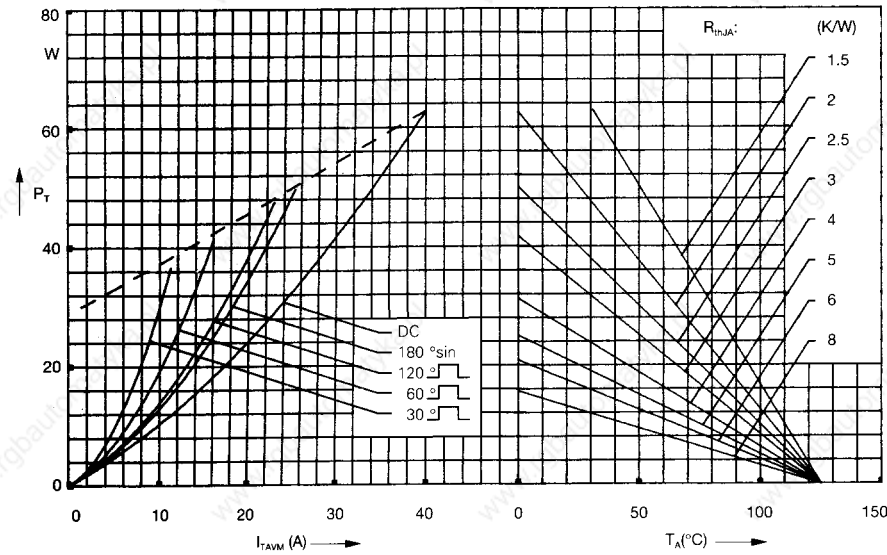

Fig. 5 Power dissipation versus on-state current and ambient temperature (per thyristor)

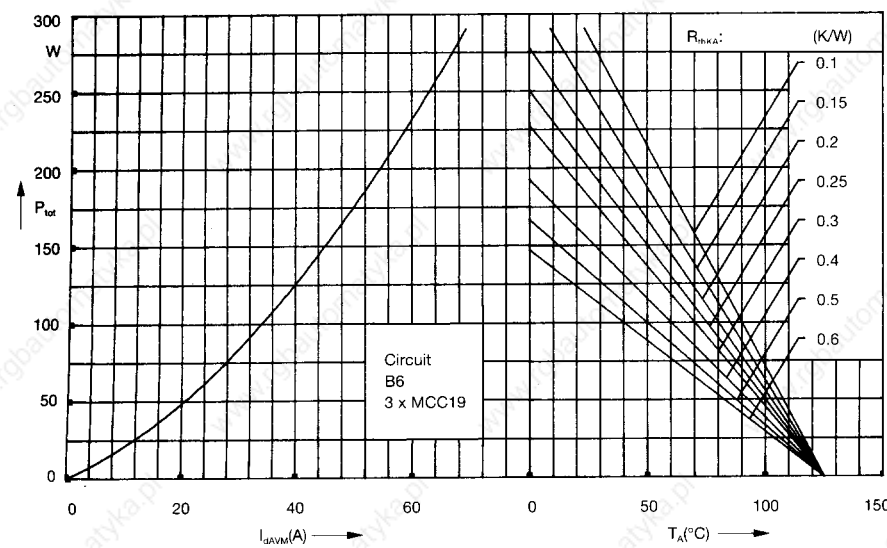

Fig. 6 Three phase rectifier bridge: Power dissipation versus direct output current and ambient temperature

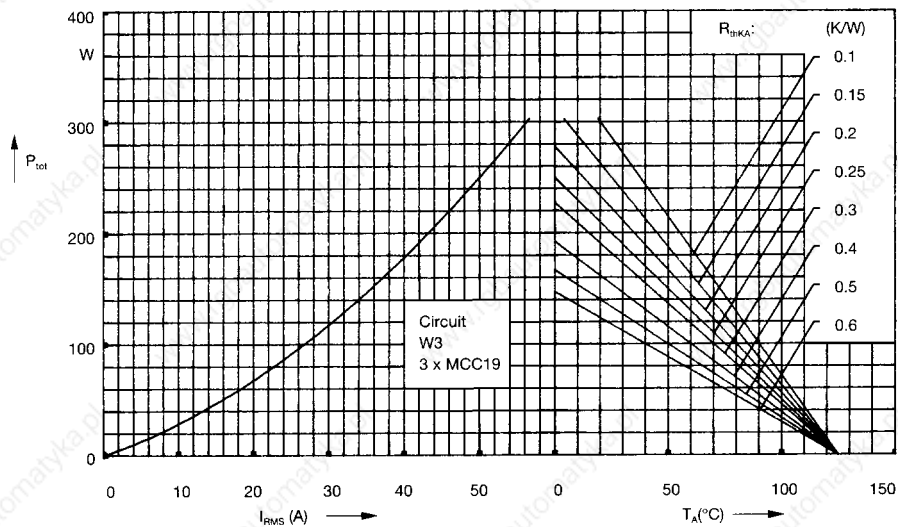

Fig. 7 Three phase AC-controller: Power dissipation versus RMS output current and ambient temperature

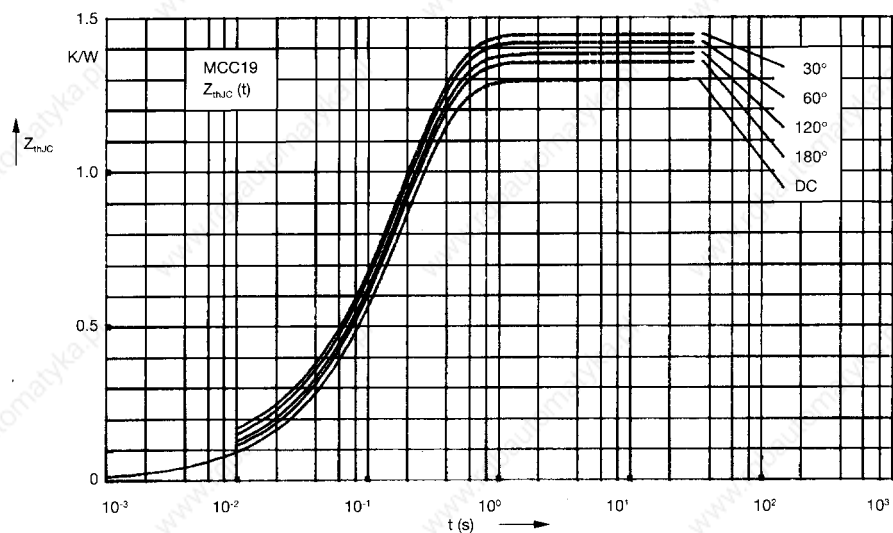

Fig. 8 Transient thermal impedance junction to case (per thyristor)

R_{thJC} for various conduction angles d:

d	R_{thJC} (K/W)
DC	1.3
180°	1.35
120°	1.39
60°	1.42
30°	1.45

Constants for Z_{thJC} calculation:

i	R_{thi} (K/W)	t_i (s)
1	0.018	0.0033
2	0.041	0.0216
3	1.241	0.191

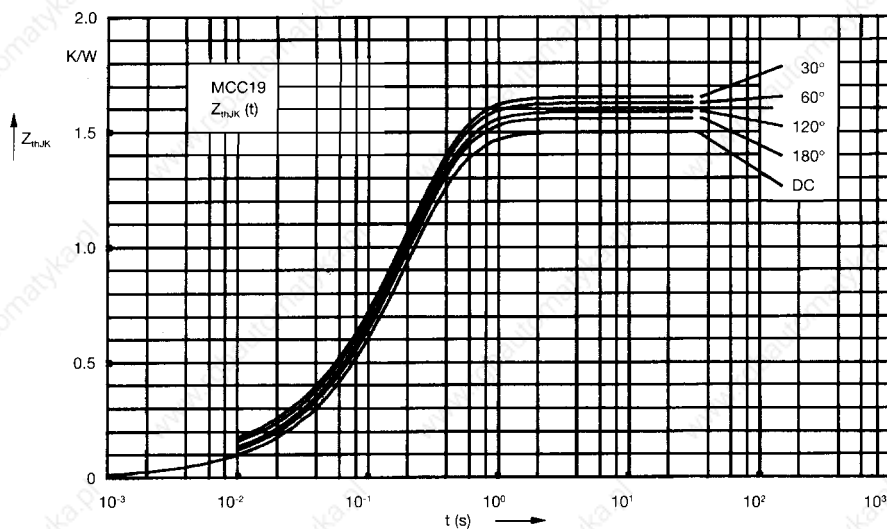

Fig. 9 Transient thermal impedance junction to heatsink (per thyristor)

R_{thJK} for various conduction angles d:

d	R_{thJK} (K/W)
DC	1.5
180°	1.55
120°	1.59
60°	1.62
30°	1.65

Constants for Z_{thJK} calculation:

i	R_{thi} (K/W)	t_i (s)
1	0.018	0.0033
2	0.041	0.0216
3	1.241	0.191
4	0.2	0.46

Thyristor Modules

V_{RSM}	V_{RRM}	Type
V_{DSM}	V_{DRM}	
V	V	
900	800	MCC 21-08io8 B
1300	1200	MCC 21-12io8 B
1500	1400	MCC 21-14io8 B
1700	1600	MCC 21-16io8 B

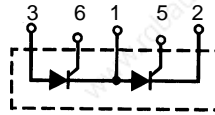

TO-240 AA

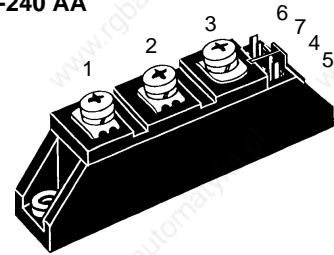

Symbol	Conditions	Maximum Ratings	
I_{TRMS}	$T_{VJ} = T_{VJM}$	33	A
I_{TAVM}	$T_C = 85^{\circ}\text{C}; 180^{\circ}$ sine	21	A
I_{TSM}	$T_{VJ} = 45^{\circ}\text{C}; V_R = 0$	$t = 10$ ms (50 Hz), sine	320 A
		$t = 8.3$ ms (60 Hz), sine	350 A
I^2dt	$T_{VJ} = T_{VJM}; V_R = 0$	$t = 10$ ms (50 Hz), sine	280 A
		$t = 8.3$ ms (60 Hz), sine	310 A
$(di/dt)_{cr}$	$T_{VJ} = T_{VJM}; f = 50\text{Hz}; t_p = 200\mu\text{s}$	repetitive, $I_T = 45$ A	150 A/ μs
	$V_D = 2/3 V_{DRM}; I_G = 0.45$ A	non repetitive, $I_T = I_{TAVM}$	500 A/ μs
$(dv/dt)_{cr}$	$T_{VJ} = T_{VJM}; V_{DR} = 2/3 V_{DRM}; R_{GK} = \infty; \text{method 1 (linear voltage rise)}$		1000 V/ μs
	P_{GM}	$T_{VJ} = T_{VJM}; t_p = 30 \mu\text{s}$	10 W
	$I_T = I_{TAVM}; t_p = 300 \mu\text{s}$	5 W	
P_{GAV}		0.5	W
V_{RGM}		10	V
T_{VJ}		-40...+125	$^{\circ}\text{C}$
T_{VJM}		125	$^{\circ}\text{C}$
T_{stg}		-40...+125	$^{\circ}\text{C}$
V_{ISOL}	50/60 Hz, RMS	$t = 1$ min	3000 V~
	$I_{ISOL} \leq 1$ mA	$t = 1$ s	3600 V~
M_d	Mounting torque (M5)	2.5-4.0/22-35	Nm/lb.in.
	Terminal connection torque (M5)	2.5-4.0/22-35	Nm/lb.in.
Weight	Typical including screws	90	g

Features

- International standard package, JEDEC TO-240 AA
- Direct copper bonded Al_2O_3 -ceramic base plate
- Planar passivated chips
- Isolation voltage 3600 V~
- UL registered, E 72873
- Gate-cathode twin pins for version 1B

Applications

- DC motor control
- Softstart AC motor controller
- Light, heat and temperature control

Advantages

- Space and weight savings
- Simple mounting with two screws
- Improved temperature and power cycling
- Reduced protection circuits

Data according to DIN/IEC 747 and refer to a single thyristor unless otherwise stated.

Symbol	Conditions	Characteristic Values
I_{RRM}, I_{DRM}	$T_{VJ} = T_{VJM}; V_R = V_{RRM}; V_D = V_{DRM}$	5 mA
V_T	$I_T = 45 \text{ A}; T_{VJ} = 25^\circ\text{C}$	1.6 V
V_{T0}	For power-loss calculations only ($T_{VJ} = 125^\circ\text{C}$)	0.85 V
r_T		15 mΩ
V_{GT}	$V_D = 6 \text{ V}; T_{VJ} = 25^\circ\text{C}$ $T_{VJ} = -40^\circ\text{C}$	1.0 V 1.2 V
I_{GT}	$V_D = 6 \text{ V}; T_{VJ} = 25^\circ\text{C}$ $T_{VJ} = -40^\circ\text{C}$	65 mA 80 mA
V_{GD} I_{GD}	$T_{VJ} = T_{VJM}; V_D = \frac{2}{3} V_{DRM}$	0.2 V 5 mA
I_L	$T_{VJ} = 25^\circ\text{C}; t_p = 10 \mu\text{s}; V_D = 6 \text{ V}$ $I_G = 0.3 \text{ A}; di_G/dt = 0.3 \text{ A}/\mu\text{s}$	150 mA
I_H	$T_{VJ} = 25^\circ\text{C}; V_D = 6 \text{ V}; R_{GK} = \infty$	100 mA
t_{gd}	$T_{VJ} = 25^\circ\text{C}; V_D = \frac{1}{2} V_{DRM}$ $I_G = 0.3 \text{ A}; di_G/dt = 0.3 \text{ A}/\mu\text{s}$	2 μs
t_q	$T_{VJ} = T_{VJM}; I_T = 15 \text{ A}, t_p = 300 \mu\text{s}; -di/dt = 10 \text{ A}/\mu\text{s}$ $V_R = 100 \text{ V}; dv/dt = 20 \text{ V}/\mu\text{s}; V_D = \frac{2}{3} V_{DRM}$	typ. 150 μs
I_{RM}	$T_{VJ} = T_{VJM}; I_T = 30 \text{ A}, -di/dt = 0.3 \text{ A}/\mu\text{s}$	4 A
R_{thJC}	per thyristor; DC current	1.1 K/W
	per module	0.55 K/W
R_{thJK}	per thyristor; DC current	1.3 K/W
	per module	0.65 K/W
	other values see Fig. 8/9	
d_s	Creepage distance on surface	12.7 mm
d_A	Strike distance through air	9.6 mm
a	Maximum allowable acceleration	50 m/s ²

Optional accessories for module-type MCC 23 version 1 B

Keyed gate/cathode twin plugs with wire length = 350 mm, gate = yellow, cathode = red

Type **ZY 200L** (L = Left for pin pair 4/5) } UL 758, style 1385,

Type **ZY 200R** (R = right for pin pair 6/7) } CSA class 5851, guide 460-1-1

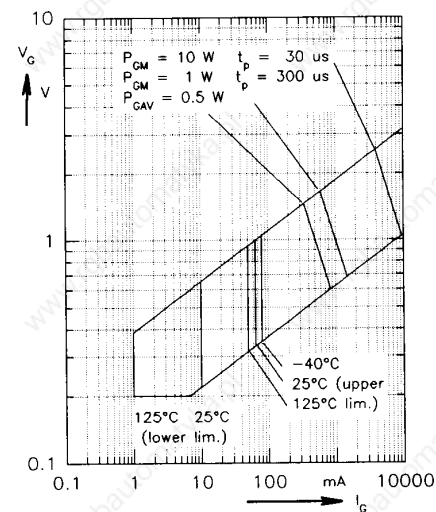

Fig. 1 Gate trigger characteristics

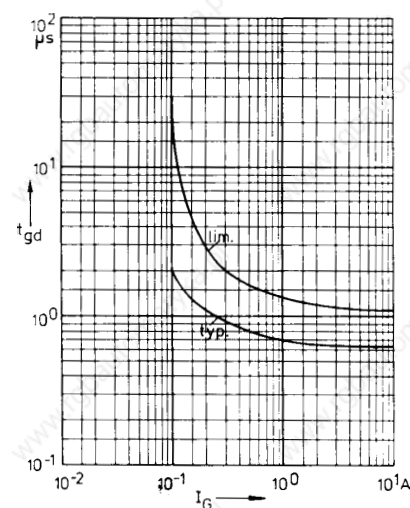
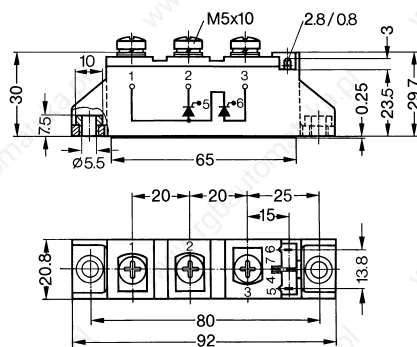

Fig. 2 Gate trigger delay time

Dimensions in mm (1 mm = 0.0394")



Thyristor Modules Thyristor/Diode Modules

$I_{TRMS} = 2x 50 A$
 $I_{TAVM} = 2x 32 A$
 $V_{RRM} = 800-1600 V$

V_{RSM}	V_{RRM}	Type		
V_{DSM}	V_{DRM}	Version 1 B	Version 8 B	Version 8 B
V	V			
900	800	MCC 26-08io1 B	MCC 26-08io8 B	MCD 26-08io8 B
1300	1200	MCC 26-12io1 B	MCC 26-12io8 B	MCD 26-12io8 B
1500	1400	MCC 26-14io1 B	MCC 26-14io8 B	MCD 26-14io8 B
1700	1600	MCC 26-16io1 B	MCC 26-16io8 B	MCD 26-16io8 B

TO-240 AA

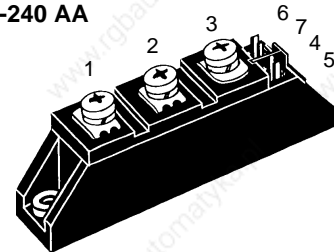

Symbol	Test Conditions	Maximum Ratings		
I_{TRMS}^1 , I_{FRMS} I_{TAVM}^1 , I_{FAVM}	$T_{VJ} = T_{VJM}$ $T_C = 75^{\circ}C$; 180° sine $T_C = 85^{\circ}C$; 180° sine	50 32 27	A A A	
I_{TSM}^1 , I_{FSM}	$T_{VJ} = 45^{\circ}C$; $V_R = 0$ $T_{VJ} = T_{VJM}$ $V_R = 0$	$t = 10$ ms (50 Hz), sine $t = 8.3$ ms (60 Hz), sine $t = 10$ ms (50 Hz), sine $t = 8.3$ ms (60 Hz), sine	520 560 460 500	A A A A
f^2dt	$T_{VJ} = 45^{\circ}C$ $V_R = 0$ $T_{VJ} = T_{VJM}$ $V_R = 0$	$t = 10$ ms (50 Hz), sine $t = 8.3$ ms (60 Hz), sine $t = 10$ ms (50 Hz), sine $t = 8.3$ ms (60 Hz), sine	1350 1300 1050 1030	A ² s A ² s A ² s A ² s
$(di/dt)_{cr}$	$T_{VJ} = T_{VJM}$ $f = 50$ Hz, $t_p = 200$ μ s $V_D = 2/3 V_{DRM}$ $I_G = 0.45$ A $di_G/dt = 0.45$ A/ μ s	repetitive, $I_T = 45$ A non repetitive, $I_T = I_{TAVM}$	150 500	A/ μ s A/ μ s
$(dv/dt)_{cr}$	$T_{VJ} = T_{VJM}$; $R_{GK} = \infty$; method 1 (linear voltage rise)	$V_{DR} = 2/3 V_{DRM}$	1000	V/ μ s
P_{GM}	$T_{VJ} = T_{VJM}$ $I_T = I_{TAVM}$	$t_p = 30$ μ s $t_p = 300$ μ s	10 5 0.5	W W W
P_{GAV}			10	V
V_{RGM}			10	V
T_{VJ}			-40...+125	°C
T_{VJM}			125	°C
T_{stg}			-40...+125	°C
V_{ISOL}	50/60 Hz, RMS $I_{ISOL} \leq 1$ mA	$t = 1$ min $t = 1$ s	3000 3600	V~ V~
M_d	Mounting torque (M5) Terminal connection torque (M5)		2.5-4.0/22-35 2.5-4.0/22-35	Nm/lb.in. Nm/lb.in.
Weight	Typical including screws		90	g

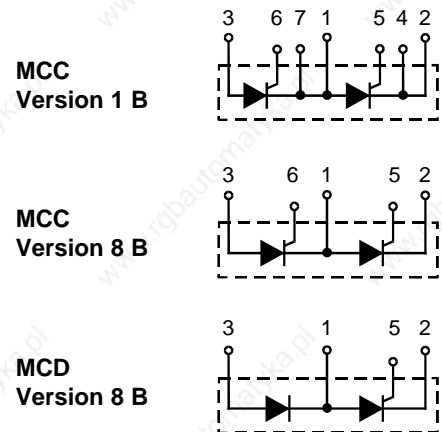

Features

- International standard package, JEDEC TO-240 AA
- Direct copper bonded Al₂O₃ -ceramic base plate
- Planar passivated chips
- Isolation voltage 3600 V~
- UL registered, E 72873
- Gate-cathode twin pins for version 1B

Applications

- DC motor control
- Softstart AC motor controller
- Light, heat and temperature control

Advantages

- Space and weight savings
- Simple mounting with two screws
- Improved temperature and power cycling
- Reduced protection circuits

Data according to IEC 60747 and refer to a single thyristor/diode unless otherwise stated. IXYS reserves the right to change limits, test conditions and dimensions

Symbol	Test Conditions	Characteristic Values
I_{RRM}, I_{DRM}	$T_{VJ} = T_{VJM}; V_R = V_{RRM}; V_D = V_{DRM}$	3 mA
V_T, V_F	$I_T, I_F = 80 \text{ A}; T_{VJ} = 25^\circ\text{C}$	1.64 V
V_{T0}	For power-loss calculations only ($T_{VJ} = 125^\circ\text{C}$)	0.85 V
r_T		11.0 mΩ
V_{GT}	$V_D = 6 \text{ V}; T_{VJ} = 25^\circ\text{C}$	1.5 V
	$T_{VJ} = -40^\circ\text{C}$	1.6 V
I_{GT}	$V_D = 6 \text{ V}; T_{VJ} = 25^\circ\text{C}$	100 mA
	$T_{VJ} = -40^\circ\text{C}$	200 mA
V_{GD}	$T_{VJ} = T_{VJM}; V_D = 2/3 V_{DRM}$	0.2 V
I_{GD}		10 mA
I_L	$T_{VJ} = 25^\circ\text{C}; t_p = 10 \mu\text{s}; V_D = 6 \text{ V}$ $I_G = 0.45 \text{ A}; di_G/dt = 0.45 \text{ A}/\mu\text{s}$	450 mA
I_H	$T_{VJ} = 25^\circ\text{C}; V_D = 6 \text{ V}; R_{GK} = \infty$	200 mA
t_{gd}	$T_{VJ} = 25^\circ\text{C}; V_D = 1/2 V_{DRM}$ $I_G = 0.45 \text{ A}; di_G/dt = 0.45 \text{ A}/\mu\text{s}$	2 μs
t_q	$T_{VJ} = T_{VJM}; I_T = 20 \text{ A}, t_p = 200 \mu\text{s}; -di/dt = 10 \text{ A}/\mu\text{s}$ typ. $V_R = 100 \text{ V}; dv/dt = 20 \text{ V}/\mu\text{s}; V_D = 2/3 V_{DRM}$	150 μs
Q_S	$T_{VJ} = T_{VJM}; I_T, I_F = 25 \text{ A}, -di/dt = 0.64 \text{ A}/\mu\text{s}$	50 μC
I_{RM}		6 A
R_{thJC}	per thyristor/diode; DC current per module	0.88 K/W
R_{thJK}	per thyristor/diode; DC current per module	1.08 K/W
	other values see Fig. 8/9	0.44 K/W
		0.54 K/W
d_s	Creepage distance on surface	12.7 mm
d_A	Strike distance through air	9.6 mm
a	Maximum allowable acceleration	50 m/s ²

Optional accessories for module-type MCC 26 version 1 B

Keyed gate/cathode twin plugs with wire length = 350 mm, gate = yellow, cathode = red

Type ZY 200L (L = Left for pin pair 4/5) } UL 758, style 1385,
Type ZY 200R (R = right for pin pair 6/7) } CSA class 5851, guide 460-1-1

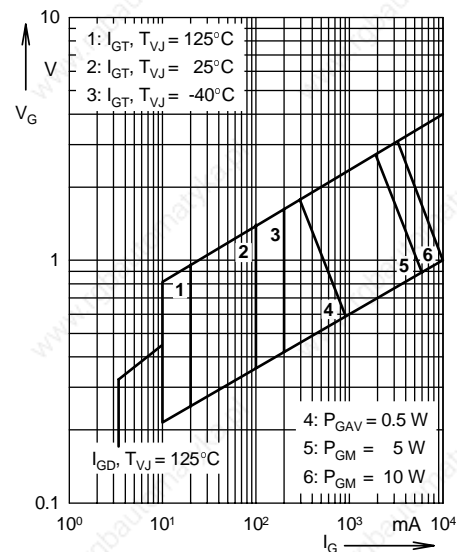

Fig. 1 Gate trigger characteristics

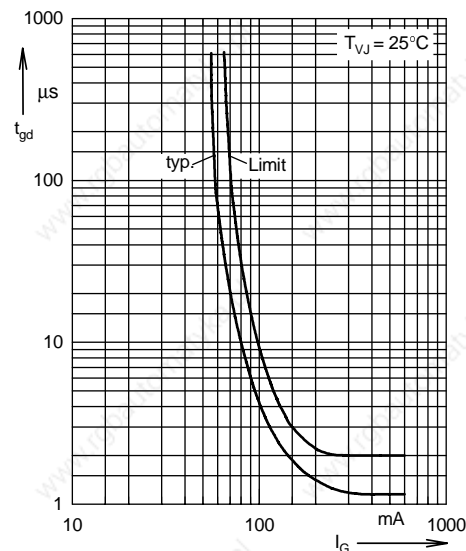
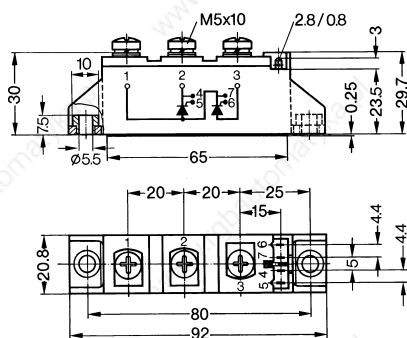

Fig. 2 Gate trigger delay time

Dimensions in mm (1 mm = 0.0394")

MCC Version 1 B



MCC Version 8 B

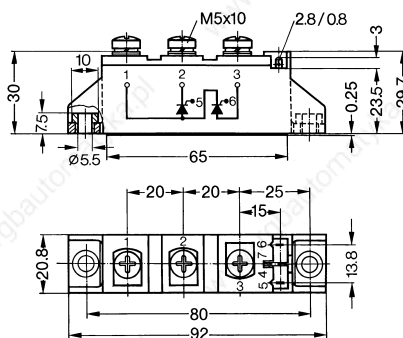

MCD Version 8 B

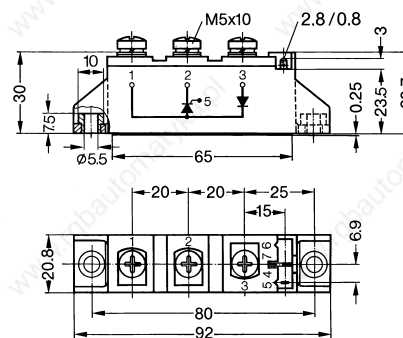

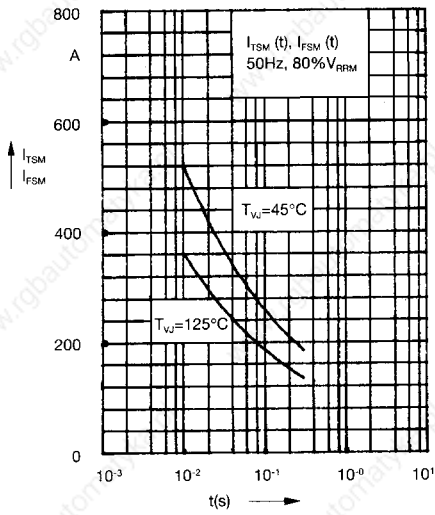

Fig. 3 Surge overload current
 I_{TSM}, I_{FSM} : Crest value, t : duration

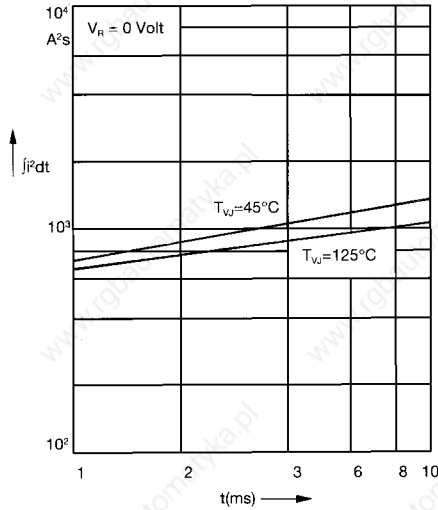

Fig. 4 $\int i^2 dt$ versus time (1-10 ms)

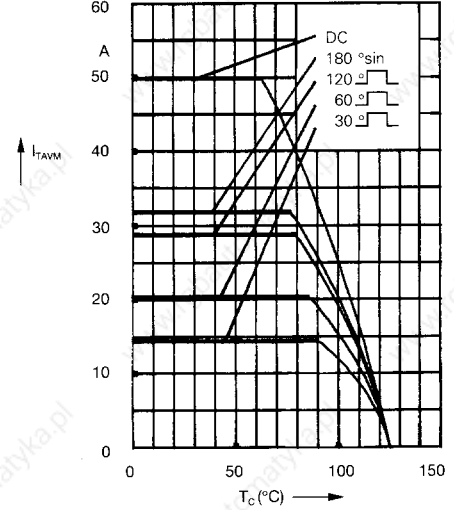

Fig. 4a Maximum forward current at case temperature

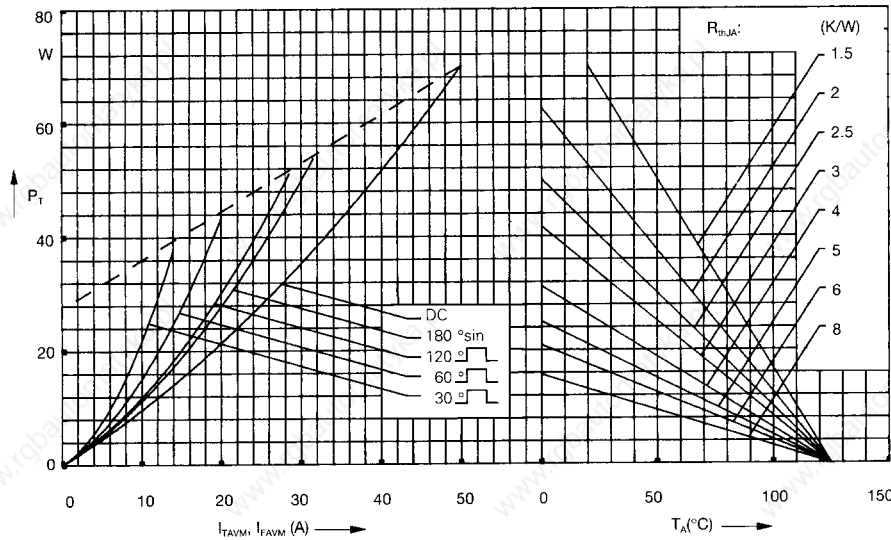

Fig. 5 Power dissipation versus on-state current and ambient temperature (per thyristor or diode)

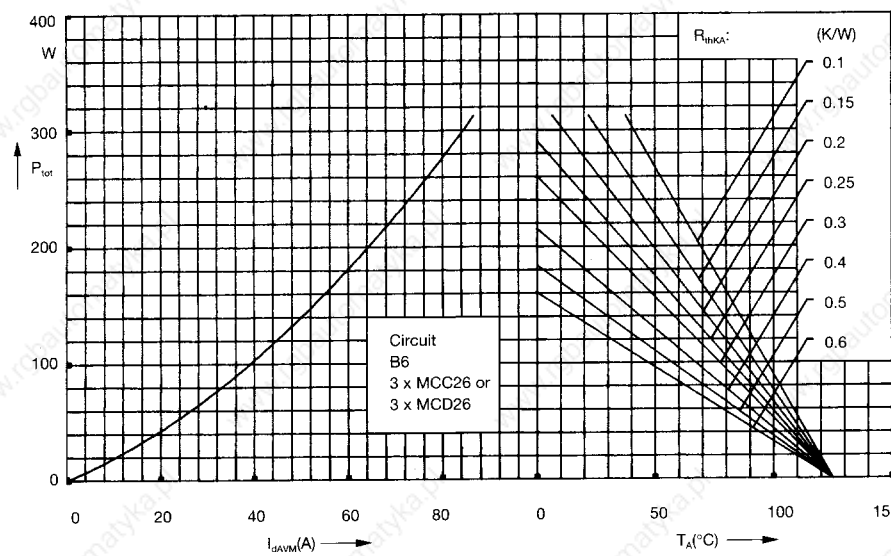

Fig. 6 Three phase rectifier bridge: Power dissipation versus direct output current and ambient temperature

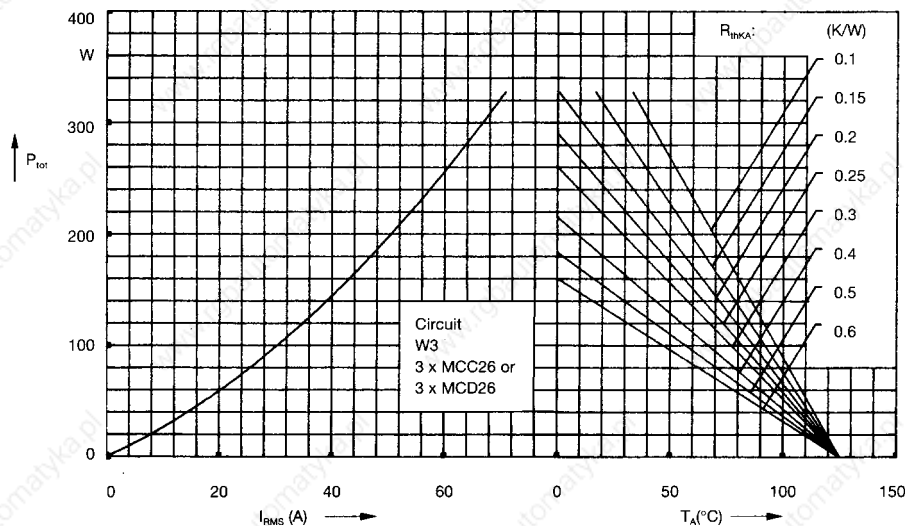

Fig. 7 Three phase AC-controller:
Power dissipation versus RMS
output current and ambient
temperature

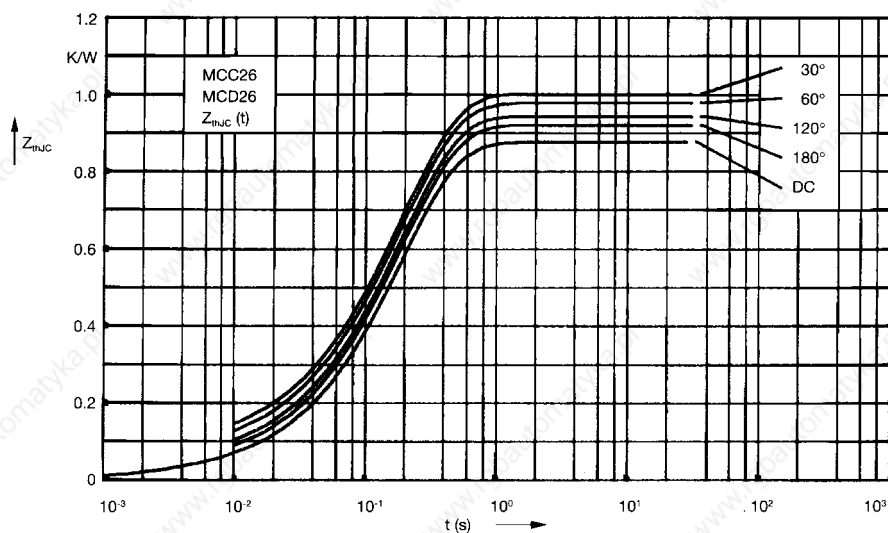

Fig. 8 Transient thermal impedance
junction to case (per thyristor or
diode)

R_{thJC} for various conduction angles d :

d	R_{thJC} (K/W)
DC	0.88
180°	0.92
120°	0.95
60°	0.98
30°	1.01

Constants for Z_{thJC} calculation:

i	R_{thi} (K/W)	t_i (s)
1	0.019	0.0031
2	0.029	0.0216
3	0.832	0.191

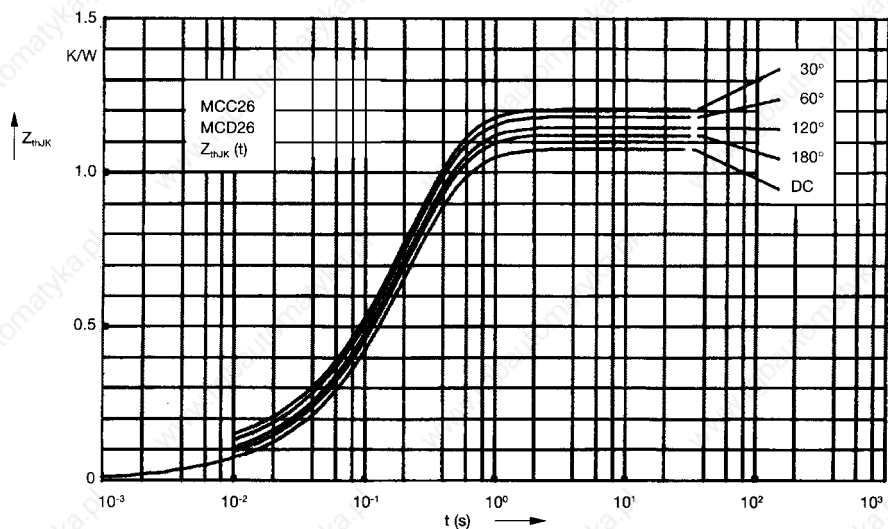

Fig. 9 Transient thermal impedance
junction to heatsink (per thyristor
or diode)

R_{thJK} for various conduction angles d :

d	R_{thJK} (K/W)
DC	1.08
180°	1.12
120°	1.15
60°	1.18
30°	1.21

Constants for Z_{thJK} calculation:

i	R_{thi} (K/W)	t_i (s)
1	0.019	0.0031
2	0.029	0.0216
3	0.832	0.191
4	0.2	0.45

Thyristor/Diode Module

$$I_{TRMS} = 2 \times 60 \text{ A}$$

$$I_{TAVM} = 2 \times 38 \text{ A}$$

$$V_{RRM} = 1200-1600 \text{ V}$$

Preliminary data

V_{RSM} V_{DSM} V	V_{RRM} V_{DRM} V	Type
1300	1200	MCD 40-12io6
1700	1600	MCD 40-16io6

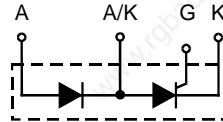

SOT-227 B,
miniBLOC

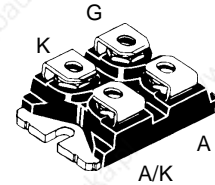

K = Cathode, A = Anode, G = Gate,
A/K = Common output

Symbol	Test Conditions	Maximum Ratings
I_{TRMS}^1 , I_{FRMS}	$T_{VJ} = T_{VJM}$; $T_C = 85^\circ\text{C}$	60 A
I_{TAVM}^2 , I_{FAVM}	$T_{VJ} = T_{VJM}$; $T_C = 85^\circ\text{C}$; 180° sine	38 A
I_{TSM}^3 , I_{FSM}	$T_{VJ} = 45^\circ\text{C}$; $V_R = 0$	$t = 10 \text{ ms}$ (50 Hz), sine 500 A
		$t = 8.3 \text{ ms}$ (60 Hz), sine 440 A
j^2dt	$T_{VJ} = 45^\circ\text{C}$ $V_R = 0$	$t = 10 \text{ ms}$ (50 Hz), sine 1250 A ² s
		$t = 8.3 \text{ ms}$ (60 Hz), sine 1220 A ² s
$(di/dt)_{cr}$	$T_{VJ} = T_{VJM}$ $f = 50 \text{ Hz}$, $t_p = 200 \mu\text{s}$ $V_D = 2/3 V_{DRM}$ $I_G = 0.45 \text{ A}$ $di_G/dt = 0.45 \text{ A}/\mu\text{s}$	repetitive, $I_T = 45 \text{ A}$ 100 A/ μs
		non repetitive, $I_T = I_{TAVM}$ 500 A/ μs
$(dv/dt)_{cr}$	$T_{VJ} = T_{VJM}$; $R_{GK} = \infty$; method 1 (linear voltage rise)	$V_{DR} = 2/3 V_{DRM}$ 1000 V/ μs
P_{GM}	$T_{VJ} = T_{VJM}$	$t_p = 30 \mu\text{s}$ 10 W
	$I_T = I_{TAVM}$	$t_p = 300 \mu\text{s}$ 5 W
P_{GAV}		0.5 W
V_{RGM}		10 V
T_{VJ}		-40...+125 °C
T_{VJM}		125 °C
T_{stg}		-40...+125 °C
V_{ISOL}	50/60 Hz, RMS	$I_{ISOL} \leq 1 \text{ mA}$ 2500 V~
M_d	Mounting torque (M4)	1.5/13 Nm/lb.in.
	Terminal connection torque (M4)	1.5/13 Nm/lb.in.
Weight	Typical including screws	30 g

Features

- International standard package miniBLOC, SOT-227 B
- Planar passivated chips

Applications

- DC motor control
- Softstart AC motor controller
- Light, heat and temperature control
- Half controlled rectifier bridge

Advantages

- Space and weight savings
- Simple mounting with two screws
- Improved temperature and power cycling
- Reduced protection circuits

Data according to IEC 60747 refer to a single thyristor/diode unless otherwise stated.
IXYS reserves the right to change limits, test conditions and dimensions

Symbol	Test Conditions	Characteristic Values
I_{RRM}, I_{DRM}	$T_{VJ} = T_{VJM}; V_R = V_{RRM}; V_D = V_{DRM}$	5 mA
V_T, V_F	$I_T, I_F = 80 \text{ A}; T_{VJ} = 25^\circ\text{C}$	1.68 V
V_{T0} r_T	For power-loss calculations only ($T_{VJ} = 125^\circ\text{C}$)	0.85 V 9.5 mΩ
V_{GT}	$V_D = 6 \text{ V}; T_{VJ} = 25^\circ\text{C}$ $T_{VJ} = -40^\circ\text{C}$	1.5 V 1.6 V
I_{GT}	$V_D = 6 \text{ V}; T_{VJ} = 25^\circ\text{C}$ $T_{VJ} = -40^\circ\text{C}$	100 mA 200 mA
V_{GD} I_{GD}	$T_{VJ} = T_{VJM}; V_D = 2/3 V_{DRM}$	0.2 V 5 mA
I_L	$T_{VJ} = 25^\circ\text{C}; t_p = 10 \mu\text{s}, V_D = 6 \text{ V}$ $I_G = 0.45 \text{ A}; di_G/dt = 0.45 \text{ A}/\mu\text{s}$	450 mA
I_H	$T_{VJ} = 25^\circ\text{C}; V_D = 6 \text{ V}; R_{GK} = \infty$	200 mA
t_{gd}	$T_{VJ} = 25^\circ\text{C}; V_D = 1/2 V_{DRM}$ $I_G = 0.45 \text{ A}; di_G/dt = 0.45 \text{ A}/\mu\text{s}$	2 μs
t_q	$T_{VJ} = T_{VJM}; I_T = 120 \text{ A}, t_p = 200 \mu\text{s}; -di/dt = 10 \text{ A}/\mu\text{s}$ $V_R = 100 \text{ V}; dv/dt = 20 \text{ V}/\mu\text{s}; V_D = 2/3 V_{DRM}$	typ. 150 μs
R_{thJC} R_{thCH}	per thyristor/diode; DC current	0.6 K/W 0.1 K/W
d_s	Creepage distance on surface	8 mm
d_A	Strike distance through air	4 mm
a	Maximum allowable acceleration	50 m/s ²

miniBLOC, SOT-227 B

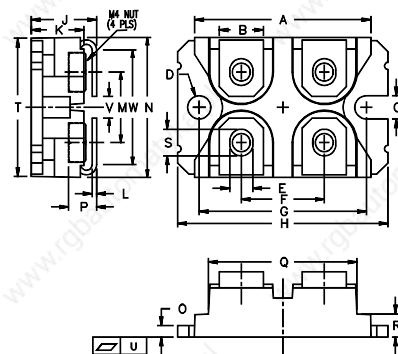

M4 screws (4x) supplied

Dim.	Millimeter		Inches	
	Min.	Max.	Min.	Max.
A	31.50	31.88	1.240	1.255
B	7.80	8.20	0.307	0.323
C	4.09	4.29	0.161	0.169
D	4.09	4.29	0.161	0.169
E	4.09	4.29	0.161	0.169
F	14.91	15.11	0.587	0.595
G	30.12	30.30	1.186	1.193
H	37.80	38.20	1.489	1.505
J	11.68	12.22	0.460	0.481
K	8.92	9.60	0.351	0.378
L	0.76	0.84	0.030	0.033
M	12.60	12.85	0.496	0.506
N	25.15	25.42	0.990	1.001
O	1.98	2.13	0.078	0.084
P	4.95	5.97	0.195	0.235
Q	26.54	26.90	1.045	1.059
R	3.94	4.42	0.155	0.174
S	4.72	4.85	0.186	0.191
T	24.59	25.07	0.968	0.987
U	-0.05	0.1	-0.002	0.004
V	3.30	4.57	0.130	0.180
W	0.780	0.830	0.031	0.033

Thyristor Modules Thyristor/Diode Modules

$$I_{TRMS} = 2 \times 80 \text{ A}$$

$$I_{TAVM} = 2 \times 51 \text{ A}$$

$$V_{RRM} = 800-1800 \text{ V}$$

V_{RSM}	V_{RRM}	Type		
V_{DSM}	V_{DRM}	Version 1 B	Version 8 B	Version 8 B
V	V			
900	800	MCC 44-08io1 B	MCC 44-08io8 B	MCD 44-08io8 B
1300	1200	MCC 44-12io1 B	MCC 44-12io8 B	MCD 44-12io8 B
1500	1400	MCC 44-14io1 B	MCC 44-14io8 B	MCD 44-14io8 B
1700	1600	MCC 44-16io1 B	MCC 44-16io8 B	MCD 44-16io8 B
1900	1800	MCC 44-18io1 B	MCC 44-18io8 B	MCD 44-18io8 B

Symbol	Test Conditions	Maximum Ratings	
I_{TRMS}^*, I_{FRMS} I_{TAVM}^*, I_{FAVM}	$T_{VJ} = T_{VJM}$ $T_C = 83^\circ\text{C}; 180^\circ \text{ sine}$ $T_C = 85^\circ\text{C}; 180^\circ \text{ sine}$	80 51 49	A A A
I_{TSM}^*, I_{FSM}	$T_{VJ} = 45^\circ\text{C};$ $V_R = 0$	$t = 10 \text{ ms (50 Hz), sine}$ $t = 8.3 \text{ ms (60 Hz), sine}$	1150 1230 A A
	$T_{VJ} = T_{VJM}$ $V_R = 0$	$t = 10 \text{ ms (50 Hz), sine}$ $t = 8.3 \text{ ms (60 Hz), sine}$	1000 1070 A A
$\int i^2 dt$	$T_{VJ} = 45^\circ\text{C}$ $V_R = 0$	$t = 10 \text{ ms (50 Hz), sine}$ $t = 8.3 \text{ ms (60 Hz), sine}$	6600 6280 A^2s A^2s
	$T_{VJ} = T_{VJM}$ $V_R = 0$	$t = 10 \text{ ms (50 Hz), sine}$ $t = 8.3 \text{ ms (60 Hz), sine}$	5000 4750 A^2s A^2s
$(di/dt)_{cr}$	$T_{VJ} = T_{VJM}$ $f = 50 \text{ Hz}, t_p = 200 \mu s$ $V_D = 2/3 V_{DRM}$ $I_G = 0.45 \text{ A}$ $di_G/dt = 0.45 \text{ A}/\mu s$	repetitive, $I_T = 150 \text{ A}$ non repetitive, $I_T = I_{TAVM}$	150 500 $A/\mu s$ $A/\mu s$
$(dv/dt)_{cr}$	$T_{VJ} = T_{VJM};$ $R_{GK} = \infty; \text{ method 1 (linear voltage rise)}$	$V_{DR} = 2/3 V_{DRM}$	1000 $V/\mu s$
P_{GM}	$T_{VJ} = T_{VJM}$ $I_T = I_{TAVM}$	$t_p = 30 \mu s$ $t_p = 300 \mu s$	10 5 W W
P_{GAV}			0.5 W
V_{RGM}			10 V
T_{VJ}			-40...+125 $^\circ\text{C}$
T_{VJM}			125 $^\circ\text{C}$
T_{stg}			-40...+125 $^\circ\text{C}$
V_{ISOL}	50/60 Hz, RMS $I_{ISOL} \leq 1 \text{ mA}$	$t = 1 \text{ min}$ $t = 1 \text{ s}$	3000 3600 V~ V~
M_d	Mounting torque (M5) Terminal connection torque (M5)		2.5-4.0/22-35 Nm/lb.in. 2.5-4.0/22-35 Nm/lb.in.
Weight	Typical including screws		90 g

TO-240 AA

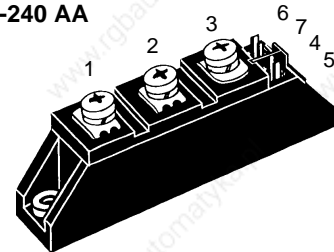

MCC
Version 1 B

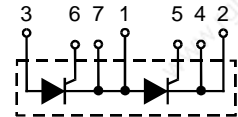

MCC
Version 8 B

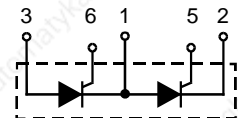

MCD
Version 8 B

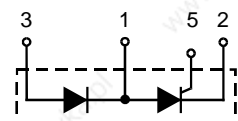

Features

- International standard package, JEDEC TO-240 AA
- Direct copper bonded Al_2O_3 -ceramic base plate
- Planar passivated chips
- Isolation voltage 3600 V~
- UL registered, E 72873
- Gate-cathode twin pins for version 1B

Applications

- DC motor control
- Softstart AC motor controller
- Light, heat and temperature control

Advantages

- Space and weight savings
- Simple mounting with two screws
- Improved temperature and power cycling
- Reduced protection circuits

Data according to IEC 60747 and refer to a single thyristor/diode unless otherwise stated. IXYS reserves the right to change limits, test conditions and dimensions

Symbol	Test Conditions	Characteristic Values
I_{RRM}, I_{DRM}	$T_{VJ} = T_{VJM}; V_R = V_{RRM}; V_D = V_{DRM}$	5 mA
V_T, V_F	$I_T, I_F = 200 \text{ A}; T_{VJ} = 25^\circ\text{C}$	1.75 V
V_{T0}	For power-loss calculations only ($T_{VJ} = 125^\circ\text{C}$)	0.85 V
r_T		5.3 mΩ
V_{GT}	$V_D = 6 \text{ V}; T_{VJ} = 25^\circ\text{C}$	1.5 V
	$T_{VJ} = -40^\circ\text{C}$	1.6 V
I_{GT}	$V_D = 6 \text{ V}; T_{VJ} = 25^\circ\text{C}$	100 mA
	$T_{VJ} = -40^\circ\text{C}$	200 mA
V_{GD}	$T_{VJ} = T_{VJM}; V_D = 2/3 V_{DRM}$	0.2 V
I_{GD}		10 mA
I_L	$T_{VJ} = 25^\circ\text{C}; t_p = 10 \mu\text{s}, V_D = 6 \text{ V}$ $I_G = 0.45 \text{ A}; di_G/dt = 0.45 \text{ A}/\mu\text{s}$	450 mA
I_H	$T_{VJ} = 25^\circ\text{C}; V_D = 6 \text{ V}; R_{GK} = \infty$	200 mA
t_{gd}	$T_{VJ} = 25^\circ\text{C}; V_D = 1/2 V_{DRM}$ $I_G = 0.45 \text{ A}; di_G/dt = 0.45 \text{ A}/\mu\text{s}$	2 μs
t_q	$T_{VJ} = T_{VJM}; I_T = 120 \text{ A}, t_p = 200 \mu\text{s}; -di/dt = 10 \text{ A}/\mu\text{s}$ typ. $V_R = 100 \text{ V}; dv/dt = 20 \text{ V}/\mu\text{s}; V_D = 2/3 V_{DRM}$	150 μs
Q_S	$T_{VJ} = T_{VJM}; I_T, I_F = 50 \text{ A}, -di/dt = 0.64 \text{ A}/\mu\text{s}$	90 μC
I_{RM}		11 A
R_{thJC}	per thyristor/diode; DC current per module	0.53 K/W
R_{thJK}	per thyristor/diode; DC current per module	0.265 K/W
	other values see Fig. 8/9	0.73 K/W
		0.365 K/W
d_s	Creepage distance on surface	12.7 mm
d_A	Strike distance through air	9.6 mm
a	Maximum allowable acceleration	50 m/s ²

Optional accessories for module-type MCC 44 version 1 B

Keyed gate/cathode twin plugs with wire length = 350 mm, gate = yellow, cathode = red

Type ZY 200L (L = Left for pin pair 4/5) } UL 758, style 1385,
Type ZY 200R (R = right for pin pair 6/7) } CSA class 5851, guide 460-1-1

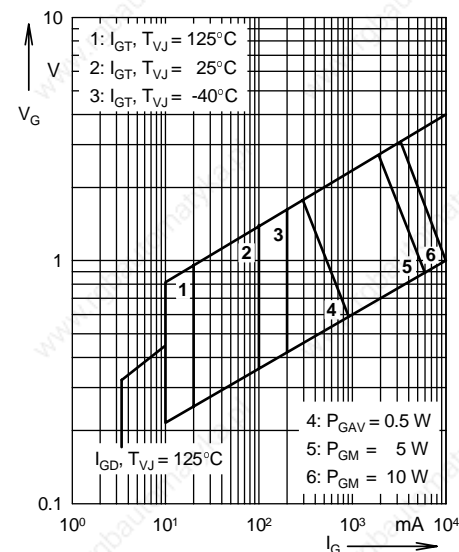

Fig. 1 Gate trigger characteristics

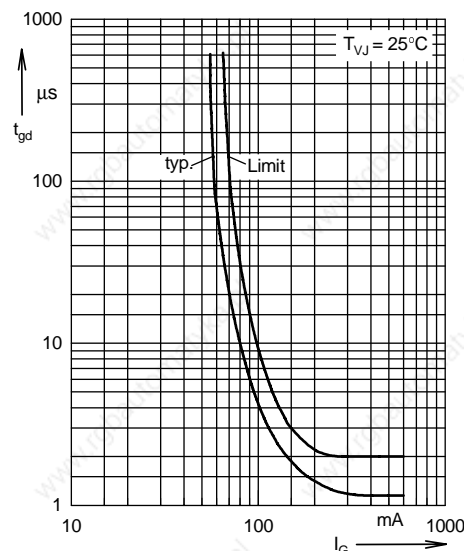
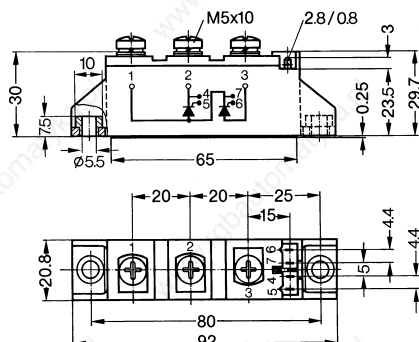

Fig. 2 Gate trigger delay time

Dimensions in mm (1 mm = 0.0394")

MCC Version 1 B



MCC Version 8 B

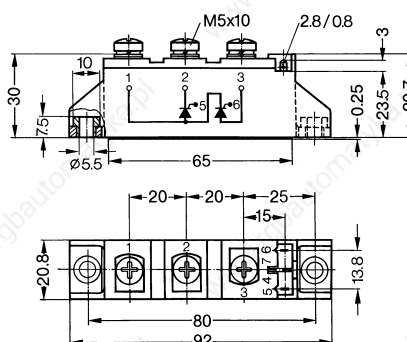

MCD Version 8 B

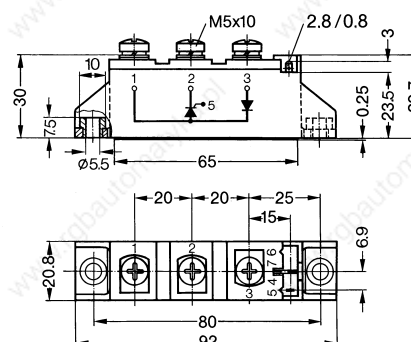

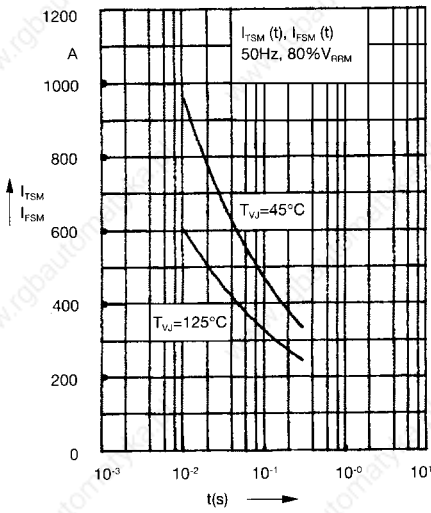

Fig. 3 Surge overload current
 I_{TSM}^* I_{FSM}^* : Crest value, t: duration

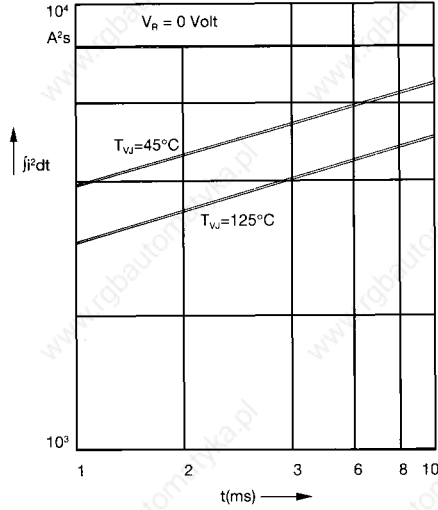

Fig. 4 $\int i^2 dt$ versus time (1-10 ms)

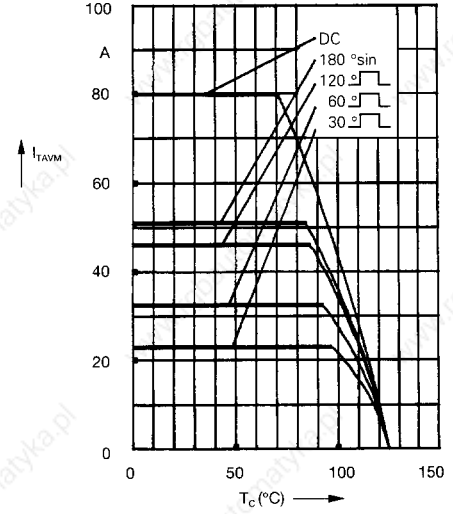

Fig. 4a Maximum forward current at case temperature

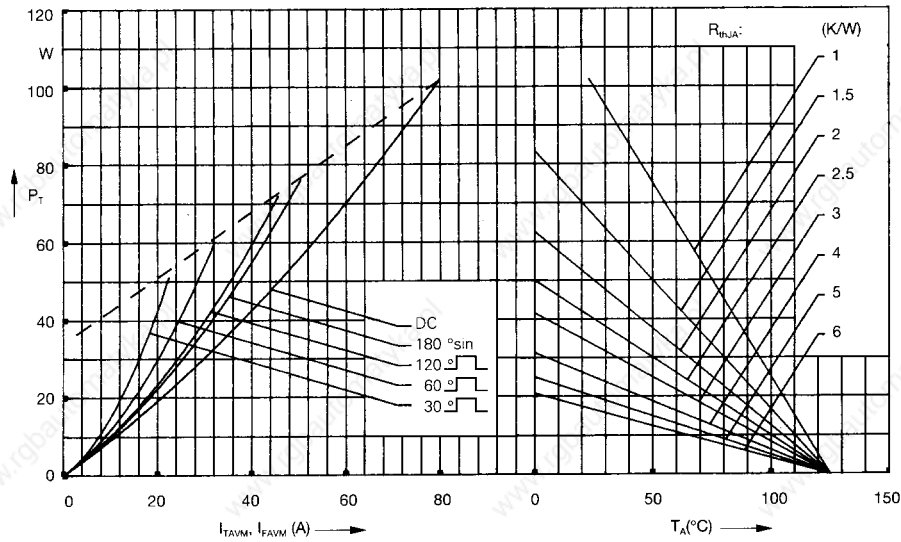

Fig. 5 Power dissipation versus on-state current and ambient temperature (per thyristor or diode)

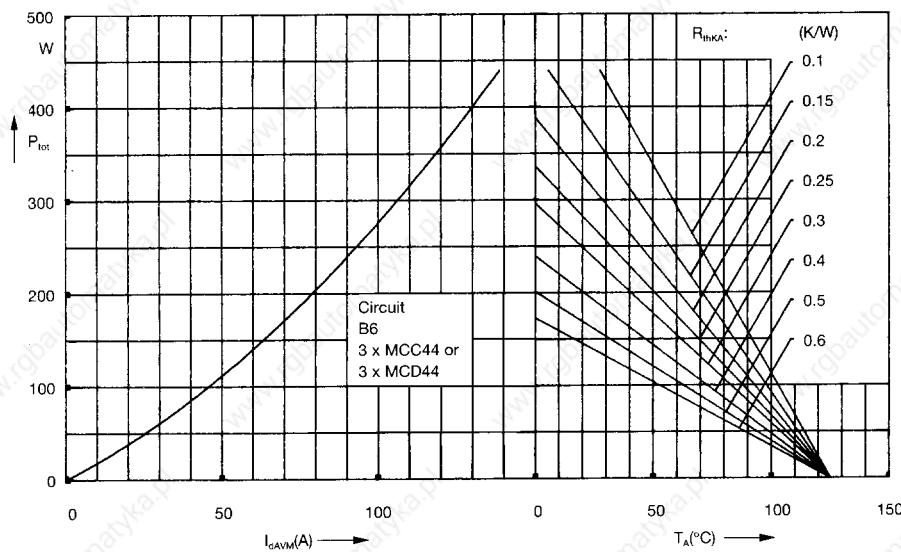

Fig. 6 Three phase rectifier bridge: Power dissipation versus direct output current and ambient temperature

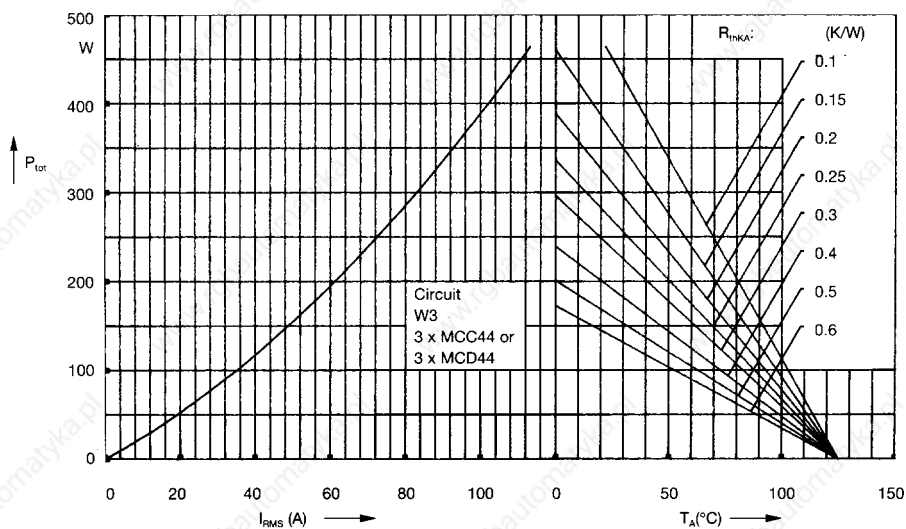

Fig. 7 Three phase AC-controller:
Power dissipation versus RMS
output current and ambient
temperature

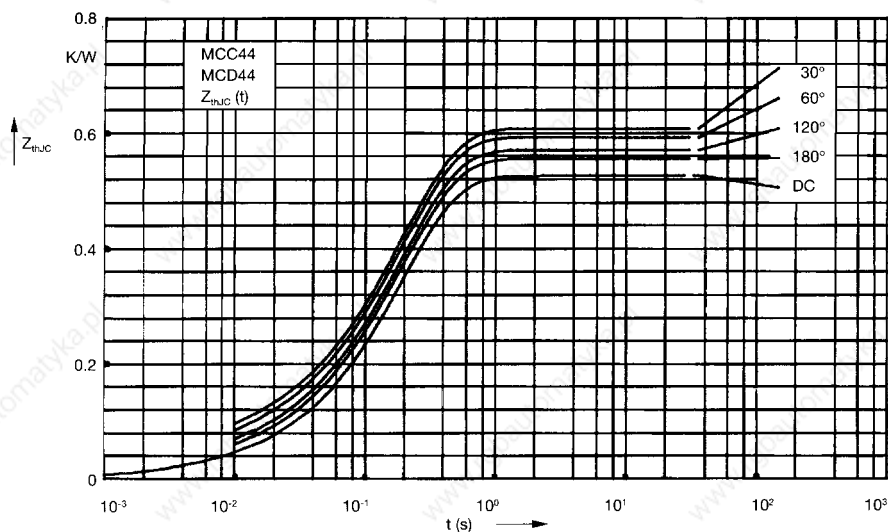

Fig. 8 Transient thermal impedance
junction to case (per thyristor or
diode)

R_{thJC} for various conduction angles d:

d	R_{thJC} (K/W)
DC	0.53
180°	0.55
120°	0.58
60°	0.6
30°	0.62

Constants for Z_{thJC} calculation:

i	R_{thi} (K/W)	t_i (s)
1	0.015	0.0035
2	0.026	0.02
3	0.489	0.195

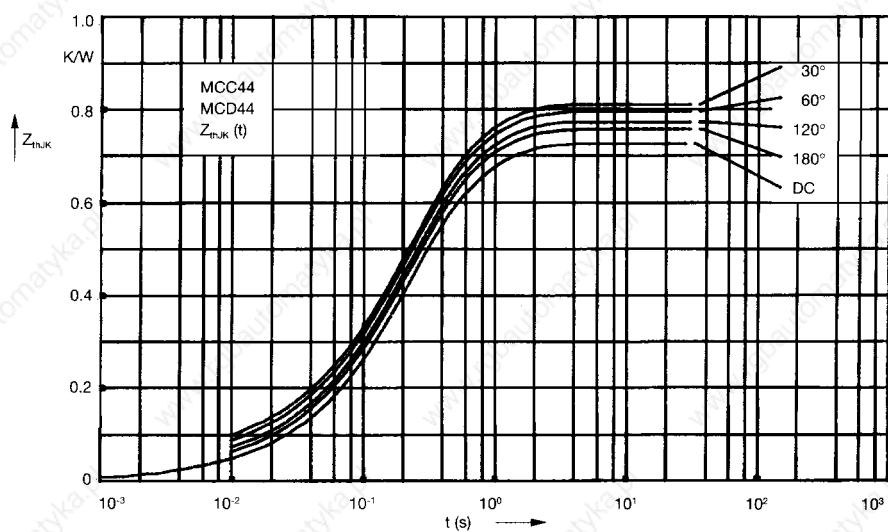

Fig. 9 Transient thermal impedance
junction to heatsink (per thyristor
or diode)

R_{thJK} for various conduction angles d:

d	R_{thJK} (K/W)
DC	0.73
180°	0.75
120°	0.78
60°	0.8
30°	0.82

Constants for Z_{thJK} calculation:

i	R_{thi} (K/W)	t_i (s)
1	0.015	0.0035
2	0.026	0.02
3	0.489	0.195
4	0.2	0.68

Thyristor Modules Thyristor/Diode Modules

$I_{TRMS} = 2 \times 100 \text{ A}$
 $I_{TAVM} = 2 \times 64 \text{ A}$
 $V_{RRM} = 800-1800 \text{ V}$

V_{RSM} V_{DSM}	V_{RRM} V_{DRM}	Type			
V	V	Version 1		Version 8	
900	800	MCC 56-08io1 B	MCD 56-08io1 B	MCC 56-08io8 B	MCD 56-08io8 B
1300	1200	MCC 56-12io1 B	MCD 56-12io1 B	MCC 56-12io8 B	MCD 56-12io8 B
1500	1400	MCC 56-14io1 B	--	MCC 56-14io8 B	MCD 56-14io8 B
1700	1600	MCC 56-16io1 B	MCD 56-16io1 B	MCC 56-16io8 B	MCD 56-16io8 B
1900	1800	MCC 56-18io1 B	--	MCC 56-18io8 B	MCD 56-18io8 B
1500	1400	MCC 56-14io1			
1700	1600	MCC 56-16io1			
700	600	MDC 56-06io1 B			

Symbol	Test Conditions	Maximum Ratings	
I_{TRMS}^* I_{FRMS} I_{TAVM}^* I_{FAVM}	$T_{VJ} = T_{VJM}$ $T_C = 83^\circ\text{C}; 180^\circ \text{ sine}$ $T_C = 85^\circ\text{C}; 180^\circ \text{ sine}$	100 64 60	A A A
I_{TSM}^* I_{FSM}	$T_{VJ} = 45^\circ\text{C};$ $V_R = 0$ $t = 10 \text{ ms (50 Hz), sine}$ $t = 8.3 \text{ ms (60 Hz), sine}$	1500 1600	A A
$\int i^2 dt$	$T_{VJ} = 45^\circ\text{C}$ $V_R = 0$ $t = 10 \text{ ms (50 Hz), sine}$ $t = 8.3 \text{ ms (60 Hz), sine}$	11 200 10 750	A^2s A^2s
$(di/dt)_{cr}$	$T_{VJ} = T_{VJM}$ $V_R = 0$ $t = 10 \text{ ms (50 Hz), sine}$ $t = 8.3 \text{ ms (60 Hz), sine}$	9100 8830	A^2s A^2s
$(dv/dt)_{cr}$	$T_{VJ} = T_{VJM}$ $R_{GK} = \infty; \text{ method 1 (linear voltage rise)}$	1000	$\text{V}/\mu\text{s}$
P_{GM}	$T_{VJ} = T_{VJM}$ $I_T = I_{TAVM}$	$t_p = 30 \mu\text{s}$ $t_p = 300 \mu\text{s}$	10 5 0.5 10 W W W V
T_{VJ} T_{VJM} T_{sig}		-40...+125 125 -40...+125	$^\circ\text{C}$ $^\circ\text{C}$ $^\circ\text{C}$
V_{ISOL}	50/60 Hz, RMS $I_{ISOL} \leq 1 \text{ mA}$	$t = 1 \text{ min}$ $t = 1 \text{ s}$	3000 3600 V~ V~
M_d	Mounting torque (M5) Terminal connection torque (M5)	2.5-4.0/22-35 2.5-4.0/22-35	Nm/lb.in. Nm/lb.in.
Weight	Typical including screws	90	g

Data according to IEC 60747 and refer to a single thyristor/diode unless otherwise stated.
IXYS reserves the right to change limits, test conditions and dimensions

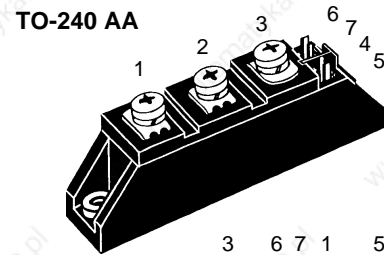

MCC
Version 1

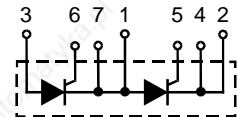

MCD
Version 1

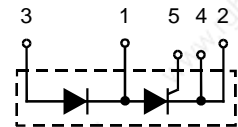

MCC
Version 8

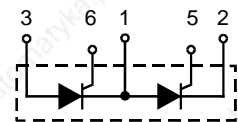

MCD
Version 8

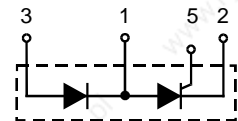

MDC
Version 1

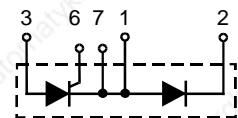

Features

- International standard package, JEDEC TO-240 AA
- Direct copper bonded Al_2O_3 -ceramic base plate
- Planar passivated chips
- Isolation voltage 3600 V~
- UL registered, E 72873
- Gate-cathode twin pins for version 1B

Applications

- DC motor control
- Softstart AC motor controller
- Light, heat and temperature control

Advantages

- Space and weight savings
- Simple mounting with two screws
- Improved temperature and power cycling
- Reduced protection circuits

Symbol	Test Conditions	Characteristic Values
I_{RRM}, I_{DRM}	$T_{VJ} = T_{VJM}; V_R = V_{RRM}; V_D = V_{DRM}$	5 mA
V_T, V_F	$I_T, I_F = 200 \text{ A}; T_{VJ} = 25^\circ\text{C}$	1.57 V
V_{T0}	For power-loss calculations only ($T_{VJ} = 125^\circ\text{C}$)	0.85 V
r_T		3.7 mΩ
V_{GT}	$V_D = 6 \text{ V}; T_{VJ} = 25^\circ\text{C}$	1.5 V
	$T_{VJ} = -40^\circ\text{C}$	1.6 V
I_{GT}	$V_D = 6 \text{ V}; T_{VJ} = 25^\circ\text{C}$	100 mA
	$T_{VJ} = -40^\circ\text{C}$	200 mA
V_{GD}	$T_{VJ} = T_{VJM}; V_D = 2/3 V_{DRM}$	0.2 V
I_{GD}		10 mA
I_L	$T_{VJ} = 25^\circ\text{C}; t_p = 10 \mu\text{s}; V_D = 6 \text{ V}$ $I_G = 0.45 \text{ A}; di_G/dt = 0.45 \text{ A}/\mu\text{s}$	450 mA
I_H	$T_{VJ} = 25^\circ\text{C}; V_D = 6 \text{ V}; R_{GK} = \infty$	200 mA
t_{gd}	$T_{VJ} = 25^\circ\text{C}; V_D = 1/2 V_{DRM}$ $I_G = 0.45 \text{ A}; di_G/dt = 0.45 \text{ A}/\mu\text{s}$	2 μs
t_q	$T_{VJ} = T_{VJM}; I_T = 150 \text{ A}, t_p = 200 \mu\text{s}; -di/dt = 10 \text{ A}/\mu\text{s}$ typ. $V_R = 100 \text{ V}; dv/dt = 20 \text{ V}/\mu\text{s}; V_D = 2/3 V_{DRM}$	150 μs
Q_S	$T_{VJ} = T_{VJM}; I_T, I_F = 50 \text{ A}, -di/dt = 3 \text{ A}/\mu\text{s}$	100 μC
I_{RM}		24 A
R_{thJC}	per thyristor/diode; DC current per module	0.45 K/W
R_{thJK}	per thyristor/diode; DC current per module	0.225 K/W
	other values see Fig. 8/9	0.65 K/W
		0.325 K/W
d_s	Creepage distance on surface	12.7 mm
d_A	Strike distance through air	9.6 mm
a	Maximum allowable acceleration	50 m/s ²

Optional accessories for module-type MCC 56 version 1 B

Keyed gate/cathode twin plugs with wire length = 350 mm, gate = yellow, cathode = red

Type ZY 200L (L = Left for pin pair 4/5) } UL 758, style 1385,
Type ZY 200R (R = right for pin pair 6/7) } CSA class 5851, guide 460-1-1

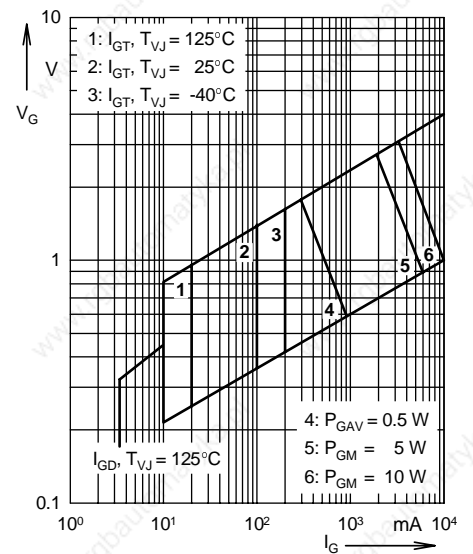

Fig. 1 Gate trigger characteristics

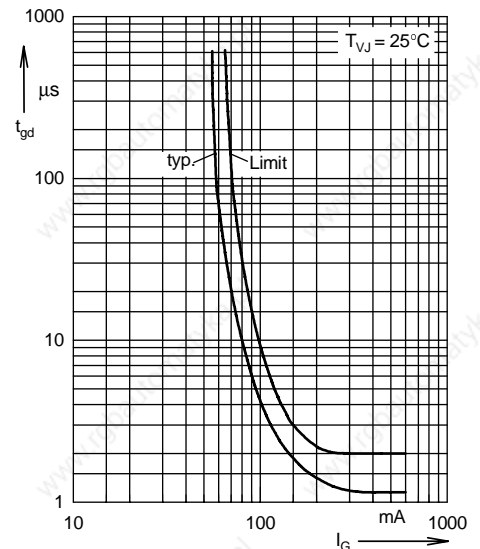
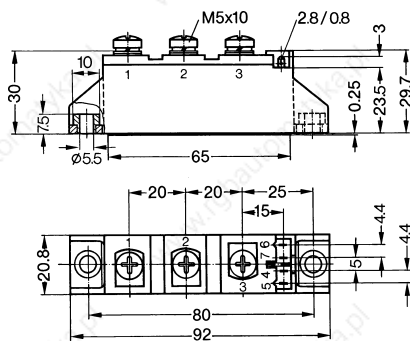

Fig. 2 Gate trigger delay time

Dimensions in mm (1 mm = 0.0394")

MCC / MCD / MDC Version 1 B



MCC Version 8 B

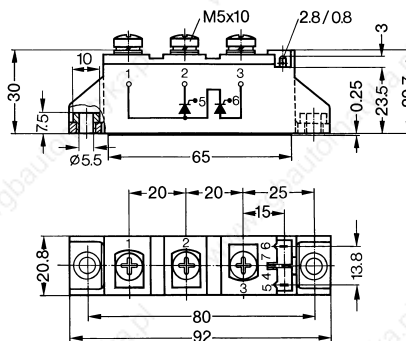

MCD Version 8 B

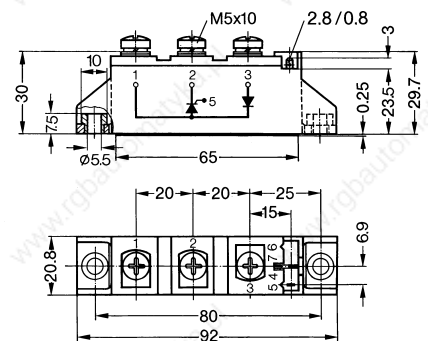

Version 1 or 8 without B in typ designation = without insert in mountig holes

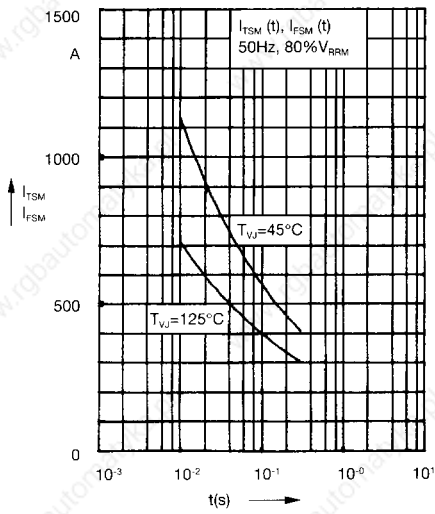

Fig. 3 Surge overload current
 I_{TSM} , I_{FSM} : Crest value, t: duration

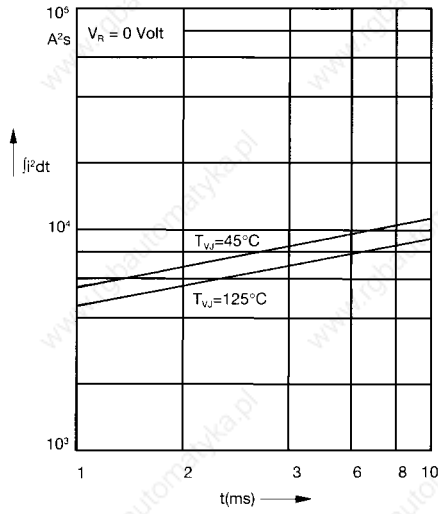

Fig. 4 $\int i^2 dt$ versus time (1-10 ms)

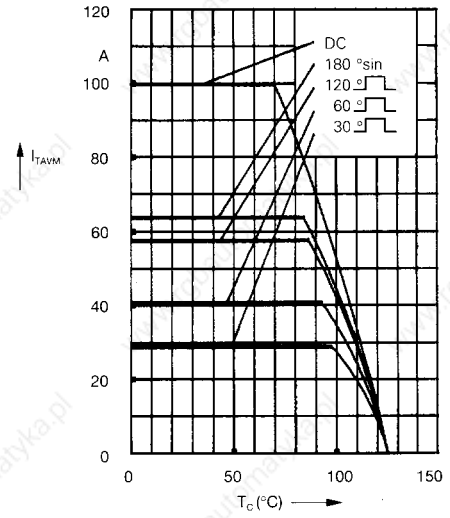

Fig. 4a Maximum forward current at case temperature

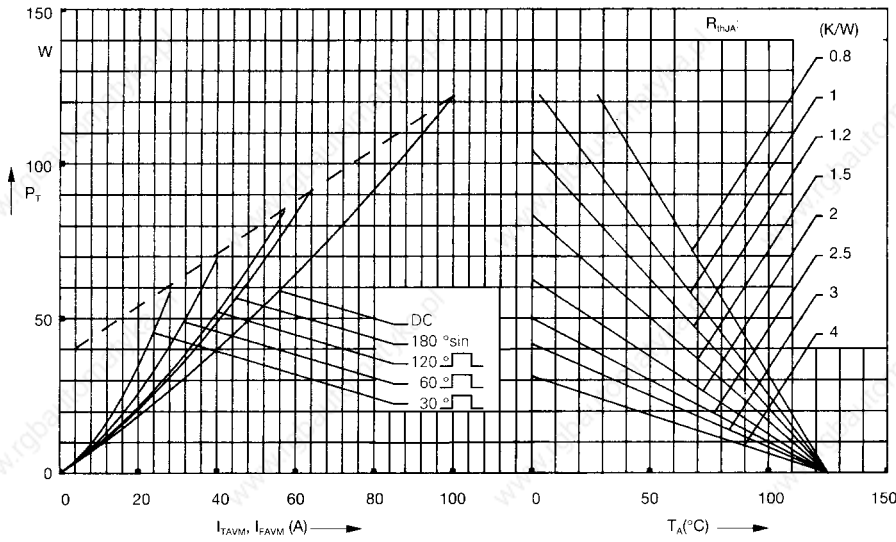

Fig. 5 Power dissipation versus on-state current and ambient temperature (per thyristor or diode)

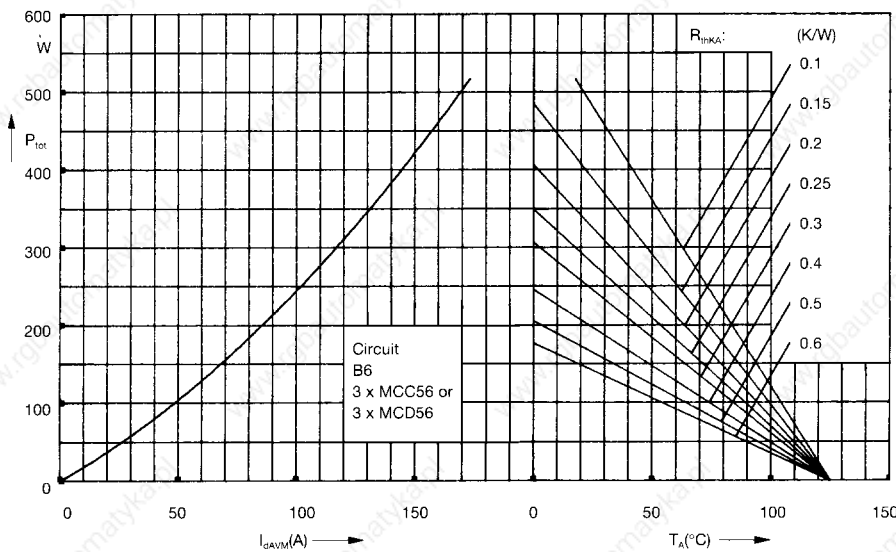

Fig. 6 Three phase rectifier bridge: Power dissipation versus direct output current and ambient temperature

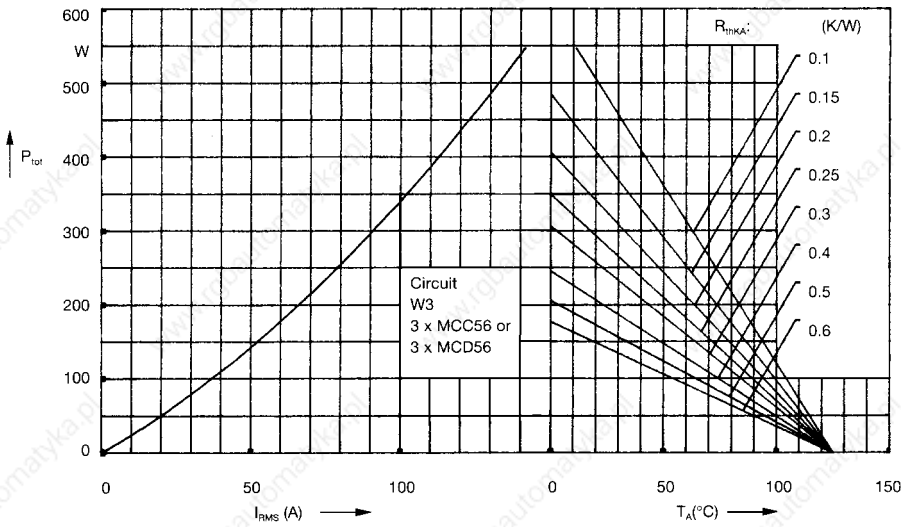

Fig. 7 Three phase AC-controller: Power dissipation versus RMS output current and ambient temperature

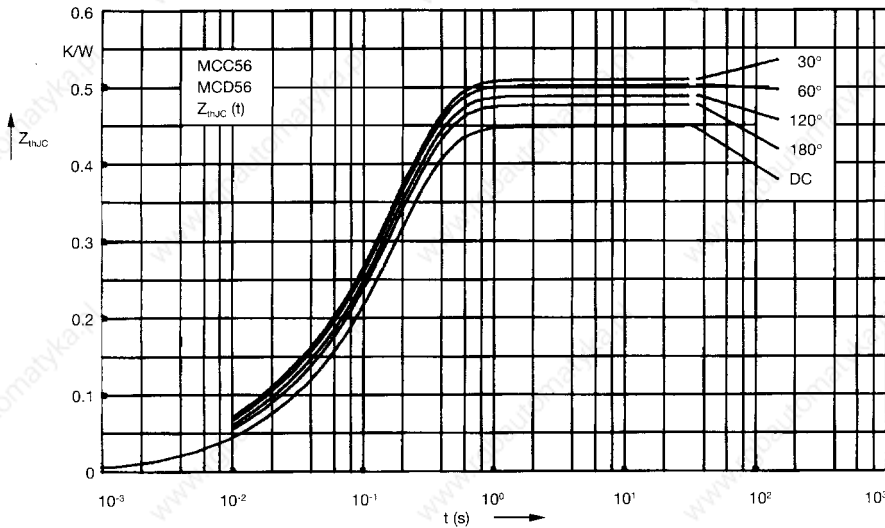

Fig. 8 Transient thermal impedance junction to case (per thyristor or diode)

R_{thJC} for various conduction angles d:

d	R_{thJC} (K/W)
DC	0.45
180°	0.47
120°	0.49
60°	0.505
30°	0.52

Constants for Z_{thJC} calculation:

i	R_{thi} (K/W)	t_i (s)
1	0.014	0.015
2	0.026	0.0095
3	0.41	0.175

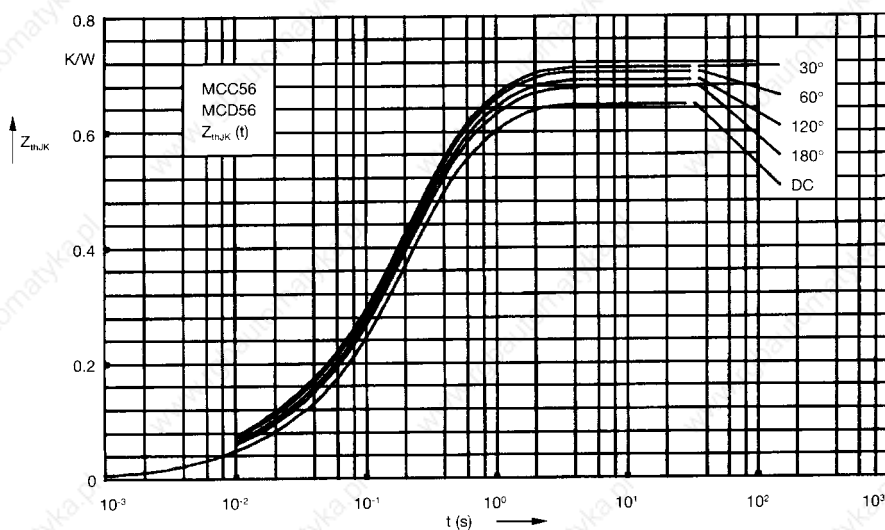

Fig. 9 Transient thermal impedance junction to heatsink (per thyristor or diode)

R_{thJK} for various conduction angles d:

d	R_{thJK} (K/W)
DC	0.65
180°	0.67
120°	0.69
60°	0.705
30°	0.72

Constants for Z_{thJK} calculation:

i	R_{thi} (K/W)	t_i (s)
1	0.014	0.015
2	0.026	0.0095
3	0.41	0.175
4	0.2	0.67

Thyristor Module

Preliminary data

$$I_{TRMS} = 2 \times 100 \text{ A}$$

$$I_{TAVM} = 2 \times 64 \text{ A}$$

$$V_{RRM, DRM} = 1600 \text{ V}$$

V_{RSM}	V_{RRM}	Type
V_{DSM}	V_{DRM}	
V	V	
1700	1600	MCC 60-16io1 B

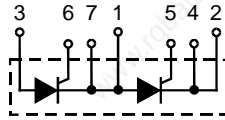

TO-240 AA

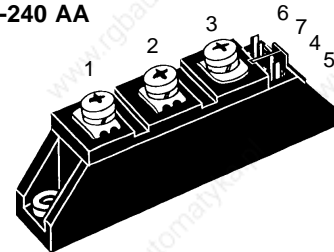

Symbol	Conditions	Maximum Ratings	
I_{TRMS}, I_{FRMS} I_{TAVM}	$T_{VJ} = T_{VJM}$ $T_C = 85^\circ\text{C}; 180^\circ \text{ sine}$	100 64	A A
I_{TSM}, I_{FSM}	$T_{VJ} = 45^\circ\text{C};$ $V_R = 0$	$t = 10 \text{ ms (50 Hz), sine}$ $t = 8.3 \text{ ms (60 Hz), sine}$	1150 A 1230 A
	$T_{VJ} = T_{VJM}$ $V_R = 0$	$t = 10 \text{ ms (50 Hz), sine}$ $t = 8.3 \text{ ms (60 Hz), sine}$	1000 A 1070 A
I^2dt	$T_{VJ} = 45^\circ\text{C}$ $V_R = 0$	$t = 10 \text{ ms (50 Hz), sine}$ $t = 8.3 \text{ ms (60 Hz), sine}$	6610 A ² s 6350 A ² s
	$T_{VJ} = T_{VJM}$ $V_R = 0$	$t = 10 \text{ ms (50 Hz), sine}$ $t = 8.3 \text{ ms (60 Hz), sine}$	5000 A ² s 4810 A ² s
$(di/dt)_{cr}$	$T_{VJ} = T_{VJM}$ $f = 50\text{Hz}, t_p = 200\mu\text{s}$ $V_D = \frac{2}{3} V_{DRM}$ $I_G = 0.45 \text{ A}$ $di_G/dt = 0.45 \text{ A}/\mu\text{s}$	repetitive, $I_T = 150 \text{ A}$ non repetitive, $I_T = I_{TAVM}$	150 A/ μs 500 A/ μs
$(dv/dt)_{cr}$	$T_{VJ} = T_{VJM};$ $R_{GK} = \infty;$ method 1 (linear voltage rise)	$V_{DR} = \frac{2}{3} V_{DRM}$	1000 V/ μs
P_{GM}	$T_{VJ} = T_{VJM}$ $I_T = I_{TAVM}$	$t_p = 30 \mu\text{s}$ $t_p = 300 \mu\text{s}$	10 W 5 W
P_{GAV}			0.5 W
V_{RGM}			10 V
T_{VJ}			-40...+140 °C
T_{VJM}			140 °C
T_{stg}			-40...+125 °C
V_{ISOL}	50/60 Hz, RMS $I_{ISOL} \leq 1 \text{ mA}$	$t = 1 \text{ min}$ $t = 1 \text{ s}$	3000 V~ 3600 V~
M_d	Mounting torque (M5) Terminal connection torque (M5)		2.5-4.0/22-35 Nm/lb.in. 2.5-4.0/22-35 Nm/lb.in.
Weight	Typical including screws		90 g

Features

- International standard package
- Direct copper bonded Al₂O₃-ceramic base plate
- Planar passivated chips
- Isolation voltage 3600 V~
- Gate-cathode twin pins

Applications

- DC motor control
- Softstart AC motor controller
- Light, heat and temperature control

Advantages

- Space and weight savings
- Simple mounting with two screws
- Improved temperature and power cycling
- Reduced protection circuits

Dimensions in mm (1 mm = 0.0394")

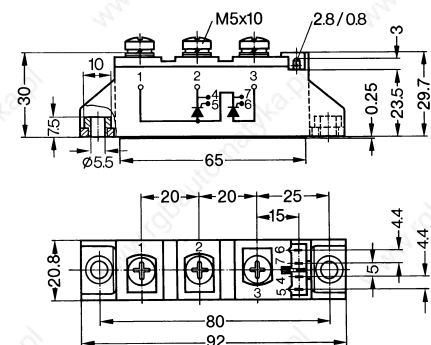

Data according to IEC 60747 and refer to a single thyristor/diode unless otherwise stated. IXYS reserves the right to change limits, test conditions and dimensions

Symbol	Conditions	Characteristic Values		
I_{RRM}, I_{DRM}	$T_{VJ} = T_{VJM}; V_R = V_{RRM}; V_D = V_{DRM}$	20	mA	
V_T, V_F	$I_T, I_F = 200 \text{ A}; T_{VJ} = 25^\circ\text{C}$	1.70	V	
V_{T0}	$T_{VJ} = 125^\circ\text{C};$ For power-loss calculations only	0.85	V	
r_T	$T_{VJ} = T_{VJM}$	4.8	m Ω	
V_{GT}	$V_D = 6 \text{ V}; T_{VJ} = 25^\circ\text{C}$	1.4	V	
	$T_{VJ} = -40^\circ\text{C}$	1.6	V	
I_{GT}	$V_D = 6 \text{ V}; T_{VJ} = 25^\circ\text{C}$	100	mA	
	$T_{VJ} = -40^\circ\text{C}$	200	mA	
V_{GD}	$T_{VJ} = T_{VJM}; V_D = \frac{2}{3} V_{DRM}$	0.2	V	
I_{GD}		10	mA	
I_L	$T_{VJ} = 25^\circ\text{C}; t_p = 10 \mu\text{s}, V_D = 6 \text{ V}$ $I_G = 0.45 \text{ A}; di_G/dt = 0.45 \text{ A}/\mu\text{s}$	450	mA	
I_H	$T_{VJ} = 25^\circ\text{C}; V_D = 6 \text{ V}; R_{GK} = \infty$	200	mA	
t_{gd}	$T_{VJ} = 25^\circ\text{C}; V_D = \frac{1}{2} V_{DRM}$ $I_G = 0.45 \text{ A}; di_G/dt = 0.45 \text{ A}/\mu\text{s}$	2	μs	
t_q	$T_{VJ} = T_{VJM}; I_T = 120 \text{ A}, t_p = 200 \mu\text{s}; -di/dt = 10 \text{ A}/\mu\text{s typ.}$ $V_R = 100 \text{ V}; dv/dt = 20 \text{ V}/\mu\text{s}; V_D = \frac{2}{3} V_{DRM}$	150	μs	
Q_S	$T_{VJ} = T_{VJM}; I_T, I_F = 50 \text{ A}, -di/dt = 0.64 \text{ A}/\mu\text{s}$	110	μC	
I_{RM}		12	A	
R_{thJC}	per thyristor/diode; DC current	0.5	K/W	
	per module	0.25	K/W	
R_{thCH}	per thyristor/diode; DC current	typ.	0.1	K/W
d_s	Creepage distance on surface	12.7	mm	
d_A	Strike distance through air	9.6	mm	
a	Maximum allowable acceleration	50	m/s ²	

Optional accessories for module-type MCC 60 version 1 B

Keyed gate/cathode twin plugs with wire length = 350 mm, gate = yellow, cathode = red

Type **ZY 200L** (L = Left for pin pair 4/5) } UL 758, style 1385,

Type **ZY 200R** (R = right for pin pair 6/7) } CSA class 5851, guide 460-1-1

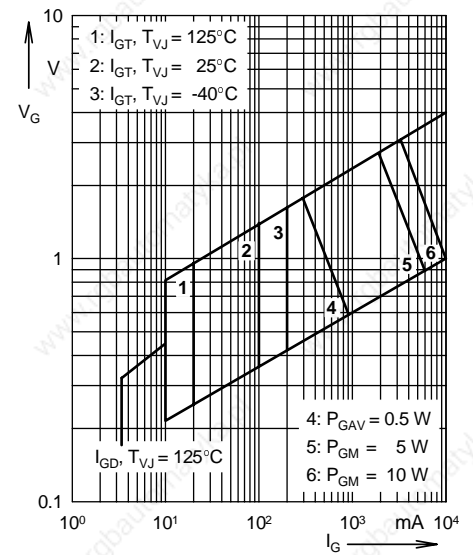

Fig. 1 Gate trigger characteristics

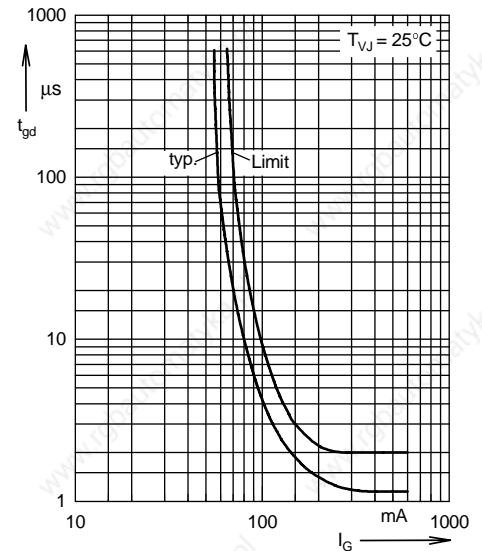

Fig. 2 Gate trigger delay time

Thyristor Modules Thyristor/Diode Modules

$$I_{TRMS} = 2 \times 180 \text{ A}$$

$$I_{TAVM} = 2 \times 115 \text{ A}$$

$$V_{RRM} = 800\text{-}1800 \text{ V}$$

V_{RSM} V_{DSM}	V_{RRM} V_{DRM}	Type	
V	V	Version 1 B	Version 8 B
900	800	MCC 72-08io1 B	--
1300	1200	MCC 72-12io1 B	MCD 72-12io1 B
1500	1400	MCC 72-14io1 B	--
1700	1600	MCC 72-16io1 B	MCD 72-16io1 B
1900	1800	MCC 72-18io1 B	--
		MCC 72-08io8 B	MCD 72-08io8 B
		MCC 72-12io8 B	MCD 72-12io8 B
		MCC 72-14io8 B	MCD 72-14io8 B
		MCC 72-16io8 B	MCD 72-16io8 B
		MCC 72-18io8 B	MCD 72-18io8 B

TO-240 AA

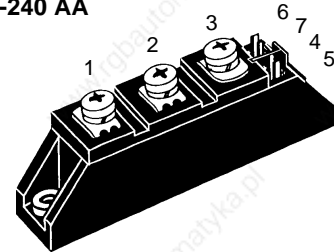

Symbol	Test Conditions	Maximum Ratings
I_{TRMS}^* , I_{FRMS} I_{TAVM}^* , I_{FAVM}	$T_{VJ} = T_{VJM}$ $T_C = 63^\circ\text{C}$; 180° sine $T_C = 85^\circ\text{C}$; 180° sine	180 A 115 A 85 A
I_{TSM}^* , I_{FSM}	$T_{VJ} = 45^\circ\text{C}$; $V_R = 0$ $T_{VJ} = T_{VJM}$ $V_R = 0$	$t = 10 \text{ ms}$ (50 Hz), sine $t = 8.3 \text{ ms}$ (60 Hz), sine $t = 10 \text{ ms}$ (50 Hz), sine $t = 8.3 \text{ ms}$ (60 Hz), sine
$\int i^2 dt$	$T_{VJ} = 45^\circ\text{C}$ $V_R = 0$ $T_{VJ} = T_{VJM}$ $V_R = 0$	$t = 10 \text{ ms}$ (50 Hz), sine $t = 8.3 \text{ ms}$ (60 Hz), sine $t = 10 \text{ ms}$ (50 Hz), sine $t = 8.3 \text{ ms}$ (60 Hz), sine
$(di/dt)_{cr}$	$T_{VJ} = T_{VJM}$ $f = 50 \text{ Hz}$, $t_p = 200 \mu\text{s}$ $V_D = 2/3 V_{DRM}$ $I_G = 0.45 \text{ A}$ $di_G/dt = 0.45 \text{ A}/\mu\text{s}$	repetitive, $I_T = 250 \text{ A}$ non repetitive, $I_T = I_{TAVM}$
$(dv/dt)_{cr}$	$T_{VJ} = T_{VJM}$; $R_{GK} = \infty$; method 1 (linear voltage rise)	$V_{DR} = 2/3 V_{DRM}$ 1000 $V/\mu\text{s}$
P_{GM}	$T_{VJ} = T_{VJM}$ $I_T = I_{TAVM}$	$t_p = 30 \mu\text{s}$ $t_p = 300 \mu\text{s}$ 10 W 5 W
P_{GAV}		0.5 W
V_{RGM}		10 V
T_{VJ}		-40...+125 °C
T_{VJM}		125 °C
T_{sig}		-40...+125 °C
V_{ISOL}	50/60 Hz, RMS $I_{ISOL} \leq 1 \text{ mA}$	$t = 1 \text{ min}$ $t = 1 \text{ s}$ 3000 V~ 3600 V~
M_d	Mounting torque (M5) Terminal connection torque (M5)	2.5-4.0/22-35 Nm/lb.in.
Weight	Typical including screws	90 g

Data according to IEC 60747 and refer to a single thyristor/diode unless otherwise stated.
IXYS reserves the right to change limits, test conditions and dimensions

MCC
Version 1 B

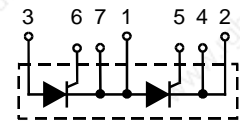

MCD
Version 1 B

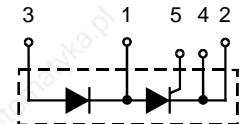

MCC
Version 8 B

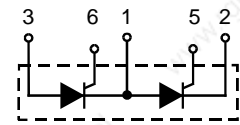

MCD
Version 8 B

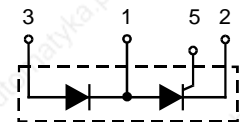

Features

- International standard package, JEDEC TO-240 AA
- Direct copper bonded Al_2O_3 -ceramic base plate
- Planar passivated chips
- Isolation voltage 3600 V~
- UL registered, E 72873
- Gate-cathode twin pins for version 1B

Applications

- DC motor control
- Softstart AC motor controller
- Light, heat and temperature control

Advantages

- Space and weight savings
- Simple mounting with two screws
- Improved temperature and power cycling
- Reduced protection circuits

Symbol	Test Conditions	Characteristic Values
I_{RRM}, I_{DRM}	$T_{VJ} = T_{VJM}; V_R = V_{RRM}; V_D = V_{DRM}$	5 mA
V_T, V_F	$I_T, I_F = 300 \text{ A}; T_{VJ} = 25^\circ\text{C}$	1.74 V
V_{T0}	For power-loss calculations only ($T_{VJ} = 125^\circ\text{C}$)	0.85 V
r_T		3.2 mΩ
V_{GT}	$V_D = 6 \text{ V}; T_{VJ} = 25^\circ\text{C}$	2.5 V
	$T_{VJ} = -40^\circ\text{C}$	2.6 V
I_{GT}	$V_D = 6 \text{ V}; T_{VJ} = 25^\circ\text{C}$	150 mA
	$T_{VJ} = -40^\circ\text{C}$	200 mA
V_{GD}	$T_{VJ} = T_{VJM}; V_D = 2/3 V_{DRM}$	0.2 V
I_{GD}		10 mA
I_L	$T_{VJ} = 25^\circ\text{C}; t_p = 10 \mu\text{s}; V_D = 6 \text{ V}$ $I_G = 0.45 \text{ A}; di_G/dt = 0.45 \text{ A}/\mu\text{s}$	450 mA
I_H	$T_{VJ} = 25^\circ\text{C}; V_D = 6 \text{ V}; R_{GK} = \infty$	200 mA
t_{gd}	$T_{VJ} = 25^\circ\text{C}; V_D = 1/2 V_{DRM}$ $I_G = 0.45 \text{ A}; di_G/dt = 0.45 \text{ A}/\mu\text{s}$	2 μs
t_q	$T_{VJ} = T_{VJM}; I_T = 150 \text{ A}, t_p = 200 \mu\text{s}; -di/dt = 10 \text{ A}/\mu\text{s}$ typ. $V_R = 100 \text{ V}; dv/dt = 20 \text{ V}/\mu\text{s}; V_D = 2/3 V_{DRM}$	185 μs
Q_S	$T_{VJ} = T_{VJM}; I_T, I_F = 50 \text{ A}, -di/dt = 6 \text{ A}/\mu\text{s}$	170 μC
I_{RM}		45 A
R_{thJC}	per thyristor/diode; DC current per module	0.3 K/W
R_{thJK}	per thyristor/diode; DC current per module	0.15 K/W
	other values see Fig. 8/9	0.5 K/W
		0.25 K/W
d_s	Creepage distance on surface	12.7 mm
d_A	Strike distance through air	9.6 mm
a	Maximum allowable acceleration	50 m/s ²

Optional accessories for module-type MCC 72 version 1 B

Keyed gate/cathode twin plugs with wire length = 350 mm, gate = yellow, cathode = red

Type ZY 200L (L = Left for pin pair 4/5) } UL 758, style 1385,
Type ZY 200R (R = right for pin pair 6/7) } CSA class 5851, guide 460-1-1

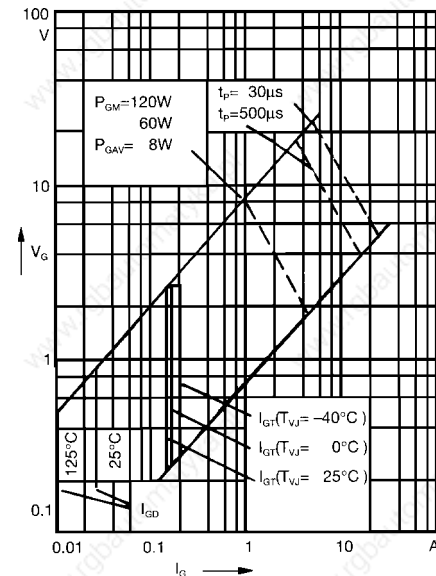

Fig. 1 Gate trigger characteristics

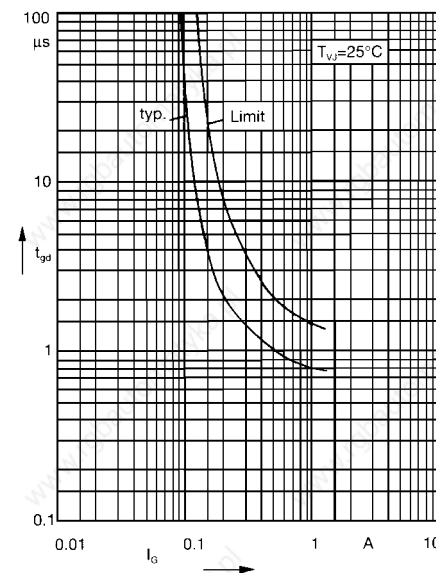
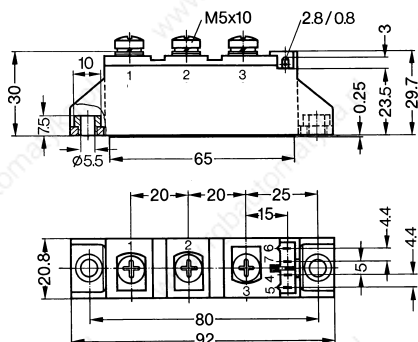

Fig. 2 Gate trigger delay time

Dimensions in mm (1 mm = 0.0394")

MCC / MCD Version 1 B



MCC Version 8 B

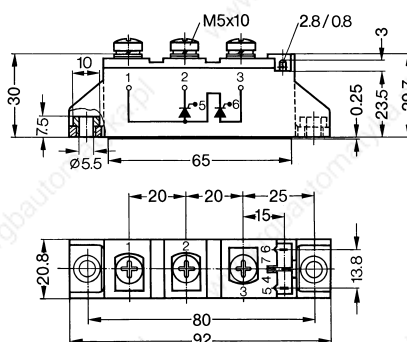

MCD Version 8 B

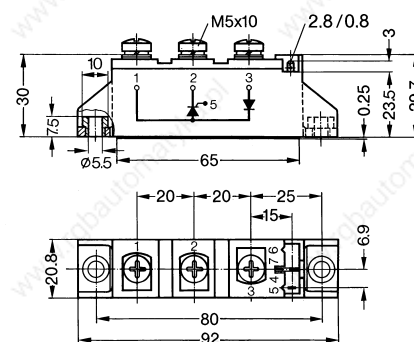

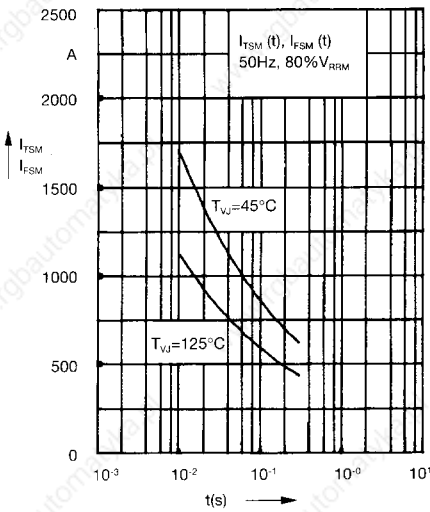

Fig. 3 Surge overload current
 I_{TSM}, I_{FSM} : Crest value, t: duration

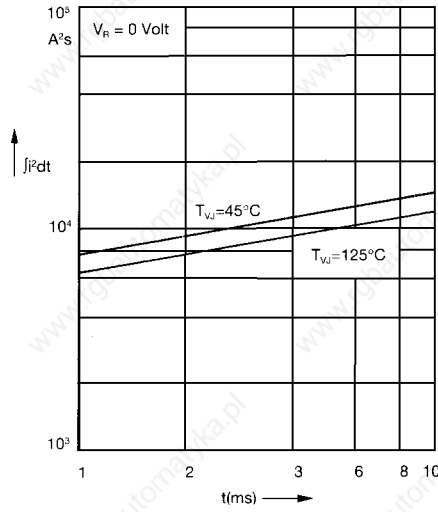

Fig. 4 $\int i^2 dt$ versus time (1-10 ms)

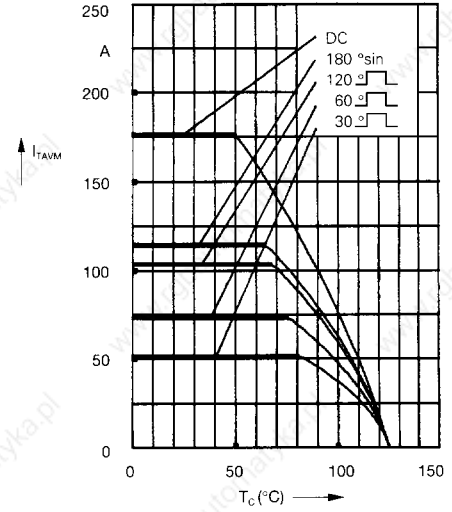

Fig. 4a Maximum forward current at case temperature

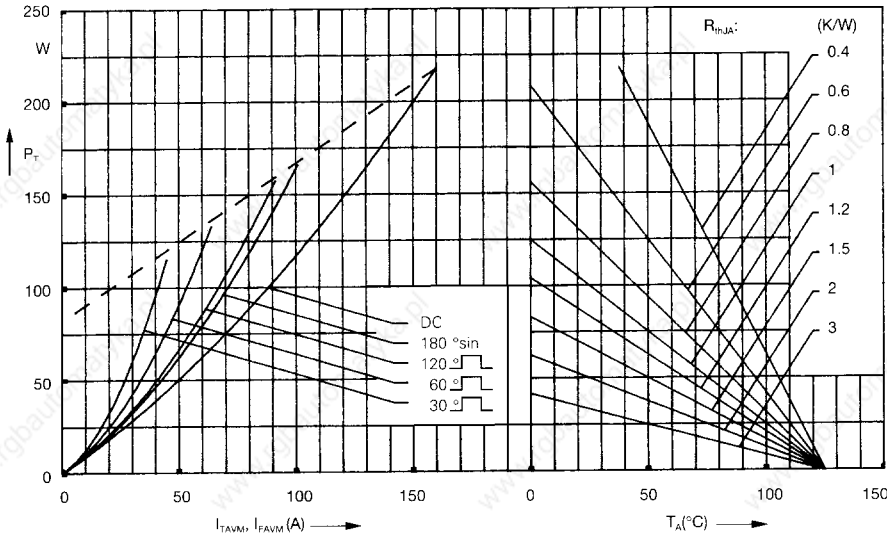

Fig. 5 Power dissipation versus on-state current and ambient temperature (per thyristor or diode)

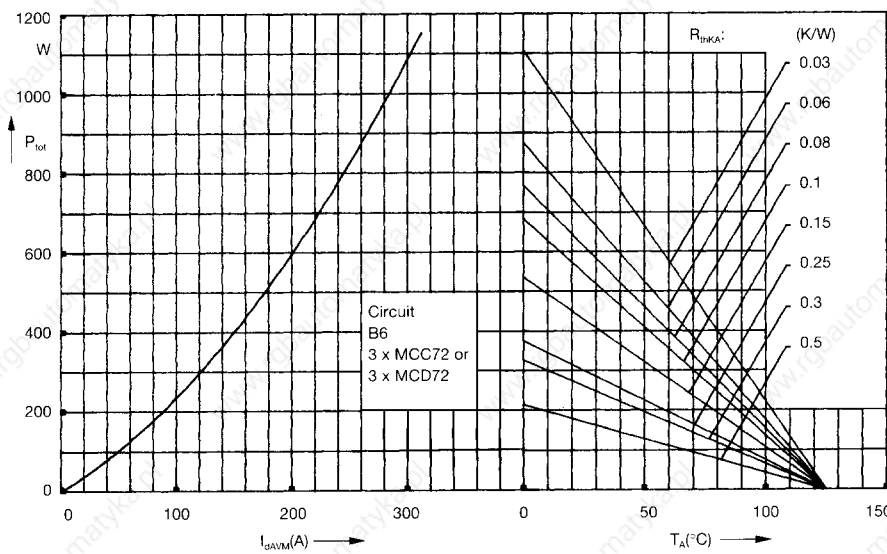

Fig. 6 Three phase rectifier bridge: Power dissipation versus direct output current and ambient temperature

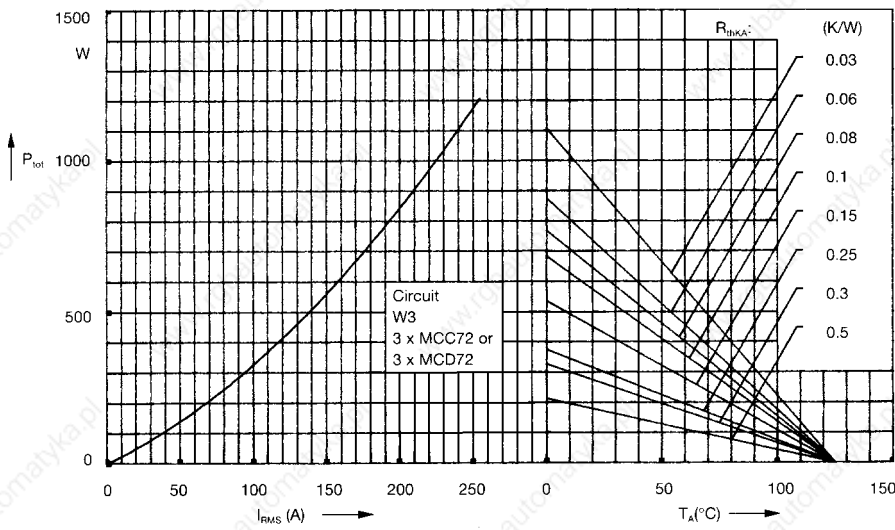

Fig. 7 Three phase AC-controller:
Power dissipation versus RMS
output current and ambient
temperature

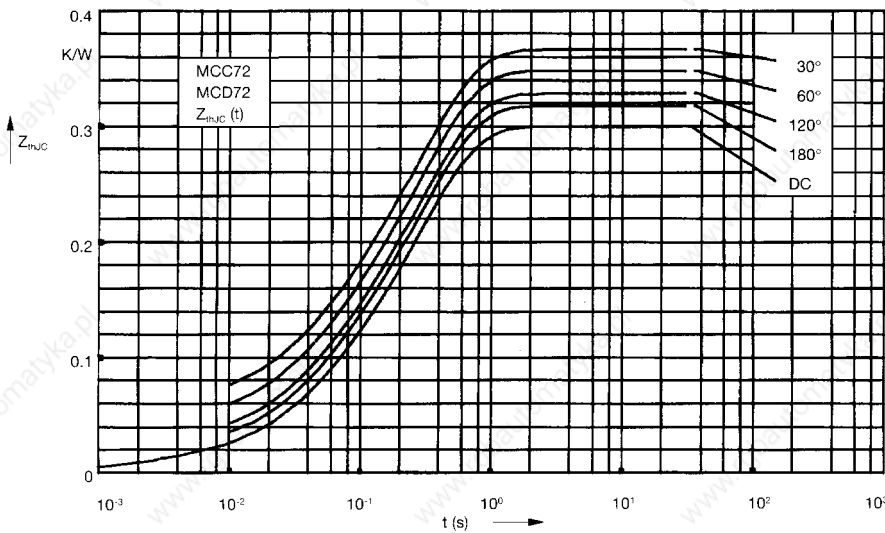

Fig. 8 Transient thermal impedance
junction to case (per thyristor or
diode)

R_{thJC} for various conduction angles d:

d	R_{thJC} (K/W)
DC	0.3
180°	0.31
120°	0.33
60°	0.35
30°	0.37

Constants for Z_{thJC} calculation:

i	R_{thi} (K/W)	t_i (s)
1	0.008	0.0019
2	0.054	0.047
3	0.238	0.3

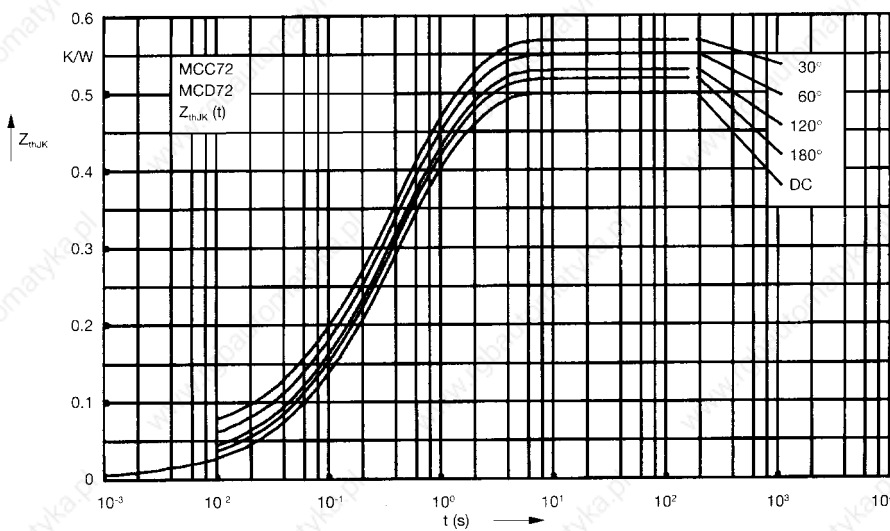

Fig. 9 Transient thermal impedance
junction to heatsink (per thyristor
or diode)

R_{thJK} for various conduction angles d:

d	R_{thJK} (K/W)
DC	0.5
180°	0.51
120°	0.53
60°	0.55
30°	0.57

Constants for Z_{thJK} calculation:

i	R_{thi} (K/W)	t_i (s)
1	0.008	0.0019
2	0.054	0.047
3	0.238	0.3
4	0.2	1.25

High Voltage Thyristor Module High Voltage Thyristor/Diode Modules

$$I_{TRMS} = 2 \times 180 \text{ A}$$

$$I_{TAVM} = 2 \times 104 \text{ A}$$

$$V_{RRM} = 2000\text{-}2200 \text{ V}$$

V_{RSM} V_{DSM} V	V_{RRM} V_{DRM} V	Type	
2100	2000	MCC 94-20io1 B	MCD 94-20io1 B
2300	2200	MCC 94-22io1 B	MCD 94-22io1 B

TO-240 AA

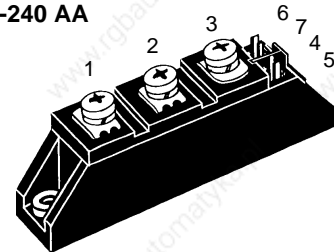

Symbol	Test Conditions	Maximum Ratings	
I_{TRMS}	$T_{VJ} = T_{VJM}$	180	A
I_{TAVM}	$T_C = 85^\circ\text{C}; 180^\circ \text{ sine}$	104	A
I_{TSM}	$T_{VJ} = 45^\circ\text{C};$ $V_R = 0$	$t = 10 \text{ ms (50 Hz)}$	1700 A
		$t = 8.3 \text{ ms (60 Hz)}$	1800 A
	$T_{VJ} = T_{VJM}$ $V_R = 0$	$t = 10 \text{ ms (50 Hz)}$	1540 A
		$t = 8.3 \text{ ms (60 Hz)}$	1640 A
$\int i^2 dt$	$T_{VJ} = 45^\circ\text{C}$ $V_R = 0$	$t = 10 \text{ ms (50 Hz)}$	14450 A^2s
		$t = 8.3 \text{ ms (60 Hz)}$	13500 A^2s
	$T_{VJ} = T_{VJM}$ $V_R = 0$	$t = 10 \text{ ms (50 Hz)}$	11850 A^2s
		$t = 8.3 \text{ ms (60 Hz)}$	11300 A^2s
$(di/dt)_{cr}$	$T_{VJ} = T_{VJM}$ $f = 50 \text{ Hz}, t_p = 200 \mu\text{s}$ $V_D = 2/3 V_{DRM}$ $I_G = 0.45 \text{ A},$ $di_G/dt = 0.45 \text{ A}/\mu\text{s}$	repetitive, $I_T = 250 \text{ A}$	150 $A/\mu\text{s}$
		non repetitive, $I_T = I_{TAVM}$	500 $A/\mu\text{s}$
$(dv/dt)_{cr}$	$T_{VJ} = T_{VJM}; V_{DR} = 2/3 V_{DRM}$ $R_{GK} = \infty; \text{method 1 (linear voltage rise)}$	1000	$V/\mu\text{s}$
P_{GM}	$T_{VJ} = T_{VJM}$ $I_T = I_{TAVM}$	$t_p = 30 \mu\text{s}$	10 W
		$t_p = 300 \mu\text{s}$	5 W
P_{GAV} V_{RGM}			0.5 W
			10 V
T_{VJ}		-40 ... 125	$^\circ\text{C}$
T_{VJM}		125	$^\circ\text{C}$
T_{stg}		-40 ... 125	$^\circ\text{C}$
V_{ISOL}	50/60 Hz, RMS $t = 1 \text{ min}$ $I_{ISOL} \leq 1 \text{ mA}$ $t = 1 \text{ s}$	3000	$V\sim$
		3600	$V\sim$
M_d	Mounting torque (M5) Terminal connection torque (M5)	2.5-4.0/22-35	Nm/lb.in.
		2.5-4.0/22-35	Nm/lb.in.
Weight	Typical including screws	90	g

MCC

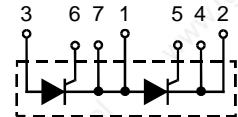

MCD

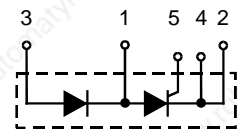

Features

- International standard package, JEDEC TO-240 AA
- Direct Copper Bonded Al_2O_3 -ceramic base plate
- Planar passivated chips
- Isolation voltage 3600 V~
- UL registered, E 72873
- Gate-cathode twin pins for version 1B

Applications

- DC motor control
- Softstart AC motor controller
- Light, heat and temperature control

Advantages

- Space and weight savings
- Simple mounting with two screws
- Improved temperature and power cycling
- Reduced protection circuits

Data according to IEC 60747 and refer to a single thyristor/diode unless otherwise stated. IXYS reserves the right to change limits, test conditions and dimensions

Symbol	Test Conditions	Characteristic Values
I_{RRM}, I_{DRM}	$T_{VJ} = T_{VJM}; V_R = V_{RRM}$	15 mA
V_T	$I_T = 300 \text{ A}; T_{VJ} = 25^\circ\text{C}$	1.74 V
V_{T0}	For power-loss calculations only ($T_{VJ} = T_{VJM}$)	0.85 V
r_T		3.2 mΩ
V_{GT}	$V_D = 6 \text{ V}; T_{VJ} = 25^\circ\text{C}$	1.5 V
	$T_{VJ} = -40^\circ\text{C}$	1.6 V
I_{GT}	$V_D = 6 \text{ V}; T_{VJ} = 25^\circ\text{C}$	100 mA
	$T_{VJ} = -40^\circ\text{C}$	200 mA
V_{GD}	$T_{VJ} = T_{VJM}; V_D = 2/3 V_{DRM}$	0.25 V
I_{GD}	$T_{VJ} = T_{VJM}; V_D = 2/3 V_{DRM}$	10 mA
I_L	$T_{VJ} = 25^\circ\text{C}; V_D = 6 \text{ V}; t_p = 30 \mu\text{s}$ $di_G/dt = 0.45 \text{ A}/\mu\text{s}; I_G = 0.45 \text{ A}$	200 mA
I_H	$T_{VJ} = 25^\circ\text{C}; V_D = 6 \text{ V}; R_{GK} = \infty$	150 mA
t_{gd}	$T_{VJ} = 25^\circ\text{C}; V_D = 1/2 V_{DRM}$ $di_G/dt = 0.45 \text{ A}/\mu\text{s}; I_G = 0.45 \text{ A}$	2 μs
t_q	$T_{VJ} = T_{VJM}; V_R = 100 \text{ V}; V_D = 2/3 V_{DRM}; t_p = 200 \mu\text{s}$ $dv/dt = 20 \text{ V}/\mu\text{s}; I_T = 150 \text{ A}; -di/dt = 10 \text{ A}/\mu\text{s}$	typ. 185 μs
Q_S	} $T_{VJ} = T_{VJM}$	170 μC
I_{RM}		-di/dt = 6 A/μs; $I_T = 50 \text{ A}$
R_{thJC}	per thyristor; DC current	0.22 K/W
	per module	0.11 K/W
R_{thJK}	per thyristor; DC current	0.42 K/W
	per module	0.21 K/W
d_s	Creeping distance on surface	12.7 mm
d_A	Creepage distance in air	9.6 mm
a	Maximum allowable acceleration	50 m/s ²

Optional accessories for module-type MCC 94 version 1 B

Keyed gate/cathode twin plugs with wire length = 350 mm, gate = yellow, cathode = red

Type ZY 200L (L = Left for pin pair 4/5) } UL 758, style 1385,
Type ZY 200R (R = right for pin pair 6/7) } CSA class 5851, guide 460-1-1

Dimensions in mm (1 mm = 0.0394")

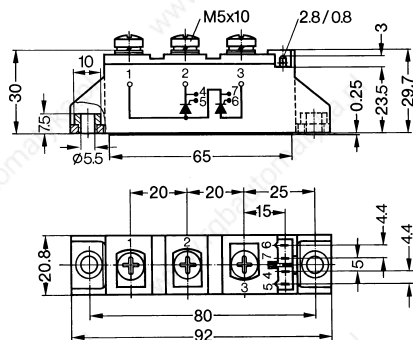

R_{thJC} for various conduction angles d:

d	R_{thJC} (K/W)
DC	0.22
180°	0.23
120°	0.25
60°	0.27
30°	0.28

Constants for Z_{thJC} calculation:

i	R_{thi} (K/W)	t_i (s)
1	0.0066	0.0019
2	0.0678	0.0477
3	0.1456	0.344

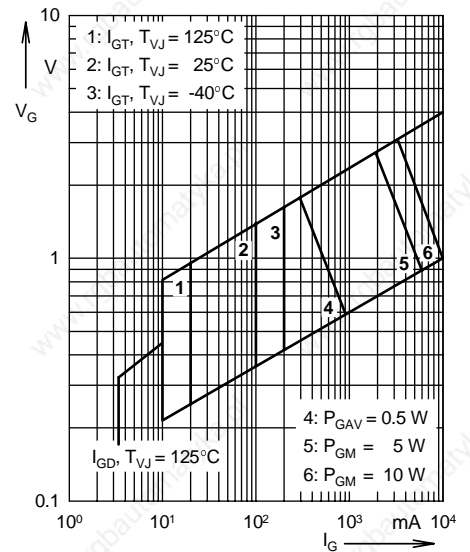

Fig. 1 Gate trigger characteristics

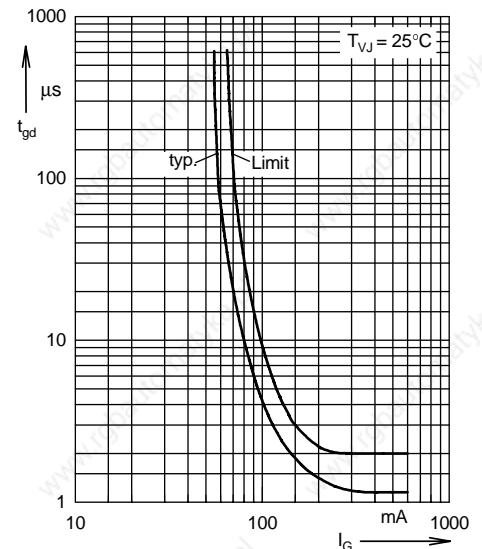

Fig. 2 Gate trigger delay time

R_{thJK} for various conduction angles d:

d	R_{thJK} (K/W)
DC	0.42
180°	0.43
120°	0.45
60°	0.47
30°	0.48

Constants for Z_{thJK} calculation:

i	R_{thi} (K/W)	t_i (s)
1	0.0066	0.0019
2	0.0678	0.0477
3	0.1456	0.344
4	0.2	1.32

Thyristor Modules Thyristor/Diode Modules

$$I_{TRMS} = 2 \times 180 \text{ A}$$

$$I_{TAVM} = 2 \times 116 \text{ A}$$

$$V_{RRM} = 800-1800 \text{ V}$$

V_{RSM} V_{DSM} V	V_{RRM} V_{DRM} V	Type	
		Version 1	Version 8
900	800	MCC 95-08io1 B	--
1300	1200	MCC 95-12io1 B	MCD 95-12io1 B
1500	1400	MCC 95-14io1 B	--
1700	1600	MCC 95-16io1 B	MCD 95-16io1 B
1900	1800	MCC 95-18io1 B	--
		MCC 95-08io8 B	MCD 95-08io8 B
		MCC 95-12io8 B	MCD 95-12io8 B
		MCC 95-14io8 B	MCD 95-14io8 B
		MCC 95-16io8 B	MCD 95-16io8 B
		MCC 95-18io8 B	MCD 95-18io8 B
1500	1400	MCC 95-16io1	
1700	1600	MCC 95-18io1	

TO-240 AA

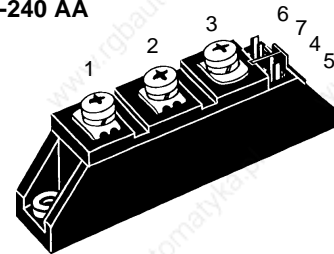

Symbol	Test Conditions	Maximum Ratings	
I_{TRMS}^1 , I_{FRMS} I_{TAVM}^2 , I_{FAVM}	$T_{VJ} = T_{VJM}$ $T_C = 85^\circ\text{C}$; 180° sine	180	A
I_{TSM}^1 , I_{FSM}	$T_{VJ} = 45^\circ\text{C}$; $V_R = 0$	t = 10 ms (50 Hz), sine t = 8.3 ms (60 Hz), sine	2250 A 2400 A
ji^2dt	$T_{VJ} = 45^\circ\text{C}$ $V_R = 0$	t = 10 ms (50 Hz), sine	25 300 A ² s
		t = 8.3 ms (60 Hz), sine	23 900 A ² s
$(di/dt)_{cr}$	$T_{VJ} = T_{VJM}$ $V_R = 0$	t = 10 ms (50 Hz), sine	20 000 A ² s
		t = 8.3 ms (60 Hz), sine	19 100 A ² s
$(dv/dt)_{cr}$	$T_{VJ} = T_{VJM}$ $R_{GK} = \infty$; method 1 (linear voltage rise)	repetitive, $I_T = 250 \text{ A}$	150 A/ μs
		non repetitive, $I_T = I_{TAVM}$	500 A/ μs
P_{GM}	$T_{VJ} = T_{VJM}$ $I_T = I_{TAVM}$	$t_p = 30 \mu\text{s}$ $t_p = 300 \mu\text{s}$	10 W 5 W
P_{GAV}			0.5 W
V_{RGM}			10 V
T_{VJ}			-40...+125 °C
T_{VJM}			125 °C
T_{stg}			-40...+125 °C
V_{ISOL}	$I_{ISOL} \leq 1 \text{ mA}$	t = 1 min	3000 V~
		t = 1 s	3600 V~
M_d	Mounting torque (M5) Terminal connection torque (M5)		2.5-4.0/22-35 Nm/lb.in.
			2.5-4.0/22-35 Nm/lb.in.
Weight	Typical including screws		90 g

MCC
Version 1

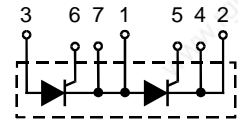

MCD
Version 1

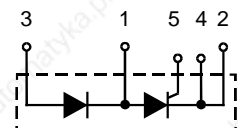

MCC
Version 8

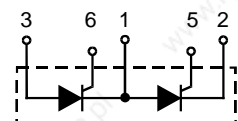

MCD
Version 8

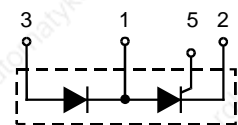

Features

- International standard package, JEDEC TO-240 AA
- Direct copper bonded Al_2O_3 -ceramic base plate
- Planar passivated chips
- Isolation voltage 3600 V~
- UL registered, E 72873
- Gate-cathode twin pins for version 1

Applications

- DC motor control
- Softstart AC motor controller
- Light, heat and temperature control

Advantages

- Space and weight savings
- Simple mounting with two screws
- Improved temperature and power cycling
- Reduced protection circuits

Data according to IEC 60747 and refer to a single thyristor/diode unless otherwise stated. IXYS reserves the right to change limits, test conditions and dimensions

Symbol	Test Conditions	Characteristic Values
I_{RRM}, I_{DRM}	$T_{VJ} = T_{VJM}; V_R = V_{RRM}; V_D = V_{DRM}$	5 mA
V_T, V_F	$I_T, I_F = 300 \text{ A}; T_{VJ} = 25^\circ\text{C}$	1.5 V
V_{T0}	For power-loss calculations only ($T_{VJ} = 125^\circ\text{C}$)	0.8 V
r_T		2.4 mΩ
V_{GT}	$V_D = 6 \text{ V}; T_{VJ} = 25^\circ\text{C}$	2.5 V
	$T_{VJ} = -40^\circ\text{C}$	2.6 V
I_{GT}	$V_D = 6 \text{ V}; T_{VJ} = 25^\circ\text{C}$	150 mA
	$T_{VJ} = -40^\circ\text{C}$	200 mA
V_{GD}	$T_{VJ} = T_{VJM}; V_D = 2/3 V_{DRM}$	0.2 V
I_{GD}		10 mA
I_L	$T_{VJ} = 25^\circ\text{C}; t_p = 10 \mu\text{s}; V_D = 6 \text{ V}$ $I_G = 0.45 \text{ A}; di_G/dt = 0.45 \text{ A}/\mu\text{s}$	450 mA
I_H	$T_{VJ} = 25^\circ\text{C}; V_D = 6 \text{ V}; R_{GK} = \infty$	200 mA
t_{gd}	$T_{VJ} = 25^\circ\text{C}; V_D = 1/2 V_{DRM}$ $I_G = 0.45 \text{ A}; di_G/dt = 0.45 \text{ A}/\mu\text{s}$	2 μs
t_q	$T_{VJ} = T_{VJM}; I_T = 150 \text{ A}, t_p = 200 \mu\text{s}; -di/dt = 10 \text{ A}/\mu\text{s}$ typ. $V_R = 100 \text{ V}; dv/dt = 20 \text{ V}/\mu\text{s}; V_D = 2/3 V_{DRM}$	185 μs
Q_S	$T_{VJ} = T_{VJM}; I_T, I_F = 50 \text{ A}, -di/dt = 6 \text{ A}/\mu\text{s}$	170 μC
I_{RM}		45 A
R_{thJC}	per thyristor/diode; DC current per module	0.22 K/W
R_{thJK}	per thyristor/diode; DC current per module	0.11 K/W 0.42 K/W 0.21 K/W
	other values see Fig. 8/9	
d_s	Creepage distance on surface	12.7 mm
d_A	Strike distance through air	9.6 mm
a	Maximum allowable acceleration	50 m/s ²

Optional accessories for module-type MCC 95 version 1 B

Keyed gate/cathode twin plugs with wire length = 350 mm, gate = yellow, cathode = red

Type ZY 200L (L = Left for pin pair 4/5) } UL 758, style 1385,
Type ZY 200R (R = right for pin pair 6/7) } CSA class 5851, guide 460-1-1

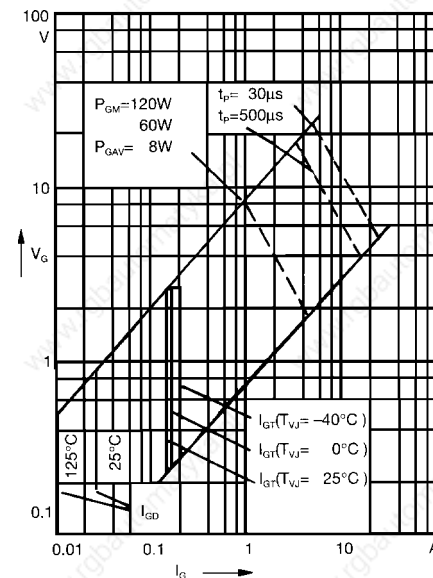

Fig. 1 Gate trigger characteristics

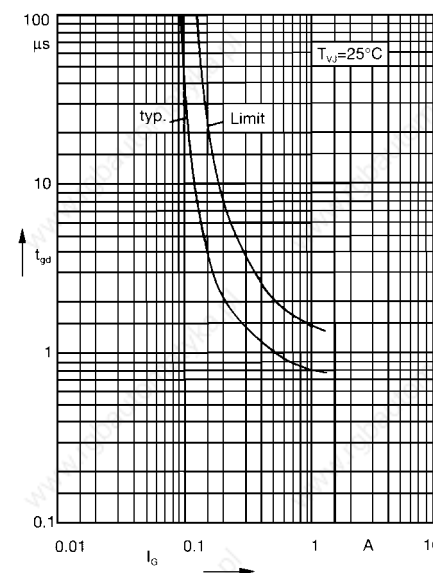
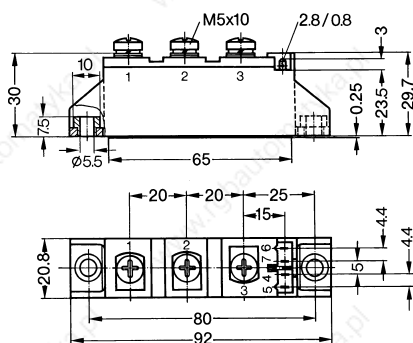

Fig. 2 Gate trigger delay time

Dimensions in mm (1 mm = 0.0394")

MCC / MCD Version 1 B



MCC Version 8 B

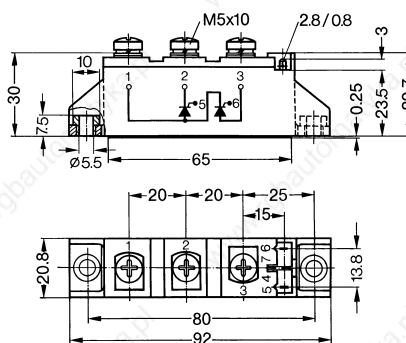

MCD Version 8 B

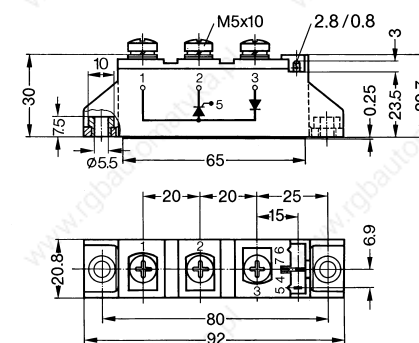

Version 1 or 8 without B in typ designation = without insert in mounting holes

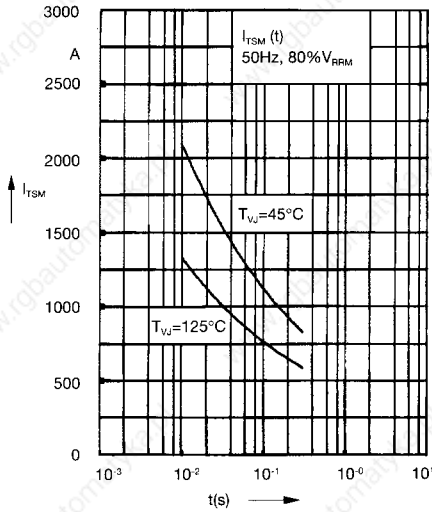

Fig. 3 Surge overload current
 I_{TSM} , I_{FSM} : Crest value, t: duration

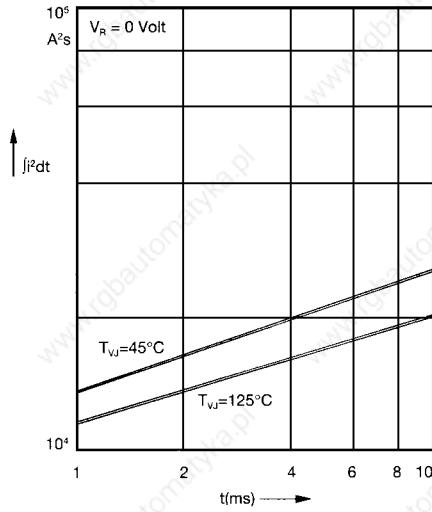

Fig. 4 j^2dt versus time (1-10 ms)

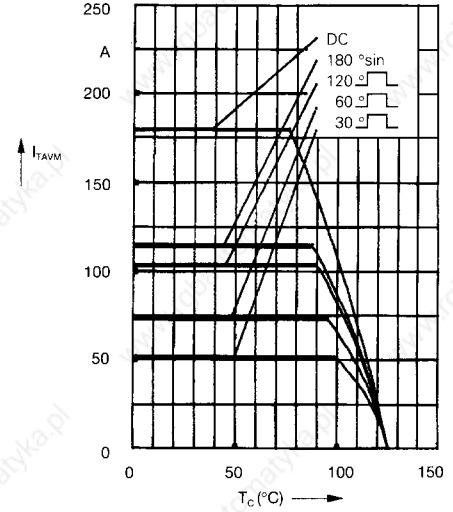

Fig. 4a Maximum forward current at case temperature

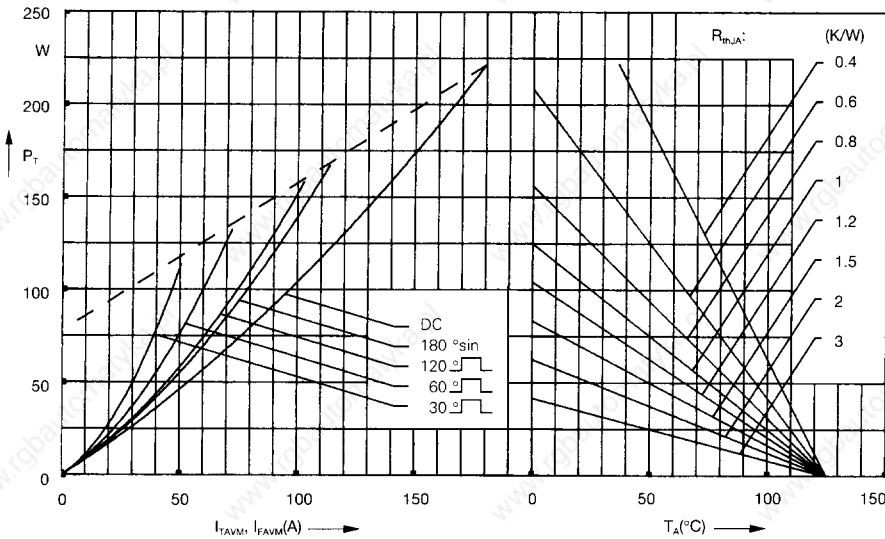

Fig. 5 Power dissipation versus on-state current and ambient temperature (per thyristor or diode)

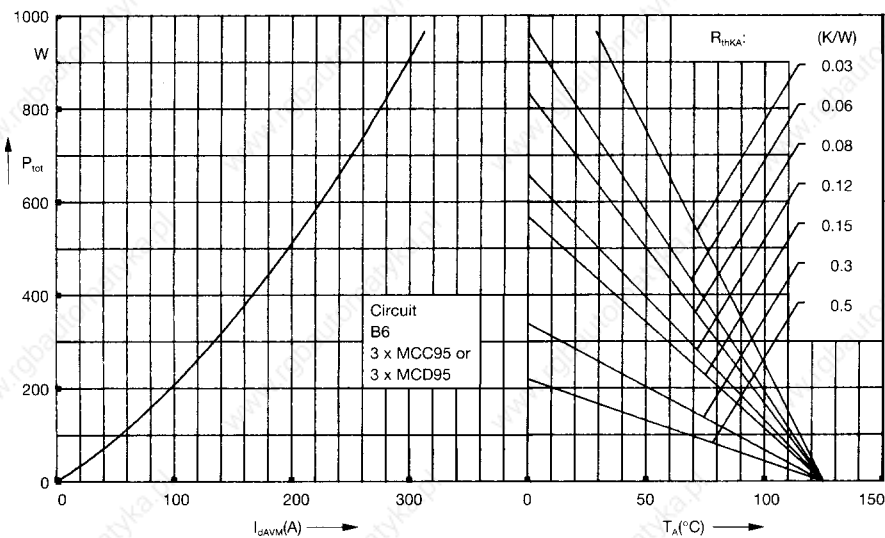

Fig. 6 Three phase rectifier bridge: Power dissipation versus direct output current and ambient temperature

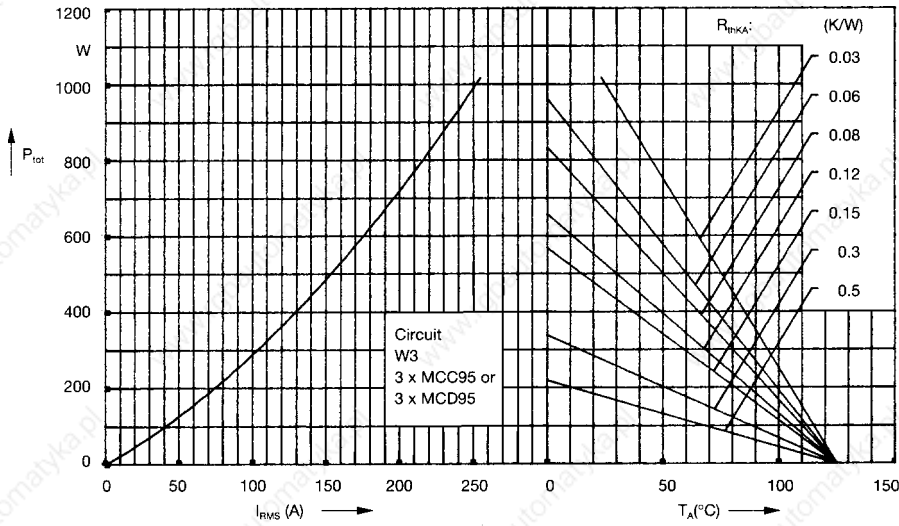

Fig. 7 Three phase AC-controller:
Power dissipation versus RMS
output current and ambient
temperature

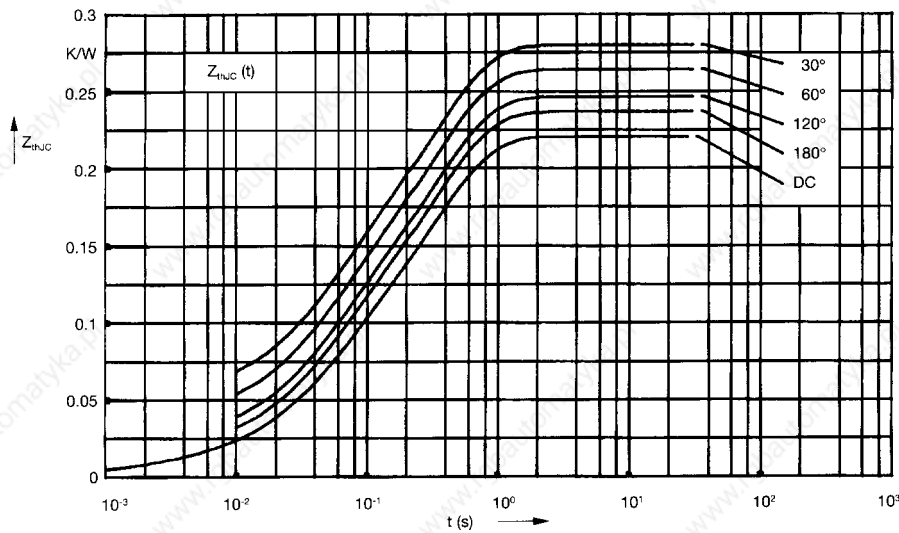

Fig. 8 Transient thermal impedance
junction to case (per thyristor or
diode)

R_{thJC} for various conduction angles d:

d	R_{thJC} (K/W)
DC	0.22
180°	0.23
120°	0.25
60°	0.27
30°	0.28

Constants for Z_{thJC} calculation:

i	R_{thi} (K/W)	t_i (s)
1	0.0066	0.0019
2	0.0678	0.0477
3	0.1456	0.344

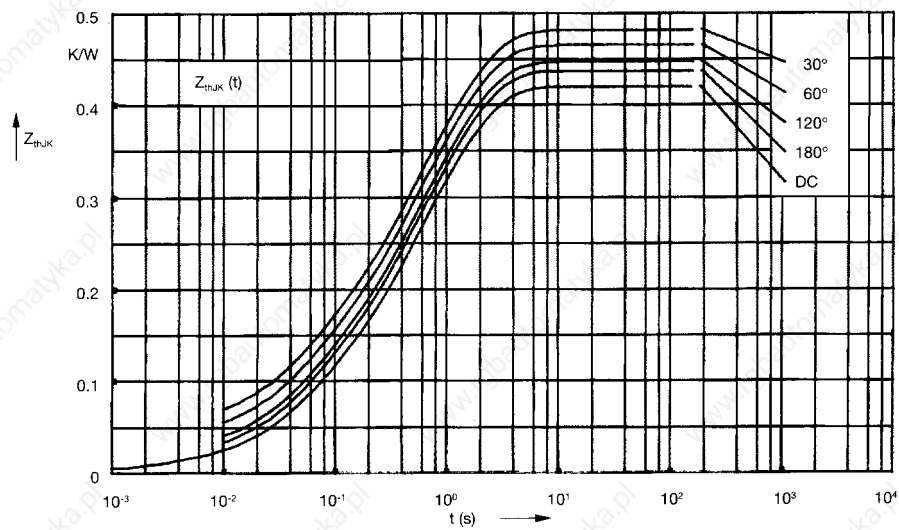

Fig. 9 Transient thermal impedance
junction to heatsink (per thyristor or
diode)

R_{thJK} for various conduction angles d:

d	R_{thJK} (K/W)
DC	0.42
180°	0.43
120°	0.45
60°	0.47
30°	0.48

Constants for Z_{thJK} calculation:

i	R_{thi} (K/W)	t_i (s)
1	0.0066	0.0019
2	0.0678	0.0477
3	0.1456	0.344
4	0.2	1.32

Thyristor Module

Preliminary data

$$I_{TRMS} = 2 \times 300 \text{ A}$$

$$I_{TAVM} = 2 \times 128 \text{ A}$$

$$V_{RRM, DRM} = 800-1800 \text{ V}$$

V_{RSM}	V_{RRM}	Type
V_{DSM}	V_{DRM}	
V	V	
900	800	MCC 122-08io1
1300	1200	MCC 122-12io1
1500	1400	MCC 122-14io1
1700	1600	MCC 122-16io1
1900	1800	MCC 122-18io1

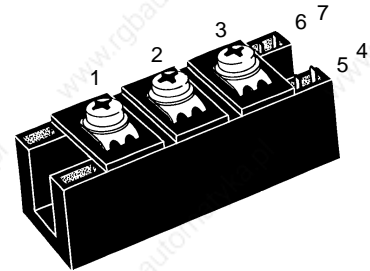
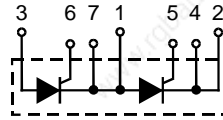

Symbol	Conditions	Maximum Ratings	
I_{TRMS}		300 A	
I_{TAVM}	$T_C = 85^\circ\text{C}; 180^\circ \text{ sine}$	128 A	
I_{TSM}	$T_{VJ} = 45^\circ\text{C}$ $V_R = 0$	$t = 10 \text{ ms (50 Hz), sine}$ $t = 8.3 \text{ ms (60 Hz), sine}$	3600 A 3850 A
	$T_{VJ} = T_{VJM}$ $V_R = 0$	$t = 10 \text{ ms (50 Hz), sine}$ $t = 8.3 \text{ ms (60 Hz), sine}$	3200 A 3420 A
I^2dt	$T_{VJ} = 45^\circ\text{C}$ $V_R = 0$	$t = 10 \text{ ms (50 Hz), sine}$ $t = 8.3 \text{ ms (60 Hz), sine}$	64800 A ² s 62300 A ² s
	$T_{VJ} = T_{VJM}$ $V_R = 0$	$t = 10 \text{ ms (50 Hz), sine}$ $t = 8.3 \text{ ms (60 Hz), sine}$	51200 A ² s 49100 A ² s
$(di/dt)_{cr}$	$T_{VJ} = T_{VJM}$ $f = 50\text{Hz}, t_p = 200\mu\text{s}$ $V_D = \frac{2}{3} V_{DRM}$ $I_G = 0.5 \text{ A}$ $di_G/dt = 0.5 \text{ A}/\mu\text{s}$	repetitive, $I_T = 500 \text{ A}$	150 A/ μs
		non repetitive, $I_T = 500 \text{ A}$	500 A/ μs
$(dv/dt)_{cr}$	$T_{VJ} = T_{VJM};$ $R_{GK} = \infty; \text{ method 1 (linear voltage rise)}$	$V_{DR} = \frac{2}{3} V_{DRM}$	1000 V/ μs
P_{GM}	$T_{VJ} = T_{VJM}$	$t_p = 30 \mu\text{s}$	120 W
	$I_T = I_{TAVM}$	$t_p = 500 \mu\text{s}$	60 W
P_{GAV}			8 W
V_{RGM}			10 V
T_{VJ}			-40...+125 °C
T_{VJM}			125 °C
T_{stg}			-40...+125 °C
V_{ISOL}	50/60 Hz, RMS	$t = 1 \text{ min}$	3000 V~
	$I_{ISOL} \leq 1 \text{ mA}$	$t = 1 \text{ s}$	3600 V~
M_d	Mounting torque (M6)		2.25-2.75/20-25 Nm/lb.in.
	Terminal connection torque (M6)		4.5-5.5/40-48 Nm/lb.in.
Weight	Typical including screws		125 g

Features

- International standard package
- Direct copper bonded Al₂O₃-ceramic base plate
- Planar passivated chips
- Isolation voltage 3600 V~
- UL registered, E 72873
- Keyed gate/cathode twin pins

Applications

- Motor control
- Power converter
- Heat and temperature control for industrial furnaces and chemical processes
- Lighting control
- Contactless switches

Advantages

- Space and weight savings
- Simple mounting
- Improved temperature and power cycling
- Reduced protection circuits

Dimensions in mm (1 mm = 0.0394")

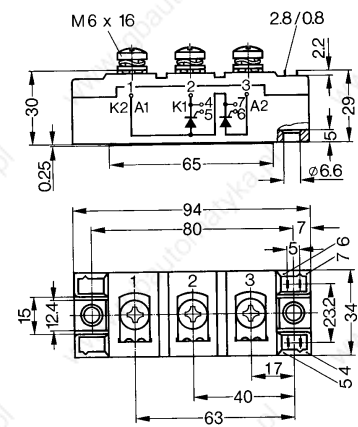

Data according to IEC 60747 and refer to a single thyristor/diode unless otherwise stated.

Symbol	Conditions	Characteristic Values	
I_{RRM}, I_{DRM}	$T_{VJ} = T_{VJM}; V_R = V_{RRM}; V_D = V_{DRM}$	10	mA
V_T, V_F	$I_T, I_F = 120 \text{ A}; T_{VJ} = 25^\circ\text{C}$	1.13	V
V_{T0}	$T_{VJ} = 125^\circ\text{C};$ For power-loss calculations only	0.85	V
r_T	$T_{VJ} = T_{VJM}$	2	m Ω
V_{GT}	$V_D = 6 \text{ V};$ $T_{VJ} = 25^\circ\text{C}$ $T_{VJ} = -40^\circ\text{C}$	1.4 1.6	V V
I_{GT}	$V_D = 6 \text{ V};$ $T_{VJ} = 25^\circ\text{C}$ $T_{VJ} = -40^\circ\text{C}$	150 200	mA mA
V_{GD}	$T_{VJ} = T_{VJM}; V_D = \frac{2}{3} V_{DRM}$	0.2	V
I_{GD}		10	mA
I_L	$T_{VJ} = 25^\circ\text{C}; t_p = 10 \mu\text{s}, V_D = 6 \text{ V}$ $I_G = 0.45 \text{ A}; di_G/dt = 0.45 \text{ A}/\mu\text{s}$	300	mA
I_H	$T_{VJ} = 25^\circ\text{C}; V_D = 6 \text{ V}; R_{GK} = \infty$	200	mA
t_{gd}	$T_{VJ} = 25^\circ\text{C}; V_D = \frac{1}{2} V_{DRM}$ $I_G = 0.45 \text{ A}; di_G/dt = 0.45 \text{ A}/\mu\text{s}$	2	μs
t_q	$T_{VJ} = T_{VJM}; I_T = 120 \text{ A}, t_p = 200 \mu\text{s}; -di/dt = 10 \text{ A}/\mu\text{s typ.}$ $V_R = 100 \text{ V}; dv/dt = 20 \text{ V}/\mu\text{s}; V_D = \frac{2}{3} V_{DRM}$	150	μs
Q_S	$T_{VJ} = T_{VJM}; I_T, I_F = 200 \text{ A}, -di/dt = 50 \text{ A}/\mu\text{s}$	330	μC
I_{RM}		180	A
R_{thJC}	per thyristor/diode; DC current	0.2	K/W
	per module	0.1	K/W
R_{thCH}	per thyristor/diode; DC current	typ. 0.1	K/W
d_s	Creepage distance on surface	12.7	mm
d_A	Strike distance through air	9.6	mm
a	Maximum allowable acceleration	50	m/s ²

Optional accessories for modules

Keyed gate/cathode twin plugs with wire length = 350 mm, gate = yellow, cathode = red

Type **ZY 180L** (L = Left for pin pair 4/5) } UL Styles 1385,
 Type **ZY 180R** (R = right for pin pair 6/7) } CSA Class 5851, File 41234

Thyristor Modules Thyristor/Diode Modules

$$I_{TRMS} = 2 \times 300 \text{ A}$$

$$I_{TAVM} = 2 \times 130 \text{ A}$$

$$V_{RRM} = 800-1800 \text{ V}$$

V_{RSM} V_{DSM} V	V_{RRM} V_{DRM} V	Type	Version 1	Version 1
900	800	MCC 132-08io1	MCC 132-08io1	MCD 132-08io1
1300	1200	MCC 132-12io1	MCC 132-12io1	MCD 132-12io1
1500	1400	MCC 132-14io1	MCC 132-14io1	MCD 132-14io1
1700	1600	MCC 132-16io1	MCC 132-16io1	MCD 132-16io1
1900	1800	MCC 132-18io1	MCC 132-18io1	MCD 132-18io1

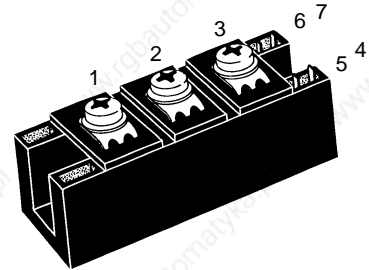

Symbol	Test Conditions	Maximum Ratings
I_{TRMS}^1, I_{FRMS} I_{TAVM}^2, I_{FAVM}	$T_{VJ} = T_{VJM}$ $T_C = 85^\circ\text{C}; 180^\circ \text{ sine}$	300 A 130 A
I_{TSM}^3, I_{FSM}	$T_{VJ} = 45^\circ\text{C};$ $V_R = 0$	$t = 10 \text{ ms (50 Hz), sine}$ 4750 A $t = 8.3 \text{ ms (60 Hz), sine}$ 5080 A
	$T_{VJ} = T_{VJM}$ $V_R = 0$	$t = 10 \text{ ms (50 Hz), sine}$ 4230 A $t = 8.3 \text{ ms (60 Hz), sine}$ 4530 A
ji^2dt	$T_{VJ} = 45^\circ\text{C}$ $V_R = 0$	$t = 10 \text{ ms (50 Hz), sine}$ 113 000 A ² s $t = 8.3 \text{ ms (60 Hz), sine}$ 108 000 A ² s
	$T_{VJ} = T_{VJM}$ $V_R = 0$	$t = 10 \text{ ms (50 Hz), sine}$ 89 500 A ² s $t = 8.3 \text{ ms (60 Hz), sine}$ 86 200 A ² s
$(di/dt)_{cr}$	$T_{VJ} = T_{VJM}$ $f = 50 \text{ Hz}, t_p = 200 \mu\text{s}$ $V_D = 2/3 V_{DRM}$ $I_G = 0.5 \text{ A}$ $di_G/dt = 0.5 \text{ A}/\mu\text{s}$	repetitive, $I_T = 500 \text{ A}$ 150 A/ μs non repetitive, $I_T = 500 \text{ A}$ 500 A/ μs
$(dv/dt)_{cr}$	$T_{VJ} = T_{VJM};$ $R_{GK} = \infty;$ method 1 (linear voltage rise)	$V_{DR} = 2/3 V_{DRM}$ 1000 V/ μs
P_{GM}	$T_{VJ} = T_{VJM}$ $I_T = I_{TAVM}$	$t_p = 30 \mu\text{s}$ 120 W $t_p = 500 \mu\text{s}$ 60 W
P_{GAV}		8 W
V_{RGM}		10 V
T_{VJ}		-40...+125 °C
T_{VJM}		125 °C
T_{stg}		-40...+125 °C
V_{ISOL}	50/60 Hz, RMS $I_{ISOL} \leq 1 \text{ mA}$	$t = 1 \text{ min}$ 3000 V~ $t = 1 \text{ s}$ 3600 V~
M_d	Mounting torque (M6) Terminal connection torque (M6)	2.25-2.75/20-25 Nm/lb.in. 4.5-5.5/40-48 Nm/lb.in.
Weight	Typical including screws	125 g

MCC

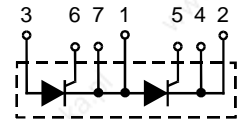

MCD

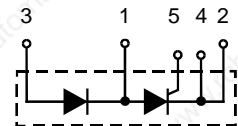

Features

- International standard package
- Direct copper bonded Al₂O₃ -ceramic base plate
- Planar passivated chips
- Isolation voltage 3600 V~
- UL registered, E 72873
- Keyed gate/cathode twin pins

Applications

- Motor control
- Power converter
- Heat and temperature control for industrial furnaces and chemical processes
- Lighting control
- Contactless switches

Advantages

- Space and weight savings
- Simple mounting
- Improved temperature and power cycling
- Reduced protection circuits

Data according to IEC 60747 and refer to a single thyristor/diode unless otherwise stated. IXYS reserves the right to change limits, test conditions and dimensions

Symbol	Test Conditions	Characteristic Values
I_{RRM}, I_{DRM}	$T_{VJ} = T_{VJM}; V_R = V_{RRM}; V_D = V_{DRM}$	10 mA
V_T, V_F	$I_T, I_F = 300 \text{ A}; T_{VJ} = 25^\circ\text{C}$	1.36 V
V_{T0}	For power-loss calculations only ($T_{VJ} = 125^\circ\text{C}$)	0.8 V
r_T		1.5 mΩ
V_{GT}	$V_D = 6 \text{ V}; T_{VJ} = 25^\circ\text{C}$	2.5 V
	$T_{VJ} = -40^\circ\text{C}$	2.6 V
I_{GT}	$V_D = 6 \text{ V}; T_{VJ} = 25^\circ\text{C}$	150 mA
	$T_{VJ} = -40^\circ\text{C}$	200 mA
V_{GD}	$T_{VJ} = T_{VJM}; V_D = 2/3 V_{DRM}$	0.2 V
I_{GD}		10 mA
I_L	$T_{VJ} = 25^\circ\text{C}; t_p = 30 \mu\text{s}; V_D = 6 \text{ V}$ $I_G = 0.5 \text{ A}; di_G/dt = 0.5 \text{ A}/\mu\text{s}$	300 mA
I_H	$T_{VJ} = 25^\circ\text{C}; V_D = 6 \text{ V}; R_{GK} = \infty$	200 mA
t_{gd}	$T_{VJ} = 25^\circ\text{C}; V_D = 1/2 V_{DRM}$ $I_G = 0.5 \text{ A}; di_G/dt = 0.5 \text{ A}/\mu\text{s}$	2 μs
t_q	$T_{VJ} = T_{VJM}; I_T = 160 \text{ A}, t_p = 200 \mu\text{s}; -di/dt = 10 \text{ A}/\mu\text{s}$ typ. $V_R = 100 \text{ V}; dv/dt = 20 \text{ V}/\mu\text{s}; V_D = 2/3 V_{DRM}$	150 μs
Q_S	$T_{VJ} = T_{VJM}; I_T, I_F = 300 \text{ A}, -di/dt = 50 \text{ A}/\mu\text{s}$	550 μC
I_{RM}		235 A
R_{thJC}	per thyristor/diode; DC current per module	0.23 K/W
R_{thJK}	per thyristor/diode; DC current per module	0.115 K/W 0.33 K/W 0.165 K/W
	other values see Fig. 8/9	
d_s	Creepage distance on surface	12.7 mm
d_A	Strike distance through air	9.6 mm
a	Maximum allowable acceleration	50 m/s ²

Optional accessories for modules

Keyed gate/cathode twin plugs with wire length = 350 mm, gate = yellow, cathode = red
 Type **ZY 180L** (L = Left for pin pair 4/5) } UL 758, style 1385,
 Type **ZY 180R** (R = right for pin pair 6/7) } CSA class 5851, guide 460-1-1

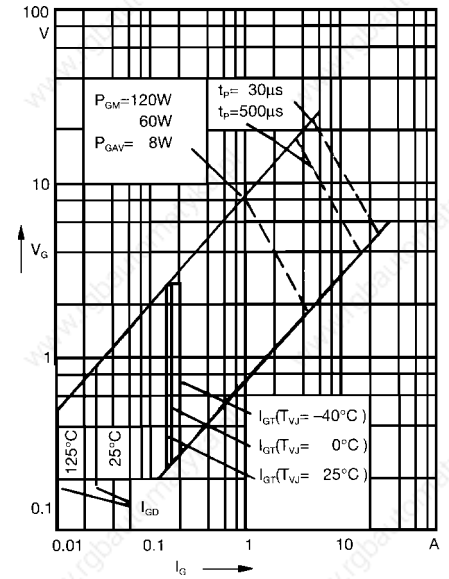

Fig. 1 Gate trigger characteristics

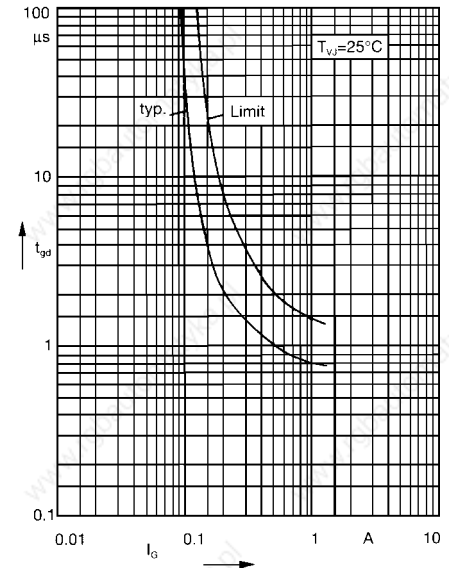
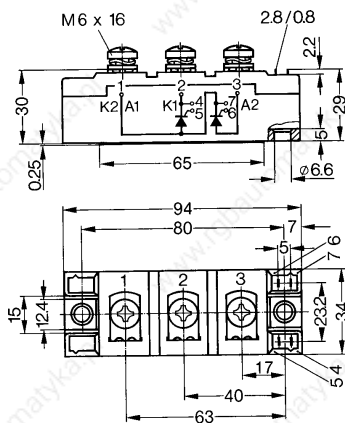

Fig. 2 Gate trigger delay time

Dimensions in mm (1 mm = 0.0394")

MCC



MCD

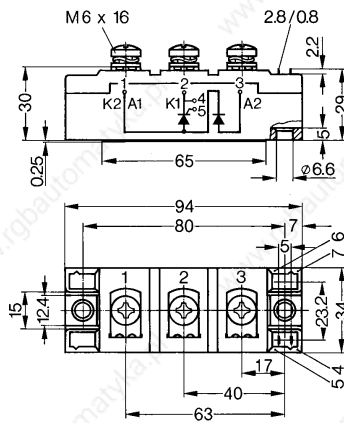

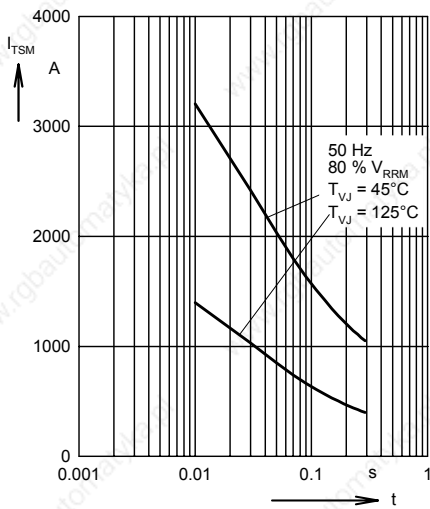

Fig. 3 Surge overload current
 I_{TSM}, I_{FSM} : Crest value, t : duration

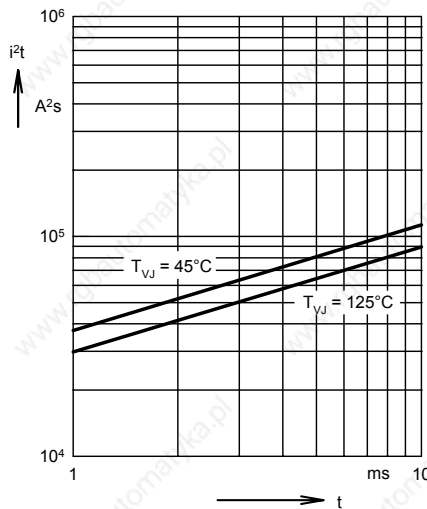

Fig. 4 i^2t versus time (1-10 ms)

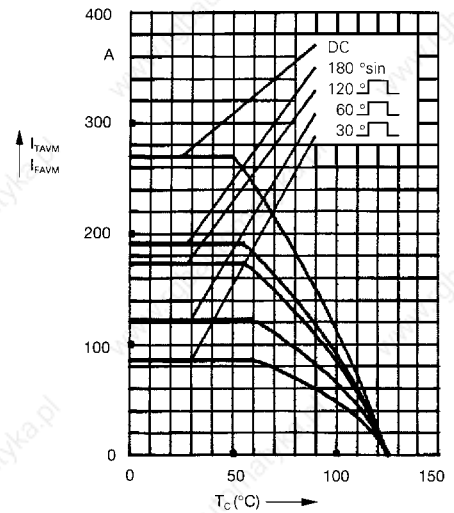

Fig. 4a Maximum forward current at case temperature

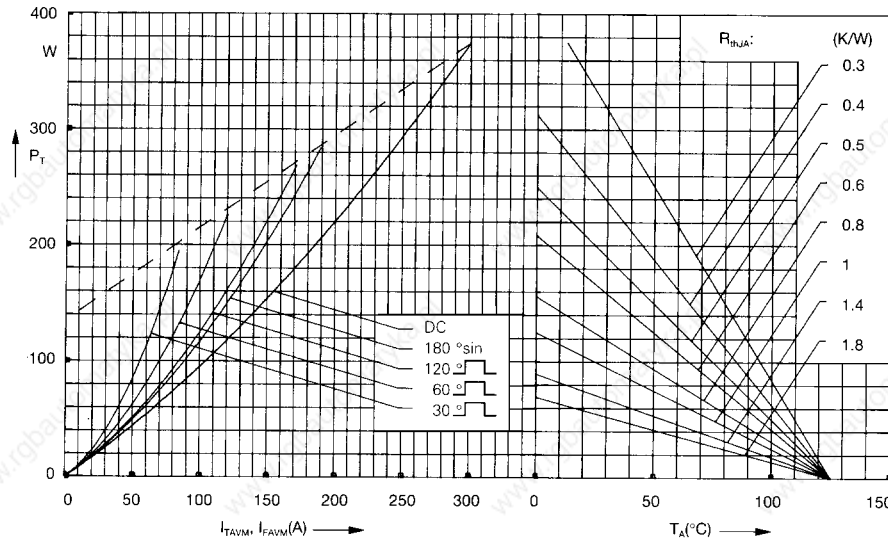

Fig. 5 Power dissipation versus on-state current and ambient temperature (per thyristor or diode)

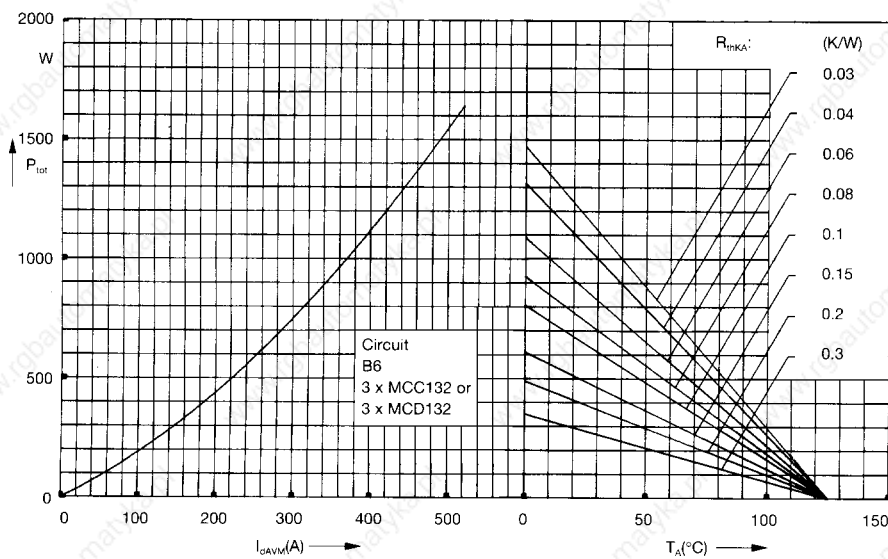

Fig. 6 Three phase rectifier bridge: Power dissipation versus direct output current and ambient temperature

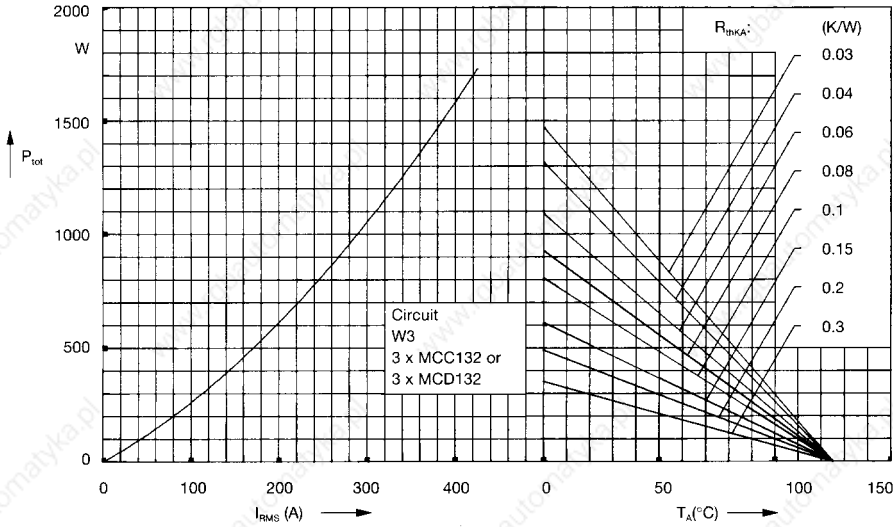

Fig. 7 Three phase AC-controller: Power dissipation versus RMS output current and ambient temperature

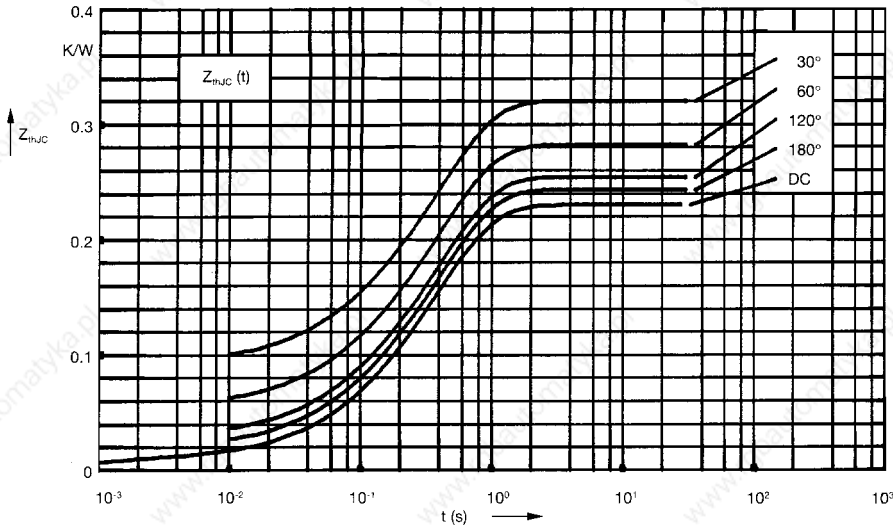

Fig. 8 Transient thermal impedance junction to case (per thyristor or diode)

R_{thJC} for various conduction angles d:

d	R_{thJC} (K/W)
DC	0.230
180°	0.244
120°	0.255
60°	0.283
30°	0.321

Constants for Z_{thJC} calculation:

i	R_{thi} (K/W)	t_i (s)
1	0.0095	0.001
2	0.0175	0.065
3	0.203	0.4

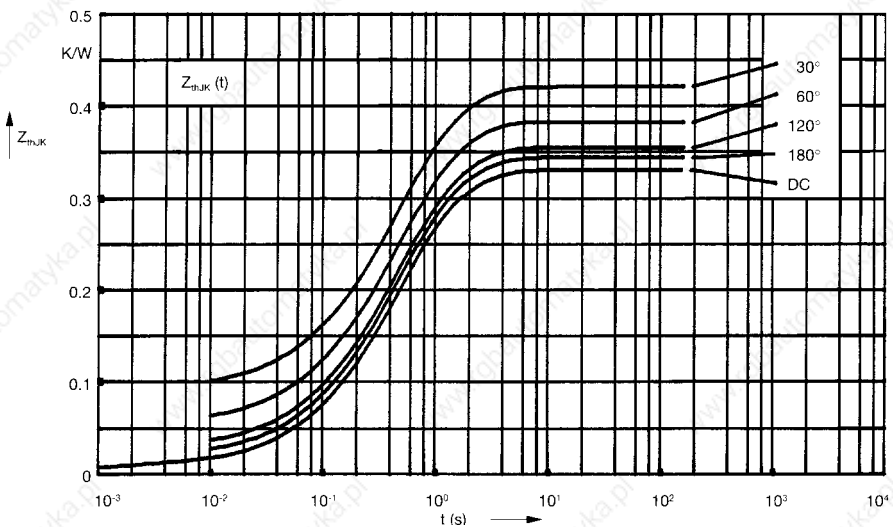

Fig. 9 Transient thermal impedance junction to heatsink (per thyristor or diode)

R_{thJK} for various conduction angles d:

d	R_{thJK} (K/W)
DC	0.330
180°	0.344
120°	0.355
60°	0.383
30°	0.421

Constants for Z_{thJK} calculation:

i	R_{thi} (K/W)	t_i (s)
1	0.0095	0.001
2	0.0175	0.065
3	0.203	0.4
4	0.1	1.29

High Voltage Thyristor Module High Voltage High Voltage

$$I_{TRMS} = 2x 300 A$$

$$I_{TAVM} = 2x 165 A$$

$$V_{RRM} = 2000-2200 V$$

V_{RSM} V_{DSM} V	V_{RRM} V_{DRM} V	Type	
2100 2300	2000 2200	MCC 161-20io1 MCC 161-22io1	MCD 161-20io1 MCD 161-22io1

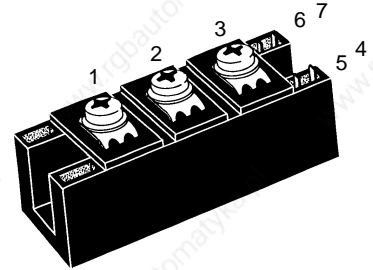

Symbol	Test Conditions	Maximum Ratings		
I_{TRMS} I_{TAVM}	$T_{VJ} = T_{VJM}$ $T_C = 85^{\circ}C$; 180° sine	300 165	A A	
I_{TSM}	$T_{VJ} = 45^{\circ}C$; $V_R = 0$	t = 10 ms (50 Hz) t = 8.3 ms (60 Hz)	A A	
	$T_{VJ} = T_{VJM}$ $V_R = 0$	t = 10 ms (50 Hz) t = 8.3 ms (60 Hz)	A A	
$\int i^2 dt$	$T_{VJ} = 45^{\circ}C$ $V_R = 0$	t = 10 ms (50 Hz) t = 8.3 ms (60 Hz)	A ² s A ² s	
	$T_{VJ} = T_{VJM}$ $V_R = 0$	t = 10 ms (50 Hz) t = 8.3 ms (60 Hz)	A ² s A ² s	
$(di/dt)_{cr}$	$T_{VJ} = T_{VJM}$ f = 50 Hz, $t_p = 200 \mu s$ $V_D = 2/3 V_{DRM}$ $I_G = 0.5 A$, $di_G/dt = 0.5 A/\mu s$	repetitive, $I_T = 500 A$ non repetitive, $I_T = I_{TAVM}$	150 500	A/ μs A/ μs
	$T_{VJ} = T_{VJM}$; $V_{DR} = 2/3 V_{DRM}$ $R_{GK} = \infty$; method 1 (linear voltage rise)		1000	V/ μs
P_{GM}	$T_{VJ} = T_{VJM}$ $I_T = I_{TAVM}$	$t_p = 30 \mu s$ $t_p = 500 \mu s$	120 60	W W
P_{GAV} V_{RGM}			8 10	W V
T_{VJ} T_{VJM} T_{stg}			-40 ... 125 125 -40 ... 125	$^{\circ}C$ $^{\circ}C$ $^{\circ}C$
V_{ISOL}	50/60 Hz, RMS	t = 1 min	3000	V~
	$I_{ISOL} \leq 1 mA$	t = 1 s	3600	V~
M_d	Mounting torque (M6)	2.25-2.75/20-25		Nm/lb.in.
	Terminal connection torque (M6)	4.5-5.5/40-48		Nm/lb.in.
Weight	Typical including screws		125	g

MCC

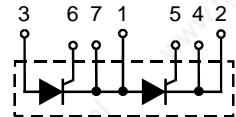

MCD

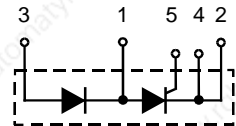

Features

- International standard package
- Direct Copper Bonded Al_2O_3 -ceramic base plate
- Planar passivated chips
- Isolation voltage 3600 V~
- UL registered, E 72873
- Keyed gate/cathode twin pins

Applications

- Motor control
- Power converter
- Heat and temperature control for industrial furnaces and chemical processes
- Lighting control
- Contactless switches

Advantages

- Space and weight savings
- Simple mounting
- Improved temperature and power cycling
- Reduced protection circuits

Data according to IEC 60747 and refer to a single thyristor/diode unless otherwise stated.
IXYS reserves the right to change limits, test conditions and dimensions

Symbol	Test Conditions	Characteristic Values	
I_{RRM}, I_{DRM}	$T_{VJ} = T_{VJM}; V_R = V_{RRM}$	40	mA
V_T	$I_T = 300 \text{ A}; T_{VJ} = 25^\circ\text{C}$	1.36	V
V_{T0}	For power-loss calculations only ($T_{VJ} = T_{VJM}$)	0.8	V
r_T		1.6	mΩ
V_{GT}	$V_D = 6 \text{ V}; T_{VJ} = 25^\circ\text{C}$	2	V
	$T_{VJ} = -40^\circ\text{C}$	2.6	V
I_{GT}	$V_D = 6 \text{ V}; T_{VJ} = 25^\circ\text{C}$	150	mA
	$T_{VJ} = -40^\circ\text{C}$	200	mA
V_{GD}	$T_{VJ} = T_{VJM}; V_D = 2/3 V_{DRM}$	0.25	V
I_{GD}	$T_{VJ} = T_{VJM}; V_D = 2/3 V_{DRM}$	10	mA
I_L	$T_{VJ} = 25^\circ\text{C}; V_D = 6 \text{ V}; t_p = 30 \mu\text{s}$ $di_G/dt = 0.45 \text{ A}/\mu\text{s}; I_G = 0.45 \text{ A}$	200	mA
I_H	$T_{VJ} = 25^\circ\text{C}; V_D = 6 \text{ V}; R_{GK} = \infty$	150	mA
t_{gd}	$T_{VJ} = 25^\circ\text{C}; V_D = 1/2 V_{DRM}$ $di_G/dt = 0.5 \text{ A}/\mu\text{s}; I_G = 0.5 \text{ A}$	2	μs
t_q	$T_{VJ} = T_{VJM}; V_R = 100 \text{ V}; V_D = 2/3 V_{DRM}; t_p = 200 \mu\text{s}$ typ. 150 $dv/dt = 20 \text{ V}/\mu\text{s}; I_T = 160 \text{ A}; -di/dt = 10 \text{ A}/\mu\text{s}$	150	μs
Q_S	$T_{VJ} = T_{VJM}$	550	μC
I_{RM}		235	A
R_{thJC}	per thyristor; DC current	0.155	K/W
	per module	0.078	K/W
R_{thJK}	per thyristor; DC current	0.225	K/W
	per module	0.113	K/W
d_s	Creeping distance on surface	12.7	mm
d_A	Creepage distance in air	9.6	mm
a	Maximum allowable acceleration	50	m/s ²

Optional accessories for modules

Keyed gate/cathode twin plugs with wire length = 350 mm, gate = yellow, cathode = red
 Type **ZY 180L** (L = Left for pin pair 4/5) } UL 758, style 1385,
 Type **ZY 180R** (R = right for pin pair 6/7) } CSA class 5851, guide 460-1-1

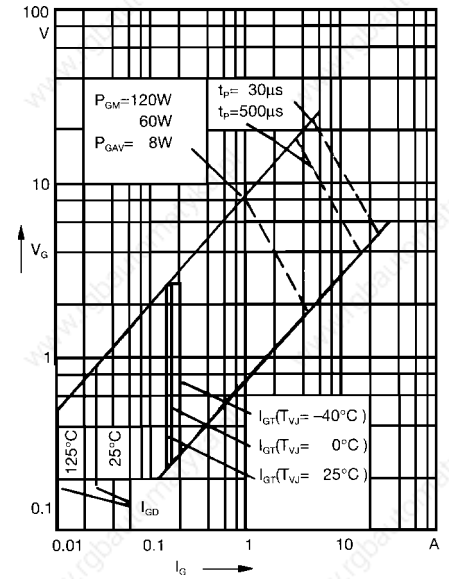

Fig. 1 Gate trigger characteristics

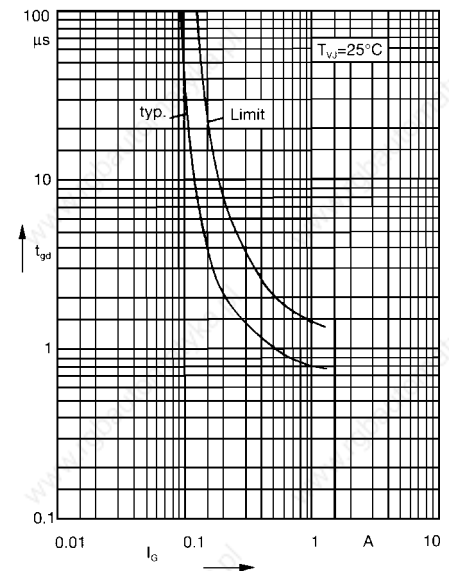
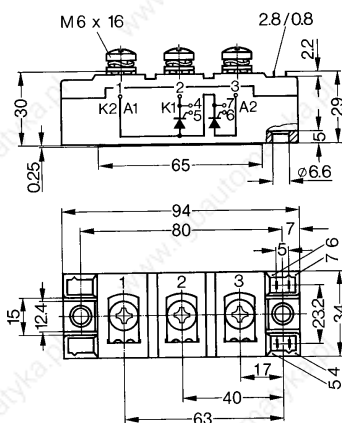

Fig. 2 Gate trigger delay time

Dimensions in mm (1 mm = 0.0394")



R_{thJC} for various conduction angles d:

d	R_{thJC} (K/W)
DC	0.155
180°	0.167
120°	0.175
60°	0.197
30°	0.226

Constants for Z_{thJC} calculation:

i	R_{thi} (K/W)	t_i (s)
1	0.0072	0.001
2	0.0188	0.08
3	0.129	0.2

R_{thJK} for various conduction angles d:

d	R_{thJK} (K/W)
DC	0.225
180°	0.237
120°	0.245
60°	0.262
30°	0.296

Constants for Z_{thJK} calculation:

i	R_{thi} (K/W)	t_i (s)
1	0.0072	0.001
2	0.0188	0.08
3	0.129	0.2
4	0.07	1.0

Thyristor Modules Thyristor/Diode Modules

$$I_{TRMS} = 2x 300 A$$

$$I_{TAVM} = 2x 190 A$$

$$V_{RRM} = 800-1800 V$$

V_{RSM}	V_{RRM}	Type	
V_{DSM}	V_{DRM}		
V	V	Version 1	Version 1
900	800	MCC 162-08io1	MCD 162-08io1
1300	1200	MCC 162-12io1	MCD 162-12io1
1500	1400	MCC 162-14io1	MCD 162-14io1
1700	1600	MCC 162-16io1	MCD 162-16io1
1900	1800	MCC 162-18io1	MCD 162-18io1

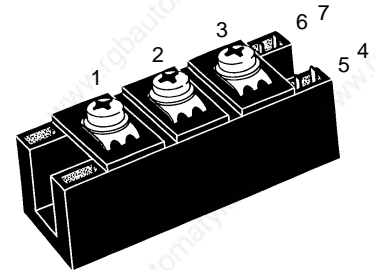

Symbol	Test Conditions	Maximum Ratings	
I_{TRMS}^* , I_{FRMS} I_{TAVM}^* , I_{FAVM}	$T_{VJ} = T_{VJM}$ $T_C = 80^\circ C$; 180° sine $T_C = 85^\circ C$; 180° sine	300 190 181	A A A
I_{TSM}^* , I_{FSM}	$T_{VJ} = 45^\circ C$; $V_R = 0$	$t = 10$ ms (50 Hz), sine $t = 8.3$ ms (60 Hz), sine	6000 6400 A A
	$T_{VJ} = T_{VJM}$ $V_R = 0$	$t = 10$ ms (50 Hz), sine $t = 8.3$ ms (60 Hz), sine	5250 5600 A A
$\int j^2 dt$	$T_{VJ} = 45^\circ C$ $V_R = 0$	$t = 10$ ms (50 Hz), sine $t = 8.3$ ms (60 Hz), sine	180 000 170 000 A ² s A ² s
	$T_{VJ} = T_{VJM}$ $V_R = 0$	$t = 10$ ms (50 Hz), sine $t = 8.3$ ms (60 Hz), sine	137 000 128 000 A ² s A ² s
$(di/dt)_{cr}$	$T_{VJ} = T_{VJM}$ $f = 50$ Hz, $t_p = 200$ μ s $V_D = 2/3 V_{DRM}$ $I_G = 0.5$ A $di_G/dt = 0.5$ A/ μ s	repetitive, $I_T = 500$ A non repetitive, $I_T = 500$ A	150 500 A/ μ s A/ μ s
$(dv/dt)_{cr}$	$T_{VJ} = T_{VJM}$; $R_{GK} = \infty$; method 1 (linear voltage rise)	$V_{DR} = 2/3 V_{DRM}$	1000 V/ μ s
P_{GM}	$T_{VJ} = T_{VJM}$ $I_T = I_{TAVM}$	$t_p = 30$ μ s $t_p = 500$ μ s	120 60 W W
P_{GAV}			8 W
V_{RGM}			10 V
T_{VJ}			-40...+125 $^\circ C$
T_{VJM}			125 $^\circ C$
T_{sig}			-40...+125 $^\circ C$
V_{ISOL}	50/60 Hz, RMS $I_{ISOL} \leq 1$ mA	$t = 1$ min $t = 1$ s	3000 3600 V~ V~
M_d	Mounting torque (M6) Terminal connection torque (M6)	2.25-2.75/20-25 4.5-5.5/40-48	Nm/lb.in. Nm/lb.in.
Weight	Typical including screws		125 g

MCC

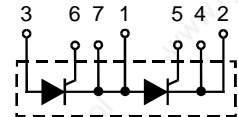

MCD

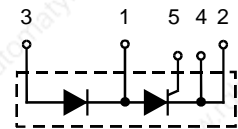

Features

- International standard package
- Direct copper bonded Al₂O₃ -ceramic base plate
- Planar passivated chips
- Isolation voltage 3600 V~
- UL registered, E 72873
- Keyed gate/cathode twin pins

Applications

- Motor control
- Power converter
- Heat and temperature control for industrial furnaces and chemical processes
- Lighting control
- Contactless switches

Advantages

- Space and weight savings
- Simple mounting
- Improved temperature and power cycling
- Reduced protection circuits

Data according to IEC 60747 and refer to a single thyristor/diode unless otherwise stated.
IXYS reserves the right to change limits, test conditions and dimensions

Symbol	Test Conditions	Characteristic Values
I_{RRM}, I_{DRM}	$T_{VJ} = T_{VJM}; V_R = V_{RRM}; V_D = V_{DRM}$	10 mA
V_T, V_F	$I_T, I_F = 300 \text{ A}; T_{VJ} = 25^\circ\text{C}$	1.25 V
V_{T0}	For power-loss calculations only ($T_{VJ} = 125^\circ\text{C}$)	0.88 V
r_T		1.15 mΩ
V_{GT}	$V_D = 6 \text{ V}; T_{VJ} = 25^\circ\text{C}$	2.5 V
	$T_{VJ} = -40^\circ\text{C}$	2.6 V
I_{GT}	$V_D = 6 \text{ V}; T_{VJ} = 25^\circ\text{C}$	150 mA
	$T_{VJ} = -40^\circ\text{C}$	200 mA
V_{GD}	$T_{VJ} = T_{VJM}; V_D = 2/3 V_{DRM}$	0.2 V
I_{GD}		10 mA
I_L	$T_{VJ} = 25^\circ\text{C}; t_p = 30 \mu\text{s}; V_D = 6 \text{ V}$ $I_G = 0.5 \text{ A}; di_g/dt = 0.5 \text{ A}/\mu\text{s}$	300 mA
I_H	$T_{VJ} = 25^\circ\text{C}; V_D = 6 \text{ V}; R_{GK} = \infty$	200 mA
t_{gd}	$T_{VJ} = 25^\circ\text{C}; V_D = 1/2 V_{DRM}$ $I_G = 0.5 \text{ A}; di_g/dt = 0.5 \text{ A}/\mu\text{s}$	2 μs
t_q	$T_{VJ} = T_{VJM}; I_T = 300 \text{ A}, t_p = 200 \mu\text{s}; -di/dt = 10 \text{ A}/\mu\text{s}$ typ. $V_R = 100 \text{ V}; dv/dt = 20 \text{ V}/\mu\text{s}; V_D = 2/3 V_{DRM}$	150 μs
Q_S	$T_{VJ} = T_{VJM}; I_T, I_F = 300 \text{ A}, -di/dt = 50 \text{ A}/\mu\text{s}$	550 μC
I_{RM}		235 A
R_{thJC}	per thyristor/diode; DC current per module	0.155 K/W
R_{thJK}	per thyristor/diode; DC current per module	0.0775 K/W
	other values see Fig. 8/9	0.225 K/W
		0.1125 K/W
d_s	Creepage distance on surface	12.7 mm
d_A	Strike distance through air	9.6 mm
a	Maximum allowable acceleration	50 m/s ²

Optional accessories for modules

Keyed gate/cathode twin plugs with wire length = 350 mm, gate = yellow, cathode = red

Type ZY 180L (L = Left for pin pair 4/5) } UL 758, style 1385,
Type ZY 180R (R = right for pin pair 6/7) } CSA class 5851, guide 460-1-1

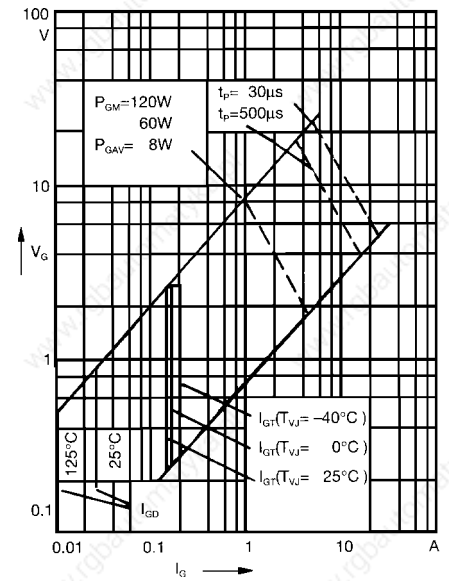

Fig. 1 Gate trigger characteristics

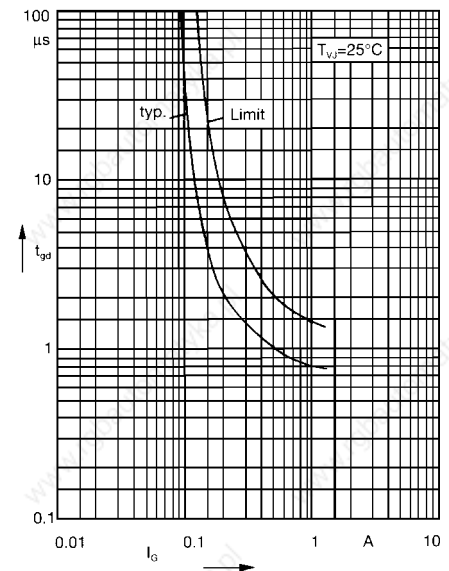
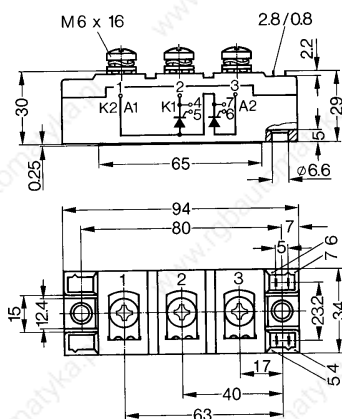

Fig. 2 Gate trigger delay time

Dimensions in mm (1 mm = 0.0394")

MCC Version 1



MCD Version 1

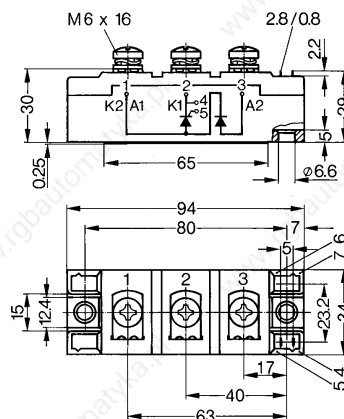

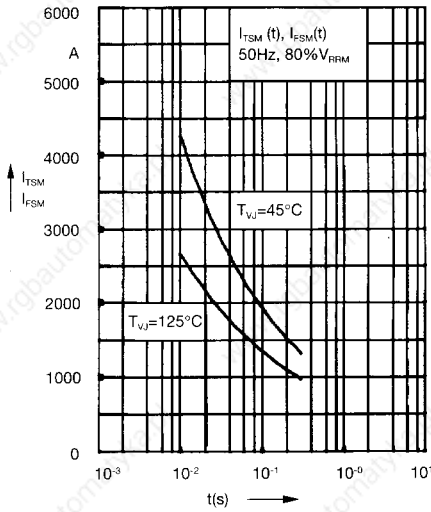

Fig. 3 Surge overload current

I_{TSM}, I_{FSM} : Crest value, t: duration

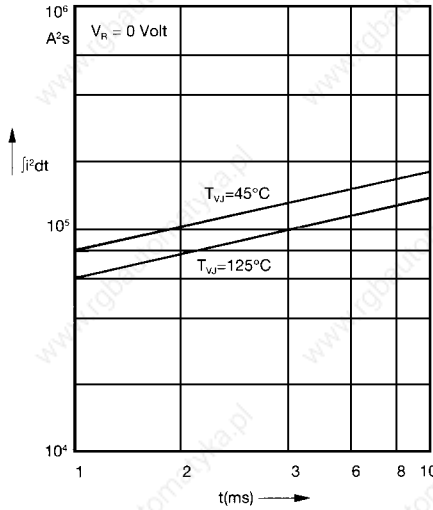

Fig. 4 j^2dt versus time (1-10 ms)

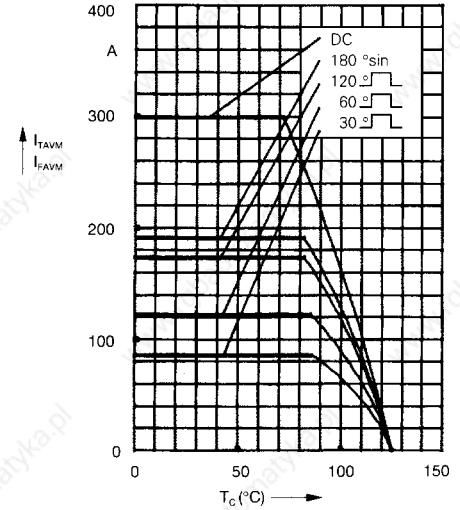

Fig. 4a Maximum forward current at case temperature

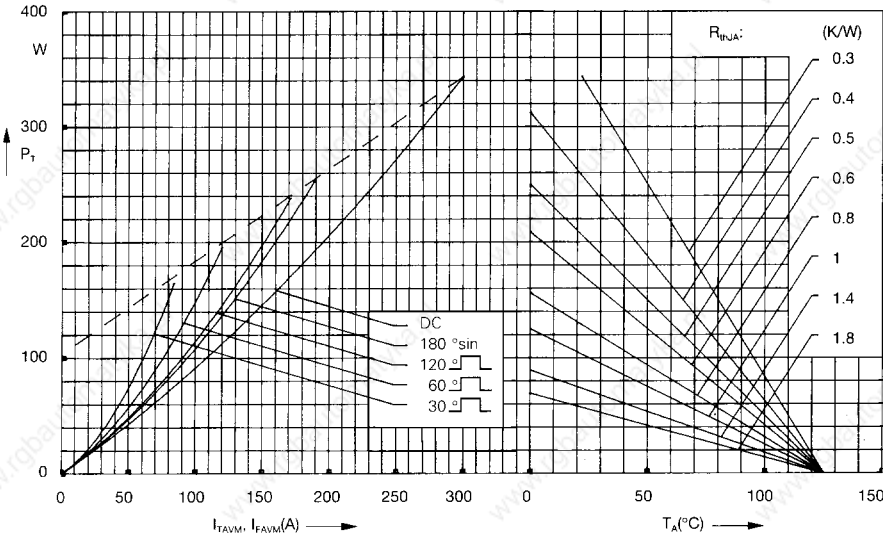

Fig. 5 Power dissipation versus on-state current and ambient temperature (per thyristor or diode)

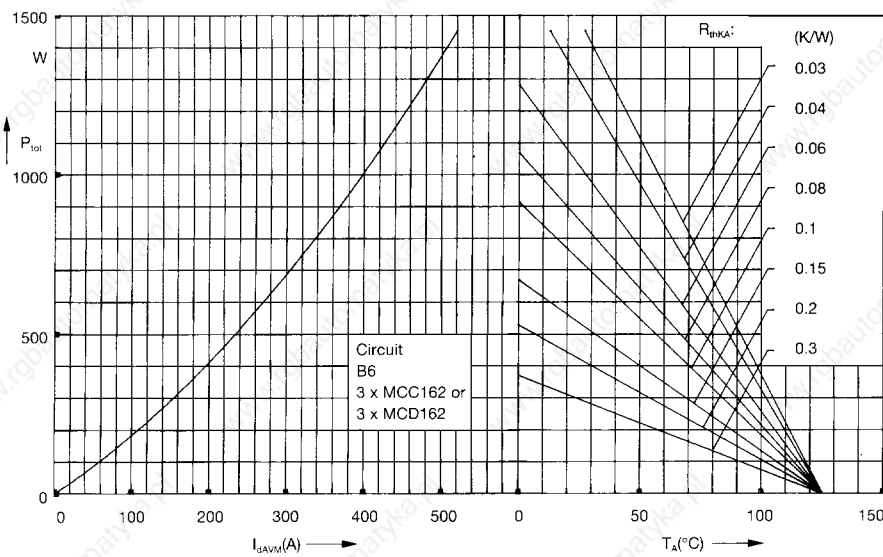

Fig. 6 Three phase rectifier bridge: Power dissipation versus direct output current and ambient temperature

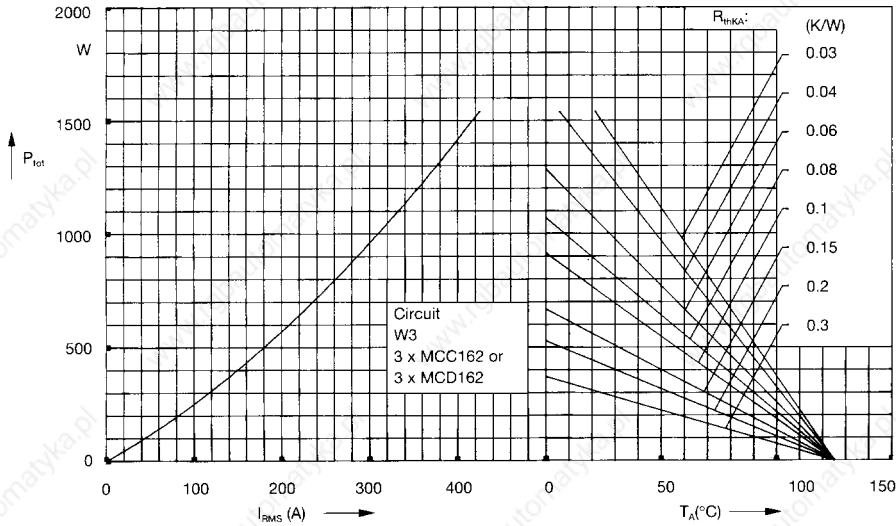

Fig. 7 Three phase AC-controller: Power dissipation versus RMS output current and ambient temperature

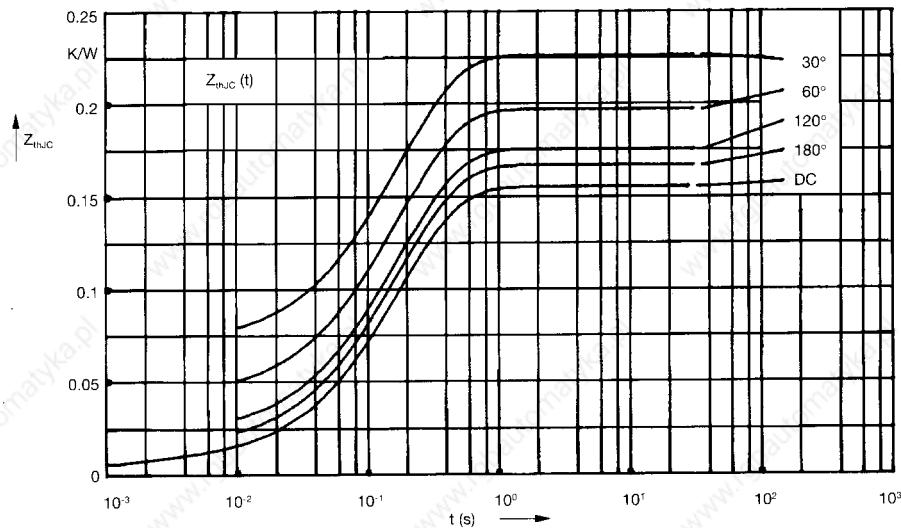

Fig. 8 Transient thermal impedance junction to case (per thyristor or diode)

R_{thJC} for various conduction angles d:

d	R_{thJC} (K/W)
DC	0.155
180°	0.167
120°	0.176
60°	0.197
30°	0.227

Constants for Z_{thJC} calculation:

i	R_{thi} (K/W)	t_i (s)
1	0.0072	0.001
2	0.0188	0.08
3	0.129	0.2

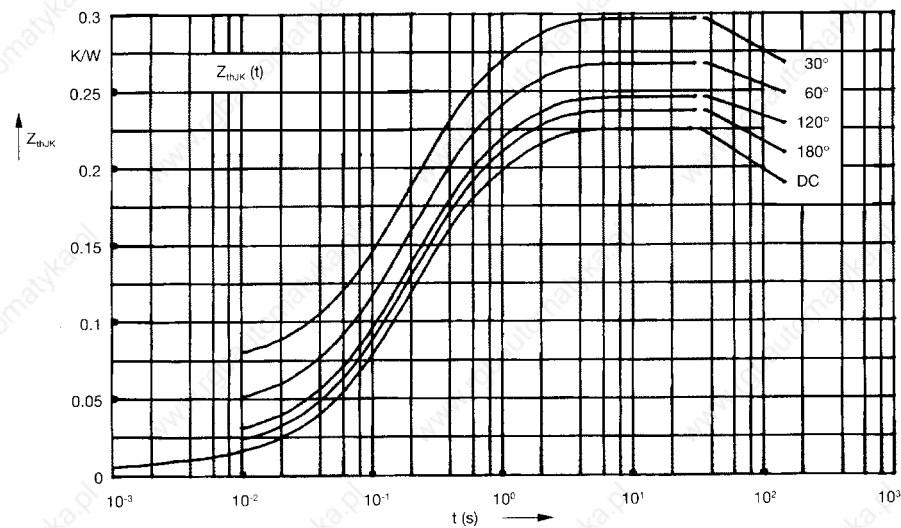

Fig. 9 Transient thermal impedance junction to heatsink (per thyristor or diode)

R_{thJK} for various conduction angles d:

d	R_{thJK} (K/W)
DC	0.225
180°	0.237
120°	0.246
60°	0.267
30°	0.297

Constants for Z_{thJK} calculation:

i	R_{thi} (K/W)	t_i (s)
1	0.0072	0.001
2	0.0188	0.08
3	0.129	0.2
4	0.07	1.0

Thyristor Modules Thyristor/Diode Modules

$I_{TRMS} = 2 \times 350 \text{ A}$
 $I_{TAVM} = 2 \times 203 \text{ A}$
 $V_{RRM} = 1200-1800 \text{ V}$

V_{RSM} V_{DSM} V	V_{RRM} V_{DRM} V	Type
1300	1200	MCC 170-12io1
1500	1400	MCC 170-14io1
1700	1600	MCC 170-16io1
1900	1800	MCC 170-18io1

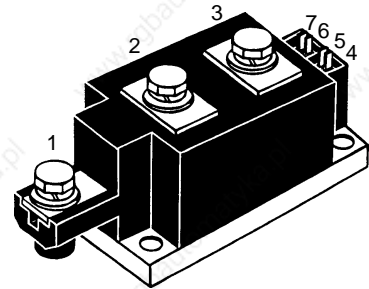
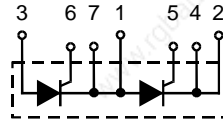

Symbol	Test Conditions	Maximum Ratings
I_{TRMS} I_{TAVM}	$T_{VJ} = T_{VJM}$ $T_C = 85^\circ\text{C}; 180^\circ \text{ sine}$	350 A 203 A
I_{TSM}, I_{FSM}	$T_{VJ} = 45^\circ\text{C};$ $V_R = 0$	$t = 10 \text{ ms (50 Hz)}$ 5400 A $t = 8.3 \text{ ms (60 Hz)}$ 5800 A
	$T_{VJ} = T_{VJM}$ $V_R = 0$	$t = 10 \text{ ms (50 Hz)}$ 5000 A $t = 8.3 \text{ ms (60 Hz)}$ 5500 A
$\int i^2 dt$	$T_{VJ} = 45^\circ\text{C}$ $V_R = 0$	$t = 10 \text{ ms (50 Hz)}$ 146 000 A ² s $t = 8.3 \text{ ms (60 Hz)}$ 140 000 A ² s
	$T_{VJ} = T_{VJM}$ $V_R = 0$	$t = 10 \text{ ms (50 Hz)}$ 125 000 A ² s $t = 8.3 \text{ ms (60 Hz)}$ 126 000 A ² s
$(di/dt)_{cr}$	$T_{VJ} = T_{VJM}$ $f = 50 \text{ Hz}, t_p = 200 \mu\text{s}$ $V_D = 2/3 V_{DRM}$ $I_G = 1 \text{ A},$ $di_G/dt = 1 \text{ A}/\mu\text{s}$	repetitive, $I_T = 660 \text{ A}$ 100 A/ μs non repetitive, $I_T = I_{TAVM}$ 500 A/ μs
$(dv/dt)_{cr}$	$T_{VJ} = T_{VJM}; V_{DR} = 2/3 V_{DRM}$ $R_{GK} = \infty; \text{method 1 (linear voltage rise)}$	1000 V/ μs
P_{GM}	$T_{VJ} = T_{VJM}$ $I_T = I_{TAVM}$	$t_p = 30 \mu\text{s}$ 120 W $t_p = 500 \mu\text{s}$ 60 W
P_{GAV} V_{RGM}		20 W 10 V
T_{VJ} T_{VJM} T_{stg}		-40...+130 °C 130 °C -40...+125 °C
V_{ISOL}	50/60 Hz, RMS $I_{ISOL} \leq 1 \text{ mA}$	$t = 1 \text{ min}$ 3000 V~ $t = 1 \text{ s}$ 3600 V~
M_d	Mounting torque (M6) Terminal connection torque (M8)	4.5-7/40-62 Nm/lb.in. 11-13/97-115 Nm/lb.in.
Weight	Typical including screws	750 g

Features

- International standard package
- Direct copper bonded Al_2O_3 -ceramic with copper base plate
- Planar passivated chips
- Isolation voltage 3600 V~
- UL registered E 72873
- Keyed gate/cathode twin pins

Applications

- Motor control, softstarter
- Power converter
- Heat and temperature control for industrial furnaces and chemical processes
- Lighting control
- Solid state switches

Advantages

- Simple mounting
- Improved temperature and power cycling
- Reduced protection circuits

Data according to IEC 60747 and refer to a single thyristor/diode unless otherwise stated.
 IXYS reserves the right to change limits, test conditions and dimensions

Symbol	Test Conditions	Characteristic Values
I_{RRM}, I_{DRM}	$T_{VJ} = T_{VJM}; V_R = V_{RRM}; V_D = V_{DRM}$	40 mA
V_{T1}, V_F	$I_T, I_F = 600 \text{ A}; T_{VJ} = 25^\circ\text{C}$	1.65 V
V_{T0}	For power-loss calculations only ($T_{VJ} = 130^\circ\text{C}$)	0.8 V
r_T		1 mΩ
V_{GT}	$V_D = 6 \text{ V}; T_{VJ} = 25^\circ\text{C}$	2 V
	$T_{VJ} = -40^\circ\text{C}$	3 V
I_{GT}	$V_D = 6 \text{ V}; T_{VJ} = 25^\circ\text{C}$	150 mA
	$T_{VJ} = -40^\circ\text{C}$	220 mA
V_{GD}	$T_{VJ} = T_{VJM}; V_D = 2/3 V_{DRM}$	0.25 V
I_{GD}	$T_{VJ} = T_{VJM}; V_D = 2/3 V_{DRM}$	10 mA
I_L	$T_{VJ} = 25^\circ\text{C}; t_p = 30 \mu\text{s}; V_D = 6 \text{ V}$ $I_G = 0.45 \text{ A}; di_G/dt = 0.45 \text{ A}/\mu\text{s}$	200 mA
I_H	$T_{VJ} = 25^\circ\text{C}; V_D = 6 \text{ V}; R_{GK} = \infty$	150 mA
t_{gd}	$T_{VJ} = 25^\circ\text{C}; V_D = 1/2 V_{DRM}$ $I_G = 1 \text{ A}; di_G/dt = 1 \text{ A}/\mu\text{s}$	2 μs
t_q	$T_{VJ} = T_{VJM}; I_T = 300 \text{ A}, t_p = 200 \mu\text{s}; -di/dt = 10 \text{ A}/\mu\text{s}$ $V_R = 100 \text{ V}; dv/dt = 50 \text{ V}/\mu\text{s}; V_D = 2/3 V_{DRM}$	typ. 200 μs
Q_S	$T_{VJ} = 125^\circ\text{C}; I_T, I_F = 300 \text{ A}; -di/dt = 50 \text{ A}/\mu\text{s}$	550 μC
I_{RM}		235 A
R_{thJC}	per thyristor (diode); DC current per module	0.164 K/W
R_{thJK}	per thyristor (diode); DC current per module	0.082 K/W
	other values see Fig. 8/9	0.204 K/W
		0.102 K/W
d_s	Creeping distance on surface	12.7 mm
d_a	Creepage distance in air	9.6 mm
a	Maximum allowable acceleration	50 m/s ²

Optional accessories for modules

Keyed Gate/Cathode twin plugs with wire length = 350 mm, gate = yellow, cathode = red

Type ZY 180 L (L = Left for pin pair 4/5) } UL 758, style 1385,
Type ZY 180 R (R = Right for pin pair 6/7) } CSA class 5851, guide 460-1-1

Dimensions in mm (1 mm = 0.0394")

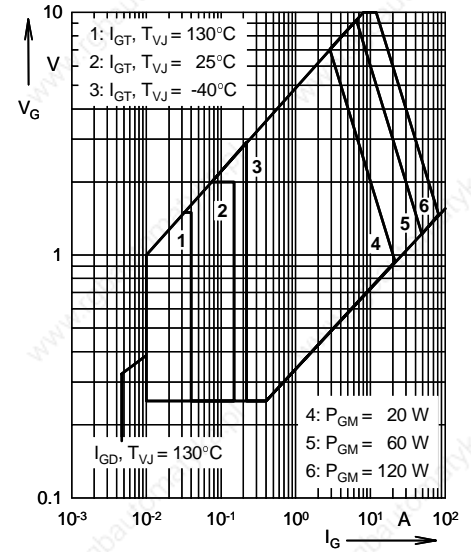
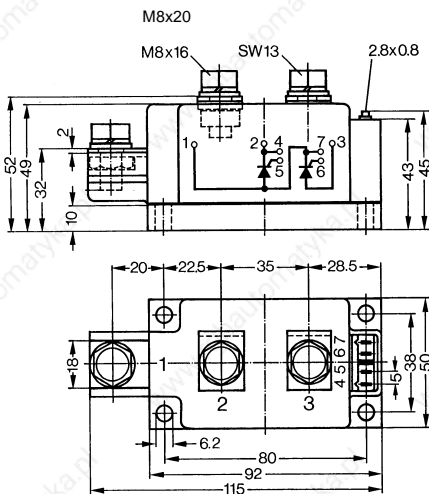

Fig. 1 Gate trigger characteristics

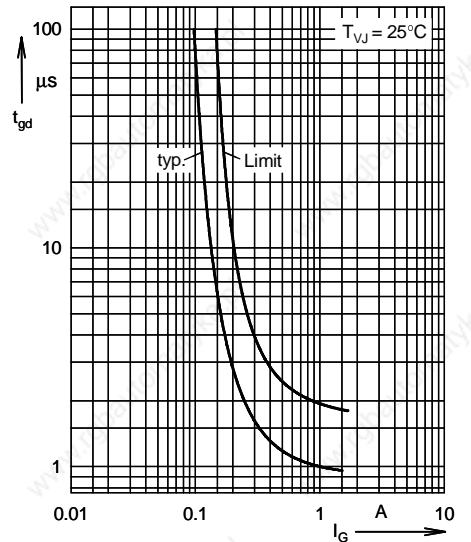

Fig. 2 Gate trigger delay time

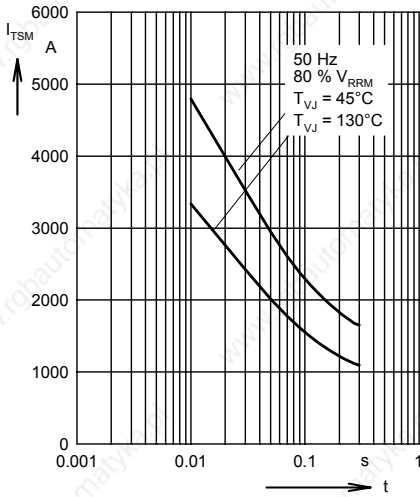

Fig. 3 Surge overload current
 I_{TSM} , I_{FSM} : Crest value, t : duration

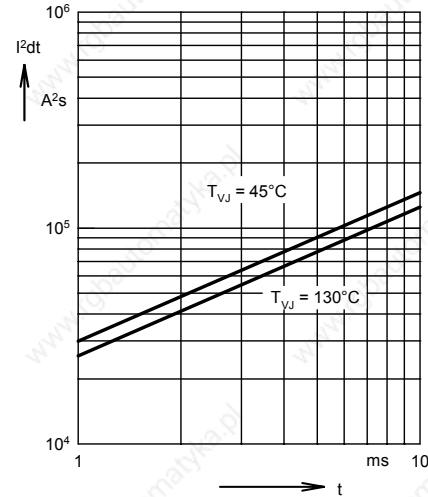

Fig. 4 $\int i^2 dt$ versus time (1-10 ms)

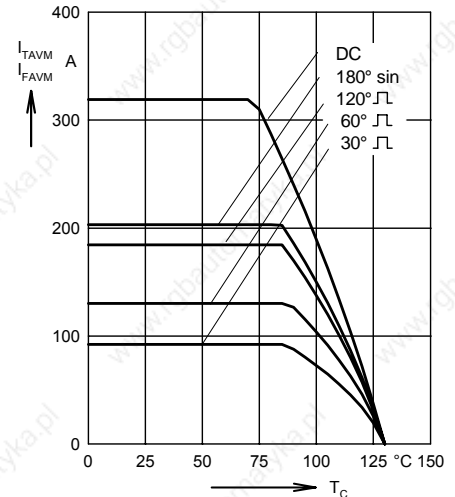

Fig. 4a Maximum forward current at case temperature

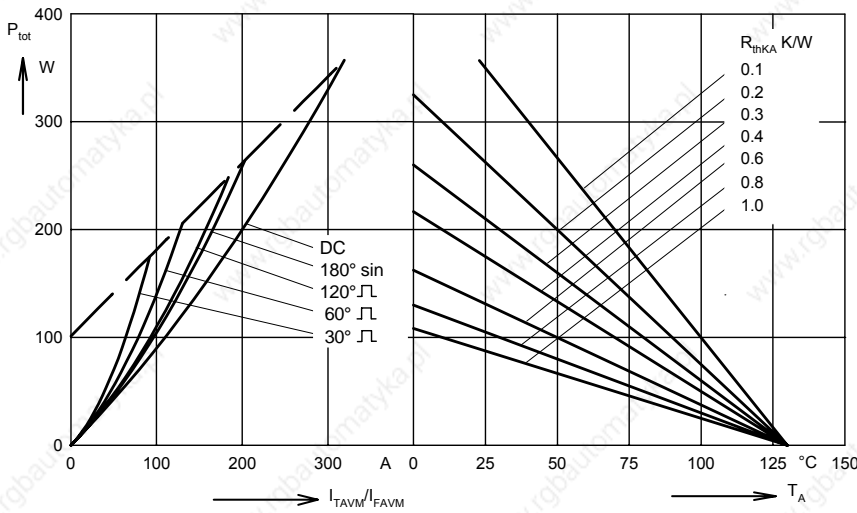

Fig. 5 Power dissipation versus on-state current and ambient temperature (per thyristor or diode)

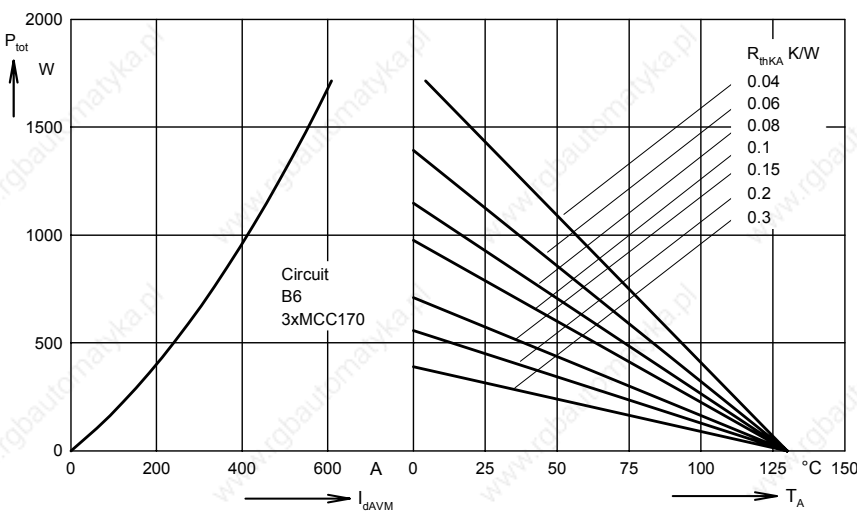

Fig. 6 Three phase rectifier bridge: Power dissipation versus direct output current and ambient temperature

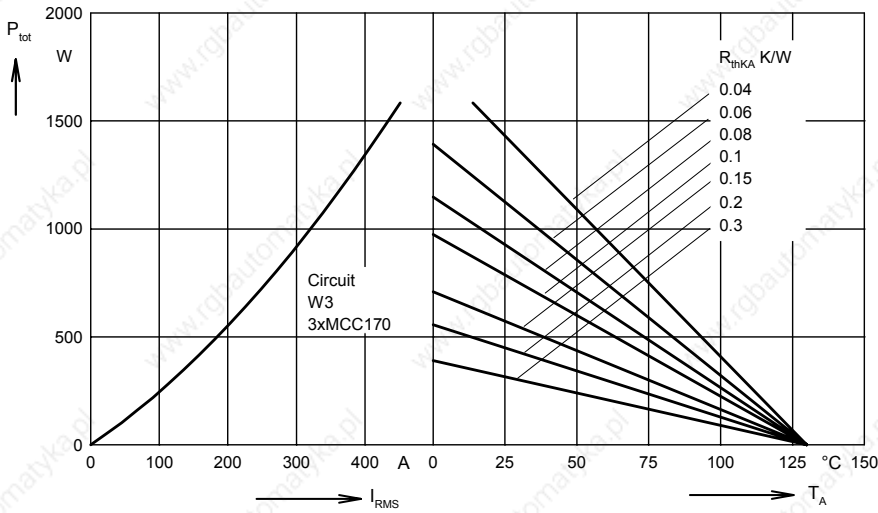

Fig. 7 Three phase AC-controller: Power dissipation versus RMS output current and ambient temperature

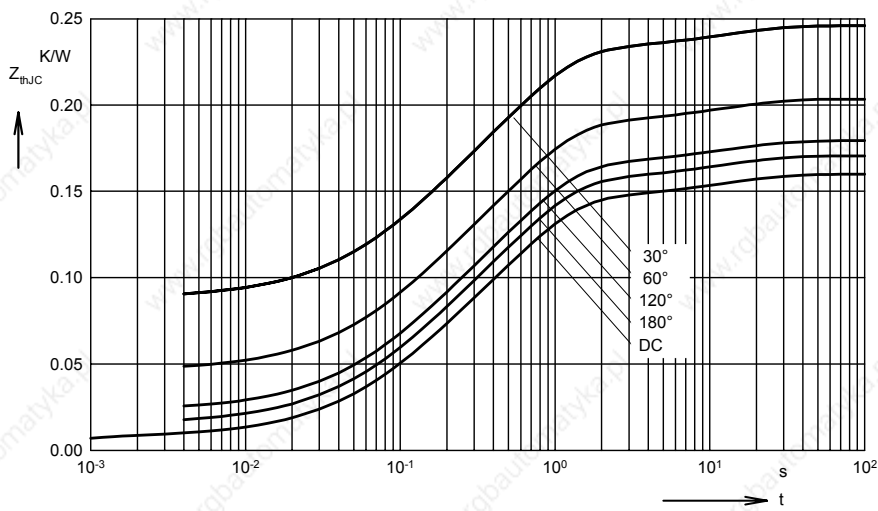

Fig. 8 Transient thermal impedance junction to case (per thyristor or diode)

R_{thJC} for various conduction angles d:

d	R_{thJC} (K/W)
DC	0.160
180°	0.171
120°	0.180
60°	0.203
30°	0.247

Constants for Z_{thJC} calculation:

i	R_{thi} (K/W)	t_i (s)
1	0.0077	0.00054
2	0.0413	0.098
3	0.096	0.54
4	0.0149	12

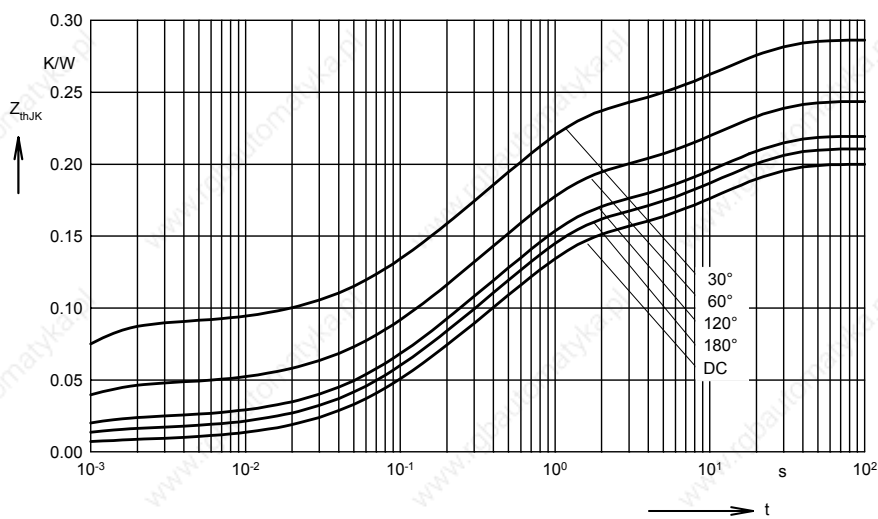

Fig. 9 Transient thermal impedance junction to heatsink (per thyristor or diode)

R_{thJK} for various conduction angles d:

d	R_{thJK} (K/W)
DC	0.200
180°	0.211
120°	0.220
60°	0.243
30°	0.287

Constants for Z_{thJK} calculation:

i	R_{thi} (K/W)	t_i (s)
1	0.0077	0.00054
2	0.0413	0.098
3	0.096	0.54
4	0.0149	12
5	0.04	12

Thyristor Modules Thyristor/Diode Modules

$$I_{TRMS} = 2 \times 400 \text{ A}$$

$$I_{TAVM} = 2 \times 250 \text{ A}$$

$$V_{RRM} = 800-1600 \text{ V}$$

V_{RSM} V_{DSM} V	V_{RRM} V_{DRM} V	Type	Version 1	Version 1
900	800	MCC 220-08io1	MCC 220-08io1	MCD 220-08io1
1300	1200	MCC 220-12io1	MCC 220-12io1	MCD 220-12io1
1500	1400	MCC 220-14io1	MCC 220-14io1	MCD 220-14io1
1700	1600	MCC 220-16io1	MCC 220-16io1	MCD 220-16io1

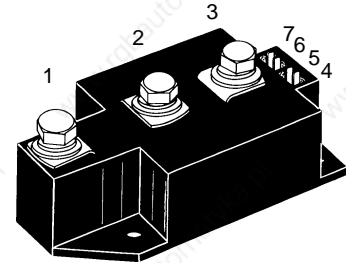

Symbol	Test Conditions	Maximum Ratings
I_{TRMS}^1 , I_{FRMS} I_{TAVM}^2 , I_{FAVM}	$T_{VJ} = T_{VJM}$ $T_C = 85^\circ\text{C}$; 180° sine	400 A 250 A
I_{TSM}^3 , I_{FSM}	$T_{VJ} = 45^\circ\text{C}$; $V_R = 0$	t = 10 ms (50 Hz), sine 8500 A t = 8.3 ms (60 Hz), sine 9000 A
	$T_{VJ} = T_{VJM}$ $V_R = 0$	t = 10 ms (50 Hz), sine 7000 A t = 8.3 ms (60 Hz), sine 7600 A
$\int i^2 dt$	$T_{VJ} = 45^\circ\text{C}$ $V_R = 0$	t = 10 ms (50 Hz), sine 360 000 A ² s t = 8.3 ms (60 Hz), sine 336 000 A ² s
	$T_{VJ} = T_{VJM}$ $V_R = 0$	t = 10 ms (50 Hz), sine 245 000 A ² s t = 8.3 ms (60 Hz), sine 240 000 A ² s
$(di/dt)_{cr}$	$T_{VJ} = T_{VJM}$ f = 50 Hz, t _p = 200 μs $V_D = 2/3 V_{DRM}$ $I_G = 1 \text{ A}$ di _G /dt = 1 A/μs	repetitive, I _T = 750 A 100 A/μs non repetitive, I _T = 250 A 800 A/μs
$(dv/dt)_{cr}$	$T_{VJ} = T_{VJM}$; R _{GK} = ∞; method 1 (linear voltage rise)	$V_{DR} = 2/3 V_{DRM}$ 1000 V/μs
P_{GM}	$T_{VJ} = T_{VJM}$ I _T = I _{TAVM}	t _p = 30 μs 120 W t _p = 500 μs 60 W
P_{GAV}		20 W
V_{RGM}		10 V
T_{VJ}		-40...+140 °C
T_{VJM}		140 °C
T_{stg}		-40...+125 °C
V_{ISOL}	50/60 Hz, RMS I _{ISOL} ≤ 1 mA	t = 1 min 3000 V~ t = 1 s 3600 V~
M_d	Mounting torque (M5) Terminal connection torque (M8)	2.5-5/22-44 Nm/lb.in. 12-15/106-132 Nm/lb.in.
Weight	Typical including screws	320 g

MCC

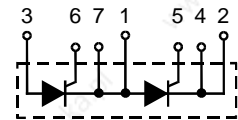

MCD

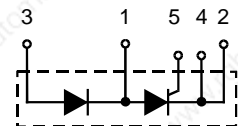

Features

- International standard package
- Direct copper bonded Al₂O₃ -ceramic base plate
- Planar passivated chips
- Isolation voltage 3600 V~
- UL registered, E 72873
- Keyed gate/cathode twin pins

Applications

- Motor control
- Power converter
- Heat and temperature control for industrial furnaces and chemical processes
- Lighting control
- Contactless switches

Advantages

- Space and weight savings
- Simple mounting
- Improved temperature and power cycling
- Reduced protection circuits

Data according to IEC 60747 and refer to a single thyristor/diode unless otherwise stated.
IXYS reserves the right to change limits, test conditions and dimensions

Symbol	Test Conditions	Characteristic Values
I_{RRM}	$T_{VJ} = T_{VJM}; V_R = V_{RRM}; V_D = V_{DRM}$	70 mA
I_{DRM}		40 mA
V_T, V_F	$I_T, I_F = 600 \text{ A}; T_{VJ} = 25^\circ\text{C}$	1.53 V
V_{T0}	For power-loss calculations only ($T_{VJ} = 140^\circ\text{C}$)	0.9 V
r_T		1.0 mΩ
V_{GT}	$V_D = 6 \text{ V}; T_{VJ} = 25^\circ\text{C}$	2 V
	$T_{VJ} = -40^\circ\text{C}$	3 V
I_{GT}	$V_D = 6 \text{ V}; T_{VJ} = 25^\circ\text{C}$	150 mA
	$T_{VJ} = -40^\circ\text{C}$	200 mA
V_{GD}	$T_{VJ} = T_{VJM}; V_D = 2/3 V_{DRM}$	0.25 V
I_{GD}		10 mA
I_L	$T_{VJ} = 25^\circ\text{C}; t_p = 30 \mu\text{s}; V_D = 6 \text{ V}$ $I_G = 0.45 \text{ A}; di_G/dt = 0.45 \text{ A}/\mu\text{s}$	200 mA
I_H	$T_{VJ} = 25^\circ\text{C}; V_D = 6 \text{ V}; R_{GK} = \infty$	150 mA
t_{gd}	$T_{VJ} = 25^\circ\text{C}; V_D = 1/2 V_{DRM}$ $I_G = 1 \text{ A}; di_G/dt = 1 \text{ A}/\mu\text{s}$	2 μs
t_q	$T_{VJ} = T_{VJM}; I_T = 300 \text{ A}, t_p = 200 \mu\text{s}; -di/dt = 10 \text{ A}/\mu\text{s}$ typ. $V_R = 100 \text{ V}; dv/dt = 50 \text{ V}/\mu\text{s}; V_D = 2/3 V_{DRM}$	200 μs
Q_S	$T_{VJ} = 125^\circ\text{C}; I_T, I_F = 400 \text{ A}, -di/dt = 50 \text{ A}/\mu\text{s}$	760 μC
I_{RM}		275 A
R_{thJC}	per thyristor/diode; DC current per module	0.139 K/W
R_{thJK}	per thyristor/diode; DC current per module	0.0695 K/W
	other values see Fig. 8/9	0.179 K/W
		0.0895 K/W
d_s	Creepage distance on surface	12.7 mm
d_A	Strike distance through air	9.6 mm
a	Maximum allowable acceleration	50 m/s ²

Optional accessories for modules

Keyed gate/cathode twin plugs with wire length = 350 mm, gate = yellow, cathode = red

Type ZY 180L (L = Left for pin pair 4/5) } UL 758, style 1385,
Type ZY 180R (R = right for pin pair 6/7) } CSA class 5851, guide 460-1-1

Dimensions in mm (1 mm = 0.0394")

MCC

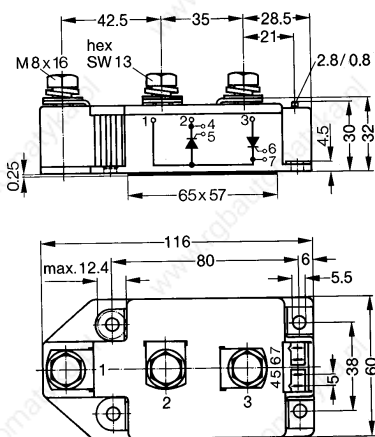

MCD

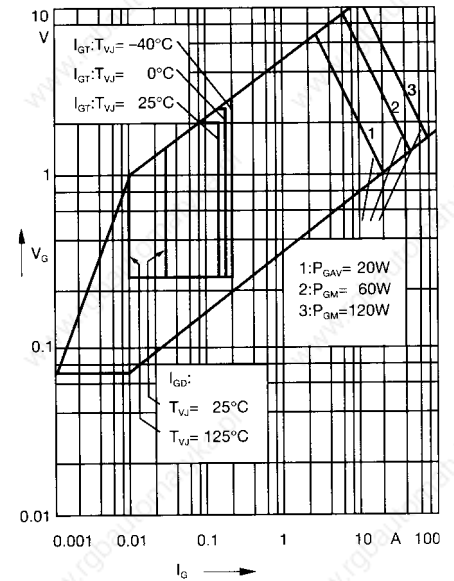
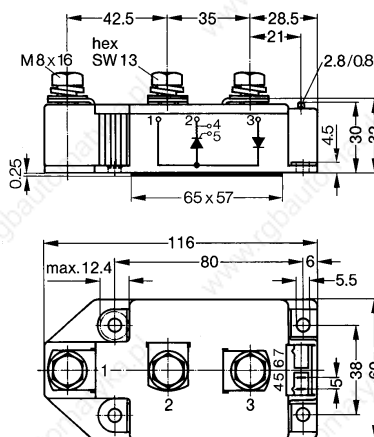

Fig. 1 Gate trigger characteristics

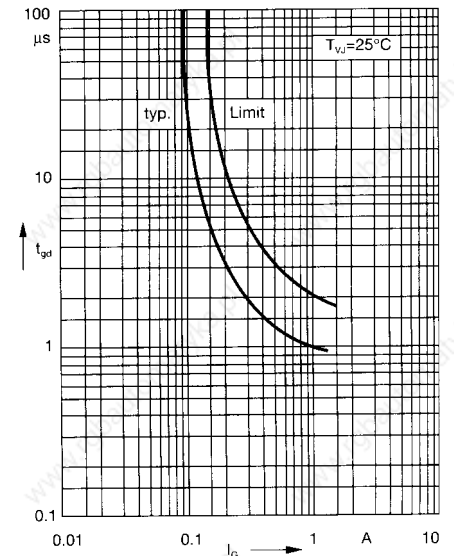
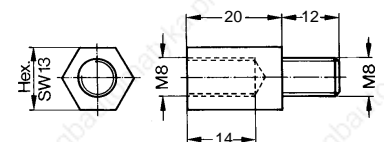

Fig. 2 Gate trigger delay time

Threaded spacer for higher Anode/Cathode construction:
Type ZY 250, material brass



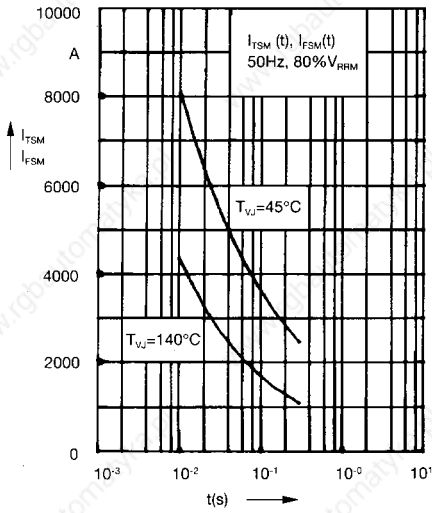

Fig. 3 Surge overload current
 I_{TSM}, I_{FSM} : Crest value, t : duration

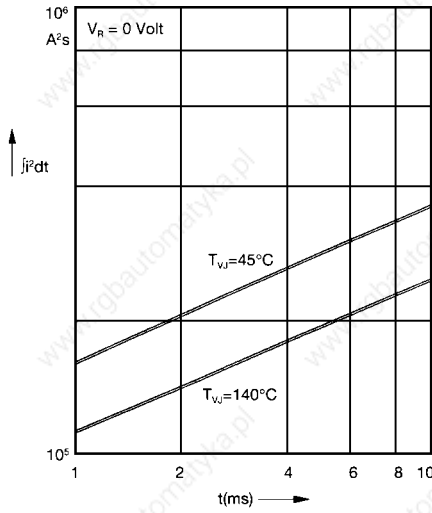

Fig. 4 $\int j^2 dt$ versus time (1-10 ms)

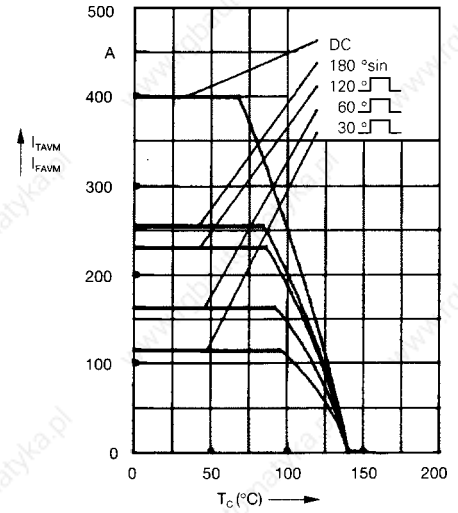

Fig. 4a Maximum forward current at case temperature

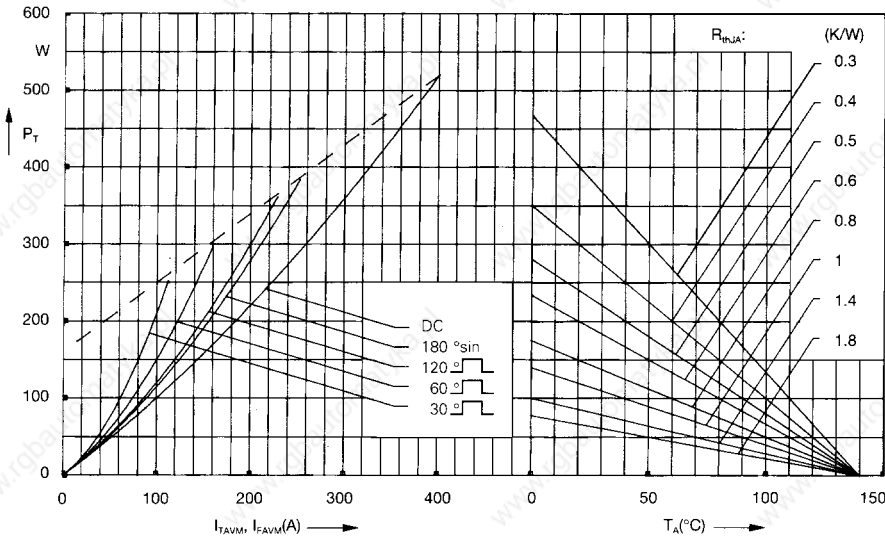

Fig. 5 Power dissipation versus on-state current and ambient temperature (per thyristor or diode)

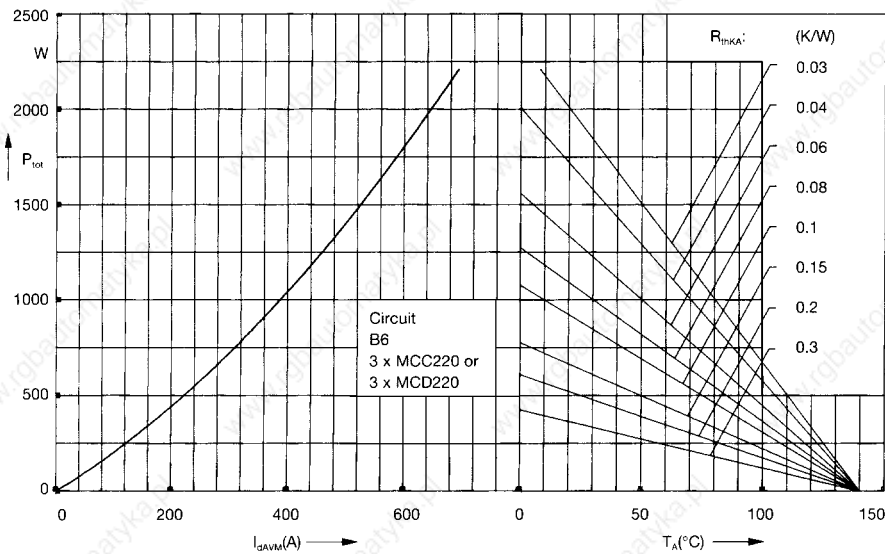

Fig. 6 Three phase rectifier bridge: Power dissipation versus direct output current and ambient temperature

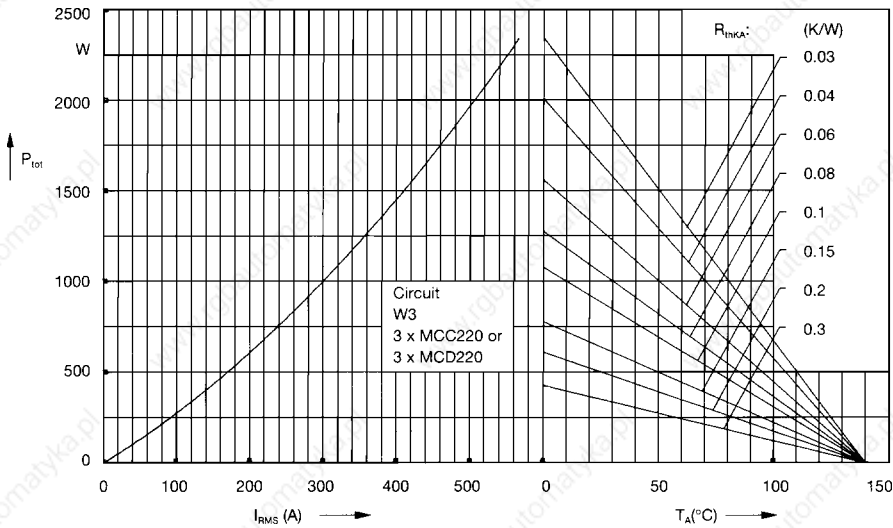

Fig. 7 Three phase AC-controller:
Power dissipation versus RMS
output current and ambient
temperature

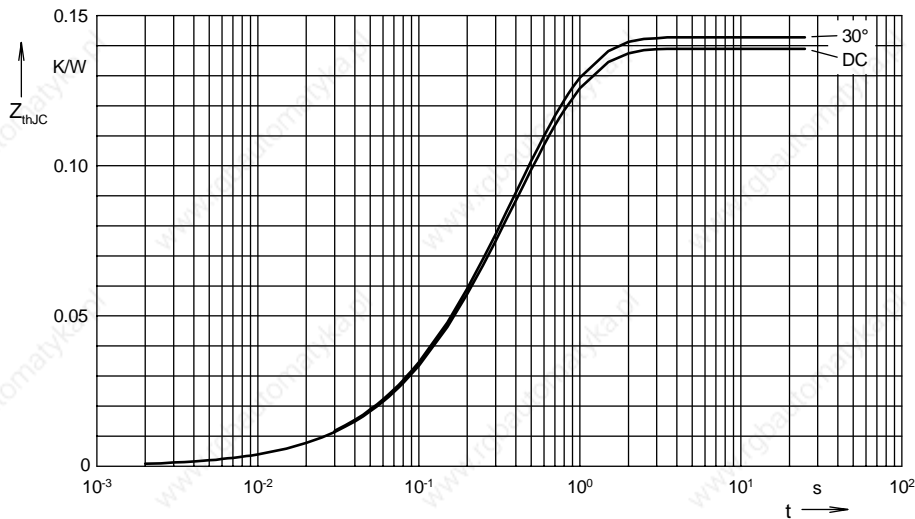

Fig. 8 Transient thermal impedance
junction to case (per thyristor or
diode)

R_{thJC} for various conduction angles d :

d	R_{thJC} (K/W)
DC	0.139
180°C	0.141
120°C	0.142
60°C	0.142
30°C	0.143

Constants for Z_{thJC} calculation:

i	R_{thi} (K/W)	t_i (s)
1	0.0037	0.0099
2	0.0177	0.168
3	0.1175	0.456

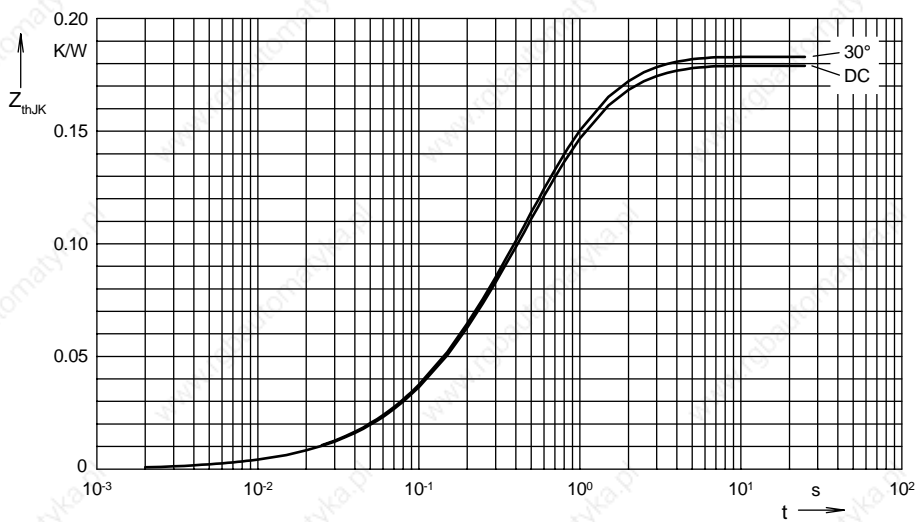

Fig. 9 Transient thermal impedance
junction to heatsink (per thyristor
or diode)

R_{thJK} for various conduction angles d :

d	R_{thJK} (K/W)
DC	0.179
180°C	0.181
120°C	0.182
60°C	0.183
30°C	0.183

Constants for Z_{thJK} calculation:

i	R_{thi} (K/W)	t_i (s)
1	0.0037	0.0099
2	0.0177	0.168
3	0.1175	0.456
4	0.04	1.36

Thyristor Modules Thyristor/Diode Modules

$I_{TRMS} = 2 \times 400 \text{ A}$
 $I_{TAVM} = 2 \times 240 \text{ A}$
 $V_{RRM} = 2000-2200 \text{ V}$

V_{RSM}	V_{RRM}	Type	
V_{DSM}	V_{DRM}		
V	V		
2100	2000	MCC 224-20io1	MCD 224-20io1
2300	2200	MCC 224-22io1	MCD 224-22io1

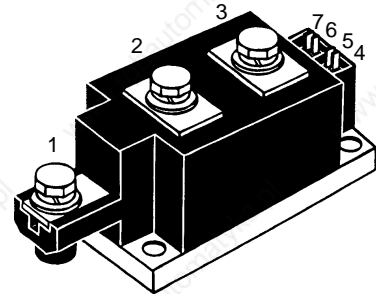

Symbol	Test Conditions	Maximum Ratings	
I_{TRMS}	$T_{VJ} = T_{VJM}$	400	A
I_{TAVM}	$T_C = 85^\circ\text{C}; 180^\circ \text{ sine}$	240	A
I_{TSM}	$T_{VJ} = 45^\circ\text{C};$ $V_R = 0$	$t = 10 \text{ ms (50 Hz)}$	A
		$t = 8.3 \text{ ms (60 Hz)}$	A
$\int i^2 dt$	$T_{VJ} = 45^\circ\text{C}$ $V_R = 0$	$t = 10 \text{ ms (50 Hz)}$	A^2s
		$t = 8.3 \text{ ms (60 Hz)}$	A^2s
$(di/dt)_{cr}$	$T_{VJ} = T_{VJM}$ $f = 50 \text{ Hz}, t_p = 200 \mu s$ $V_D = 2/3 V_{DRM}$ $I_G = 1 \text{ A}$ $di_G/dt = 1 \text{ A}/\mu s$	repetitive, $I_T = 750 \text{ A}$	100 $A/\mu s$
		non repetitive, $I_T = I_{TAVM}$	500 $A/\mu s$
$(dv/dt)_{cr}$	$T_{VJ} = T_{VJM}; V_{DR} = 2/3 V_{DRM}$ $R_{GK} = \infty; \text{method 1 (linear voltage rise)}$	1000	$V/\mu s$
P_{GM}	$T_{VJ} = T_{VJM}$ $I_T = I_{TAVM}$	$t_p = 30 \mu s$	120 W
		$t_p = 500 \mu s$	60 W
P_{GAV}			20 W
V_{RGM}			10 V
T_{VJ}		-40 ... 130	$^\circ\text{C}$
T_{VJM}		130	$^\circ\text{C}$
T_{sig}		-40 ... 125	$^\circ\text{C}$
V_{ISOL}	50/60 Hz, RMS $t = 1 \text{ min}$	3000	V_{\sim}
	$I_{ISOL} \leq 1 \text{ mA}$ $t = 1 \text{ s}$	3600	V_{\sim}
M_d	Mounting torque (M6)	4.5-7/40-62	Nm/lb.in.
	Terminal connection torque (M8)	11-13/97-115	Nm/lb.in.
Weight	Typical including screws	750	g

MCC

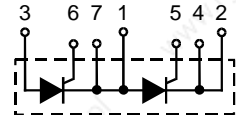

MCD

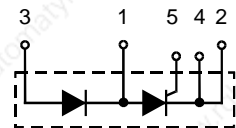

Features

- International standard package
- Direct Copper Bonded Al_2O_3 -ceramic with copper base plate
- Planar passivated chips
- Isolation voltage 3600 V~
- UL registered E 72873
- Keyed gate/cathode twin pins

Applications

- Motor control, softstarter
- Power converter
- Heat and temperature control for industrial furnaces and chemical processes
- Lighting control
- Solid state switches

Advantages

- Simple mounting
- Improved temperature and power cycling
- Reduced protection circuits

Data according to IEC 60747 and refer to a single thyristor/diode unless otherwise stated. IXYS reserves the right to change limits, test conditions and dimensions

Symbol	Test Conditions	Characteristic Values	
I_{RRM}, I_{DRM}	$T_{VJ} = T_{VJM}; V_R = V_{RRM}$	40	mA
V_T	$I_T = 600 \text{ A}; T_{VJ} = 25^\circ\text{C}$	1.4	V
V_{T0}	For power-loss calculations only ($T_{VJ} = T_{VJM}$)	0.8	V
r_T		0.76	m Ω
V_{GT}	$V_D = 6 \text{ V}; T_{VJ} = 25^\circ\text{C}$	2	V
	$T_{VJ} = -40^\circ\text{C}$	3	V
I_{GT}	$V_D = 6 \text{ V}; T_{VJ} = 25^\circ\text{C}$	150	mA
	$T_{VJ} = -40^\circ\text{C}$	220	mA
V_{GD}	$T_{VJ} = T_{VJM}; V_D = 2/3 V_{DRM}$	0.25	V
I_{GD}	$T_{VJ} = T_{VJM}; V_D = 2/3 V_{DRM}$	10	mA
I_L	$T_{VJ} = 25^\circ\text{C}; V_D = 6 \text{ V}; t_p = 30 \mu\text{s}$ $di_G/dt = 0.45 \text{ A}/\mu\text{s}; I_G = 0.45 \text{ A}$	200	mA
I_H	$T_{VJ} = 25^\circ\text{C}; V_D = 6 \text{ V}; R_{GK} = \infty$	150	mA
t_{gd}	$T_{VJ} = 25^\circ\text{C}; V_D = 1/2 V_{DRM}$ $di_G/dt = 1 \text{ A}/\mu\text{s}; I_G = 1 \text{ A}$	2	μs
t_q	$T_{VJ} = T_{VJM}; V_R = 100 \text{ V}; V_D = 2/3 V_{DRM}; t_p = 200 \mu\text{s}$ $dv/dt = 50 \text{ V}/\mu\text{s}; I_T = 300 \text{ A}; -di/dt = 10 \text{ A}/\mu\text{s}$	typ. 200	μs
Q_S	} $T_{VJ} = T_{VJM}$ } $-di/dt = 50 \text{ A}/\mu\text{s}; I_T = 400 \text{ A}$	760	μC
I_{RM}		275	A
R_{thJC}	per thyristor; DC current per module	0.139 0.069	K/W
R_{thJK}	per thyristor; DC current per module	0.179 0.089	K/W
d_s	Creeping distance on surface	12.7	mm
d_A	Creepage distance in air	9.6	mm
a	Maximum allowable acceleration	50	m/s ²

Optional accessories for modules

Keyed Gate/Cathode twin plugs with wire length = 350 mm, gate = yellow, cathode = red

Type ZY 180 L (L = Left for pin pair 4/5) } UL 758, style 1385,
Type ZY 180 R (R = Right for pin pair 6/7) } CSA class 5851, guide 460-1-1

Dimensions in mm (1 mm = 0.0394")

MCC

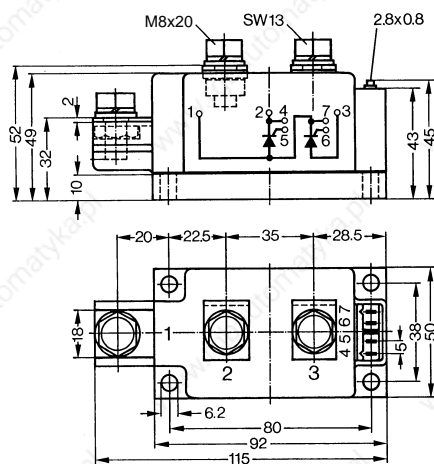

MCD

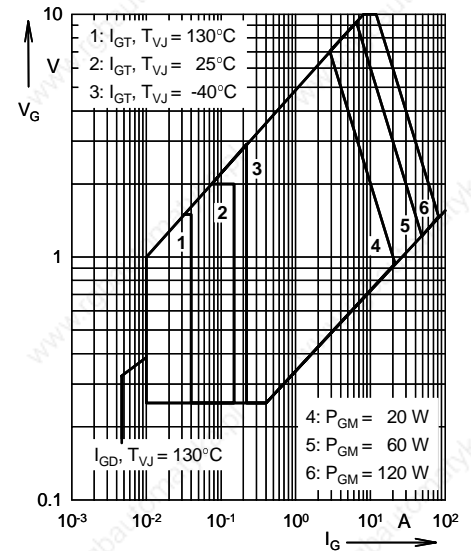
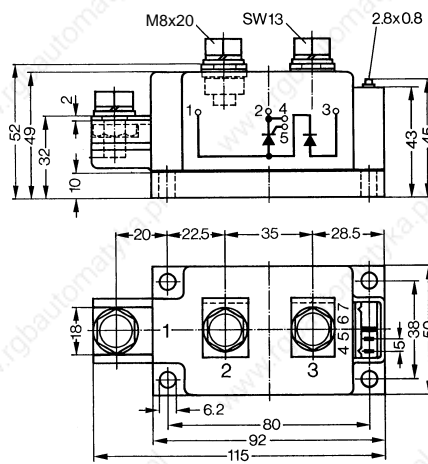

Fig. 1 Gate trigger characteristics

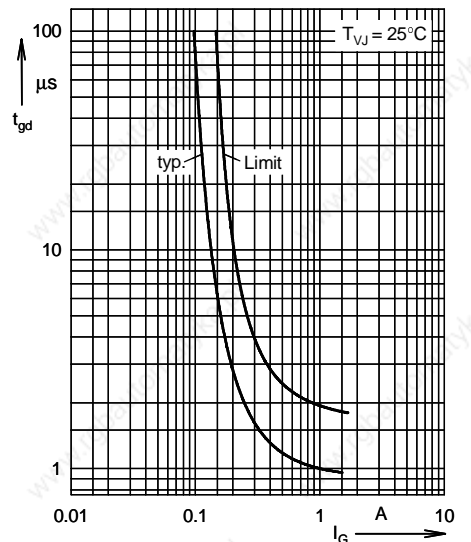

Fig. 2 Gate trigger delay time

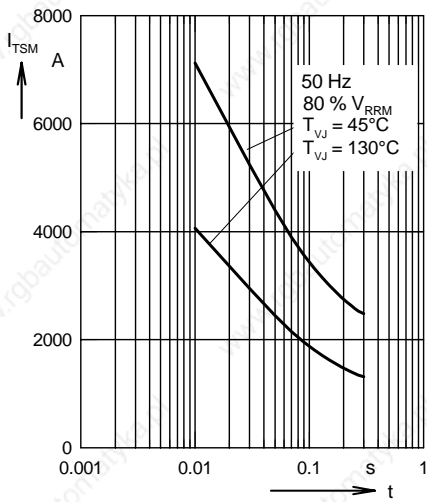

Fig. 3 Surge overload current
 I_{TSM} : Crest value, t : duration

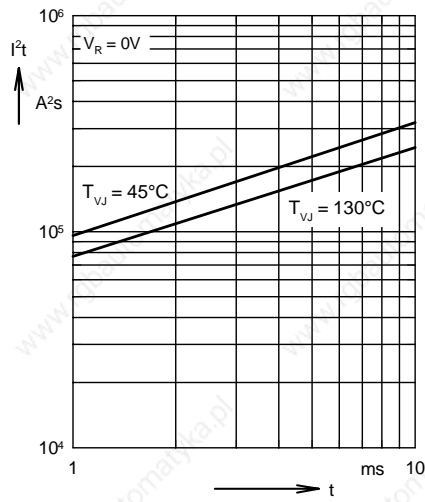

Fig. 4 I^2t versus time (1-10 ms)

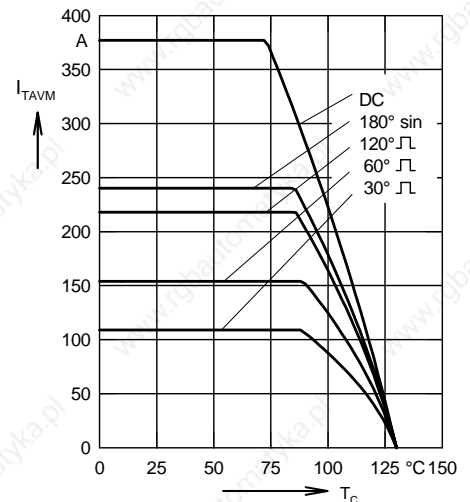

Fig. 4a Maximum forward current at case temperature

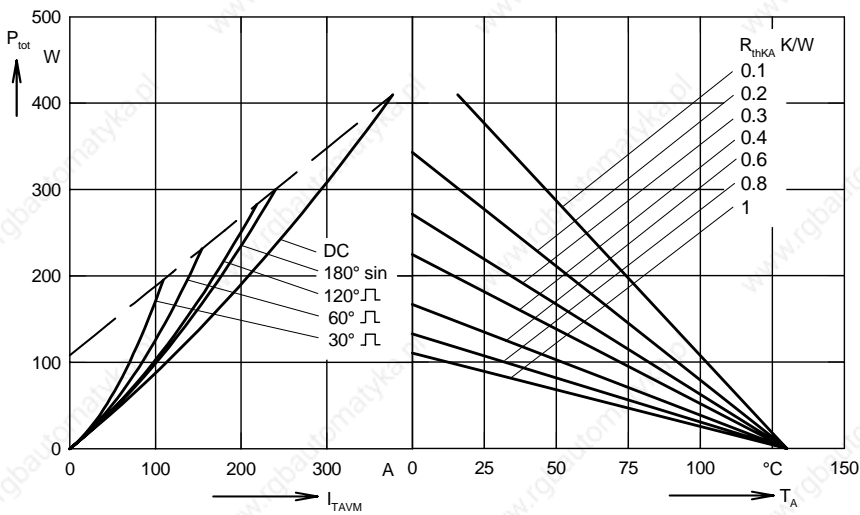

Fig. 5 Power dissipation versus on-state current and ambient temperature (per thyristor or diode)

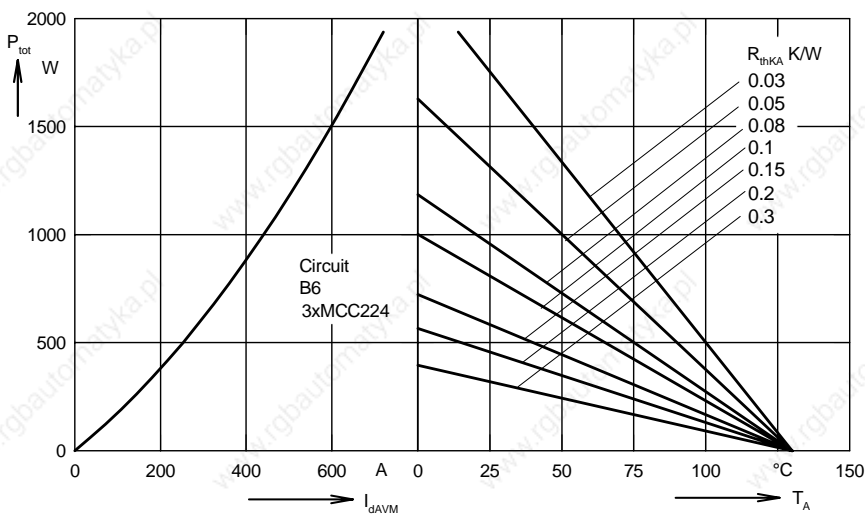

Fig. 6 Three phase rectifier bridge: Power dissipation versus direct output current and ambient temperature

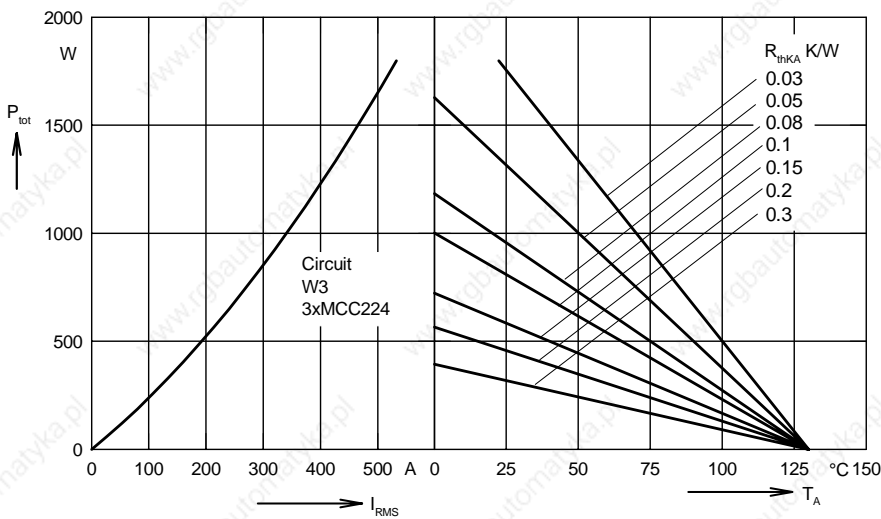

Fig. 7 Three phase AC-controller: Power dissipation versus RMS output current and ambient temperature

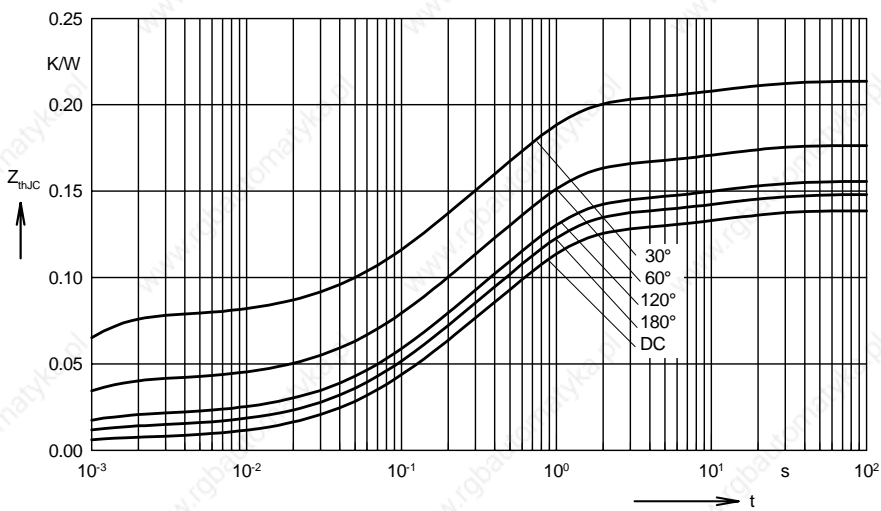

Fig. 8 Transient thermal impedance junction to case (per thyristor or diode)

R_{thJC} for various conduction angles d:

d	R_{thJC} (K/W)
DC	0.139
180°	0.148
120°	0.156
60°	0.176
30°	0.214

Constants for Z_{thJC} calculation:

i	R_{thi} (K/W)	t_i (s)
1	0.0067	0.00054
2	0.0358	0.098
3	0.0832	0.54
4	0.0129	12

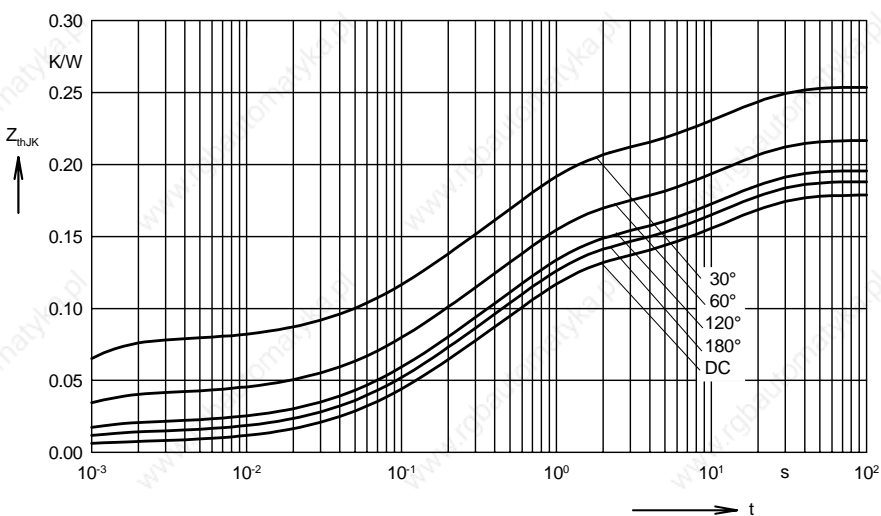

Fig. 9 Transient thermal impedance junction to heatsink (per thyristor or diode)

R_{thJK} for various conduction angles d:

d	R_{thJK} (K/W)
DC	0.179
180°	0.188
120°	0.196
60°	0.216
30°	0.256

Constants for Z_{thJK} calculation:

i	R_{thi} (K/W)	t_i (s)
1	0.0067	0.00054
2	0.0358	0.098
3	0.0832	0.54
4	0.0129	12
5	0.04	12

Thyristor Modules Thyristor/Diode Modules

$$I_{TRMS} = 2 \times 400 \text{ A}$$

$$I_{TAVM} = 2 \times 221 \text{ A}$$

$$V_{RRM} = 1200-1800 \text{ V}$$

V_{RSM}	V_{RRM}	Type	
V_{DSM}	V_{DRM}		
V	V		
1300	1200	MCC 225-12io1	MCD 225-12io1
1500	1400	MCC 225-14io1	MCD 225-14io1
1700	1600	MCC 225-16io1	MCD 225-16io1
1900	1800	MCC 225-18io1	MCD 225-18io1

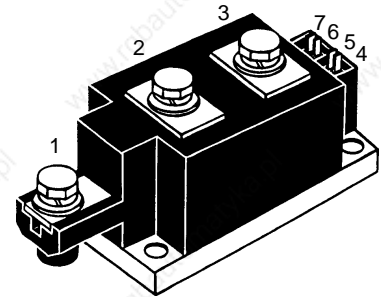

Symbol	Test Conditions	Maximum Ratings	
I_{TRMS}	$T_{VJ} = T_{VJM}$	400	A
I_{TAVM}	$T_C = 85^\circ\text{C}; 180^\circ \text{ sine}$	221	A
I_{TSM}^*, I_{FSM}	$T_{VJ} = 45^\circ\text{C};$ $V_R = 0$	$t = 10 \text{ ms (50 Hz)}$	8000 A
		$t = 8.3 \text{ ms (60 Hz)}$	8500 A
	$T_{VJ} = T_{VJM}$ $V_R = 0$	$t = 10 \text{ ms (50 Hz)}$	7000 A
		$t = 8.3 \text{ ms (60 Hz)}$	7700 A
$\int i^2 dt$	$T_{VJ} = 45^\circ\text{C}$ $V_R = 0$	$t = 10 \text{ ms (50 Hz)}$	320 000 A ² s
		$t = 8.3 \text{ ms (60 Hz)}$	300 000 A ² s
$(di/dt)_{cr}$	$T_{VJ} = T_{VJM}$ $V_R = 0$	$t = 10 \text{ ms (50 Hz)}$	245 000 A ² s
		$t = 8.3 \text{ ms (60 Hz)}$	246 000 A ² s
$(di/dt)_{cr}$	$T_{VJ} = T_{VJM}$ $f = 50 \text{ Hz}, t_p = 200 \mu\text{s}$ $V_D = 2/3 V_{DRM}$ $I_G = 1 \text{ A},$ $di_G/dt = 1 \text{ A}/\mu\text{s}$	repetitive, $I_T = 750 \text{ A}$	100 A/ μs
		non repetitive, $I_T = I_{TAVM}$	500 A/ μs
$(dv/dt)_{cr}$	$T_{VJ} = T_{VJM}; V_{DR} = 2/3 V_{DRM}$ $R_{GK} = \infty; \text{method 1 (linear voltage rise)}$	1000	V/ μs
P_{GM}	$T_{VJ} = T_{VJM}$ $I_T = I_{TAVM}$	$t_p = 30 \mu\text{s}$	120 W
		$t_p = 500 \mu\text{s}$	60 W
P_{GAV}		20	W
V_{RGM}		10	V
T_{VJ}		-40...+130	°C
T_{VJM}		130	°C
T_{stg}		-40...+125	°C
V_{ISOL}	50/60 Hz, RMS $I_{ISOL} \leq 1 \text{ mA}$	$t = 1 \text{ min}$	3000 V~
		$t = 1 \text{ s}$	3600 V~
M_d	Mounting torque (M6)	4.5-7/40-62	Nm/lb.in.
	Terminal connection torque (M8)	11-13/97-115	Nm/lb.in.
Weight	Typical including screws	750	g

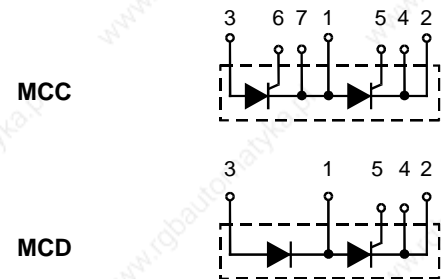

Features

- International standard package
- Direct copper bonded Al₂O₃-ceramic with copper base plate
- Planar passivated chips
- Isolation voltage 3600 V~
- UL registered E 72873
- Keyed gate/cathode twin pins

Applications

- Motor control, softstarter
- Power converter
- Heat and temperature control for industrial furnaces and chemical processes
- Lighting control
- Solid state switches

Advantages

- Simple mounting
- Improved temperature and power cycling
- Reduced protection circuits

Data according to IEC 60747 and refer to a single thyristor/diode unless otherwise stated. IXYS reserves the right to change limits, test conditions and dimensions

Symbol	Test Conditions	Characteristic Values
I_{RRM}, I_{DRM}	$T_{VJ} = T_{VJM}; V_R = V_{RRM}; V_D = V_{DRM}$	40 mA
V_T, V_F	$I_T, I_F = 600 \text{ A}; T_{VJ} = 25^\circ\text{C}$	1.40 V
V_{T0}	For power-loss calculations only ($T_{VJ} = 130^\circ\text{C}$)	0.8 V
r_T		0.76 mΩ
V_{GT}	$V_D = 6 \text{ V}; T_{VJ} = 25^\circ\text{C}$	2 V
	$T_{VJ} = -40^\circ\text{C}$	3 V
I_{GT}	$V_D = 6 \text{ V}; T_{VJ} = 25^\circ\text{C}$	150 mA
	$T_{VJ} = -40^\circ\text{C}$	220 mA
V_{GD}	$T_{VJ} = T_{VJM}; V_D = 2/3 V_{DRM}$	0.25 V
I_{GD}	$T_{VJ} = T_{VJM}; V_D = 2/3 V_{DRM}$	10 mA
I_L	$T_{VJ} = 25^\circ\text{C}; t_p = 30 \mu\text{s}; V_D = 6 \text{ V}$ $I_G = 0.45 \text{ A}; di_G/dt = 0.45 \text{ A}/\mu\text{s}$	200 mA
I_H	$T_{VJ} = 25^\circ\text{C}; V_D = 6 \text{ V}; R_{GK} = \infty$	150 mA
t_{gd}	$T_{VJ} = 25^\circ\text{C}; V_D = 1/2 V_{DRM}$ $I_G = 1 \text{ A}; di_G/dt = 1 \text{ A}/\mu\text{s}$	2 μs
t_q	$T_{VJ} = T_{VJM}; I_T = 300 \text{ A}, t_p = 200 \mu\text{s}; -di/dt = 10 \text{ A}/\mu\text{s}$ $V_R = 100 \text{ V}; dv/dt = 50 \text{ V}/\mu\text{s}; V_D = 2/3 V_{DRM}$	typ. 200 μs
Q_S	$T_{VJ} = 125^\circ\text{C}; I_T, I_F = 300 \text{ A}; -di/dt = 50 \text{ A}/\mu\text{s}$	550 μC
I_{RM}		235 A
R_{thJC}	per thyristor (diode); DC current per module	0.157 K/W
R_{thJK}	per thyristor (diode); DC current per module	0.08 K/W
	other values see Fig. 8/9	0.197 K/W
		0.1 K/W
d_s	Creeping distance on surface	12.7 mm
d_a	Creepage distance in air	9.6 mm
a	Maximum allowable acceleration	50 m/s ²

Optional accessories for modules

Keyed Gate/Cathode twin plugs with wire length = 350 mm, gate = yellow, cathode = red

Type ZY 180 L (L = Left for pin pair 4/5) } UL 758, style 1385,
Type ZY 180 R (R = Right for pin pair 6/7) } CSA class 5851, guide 460-1-1

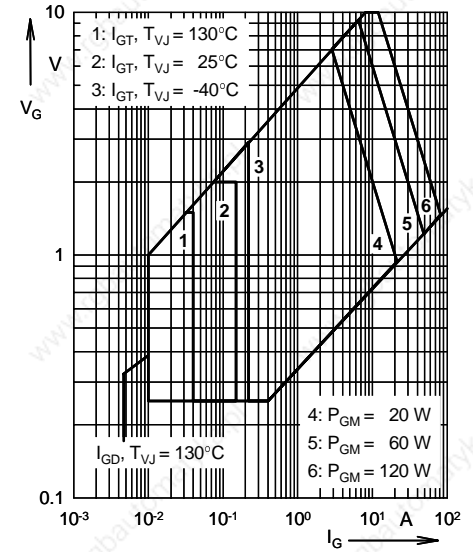

Fig. 1 Gate trigger characteristics

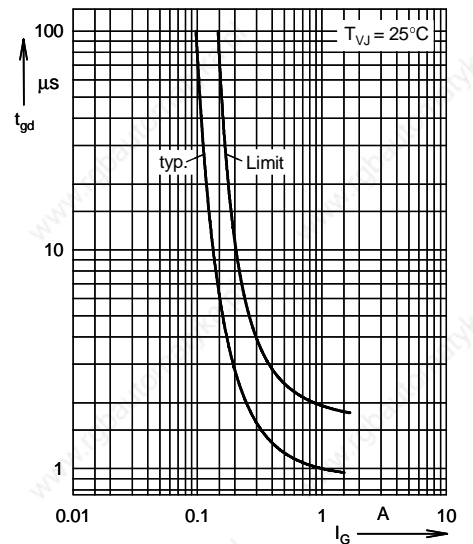
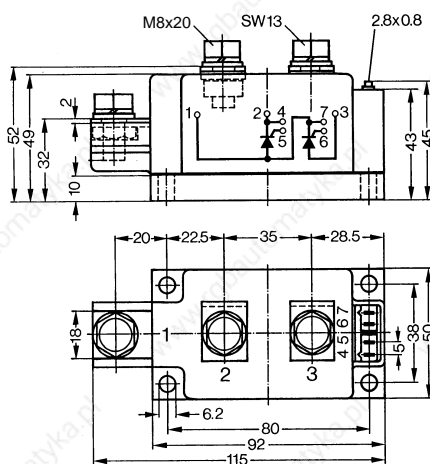

Fig. 2 Gate trigger delay time

Dimensions in mm (1 mm = 0.0394")

MCC



MCD

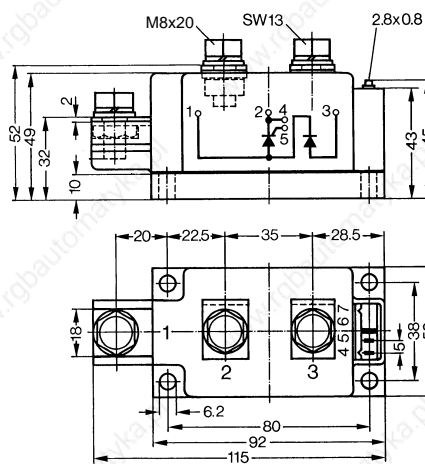

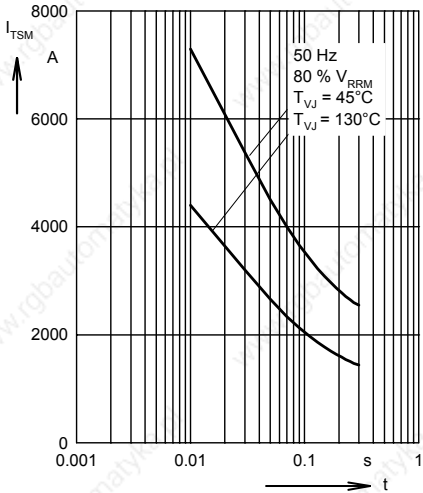

Fig. 3 Surge overload current
 I_{TSM} , I_{FSM} : Crest value, t : duration

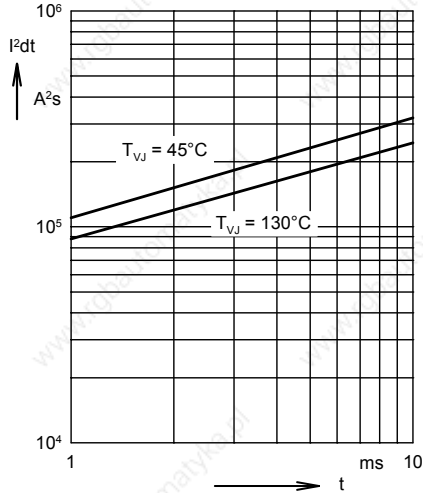

Fig. 4 $\int i^2 dt$ versus time (1-10 ms)

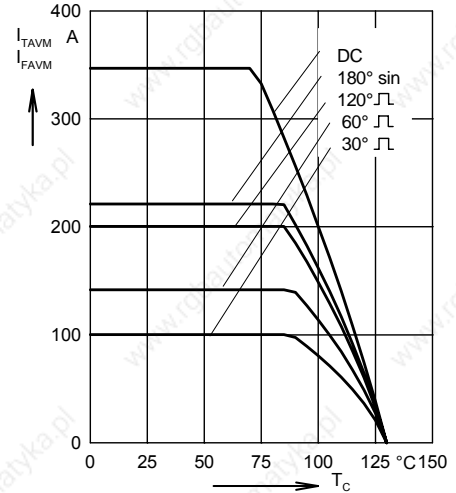

Fig. 4a Maximum forward current at case temperature

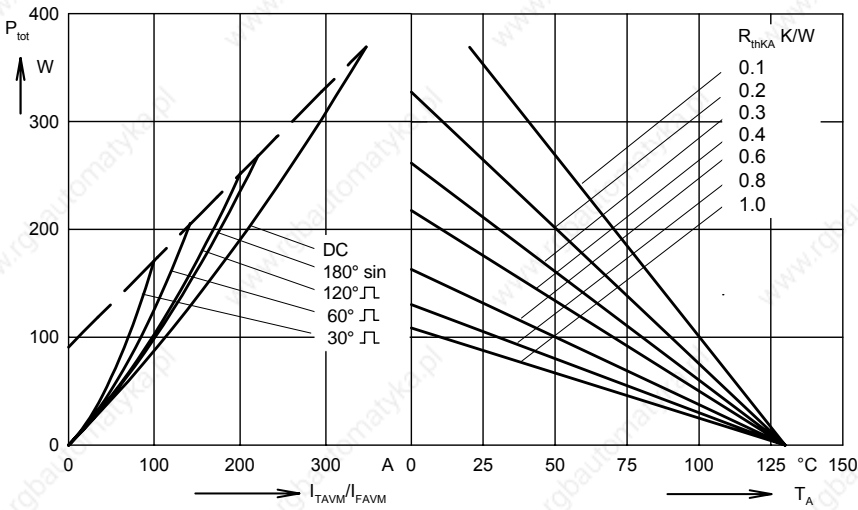

Fig. 5 Power dissipation versus on-state current and ambient temperature (per thyristor or diode)

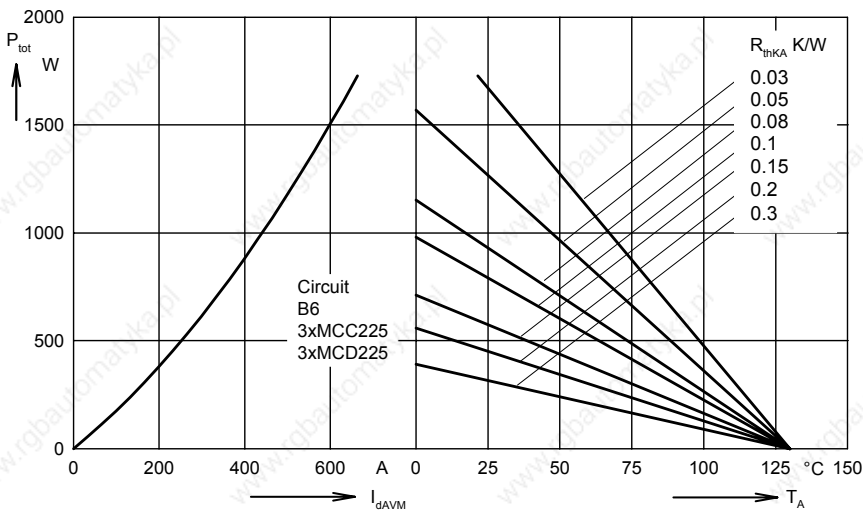

Fig. 6 Three phase rectifier bridge: Power dissipation versus direct output current and ambient temperature

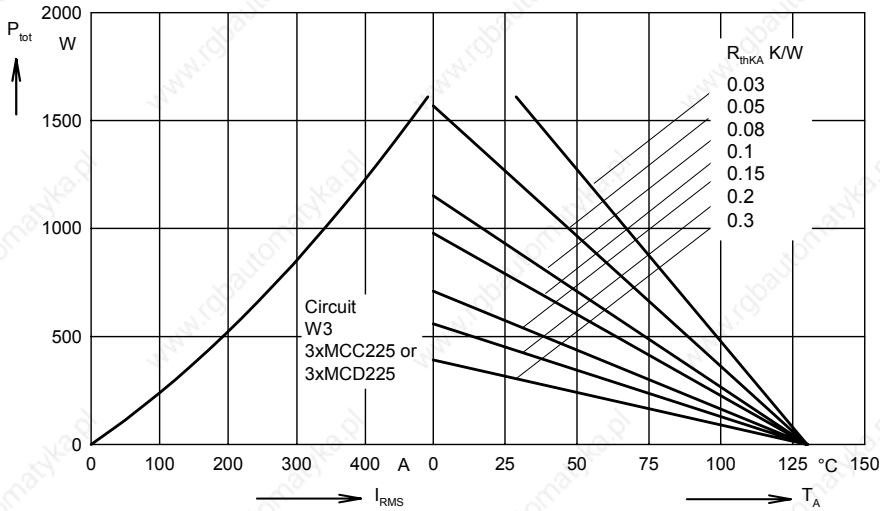

Fig. 7 Three phase AC-controller:
Power dissipation versus RMS
output current and ambient
temperature

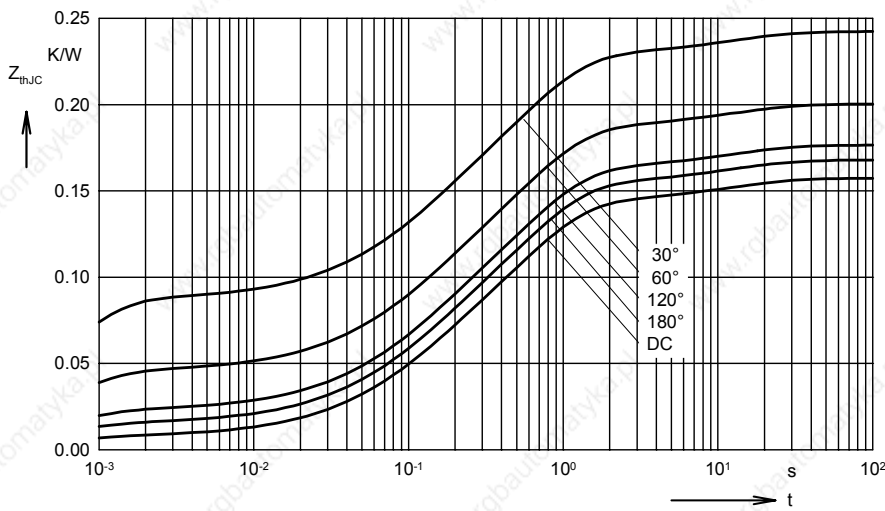

Fig. 8 Transient thermal impedance
junction to case (per thyristor or
diode)

R_{thJC} for various conduction angles d:

d	R_{thJC} (K/W)
DC	0.157
180°	0.168
120°	0.177
60°	0.200
30°	0.243

Constants for Z_{thJC} calculation:

i	R_{thi} (K/W)	t_i (s)
1	0.0076	0.00054
2	0.0406	0.098
3	0.0944	0.54
4	0.0147	12

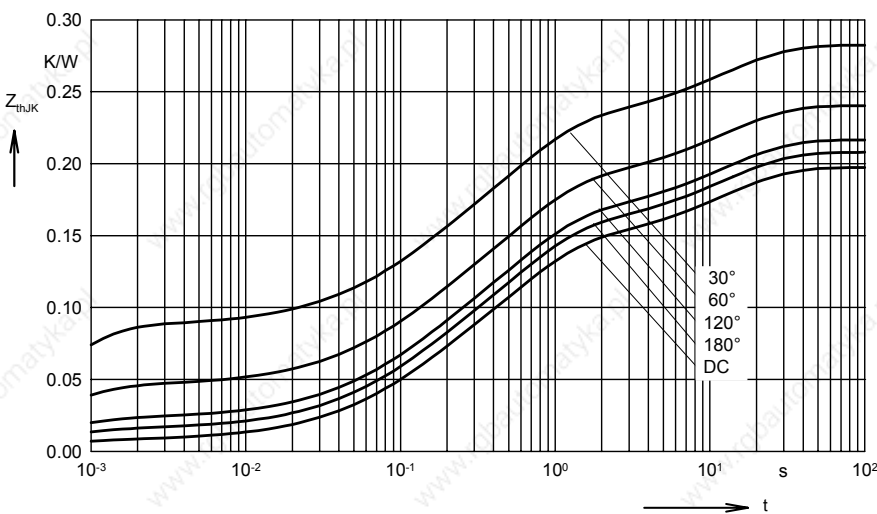

Fig. 9 Transient thermal impedance
junction to heatsink (per thyristor
or diode)

R_{thJK} for various conduction angles d:

d	R_{thJK} (K/W)
DC	0.197
180°	0.208
120°	0.217
60°	0.240
30°	0.283

Constants for Z_{thJK} calculation:

i	R_{thi} (K/W)	t_i (s)
1	0.0076	0.00054
2	0.0406	0.098
3	0.0944	0.54
4	0.0147	12
5	0.04	12

Thyristor Modules Thyristor/Diode Modules

$$I_{TRMS} = 2 \times 450 \text{ A}$$

$$I_{TAVM} = 2 \times 287 \text{ A}$$

$$V_{RRM} = 800-1800 \text{ V}$$

V_{RSM} V_{DSM} V	V_{RRM} V_{DRM} V	Type	Version 1	Version 1
900	800	MCC 250-08io1	MCD 250-08io1	
1300	1200	MCC 250-12io1	MCD 250-12io1	
1500	1400	MCC 250-14io1	MCD 250-14io1	
1700	1600	MCC 250-16io1	MCD 250-16io1	
1900	1800	MCC 250-18io1		

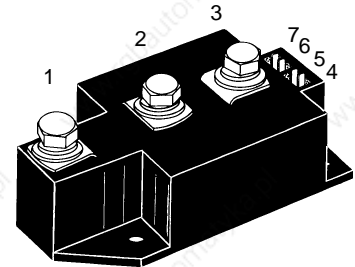

Symbol	Test Conditions	Maximum Ratings
I_{TRMS}^1, I_{FRMS} I_{TAVM}^2, I_{FAVM}	$T_{VJ} = T_{VJM}$ $T_C = 85^\circ\text{C}; 180^\circ \text{ sine}$	450 A 287 A
I_{TSM}^3, I_{FSM}	$T_{VJ} = 45^\circ\text{C};$ $V_R = 0$	$t = 10 \text{ ms (50 Hz), sine}$ 9000 A $t = 8.3 \text{ ms (60 Hz), sine}$ 9600 A
	$T_{VJ} = T_{VJM}$ $V_R = 0$	$t = 10 \text{ ms (50 Hz), sine}$ 7800 A $t = 8.3 \text{ ms (60 Hz), sine}$ 8500 A
j^2dt	$T_{VJ} = 45^\circ\text{C}$ $V_R = 0$	$t = 10 \text{ ms (50 Hz), sine}$ 405 000 A ² s $t = 8.3 \text{ ms (60 Hz), sine}$ 380 000 A ² s
	$T_{VJ} = T_{VJM}$ $V_R = 0$	$t = 10 \text{ ms (50 Hz), sine}$ 304 000 A ² s $t = 8.3 \text{ ms (60 Hz), sine}$ 300 000 A ² s
$(di/dt)_{cr}$	$T_{VJ} = T_{VJM}$ $f = 50 \text{ Hz}, t_p = 200 \mu\text{s}$ $V_D = 2/3 V_{DRM}$ $I_G = 1 \text{ A}$ $di_G/dt = 1 \text{ A}/\mu\text{s}$	repetitive, $I_T = 860 \text{ A}$ 100 A/ μs non repetitive, $I_T = 290 \text{ A}$ 800 A/ μs
$(dv/dt)_{cr}$	$T_{VJ} = T_{VJM}$ $R_{GK} = \infty$; method 1 (linear voltage rise)	$V_{DR} = 2/3 V_{DRM}$ 1000 V/ μs
P_{GM}	$T_{VJ} = T_{VJM}$ $I_T = I_{TAVM}$	$t_p = 30 \mu\text{s}$ 120 W $t_p = 500 \mu\text{s}$ 60 W
P_{GAV}		20 W
V_{RGM}		10 V
T_{VJ}		-40...+140 °C
T_{VJM}		140 °C
T_{stg}		-40...+125 °C
V_{ISOL}	50/60 Hz, RMS $I_{ISOL} \leq 1 \text{ mA}$	$t = 1 \text{ min}$ 3000 V~ $t = 1 \text{ s}$ 3600 V~
M_d	Mounting torque (M5) Terminal connection torque (M8)	2.5-5/22-44 Nm/lb.in. 12-15/106-132 Nm/lb.in.
Weight	Typical including screws	320 g

MCC

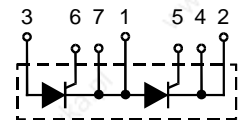

MCD

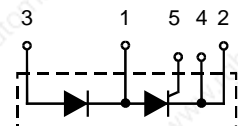

Features

- International standard package
- Direct copper bonded Al_2O_3 -ceramic base plate
- Planar passivated chips
- Isolation voltage 3600 V~
- UL registered, E 72873
- Keyed gate/cathode twin pins

Applications

- Motor control
- Power converter
- Heat and temperature control for industrial furnaces and chemical processes
- Lighting control
- Contactless switches

Advantages

- Space and weight savings
- Simple mounting
- Improved temperature and power cycling
- Reduced protection circuits

Data according to IEC 60747 and refer to a single thyristor/diode unless otherwise stated.
IXYS reserves the right to change limits, test conditions and dimensions

Symbol	Test Conditions	Characteristic Values
I_{RRM}	$T_{VJ} = T_{VJM}; V_R = V_{RRM}; V_D = V_{DRM}$	70 mA
I_{DRM}		40 mA
V_T, V_F	$I_T, I_F = 600 \text{ A}; T_{VJ} = 25^\circ\text{C}$	1.36 V
V_{T0}	For power-loss calculations only ($T_{VJ} = 140^\circ\text{C}$)	0.85 V
r_T		0.82 mΩ
V_{GT}	$V_D = 6 \text{ V}; T_{VJ} = 25^\circ\text{C}$	2 V
	$T_{VJ} = -40^\circ\text{C}$	3 V
I_{GT}	$V_D = 6 \text{ V}; T_{VJ} = 25^\circ\text{C}$	150 mA
	$T_{VJ} = -40^\circ\text{C}$	200 mA
V_{GD}	$T_{VJ} = T_{VJM}; V_D = 2/3 V_{DRM}$	0.25 V
I_{GD}		10 mA
I_L	$T_{VJ} = 25^\circ\text{C}; t_p = 30 \mu\text{s}; V_D = 6 \text{ V}$ $I_G = 0.45 \text{ A}; di_G/dt = 0.45 \text{ A}/\mu\text{s}$	200 mA
I_H	$T_{VJ} = 25^\circ\text{C}; V_D = 6 \text{ V}; R_{GK} = \infty$	150 mA
t_{gd}	$T_{VJ} = 25^\circ\text{C}; V_D = 1/2 V_{DRM}$ $I_G = 1 \text{ A}; di_G/dt = 1 \text{ A}/\mu\text{s}$	2 μs
t_q	$T_{VJ} = T_{VJM}; I_T = 300 \text{ A}, t_p = 200 \mu\text{s}; -di/dt = 10 \text{ A}/\mu\text{s}$ typ. $V_R = 100 \text{ V}; dv/dt = 50 \text{ V}/\mu\text{s}; V_D = 2/3 V_{DRM}$	200 μs
Q_S	$T_{VJ} = 125^\circ\text{C}; I_T, I_F = 400 \text{ A}, -di/dt = 50 \text{ A}/\mu\text{s}$	760 μC
I_{RM}		275 A
R_{thJC}	per thyristor/diode; DC current per module	0.129 K/W
R_{thJK}	per thyristor/diode; DC current per module	0.0645 K/W
	other values see Fig. 8/9	0.169 K/W
		0.0845 K/W
d_s	Creepage distance on surface	12.7 mm
d_A	Strike distance through air	9.6 mm
a	Maximum allowable acceleration	50 m/s ²

Optional accessories for modules

Keyed gate/cathode twin plugs with wire length = 350 mm, gate = yellow, cathode = red

Type ZY 180L (L = Left for pin pair 4/5) } UL 758, style 1385,
Type ZY 180R (R = right for pin pair 6/7) } CSA class 5851, guide 460-1-1

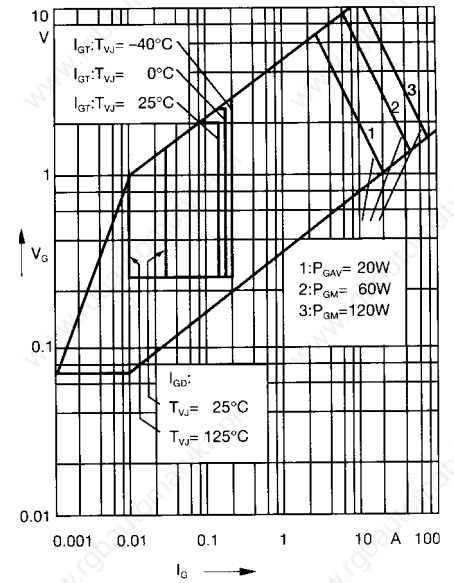

Fig. 1 Gate trigger characteristics

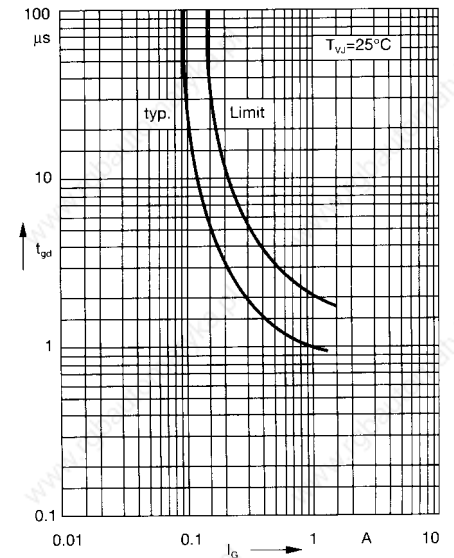
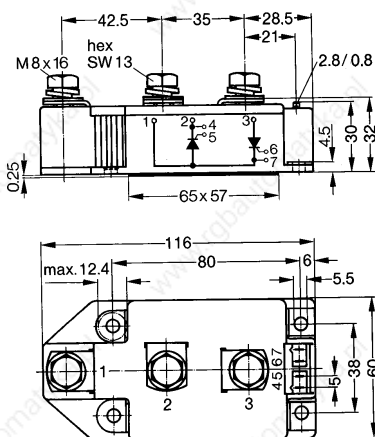

Fig. 2 Gate trigger delay time

Dimensions in mm (1 mm = 0.0394")

MCC



MCD

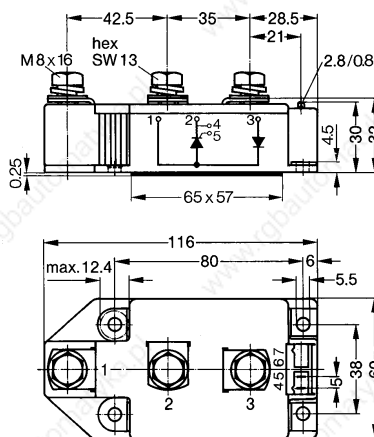

Threaded spacer for higher Anode/
Cathode construction:
Type ZY 250, material brass

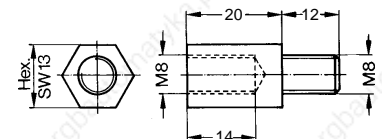

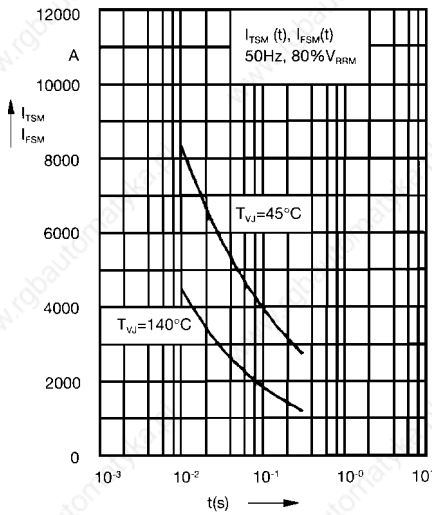

Fig. 3 Surge overload current
 I_{TSM}, I_{FSM} : Crest value, t: duration

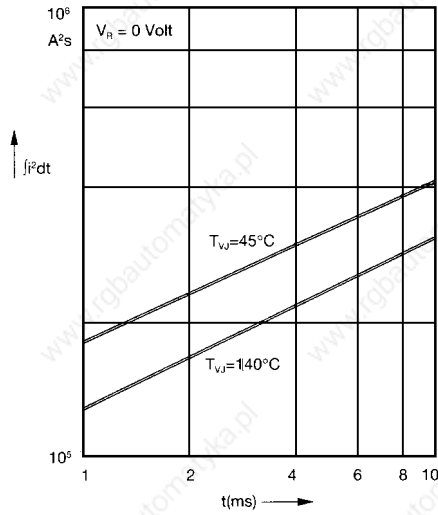

Fig. 4 j^2dt versus time (1-10 ms)

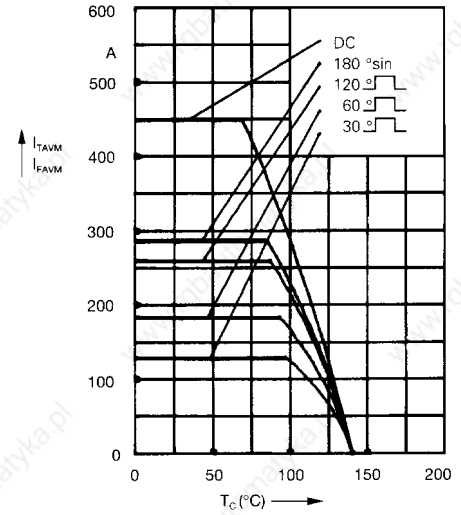

Fig. 4a Maximum forward current at case temperature

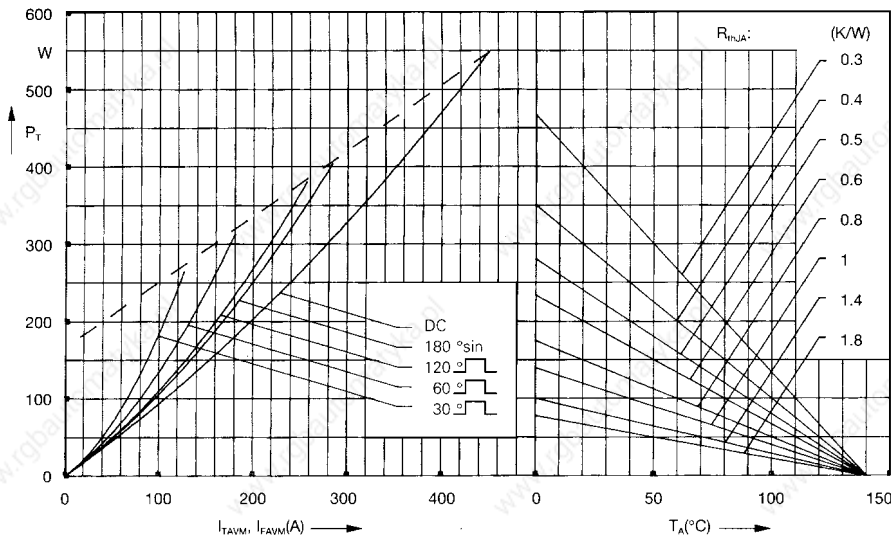

Fig. 5 Power dissipation versus on-state current and ambient temperature (per thyristor or diode)

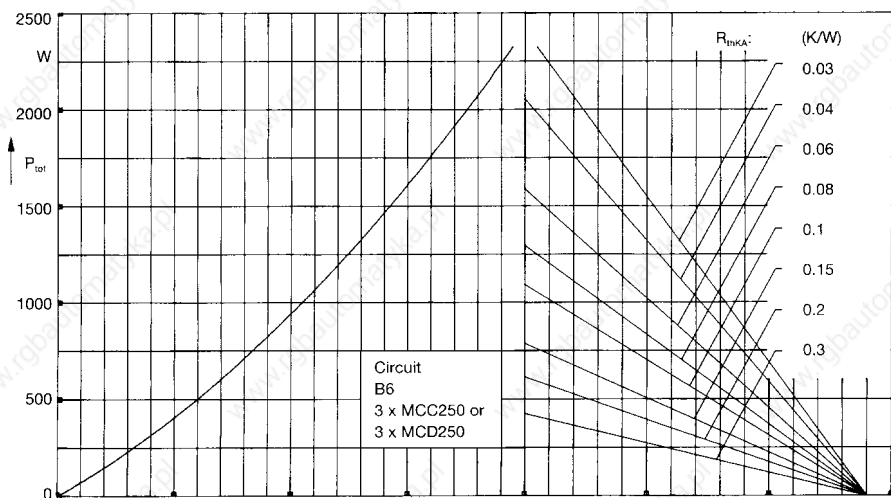

Fig. 6 Three phase rectifier bridge: Power dissipation versus direct output current and ambient temperature

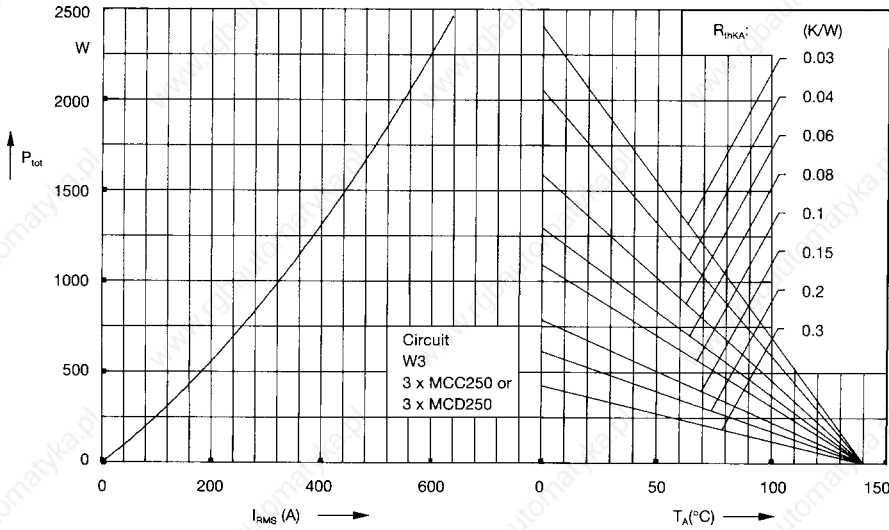

Fig. 7 Three phase AC-controller:
Power dissipation versus RMS
output current and ambient
temperature

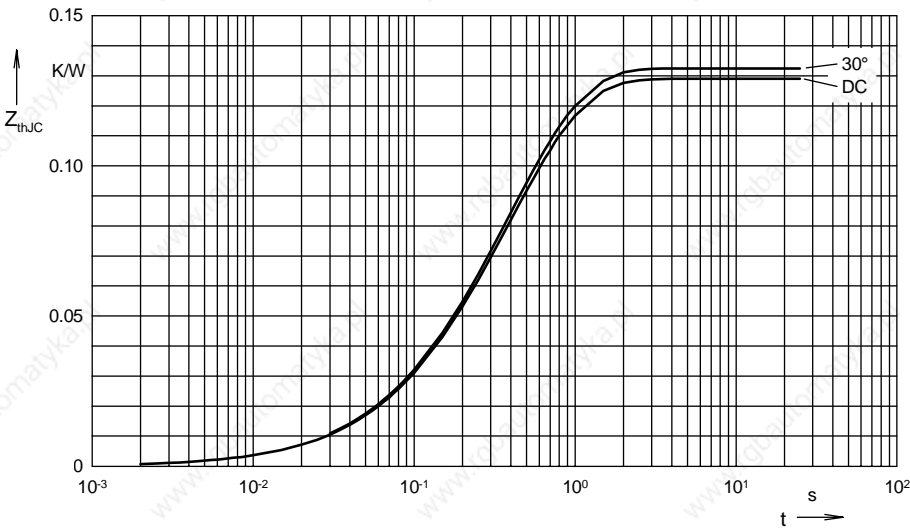

Fig. 8 Transient thermal impedance
junction to case (per thyristor or
diode)

R_{thJC} for various conduction angles d :

d	R_{thJC} (K/W)
DC	0.129
180°C	0.131
120°C	0.131
60°C	0.132
30°C	0.132

Constants for Z_{thJC} calculation:

i	R_{thi} (K/W)	t_i (s)
1	0.0035	0.099
2	0.0165	0.168
3	0.1091	0.456

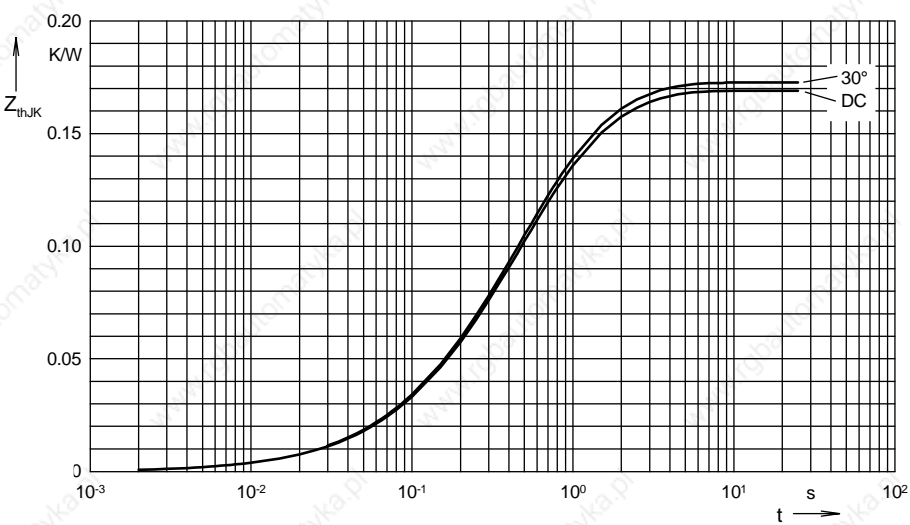

Fig. 9 Transient thermal impedance
junction to heatsink (per thyristor
or diode)

R_{thJK} for various conduction angles d :

d	R_{thJK} (K/W)
DC	0.169
180°C	0.171
120°C	0.172
60°C	0.172
30°C	0.173

Constants for Z_{thJK} calculation:

i	R_{thi} (K/W)	t_i (s)
1	0.0033	0.099
2	0.0159	0.168
3	0.1053	0.456
4	0.04	1.36

Thyristor Modules Thyristor/Diode Modules

$$I_{TRMS} = 2x 450 A$$

$$I_{TAVM} = 2x 250 A$$

$$V_{RRM} = 1200-1800 V$$

V_{RSM} V_{DSM} V	V_{RRM} V_{DRM} V	Type	
1300	1200	MCC 255-12io1	MCD 255-12io1
1500	1400	MCC 255-14io1	MCD 255-14io1
1700	1600	MCC 255-16io1	MCD 255-16io1
1900	1800	MCC 255-18io1	MCD 255-18io1

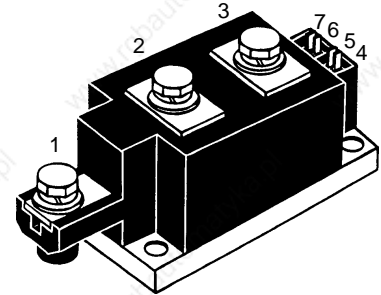

Symbol	Test Conditions	Maximum Ratings	
I_{TRMS}, I_{FRMS} I_{TAVM}, I_{FAVM}	$T_{VJ} = T_{VJM}$ $T_C = 85^\circ C; 180^\circ$ sine	450 250	A A
I_{TSM}, I_{FSM}	$T_{VJ} = 45^\circ C;$ $V_R = 0$	$t = 10$ ms (50 Hz) $t = 8.3$ ms (60 Hz)	9000 9600 A A
	$T_{VJ} = T_{VJM}$ $V_R = 0$	$t = 10$ ms (50 Hz) $t = 8.3$ ms (60 Hz)	7800 8600 A A
$\int i^2 dt$	$T_{VJ} = 45^\circ C$ $V_R = 0$	$t = 10$ ms (50 Hz) $t = 8.3$ ms (60 Hz)	405 000 382 000 A^2s A^2s
	$T_{VJ} = T_{VJM}$ $V_R = 0$	$t = 10$ ms (50 Hz) $t = 8.3$ ms (60 Hz)	304 000 307 000 A^2s A^2s
$(di/dt)_{cr}$	$T_{VJ} = T_{VJM}$ $f = 50$ Hz, $t_p = 200$ μs $V_D = 2/3 V_{DRM}$ $I_G = 1$ A, $di_G/dt = 1$ A/ μs	repetitive, $I_T = 860$ A non repetitive, $I_T = I_{TAVM}$	100 500 A/ μs A/ μs
$(dv/dt)_{cr}$	$T_{VJ} = T_{VJM}; V_{DR} = 2/3 V_{DRM}$ $R_{GK} = \infty;$ method 1 (linear voltage rise)		1000 V/ μs
P_{GM}	$T_{VJ} = T_{VJM}$ $I_T = I_{TAVM}$	$t_p = 30$ μs $t_p = 500$ μs	120 60 20 10 W W W V
P_{GAV} V_{RGM}			
T_{VJ} T_{VJM} T_{stg}			-40...+130 130 -40...+125 $^\circ C$ $^\circ C$ $^\circ C$
V_{ISOL}	50/60 Hz, RMS $I_{ISOL} \leq 1$ mA	$t = 1$ min $t = 1$ s	3000 3600 V~ V~
M_d	Mounting torque (M6) Terminal connection torque (M8)	4.5-7/40-62 11-13/97-115	Nm/lb.in. Nm/lb.in.
Weight	Typical including screws	750	g

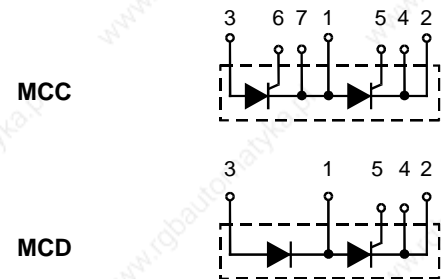

Features

- International standard package
- Direct copper bonded Al_2O_3 -ceramic with copper base plate
- Planar passivated chips
- Isolation voltage 3600 V~
- UL registered E 72873
- Keyed gate/cathode twin pins

Applications

- Motor control, softstarter
- Power converter
- Heat and temperature control for industrial furnaces and chemical processes
- Lighting control
- Solid state switches

Advantages

- Simple mounting
- Improved temperature and power cycling
- Reduced protection circuits

Data according to IEC 60747 and refer to a single thyristor/diode unless otherwise stated. IXYS reserves the right to change limits, test conditions and dimensions

Symbol	Test Conditions	Characteristic Values
I_{RRM}, I_{DRM}	$T_{VJ} = T_{VJM}; V_R = V_{RRM}; V_D = V_{DRM}$	40 mA
V_T, V_F	$I_T, I_F = 600 \text{ A}; T_{VJ} = 25^\circ\text{C}$	1.36 V
V_{T0}	For power-loss calculations only ($T_{VJ} = 130^\circ\text{C}$)	0.8 V
r_T		0.68 mΩ
V_{GT}	$V_D = 6 \text{ V}; T_{VJ} = 25^\circ\text{C}$	2 V
	$T_{VJ} = -40^\circ\text{C}$	3 V
I_{GT}	$V_D = 6 \text{ V}; T_{VJ} = 25^\circ\text{C}$	150 mA
	$T_{VJ} = -40^\circ\text{C}$	220 mA
V_{GD}	$T_{VJ} = T_{VJM}; V_D = 2/3 V_{DRM}$	0.25 V
I_{GD}	$T_{VJ} = T_{VJM}; V_D = 2/3 V_{DRM}$	10 mA
I_L	$T_{VJ} = 25^\circ\text{C}; t_p = 30 \mu\text{s}; V_D = 6 \text{ V}$ $I_G = 0.45 \text{ A}; di_G/dt = 0.45 \text{ A}/\mu\text{s}$	200 mA
I_H	$T_{VJ} = 25^\circ\text{C}; V_D = 6 \text{ V}; R_{GK} = \infty$	150 mA
t_{gd}	$T_{VJ} = 25^\circ\text{C}; V_D = 1/2 V_{DRM}$ $I_G = 1 \text{ A}; di_G/dt = 1 \text{ A}/\mu\text{s}$	2 μs
t_q	$T_{VJ} = T_{VJM}; I_T = 300 \text{ A}, t_p = 200 \mu\text{s}; -di/dt = 10 \text{ A}/\mu\text{s}$ typ. $V_R = 100 \text{ V}; dv/dt = 50 \text{ V}/\mu\text{s}; V_D = 2/3 V_{DRM}$	200 μs
Q_S	$T_{VJ} = 125^\circ\text{C}; I_T, I_F = 300 \text{ A}; -di/dt = 50 \text{ A}/\mu\text{s}$	760 μC
I_{RM}		275 A
R_{thJC}	per thyristor (diode); DC current per module	0.140 K/W
R_{thJK}	per thyristor (diode); DC current per module	0.07 K/W 0.18 K/W 0.09 K/W
	other values see Fig. 8/9	
d_s	Creeping distance on surface	12.7 mm
d_A	Creepage distance in air	9.6 mm
a	Maximum allowable acceleration	50 m/s ²

Optional accessories for modules

Keyed Gate/Cathode twin plugs with wire length = 350 mm, gate = yellow, cathode = red

Type ZY 180 L (L = Left for pin pair 4/5) } UL 758, style 1385,
Type ZY 180 R (R = Right for pin pair 6/7) } CSA class 5851, guide 460-1-1

Dimensions in mm (1 mm = 0.0394")

MCC 255

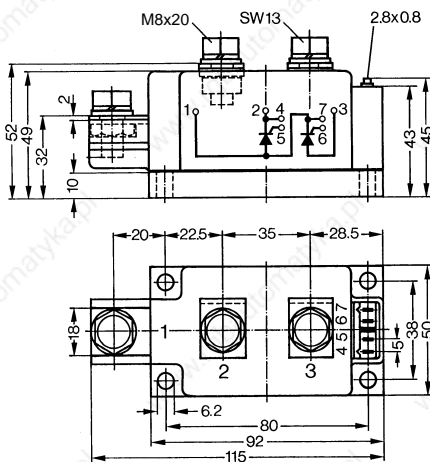

MCD 255

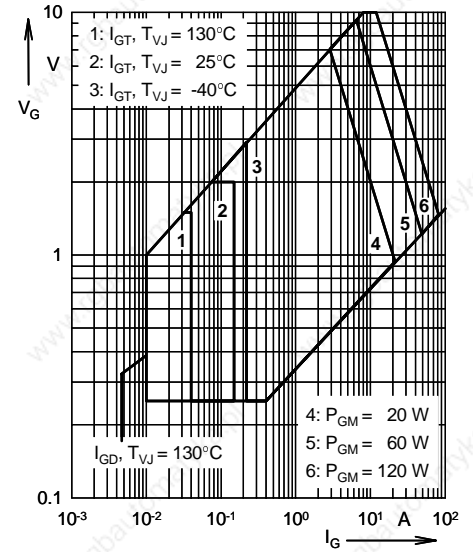
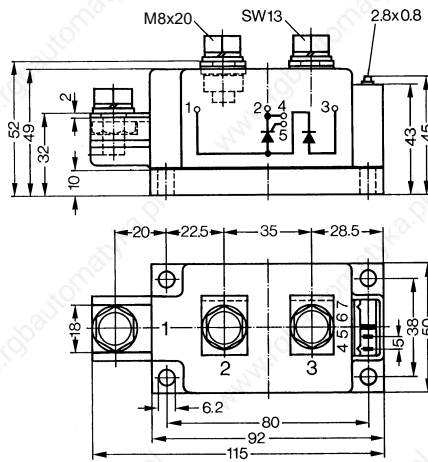

Fig. 1 Gate trigger characteristics

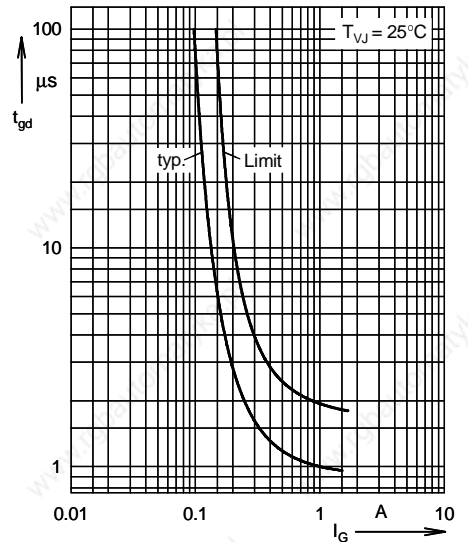

Fig. 2 Gate trigger delay time

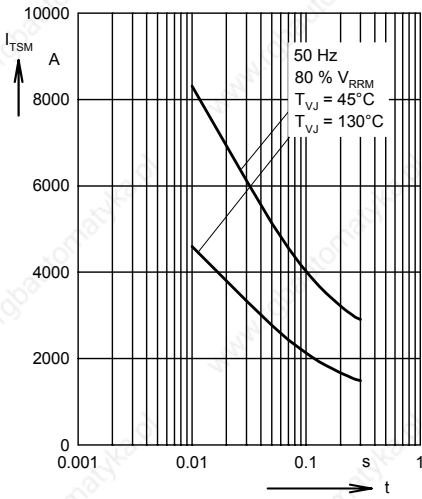

Fig. 3 Surge overload current
 I_{TSM}, I_{FSM} : Crest value, t : duration

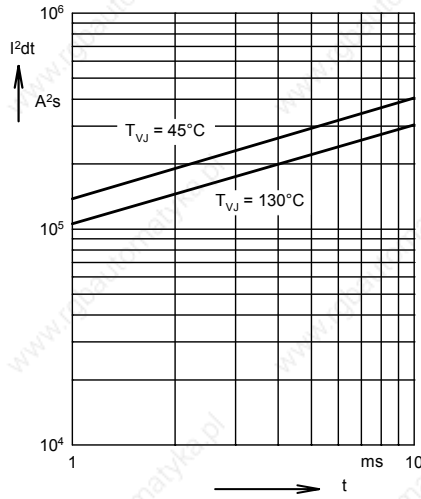

Fig. 4 $\int i^2 dt$ versus time (1-10 ms)

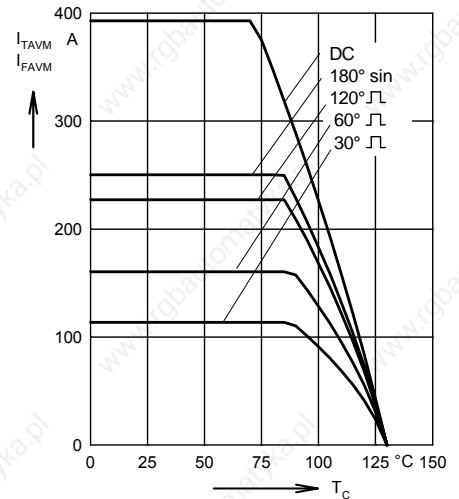

Fig. 4a Maximum forward current at case temperature

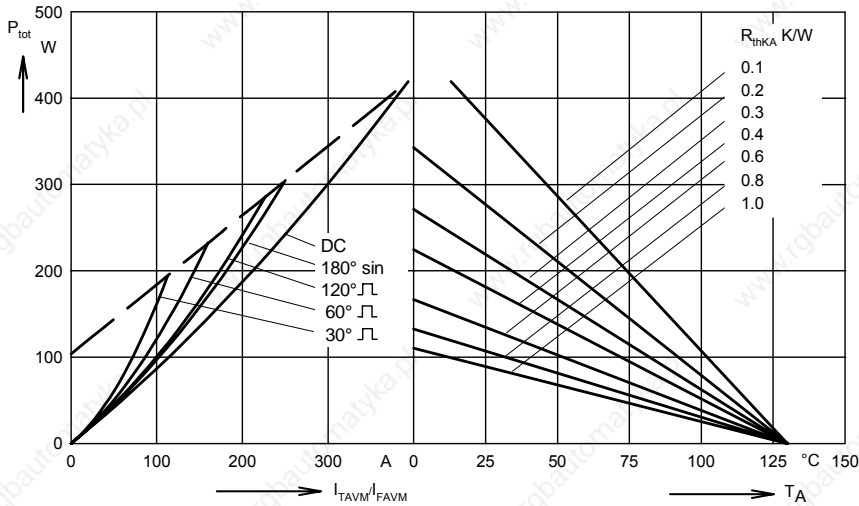

Fig. 5 Power dissipation versus on-state current and ambient temperature (per thyristor or diode)

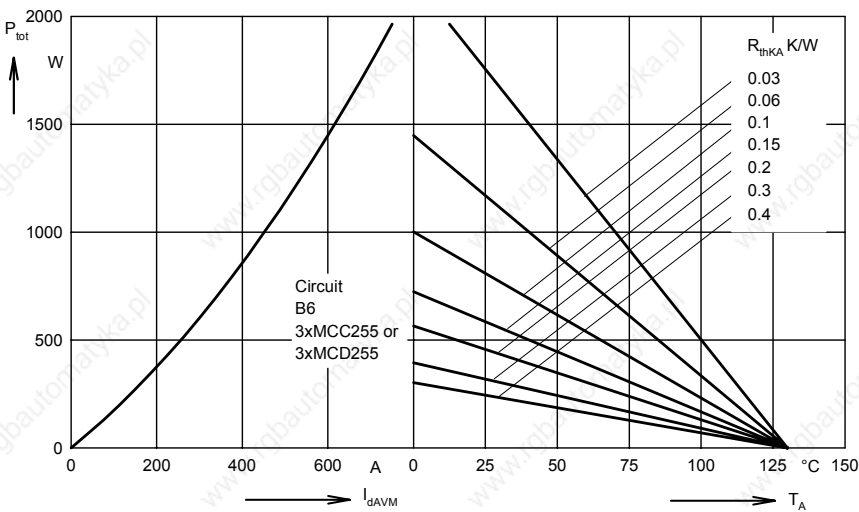

Fig. 6 Three phase rectifier bridge: Power dissipation versus direct output current and ambient temperature

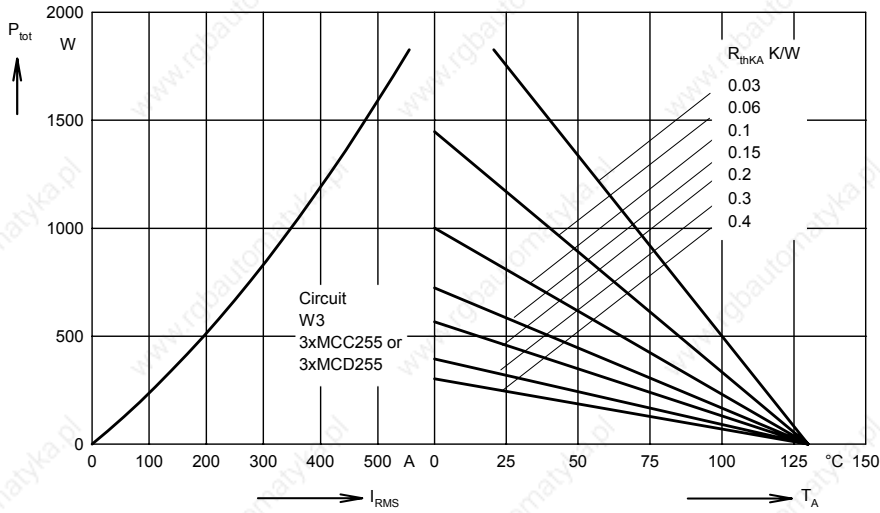

Fig. 7 Three phase AC-controller:
Power dissipation versus RMS
output current and ambient
temperature

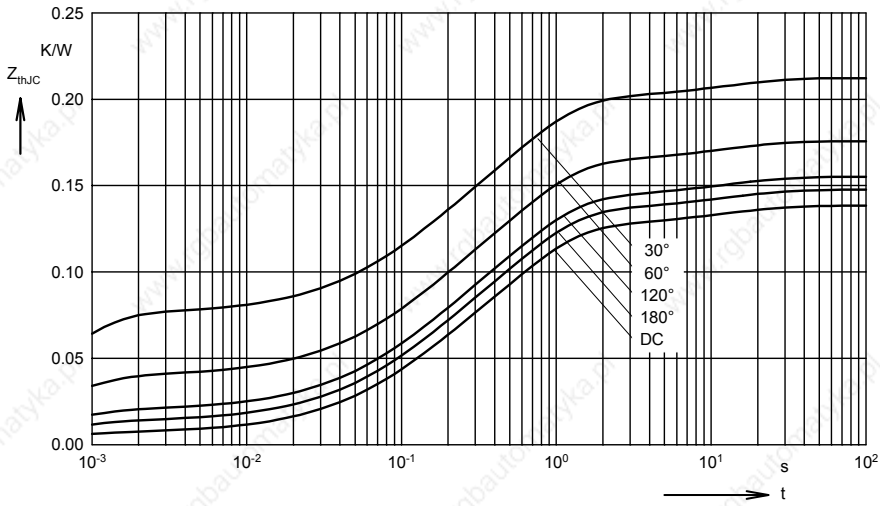

Fig. 8 Transient thermal impedance
junction to case (per thyristor or
diode)

R_{thJC} for various conduction angles d:

d	R_{thJC} (K/W)
DC	0.139
180°	0.148
120°	0.156
60°	0.176
30°	0.214

Constants for Z_{thJC} calculation:

i	R_{thi} (K/W)	t_i (s)
1	0.0066	0.00054
2	0.0358	0.098
3	0.0831	0.54
4	0.0129	12

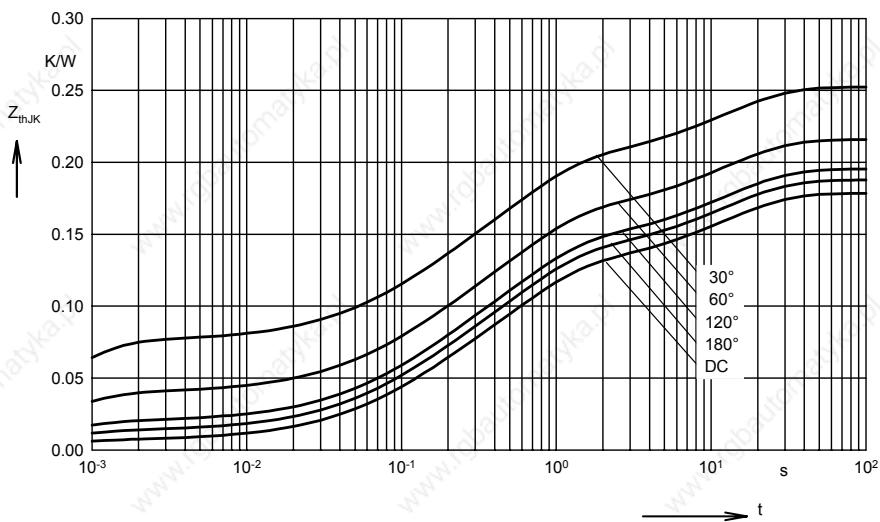

Fig. 9 Transient thermal impedance
junction to heatsink (per thyristor
or diode)

R_{thJK} for various conduction angles d:

d	R_{thJK} (K/W)
DC	0.179
180°	0.188
120°	0.196
60°	0.216
30°	0.254

Constants for Z_{thJK} calculation:

i	R_{thi} (K/W)	t_i (s)
1	0.0066	0.00054
2	0.0358	0.098
3	0.0831	0.54
4	0.0129	12
5	0.04	12

Thyristor Modules Thyristor/Diode Modules

$I_{TRMS} = 2 \times 500 \text{ A}$
 $I_{TAVM} = 2 \times 320 \text{ A}$
 $V_{RRM} = 800-2200 \text{ V}$

V_{RSM} V_{DSM} V	V_{RRM} V_{DRM} V	Type	Version 1	Version 1
900	800	MCC 310-08io1	MCC 310-08io1	MCD 310-08io1
1300	1200	MCC 310-12io1	MCC 310-12io1	MCD 310-12io1
1500	1400	MCC 310-14io1	MCC 310-14io1	MCD 310-14io1
1700	1600	MCC 310-16io1	MCC 310-16io1	MCD 310-16io1
1900	1800	MCC 310-18io1	MCC 310-18io1	MCD 310-18io1

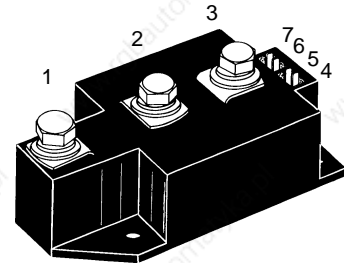

Symbol	Test Conditions	Maximum Ratings
I_{TRMS}, I_{FRMS} I_{TAVM}, I_{FAVM}	$T_{VJ} = T_{VJM}$ $T_C = 85^\circ\text{C}; 180^\circ \text{ sine}$	500 A 320 A
I_{TSM}, I_{FSM}	$T_{VJ} = 45^\circ\text{C};$ $V_R = 0$	$t = 10 \text{ ms (50 Hz), sine}$ 9200 A $t = 8.3 \text{ ms (60 Hz), sine}$ 9800 A
	$T_{VJ} = T_{VJM}$ $V_R = 0$	$t = 10 \text{ ms (50 Hz), sine}$ 8000 A $t = 8.3 \text{ ms (60 Hz), sine}$ 8600 A
$j_i^2 dt$	$T_{VJ} = 45^\circ\text{C}$ $V_R = 0$	$t = 10 \text{ ms (50 Hz), sine}$ 420 000 A ² s $t = 8.3 \text{ ms (60 Hz), sine}$ 400 000 A ² s
	$T_{VJ} = T_{VJM}$ $V_R = 0$	$t = 10 \text{ ms (50 Hz), sine}$ 320 000 A ² s $t = 8.3 \text{ ms (60 Hz), sine}$ 306 000 A ² s
$(di/dt)_{cr}$	$T_{VJ} = T_{VJM}$ $f = 50 \text{ Hz}, t_p = 200 \mu\text{s}$ $V_D = 2/3 V_{DRM}$ $I_G = 1 \text{ A}$ $di_G/dt = 1 \text{ A}/\mu\text{s}$	repetitive, $I_T = 960 \text{ A}$ 100 A/ μs non repetitive, $I_T = 320 \text{ A}$ 500 A/ μs
$(dv/dt)_{cr}$	$T_{VJ} = T_{VJM};$ $R_{GK} = \infty; \text{ method 1 (linear voltage rise)}$	$V_{DR} = 2/3 V_{DRM}$ 1000 V/ μs
P_{GM}	$T_{VJ} = T_{VJM}$ $I_T = I_{TAVM}$	$t_p = 30 \mu\text{s}$ 120 W $t_p = 500 \mu\text{s}$ 60 W
P_{GAV}		20 W
V_{RGM}		10 V
T_{VJ}		-40...+140 °C
T_{VJM}		140 °C
T_{stg}		-40...+125 °C
V_{ISOL}	50/60 Hz, RMS $I_{ISOL} \leq 1 \text{ mA}$	$t = 1 \text{ min}$ 3000 V~ $t = 1 \text{ s}$ 3600 V~
M_d	Mounting torque (M5) Terminal connection torque (M8)	2.5-5/22-44 Nm/lb.in. 12-15/106-132 Nm/lb.in.
Weight	Typical including screws	320 g

MCC

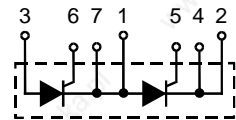

MCD

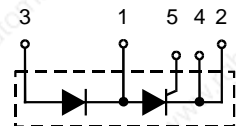

Features

- International standard package
- Direct copper bonded Al₂O₃ -ceramic base plate
- Planar passivated chips
- Isolation voltage 3600 V~
- UL registered, E 72873
- Keyed gate/cathode twin pins

Applications

- Motor control
- Power converter
- Heat and temperature control for industrial furnaces and chemical processes
- Lighting control
- Contactless switches

Advantages

- Space and weight savings
- Simple mounting
- Improved temperature and power cycling
- Reduced protection circuits

Data according to IEC 60747 and refer to a single thyristor/diode unless otherwise stated.
IXYS reserves the right to change limits, test conditions and dimensions

Symbol	Test Conditions	Characteristic Values
I_{RRM}	$T_{VJ} = T_{VJM}; V_R = V_{RRM}; V_D = V_{DRM}$	70 mA
I_{DRM}		40 mA
V_T, V_F	$I_T, I_F = 600 \text{ A}; T_{VJ} = 25^\circ\text{C}$	1.32 V
V_{T0}	For power-loss calculations only ($T_{VJ} = 140^\circ\text{C}$)	0.8 V
r_T		0.82 mΩ
V_{GT}	$V_D = 6 \text{ V}; T_{VJ} = 25^\circ\text{C}$	2 V
	$T_{VJ} = -40^\circ\text{C}$	3 V
I_{GT}	$V_D = 6 \text{ V}; T_{VJ} = 25^\circ\text{C}$	150 mA
	$T_{VJ} = -40^\circ\text{C}$	200 mA
V_{GD}	$T_{VJ} = T_{VJM}; V_D = 2/3 V_{DRM}$	0.25 V
I_{GD}		10 mA
I_L	$T_{VJ} = 25^\circ\text{C}; t_p = 30 \mu\text{s}; V_D = 6 \text{ V}$ $I_G = 0.45 \text{ A}; di_G/dt = 0.45 \text{ A}/\mu\text{s}$	200 mA
I_H	$T_{VJ} = 25^\circ\text{C}; V_D = 6 \text{ V}; R_{GK} = \infty$	150 mA
t_{gd}	$T_{VJ} = 25^\circ\text{C}; V_D = 1/2 V_{DRM}$ $I_G = 1 \text{ A}; di_G/dt = 1 \text{ A}/\mu\text{s}$	2 μs
t_q	$T_{VJ} = T_{VJM}; I_T = 300 \text{ A}, t_p = 200 \mu\text{s}; -di/dt = 10 \text{ A}/\mu\text{s}$ typ. 200 μs $V_R = 100 \text{ V}; dv/dt = 50 \text{ V}/\mu\text{s}; V_D = 2/3 V_{DRM}$	
Q_S	$T_{VJ} = 125^\circ\text{C}; I_T, I_F = 400 \text{ A}, -di/dt = 50 \text{ A}/\mu\text{s}$	760 μC
I_{RM}		275 A
R_{thJC}	per thyristor/diode; DC current per module	0.112 K/W
R_{thJK}	per thyristor/diode; DC current per module	0.056 K/W
	other values see Fig. 8/9	0.152 K/W
		0.076 K/W
d_s	Creepage distance on surface	12.7 mm
d_A	Strike distance through air	9.6 mm
a	Maximum allowable acceleration	50 m/s ²

Optional accessories for modules

Keyed gate/cathode twin plugs with wire length = 350 mm, gate = yellow, cathode = red

Type ZY 180L (L = Left for pin pair 4/5) } UL 758, style 1385,
Type ZY 180R (R = right for pin pair 6/7) } CSA class 5851, guide 460-1-1

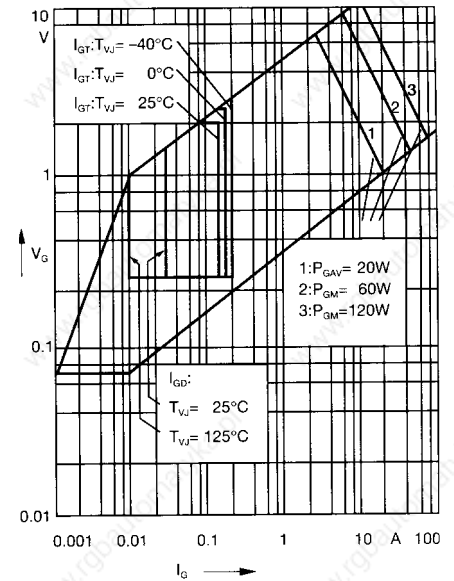

Fig. 1 Gate trigger characteristics

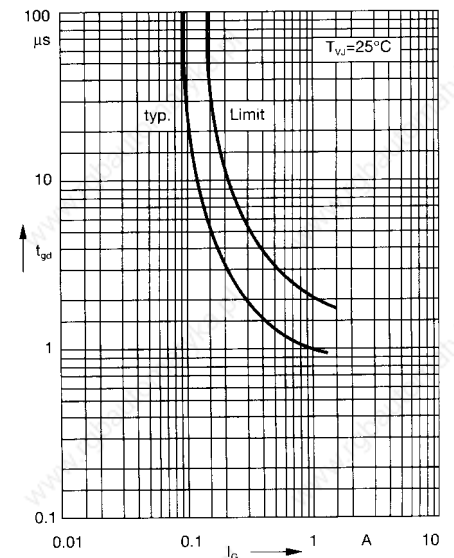
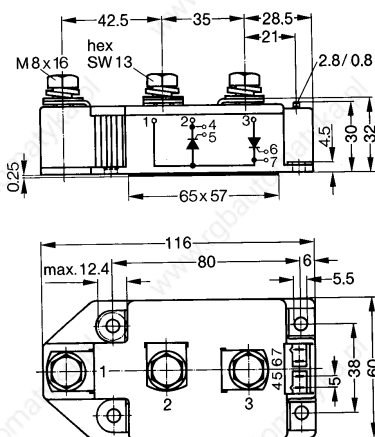

Fig. 2 Gate trigger delay time

Dimensions in mm (1 mm = 0.0394")

MCC



MCD

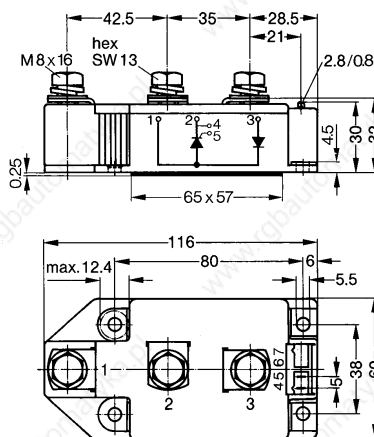

Threaded spacer for higher Anode/Cathode construction:
Type ZY 250, material brass

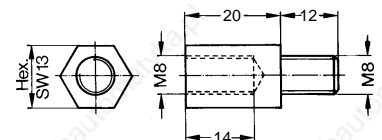

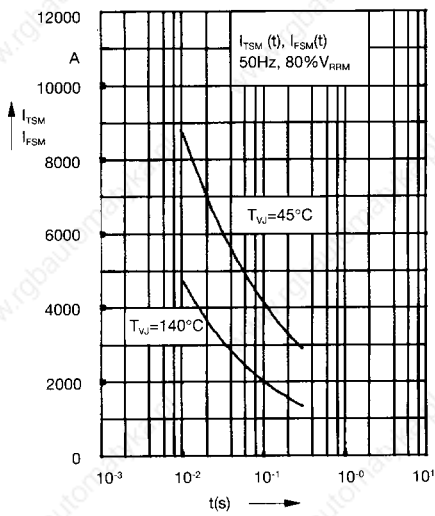

Fig. 3 Surge overload current
 I_{TSM}, I_{FSM} : Crest value, t : duration

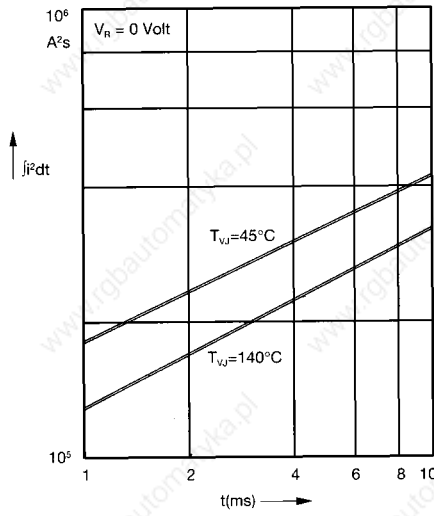

Fig. 4 $\int i^2 dt$ versus time (1-10 ms)

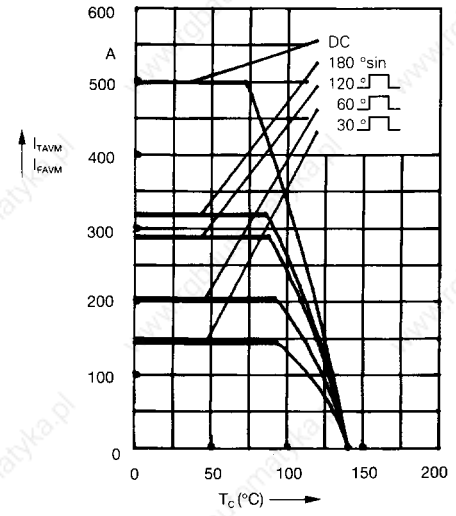

Fig. 4a Maximum forward current at case temperature

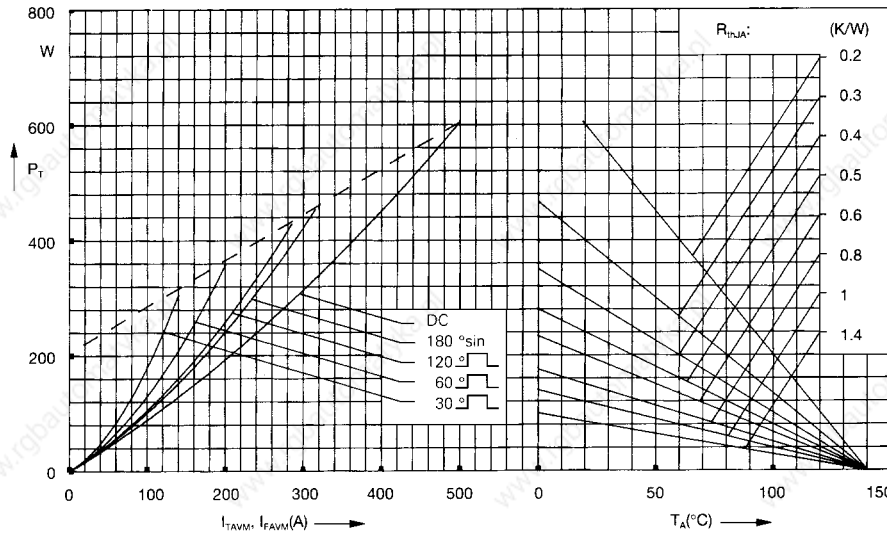

Fig. 5 Power dissipation versus on-state current and ambient temperature (per thyristor or diode)

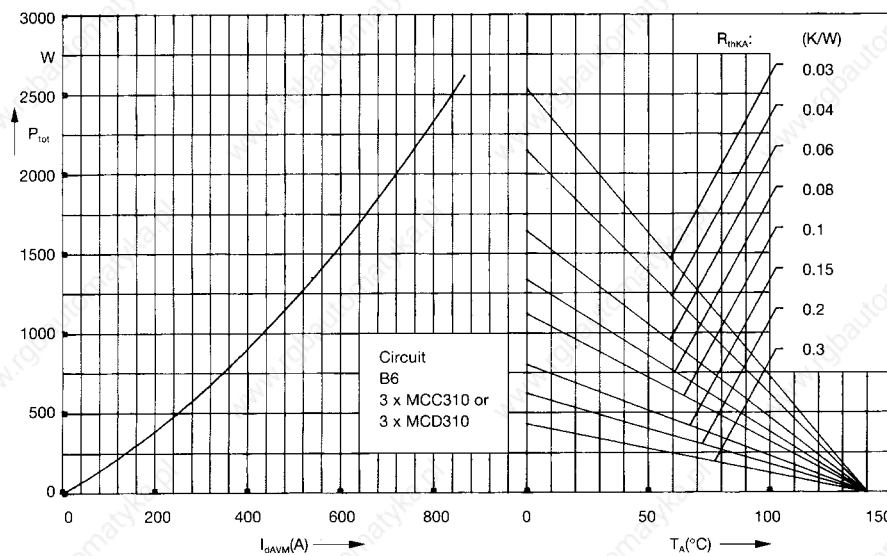

Fig. 6 Three phase rectifier bridge: Power dissipation versus direct output current and ambient temperature

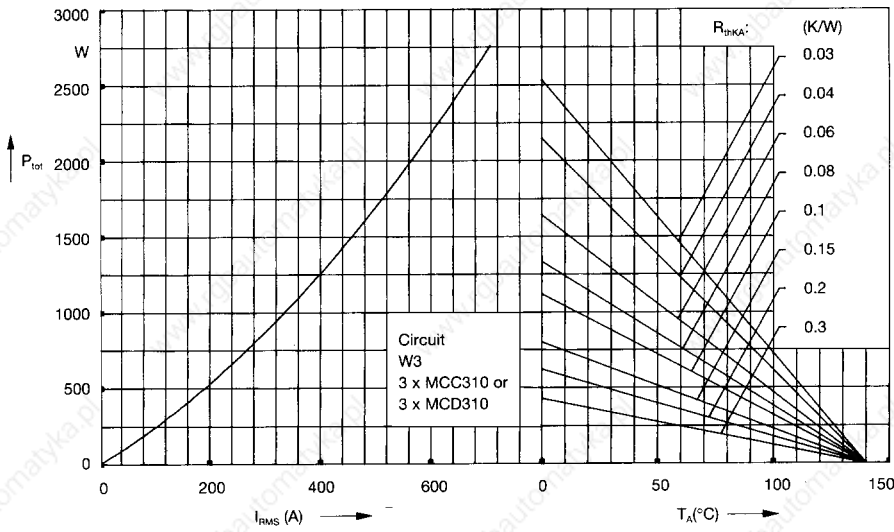

Fig. 7 Three phase AC-controller: Power dissipation versus RMS output current and ambient temperature

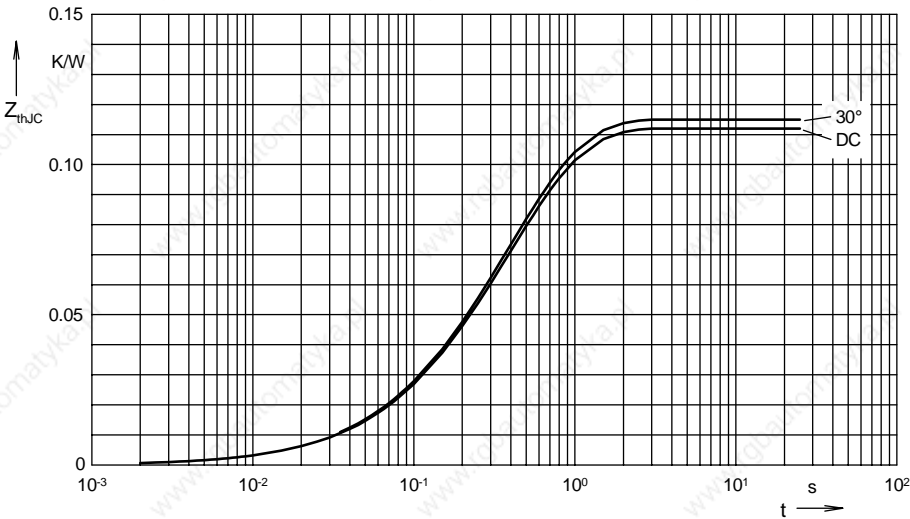

Fig. 8 Transient thermal impedance junction to case (per thyristor or diode)

R_{thJC} for various conduction angles d:

d	R_{thJC} (K/W)
DC	0.112
180°C	0.113
120°C	0.114
60°C	0.115
30°C	0.115

Constants for Z_{thJC} calculation:

i	R_{thi} (K/W)	t_i (s)
1	0.003	0.099
2	0.0143	0.168
3	0.0947	0.456

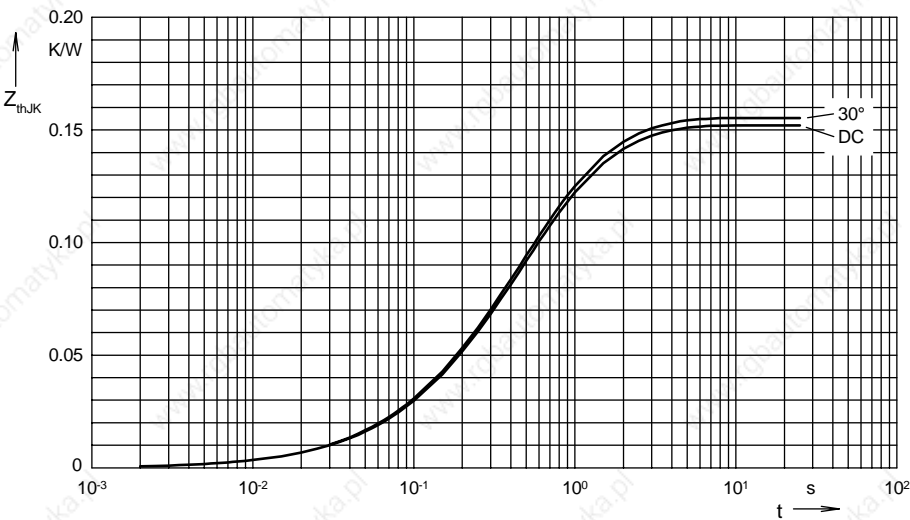

Fig. 9 Transient thermal impedance junction to heatsink (per thyristor or diode)

R_{thJK} for various conduction angles d:

d	R_{thJK} (K/W)
DC	0.152
180°C	0.154
120°C	0.154
60°C	0.155
30°C	0.155

Constants for Z_{thJK} calculation:

i	R_{thi} (K/W)	t_i (s)
1	0.003	0.099
2	0.0143	0.168
3	0.0947	0.456
4	0.04	1.36

Thyristor Modules Thyristor/Diode Modules

$$I_{TRMS} = 2x 520 A$$

$$I_{TAVM} = 2x 320 A$$

$$V_{RRM} = 1200-1800 V$$

V_{RSM}	V_{RRM}	Type	
V_{DSM}	V_{DRM}		
V	V		
1300	1200	MCC 312-12io1	MCD 312-12io1
1500	1400	MCC 312-14io1	MCD 312-14io1
1700	1600	MCC 312-16io1	MCD 312-16io1
1900	1800	MCC 312-18io1	MCD 312-18io1

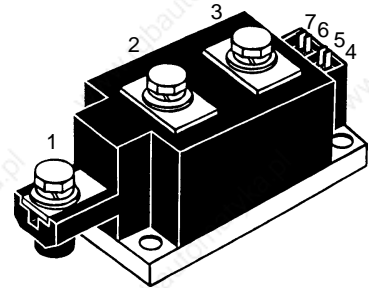

Symbol	Test Conditions	Maximum Ratings	
I_{TRMS}, I_{FRMS} I_{TAVM}, I_{FAVM}	$T_{VJ} = T_{VJM}$ $T_C = 85^\circ C; 180^\circ$ sine	520	A
		320	A
I_{TSM}, I_{FSM}	$T_{VJ} = 45^\circ C;$ $V_R = 0$	$t = 10$ ms (50 Hz)	A
		$t = 8.3$ ms (60 Hz)	A
	$T_{VJ} = T_{VJM}$ $V_R = 0$	$t = 10$ ms (50 Hz)	A
		$t = 8.3$ ms (60 Hz)	A
$\int i^2 dt$	$T_{VJ} = 45^\circ C$ $V_R = 0$	$t = 10$ ms (50 Hz)	A ² s
		$t = 8.3$ ms (60 Hz)	A ² s
	$T_{VJ} = T_{VJM}$ $V_R = 0$	$t = 10$ ms (50 Hz)	A ² s
		$t = 8.3$ ms (60 Hz)	A ² s
$(di/dt)_{cr}$	$T_{VJ} = T_{VJM}$ $f = 50$ Hz, $t_p = 200$ μ s $V_D = 2/3 V_{DRM}$ $I_G = 1$ A, $di_G/dt = 1$ A/ μ s	repetitive, $I_T = 960$ A	100 A/ μ s
		non repetitive, $I_T = I_{TAVM}$	500 A/ μ s
$(dv/dt)_{cr}$	$T_{VJ} = T_{VJM}; V_{DR} = 2/3 V_{DRM}$ $R_{GK} = \infty;$ method 1 (linear voltage rise)		1000 V/ μ s
P_{GM}	$T_{VJ} = T_{VJM}$ $I_T = I_{TAVM}$	$t_p = 30$ μ s	120 W
		$t_p = 500$ μ s	60 W
P_{GAV}			20 W
V_{RGM}			10 V
T_{VJ}			-40...+140 $^\circ C$
T_{VJM}			140 $^\circ C$
T_{stg}			-40...+125 $^\circ C$
V_{ISOL}	50/60 Hz, RMS	$t = 1$ min	3000 V~
	$I_{ISOL} \leq 1$ mA	$t = 1$ s	3600 V~
M_d	Mounting torque (M6)	4.5-7/40-62	Nm/lb.in.
	Terminal connection torque (M8)	11-13/97-115	Nm/lb.in.
Weight	Typical including screws	750	g

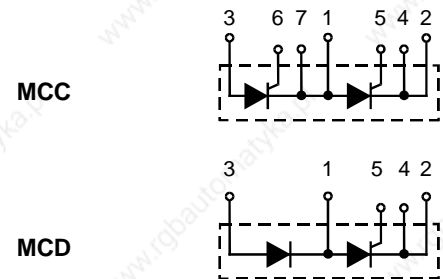

Features

- International standard package
- Direct copper bonded Al_2O_3 -ceramic with copper base plate
- Planar passivated chips
- Isolation voltage 3600 V~
- UL registered E 72873
- Keyed gate/cathode twin pins

Applications

- Motor control, softstarter
- Power converter
- Heat and temperature control for industrial furnaces and chemical processes
- Lighting control
- Solid state switches

Advantages

- Simple mounting
- Improved temperature and power cycling
- Reduced protection circuits

Data according to IEC 60747 and refer to a single thyristor/diode unless otherwise stated. IXYS reserves the right to change limits, test conditions and dimensions

Symbol	Test Conditions	Characteristic Values
I_{RRM}, I_{DRM}	$T_{VJ} = T_{VJM}; V_R = V_{RRM}; V_D = V_{DRM}$	40 mA
V_T, V_F	$I_T, I_F = 600 \text{ A}; T_{VJ} = 25^\circ\text{C}$	1.32 V
V_{T0}	For power-loss calculations only ($T_{VJ} = 140^\circ\text{C}$)	0.8 V
r_T		0.68 mΩ
V_{GT}	$V_D = 6 \text{ V}; T_{VJ} = 25^\circ\text{C}$	2 V
	$T_{VJ} = -40^\circ\text{C}$	3 V
I_{GT}	$V_D = 6 \text{ V}; T_{VJ} = 25^\circ\text{C}$	150 mA
	$T_{VJ} = -40^\circ\text{C}$	220 mA
V_{GD}	$T_{VJ} = T_{VJM}; V_D = 2/3 V_{DRM}$	0.25 V
I_{GD}	$T_{VJ} = T_{VJM}; V_D = 2/3 V_{DRM}$	10 mA
I_L	$T_{VJ} = 25^\circ\text{C}; t_p = 30 \mu\text{s}; V_D = 6 \text{ V}$ $I_G = 0.45 \text{ A}; di_G/dt = 0.45 \text{ A}/\mu\text{s}$	200 mA
I_H	$T_{VJ} = 25^\circ\text{C}; V_D = 6 \text{ V}; R_{GK} = \infty$	150 mA
t_{gd}	$T_{VJ} = 25^\circ\text{C}; V_D = 1/2 V_{DRM}$ $I_G = 1 \text{ A}; di_G/dt = 1 \text{ A}/\mu\text{s}$	2 μs
t_q	$T_{VJ} = T_{VJM}; I_T = 300 \text{ A}, t_p = 200 \mu\text{s}; -di/dt = 10 \text{ A}/\mu\text{s}$ typ. $V_R = 100 \text{ V}; dv/dt = 50 \text{ V}/\mu\text{s}; V_D = 2/3 V_{DRM}$	200 μs
Q_S	$T_{VJ} = 125^\circ\text{C}; I_T, I_F = 300 \text{ A}; -di/dt = 50 \text{ A}/\mu\text{s}$	760 μC
I_{RM}		275 A
R_{thJC}	per thyristor (diode); DC current per module	0.12 K/W
R_{thJK}	per thyristor (diode); DC current per module	0.06 K/W
	other values see Fig. 8/9	0.16 K/W
		0.08 K/W
d_s	Creeping distance on surface	12.7 mm
d_A	Creepage distance in air	9.6 mm
a	Maximum allowable acceleration	50 m/s ²

Optional accessories for modules

Keyed Gate/Cathode twin plugs with wire length = 350 mm, gate = yellow, cathode = red

Type ZY 180 L (L = Left for pin pair 4/5)

UL 758, style 1385,

Type ZY 180 R (R = Right for pin pair 6/7)

CSA class 5851, guide 460-1-1

Dimensions in mm (1 mm = 0.0394")

MCC

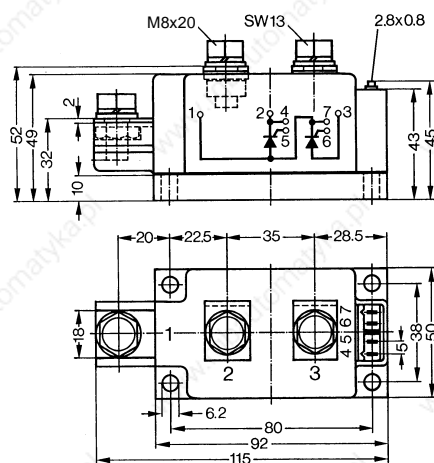

MCD

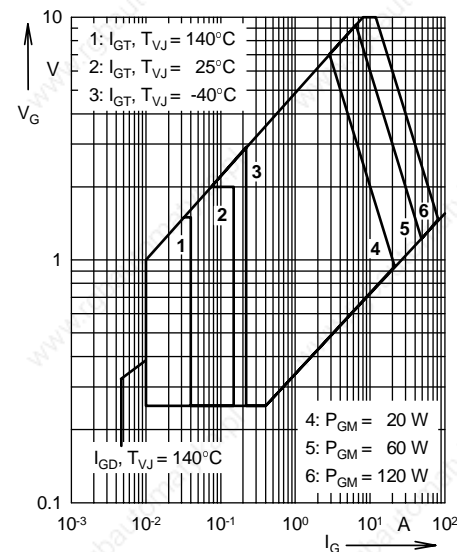
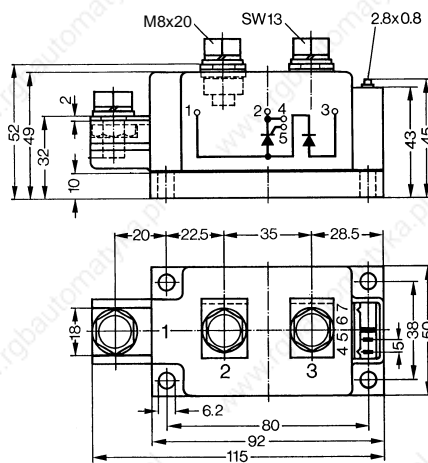

Fig. 1 Gate trigger characteristics

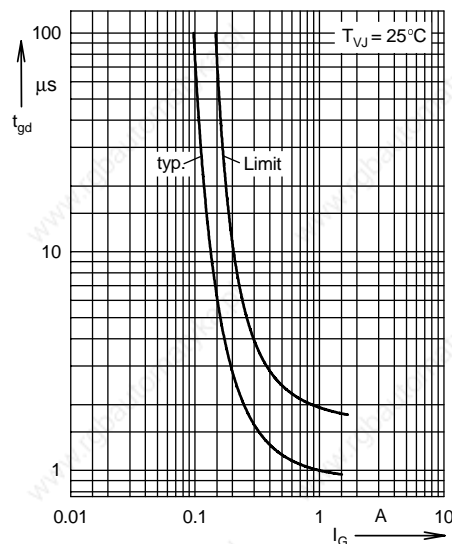

Fig. 2 Gate trigger delay time

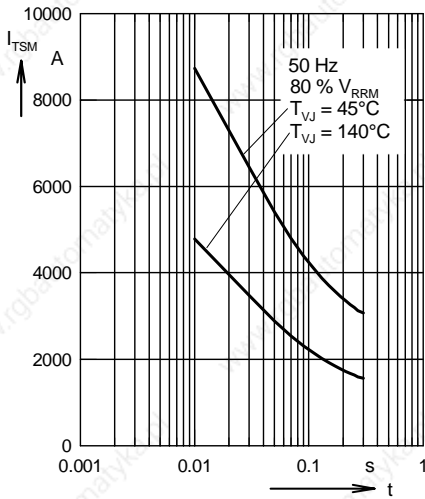

Fig. 3 Surge overload current
 I_{TSM} , I_{FSM} : Crest value, t: duration

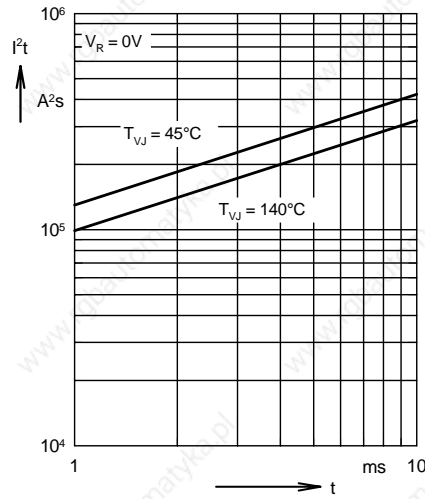

Fig. 4 I^2t versus time (1-10 ms)

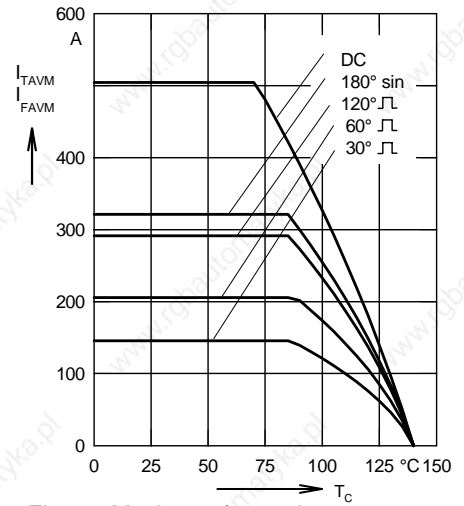

Fig. 4a Maximum forward current at case temperature

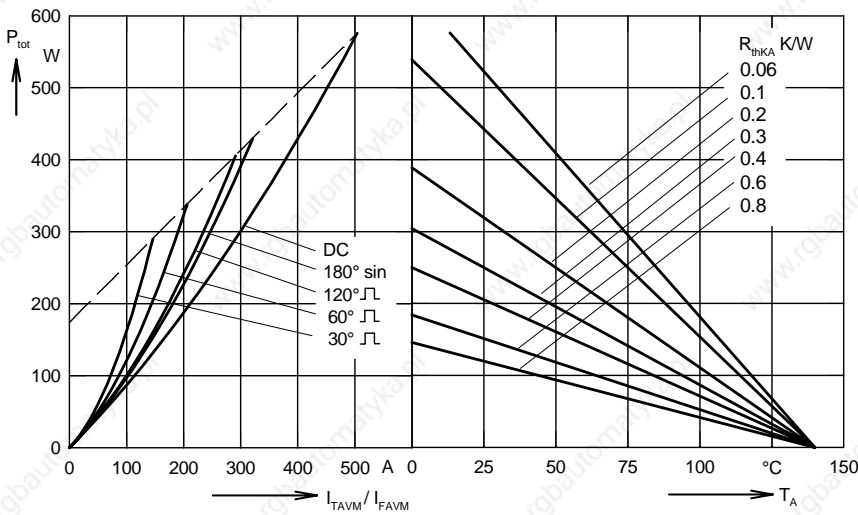

Fig. 5 Power dissipation versus on-state current and ambient temperature (per thyristor or diode)

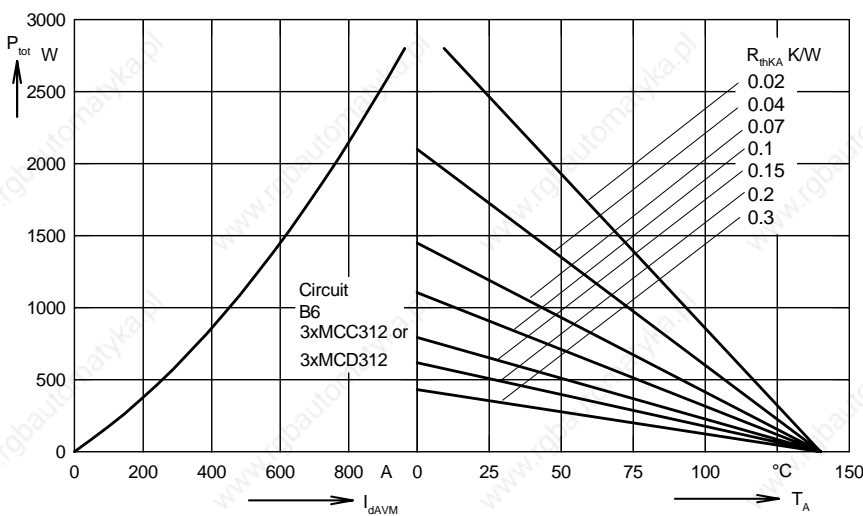

Fig. 6 Three phase rectifier bridge: Power dissipation versus direct output current and ambient temperature

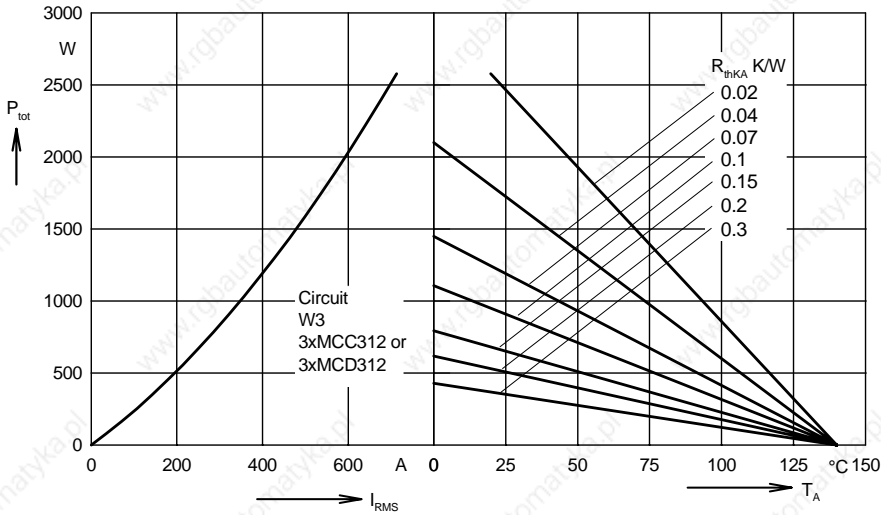

Fig. 7 Three phase AC-controller:
Power dissipation versus RMS
output current and ambient
temperature

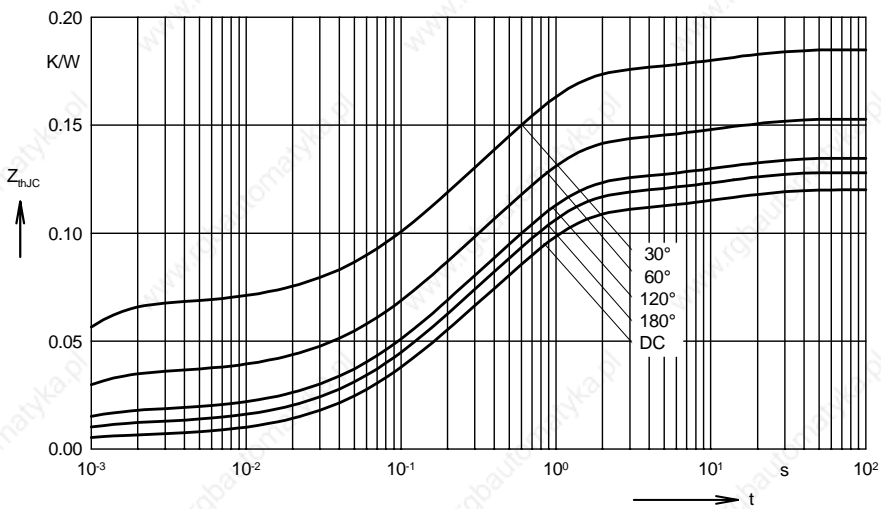

Fig. 8 Transient thermal impedance
junction to case (per thyristor or
diode)

R_{thJC} for various conduction angles d:

d	R_{thJC} (K/W)
DC	0.120
180°	0.128
120°	0.135
60°	0.153
30°	0.185

Constants for Z_{thJC} calculation:

i	R_{thi} (K/W)	t_i (s)
1	0.0058	0.00054
2	0.031	0.098
3	0.072	0.54
4	0.0112	12

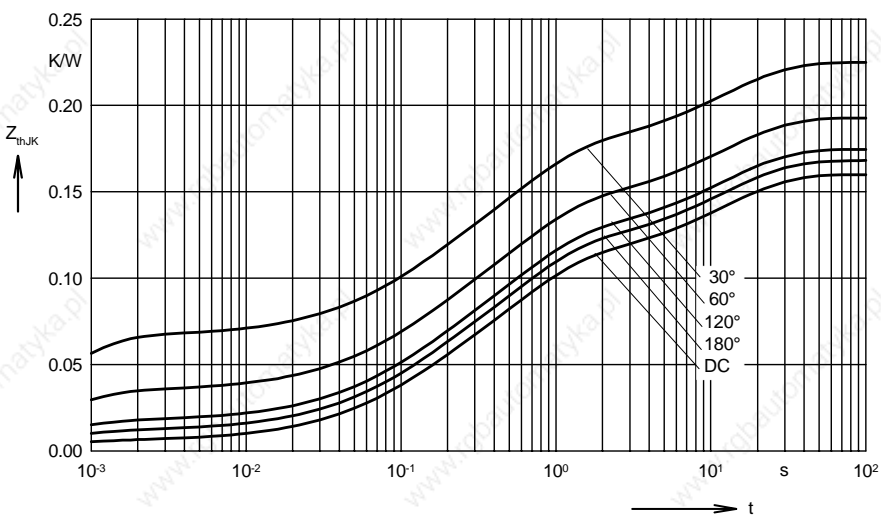

Fig. 9 Transient thermal impedance
junction to heatsink (per thyristor
or diode)

R_{thJK} for various conduction angles d:

d	R_{thJK} (K/W)
DC	0.160
180°	0.168
120°	0.175
60°	0.193
30°	0.225

Constants for Z_{thJK} calculation:

i	R_{thi} (K/W)	t_i (s)
1	0.0058	0.00054
2	0.031	0.098
3	0.072	0.54
4	0.0112	12
5	0.04	12

High Power Single Thyristor Module

$I_{TRMS} = 750 \text{ A}$
 $I_{TAV} = 464 \text{ A}$
 $V_{RRM} = 2000-2200 \text{ V}$

V_{RSM}	V_{RRM}	Type
V_{DSM}	V_{DRM}	
V	V	
2100	2000	MCO 450-20io1
2300	2200	MCO 450-22io1

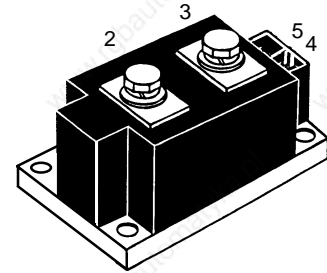
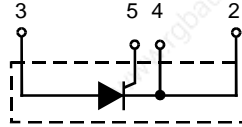

Symbol	Test Conditions	Maximum Ratings	
I_{TRMS}	$T_{VJ} = T_{VJM}$	750 A	
I_{TAV}	$T_C = 85^\circ\text{C}; 180^\circ \text{ sine}$	464 A	
I_{TSM}	$T_{VJ} = 45^\circ\text{C}$ $V_R = 0$	$t = 10 \text{ ms (50 Hz)}$ $t = 8.3 \text{ ms (60 Hz)}$	15000 A 16000 A
	$T_{VJ} = T_{VJM}$ $V_R = 0$	$t = 10 \text{ ms (50 Hz)}$ $t = 8.3 \text{ ms (60 Hz)}$	13000 A 14400 A
I^2t	$T_{VJ} = 45^\circ\text{C}$ $V_R = 0$	$t = 10 \text{ ms (50 Hz)}$ $t = 8.3 \text{ ms (60 Hz)}$	1125000 A ² s 1062000 A ² s
	$T_{VJ} = T_{VJM}$ $V_R = 0$	$t = 10 \text{ ms (50 Hz)}$ $t = 8.3 \text{ ms (60 Hz)}$	845000 A ² s 813000 A ² s
$(di/dt)_{cr}$	$T_{VJ} = T_{VJM}$ repetitive, $f = 50 \text{ Hz}, t_p = 200 \mu\text{s}$ $V_D = 2/3 V_{DRM}$	$I_T = 960 \text{ A}$	100 A/ μs
	$I_G = 1 \text{ A}$, non repetitive, $di_G/dt = 1 \text{ A}/\mu\text{s}$	$I_T = I_{TAVM}$	500 A/ μs
$(dv/dt)_{cr}$	$T_{VJ} = T_{VJM}; V_{DR} = 2/3 V_{DRM}$ $R_{GK} = \infty$; method 1 (linear voltage rise)		1000 V/ μs
P_{GM}	$T_{VJ} = T_{VJM}$ $I_T = I_{TAVM}$	$t_p = 30 \mu\text{s}$ $t_p = 500 \mu\text{s}$	120 W 60 W
P_{GAV}			30 W
V_{RGM}			10 V
T_{VJ}			-40...130 °C
T_{VJM}			130 °C
T_{stg}			-40...125 °C
V_{ISOL}	50/60 Hz, RMS	$t = 1 \text{ min}$	3000 V~
	$I_{ISOL} \leq 1 \text{ mA}$	$t = 1 \text{ s}$	3600 V~
M_d	Mounting torque (M6)		4.5-7/40-62 Nm/lb.in.
	Terminal connection torque (M8)		11-13/97-115 Nm/lb.in.
Weight	Typical including screws		650 g

Features

- Direct copper bonded Al_2O_3 -ceramic with copper base plate
- Planar passivated chips
- Isolation voltage 3600 V~
- UL applied
- Keyed gate/cathode twin pins

Applications

- Motor control, soft starter
- Power converter
- Heat and temperature control for industrial furnaces and chemical processes
- Lighting control
- Solid state switches

Advantages

- Improved temperature and power cycling
- Reduced protection circuits

Data according to IEC 60747 refer to a single thyristor/diode unless otherwise stated. IXYS reserves the right to change limits, test conditions and dimensions

Symbol	Test Conditions	Characteristic Values	
I_{RRM}	$T_{VJ} = T_{VJM}; V_R = V_{RRM}$	40	mA
V_T	$I_T = 600 \text{ A}; T_{VJ} = 25^\circ\text{C}$	1.15	V
V_{T0}	For power-loss calculations only ($T_{VJ} = T_{VJM}$)	0.77	V
r_T		0.42	m Ω
V_{GT}	$V_D = 6 \text{ V}; T_{VJ} = 25^\circ\text{C}$	2	V
	$T_{VJ} = -40^\circ\text{C}$	3	V
I_{GT}	$V_D = 6 \text{ V}; T_{VJ} = 25^\circ\text{C}$	300	mA
	$T_{VJ} = -40^\circ\text{C}$	400	mA
V_{GD}	$T_{VJ} = T_{VJM}; V_D = 2/3 V_{DRM}$	0.25	V
I_{GD}	$T_{VJ} = T_{VJM}; V_D = 2/3 V_{DRM}$	10	mA
I_L	$T_{VJ} = 25^\circ\text{C}; V_D = 6 \text{ V}; t_p = 30 \mu\text{s}$ $di_G/dt = 1 \text{ A}/\mu\text{s}; I_G = 1 \text{ A}$	400	mA
I_H	$T_{VJ} = 25^\circ\text{C}; V_D = 6 \text{ V}; R_{GK} = \infty$	300	mA
t_{gd}	$T_{VJ} = 25^\circ\text{C}; V_D = 1/2 V_{DRM}$ $di_G/dt = 1 \text{ A}/\mu\text{s}; I_G = 1 \text{ A}$	2	μs
t_q	$T_{VJ} = T_{VJM}; V_R = 100 \text{ V}; V_D = 2/3 V_{DRM}; t_p = 200 \mu\text{s}$ $dv/dt = 50 \text{ V}/\mu\text{s}; I_T = 500 \text{ A}; -di/dt = 10 \text{ A}/\mu\text{s}$	typ. 350	μs
R_{thJC}	DC current	0.072	K/W
R_{thJK}	DC current	0.096	K/W
d_s	Creep distance on surface	12.7	mm
d_A	Strike distance in air	9.6	mm
a	Maximum allowable acceleration	50	m/s ²

Optional accessories for modules

Keyed Gate/Cathode twin plugs with wire length = 350 mm, gate = yellow, cathode = red

Type **ZY 180 L** (L = Left for pin pair 4/5) $\left\{ \begin{array}{l} \text{UL 758, style 1385, File E 38136,} \\ \text{CSA class 5851, guide 460-1-1, appl. 41234} \end{array} \right.$

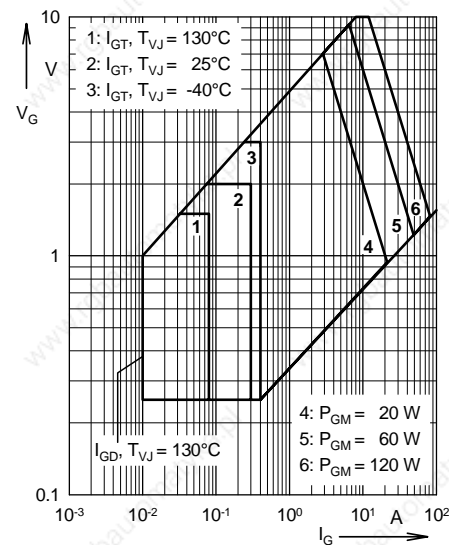

Fig. 1 Gate trigger characteristics

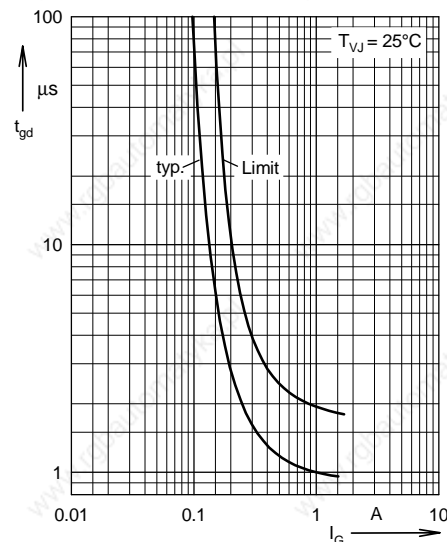
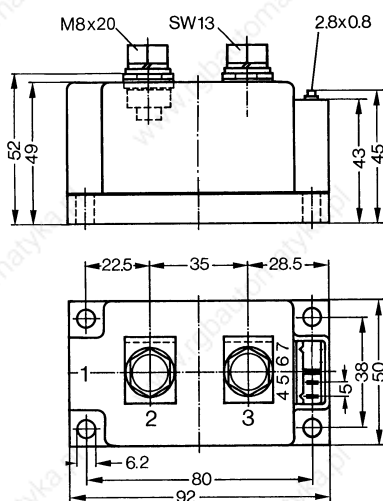

Fig. 2 Gate trigger delay time

Dimensions in mm (1 mm = 0.0394")



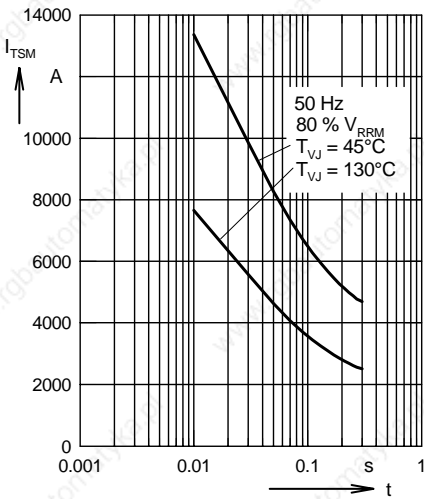

Fig. 3 Surge overload current
 I_{TSM} : Crest value, t : duration

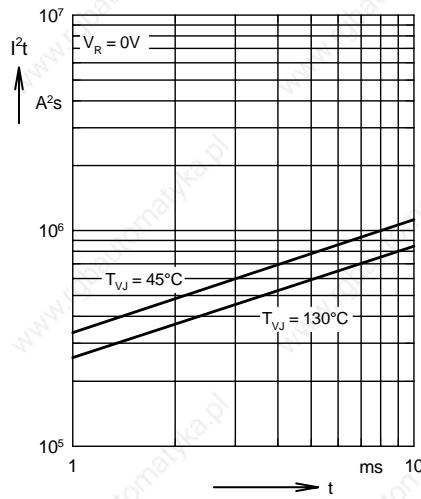

Fig. 4 I^2t versus time (1-10 ms)

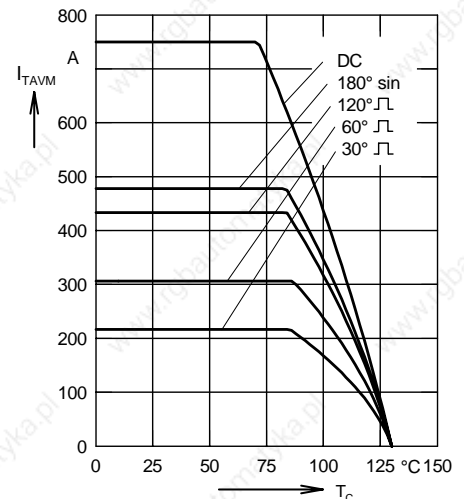

Fig. 5 Maximum forward current at case temperature

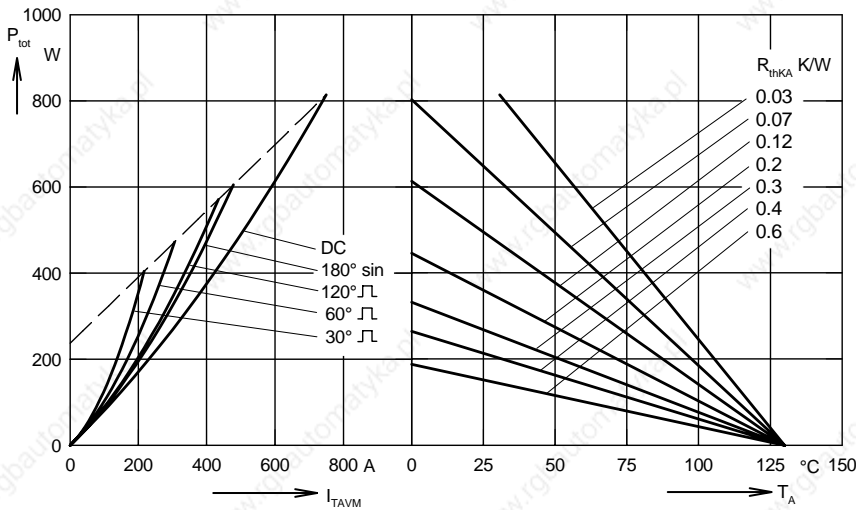

Fig. 6 Power dissipation versus on-state current and ambient temperature

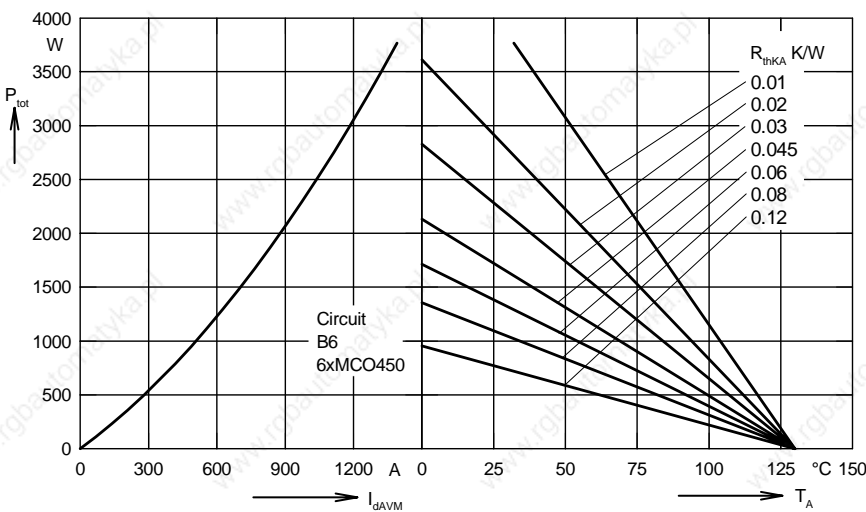

Fig. 7 Three phase rectifier bridge:
 Power dissipation versus direct output current and ambient temperature

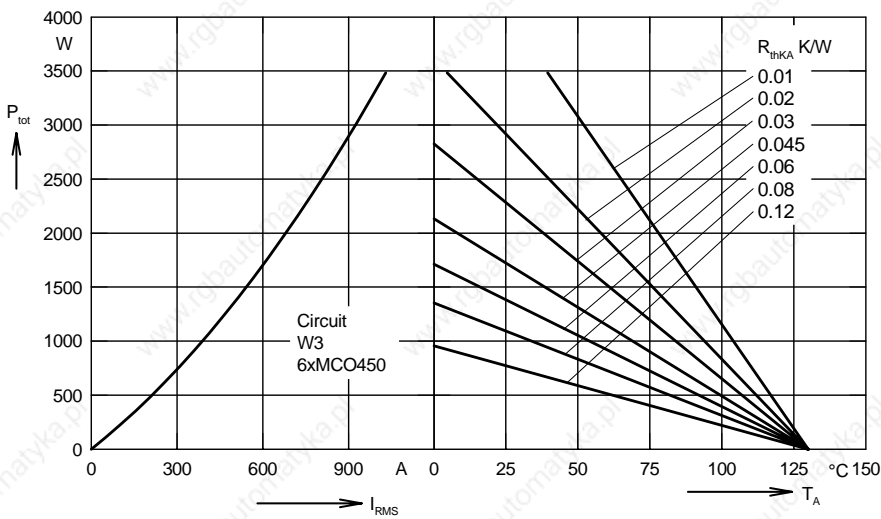

Fig. 8 Three phase AC-controller: Power dissipation versus RMS output current and ambient temperature

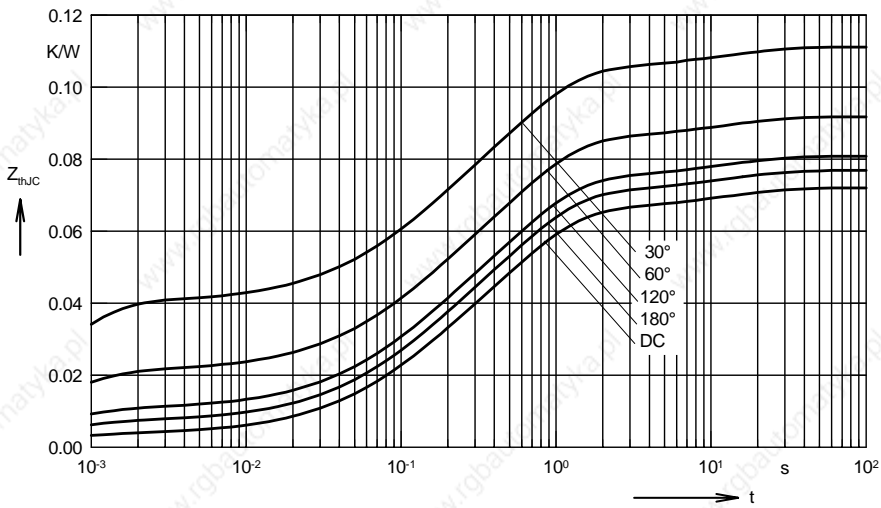

Fig. 9 Transient thermal impedance junction to case

R_{thJC} for various conduction angles d:

d	R_{thJC} (K/W)
DC	0.072
180°	0.0768
120°	0.081
60°	0.092
30°	0.111

Constants for Z_{thJC} calculation:

i	R_{thi} (K/W)	t_i (s)
1	0.0035	0.0054
2	0.0186	0.098
3	0.0432	0.54
4	0.0067	12

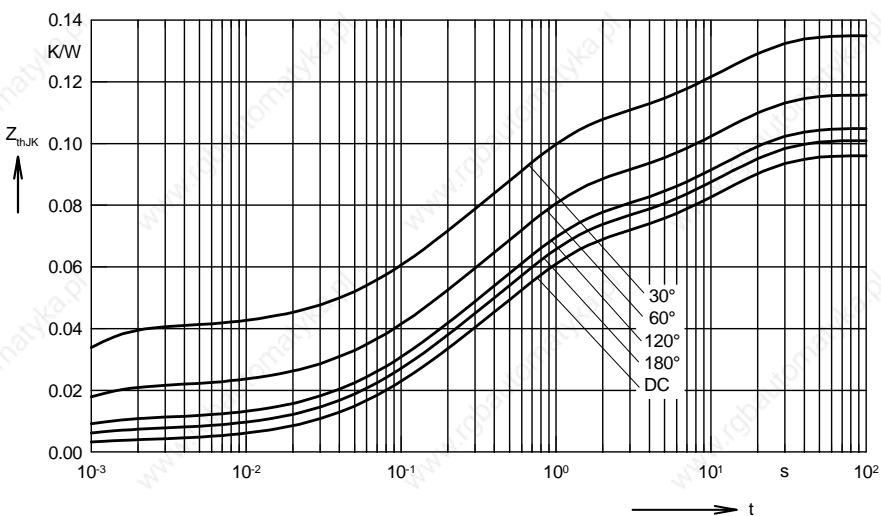

Fig.10 Transient thermal impedance junction to heatsink

R_{thJK} for various conduction angles d:

d	R_{thJK} (K/W)
DC	0.096
180°	0.1
120°	0.105
60°	0.116
30°	0.135

Constants for Z_{thJK} calculation:

i	R_{thi} (K/W)	t_i (s)
1	0.0035	0.0054
2	0.0186	0.098
3	0.0432	0.54
4	0.0067	12
5	0.024	12

High Power Thyristor Modules

$I_{TRMS} = 880 \text{ A}$
 $I_{T(AV)M} = 560 \text{ A}$
 $V_{RRM} = 1200-1800 \text{ V}$

V_{RSM} V_{DSM} V	V_{RRM} V_{DRM} V	Type
1300	1200	MCO 500-12io1
1500	1400	MCO 500-14io1
1700	1600	MCO 500-16io1
1900	1800	MCO 500-18io1

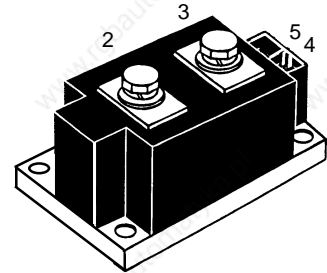
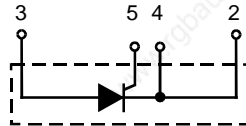

Symbol	Test Conditions	Maximum Ratings	
I_{TRMS}	$T_{VJ} = T_{VJM}$	880 A	
$I_{T(AV)M}$	$T_C = 85^\circ\text{C}; 180^\circ \text{ sine}$	560 A	
I_{TSM}	$T_{VJ} = 45^\circ\text{C}$ $V_R = 0$	$t = 10 \text{ ms (50 Hz)}$ $t = 8.3 \text{ ms (60 Hz)}$	17000 A 16000 A
	$T_{VJ} = T_{VJM}$ $V_R = 0$	$t = 10 \text{ ms (50 Hz)}$ $t = 8.3 \text{ ms (60 Hz)}$	13000 A 14400 A
I^2t	$T_{VJ} = 45^\circ\text{C}$ $V_R = 0$	$t = 10 \text{ ms (50 Hz)}$ $t = 8.3 \text{ ms (60 Hz)}$	1445000 A^2s 1062000 A^2s
	$T_{VJ} = T_{VJM}$ $V_R = 0$	$t = 10 \text{ ms (50 Hz)}$ $t = 8.3 \text{ ms (60 Hz)}$	845000 A^2s 813000 A^2s
$(di/dt)_{cr}$	$T_{VJ} = T_{VJM}$ $f = 50 \text{ Hz}, t_p = 200 \mu\text{s}$ $V_D = 2/3 V_{DRM}$	repetitive, $I_T = 960 \text{ A}$	100 $A/\mu\text{s}$
	$I_G = 1 \text{ A}$ $di_G/dt = 1 \text{ A}/\mu\text{s}$	non repetitive, $I_T = I_{T(AV)M}$	500 $A/\mu\text{s}$
$(dv/dt)_{cr}$	$T_{VJ} = T_{VJM}; V_{DR} = 2/3 V_{DRM}$ $R_{GK} = \infty; \text{method 1 (linear voltage rise)}$		1000 $V/\mu\text{s}$
P_{GM}	$T_{VJ} = T_{VJM}$ $I_T = I_{T(AV)M}$	$t_p = 30 \mu\text{s}$ $t_p = 500 \mu\text{s}$	120 W 60 W
P_{GAV}			30 W
V_{RGM}			10 V
T_{VJ}			-40...140 $^\circ\text{C}$
T_{VJM}			140 $^\circ\text{C}$
T_{stg}			-40...125 $^\circ\text{C}$
V_{ISOL}	50/60 Hz, RMS	$t = 1 \text{ min}$	3000 V~
	$I_{ISOL} \leq 1 \text{ mA}$	$t = 1 \text{ s}$	3600 V~
M_d	Mounting torque (M6)		4.5-7/40-62 Nm/lb.in.
	Terminal connection torque (M8)		11-13/97-115 Nm/lb.in.
Weight	Typical including screws		650 g

Features

- International standard package
- Direct copper bonded Al_2O_3 -ceramic with copper base plate
- Planar passivated chips
- Isolation voltage 3600 V~
- UL registered E 72873
- Keyed gate/cathode twin pins

Applications

- Motor control, softstarter
- Power converter
- Heat and temperature control for industrial furnaces and chemical processes
- Lighting control
- Solid state switches

Advantages

- Simple mounting
- Improved temperature and power cycling
- Reduced protection circuits

Data according to IEC 60747 refer to a single thyristor/diode unless otherwise stated. IXYS reserves the right to change limits, test conditions and dimensions

Symbol	Test Conditions	Characteristic Values	
I_{RRM}	$T_{VJ} = T_{VJM}; V_R = V_{RRM}$	40	mA
V_T	$I_T = 1200 \text{ A}; T_{VJ} = 25^\circ\text{C}$	1.3	V
V_{T0}	For power-loss calculations only ($T_{VJ} = T_{VJM}$)	0.8	V
r_T		0.38	m Ω
V_{GT}	$V_D = 6 \text{ V}; T_{VJ} = 25^\circ\text{C}$	2	V
	$T_{VJ} = -40^\circ\text{C}$	3	V
I_{GT}	$V_D = 6 \text{ V}; T_{VJ} = 25^\circ\text{C}$	300	mA
	$T_{VJ} = -40^\circ\text{C}$	400	mA
V_{GD}	$T_{VJ} = T_{VJM}; V_D = 2/3 V_{DRM}$	0.25	V
I_{GD}	$T_{VJ} = T_{VJM}; V_D = 2/3 V_{DRM}$	10	mA
I_L	$T_{VJ} = 25^\circ\text{C}; V_D = 6 \text{ V}; t_p = 30 \mu\text{s}$ $di_G/dt = 1 \text{ A}/\mu\text{s}; I_G = 1 \text{ A}$	400	mA
I_H	$T_{VJ} = 25^\circ\text{C}; V_D = 6 \text{ V}; R_{GK} = \infty$	300	mA
t_{gd}	$T_{VJ} = 25^\circ\text{C}; V_D = 1/2 V_{DRM}$ $di_G/dt = 1 \text{ A}/\mu\text{s}; I_G = 1 \text{ A}$	2	μs
t_q	$T_{VJ} = T_{VJM}; V_R = 100 \text{ V}; V_D = 2/3 V_{DRM}; t_p = 200 \mu\text{s}$ $dv/dt = 50 \text{ V}/\mu\text{s}; I_T = 500 \text{ A}; -di/dt = 10 \text{ A}/\mu\text{s}$	typ. 350	μs
R_{thJC}	DC current	0.072	K/W
R_{thJK}	DC current	0.096	K/W
d_s	Creeping distance on surface	12.7	mm
d_A	Creepage distance in air	9.6	mm
a	Maximum allowable acceleration	50	m/s ²

Optional accessories for modules

Keyed Gate/Cathode twin plugs with wire length = 350 mm, gate = yellow, cathode = red

Type **ZY 180 L** (L = Left for pin pair 4/5) $\left\{ \begin{array}{l} \text{UL 758, style 1385,} \\ \text{CSA class 5851, guide 460-1-1} \end{array} \right.$

Dimensions in mm (1 mm = 0.0394")

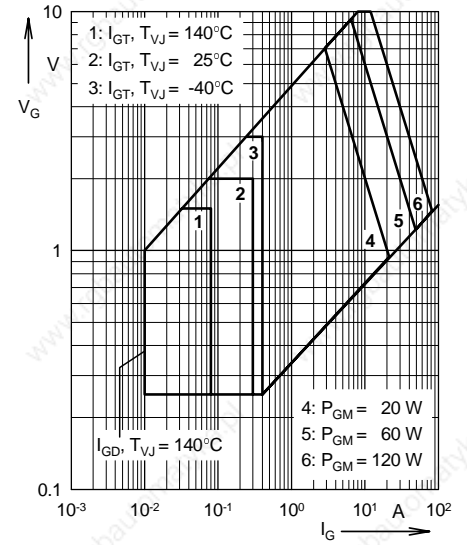
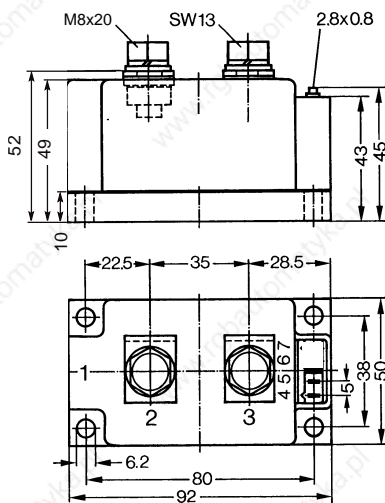

Fig. 1 Gate trigger characteristics

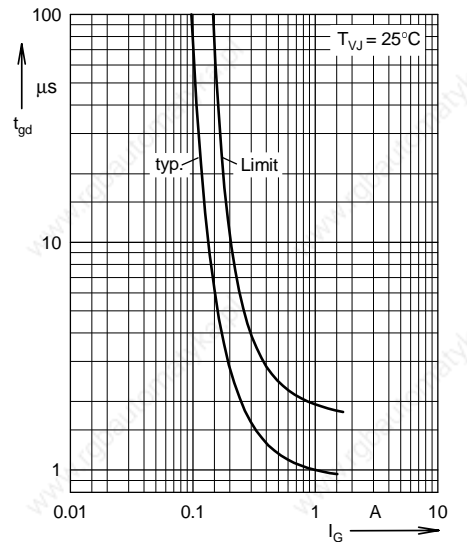

Fig. 2 Gate trigger delay time

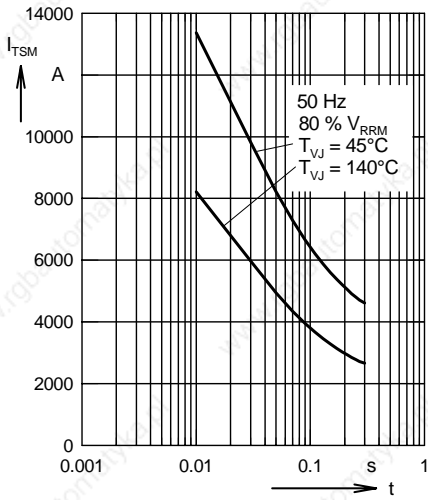

Fig. 3 Surge overload current
 I_{TSM} , I_{FSM} : Crest value, t : duration

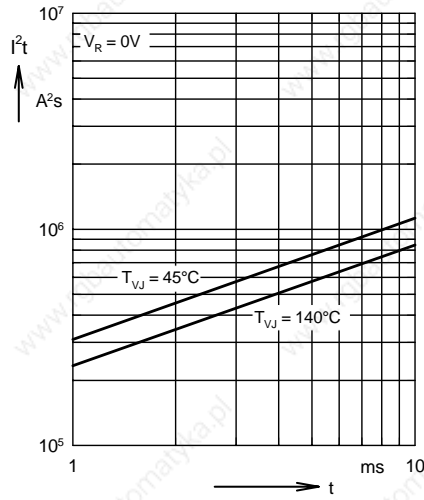

Fig. 4 I^2t versus time (1-10 ms)

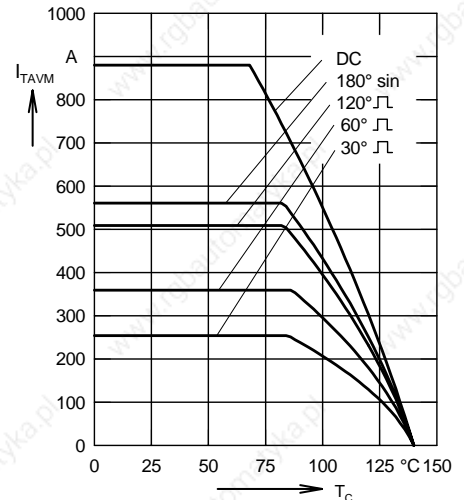

Fig. 5 Maximum forward current at case temperature

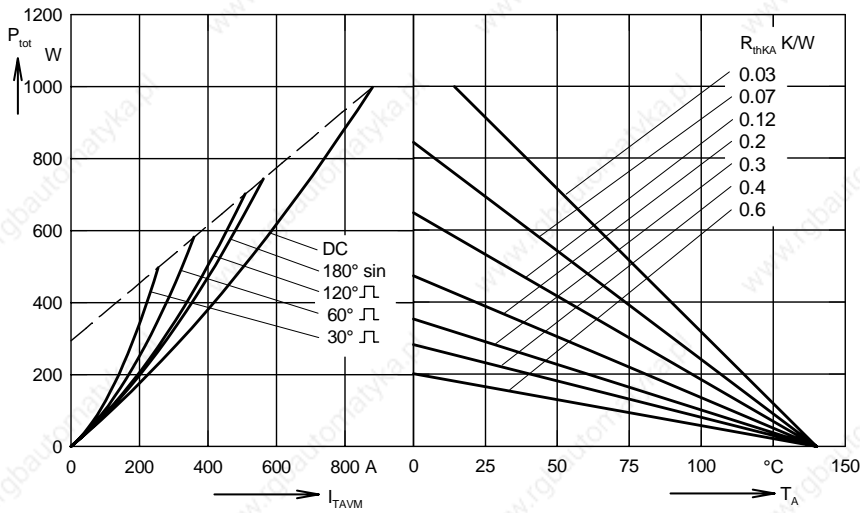

Fig. 6 Power dissipation versus on-state current and ambient temperature

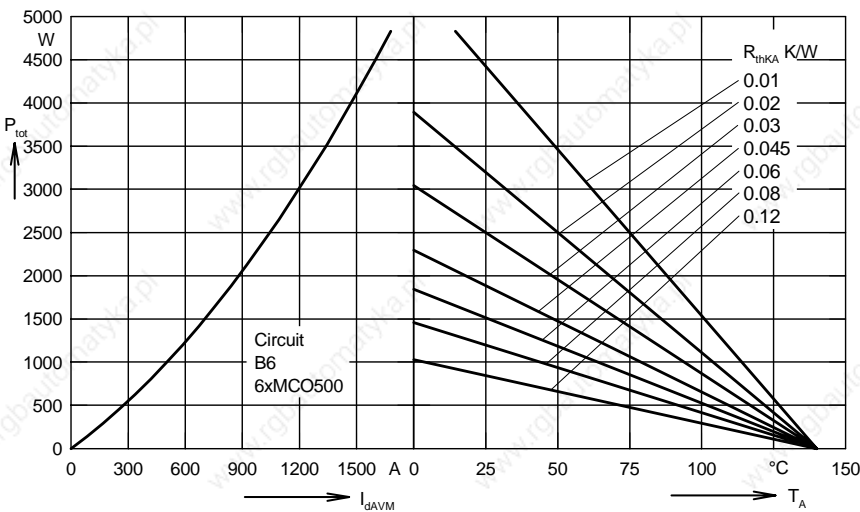

Fig. 7 Three phase rectifier bridge:
 Power dissipation versus direct output current and ambient temperature

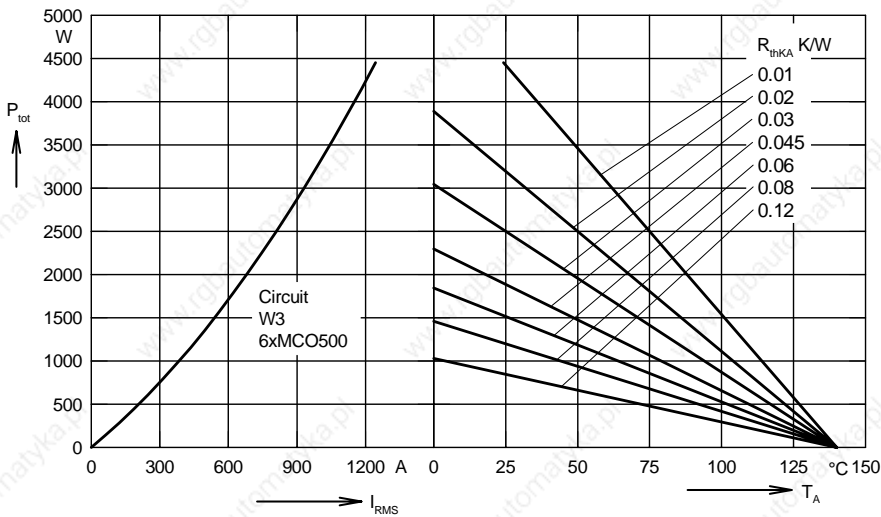

Fig. 8 Three phase AC-controller: Power dissipation versus RMS output current and ambient temperature

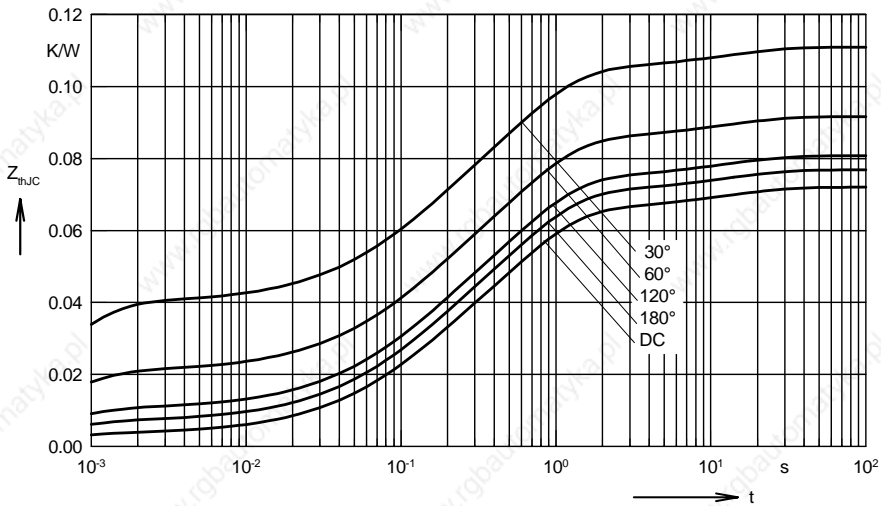

Fig. 9 Transient thermal impedance junction to case (per thyristor)

R_{thJC} for various conduction angles d:

d	R_{thJC} (K/W)
DC	0.072
180°	0.0768
120°	0.081
60°	0.092
30°	0.111

Constants for Z_{thJC} calculation:

i	R_{thi} (K/W)	t_i (s)
1	0.0035	0.0054
2	0.0186	0.098
3	0.0432	0.54
4	0.0067	12

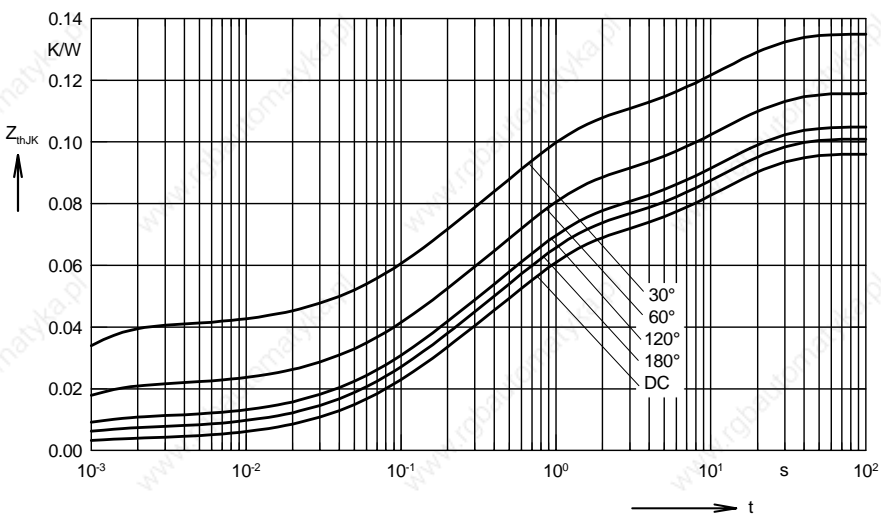

Fig.10 Transient thermal impedance junction to heatsink (per thyristor)

R_{thJK} for various conduction angles d:

d	R_{thJK} (K/W)
DC	0.096
180°	0.1
120°	0.105
60°	0.116
30°	0.135

Constants for Z_{thJK} calculation:

i	R_{thi} (K/W)	t_i (s)
1	0.0035	0.0054
2	0.0186	0.098
3	0.0432	0.54
4	0.0067	12
5	0.024	12

High Power Single Thyristor Module

$I_{TRMS} = 928 \text{ A}$
 $I_{TAV} = 600 \text{ A}$
 $V_{RRM} = 2000\text{-}2200 \text{ V}$

Preliminary data

V_{RSM} V_{DSM} V	V_{RRM} V_{DRM} V	Type
2100	2000	MCO 600-20io1
2300	2200	MCO 600-22io1

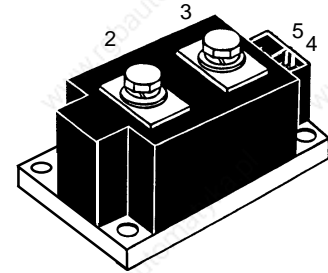
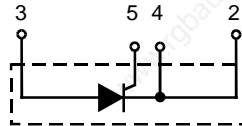

Symbol	Test Conditions	Maximum Ratings	
I_{TRMS} I_{TAV}	$T_{VJ} = T_{VJM}$ $T_C = 85^\circ\text{C}; 180^\circ \text{ sine}$	928 A 600 A	
I_{TSM}	$T_{VJ} = 45^\circ\text{C}$ $V_R = 0$	$t = 10 \text{ ms (50 Hz)}$ $t = 8.3 \text{ ms (60 Hz)}$	15000 A 16000 A
	$T_{VJ} = T_{VJM}$ $V_R = 0$	$t = 10 \text{ ms (50 Hz)}$ $t = 8.3 \text{ ms (60 Hz)}$	13000 A 14400 A
I^2t	$T_{VJ} = 45^\circ\text{C}$ $V_R = 0$	$t = 10 \text{ ms (50 Hz)}$ $t = 8.3 \text{ ms (60 Hz)}$	1125000 A ² s 1062000 A ² s
	$T_{VJ} = T_{VJM}$ $V_R = 0$	$t = 10 \text{ ms (50 Hz)}$ $t = 8.3 \text{ ms (60 Hz)}$	845000 A ² s 813000 A ² s
$(di/dt)_{cr}$	$T_{VJ} = T_{VJM}$ $f = 50 \text{ Hz}, t_p = 200 \mu\text{s}$ $V_D = 2/3 V_{DRM}$ $I_G = 1 \text{ A},$ $di_G/dt = 1 \text{ A}/\mu\text{s}$	repetitive, $I_T = 960 \text{ A}$ non repetitive, $I_T = I_{TAVM}$	100 A/ μs 500 A/ μs
	$T_{VJ} = T_{VJM}; V_{DR} = 2/3 V_{DRM}$ $R_{GK} = \infty;$ method 1 (linear voltage rise)		1000 V/ μs
P_{GM}	$T_{VJ} = T_{VJM}$ $I_T = I_{TAVM}$	$t_p = 30 \mu\text{s}$ $t_p = 500 \mu\text{s}$	120 W 60 W
P_{GAV} V_{RGM}			30 W 10 V
T_{VJ} T_{VJM} T_{stg}			-40...140 °C 140 °C -40...125 °C
V_{ISOL}	50/60 Hz, RMS	$t = 1 \text{ min}$	3000 V~
	$I_{ISOL} \leq 1 \text{ mA}$	$t = 1 \text{ s}$	3600 V~
M_d	Mounting torque (M6)		4.5-7/40-62 Nm/lb.in.
	Terminal connection torque (M8)		11-13/97-115 Nm/lb.in.
Weight	Typical including screws		650 g

Features

- Direct copper bonded Al_2O_3 -ceramic with copper base plate
- Planar passivated chips
- Isolation voltage 3600 V~
- UL applied
- Keyed gate/cathode twin pins

Applications

- Motor control, softstarter
- Power converter
- Heat and temperature control for industrial furnaces and chemical processes
- Lighting control
- Solid state switches

Advantages

- Improved temperature and power cycling
- Reduced protection circuits

Data according to IEC 60747 and refer to a single thyristor/diode unless otherwise stated. IXYS reserves the right to change limits, test conditions and dimensions

Symbol	Test Conditions	Characteristic Values	
I_{RRM}	$T_{VJ} = T_{VJM}; V_R = V_{RRM}$	60	mA
V_T	$I_T = 600 \text{ A}; T_{VJ} = 25^\circ\text{C}$	1.15	V
V_{T0}	For power-loss calculations only ($T_{VJ} = T_{VJM}$)	0.77	V
r_T		0.42	mΩ
V_{GT}	$V_D = 6 \text{ V}; T_{VJ} = 25^\circ\text{C}$	2	V
	$T_{VJ} = -40^\circ\text{C}$	3	V
I_{GT}	$V_D = 6 \text{ V}; T_{VJ} = 25^\circ\text{C}$	300	mA
	$T_{VJ} = -40^\circ\text{C}$	400	mA
V_{GD}	$T_{VJ} = T_{VJM}; V_D = 2/3 V_{DRM}$	0.25	V
I_{GD}	$T_{VJ} = T_{VJM}; V_D = 2/3 V_{DRM}$	10	mA
I_L	$T_{VJ} = 25^\circ\text{C}; V_D = 6 \text{ V}; t_p = 30 \mu\text{s}$ $di_G/dt = 1 \text{ A}/\mu\text{s}; I_G = 1 \text{ A}$	400	mA
I_H	$T_{VJ} = 25^\circ\text{C}; V_D = 6 \text{ V}; R_{GK} = \infty$	300	mA
t_{gd}	$T_{VJ} = 25^\circ\text{C}; V_D = 1/2 V_{DRM}$ $di_G/dt = 1 \text{ A}/\mu\text{s}; I_G = 1 \text{ A}$	2	μs
t_q	$T_{VJ} = T_{VJM}; V_R = 100 \text{ V}; V_D = 2/3 V_{DRM}; t_p = 200 \mu\text{s}$ $dv/dt = 50 \text{ V}/\mu\text{s}; I_T = 500 \text{ A}; -di/dt = 10 \text{ A}/\mu\text{s}$	typ. 350	μs
R_{thJC}	DC current	0.065	K/W
R_{thJK}	DC current	0.085	K/W
d_s	Creep distance on surface	12.7	mm
d_A	Strike distance in air	9.6	mm
a	Maximum allowable acceleration	50	m/s ²

Optional accessories for modules

Keyed Gate/Cathode twin plugs with wire length = 350 mm, gate = yellow, cathode = red

Type **ZY 180 L** (L = Left for pin pair 4/5) $\left\{ \begin{array}{l} \text{UL 758, style 1385, File E 38136,} \\ \text{CSA class 5851, guide 460-1-1, appl. 41234} \end{array} \right.$

Dimensions in mm (1 mm = 0.0394")

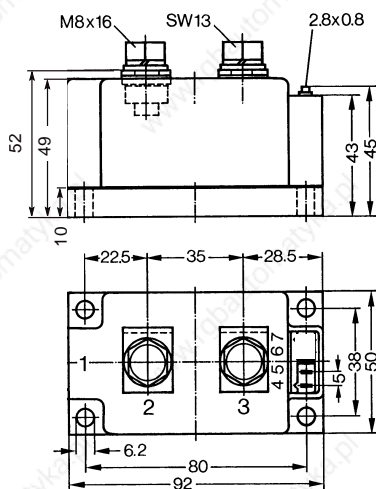

Peak reverse recovery current versus $-di/dt$

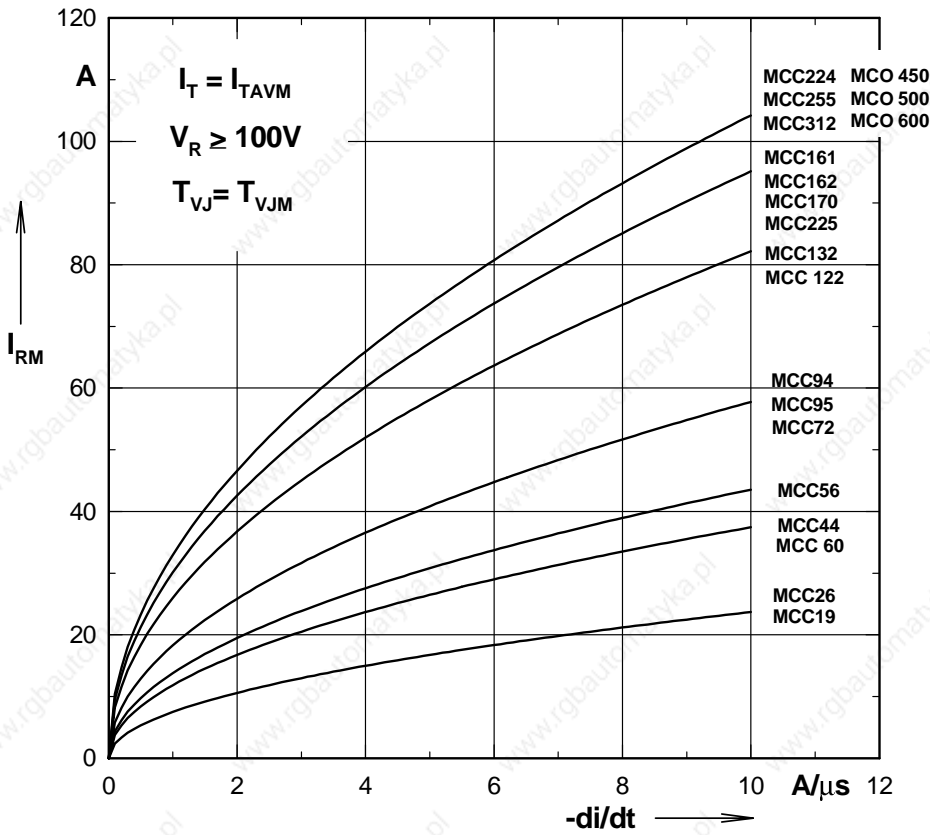

Recommended RC snubber network against hole storage effect overvoltage

Type	Supply Voltage V_{VRMS}		
	$\leq 250 V$	$\leq 400 V$	$\leq 575 V$
MCC/MCD/MDD 19/26	R = 68 Ω /6 W C = 0.22 μF	R = 68 Ω /6 W C = 0.22 μF	R = 100 Ω /10 W C = 0.1 μF
MCC/MCD/MDD 44/56/60/72/94/95	R = 33 Ω /10 W C = 0.22 μF	R = 47 Ω /10 W C = 0.22 μF	R = 68 Ω /10 W C = 0.1 μF
MCC/MCD/MDD/MCO/MDO 122/132/142/161/162/170/ 172/220/225/250/255/310/ 312/450/500/600	R = 33 Ω /25 W C = 0.47 μF	R = 33 Ω /25 W C = 0.47 μF	R = 47 Ω /25 W C = 0.1 μF

Conditions

$f = 40 - 60 \text{ Hz}$
 Short circuit voltage 4-6 %
 Voltage safety factor 2.5

