

# AS-i 3.0 PROFIBUS Gateway in Stainless Steel

## *User manual*



AS-i 3.0 specification

Subject to modifications without notice.

Generally, this manual refers to products without mentioning existing patents, utility models, or trademarks.

The absence of any such references does not indicate that a product is patent-free.

© Bihl+Wiedemann GmbH

Flosswoerthstr. 41

D-68199 Mannheim

# Table of contents

## AS-i 3.0 PROFIBUS Gateway in Stainless Steel

1	Symbol catalog .....	8
1.1	Abbreviations .....	8
2	General .....	9
2.1	Product information .....	9
2.1.1	AS-i 3.0 PROFIBUS Gateway in Stainless Steel .....	9
2.2	New Generation of AS-i Gateways with ethernet diagnostics interface ...	10
2.3	AS-i specification 3.0 .....	10
2.4	Conformity statement .....	11
2.5	Certification according to DIN EN ISO 9001 : 2000 .....	11
2.6	Hazardous Location Information .....	11
2.6.1	Products marked "CL I, DIV 2, GP A, B, C, D" .....	11
3	Safety .....	13
3.1	Intended use .....	13
3.2	General safety information .....	13
3.2.1	Disposal .....	13
4	Spezifikationen .....	14
4.1	Technical data .....	14
4.1.1	Data sheet .....	14
5	Installation - PROFIBUS single/double master .....	17
5.1	Dimensions .....	17
5.2	Connections .....	17
5.3	Installing in the control cabinet .....	17
5.4	Removing .....	18
5.5	Electrical Connection .....	18
5.6	Startup .....	19
5.6.1	Switching to advanced display mode .....	19
5.6.2	Setting the PROFIBUS-DP address 14 .....	19
5.7	Connecting AS-i Slaves .....	20
5.8	Error tracing .....	21
5.8.1	Faulty slaves .....	21

5.8.2	Error display (last error) .....	21
5.9	Quick setup .....	22
5.10	Addressing .....	23
5.10.1	Program slave 0 to address 6 .....	23
<b>6</b>	<b>Installation - PROFIBUS Basic Master .....</b>	<b>24</b>
6.1	Dimensions .....	24
6.2	Electrical Connection .....	24
6.3	Startup .....	25
6.3.1	Setting the PROFIBUS-DP address .....	25
6.3.2	Switching to configuration mode .....	25
6.3.3	Error display (last error) .....	26
6.3.4	Connecting AS-i Slaves .....	26
6.3.5	Store AS-i configuration .....	27
6.3.5.1	Addressing>Delete slave address 5 .....	27
6.3.5.2	Programming slave 0 to address 4 .....	28
6.3.5.3	Error tracing\Incorrect slaves (one error) .....	29
6.3.5.4	Faulty slaves (multiple errors) .....	29
<b>7</b>	<b>Electrical connection .....</b>	<b>30</b>
7.1	Overview of terminals, indicators and operating elements .....	30
7.1.1	BWU1567, BWU1775, BWU1599, BW1653, BWU1773, BWU1891, BWU1568, BWU1776, BWU1600, BW1654, BWU1774, BWU1569, BWU1777, BWU1601, BW1655 .....	30
7.1.2	BWU1702, BWU1703, BWU2234 .....	31
7.1.3	BWU2544, BWU2545, BWU2546 .....	32
7.1.4	BWU1746 .....	33
7.2	AS-i bus connection .....	34
7.3	Information about the device types .....	34
7.4	AS-i and power supply terminal assignments .....	34
7.4.1	Electrical connection BWU1567, BWU1775, BWU1599, BW1653, BWU1773, BWU2544 .....	35
7.4.2	Electrical connection: BWU1702 .....	36
7.4.3	Electrical connection BWU1891 .....	37
7.4.4	Electrical connection BWU1568, BWU1776, BWU1600, BW1654, BWU1703, BWU1774, BWU2545 .....	38
7.4.5	Electrical connection BWU1569, BWU1777, BWU1601, BW1655, BWU2234, BWU2546 .....	39
7.4.6	Electrical connection BWU1746 .....	40
7.5	PROFIBUS interface .....	41
7.5.1	Terminating resistors on the PROFIBUS network .....	41
7.6	Diagnostics interface .....	42
7.6.1	BWU1567, BWU1775, BWU1599, BW1653, BWU1773, BWU1891, BWU1568, BWU1776, BWU1600, BW1654, BWU1774, BWU1569, BWU1777, BWU1601, BW1655 .....	42
7.6.2	BWU2544, BWU2545, BWU2546 .....	42
7.7	Chip card .....	42

7.7.1	Using the chip card .....	42
7.7.1.1	Card unformatted .....	43
7.7.1.2	Data not compatible .....	43
7.7.1.3	Card empty .....	43
7.7.1.4	Data compatible .....	43
7.7.1.5	Data in the device and on the chip card identical .....	44
7.7.1.6	Data in the device and on the chip card not identical .....	44
<b>7.8</b>	<b>Indicators and operating elements .....</b>	<b>45</b>
7.8.1	LED indicators – master .....	45
7.8.2	Buttons .....	46
<b>8</b>	<b>Operation in advanced display mode .....</b>	<b>47</b>
<b>9</b>	<b>PROFIBUS DP .....</b>	<b>48</b>
<b>9.1</b>	<b>DP Telegrams .....</b>	<b>48</b>
9.1.1	Diagnostics .....	48
9.1.1.1	Diagnostic description for BWU1567, BWU1568, BWU1569, BWU1599, BWU1600, BWU1601, BW1653, BW1654, BW1655, BWU1702, BWU1703, BWU1746, BWU1773, BWU1774, BWU1775, BWU1776, BWU1777, BWU1891, BWU223449 .....	52
9.1.1.2	Diagnostic description for BWU2544, BWU2545, BWU2546 .....	52
9.1.1.3	Parameters .....	53
9.1.2	Configuration DP/V0 (cyclic data) .....	56
9.1.2.1	Options .....	56
9.1.3	I/O Data .....	58
9.1.3.1	Process data .....	58
9.1.3.2	AS-i 16-bit data .....	60
9.1.3.3	Command interface .....	61
9.1.3.4	Safety Control/Status .....	62
<b>9.2</b>	<b>DP/V1 .....</b>	<b>63</b>
<b>9.3</b>	<b>Restrictions .....</b>	<b>63</b>
<b>10</b>	<b>Advanced Diagnostics for AS-i Masters .....</b>	<b>65</b>
10.1	List of corrupted AS-i Slaves (LCS) .....	65
10.2	Protocol analysis: Counters for corrupted data telegrams .....	65
10.3	Offline Phase for Configuration Errors .....	66
10.4	Functions of the AS-i Fault Detector .....	66
10.4.1	Duplicate address detection .....	66
10.4.2	Earth/Ground Fault Detector .....	66
10.4.3	Noise Detector .....	67
10.4.4	Over-voltage Detector .....	67
10.5	Functions of the new generation of AS-i Gateways .....	68
10.5.1	C-programmable Gateways .....	68
10.5.2	Interchangeable memory card .....	68
10.5.3	Earth fault monitor .....	68
10.5.4	Current can be read directly on the unit .....	69
10.5.5	Self-resetting fuses .....	70
10.5.6	AS-i Power24V capable .....	70
10.5.7	Ethernet diagnostics interface with web server .....	70
10.5.8	Transitionless operating mode changes .....	70

**Table of contents**

<b>11</b>	<b>System startup using AS-i Control Tools .....</b>	<b>72</b>
11.1	Windows software AS-i Control Tools .....	72
11.2	PROFIBUS DP Master Simulator.....	75
11.3	Serial PROFIBUS Master .....	76
11.4	Additional information .....	76
<b>12</b>	<b>Appendix: Example for startup on a Siemens S7 .....</b>	<b>77</b>
12.1	Hardware configuration .....	77
12.1.1	Electrical connection for AS-i .....	77
12.1.2	Electrical connection for PROFIBUS DP .....	78
12.2	<b>SIMATIC Step 7 Configuration .....</b>	<b>78</b>
12.2.1	Configuration of the Hardware .....	78
12.2.2	Insert AS-i 3.0 PROFIBUS Gateway in Stainless Steel.....	81
12.2.3	Configuring AS-i 3.0 PROFIBUS Gateway in Stainless Steel in-/output.....	84
12.2.4	AS-i 3.0 PROFIBUS Gateway in Stainless Steel parameters .....	87
12.2.4.1	General DP parameters.....	89
12.2.4.2	Device-specific parameters .....	89
12.2.4.3	Hex parameterizing.....	93
12.2.5	<b>SIMATIC Step7 blocks.....</b>	<b>93</b>
12.2.6	<b>Variable table VAT_ASI_IO .....</b>	<b>94</b>
12.2.6.1	AS-i flags byte 0, input bits 7 - 4 .....	96
12.2.6.2	AS-i flags byte 0, output bits 7 - 4 .....	96
12.2.7	System behavior on AS-i Config Error .....	98
<b>13</b>	<b>Codes Indicated by the Display .....</b>	<b>103</b>
13.1	Codes indicated by AS-i Gateway with standard function range .....	104
<b>14</b>	<b>Accessories .....</b>	<b>105</b>
<b>15</b>	<b>Glossary .....</b>	<b>107</b>
<b>16</b>	<b>Reference List .....</b>	<b>112</b>
16.1	Manual: "AS-i 3.0 Command Interface" .....	112
<b>17</b>	<b>Your opinion is important to us!.....</b>	<b>113</b>

## Conformity Statement

The AS-i 3.0 PROFIBUS Gateway in Stainless Steel has been developed and produced in accordance with the applicable european standards and directives. The conformity statement according to the EC EMC-, low voltage, and -machinery directive can be sent to by request.

Additional information can be found in the Bihl+Wiedemann GmbH basic catalogue or in the online catalogue in internet.

Subject to technical modifications.

## 1. Symbol catalog



### **Information!**

*This symbol indicates important information.*



### **Attention!**

*This symbol warns of a potential failure. Non-compliance may lead to interruptions of the device, the connected peripheral systems, or plant, potentially leading to total malfunctioning.*



### **Warning!**

*This symbol warns of an imminent danger. Non-compliance may lead to personal injuries that could be fatal or result in material damages and destruction.*

### 1.1 Abbreviations



### **Information!**

*Additional information can be found in section <Glossary>.*

**General**

**2. General**

**2.1 Product information**

This system manual applies to the following Bihl+Wiedemann GmbH equipment:

**2.1.1 AS-i 3.0 PROFIBUS Gateway in Stainless Steel**

Article no.	field bus interface	number of AS-i Masters	RS 232 diagnostic interface	Ethernet diagnostic interface	Recognition of duplicate addresses	Control II	Control III (option) <sup>1</sup>	Class 1 Div 2 certification	Power supply decoupling unit	LCD display (alpha numeric)	LED display (3-digit)
<b>BWU1567</b>	PROFIBUS	1	•	–	•	–	–	–	–	•	–
<b>BWU1775</b>											
<b>BWU1702</b>	PROFIBUS	1	–	–	•	–	–	–	–	•	–
<b>BWU2544</b>	PROFIBUS	1	–	•	•	–	•	–	–	•	–
<b>BWU1599</b>	PROFIBUS	1	•	–	•	•	•	–	–	•	–
<b>BW1653</b>	PROFIBUS	1	•	–	•	–	–	•	–	•	–
<b>BWU1773</b>	PROFIBUS	1	–	–	–	–	–	–	–	•	–
<b>BWU1891</b>	PROFIBUS	1	•	–	•	–	–	–	•	•	–
<b>BWU1568</b>	PROFIBUS	2	•	–	•	–	–	–	–	•	–
<b>BWU1776</b>											
<b>BWU1703</b>	PROFIBUS	2	–	–	•	–	–	–	–	•	–
<b>BWU2545</b>	PROFIBUS	2	–	•	•	–	•	–	–	•	–
<b>BWU1600</b>	PROFIBUS	2	•	–	•	•	–	–	–	•	–
<b>BW1654</b>	PROFIBUS	2	•	–	•	–	•	•	–	•	–
<b>BWU1774</b>	PROFIBUS	2	–	–	–	–	–	–	–	•	–
<b>BWU1569</b>	PROFIBUS	2	•	–	•	–	–	–	•	•	–
<b>BWU1777</b>											
<b>BWU2234</b>	PROFIBUS	2	–	–	•	–	–	–	•	•	–
<b>BWU2546</b>	PROFIBUS	2	–	•	•	–	•	–	•	•	–
<b>BWU1601</b>	PROFIBUS	2	–	–	•	•	–	–	•	•	–
<b>BW1655</b>	PROFIBUS	2	•	–	•	•	–	•	•	•	–
<b>BWU1746</b>	PROFIBUS	1	–	–	–	–	–	–	–	–	•

Tab. 2-1. Function range of "AS-i 3.0 PROFIBUS Gateway in Stainless Steel"

1. Activation art. no BW2582

The AS-i/PROFIBUS Gateways serve to connect AS-i systems to the superordinate PROFIBUS. The gateways act as a master for AS-i and as a slave on PROFIBUS.

The AS-i/PROFIBUS Gateways are designed to connect AS-i systems to an upper-level PROFIBUS network. The gateways act as a master for AS-i and as a slave on PROFIBUS.

All AS-i functions can be used cyclically as well as acyclically via PROFIBUS DP/ V1.

For the cyclical data transfer up to 32 bytes of I/O data can be transferred as binary data for one AS-i network. Additionally, analog signals and all available commands of the new AS-i specification can be transferred via the command channel through PROFIBUS.

On the serial PROFIBUS Master AS-i Control Tools can be used to monitor the AS-i data online via PROFIBUS DP/V1.

## 2.2 New Generation of AS-i Gateways with ethernet diagnostics interface

### The plus points of the new Gateway generation at a glance:

- Gateways now programmable in C
- Ethernet diagnostics interface for remote diagnostics
- Integrated web server: diagnostics for the Gateways and the AS-i circuits over Ethernet possible with no additional software
- GSD file for PROFIBUS and GSDML file for PROFINET already stored in the web server
- Earth fault monitor distinguishes between AS-i cable and sensor cable
- Current from both AS-i circuits in the "1 Gateway, 1 power supply for 2 AS-i circuits" version can now be read directly on the unit
- Self-resetting fuses in the "1 Gateway, 1 power supply for 2 AS-i circuits" version
- Device temperature display
- AS-i Power24V capable
- Interfaces for virtually every bus system and Ethernet solution



### **Information!**

See also section <Functions of the new generation of AS-i Gateways> for further information.

## 2.3 AS-i specification 3.0

The AS-i 3.0 devices already fulfil the AS-i specification 3.0.

The previous specifications (2.1 and 2.0) are supported as well.

### **Advanced Diagnostics**

Diagnostics, which go far beyond the standard diagnostics facilitate the simple detection of the occasionally occurring configuration errors and further irritations towards the AS-i communication. So in case of an error the down time of machines can be minimized or you can initiate preventive maintenance.

### Commissioning and monitoring

Commissioning, debugging and setting up of the AS-i parameters can also be accomplished with the use of push-buttons on the frontside of the gateway, the display and the LEDs. It is also possible to do the configuration with the software "AS-i Control Tools".

## 2.4 Conformity statement

The AS-i 3.0 PROFIBUS Gateway in Stainless Steel has been developed and manufactured in accordance with the applicable european standards and directives.



### **Information!**

*The corresponding conformity statement can be found at the very beginning of this system manual.*

## 2.5 Certification according to DIN EN ISO 9001 : 2000

The manufacturer of the product possesses a certified quality assurance system in accordance with ISO 9001.



### **Information!**

*The current certificate can be viewed in internet:  
<http://www.bihl-wiedemann.de>*

## 2.6 Hazardous Location Information

### 2.6.1 Products marked "CL I, DIV 2, GP A, B, C, D"

The following information applies when operating this equipment in hazardous locations:

Products marked "CL I, DIV 2, GP A, B, C, D" are suitable for use in Class I Division 2 Groups A, B, C, D, hazardous locations and nonhazardous locations only. Each product is supplied with markings on the rating nameplate indicating the hazardous location temperature code.

Combinations of equipment in your system are subject to investigation by the local authority having jurisdiction at the time of installation.



**Explosion hazard!**

- Do not disconnect equipment unless power has been removed or the area is known to be nonhazardous.
- Do not disconnect connections to this equipment unless power has been removed or the area is known to be nonhazardous. Secure any external connections that mate to this equipment by using screws, sliding latches, threaded connectors, or other means provided with this product.
- Only use the RS 232 connector if the area is nonhazardous.
- Substitution of components may impair suitability for Class I, Division 2.

*If this product contains batteries, they must only be changed in an area known to be nonhazardous.*

### 3. Safety

#### 3.1 Intended use



##### **Warning!**

*This symbol warns of a possible danger. The protection of operating personnel and the system against possible danger is not guaranteed if the control interface unit is not operated in accordance to its intended use.*

#### 3.2 General safety information



##### **Warning!**

*Safety and correct functioning of the device cannot be guaranteed if any operation other than described in this operation manual is performed. Connecting the equipment and conducting any maintenance work under power must exclusively be performed by appropriately qualified personnel. In case a failure cannot be eliminated, the device must be taken out of operation and inadvertently operation must be prevented. Repair work must be performed by the manufacturer only. Additions or modifications to the equipment are not permitted and will void the warranty.*



##### **Information!**

*The operator is responsible for the observation of local safety standards.*

#### 3.2.1 Disposal



##### **Information!**

*Electronic waste is hazardous waste. Please comply with all local ordinances when disposing this product!*

*The device does not contain batteries that need to be removed before disposing it.*

## Specifications

### 4. Specifications

#### 4.1 Technical data



#### Information!

The technical data are placed in the data sheet. Please view the current version on the web page: <http://www.bihl-wiedemann.de/englisch/index.html>.

#### 4.1.1 Data sheet

Article no.	BWU1567 BWU1568 BWU1569	BW1653 BW1654 BW1655 Class 1 Div. 2 (Group A, B, C & D, T-Code 4)	BWU1746	BWU1773 BWU1774 BWU1891	BWU2544 BWU2545 BWU2546
<b>Interface</b>					
PROFIBUS interface	IE 61 158 / IEC 61 784-1				
Baud rates	9,6 KBAud up to 12 000 KBAud, automatic recognition				
DP functions	imaging of the AS-i slaves as I/O Data of the PROFIBUS complete diagnosis and configuration via the DP Master				
Card slot	-				Chip card for storage of configuration data
<b>AS-i</b>					
Cycle time	150µs · (number of slaves + 2)				
Operating voltage	AS-i voltage 30V DC				
<b>Anzeige</b>					
7-Segment display	-		AS-i slave addresses, error codes	-	
LCD	menu, AS-i indication of slave addresses, error messages in plain text		-	menu, AS-i indication of slave addresses, error messages in plain text	
LED power	power ON				
LED PROFIBUS	PROFIBUS Master recognized				
LED config error	configuration error				
LED U AS-i	AS-i voltage o.k.				
LED AS-i active	AS-i normal operation active				
LED prg enable	automatic address programming enabled				
LED prj mode	master is in configuration mode				
<b>Environment</b>					
Applied standards	EN 61 000-6-2 EN 61 000-6-4				
Housing	Stainless Steel				
Operating temperature	0°C ... +55°C				
Storage temperature	-25°C ... +85°C				
Protection category DIN EN 60 529	IP20				
Maximum tolerable shock and vibration stress	according EN 61 131-2				
Voltage of insulation	≥ 500V				
Dimensions (W / H / D in mm)	75 / 120 / 83	42 / 120 / 40	75 / 120 / 83	75 / 120 / 93	
Weight	460 g	300 g	460 g		

Article no.	Number AS-i Master	Duplicate addresses inspector	AS-i Detector	Programming and diagnosis interface	Safety Monitor integrated	Preprocessing	AS-i Spec.
BWU1567	1 Master	yes	yes	RS232	optional	no	3.0
BWU1568	2 Master	yes	yes	RS232	optional	no	3.0
BWU1569	2 Master out of 1 power supply	yes	yes	RS232	optional	no	3.0
BW1653	1 Master	yes	yes	RS232	no	no	3.0
BW1654	2 Master	yes	yes	RS232	no	no	3.0
BW1655	2 Master out of 1 power supply	yes	yes	RS232	no	no	3.0
BWU1746	1 Master	no	yes	no	no	no	3.0
BWU1773	1 Master	no	yes	no	no	no	3.0
BWU1774	2 Master	no	yes	no	no	no	3.0
BWU1891	1 Master	yes	yes	RS232	no	no	3.0
BWU2544	1 Master	yes	yes	Ethernet	optional	Control III	3.0
BWU2545	2 Master	yes	yes	Ethernet	optional	Control III	3.0
BWU2546	2 Master	yes	yes	Ethernet	optional	Control III	3.0

Bemessungsbetriebsstrom				
Article no.	Master power supply, max. 200mA out of AS-i circuit 1 (ca. 70mA ... 200mA), max. 200mA out of AS-i circuit 2 (ca. 70mA ... 200mA); in sum max. 270mA	Master power supply, ca. 200mA out of AS-i circuit 1 ca. 70mA out of AS-i circuit 2	Version „1 gateway, 1 power supply for 2 AS-i networks“, approx. 250mA (PELV voltage)	Master power supply, ca. 200mA out of AS-i circuit
BWU1567	–	–	–	●
BWU1568	●	–	–	–
BWU1569	–	–	●	–
BW1653	–	–	–	●
BW1654	–	●	–	–
BW1655	–	–	●	–
BWU1746	–	–	–	●
BWU1773	–	–	–	●
BWU1774	–	●	–	–
BWU1891	–	–	–	●
BWU2544	–	–	–	●
BWU2545	●	–	–	–
BWU2546	–	–	●	–

**Specifications**

Article no.	BWU1567	BWU1568	BWU1569	BW1653 BW1654	BW1655	BWU1746 BWU1773 BWU1774 BWU1891 BWU2544	BWU2545	BWU2546
Redundant power supply out of AS-i: all fundamental functions of the device remain available even in case of power failure in one of the two AS-i networks	-	•	-	-	-	-	•	-
Current measurement of the AS-i circuits	-	-	-	-	-	-	-	•
Self-resetting adjustable fuses	-	-	-	-	-	-	-	•
AS-i earth fault monitor distinguishes between AS-i cable and sensor cable	-	-	-	-	-	-	-	•
In version 1 gateway, 1 power supply for 2 AS-i circuits: only 1 Gateway + 1 AS-i power supply for 2 AS-i networks	-	-	•	-	•	-	-	•

<sup>1</sup> (Recognition of duplicate AS-i addresses) except

BWU1746, BWU1773, BWU1774

<sup>2</sup> (Optional programmable in C) and

<sup>3</sup> (GSD file integrated)

BWU2544, BWU2545, BWU2546

<sup>4</sup> AS-i Power24V

The gateways BWU2544, BWU2545 and BWU2546 are AS-i Power24V capable. That means, that all devices can be operated directly on a 24V (PELV) power supply.

The gateway BWU2546 is optimized with integrated data coupling coils and adjustable self-resetting fuses for safe use also of powerful 24V power supplies.

The gateways BWU2544 and BWU2545 will add in Power24V-operation a BW1943 power supply decoupling unit.

AS-i 3.0 from ID no. 12003 (see lateral label)

BWU1567, BWU1568, BWU1569, BWU1653, BWU1654, BWU1655, BWU1773, BWU1774



Currently supplied devices correspond as standard AS-i 3.0.

## 5. Installation - PROFIBUS single/double master

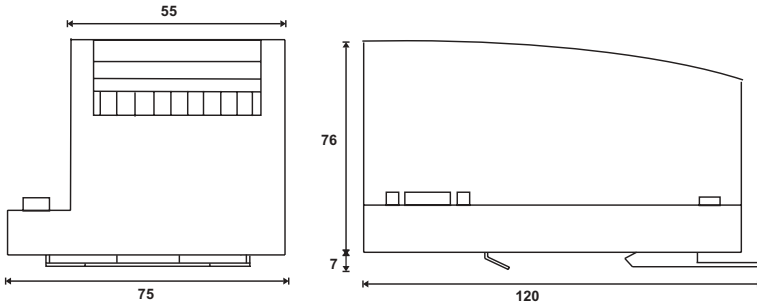
### 5.1 Dimensions

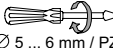

### 5.2 Connections

 Ø 5 ... 6 mm / PZ2	0,8 Nm 7 LB.IN
 10	2 x (0,5 ... 1,5) mm <sup>2</sup>
 10	2 x (0,5 ... 1,5) mm <sup>2</sup>
AWG	2 x 24 ...12

### 5.3 Installing in the control cabinet

The AS-i/Gateway is installed in the control cabinet on 35mm DIN rails per DIN EN 50 022.



#### **Information!**

*The enclosure of the AS-i/Gateway is made of stainless steel. The unit is also suitable for exposed wall mounting.*

To install, place the unit on the upper edge of the DIN rail and then snap in the lower edge.

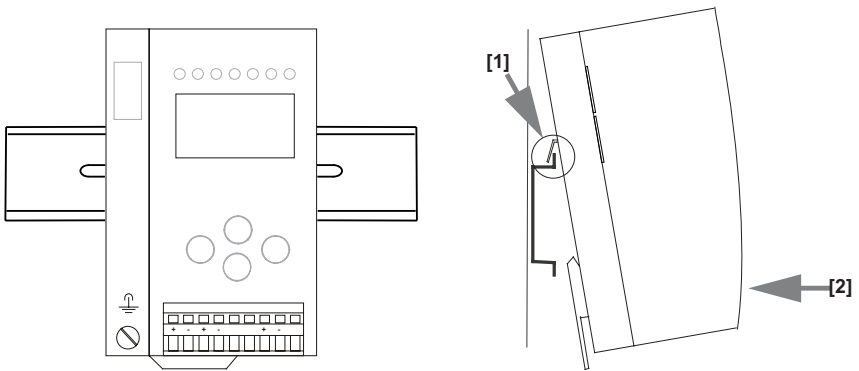

#### 5.4 Removing

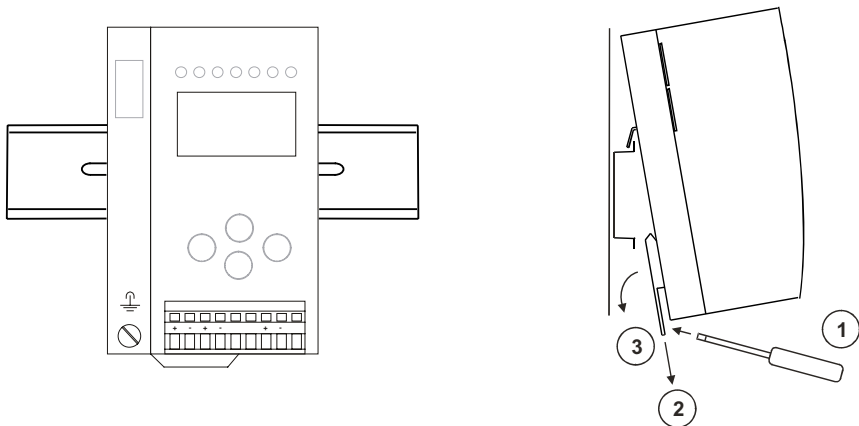

To remove, press the holding clamps [2] down using a screwdriver [1], press the unit firmly against the upper rail guide and lift out.

#### 5.5 Electrical Connection



**Information!**

Electrical connections are described in section <Electrical connection>.



**Information!**

See also section <Operation in advanced display mode> for further information.

## 5.6 Startup

### 5.6.1 Switching to advanced display mode

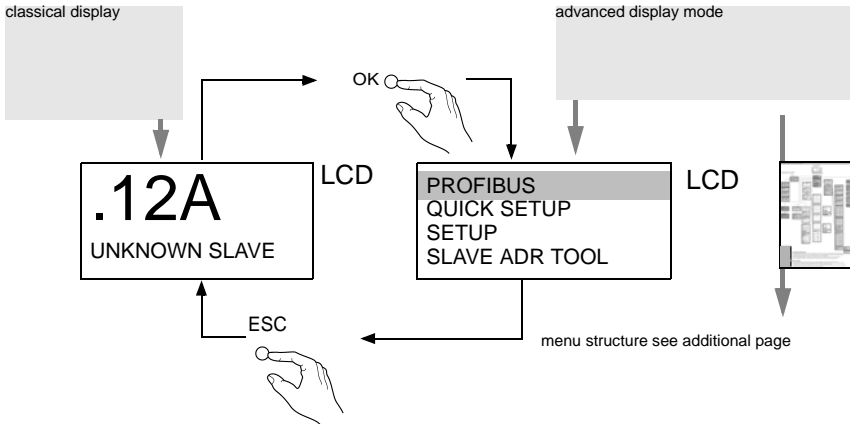

### 5.6.2 Setting the PROFIBUS-DP address 14

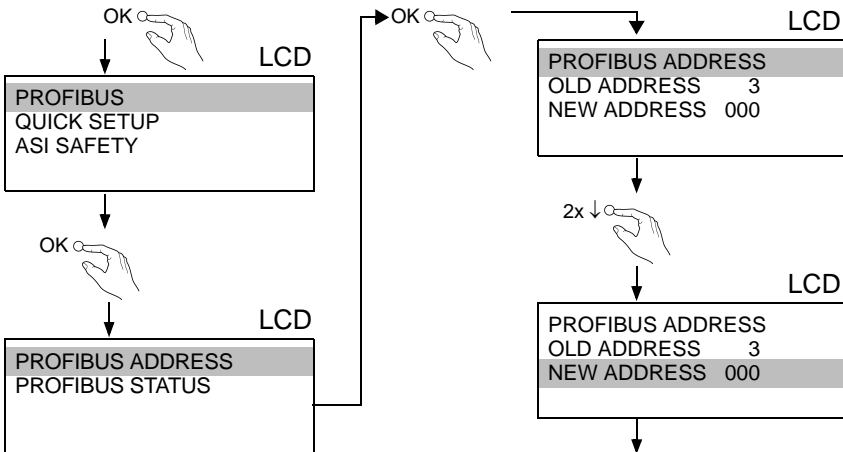

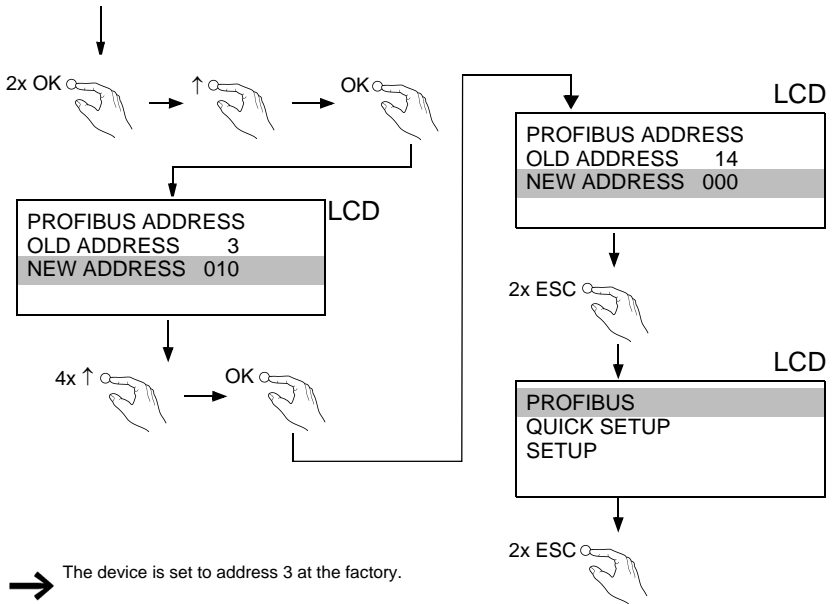

### 5.7 Connecting AS-i Slaves

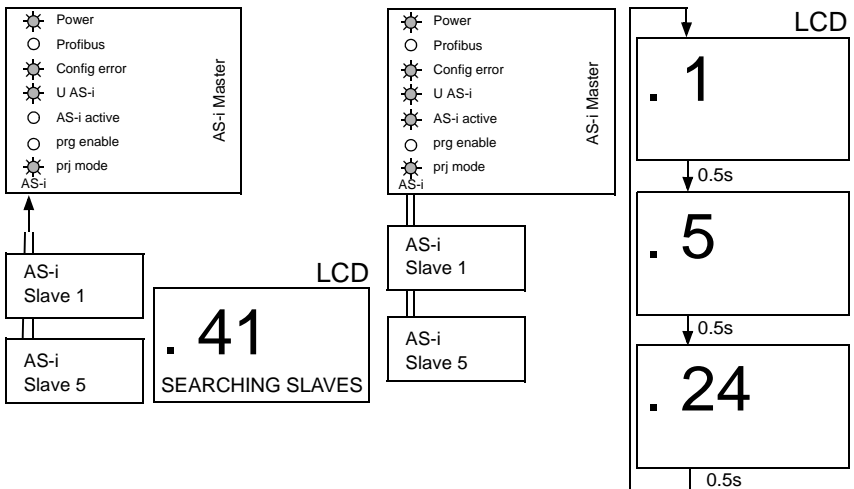

## 5.8 Error tracing

### 5.8.1 Faulty slaves

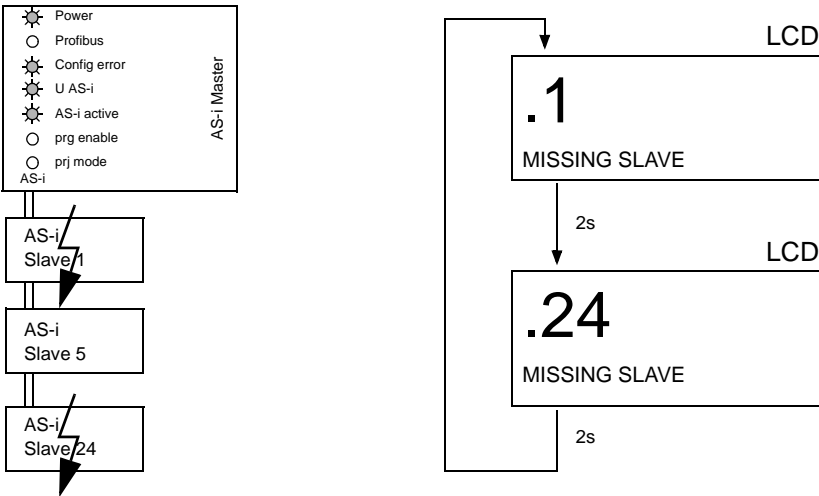

### 5.8.2 Error display (last error)

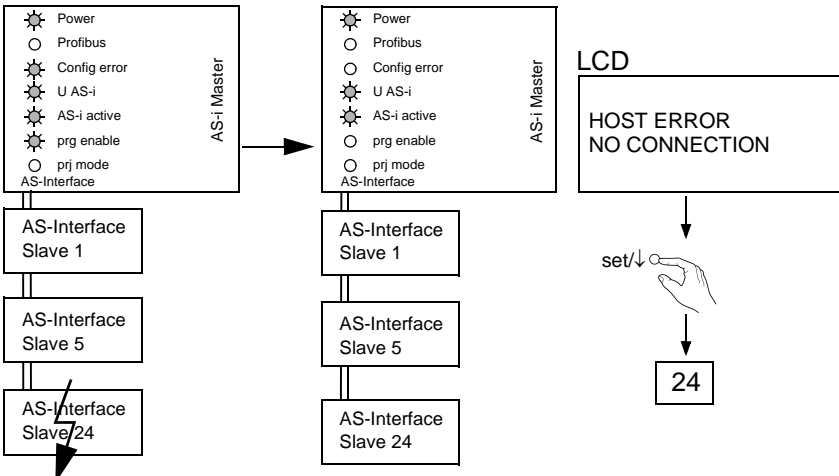

5.9 Quick setup

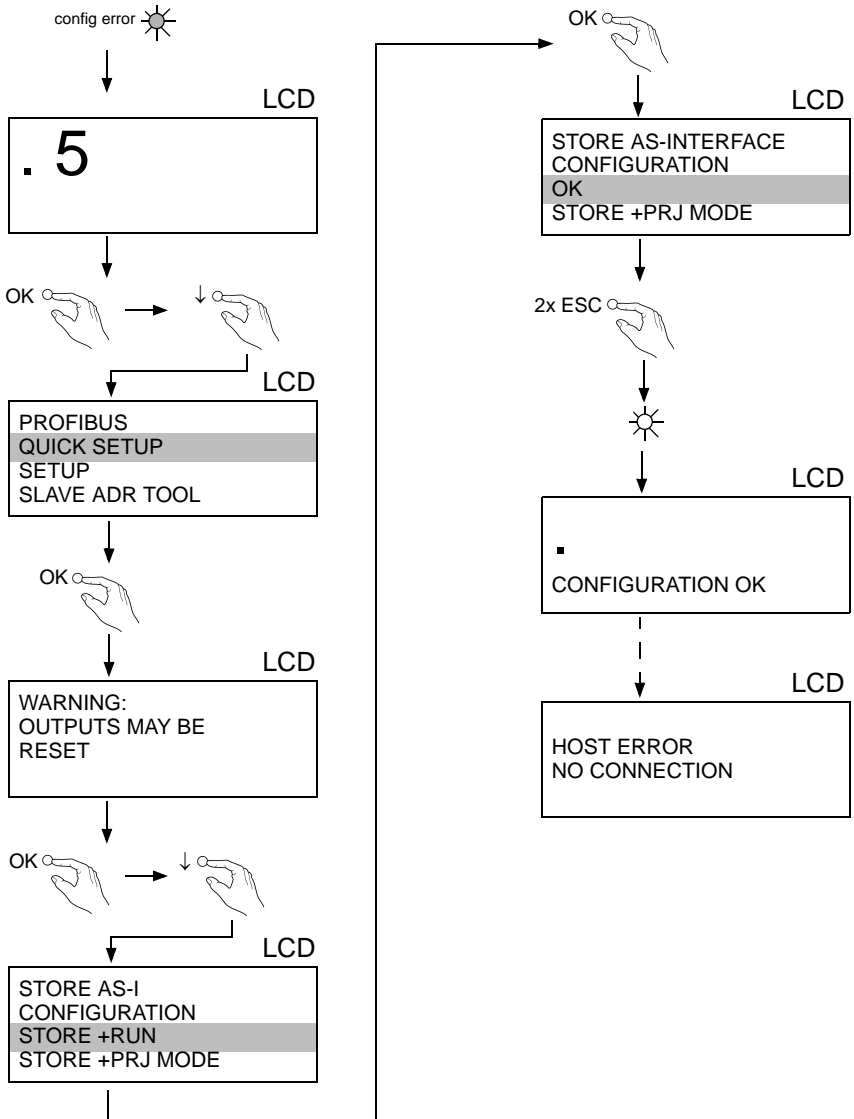

Issue date: 28.3.2012

5.10 Addressing

5.10.1 Program slave 0 to address 6

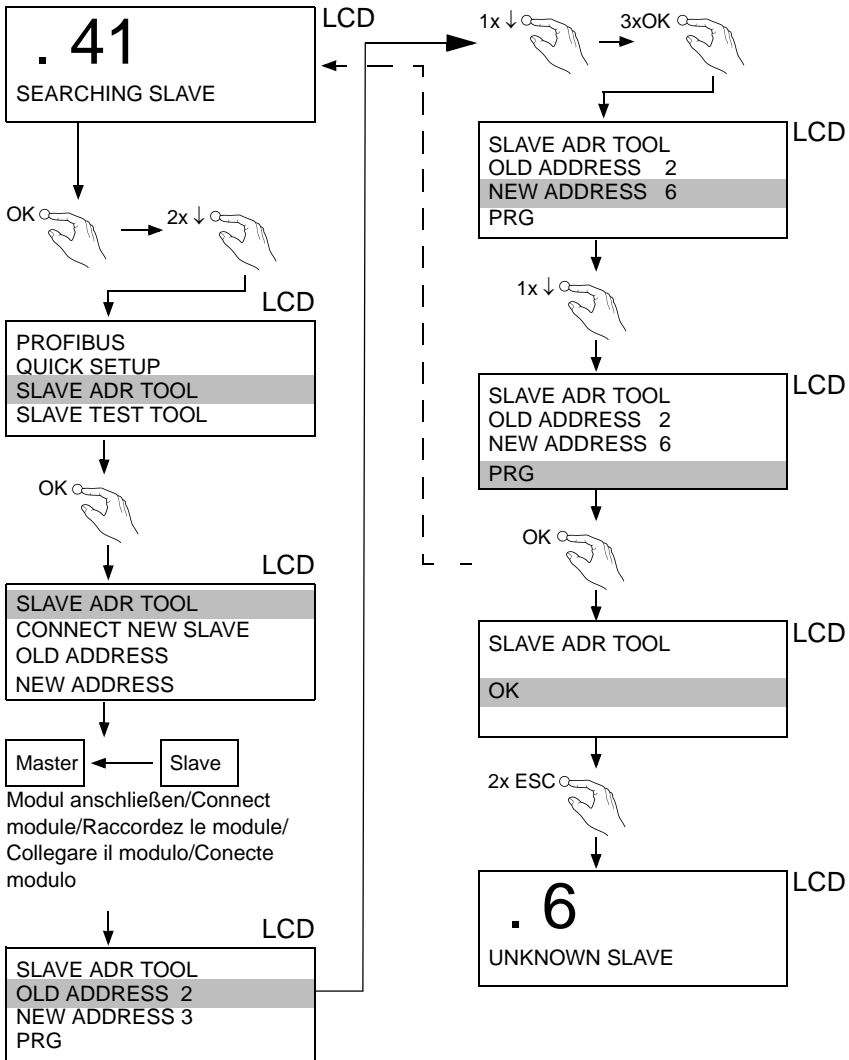

Issue date: 28.3.2012

## 6. Installation - PROFIBUS Basic Master

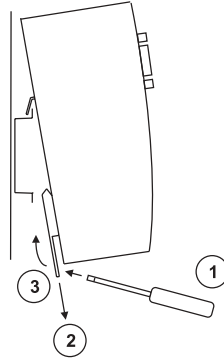
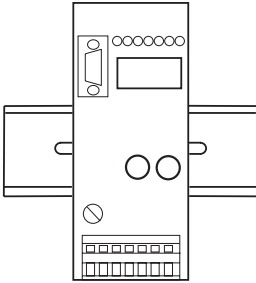

### 6.1 Dimensions

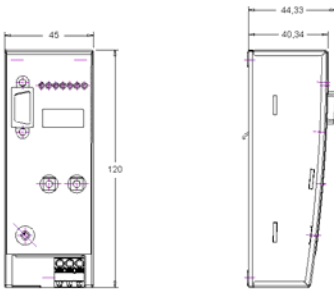

### 6.2 Electrical Connection



#### **Information!**

Electrical connections are described in section <Electrical connection>.

### 6.3 Startup



#### **Attention!**

If PROFIBUS active, no configuration settings by push buttons!

#### 6.3.1 Setting the PROFIBUS-DP address

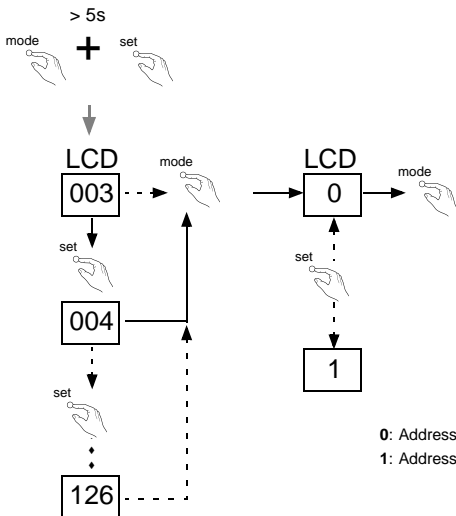

The device is set to address 3 at the factory.

#### 6.3.2 Switching to configuration mode

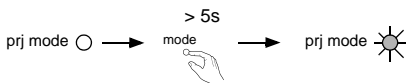

**6.3.3 Error display (last error)**

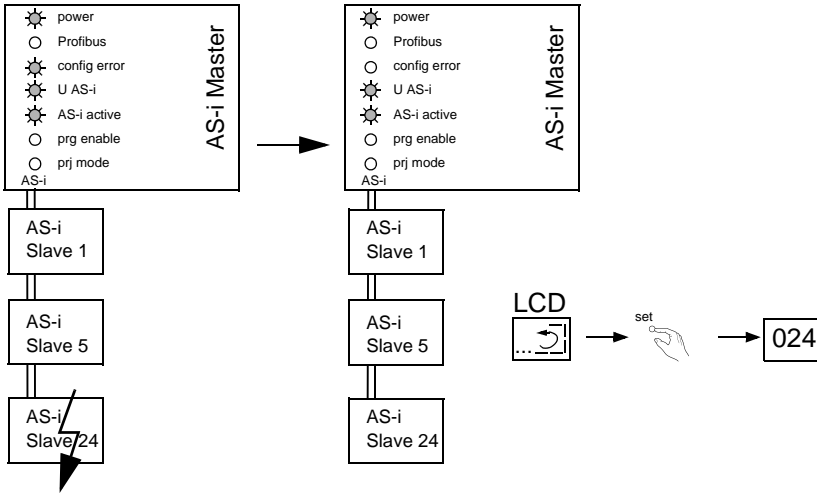

**6.3.4 Connecting AS-i Slaves**

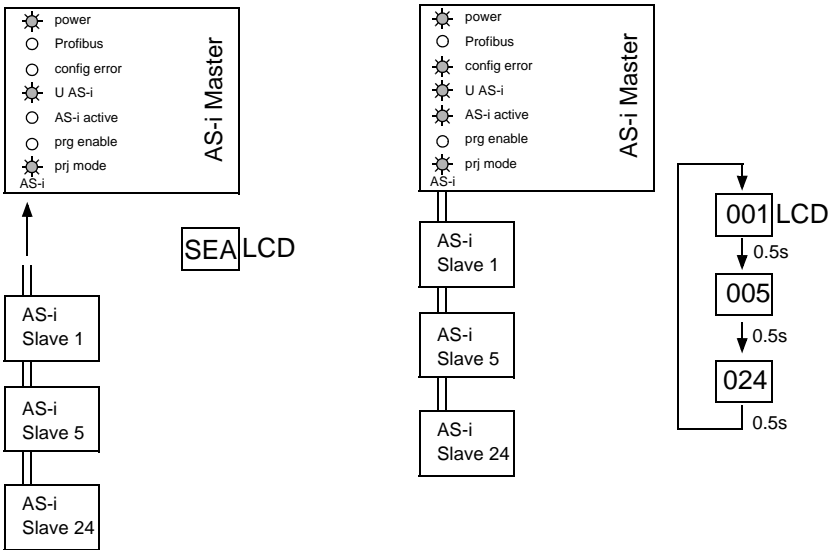

Issue date: 28.3.2012

**6.3.5 Store AS-i configuration**

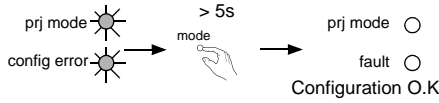

No PROFIBUS

**6.3.5.1 AddressingDelete slave address 5**

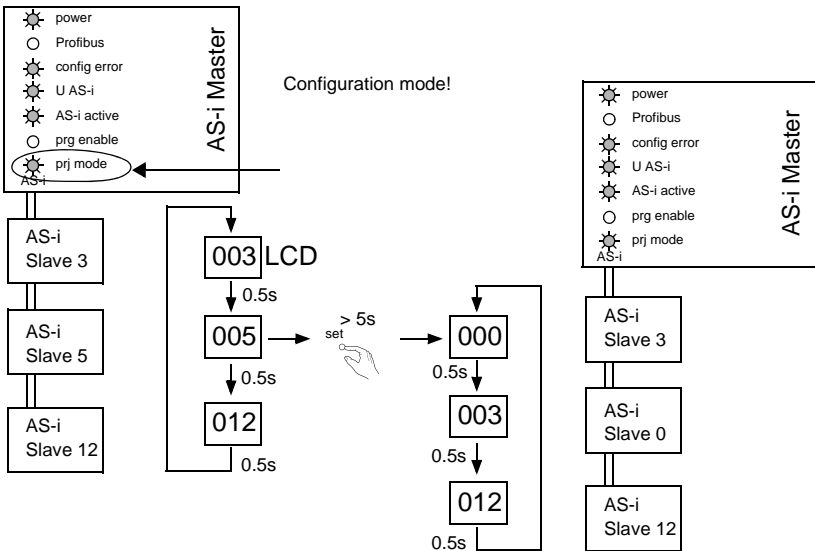

6.3.5.2 Programming slave 0 to address 4

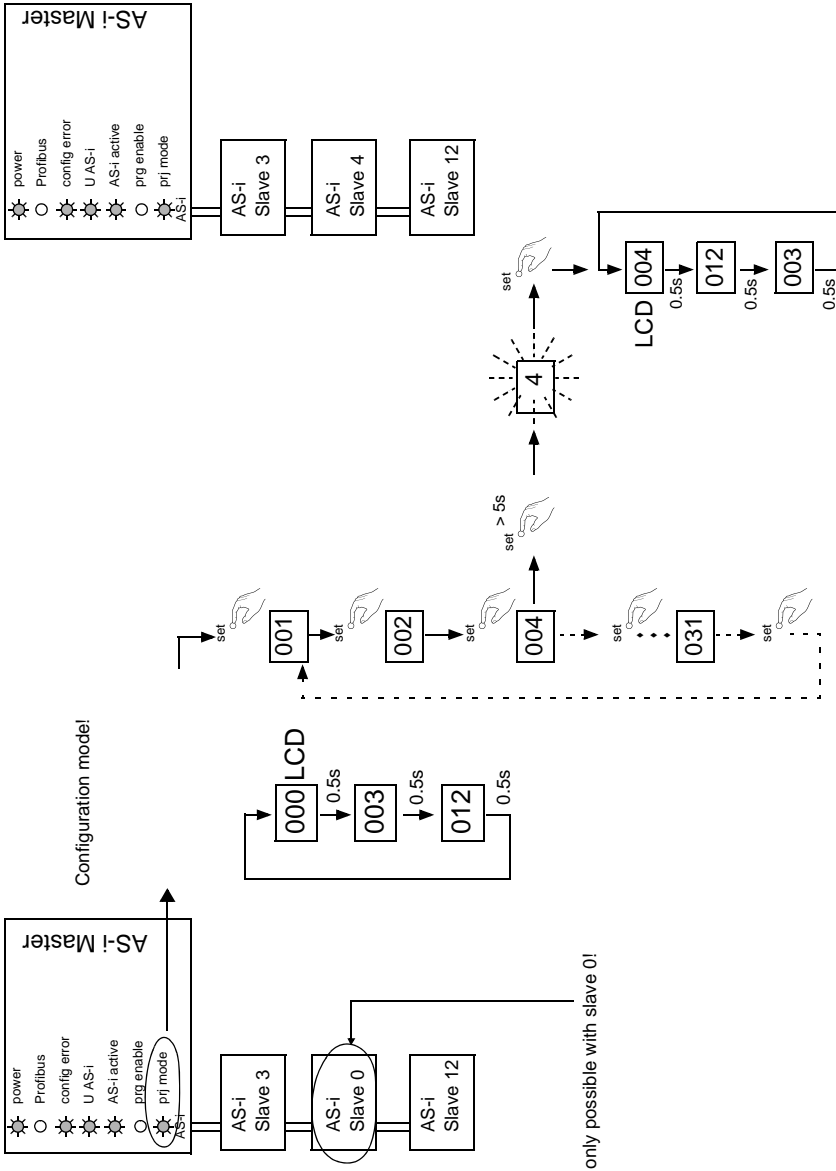

Issue date: 28.3.2012

**6.3.5.3 Error tracing Incorrect slaves (one error)**

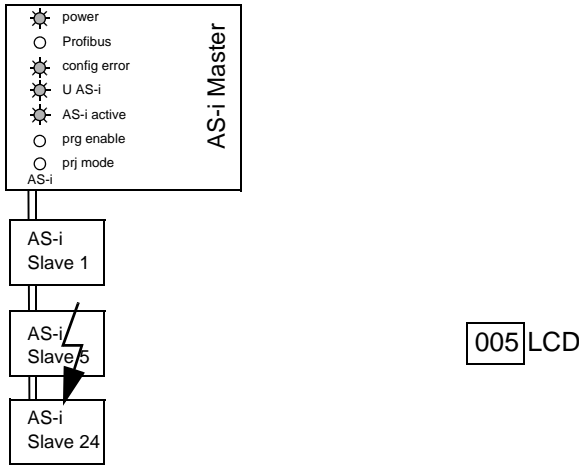

**6.3.5.4 Faulty slaves (multiple errors)**

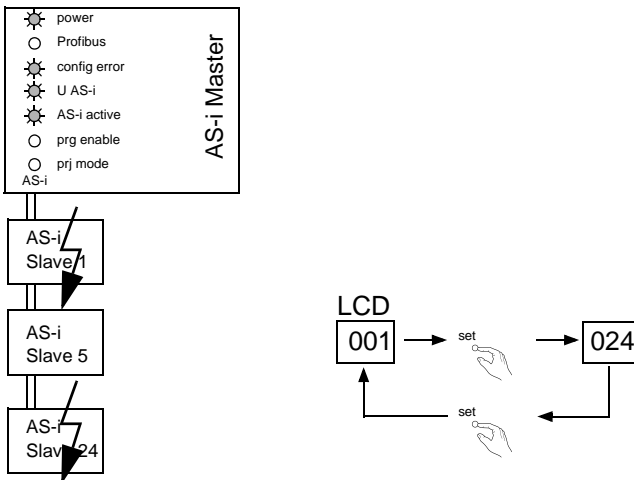





Issue date: 28.3.2012

## 7. Electrical connection

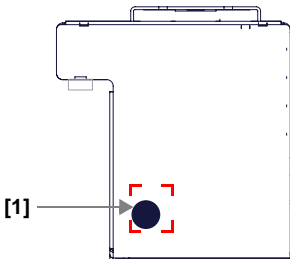
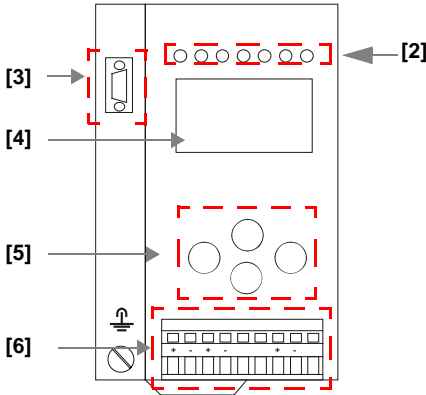
### 7.1 Overview of terminals, indicators and operating elements

#### 7.1.1 BWU1567, BWU1775, BWU1599, BW1653, BWU1773, BWU1891, BWU1568, BWU1776, BWU1600, BW1654, BWU1774, BWU1569, BWU1777, BWU1601, BW1655



	0,8 Nm 7 LB.IN
	2 x (0,5 ... 1,5) mm <sup>2</sup>
	2 x (0,5 ... 1,5) mm <sup>2</sup>
AWG	2 x 24 ... 12



**Legend:**

- [1] RS232 diagnostics port<sup>1</sup>
- [2] LEDs
- [3] D-sub connection (PROFIBUS interface)
- [4] LC display
- [5] Push-buttons
- [6] AS-i and power supply terminal

1. Only in conjunction with AS-i Control Tools

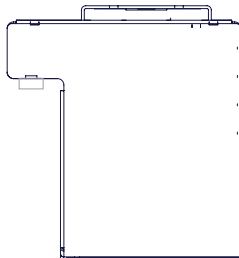
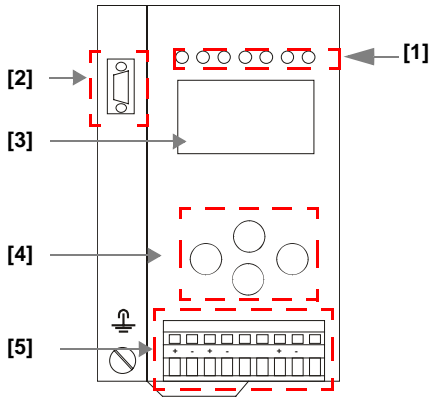
7.1.2 BWU1702, BWU1703, BWU2234

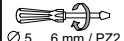



 Ø 5 ... 6 mm / PZ2	0,8 Nm 7 LB.IN
	2 x (0,5 ... 1,5) mm <sup>2</sup>
	2 x (0,5 ... 1,5) mm <sup>2</sup>
AWG	2 x 24 ...12

**Legend:**

- [1] LEDs
- [2] D-sub connection (PROFIBUS interface)
- [3] LC display
- [4] Push-buttons
- [5] AS-i and power supply terminal

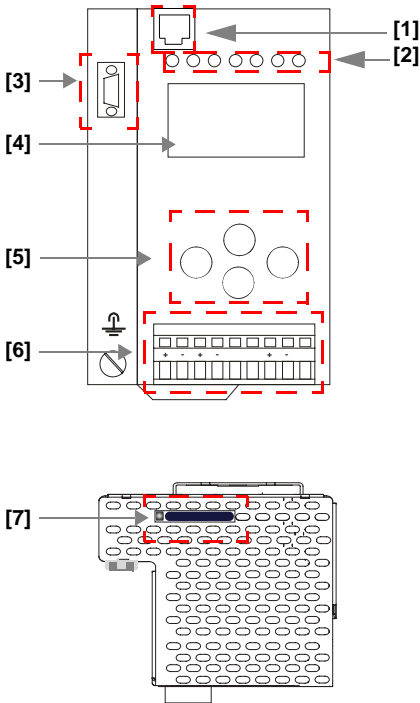
7.1.3 BWU2544, BWU2545, BWU2546

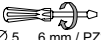

<b>i</b>	
 Ø 5 ... 6 mm / PZ2	0,8 Nm 7 LB.IN
 10	2 x (0,5 ... 1,5) mm <sup>2</sup>
 10	2 x (0,5 ... 1,5) mm <sup>2</sup>
AWG	2 x 24 ...12

**Legend:**



- [1] Ethernet diagnostics port<sup>1</sup>
- [2] LEDs
- [3] D-sub connection (PROFIBUS interface)
- [4] LC display
- [5] Push-buttons
- [6] AS-i and power supply terminal
- [7] Chip card

1. Only in conjunction with AS-i Control Tools

**Electrical connection**

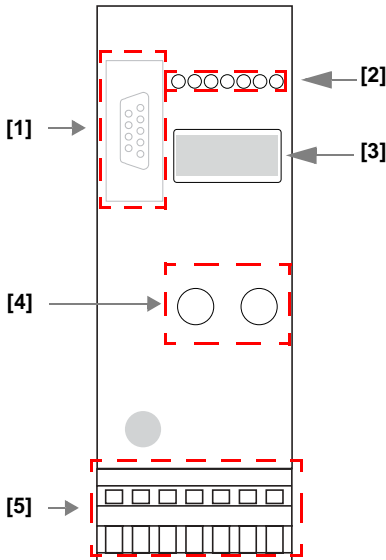
7.1.4 BWU1746

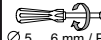

i	
 Ø 5 ... 6 mm / PZ2	0,8 Nm 7 LB.IN
	2 x (0,5 ... 1,5) mm <sup>2</sup>
	2 x (0,5 ... 1,5) mm <sup>2</sup>
AWG	2 x 24 ... 12

**Legend:**

- [1] D-sub connection (PROFIBUS interface)
- [2] LEDs
- [3] LED display (3-digit)
- [4] Push-buttons
- [5] AS-i and power supply terminal

## 7.2 AS-i bus connection

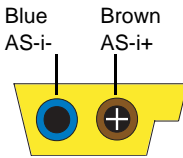

Yellow ASi ribbon cable

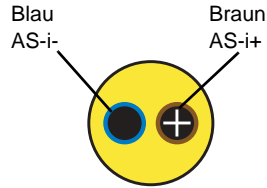

2-conductor AS-i round cable  
(Recommended: flexible power cable  
H05VV-F2x1,5 per DIN VDE 0281)



### Information!

*Electrical work is to be performed only by electrical technicians.*

## 7.3 Information about the device types



### Information!

*A listing of the individual devices and their features can be found in section <Product information>.*

## 7.4 AS-i and power supply terminal assignments



### Information!

*The cable indicated by grey must not have slaves or repeaters connected to it.*

*The yellow cable must not have AS-i power suppliers or additional masters connected to it.*



### Information!

*The function ground can be connected either to the grounding screw or to the terminal.*

*The function ground should be made with as short a cable as possible to ensure good EMC characteristics.*

*Therefore function grounding using the grounding screw is preferred.*



*The AS-i communication can jam up if the connectors from a BWU2234 gateway are exchanged with the ones from a BWU1702 gateway!*

**7.4.1 Electrical connection BWU1567, BWU1775, BWU1599, BW1653, BWU1773, BWU2544**

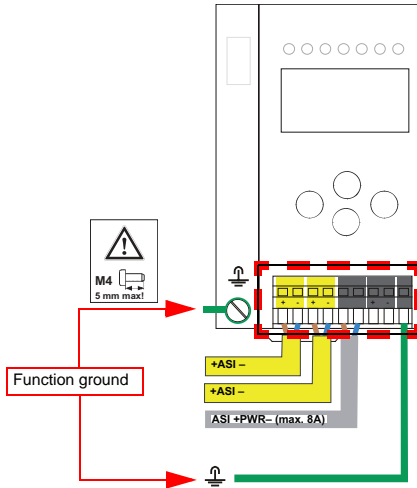

Terminal	Signal / Description
+AS-i-	Connection to AS-i Circuit
ASI +PWR-	Supply voltage for AS-i Circuit (max. 8 A)
FE	Function ground



**Information!**

For additional information, please refer to the section <AS-i and power supply terminal assignments>.

**Electrical connection**

**7.4.2 Electrical connection: BWU1702**

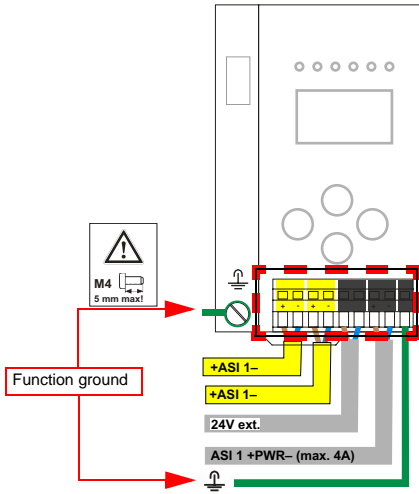

Terminal	Signal / Description
+ASI-	Connection to AS-i Circuit
24 V ext.	Additional 24 V
ASI 1 +PWR-	Supply voltage for AS-i Circuit 1 (max. 4 A)
FG	Function ground



**Information!**

For additional information, please refer to the section <AS-i and power supply terminal assignments>.

**Electrical connection**

**7.4.3 Electrical connection BWU1891**

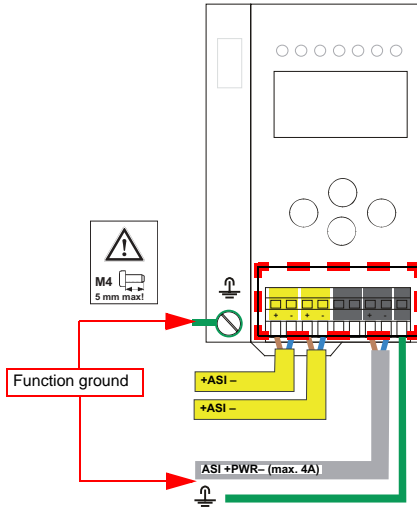

Terminal	Signal / Description
+AS-i-	Connection to AS-i Circuit
ASI +PWR-	Supply voltage for AS-i Circuit (max. 4 A)
FE	Function ground



**Information!**

For additional information, please refer to the section <AS-i and power supply terminal assignments>.

7.4.4 Electrical connection BWU1568, BWU1776, BWU1600, BW1654, BWU1703, BWU1774, BWU2545

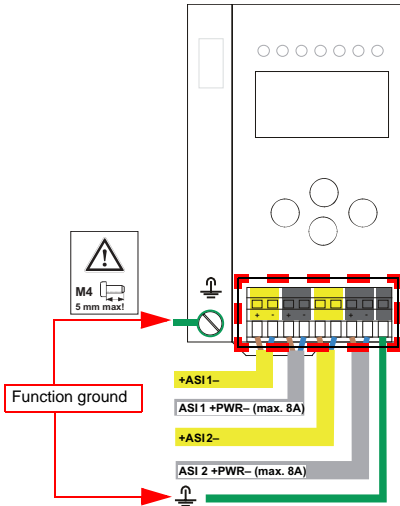

Terminal	Signal / Description
+ASI 1-	Connection to AS-i circuit 1
+ASI 2-	Connection to AS-i circuit 2
ASI 1 +PWR-	Supply voltage for AS-i circuit 1 (max. 8 A)
ASI 2 +PWR-	Supply voltage for AS-i circuit 2 (max. 8 A)
FE	Function ground



**Information!**

AS-i circuits 1 and 2 are powered by separate power supplies.



**Information!**

For additional information, please refer to the section <AS-i and power supply terminal assignments>.

7.4.5 Electrical connection BWU1569, BWU1777, BWU1601, BW1655, BWU2234, BWU2546

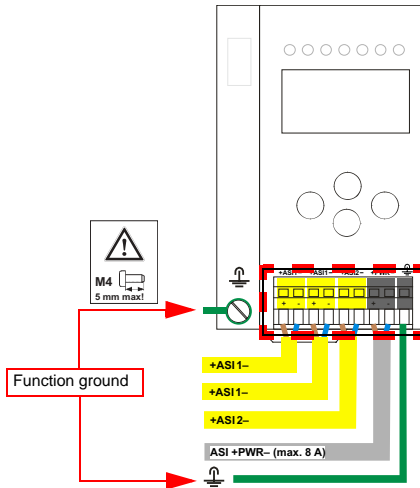

Terminal	Signal / Description
+ASI 1-	Connection to AS-i circuit 1
+ASI 2-	Connection to AS-i circuit 2
ASI +PWR-	Supply voltage for AS-i circuits (max. 8 A)
FE	Function ground



**Information!**

AS-i Circuit 1 and 2 are both powered from a Bihl+Wiedemann GmbH power supply!

No other power supplies are approved!



**Information!**

For additional information, please refer to the section <AS-i and power supply terminal assignments>.

7.4.6 Electrical connection BWU1746

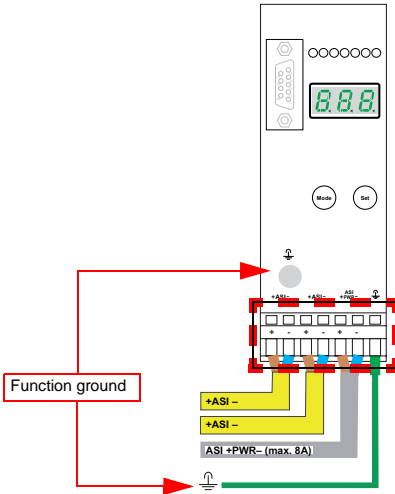

Terminal	Signal / Description
+AS-i-	Connection to AS-i Circuit
ASi +PWR-	Supply voltage for AS-i Circuit (max. 8 A)
FE	Function ground



**Information!**

For additional information, please refer to the section <AS-i and power supply terminal assignments>.

### 7.5 PROFIBUS interface

The PROFIBUS interface is designed as a 9-pin D-SUB connector, in accordance with the PROFIBUS standard EN 50 170. It is located at the top left-hand side of the master.

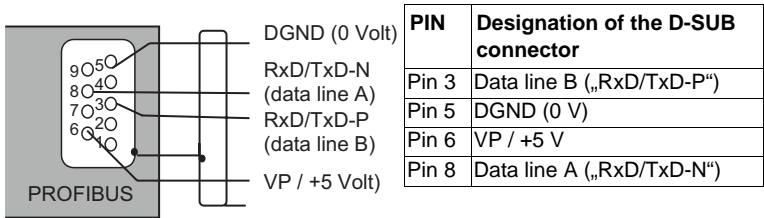

The AS-i/PROFIBUS gateway sends and receives signals on pins 3 and 8 of the D-SUB connector. The PROFIBUS signal “RxD/TxD-N (data line A)<sup>1</sup>” is located on pin 8, the signal “RxD/TxD-P (data line B)<sup>1</sup>” is located on pin 3.

Pin 5 (0 V) and pin 6 (5 V) supply 5 V DC for the bus termination resistor.

#### 7.5.1 Terminating resistors on the PROFIBUS network

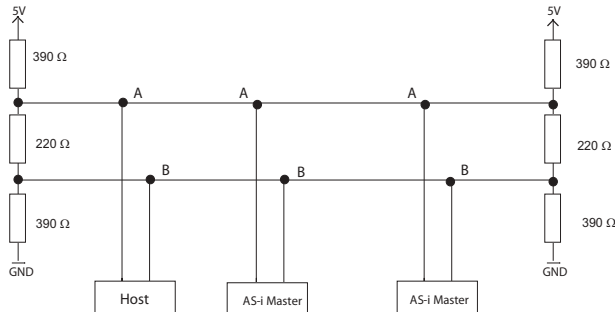

Issue date: 28.3.2012

1. If you measure the DC voltage between RxD/TxD-P (data line B) and RxD/TxD-N (data line A), RxD/TxD-P (data line B) is the positive pole when the bus is silent.

**Electrical connection**

## 7.6 Diagnostics interface

The service and diagnostics interface (in conjunction with **AS-i Control Tools** software) is used for communication between the PC and the unit.

### 7.6.1 BWU1567, BWU1775, BWU1599, BW1653, BWU1773, BWU1891, BWU1568, BWU1776, BWU1600, BW1654, BWU1774, BWU1569, BWU1777, BWU1601, BW1655

The service and diagnostics interface is configured as a mini DIN-6 female and it is placed at the top of the housing (see section <Overview of terminals, indicators and operating elements>).

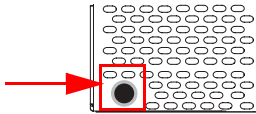

### 7.6.2 BWU2544, BWU2545, BWU2546

The service and diagnostics interface in these devices is as RJ45 female configured and it is placed on the front plate, on the left hand side.



## 7.7 Chip card

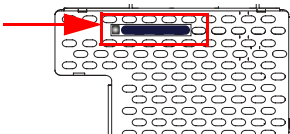

The configuration is stored in a fixed installed EEPROM and can be overwritten by the chip card. The chip card does not have to be inserted in operation.

### **Warning!**

*Power must always be turned off when removing or inserting the chip card!*



### 7.7.1 Using the chip card

The chip card integrated in the AS-i master is used to read-out and to store configuration data.

### 7.7.1.1 Card unformatted

If an unformatted card is found when the device is started, the following is displayed:

```
NEW CHIPCARD  
WILL BE FORMATED  
AS-I DATA WILL  
BE SYNCHRONIZED
```

The chip card is formatted and then the data copied to the chip card.

### 7.7.1.2 Data not compatible

If a card is found whose data are incompatible with the device, the following error message is displayed:

```
CHIPCARD NOT  
COMPATIBLE
```

### 7.7.1.3 Card empty

The following message is displayed for an empty card:

```
CHIPCARD FOUND  
AS-I DATA WILL  
BE SYNCHRONIZED
```

From this time on all changes are made both in the device and on the chip card.

### 7.7.1.4 Data compatible

When starting with an empty device (e.g. after a factory reset) a non-empty card is found whose data are compatible with the device, the following message is displayed:

```
AS-I DATA FROM  
CHIPCARD TAKEN
```

The card configuration is written to the device. From this time on all changes are made both in the device and on the chip card.

**Electrical connection**

**7.7.1.5 Data in the device and on the chip card identical**

If the card and device are not empty at start and the data are identical, no message is displayed.

**7.7.1.6 Data in the device and on the chip card not identical**

If the card and device are not empty at start and the data are not identical, an error message is displayed and the card is not synchronized with the device. The following menu is then automatically opened:

```
CHIPCARD AND  
AS-I DATA  
DIFFERENT  
CARD->MASTER  
MASTER->CARD  
CONTINUE
```

**Description**

- CHIP CARD>MASTER: Chip card data are copied to the master
- MASTER->CHIPCARD: Master data are copied to the chip card
- NEXT: No change to the data

The menu can be exited by pressing the ESC/Service key without changing the data.

## 7.8 Indicators and operating elements

### 7.8.1 LED indicators – master

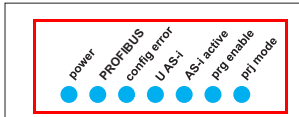

The LED's on the front panel of the device indicate:

#### **Power**

The master is receiving sufficient power.

#### **PROFIBUS**

LED an: Gateway is allocated to a PROFIBUS Master.

LED aus: Gateway is not allocated to a PROFIBUS Master.

#### **config error**

Configuration error.

At least one configured slave is missing, or at least one detected slave is not configured, or for at least one configured and detected slave the actual configuration data does not match the nominal configuration data, or the master is in the startup process.

This LED flashes if a peripheral fault has been detected for at least one AS-i slave on the AS-i network. If there are configuration errors as well as periphery faults, only the configuration error is displayed.

#### **U AS-i**

The AS-i network is sufficiently powered.

#### **AS-i active**

Normal operation is active

#### **prg enable**

Automatic single node replacement is enabled.

Exactly one slave is missing in the protected operating mode. The slave can be replaced by another slave of the same type with address zero. The master automatically addresses the new slave to the faulty address and thus corrects the configuration error

#### **prj mode**

The AS-i master is in configuration mode.

## 7.8.2 Buttons

The buttons are used for the following:

### **Mode/↑**

Switching between configuration mode and protected operating mode, and saving the current AS-i configuration as the nominal configuration.

### **Set/↓**

Selecting the address of and assigning an address to a slave.

### **OK, ESC**

Changing to the advanced display mode.

For additional information see section <Operation in advanced display mode>.

## 8. Operation in advanced display mode



### **Information!**

*You will find a description of the display menu in the separate document "Display\_Menue".*

## 9. PROFIBUS DP

This chapter contains all necessary information to operate the PROFIBUS gateways in a PROFIBUS DP network.



### **Information!**

*The respective bits ground fault, overvoltage, noise, double address will only be set if AS-i masters are used, which also support these functions.*

### 9.1 DP Telegrams

#### 9.1.1 Diagnostics

#### **EC-flags (high) and AS-i watchdog:**

- bit 0: periphery fault
- bit 1: ...
- bit 2: failure redundant 24 V AUX (option safety monitor)
- bit 3: failure redundant 24 V AUX (option single master)
- bit 4: earth fault
- bit 5: over voltage
- bit 6: noise
- bit 7: duplicate address

#### **EC-flags (low):**

- bit 0: configuration error
- bit 1: slave with address '0' detected
- bit 2: auto\_address\_assignment *not* possible
- bit 3: auto\_address\_assignment available
- bit 4: configuration mode active
- bit 5: *not* in normal operation
- bit 6: AS-i power fail
- bit 7: AS-i master offline

#### **Delta list:** List of AS-i slaves with configuration error

- 1: ConfigError
- 0: no ConfigError

#### **LPF:** List of AS-i slaves with periphery fault

- 1: periphery fault
- 0: no periphery fault

Each element of the user diagnostics (ec-flags and slave lists) can be switched off by setting the appropriate bit in the parameter telegram.

ExtDiag will be set if at least one of the following conditions is fulfilled:

- ConfigError  $\equiv$  1
- APF  $\equiv$  1
- PeripheryFault  $\equiv$  1

The conditions when to set the ExtDiag bit can be chosen using the user parameters or the commands of the command interface.

The GSD file includes the following presettings:

- The diagnosis transmits ec-flags, delta list and LPF.
- ExtDiag will be set if ConfigError = 1 and APF = 1. ExtDiag will not be set if there is a periphery fault.

If a double master is being used, the data for AS-i circuit are transmitted in the user parameter bytes 4 to 6. For circuit 2 3 additional bytes are added.

#### 9.1.1.1 Diagnostic description for BWU1567, BWU1568, BWU1569, BWU1599, BWU1600, BWU1601, BWU1653, BWU1654, BWU1655, BWU1702, BWU1703, BWU1746, BWU1773, BWU1774, BWU1775, BWU1776, BWU1777, BWU1891, BWU2234

DP diagnostics - single master					
PDU byte	user byte		DP	DP/V1	user
1	-	station_status 1	4		
2	-	station_status 2	4		
3	-	station_status 3	4		
4	-	master address	4		
5	-	ident high	4		
6	-	ident low	4		
7	1	header	4	4	
8	2	type		4	
9	3	slot		4	
10	4	spec		4	
11	5	ec-flags (high)			4
12	6	ec-flags (low)			4
13	7	delta (0...7)			4
14	8	delta (8...15)			4
...	...	...			...

Tab. 9-2.

DP diagnostics - single master					
PDU byte	user byte		DP	DP/V1	user
20	14	delta (56...63)			4
21	15	LPF (0...7)			4
...	...	...			...
28	22	LPF (56 ... 63)			4

Tab. 9-2.

DP diagnostics - double master					
PDU byte	user byte		DP	DP/V1	user
1	-	station_status 1	4		
2	-	station_status 2	4		
3	-	station_status 3	4		
4	-	master address	4		
5	-	ident high	4		
6	-	ident low	4		
7	1	header	4	4	
8	2	type		4	
9	3	slot		4	
10	4	spec		4	
11	5	ec-flags (high), circuit 1			4
12	6	ec-flags (low), circuit 1			4
13	7	delta (0 ... 7), circuit 1			4
14	8	delta (8 ... 15), circuit 1			4
...	...	...			...
20	14	delta (56 ... 63), circuit 1			4
21	15	LPF (0 ... 7), circuit 1			4
...	...	...			...
28	22	LPF (56 ... 63), circuit 1			4
29	23	reserved			4
...	...	...			...
36	30	reserved			4
37	31	ec-flags (high), circuit 2			4
38	32	ec-flags (low), circuit 2			4
39	33	delta (0...7), circuit 2			4
40	34	delta (8...15), circuit 2			4
...	...	...			...
46	40	delta (56...63), circuit 2			4
47	41	LPF (0...7), circuit 2			4
	...	...			...
54	48	LPF (56 ... 63), circuit 2			4

Tab. 9-3.

### 9.1.1.2 Diagnostic description for BWU2544, BWU2545, BWU2546

#### DP diagnostics

Byte	description
1	station state 1
2	station state 2
3	station state 3
4	Master address
5	ident high
6	ident low

Tab. 9-4.

The following blocks may be optionally appended to the DP diagnostics. Bytes 1 ... 4 are sent in each block according to the PROFIBUS standard.

Only when double masters are used is the entry „circuit 2“ available in the AS-i flags, delta list and LPF.

#### AS-i flags

Byte	description
1	0x06 header
2	0xA0 (circuit 1)/0xA1 (circuit 2) type
3	0x00 slot
4	0x00 spec
5	EC flags (high)
6	EC flags (low)

Tab. 9-5.

#### Delta list

Byte	description
1	0x0C header
2	0xA2 (circuit 1)/0xA3 (circuit 2) type
3	0x00 slot
4	0x00 spec
5	delta (0 ... 7)
6	delta (8 ... 15)

Tab. 9-6.

**Delta list**

Byte	description
...	...
12	delta (56 ... 63)

Tab. 9-6.

**LPF**

Byte	description
1	0x0C header
2	0xA4 (circuit 1)/0xA5 (circuit 2) type
3	0x00 slot
4	0x00 spec
5	LPF (0 ... 7)
6	LPF (8 ... 15)
...	...
12	LPF (56 ... 63)

Tab. 9-7.

**9.1.1.3 Parameters**

With the user parameters you can choose if and which slave list will be displayed in the diagnosis. Furthermore you can select which conditions have to be fulfilled to set the ExtDiag bit within the diagnostic telegram.

DP parameters - single master						
PDU byte	user byte		DP	DP/V1	user	default
1	–	Station_Status	4			
2	–	WD_Fact_1	4			
3	–	WD_Fact_2	4			
4	–	min T <sub>sdr</sub>	4			
5	–	Ident High	4			
6	–	Ident Low	4			
7	–	Group_Ident	4			
8	1	DPV Status 1		4		80 <sub>16</sub>
9	2	DPV Status 2		4		00 <sub>16</sub>
10	3	DPV Status 3		4		00 <sub>16</sub>

Tab. 9-8.

DP parameters - single master						
PDU byte	user byte		DP	DP/V1	user	default
11	4	User Byte 1			4	0B <sub>16</sub>
12	5	User Byte 2			4	06 <sub>16</sub>
13	6	User Byte 3			4	00 <sub>16</sub>

Tab. 9-8.

DP parameters - double master						
PDU byte	user byte		DP	DP/V1	user	default
1	-	Station_Status	4			
2	-	WD_Fact_1	4			
3	-	WD_Fact_2	4			
4	-	min T <sub>sdr</sub>	4			
5	-	ident high	4			
6	-	ident low	4			
7	-	Group_Ident	4			
8	1	DPV status 1		4		80 <sub>16</sub>
9	2	DPV status 2		4		00 <sub>16</sub>
10	3	DPV status 3		4		00 <sub>16</sub>
11	4	user byte 1, circuit 1			4	0B <sub>16</sub>
12	5	user byte 2, circuit 1			4	06 <sub>16</sub>
13	6	user byte 3, circuit 1			4	00 <sub>16</sub>
14	7	user byte 1, circuit 2			4	0B <sub>16</sub>
15	8	user byte 2, circuit 2			4	06 <sub>16</sub>
16	9	user byte 3, circuit 2			4	00 <sub>16</sub>

Tab. 9-9.

The bits in "user byte 1" and "user byte 3" have the following meanings:

user byte 1								
	2 <sup>7</sup>	2 <sup>6</sup>	2 <sup>5</sup>	2 <sup>4</sup>	2 <sup>3</sup>	2 <sup>2</sup>	2 <sup>1</sup>	2 <sup>0</sup>
	-	-			LPF	-	D	F
default	0	0	0	0	1	0	1	1

Tab. 9-10.

The GSD's default user parameter telegram is:

(DP/V1 enabled, diagnostics settings see chap. <Diagnostics>).

user byte 2								
	$2^7$	$2^6$	$2^5$	$2^4$	$2^3$	$2^2$	$2^1$	$2^0$
	FD	0		CS	PF	APF	CF	–
default	0	0		0	0	1	1	0

Tab. 9-11.

user byte 3								
	$2^7$	$2^6$	$2^5$	$2^4$	$2^3$	$2^2$	$2^1$	$2^0$
		–				0		
default		0				0		

Tab. 9-12.

**LPF:**

- 1: LPF will be transmitted in the diagnostics
- 0: LPF will not be transmitted

**D:**

- 1: Delta list will be transmitted in the diagnostics
- 0: Delta list will not be transmitted

**F:**

- 1: EC-flags will be transmitted in the diagnostics
- 0: EC-flags will not be transmitted

**FD:**

If this bit is set, the PROFIBUS diagnostics is refreshed only if the PROFIBUS norm dictates this ("freeze diagnostics"). In doubt the data of the PROFIBUS masters diagnostics are not up to date.

**CS:**

- 1: ExtDiag will be set if the LCS is not empty
- 0: ExtDiag will not be set if the LCS is not empty

**PF:**

- 1: ExtDiag will be set if there is a periphery fault at the AS-i line
- 0: ExtDiag will not be set.

**APF:**

- 1: ExtDiag will be set if there is an AS-i power fail
- 0: ExtDiag will not be set.

**CF:**

- 1: ExtDiag will be set if there is a configuration error
- 0: ExtDiag will not be set.

80 <sub>16</sub>	00 <sub>16</sub>	00 <sub>16</sub>	0B <sub>16</sub>	06 <sub>16</sub>	00 <sub>16</sub>
------------------	------------------	------------------	------------------	------------------	------------------

If a double master is being used, the User-Diagnosis-Bytes 5 to 30 represent AS-i network 1 and the User-diagnosis bytes 31 to 48 represent AS-i network 2.

### 9.1.2 Configuration DP/V0 (cyclic data)

The configuration of the AS-i/PROFIBUS gateways is made with the GSD file. Therefore the provided GSD file has to be imported into your PROFIBUS configuration tool.

#### 9.1.2.1 Options

The original data input and outlet data can be used with different „Special IDs“.

The advantages of special input and output IDs are, that they can include up to 64 elements (bytes or words), and that the length of input and output data can be different. Additionally, "manufacturer specific" data bytes describing the ID type are possible. These "manufacturer specific" data bytes describe the which type ID is.

The GSD file offers here several combinations (several lengths) for transmitting I/O data, command interface (management) and analog data.

Therefore the analog data can be transmitted directly in the process data channel and do not have to be requested by the slower DP/V1 commands.

Maximally 8 modules can be configured.



#### **Information!**

*There are some controls, with which slot numbers (1-n) required for generating of new modules are not generated automatically, but must be added manually!*

The detailed possibilities:

Length	description
4 bytes	digital input (slaves 0 - 7)
8 bytes	digital input (slaves 0 - 15)
12 bytes	digital input (slaves 0 - 23)
16 bytes	digital input (slaves 0 - 31)
20 bytes	digital input (slaves 0 - 7B)
24 bytes	digital input (slaves 0 - 15B)
28 bytes	digital input (slaves 0 - 23B)
32 bytes	digital input (slaves 0 - 31B)

Tab. 9-13.

Length	description
4 bytes	digital output (slaves 0 - 7)
8 bytes	digital output (slaves 0 - 15)

Tab. 9-14.

Length	description
12 bytes	digital output (slaves 0 - 23)
16 bytes	digital output (slaves 0 - 31)
20 bytes	digital output (slaves 0 - 7B)
24 bytes	digital output (slaves 0 - 15B)
28 bytes	digital output (slaves 0 - 23B)
32 bytes	digital output (slaves 0 - 31B)

Tab. 9-14.

Length	description
16 bytes	digital in/out (slaves 0 - 31)
16 Bytes	digital in/out (slaves 0B - 31B)
32 bytes	digital in/out (slaves 0 - 31B)

Tab. 9-15.

**Information!**

2 command interfaces can be intergrated.

Length	description
2 bytes	management (command interface)
4 bytes	management (command interface)
8 bytes	management (command interface)
11 bytes	management (command interface)
12 bytes	management (command interface)
34 bytes	management (command interface)
36 bytes	management (command interface)

Tab. 9-16.

Length	description
24 bytes	analog input (slaves 29 - 31)
56 bytes	analog input (slaves 25 - 31)
88 bytes	analog input (slaves 21 - 31)
120 bytes	analog input (slaves 17 - 31)
128 bytes	analog input (slaves 16 - 31)
16 bytes	analog input (slaves 14 - 15)

Tab. 9-17.

Length	description
24 bytes	analog output (slaves 29 - 31)
56 bytes	analog output (slaves 25 - 31)
88 bytes	analog output (slaves 21 - 31)
120 bytes	analog output (slaves 17 - 31)
128 bytes	analog output (slaves 16 - 31)
16 bytes	analog output (slaves 14 - 15)

Tab. 9-18.

Length	description
2 bytes ... 128 bytes	analog input data circuit 1, dynamic <sup>1</sup>
2 bytes ... 128 bytes	analog output data circuit 1, dynamic <sup>1</sup>
2 bytes ... 128 bytes	analog input data circuit 2, dynamic <sup>1</sup>
2 bytes ... 128 bytes	analog output data circuit 2, dynamic <sup>1</sup>

Tab. 9-19.

1. Module parameters necessarily

Length	description
2 bytes	flags and detector circuit 1
2 bytes	flags and detector circuit 2

Tab. 9-20.

### 9.1.3 I/O Data

#### 9.1.3.1 Process data

In V2.1 mode the AS-i I/O data are mapped in the process data as known from the Siemens and AS-i/InterBus masters. This means that the lower nibble describes the data of the AS-i slave with the higher slave address. The ec-flags or hi-flags are additionally mapped at the nibble of AS-i slave 0.

byte	2 <sup>7</sup>	2 <sup>6</sup>	2 <sup>5</sup>	2 <sup>4</sup>	2 <sup>3</sup>	2 <sup>2</sup>	2 <sup>1</sup>	2 <sup>0</sup>
0	flags				slave 1/1A			
	F3	F2	F1	F0	D3	D2	D1	D0
1	slave 2/2A				slave 3/3A			
2	slave 4/4A				slave 5/5A			
3	slave 6/6A				slave 7/7A			
4	slave 8/8A				slave 9/9A			
5	slave 10/10A				slave 11/11A			
6	slave 12/12A				slave 13/13A			
7	slave 14/14A				slave 15/15A			
8	slave 16/16A				slave 17/17A			

Tab. 9-21.

Issue date: 28.3.2012

byte	2 <sup>7</sup>	2 <sup>6</sup>	2 <sup>5</sup>	2 <sup>4</sup>	2 <sup>3</sup>	2 <sup>2</sup>	2 <sup>1</sup>	2 <sup>0</sup>
9		slave 18/18A				slave 19/19A		
10		slave 20/20A				slave 21/21A		
11		slave 22/22A				slave 23/23A		
12		slave 24/24A				slave 25/25A		
13		slave 26/26A				slave 27/27A		
14		slave 28/28A				slave 29/29A		
15		slave 30/30A				slave 31/31A		
16		reserved				slave 1B		
17		slave 2B				slave 3B		
18		slave 4B				slave 5B		
19		slave 6B				slave 7B		
20		slave 8B				slave 9B		
21		slave 10B				slave 11B		
22		slave 12B				slave 13B		
23		slave 14B				slave 15B		
24		slave 16B				slave 17B		
25		slave 18B				slave 19B		
26		slave 20B				slave 21B		
27		slave 22B				slave 23B		
28		slave 24B				slave 25B		
29		slave 26B				slave 27B		
30		slave 28B				slave 29B		
31		slave 30B				slave 31B		

Tab. 9-21.

Flags		
	input data	output data
F0	ConfigError	Offline
F1	APF	LOS master bit
F2	PeripheryFault	→ ConfigurationMode
F3	ConfigurationActive	→ ProtectedMode

Tab. 9-22.

ConfigError: 0 = config ok  
1 = config error

APF: 0 = AS-i power ok  
1 = AS-i power fail

PeripheryFault: 0 = periphery ok  
1 = periphery fault

ConfigurationActive: 0 = configuration active  
1 = configuration inactive

Offline: 0 = online  
1 = offline

LOS-Master-Bit 0 = offline by configerror deactivated  
1 = offline by configerror activated

A rising edge of F2 and F3 switch the master to the desired mode.

A rising edge of the "LOS master bit" effects that all bits in the LOS are set. A falling edge effects that all bits are deleted.

### EC-flags (high) and AS-i watchdog:

bit 0: periphery fault  
bit 1: ...  
bit 2: failure redundant 24 V AUX (option safety monitor)  
bit 3: failure redundant 24 V AUX (option single master)  
bit 4: earth fault  
bit 5: over voltage  
bit 6: noise  
bit 7: duplicate address

### EC-flags (low):

bit 0: configuration error  
bit 1: slave with address '0' detected  
bit 2: auto\_address\_assignment *not* possible  
bit 3: auto\_address\_assignment available  
bit 4: configuration mode active  
bit 5: *not* in normal operation  
bit 6: AS-i power fail  
bit 7: AS-i master offline

#### 9.1.3.2 AS-i 16-bit data



#### **Information!**

*A-slaves map the data on channels 1 and 2.*

*B-slaves map the data on channels 3 and 4.*

In addition to the access via the command interfaces, the 16-bit data for or by the slaves with 16-bit value can be exchanged cyclically (profile 7.3., S-7.4, S-6.0, S-7.5, S-7.A.8, S-7.A.9, S-7.A.A). Competing writing access attempts on analog output data will not be blocked by each other. If analog data for a particular slave

are being transmitted both cyclically and acyclically with the command interface or via DP/V1 connections, the acyclically transmitted values will be overwritten by the cyclically transmitted values.

AS-i 16-bit data can be transmitted in a reserved data area. Therefore accessing analog data is as easy as accessing digital data.

16-bit data								
byte	$2^7$	$2^6$	$2^5$	$2^4$	$2^3$	$2^2$	$2^1$	$2^0$
1	slave 31-n/8, channel 1, high byte							
2	slave 31-n/8, channel 1, low byte							
3	slave 31-n/8, channel 2, high byte							
4	slave 31-n/8, channel 2, low byte							
...	...							
n-3	slave 31, channel 3/slave 31B, channel 1, high byte							
n-2	slave 31, channel 3/slave 31B, channel 1, low byte							
n-1	slave 31, channel 4/slave 31B, channel 2, high byte							
n	slave 31, channel 4/slave 31B, channel 2, low byte							

Tab. 9-23.

### 9.1.3.3 Command interface

Only using the IDs of the process data field the PROFIBUS gateway can be used as M0 AS-i master. By using the command interface (see chap. <DP/V1>) the functions of a M3 master become available.

Request								
byte	$2^7$	$2^6$	$2^5$	$2^4$	$2^3$	$2^2$	$2^1$	$2^0$
1	command							
2	T	circuit						
3	request parameter byte 1							
...	...							
36	request parameter byte 34							

Answer								
byte	$2^7$	$2^6$	$2^5$	$2^4$	$2^3$	$2^2$	$2^1$	$2^0$
1	command (mirrored)							
2	result							
3	response parameter byte 1							
...	...							
36	response parameter byte 34							

Tab. 9-24.

A command of the command interface will be edited if the toggle bit  $T^1$  has changed. This way the same command can be used repeatedly.

The commands of the command interface can also be activated with PROFIBUS DP/V1. Even the process data exchange is possible via the command interface. This way the Windows configuration software "AS-i-Control Tools" can run the whole communication via DP/V1.

### 9.1.3.4 Safety Control/Status

In the fieldbus configuration the designator **Safety Control/Status** can be added as cyclical data. This is possible both for the integrated Safety Monitor and for 2nd generation Monitors.



#### Information!

*Generation III external Monitors allow a maximum of eight OSSDs to be sent.*

The state of the outputs and the message outputs is then inserted as a cyclical input datum.

#### Inputs

byte	description
1	Status OSSD 1, color-coded as defined in the table <Coding of status bytes>).
2	Status OSSD 2, color-coded as defined in the table <Coding of status bytes>).
...	...
n	Status OSSD n, color-coded as defined in the table <Coding of status bytes>).

Tab. 9-25.

#### Coding of status bytes

Bit [0 ... 3]	state or. color	description
00 <sub>16</sub>	green permanent lighting	output on
01 <sub>16</sub>	green flashing	delay time is running at stop category 1
02 <sub>16</sub>	yellow permanent lighting	start-up/restart-disable active
03 <sub>16</sub>	yellow flashing	external test necessary / acknowledgement / start delay active
04 <sub>16</sub>	red permanent lighting	output off
05 <sub>16</sub>	red flashing	error
06 <sub>16</sub>	grey or off	output not projected
07 <sub>16</sub>	reserved	
Bit [6]	status or color	

Tab. 9-26.

1. A **T bit** (toggle bit) is only needed to execute two commands directly one after the other.

### Coding of status bytes

0	no device flashing yellow
1	at least one device flashing yellow
Bit [7]	status or color
0	no device flashing red
1	at least one device flashing red

Tab. 9-26.

The cyclical output identifier contains the 4 Safety Monitor bits 1.Y1, 1.Y2, 2.Y1 and 2.Y2. The monitoring element "Monitor input" and the start elements "Monitor Start-Monitor Input" and "Activation using Monitor Input" access these data. In contrast, the "Feedback circuit" element always accesses the EDM input.

### Outputs

byte	description
1	byte from the fieldbus
	bit 0: 1.Y1
	bit 1: 1.Y2
	bit 2: 2.Y1
	bit 3: 2.Y2
	bit 4 ... 7: reserved
2	reserved

Tab. 9-27.

The bits of the output bytes are ORed with the real and the homonymous hardware inputs of the device.

## 9.2 DP/V1

To exchange data between the PROFIBUS master and the AS-i/PROFIBUS gateway via PROFIBUS DP/V1 only one data block is used - slot 1, index 16. Within this data block a command interface is installed like the one used in the DP telegram.

The DP/V1-command interfaces are edited every time they are sent. Therefore it is possible to execute the same command several times without changing "command" or "circuit" and setting a toggle bit.

## 9.3 Restrictions

The SPC3 has only 1,5 KByte DP-RAM available. Therefore the lengths of telegrams and the numbers of DP/V1-connections to class 2 masters have to be restricted.

**Information!**

I+M service contains data for identification and maintenance. This service is on by default. Switching the services off provides additional memory into SPC3. This changes the DP/VD length-limit.

Restrictions due to the SPC3		
MSC1	inputs data / outputs data	single master: 288 bytes <sup>1</sup> doppel master: 272 bytes <sup>2</sup>
	diagnosis	62 bytes
	parameter	single master: 53 bytes doppel master: 88 bytes
	configuration <sup>3</sup>	32 bytes
	SetSlaveAddress	4 bytes
MSAC1	SAPs	1
	PDU	72 bytes <sup>4</sup>
MSAC2	SAPs	2
	PDU	72 bytes <sup>5</sup>

Tab. 9-28.

1. The maximum length of the input and output data can vary up to 288 bytes input or output data if the **I+M** (information+maintenance) **service** is *on* only. The maximum length of the input and output data (both master) is not variable and it is limited to 144 bytes (for input and output data) if the **I+M service** is disabled.
2. The maximum length of the input and output data can vary up to 272 bytes input or output data if the **I+M** (information+maintenance) **service** is *on* only. The maximum length of the input and output data (both master) is not variable and it is limited to 144 bytes (for input and output data) if the **I+M service** is disabled.
3. Maximally 8 modules can be configured
4. The maximum length is limited to 42 bytes if the **I+M service** is set to *off*.
5. The maximum length is limited to 52 bytes if the **I+M service** is set to *off*.

## 10. Advanced Diagnostics for AS-i Masters

The advanced AS-i diagnostics is intended to localize occasionally occurring configuration errors and to determine the quality of data transmission on AS-i without using additional diagnostics tools.

AS-i Control Tools, a MS-Windows software designed to simplify AS-i installation and used to program AS-i Control, enables operation of the advanced diagnostics functions (LCS, error counters, and LOS).

### 10.1 List of corrupted AS-i Slaves (LCS)

The LCS contains the information from the Delta list. In addition to the list of configured slaves (LPS), the list of detected slaves (LDS), and the list of activated slaves (LAS), the AS-i master creates a fourth list, the list of corrupted slaves (LCS) containing advanced diagnostics data used to diagnose the causes for intermittently occurring configuration errors on AS-i. This list contains entries for all AS-i slaves that were responsible for at least one intermittent configuration error since the list was last read or since the AS-i master was turned on. Furthermore, intermittent AS-i power failures are listed in the LCS at the position of AS-i slave with address 0.



#### **Information!**

*Whenever the LCS is read it is deleted from memory.*



#### **Information!**

*The last intermittent configuration error can also be displayed on the AS-i master:*

*Pressing the "Set" button on the AS-i master initiates the display of the AS-i slave responsible for the last intermittent configuration error. If a intermittent AS-i power failure occurred, the display shows 39 after pressing the "Set" button.*

*This function is only available if the device is in normal operating mode of the protected mode (display empty) or in the off-line phase (Display: "40").*

### 10.2 Protocol analysis: Counters for corrupted data telegrams

The AS-i master with advanced diagnostics provides a counter for telegram repetitions for each AS-i slave. The counter counts up every time a corrupted data telegram has been found, making it possible to determine the quality of the transmission if only a few telegrams are corrupt and the AS-i slave never caused a configuration error.



#### **Information!**

*The counter values are read via the host interface and will be deleted after they were read.*

*The highest possible counter value is 254. 255 indicates a counter overflow.*

Displaying the protocol analysis is possible through the AS-i Control Tools software by using the command "Master | AS-i Diagnostics".

## 10.3 Offline Phase for Configuration Errors

The AS-i masters with advanced diagnostics offer the possibility to set themselves into the offline phase when a configuration error occurs and thus are able to transition the AS-i network into a safe operational state. This ensures a quick reaction to a configuration error and the host can be relieved from this task. If any problems occur on the AS-i network, the AS-i masters can independently switch the AS-interface into a safe state.

There are two different ways to parameterize the AS-i master for this feature:

- Any configuration error occurring on AS-i switches the master from regular operation in protected mode into the offline phase.
- o . A list with the addresses of slaves that can potential initiate the off-line phase is defined (list of offline slaves LOS).

The user can decide how the system should react to a configuration error on AS-i. Thus, the AS-i master can be set to the offline phase for critical AS-i slaves, whereas for less critical slaves only the error message is sent to the host, but AS-i is still running.

Like the advanced diagnostics, the parameterization "offline phase on configuration error" is also supported by "AS-i-Control-Tools" (Command | Characteristics | Offline because of configuration error).

There are two options to reset the error message "OFFLINE BY LOS":

1. Deleting the complete LOS list on the affected AS-i network ("CLEAR ALL").
2. Power reset on the affected AS-i network.



### **Attention!**

*If a power reset occurs on the AS-i network 1 the complete double gateway will be shut down.*

## 10.4 Functions of the AS-i Fault Detector

### 10.4.1 Duplicate address detection

If two slaves on an AS-i network have the same address, a duplicate address exists. Since the master cannot communicate individually with these slaves any longer, this is considered an error. Because the two slave replies interfere, it is impossible for the master to recognize the slave responses. This results in extremely unstable network behavior.

The duplicate address detection function is used to safely recognize a duplicate address and to display it on the screen and in AS-i Control Tools.

A duplicate address causes a configuration error and is displayed on the screen.



### **Information!**

*Duplicate addresses can be recognized only on an AS-i segment directly connected to the master.*

### 10.4.2 Earth/Ground Fault Detector

An Earth/Ground Fault exists when the voltage  $U_{\text{GND}}$  (Nominal value of  $U_{\text{GND}}=0,5 U_{\text{AS-i}}$ ) is outside of the following range:

$$10\% U_{AS-i} \leq U_{GND} \leq 90\% U_{AS-i}$$

This error substantially limits the noise immunity of the AS-i communication.

Ground faults are indicated on the master's display as well as in AS-i Control Tools.



**Information!**

*To recognize ground faults the master must be grounded with its machine ground connection.*



**Information!**

*A ground fault in one of the two networks of a double master in a version 1 power supply for two AS-i networks causes a ground fault in the other network as well because of the existing galvanic connection.*

#### 10.4.3 Noise Detector

The noise detector detects AC voltages on AS-i, that are not initiated by an AS-i master or AS-i slaves. These interference voltages can cause telegram disturbances.

A frequent cause are insufficiently shielded frequency inverters or improperly routed cables.

Noises is indicated on the master's display as well as in AS-i Control Tools.

#### 10.4.4 Over-voltage Detector

Over-voltages are present if the conductors of an AS-i network that normally are routed electrically symmetrical with respect to machine ground, are strongly electrically raised. A cause can for example be startup procedures of large consumers.

However, over-voltages do generally not interfere with the AS-i communication, but can under certain circumstances cause incorrect sensor signals.

Over-voltages are indicated on the master's display as well as in the AS-i Control Tools.

## 10.5 Functions of the new generation of AS-i Gateways

The new generation scores with further optimized diagnostics, several additional functions and even greater operating convenience.



### Information!

A listing of the individual devices and their features can be found in section <New Generation of AS-i Gateways with ethernet diagnostics interface>.

### 10.5.1 C-programmable Gateways

Main menu || SETUP || AS-I CONTROL || CONTROL FLAGS ||

The devices programmed in C are able themselves to take over a great number of control tasks. In smaller systems the user will even be able to do without a PLC altogether: if desired the C program can function as a full mini-PLC. In more complex applications the C-programmable Gateways make the work of the PLC easier - for example by pre-processing special functions.

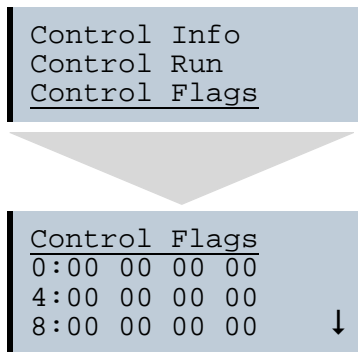

### 10.5.2 Interchangeable memory card

Main menu || SETUP || CHIPCARD || AS-I CHIPCARD ||

Interchangeable memory card: redundant memory for C program and device configuration.

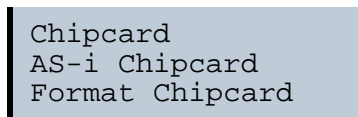

### 10.5.3 Earth fault monitor

Main menu || DIAGNOSE || ASI WATCHDOG ||

The new earth fault monitor allows the service technician to detect whether an earth fault has occurred directly on AS-i or on a sensor line.

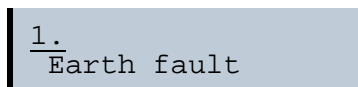

```

EFLT Ratio:      ↑
AS-i+ 2%
AS-i DC Voltage: 1
                 31,3V
                 ↓
    
```

```

EFLT Ratio:      ↑
AS-i+ 100%
AS-i DC Voltage: 2
                 31,5V
    
```

**10.5.4 Current can be read directly on the unit**

Now the devices display both the maximum current and the current actually present in the respective AS-i circuit. Heavy consumers or a strong overload in an AS-i circuit are then easy to detect. Plus you can set the maximum current in the AS-i circuit on these devices. This ensures line protection even when using large 24V power supplies.

```

AS-i power
Reset
Maximal:        2
                1,3A
                ↓
    
```

```

Maximal:        ↑
                1,3A
current:        2
                0,3A
                ↓
    
```

```

Current:        ↑
                0,3A
Current limiting 2
                3,2A
                ↓
    
```

Issue date: 28.3.2012

### 10.5.5 Self-resetting fuses

Thanks to self-resetting fuses in the "1 Gateway, 1 power supply for 2 AS-i circuits" Gateway version, when there is a short circuit in one of the two AS-i circuits the other circuit and the Gateway remain operational - the host controller keeps receiving diagnostic information from AS-i, which also provides meaningful assistance towards rapid troubleshooting.

The fuse resets itself periodically to check if the error is solved. The measured current value is available as diagnostic information at the field on the display and at the control level.

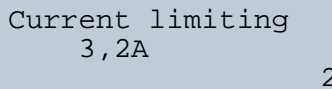

### 10.5.6 AS-i Power24V capable

Main menu || SETUP || ASI POWER ||

Gateways for AS-i Power24V have been developed especially for use in small systems. They don't need any special AS-i power supply. With a standard 24V power supply a 50 m line length and with an AS-i power supply min. 100 m line length can be realised.

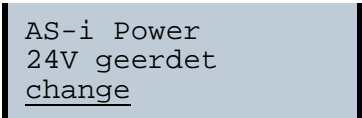
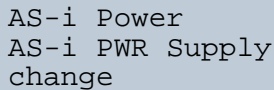
### 10.5.7 Ethernet diagnostics interface with web server

These devices allow diagnostics for both the Gateway and the AS-i networks (including Safety technology) over Ethernet without additional software. AS-i network can be thus a part of a remote maintenance concept. Moreover the configuration file are stored on the web server and so they are always within reach.

### 10.5.8 Transitionless operating mode changes

Main menu || SETUP || MODE CHANGE ||

These devices are able to change the operating mode from projecting mode to the protected operating mode without having to first go to the "offline phase".

This means the Slave outputs are not cleared and the safe Slaves not turned off.

Activation and deactivation is set using the PROFIBUS start parameterization.

This function must be explicitly activated; the default setting is "Deactivated."

The setting for activated and deactivated is saved, which means that it remains set after a "power cycle".

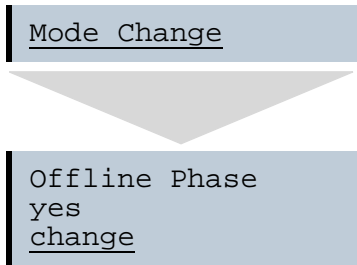

## 11. System startup using AS-i Control Tools

The Windows based software "AS-i Control Tools" with a serial interface for stainless steel AS-i masters is designed to make the startup of the AS-i 3.0 PROFIBUS Gateway in Stainless Steel as comfortable as possible.

Additionally, the software communicates with the AS-i 3.0 PROFIBUS Gateway in Stainless Steel by using a PROFIBUS DP Master Simulator DP/V1 or the serial PROFIBUS master.

### 11.1 Windows software AS-i Control Tools



#### **Information!**

*AS-i Control Tools must be installed first!*

This way, the device driver is copied into the previous designed folder in AS-i Control Tools and should be recognized automatically.

The Windows software "AS-i Control Tools" enables the user to easily configure the AS-i network.

1. Plug the PROFIBUS Master Simulator or a serial PROFIBUS Master, respectively, into the D-SUB connector of the AS-i/PROFIBUS Gateway and connect the device to the PC via its serial interface.
2. Start AS-i Control Tools.
3. Select Master | New.

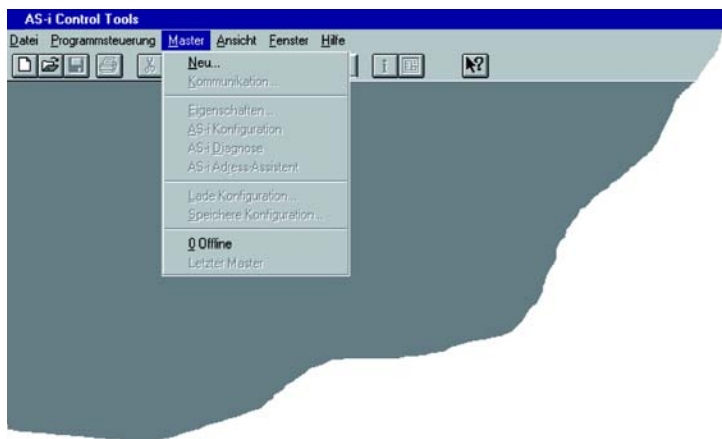

4. Choose PROFIBUS as the protocol.
5. Select the appropriate settings (for example serial interface COM 2, station address <auto>).

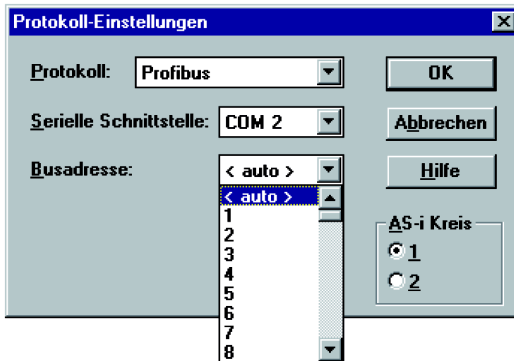

- Select Master | AS-i configuration. The AS-i configuration editor will be started. All detected and configured AS-i slaves are displayed in this window.

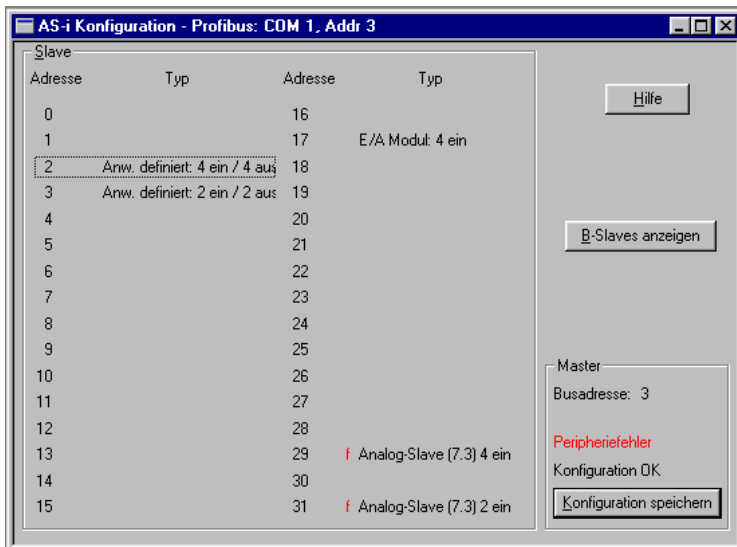

- Click on a slave to open the dialog window 'slave configuration'.



This window enables the user to edit a slave address and to set AS-i parameters or AS-i configuration data. Additionally, inputs and outputs can be tested.

- Click the second button on the right side of the tool bar to get a graphical display of "AS-i Control Tools".

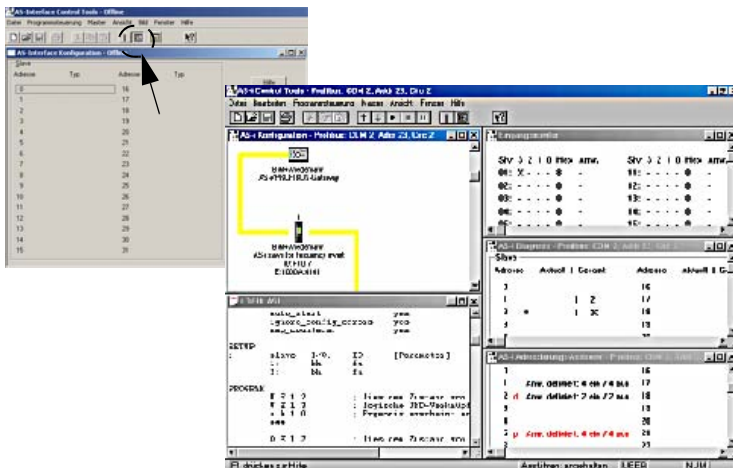

Issue date: 28.3.2012

Configuring the AS-i network is easily accomplished by first connecting each AS-i slave separately to the AS-i line and setting its address, followed by pressing the button “Store configuration” to store the existing AS-i network in the AS-i master as configuration data.

Furthermore, an **AS-i Address Assistant** is available, allowing to perform an address change of a new AS-i slave to the desired address as soon as it is connected to the AS-i network. The desired AS-i configuration can be created offline ahead of time and can be stored to a file. When setting up the system the AS-i slaves are then simply connected, one at a time, to the AS-i network. Further descriptions to all additional features of this software can be obtained from the integrated help file.

### 11.2 PROFIBUS DP Master Simulator

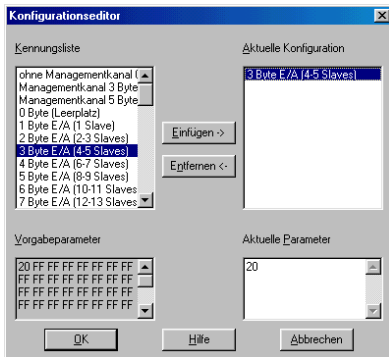
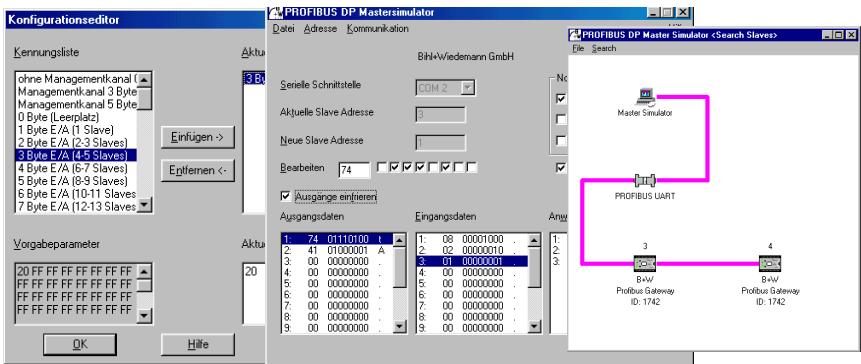

The PROFIBUS DP Master Simulator is an easy to use universal tool for data exchange with PROFIBUS slaves from almost any manufacturer using PROFIBUS DP. The PROFIBUS DP master simulator can exchange data with many PROFIBUS slaves even without GSD file, type-file, or PROFIBUS master. Furthermore, the PROFIBUS DP Master Simulator also processes GSD-files as well as the in-

put of special configurations to start the data exchange with the PROFIBUS slaves.. Addressing of PROFIBUS slaves - especially IP67 modules without addressing switch - is also possible.

The PROFIBUS DP Master Simulator also offers the possibility to scan a complete PROFIBUS network for connected users and to display them graphically. In this case, the **PROFIBUS UART** has to be connected directly to a PROFIBUS slave. I/O data, especially diagnostics data, can now be displayed in binary, hexadecimal, and ASCII format. The output data can be transmitted consistently. It is possible to hold an output as long as the mouse button is pressed in "click and hold" mode.

The new version of the PROFIBUS DP Master Simulator also supports PROFIBUS DP/V1, and therefore enables PROFIBUS slaves to be operated in the acyclic mode. This is especially helpful for the configuration and the startup of complex field devices like drives, modular I/O systems, etc.

The PROFIBUS Master Simulator is delivered with the **PROFIBUS UART**, the ideal interface converter between the RS 232 interface of a PC and PROFIBUS. The compact UART does not need an additional external power supply.

Therefore it is also suitable for mobile use with a laptop or a notebook. The **PROFIBUS UART** is simply inserted between the PROFIBUS and the RS 232 connector cable.

Additionally to the monitor and startup software DLL drivers for Windows NT, 2000, XP, Vista as well as simple examples written in C are supplied with the PROFIBUS UART. This offers the possibility to use the PROFIBUS UART in combination with other software applications. However, the PROFIBUS UART is a monitoring and startup tool for PROFIBUS slaves and is not designed to control automation processes.

### 11.3 Serial PROFIBUS Master



The serial PROFIBUS master fulfills all tasks of the PROFIBUS DP master simulator DP/V1. It can run PROFIBUS DP with up to 1,5 MBaud.

### 11.4 Additional information

For additional information please visit Bihl+Wiedemann's homepage: [www.bihl-wiedemann.de](http://www.bihl-wiedemann.de).

## 12. Appendix: Example for startup on a Siemens S7



### Information!

This example shows the start up of the AS-i 3.0 PROFIBUS Gateway in Stainless Steel BWU1567 on a Siemens S7-300 programmable logic controller. The start up is the same with new range of devices.

This example shows you how to start up the AS-i 3.0 PROFIBUS Gateway in Stainless Steel Art. No. BWU1567 on a Siemens S7-300 programmable logic controller.

Hardware used:	
SIMATIC S7 power supply	PS 307 5A
SIMATIC S7-CPU with PROFIBUS DP	CPU 315-2DP Order No.: 6ES7 315-2AF03-0AB0 Firmware Version 1.2
Bihl+Wiedemann AS-i 3.0 PROFIBUS Gateway in Stainless Steel	Art. no. BWU1567 Ident no. 11426
Bihl+Wiedemann AS-i-Power-Extender	Art. no. BWU1197 Ident no. 10558
Bihl+Wiedemann AS-i-4i Module	
Bihl+Wiedemann AS-i-4I/4O Module	
Power supply	Powers the AS-i components through the AS-i Power Extender
Software used:	
Bihl+Wiedemann GSD-File for the AS-i 3.0 PROFIBUS Gateway in Stainless Steel	Art. no. BWU1567
SIMATIC Step7 Version 5.4 SP4 Service Pack 1	Version: K5.4.4.0
Associated documentation:	
Bihl+Wiedemann AS-i/PROFIBUS-Gateway Operating Manual	
SIEMENS S7-300 documentation	

Current examples can be found in the download area on the Bihl+Wiedemann homepage.

### 12.1 Hardware configuration

#### 12.1.1 Electrical connection for AS-i

To supply the AS-i circuit, connect the output on the AS-i Power Extender or an AS-i power supply to the AS-i 3.0 PROFIBUS Gateway in Stainless Steel. Observe correct polarity of the terminals AS-i(+) and AS-i(-).

In the following the desired AS-i slaves are connected to the AS-i circuit. The AS-i slaves have their device address set to 0 by default. This must be changed to the desired AS-i slave address.

You can set the AS-i slave address using the function "AS-i SLAVE ADDR" function from the submenu "SETUP" on the AS-i 3.0 PROFIBUS Gateway in Stainless Steel. For more detailed information, refer to chapter "Operating in advanced Display Mode".

Once the AS-i circuit has been configured and parameterized as desired, apply this configuration to the AS-i 3.0 PROFIBUS Gateway in Stainless Steel using the function "QUICK SETUP".

The AS-i 3.0 PROFIBUS Gateway in Stainless Steel is now ready to run.

### 12.1.2 Electrical connection for PROFIBUS DP

To connect the AS-i 3.0 PROFIBUS Gateway in Stainless Steel to the CPU 315-2DP, a standard PROFIBUS cable with 9-pin SUB-D plug is used.

If the AS-i 3.0 PROFIBUS Gateway in Stainless Steel is connected on the PROFIBUS as the last station, the termination resistor on the PROFIBUS plug must be enabled.

## 12.2 SIMATIC Step 7 Configuration

The remainder of this description presumes that a SIMATIC Step7 project has been created and added to an S7-300.

Now the hardware configuration must be opened for this SIMATIC-300 station.

### 12.2.1 Configuration of the Hardware

Before configuring the hardware, the GSD file 15671745.gsd supplied with the AS-i 3.0 PROFIBUS Gateway in Stainless Steel must be added to the hardware catalog.

Add the GSD file using the menu function "Install new GSD".

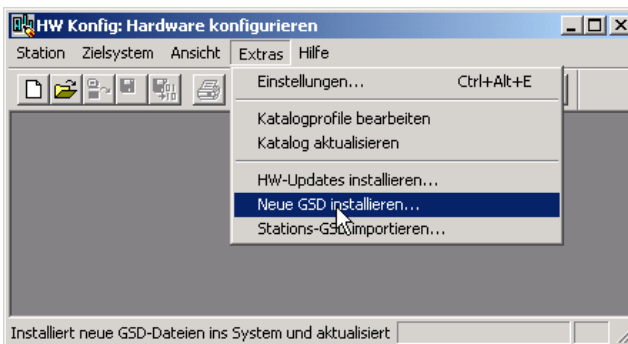

The PROFIBUS properties of the Bihl+Wiedemann AS-i 3.0 PROFIBUS Gateway in Stainless Steel are described in the GSD file 15671745.gsd.

Clicking on the "Open" field adds the GSD file "15671745.gsd" to the hardware catalog.

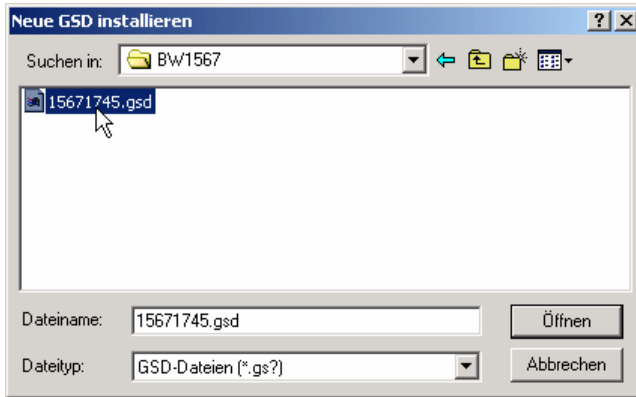

Clicking on the "Open" field adds the GSD file "15671745.gsd" to the hardware catalog.

After successful installation of the GSD file you may now open the hardware catalog. The modules contained under SIMATIC 300.

- 9. profile rail
- 10. power supply e.g. PS 307 5A
- 11. CPUe.g. CPU 315-2 DP

are added to the project. When selecting the CPU module, note the correct hardware version (identifiable by the imprint of the part number at lower left) and the firmware version (identifiable at left beneath the cover).

Steckplatz	Baugruppe	Bestellnummer	Firmware	MPI-Adresse	E-Adresse	A-Adresse
1	PS 307 5A	6ES7 307-1EA00-0AA0				
2	<b>CPU 315-2 DP</b>	<b>6ES7 315-2AF03-0AB0</b>	<b>V1.2</b>	2		
X2	DP				1023*	
3						

When adding the CPU module you are prompted for the desired PROFIBUS connection. The standard proposed is for the CPU as PROFIBUS DP Master. This can be directly applied. The CPU mode must be set on the DP Master.

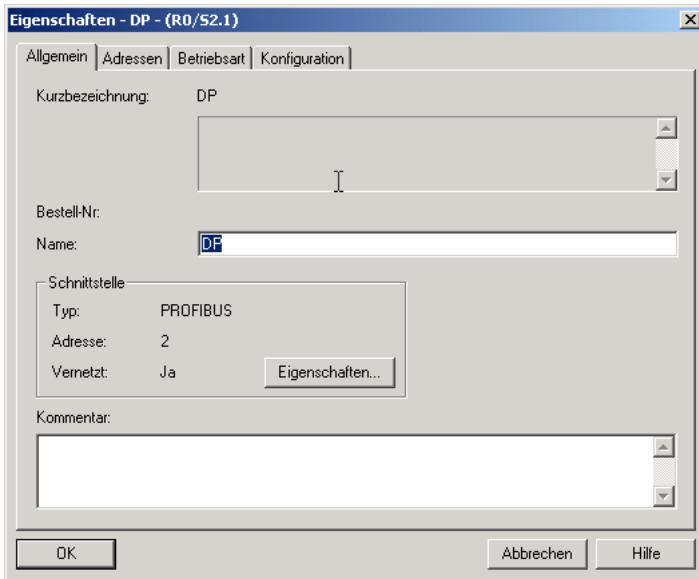

The CPU PROFIBUS DP Properties can be used to display the properties for the PROFIBUS. Clicking on the "Settings" button displays the PROFIBUS settings.

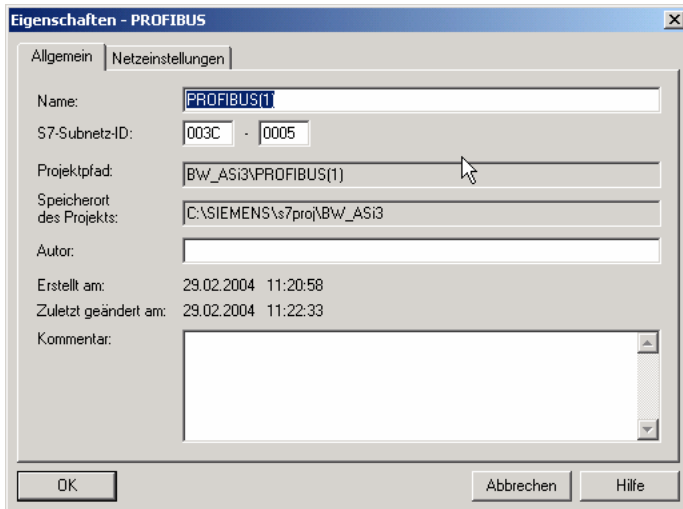

Profile "DP" is generally used as the PROFIBUS profile.

The bit rate for the PROFIBUS can be set in the window "Properties PROFIBUS" → "Network settings" → "Transmission rate".

If special adjustments are needed, you can adjust the PROFIBUS parameters using the profile "Properties PROFIBUS" → "Network settings" → "Profile" → "User defined".

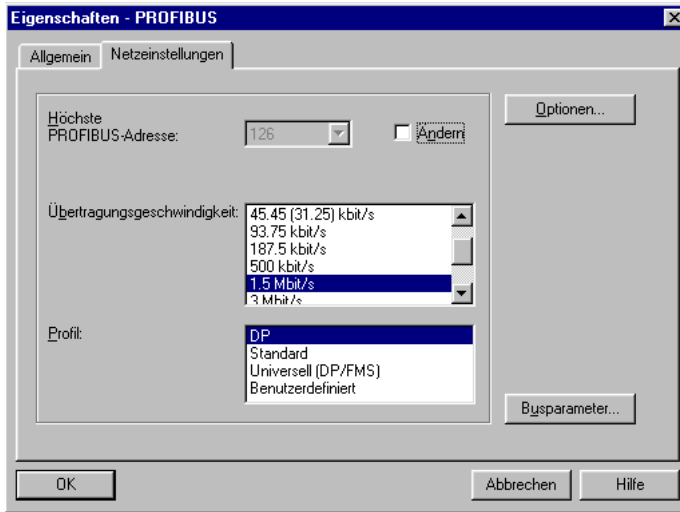

### 12.2.2 Insert AS-i 3.0 PROFIBUS Gateway in Stainless Steel

Once the SIMATIC hardware has been added to the hardware configuration and the PROFIBUS configured, you can add the Bihl+Wiedemann AS-i 3.0 PROFIBUS Gateway in Stainless Steel to the project.

After successfully installing the GSD file "15671745.gsd" you will find the AS-i 3.0 PROFIBUS Gateway in Stainless Steel in the hardware catalog under **PROFIBUS/other FIELD DEVICES/Gateway/AS-i**.

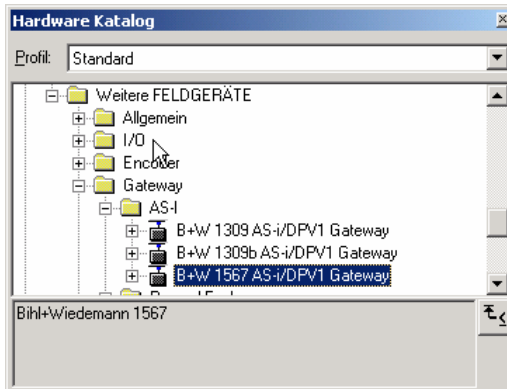

Issue date: 28.3.2012

The AS-i 3.0 PROFIBUS Gateway in Stainless Steel is called "Bihl+Wiedemann BWU1567 GW+Safety Mon" in the catalog and can now be added to the PROFIBUS branch using drag and drop.

Opening the device "Bihl+Wiedemann BWU1567 GW+Safety Mon" by clicking on the plug sign in the hardware catalog causes a list to appear of the possible PROFIBUS communication modules.

Which module you select for the desired PROFIBUS communication depends on which version of the AS-i circuit you have and on the desired communication possibilities.

For simple transmission of the data bits in an AS-i circuit with AS-i standard sensors in the I/O area of the SIMATIC CPU, use the module "16 Byte Digital In/Out (0-31)". With this module the input and output data for the possible 31 slaves in an AS-i circuit are send directly to the I/O section of the CPU.

When using A/B slaves, use the module "32 Byte Digital In/Out (0-31B)". The B-addressed slaves are mapped in the additional 15 bytes of data.

The other modules called "Digital" can be used instead of the above mentioned module to adapt to the actual AS-i circuit. This makes flexible adaptation to the structure of the AS-i circuit possible.

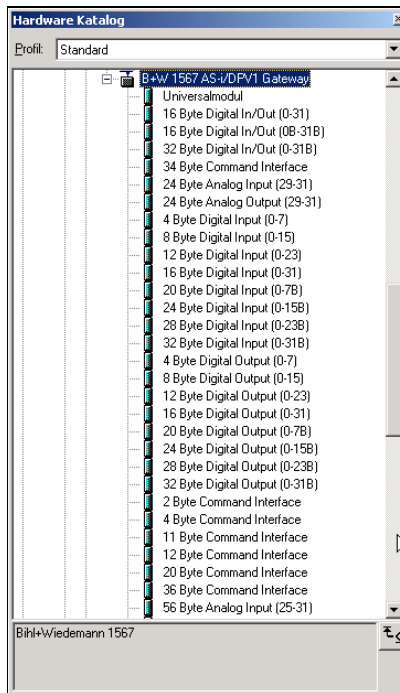

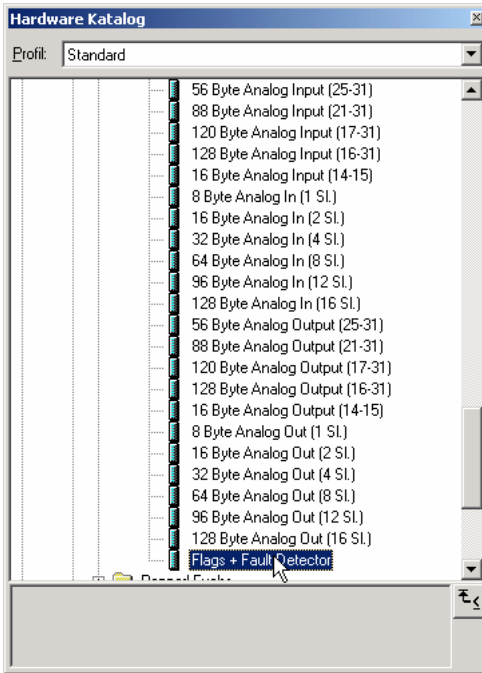

In addition to sending the AS-i slave digital data, a communication interface module can be added. The communication interface is used for sending specific commands to the AS-i 3.0 PROFIBUS Gateway in Stainless Steel. More details about this can be found in chap. 9.

In order to send the analog values for AS-i slaves directly, the modules can be used with the keyword "Analog". The value in parentheses indicates which address range is to be used for the AS-i Analog slaves.

For modules "nn Byte Analog In (n Sl.)" and "nn Byte Analog Out (n Sl.)" the AS-i address of the analog slave can be freely selected.

When adding the AS-i 3.0 PROFIBUS Gateway in Stainless Steel "Bihl+Wiedemann BWU1567 GW+Safety Mon" using drag and drop the dialog for assigning the PROFIBUS slave address is shown. The factory default setting for the AS-i 3.0 PROFIBUS Gateway in Stainless Steel is Address 3.

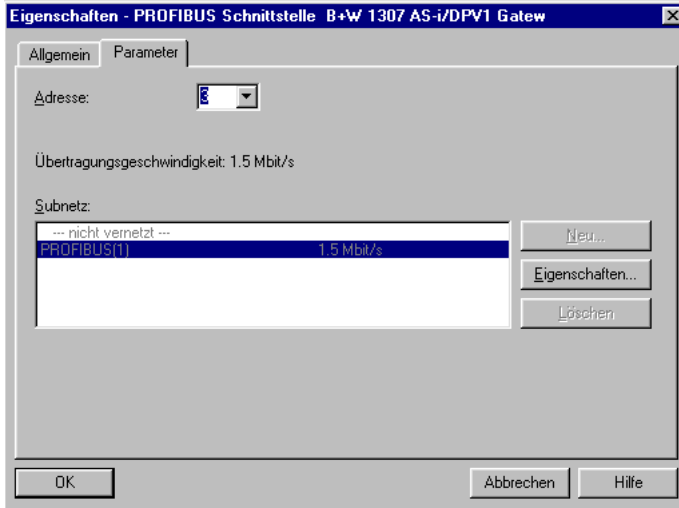

### 12.2.3 Configuring AS-i 3.0 PROFIBUS Gateway in Stainless Steel in-/output

If the AS-i 3.0 PROFIBUS Gateway in Stainless Steel is added to the PROFIBUS using drag and drop, the Step7 hardware configuration shows the following graphic.

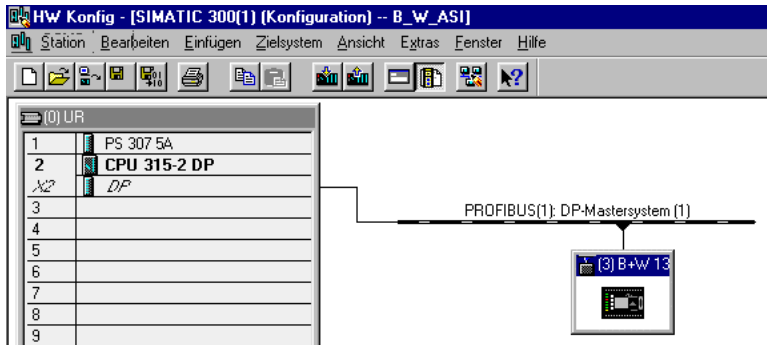

At this point the desired PROFIBUS communication module should be parameterised. This is done in the following steps:

1. Select the AS-i 3.0 PROFIBUS Gateway in Stainless Steel by clicking on the Slave icon. In the lower edge of the screen a table is shown which contains lines beginning with Slot 0.

2. Select the desired communication module "Flags + Fault Detector" from the hardware catalog. These flags use the individual bits to signal the operating status of the AS-i 3.0 PROFIBUS Gateway in Stainless Steel and should be processed in the application program.
3. Drag the selected communication module to the table line for Slot 0.

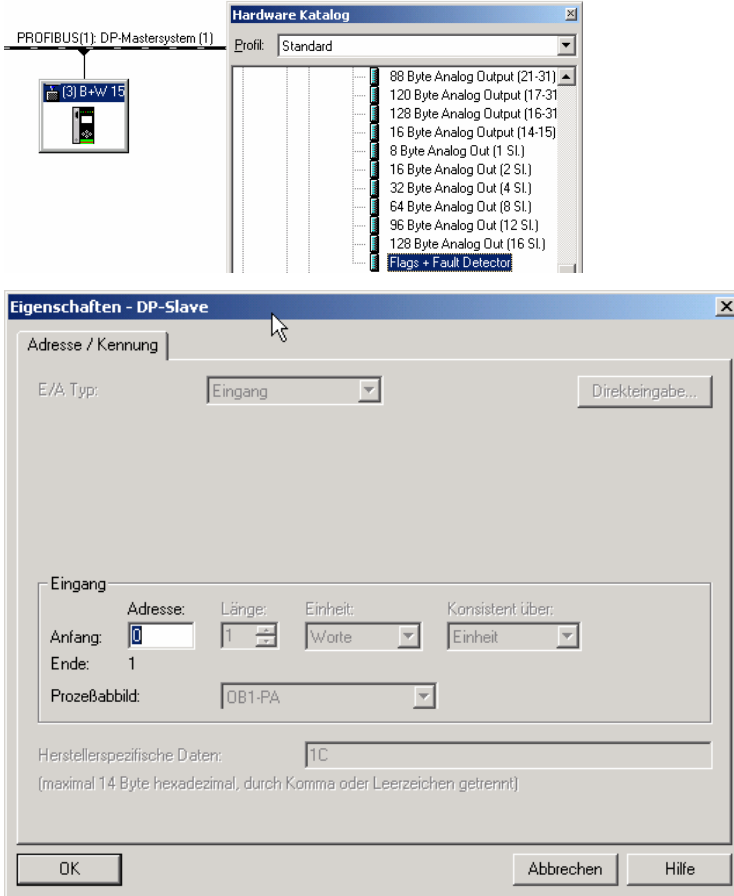

4. Select the desired communication module from the hardware catalog. Here "16 Byte Digital In/Out (0-31)"

5. Drag the selected communication module to the table line for slot 1.

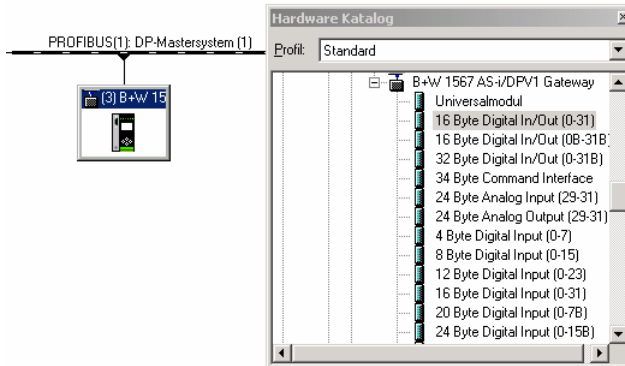

6. If desired, you can now place additional modules for the command interface and analog value transmission in the following slots:

Steckplatz	DP-Kennung	Bestellnummer / Bezeichnung	E-Adresse	A-Adresse	Kommentar
0	65	Flags + Fault Detector	0...1		
1	193	16 Byte Digital In/Out (0-31)	2...17	2...17	
2					
3					

7. Double-clicking on the desired slot line opens a dialog window in which you can assign the PROFIBUS communication module to the address range of the CPU.

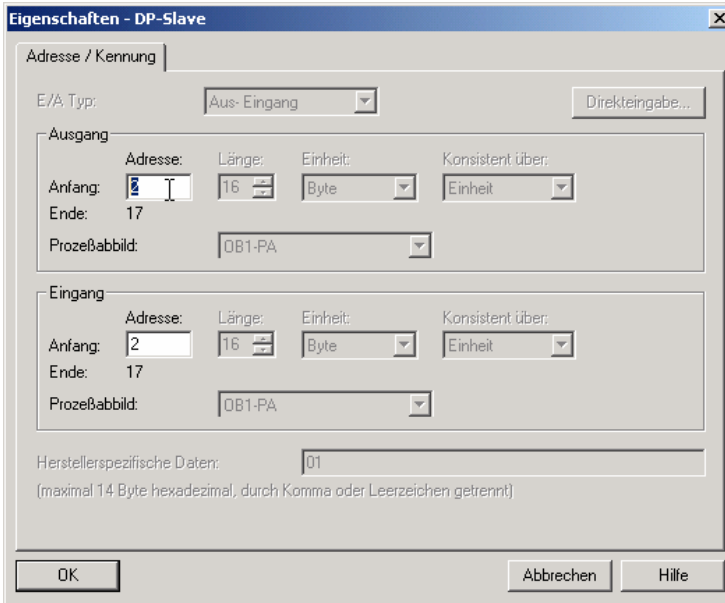

In this example the data transfer of the 16 byte in-/output data of the AS-i 3.0 PROFIBUS Gateway in Stainless Steel takes place in (out) the CPU address range Input (output) data image byte 0 to 15.

#### 12.2.4 AS-i 3.0 PROFIBUS Gateway in Stainless Steel parameters

The AS-i 3.0 PROFIBUS Gateway in Stainless Steel is symbolically represented as a rectangular window connected with the PROFIBUS branch. Double-clicking in the upper line of this window [(3) B+W 15] opens the dialog window for the properties of this PROFIBUS slave.

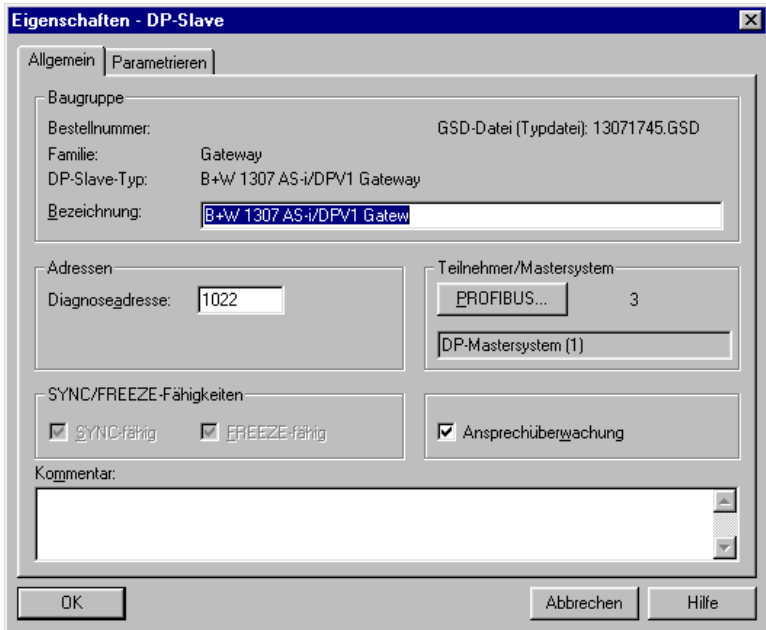

The diagnostics address entered in this window is used for parameterizing the function module SFC13 (diagnostic request). At this address you can use the standard function SFC13 to read out the PROFIBUS diagnostic data of this DP slave while running.

When invoking SFC13, note that the diagnostic address must be parameterized as a hexadecimal value.

For example: Diagnostic address 1022 → W#16#3FE

Clicking on the "Parameterize" tab displays the possible settings for the PROFIBUS start parameters.

### 12.2.4.1 General DP parameters

Startup when nominal configuration is not the same as actual configuration:

Use this parameter to specify whether the AS-i circuit should be started up even if the AS-i circuit has a different configuration than the stored AS-i configuration.

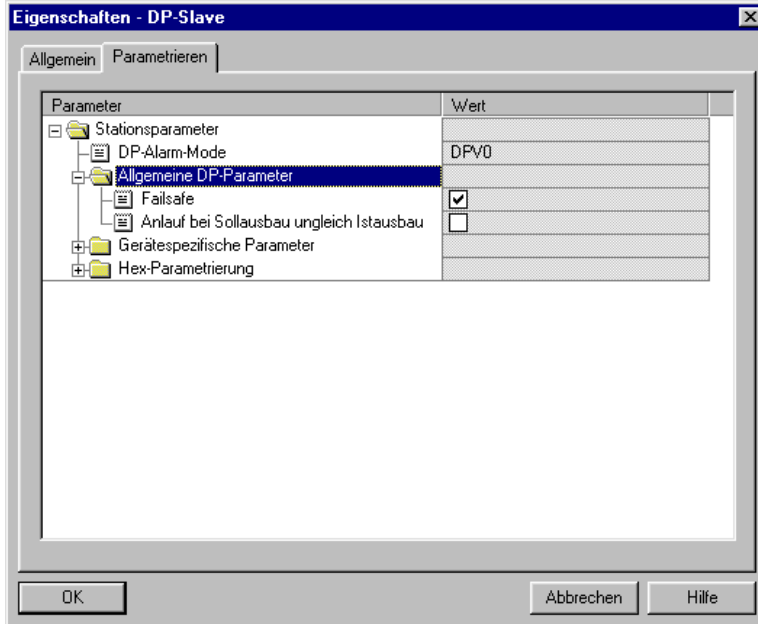

### 12.2.4.2 Device-specific parameters

Acyclic Communication

Turning acyclic PROFIBUS DP communication on/off according to the DPV1 standard.

Default: Communication turned on according to DPV1.

AS-i Flags

Specifies whether the AS-i flags are sent in the PROFIBUS diagnostic.

Default: Transmission in the PROFIBUS diagnostic data.

List of Configuration Errors

The AS-i 3.0 PROFIBUS Gateway in Stainless Steel saves a list of all AS-i slaves which have triggered a present configuration error. This list can be sent with the PROFIBUS diagnostic data.

Default: Transmission in the PROFIBUS diagnostic data.

#### List of Peripheral Faults

The AS-i 3.0 PROFIBUS Gateway in Stainless Steel saves a list of all AS-i slaves which have triggered a peripheral errors. This list can be sent with the PROFIBUS diagnostic data.

Default: Transmission in the PROFIBUS diagnostic data.

#### Earth Fault

The AS-i 3.0 PROFIBUS Gateway in Stainless Steel can detect an earth (ground) fault. The information as to whether there is or is not an earth fault is sent in the diagnostic data.

Default: Transmission in the PROFIBUS diagnostic data.

#### Double Address

The AS-i 3.0 PROFIBUS Gateway in Stainless Steel detects when there is double addressing. This list can be sent with the diagnostic data.

Default: Transmission in the PROFIBUS diagnostic data.

#### Noise and Over voltage

The AS-i 3.0 PROFIBUS Gateway in Stainless Steel analyzes the quality of the AS-i voltage during running. This assessment can be sent with the diagnostic data.

Default: Not transmitted in the PROFIBUS diagnostic data.

#### ExtDiag on Configuration Errors

When an AS-i configuration error occurs, the AS-i 3.0 PROFIBUS Gateway in Stainless Steel sets the ExtDiag flag in its PROFIBUS data reply. By setting this flag the Profibus DP slave tells the PROFIBUS master that there is an error condition and that the diagnostic data are being updated.

In the case of the S7 controller invoking of the OB82 is triggered when an ExtDiag flag is set. If the latter is not present, the controller is stopped.

Setting this ExtDiag flag can be suppressed using this parameter. Consequently no interrupt controlled OB82 invoking is triggered in the controller, and the controller must then respond to a possible AS-i configuration error by checking the AS-i flag in the input data.

Default: Setting of the ExtDiag flag for AS-i configuration error is enabled.

#### ExtDiag on AS-i Power Fail

Activates and deactivates setting of the ExtDiag flag on AS-i power fail.

Default: Setting of the ExtDiag flag on AS-i power fail is enabled.

#### ExtDiag on Peripheral Faults

Activates and deactivates setting of the ExtDiag flag on peripheral faults.

Default: Setting of the ExtDiag flag on peripheral faults disabled.

#### ExtDiag on Earth Fault

Activates and deactivates setting of the ExtDiag flag on earth (ground) fault.

Default: Setting of the ExtDiag flag on earth fault is disabled.

#### ExtDiag on Double Address

Activates and deactivates setting of the ExtDiag flag on double address.

Default: Setting of the ExtDiag flag on double address is disabled.

#### Freeze Diagnosis

The diagnostic data are continuously updated during runtime. If this is not desired, this parameter can be used to disable continuous updating. Updating then takes place only when this is required by the PROFIBUS standard.

#### AS-i Input Change Buffers

Default: Disabled.

#### Download Slave Parameters

Based on this entry the parameter bits can be downloaded for each AS-i slave. These are then sent to the connected AS-i slave when the AS-i cycle is started. Sending of the set parameters bits can be disabled with this value.

Default: Sending of the AS-i parameter bits enabled.

#### AS-i-Parameter Slave 1/1A...

The parameter bits send to this AS-i slave can be selected in the drop down window. The settings which are made with the parameters bits can be found in the data sheet for the corresponding slave.

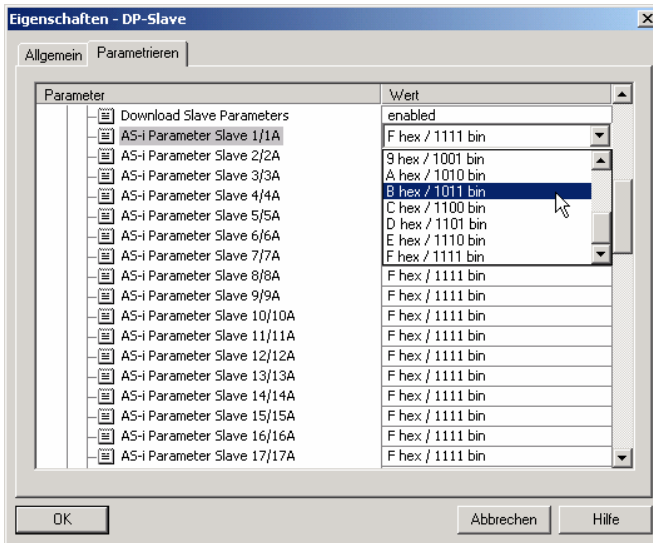
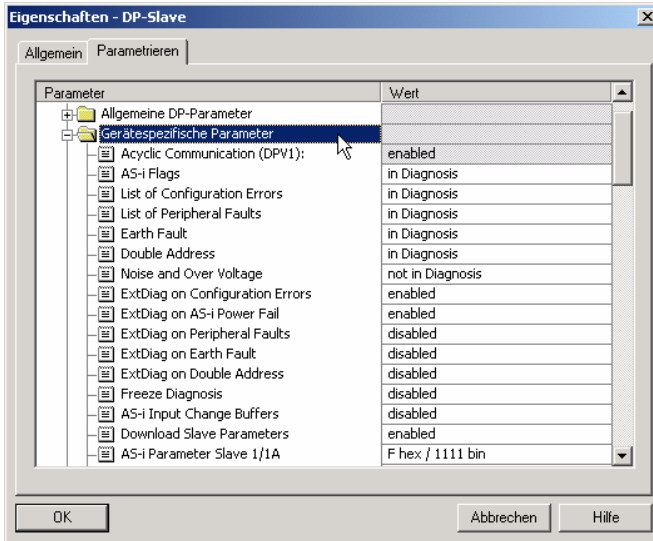

Issue date: 28.3.2012

### 12.2.4.3 Hex parameterizing

DPV1\_Status

Hexadecimal representation of the data resulting from the settings for parameter bytes 0 to 2.

User\_Prm\_Data

Hexadecimal representation of the data resulting from the settings for parameter bytes 3 to 37.

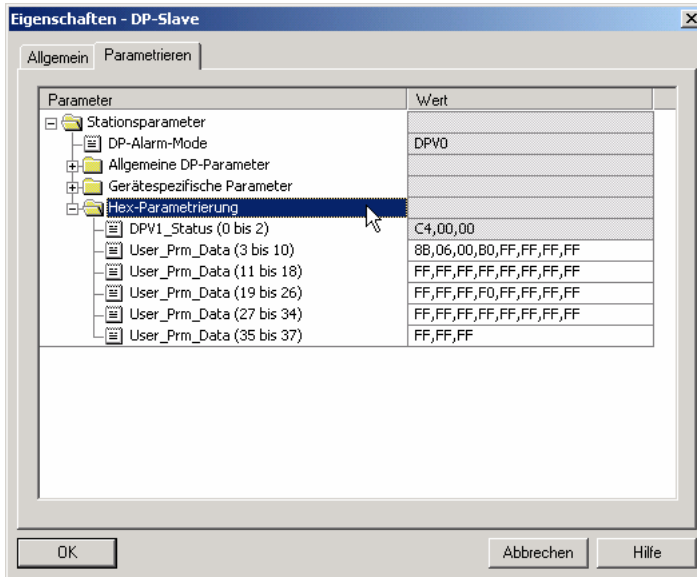

### 12.2.5 SIMATIC Step7 blocks

After the hardware has been configured, these can be sent to the CPU. Since data transmission of the AS-i data is done in this example directly to the process image, no additional Step7 program is needed for data refreshing. Therefore there is no program code in OB1.

OB1: Cyclical program block. Access to the AS-i data is via the parameterized address space in the in-/outputs process image.

OB82: PROFIBUS diagnostic alarm. This OB is invoked as soon as a PROFIBUS slave has set the ExtDiag flag in the telegram reply. This ExtDiag flag allows a PROFIBUS slave to report an error condition to a PROFIBUS master. If OB82 is not present, the CPU is stopped when a PROFIBUS slave sets the ExtDiag flag.

OB86: PROFIBUS peripheral error. This OB is invoked when the PROFIBUS master detects a PROFIBUS slave failure.

OB100: Startup OB. This OB is run once when the CPU starts up.

VAT\_ASI\_IO Variable table, AS-i startup example.

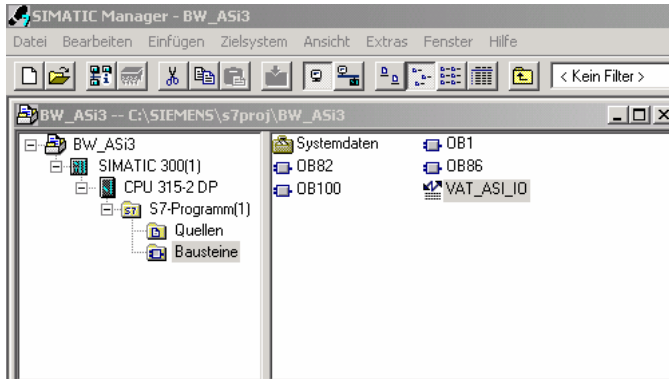

### 12.2.6 Variable table VAT\_ASI\_IO

In the hardware configuration the 16 bytes of I/O data for the AS-i/DP Gateway are coupled to the input/output byte Address 2 to 17 of the process image. The directly send AS-i diagnostic information for error processing are evident from the input bits of the EW0.

Flags + Fault Detector

Bit 0 = Configuration error

Bit 1 = Slave with address ZERO detected

Bit 2 = Automatic addressing not possible

Bit 3 = Automatic addressing available

Bit 4 = Projecting mode active

Bit 5 = Not in normal mode

Bit 6 = AS-i Power Fail

Bit 7 = AS-i Master is offline

Bit 8 = Peripheral error

Bit 9 = reserved

Bit 10 = reserved

Bit 11 = reserved

Bit 12 = Earth fault

Bit 13 = Overvoltage

Bit 14 = Noise

Bit 15 = Double address

This allows the AS-i circuit data to appear directly in the process image inputs/ outputs.

VAT_ASI_ID -- @BW_ASI3\SIMATIC300(1)\CPU315-2 DP\S7-Programm(1) ONLINE						
	Operand	Symbol	Symbolkommentar	Anzeig	Statuswert	
1	EB 2	"IN_Flags_Slave1"	Bit7-4=Flags Bit3-0=Slave1	BIN	2#0000_1000	
2	EB 3	"IN_Slave2_Slave3"	Bit7-4=Slave2 Bit3-0=Slave3	BIN	2#0100_0000	
3	EB 4	"IN_Slave4_Slave5"	Bit7-4=Slave4 Bit3-0=Slave5	BIN	2#0000_0000	
4	EB 5	"IN_Slave6_Slave7"	Bit7-4=Slave6 Bit3-0=Slave7	BIN	2#0000_0000	
5	EB 6	"IN_Slave8_Slave9"	Bit7-4=Slave8 Bit3-0=Slave9	BIN	2#0000_0000	
6	E 2.4	"IN_ASI_Config_Error"	0=ConfigOK 1=ConfigError	BOOL	false	
7	E 2.5	"IN_ASI_Power_Fail"	0=AS-iPowerOK 1=AS-iPowerError	BOOL	false	
8	E 2.6	"IN_Periphery_Fault"	0=PeripheryOK 1=PeripherieError	BOOL	false	
9	E 2.7	"IN_Configuration_Active"	0=ConfigActive 1=ConfigInactiv	BOOL	false	
10						
11	AB 2	"OUT_Flags_Slave1"	Bit7-4=Flags Bit3-0=Slave1	BIN	2#0000_0000	
12	AB 3	"OUT_Slave2_Slave3"	Bit7-4=Slave2 Bit3-0=Slave3	BIN	2#0000_0100	
13	AB 4	"OUT_Slave4_Slave5"	Bit7-4=Slave4 Bit3-0=Slave5	BIN	2#0000_0000	
14	AB 5	"OUT_Slave6_Slave7"	Bit7-4=Slave6 Bit3-0=Slave7	BIN	2#0000_0000	
15	AB 6	"OUT_Slave8_Slave9"	Bit7-4=Slave8 Bit3-0=Slave9	BIN	2#0000_0000	
16	A 2.4	"OUT_ASI_Off_Line"	0=OnLine 1=OffLine	BOOL	false	
17	A 2.5	"OUT_LOS_Masterbit"	0=OffLine when ConfigError 1=active when ConfigError	BOOL	false	
18	A 2.6	"OUT_Configuration_Mode"	-> Set Configuration Mode	BOOL	false	
19	A 2.7	"OUT_Protected_Mode"	-> Set Protected Mode	BOOL	false	
20						
21	EW 0	"FLags + Fault Detector"	AS-i Diagnose Information	BIN	2#0000_0000_0000_0000	
22						

In the structure of the 16 byte I/O data field each AS-i slave has a 4-bit data field. This is determined by the address of the AS-i slave within the AS-i circuit.

Assignment of the I/O address and AS-i slave address		
Address byte	Bits 7 - 4	Bits 3 - 0
I/O byte 2	flags	slave 1
I/O byte 3	slave 2	slave 3
I/O byte 4	slave 4	slave 5
I/O byte 5	slave 6	slave 7
I/O byte 6	slave 8	slave 9
I/O byte 7	slave 10	slave 11
I/O byte 8	slave 12	slave 13
I/O byte 9	slave 14	slave 15
I/O byte 10	slave 16	slave 17
I/O byte 11	slave 18	slave 19
I/O byte 12	slave 20	slave 21
I/O byte 13	slave 22	slave 23
I/O byte 14	slave 24	slave 25
I/O byte 15	slave 26	slave 27
I/O byte 16	slave 28	slave 29
I/O byte 17	slave 30	slave 31

The data for the slaves present and projected in the AS-i circuit are refreshed based on their position in the I/O data field.

The data fields for non-present slaves are filled with zero.

This means for example the AS-i data for the AS-i slave having Address 12 occupies bits 7 - 4 in I/O byte 8 of the controller.

### 12.2.6.1 AS-i flags byte 0, input bits 7 - 4

In order to check the current operating status of the AS-i circuit, the AS-i flags refreshed with each PROFIBUS cycle can be used. These for flags occupy bits 7 - 4 in input byte 0.

AS-i Config Error:

Bit 4: 0 = AS-i configuration OK, 1 = AS-i configuration faulty

If during running the gateway AS-i master detects a discrepancy between the nominal configuration and the actual configuration, this bit is set. This allows the control program to react to a faulty AS-i slave.

AS-i Power Fail

Bit 5: 0 = AS-i power OK, 1 = AS-i power fail

When there is a failure of the AS-i supply voltage, this is indicated by the AS-i power fail bit.

AS-i Peripheral Error

Bit 6: 0 = AS-i peripheral OK, 1 = AS-i peripheral error

This bit indicates that there is a peripheral error on an AS-i slave. This may result for example from incorrect parameterizing of the AS-i slave.

AS-i Configuration Active

Bit 7: 0 = AS-i configuration is active, 1 = AS-i configuration is inactive.

This bit indicates whether the AS-i gateway is in protected mode (Bit 7 = 0) or in projecting mode.



#### **Information!**

*It is recommended that the AS-i flags be checked in the control program and to respond according to the reported states.*

### 12.2.6.2 AS-i flags byte 0, output bits 7 - 4

Output bits 7 - 4 in byte 0 can be used to affect the status of the AS-i circuit by the controller.

AS-i Off Line

Bit 4: 0 = Online, 1 = Offline

Use this bit to enable/disable the data cycle of the AS-i circuit. If the AS-i Master is in offline mode, no AS-i communication with the AS-i slaves will take place.

AS-i LOS Master Bit

Bit 5: 0 = Offline when AS-i configuration error disabled, 1 = enabled

If this bit is set, the AS-i Master immediately switches to the offline phase and stops AS-i communication when an AS-i configuration error is detected. This results in the connected AS-i output modules immediately switching to safe mode (outputs turned off).

#### AS-i Configuration Mode

Bit 6: 0 = no action, 1 = turn on configuration mode of AS-i Master

Setting Bit 6 switches the AS-i Master to configuration mode. Then for example the command interface can be used to save an existing AS-i configuration using the controller.

The rising edge is used for switching. After Bit 7 = 1 in the input flags has indicated that the AS-i Master is in configuration mode, output bit 6 must be reset again by the controller.

#### AS-i Protected Mode

Bit 6: 0 = no action, 1 = turn on protected mode of AS-i Master

After successful configuration of the AS-i Master through the command interface, the AS-i Master can be switched back to protected mode.

The rising edge is used for switching. After Bit 7 = 0 in the input flags has indicated that the AS-i Master is in configuration mode, output bit 7 must be reset again by the controller.

The table shows an AS-i circuit which is in operation. Since there is no AS-i error, bits 4 - 7 in the input byte are ZERO.

In the case of AS-i Slave address 1, this is a 4 I/O module. In this module Output 3 is set and Input 1 allocated.

AS-i Slave address 2 is a 4 Input module. Input 2 is set.

@VAT_ASI_IO -- B_W_ASI\SIMATIC 300(1)\CPU 315-2 DP\S7-Programm(1)						
	Operand	Symbol	Anzei	Statuswert	Steuerwert	
1	EB 0	"IN_Flags_Slave1"	BIN	2#0000_0001		
2	EB 1	"IN_Slave2_Slave3"	BIN	2#0010_0000		
3	EB 2	"IN_Slave4_Slave5"	BIN	2#0000_0000		
4	EB 3	"IN_Slave6_Slave7"	BIN	2#0000_0000		
5	EB 4	"IN_Slave8_Slave9"	BIN	2#0000_0000		
6	E 0.4	"IN_ASI_Config_Error"	BOOL	false		
7	E 0.5	"IN_ASI_Power_Fail"	BOOL	false		
8	E 0.6	"IN_Periphery_Fault"	BOOL	false		
9	E 0.7	"IN_Configuration_Active"	BOOL	false		
10						
11	AB 0	"OUT_Flags_Slave1"	BIN	2#0000_0100	2#0000_0100	
12	AB 1	"OUT_Slave2_Slave3"	BIN	2#0000_0000		
13	AB 2	"OUT_Slave4_Slave5"	BIN	2#0000_0000		
14	AB 3	"OUT_Slave6_Slave7"	BIN	2#0000_0000		
15	AB 4	"OUT_Slave8_Slave9"	BIN	2#0000_0000		
16	A 0.4	"OUT_ASI_Off_Line"	BOOL	false		
17	A 0.5	"OUT_LOS_Masterbit"	BOOL	false		
18	A 0.6	"OUT_Configuration_Mode"	BOOL	false	false	
19	A 0.7	"OUT_Protected_Mode"	BOOL	false	false	
20						

### 12.2.7 System behavior on AS-i Config Error

If while running in protected mode a configured AS-i slave fails, an AS-i configuration error is generated.

1. The missing slave is shown on the display of the AS-i 3.0 PROFIBUS Gateway in Stainless Steel.
2. The input flag AS-i Config Error bit 4 in byte 2 is set.
3. If the standard parameters for the PROFIBUS hardware configuration were applied unchanged for the AS-i 3.0 PROFIBUS Gateway in Stainless Steel, the Gateway sets the ExtDiag flag in the PROFIBUS data reply. This results in the controller signaling a PROFIBUS slave error and invoking OB82. At the same time the event is written to the diagnostic buffer of the CPU.

If the message for the ExDiagFlag is turned off in the PROFIBUS parameters, no PROFIBUS message is generated and OB82 is not activated. This is always recommended for applications which do not have to respond immediately to an error using OB82. In such cases the status can be processed using the message bit of the AS-i Flags or the Flags + Fault Detector bits for the normal PLC cycle. Error management can be structured on the basis of these messages.

	Operand	Symbol	Anzeigeforma	Statuswert	Steuerwert
1	EB 0	"IN_Flags_Slave1"	BIN	2#0001_0000	
2	EB 1	"IN_Slave2_Slave3"	BIN	2#0000_0000	
3	EB 2	"IN_Slave4_Slave5"	BIN	2#0000_0000	
4	EB 3	"IN_Slave6_Slave7"	BIN	2#0000_0000	
5	EB 4	"IN_Slave8_Slave9"	BIN	2#0000_0000	
6	E 0.4	"IN_ASI_Config_Error"	BOOL	true	
7	E 0.5	"IN_ASI_Power_Fail"	BOOL	false	
8	E 0.6	"IN_Periphery_Fault"	BOOL	false	
9	E 0.7	"IN_Configuration_Active"	BOOL	false	
10					
11	AB 0	"OUT_Flags_Slave1"	BIN	2#0000_0000	
12	AB 1	"OUT_Slave2_Slave3"	BIN	2#0000_0000	
13	AB 2	"OUT_Slave4_Slave5"	BIN	2#0000_0000	
14	AB 3	"OUT_Slave6_Slave7"	BIN	2#0000_0000	
15	AB 4	"OUT_Slave8_Slave9"	BIN	2#0000_0000	
16	A 0.4	"OUT_ASI_Off_Line"	BOOL	false	
17	A 0.5	"OUT_LOS_Masterbit"	BOOL	false	
18	A 0.6	"OUT_Configuration_Mode"	BOOL	false	false
19	A 0.7	"OUT_Protected_Mode"	BOOL	false	false
20					

In the diagnostic buffer of the CPU the configuration error which occurred is entered with "Module error".

The affected AS-i 3.0 PROFIBUS Gateway in Stainless Steel can be ascertained from the diagnostic address of the slave which reports the error. This diagnostic address is evident as a parameter of the OB82 when it is invoked. The event is declared as an incoming event.

**Appendix: Example for startup on a Siemens S7**

The diagnostic address, here 1022, refers to the specification in the hardware specification of the S7 with respect to the AS-i 3.0 PROFIBUS Gateway in Stainless Steel.

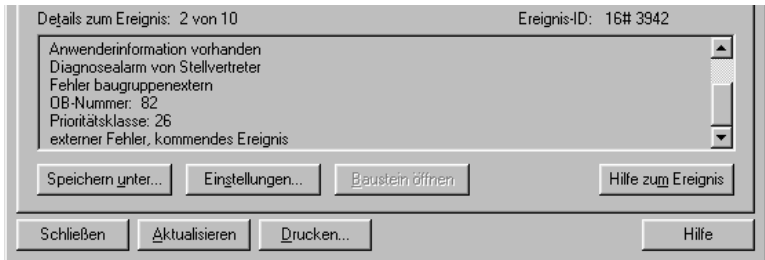
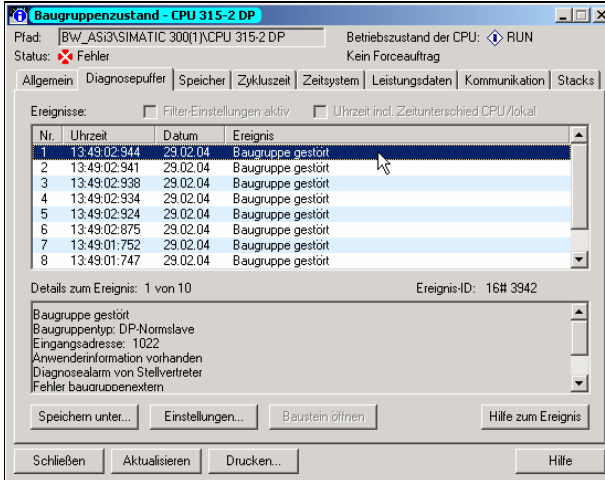

As soon as the AS-i configuration error is cleared, the OB82 is invoked again. In turn the diagnostic address of the AS-i 3.0 PROFIBUS Gateway in Stainless Steel, here 1022, is entered as a parameter and the event is declared as an outgoing event.

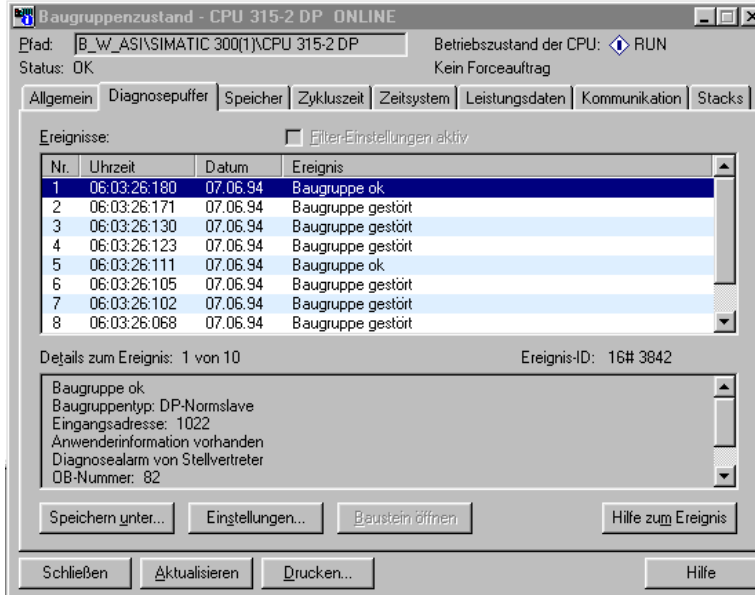

The screenshot shows the 'Baugruppenzustand - CPU 315-2 DP ONLINE' window. The path is 'B\_W\_ASI\SIMATIC 300(1)\CPU 315-2 DP' and the CPU status is 'RUN'. The 'Ereignisse' tab is active, showing a list of events. The details for event 1 are expanded.

Nr.	Uhrzeit	Datum	Ereignis
1	06:03:26:180	07.06.94	Baugruppe ok
2	06:03:26:171	07.06.94	Baugruppe gestört
3	06:03:26:130	07.06.94	Baugruppe gestört
4	06:03:26:123	07.06.94	Baugruppe gestört
5	06:03:26:111	07.06.94	Baugruppe ok
6	06:03:26:105	07.06.94	Baugruppe gestört
7	06:03:26:102	07.06.94	Baugruppe gestört
8	06:03:26:068	07.06.94	Baugruppe gestört

Details zum Ereignis: 1 von 10      Ereignis-ID: 16# 3842

Baugruppe ok  
 Baugruppentyp: DP-Normslave  
 Eingangsadresse: 1022  
 Anwenderinformation vorhanden  
 Diagnosealarm von Stellvertreter  
 OB-Nummer: 82

Buttons: Speichern unter..., Einstellungen..., Baustein öffnen, Hilfe zum Ereignis, Schließen, Aktualisieren, Drucken..., Hilfe

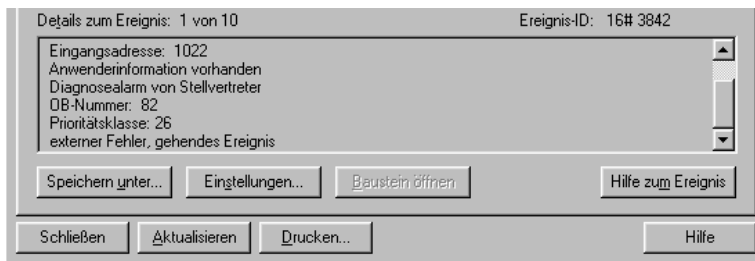

This is a close-up of the 'Details zum Ereignis' window for event 1. It shows the following information:

Details zum Ereignis: 1 von 10      Ereignis-ID: 16# 3842

Eingangsadresse: 1022  
 Anwenderinformation vorhanden  
 Diagnosealarm von Stellvertreter  
 OB-Nummer: 82  
 Prioritätsklasse: 26  
 externer Fehler, gehendes Ereignis

Buttons: Speichern unter..., Einstellungen..., Baustein öffnen, Hilfe zum Ereignis, Schließen, Aktualisieren, Drucken..., Hilfe

Entry of the error messages in the diagnostic buffer of the CPU and invoking of the OB82 is a consequence of the set ExtDiag flag for an error in the AS-i 3.0 PROFIBUS Gateway in Stainless Steel.

This can be prevented by turning off the ExtDiag flag in the PROFIBUS parameters of the AS-i 3.0 PROFIBUS Gateway in Stainless Steel.

The errors can be responded to by the controller by querying the AS-i flag in the input data. This means a configuration error is reported twice in a standard case: Once via the AS-i flag Config Error and once via the ExtDiag flag in the PROFIBUS telegram.

If for timing reasons an AS-i error must be responded to in a non-interrupt controlled way, the message can be turned off using the ExtDiag flag. In this case it is sufficient to check the AS-i flag Config Error in the program sequence.

The same applies to the other messages.

If the message for various error states of the AS-i 3.0 PROFIBUS Gateway in Stainless Steel is activated via the PROFIBUS and if the data for the PROFIBUS diagnostic data are enabled, the SIEMENS function module SFC13 can be used to retrieve the PROFIBUS diagnostic data of the AS-i Gateway and save them to a data module. Use of SFC13 is described in detail in the SIEMENS documentation for PROFIBUS.

### 13. Codes Indicated by the Display

In the basic state of the configuration mode, the addresses of all detected slaves are displayed in two-second intervals. A blank display indicates that the LDS (List of Detected Slaves) is empty, no slaves were detected.

In the basic state of the protected operating mode, the display is either blank or displays the address of a faulty assignment.

During manual address programming, the slave address display has a different meaning (see also chapter "Operating in advanced display mode").

All displayed numbers bigger than 31 which can not be interpreted as a slave address are status or error messages of the master. They have the following meanings:

39	Advanced AS-i diagnostics: After pressing the 'set'-button a short-time AS-i power failure occurred.
40	The AS-i master is in offline phase.
41	The AS-i master is in detection phase.
42	The AS-i master is in activation phase.
43	The AS-i master starts the normal operating mode.
68	Hardware error: disturbed internal communication.
69	Hardware error: disturbed internal communication.
70	Hardware error: The AS-i master's EEPROM cannot be written.
71	Wrong PIC-type.
72	Hardware error: wrong PIC-processor.
73	Hardware error: wrong PIC-processor.
74	Checksum error in the EEPROM.
75	Error in the internal RAM.
76	Error in the external RAM.
77	AS-i control software error: Stack overflow (AS-i control II)
78	AS-i control software error: Checksum error in the control program.
79	Checksum error in the data menu.
80	Error while attempting to exit the configuration mode: A slave with address zero exists.
81	General error while changing a slave address
82	The front panel operation is blocked. Until repowering-up the device can only be accessed from the host via the interface.
83	Program reset of the AS-i Control program: The AS-i Control program is being read from the EEPROM and copied into the RAM.
88	Display test while starting up the AS-i master

Issue date: 28.3.2012

90	Error while changing a slave address in protected operating mode: No slave with address 0 existing.
91	Error while changing slave address: Target address is already used.
92	Error while changing slave address: New address could not be set.
93	Error while changing slave address: New address could only be stored volatile in the slave.
94	Error while changing the slave address in protected operating mode: Slave has wrong configuration data.
95	The error 95 is caused by a superfluous slave and not by a missing slave. That is why the slave address is occupied by this superfluous slave. (In the protected mode the slave addresses which caused any configuration error can be displayed by pressing the SET button. AS-i master without graphical display are not able to differentiate between a missing slave, an incorrect slave or a redundant slave. All incorrect addresses are displayed. By pressing the SET button 5 sec. the displayed address starts to flash. Pressing the SET button again the master attempts to program the slave at the address 0 to the incorrect address.)

### 13.1 Codes indicated by AS-i Gateway with standard function range

The basic master cannot display the following messages in a numeric form:

APF	Offline because of Power Fail
bF	Bus fault (no PROFIBUS connected)
LOS	Offline because of LOS
OFH	Offline because of Host
OFL	Offline - other cause
SEA	Collet phase
... 	(Current light) error-free function
EFL	Ground fault

**Accessories**

**14. Accessories**

**AS-i Master/Gateways/Links/Scanner**



AS-i 3.0 PROFIBUS Gateways



AS-i 3.0 EtherNet/IP + Modbus TCP Gateways

AS-i 3.0 PROFINET Gateways

AS-i 3.0 EtherCAT Gateways



AS-i 3.0 CANopen Gateways

AS-i 3.0 DeviceNet Gateways



AS-i 3.0 PROFIBUS Gateways (Basic Master)



AS-i 3.0 Master for Allen-Bradley ControlLogix



AS-i 3.0 Master for Allen-Bradley CompactLogix/MicroLogix 1500

Information:  
<http://www.bihl-wiedemann.de/englisch/catalog/ogateway/ogateway.htm>

**Software**



AS-i Control Tools: Configuration and AS-i Diagnostics Software



AS-i Safety Monitor Configuration Software ASIMON 3 G2

Information:  
<http://www.bihl-wiedemann.de/englisch/catalog/osoftw/osoftw.htm>

**AS-i Analog Modules: 4 ... 20mA, 0 ... 10V, Pt100, Thermocouple Type J/K**



AS-i 3.0 Analog Modules, IP20, 2 channels



AS-i Analog Modules, IP20, 4 channels



AS-i Analog Modules (M12) 2 channels, IP65



AS-i Analog Modules (M12), 4 channels, IP65

AS-i Analog Modules 1E/1A (M12), IP65



AS-i Analog Modules (PG), IP65



AS-i Balance Controller, IP65

Information:  
<http://www.bihl-wiedemann.de/englisch/catalog/oanalog/oanalog.htm>

**OEM Modules/AS-i Special Slaves\***



AS-i 2E/2A AB Modules



AS-i 1E/1A AB Modules



AS-i 4E/4A Modules

AS-i 8E Modules



AS-i 6A AB Modules

AS-i 4E/3A AB Modules



AS-i OEM Slaves with serial interface

AS-i 4E/4A OEM Modules



AS-i 8E/8A Modules

AS-i 16E/16A Modules



AS-i OEM Analog Modules 4 ... 20mA 0 ... 10V



AS-i OEM Power Supply Modules

Information:  
<http://www.bihl-wiedemann.de/englisch/catalog/oslave/oslave.htm>

\* customer-specific orders are welcome!

Issue date: 28.3.2012

## Accessories

### Specialities



AS-i 4E/4A Modules

AS-i 8E Modules

AS-i 8A Modules

AS-i 4E/4A Relay Modules

AS-i 4E/3A Relay Modules



AS-i Counter Modules



AS-i/AS-i Coupler

Information:  
<http://www.bihl-wiedemann.de/englisch/catalog/ospezial/ospezial.htm>

### Network Extensions/Diagnostics



AS-i Advanced Repeater with Bus Termination

AS-i High Power Repeater



AS-i Advanced Repeater, IP65



AS-i Bus Termination



AS-i Diagnostic Tuner



AS-i Analyser

Information:  
<http://www.bihl-wiedemann.de/englisch/catalog/oreptun/oreptun.htm>

### Power Supplies



AS-i Power Supply, 1,8 A



Power Supply for AS-i Master, 4A/8A



AS-i Power Supply, 4A/8A



AS-i Power Extender



AS-i Wide Range Power Supply, 8A



AS-i Module for Power Decoupling

Information:  
<http://www.bihl-wiedemann.de/englisch/catalog/opower/opower.htm>

### Safety: up to 16 release circuits (OSSDs)



AS-i 3.0 PROFIBUS Gateways with integrated Safety Monitor



AS-i 3.0 EtherNet/IP+Modbus Gateways\*

AS-i 3.0 PROFINET Gateways\*

AS-i 3.0 EtherCAT Gateways\*

\*with integrated Safety Monitor



AS-i Safety Monitor, Generation II, 16 OSSDs



AS-i 3.0 Gateways PROFIsafe via PROFIBUS



AS-i 3.0 Gateways PROFIsafe via PROFINET



AS-i Safety Monitor, Generation I, 2 OSSDs



AS-i Safety Input Modules, IP20



AS-i Safety Output Modules



AS-i Safety Input Modules (M12), IP67

Information:  
<http://www.bihl-wiedemann.de/englisch/catalog/osafety/osafety.htm>

## 15. Glossary

### A/B slave

An AS-i slave with extended addressing. The address range of an A/B slave extends from 1A to 31A and 1B to 31B. As the master needs the fourth output data bit for switching between A and B address, A/B slaves only have three output data bits maximum.

### Activation phase

In the activation phase the detected slaves are activated by sending the parameter. This is indicated by a "42" on the Master's Display. This phase takes only 10 ms, tops, to short to be displayed.

### AS-i Power Fail

Voltage drop on the AS-i line; If the voltage drops below a specific value, the master changes to the ⇒ Offline phase.

### Initiation phase

After the initial data exchange with all AS-i slaves the master is looking for new slaves. For this purpose an inquiring call is sent to one AS-i address. If a reply is received, the master tries to read the ⇒ current configuration of the slave. Depending on the mode (⇒ protected mode or ⇒ configuration mode) and on the current configuration, the detected slave will be activated.

After each data exchange with all AS-i slaves exactly one inquiring call is sent to one slave address. Hence, the AS-i cycle always includes one more telegram than the number of activated slaves (⇒ LAS).

### Autoprogram flags

Auto Address Enable; flag from the operating system to the AS-i Master.

With this flag, automatic addressing can be enabled or disabled. This flag is saved in non-volatile memory in the Master.

Auto Address Assign, Auto Address Possible; flag from the AS-i Master to the operating system.

Automatic programming is not disabled and no configuration error was found.

If a slave fails, it could be addressed automatically.

Auto Address Available, flag from the AS-i Master to the operating system. Exactly one AS-i slave is missing and the automatic single node replacement is not disabled.

If at this point a slave with the address 0 and the profile of the missing slave is connected, it automatically receives the address of the missing slave.

**I/O code**

The first digit of the slave profile, which indicates how many in- and outputs the slave has. A 4I/4O slave has for example a "7", and a slave with 4 digital inputs a "0".

**Detection phase**

In the detection phase, after the startup the master is scanning for AS-i slaves. The master remains in this phase until at least one slave was detected. If the master remains in the detection phase no slave was found. Most of the time, the reason for this is a wrong power supply or a wiring error.

The detection phase is indicated by code "41".

**Protected mode**

In protected operating mode only those slaves that are registered in the  $\Rightarrow$  LPS and whose current configuration matches the target configuration are activated.

Also see  $\Rightarrow$  configuration mode. This mode is intended for normal operation, since all AS-i protective measures are activated.

**ID code**

The ID code is set by the slave manufacturer and cannot be changed. The AS-i Association determines the ID codes which are assigned for a particular class of slaves. For example, all  $\Rightarrow$  A/B slaves have ID code "A".

**ID1 Code, extended ID1 code**

The ID1 code is set by the slave manufacturer. In contrast to the other codes, which determine the profile, it can be changed from the master or using an addressing device. The user should however only use this feature in exceptional circumstances, since otherwise *configuration errors* may occur.

In the case of A/B slaves, the MSB of the ID1 code is used for distinguishing between the A and the B address. Therefore, only the lowest 3 bits are relevant for these slaves.

Since this code was not introduced until AS-i Specification 2.1, it is also referred to as extended ID1 code.

### **ID2 Code, extended ID2 code**

The ID2 code is set by the slave manufacturer and cannot be changed. The AS-i Association determines the ID2 codes, which are assigned for a particular class of slaves. For example, all 2-channel 16 bit input slaves having an S-7-3 bit code use ID2 code "D". Since this code was not introduced until AS-i Specification 2.1, it is also referred to as extended ID2 code.

### **Current configuration**

The configuration data of all slaves detected by the master. The configuration data of a slave, the  $\Rightarrow$  slave profile, consists of:

$\Rightarrow$  IO code,  $\Rightarrow$  ID code,  $\Rightarrow$  extended ID1code ,  $\Rightarrow$  extended ID2 code.

### **Current parameter**

The AS-i parameter that have most recently been sent to the AS-i slave, as opposed to  $\Rightarrow$  permanent parameters.

### **Configuration Error/Config Error**

An configuration error is displayed if the target and the current configuration of the connected slaves do not match. A configuration error could be due to the following:

Missing slave: A slave entered in the  $\Rightarrow$  LPS is not available

Wrong type of slave: The  $\Rightarrow$  slave profile of the connected slave does not comply with the configuration.

Unknown slave: A connected slave is not entered in the  $\Rightarrow$  LPS.

### **LAS - List of Activated Slaves**

The master exchanges I/O data with the slaves entered in the LAS. In protected mode only the detected slaves ( $\Rightarrow$  LDS) that are expected by the master and are entered in the  $\Rightarrow$  LPS are activated. In configuration mode all slaves entered in the  $\Rightarrow$  LDS are activated.

### **LDS - List of Detected Slaves**

If the master was able to read the  $\Rightarrow$  slave profile, the slave is entered in the LDS.

### **LPF - List of Peripheral Faults**

The list of peripheral faults was introduced with specification 2.1. This list includes an entry for each slave that signals a  $\Rightarrow$  peripheral fault.

### **LPS - List of Projected Slaves**

The list of projected slaves includes all slaves expected by the master. When saving the current configuration all entries in the  $\Rightarrow$  LDS are stored in the LPS (except for a slave with address 0).

### Offline phase

In the offline phase all input and output data is reset. This phase is entered after the startup of the master, after a  $\Rightarrow$  AS-i power fail, and during the transition from the  $\Rightarrow$  configuration mode to the  $\Rightarrow$  protected mode.

Furthermore, the master can actively be transferred into the offline phase by setting the offline flag.

During the offline phase, masters with a LED display show code "40".

### Peripheral fault

A peripheral fault is indicated by a red flashing LED on the master and on the slave.

Depending on the slave type this indicates an overflow, an overload of the sensor's power supply, or another fault regarding the periphery of the slave.

### Permanent configuration

The configuration data of all expected slaves stored in the master ( $\Rightarrow$  slave profile). If the  $\Rightarrow$  permanent configuration differs from the  $\Rightarrow$  actual configuration, a configuration error exists.

### Permanent parameter

The parameters saved in the master and sent to the slave after startup of the master during the  $\Rightarrow$  activation phase.

### Configuration mode

During the configuration mode the master exchanges data with all connected slaves, no matter which of the slaves were configured. Thus, in this mode it is possible to operate a system without the necessity to configure it before.

See also  $\Rightarrow$  protected mode.

### Single Slave

A single slave can in contrast to a  $\Rightarrow$  A/B slave only be addressed from range 1 to 31; the fourth output data bit can be used. All slaves as defined by the older AS-i Specification 2.0 are single slaves.

There are however also single slaves as defined by Specification 2.1, for example the new 16 bit slaves.

### Slave profile

Configuration data for a slave, consisting of:

$\Rightarrow$  I/O configuration and  $\Rightarrow$  ID-Code, as well as  $\Rightarrow$  extended ID1-Code and  $\Rightarrow$  extended ID2-Code.

The slave profile is used to distinguish between various slave classes. It is specified by the AS-i Association and set by the slave manufacturer.

AS-i 2.0 slaves do not have extended ID1 and ID2 codes. A 2.1 or 3.0 AS-interface master enters in this case an "F" for each of the extended ID1 and ID2 codes.

## 16. Reference List

### 16.1 Manual: "AS-i 3.0 Command Interface"

This Manual contains a detailed description of the AS-i 3.0 Command Interface.

**Your opinion is important to us!**

## 17. Your opinion is important to us!

Please give us an opportunity to hear your suggestions, wishes and criticisms regarding this Manual.

We read every note or comment, no matter how small, and incorporate them into the documentation whenever possible.

Fill out the form on the following page and fax it to us or send your remarks, suggestions for improvement etc. to the following address:

Bihl+Wiedemann GmbH

Technical Support

Floßwörthstr. 41

D - 68199 Mannheim

Germany

Phone: +49 (0) 621-33 99 6-0

Fax: +49 (0) 621-33 9 22 39

eMail: mail@bihl-wiedemann.de

### **Fax reply**

Bihl+Wiedemann GmbH

Technical Support

Date: \_\_\_\_\_

Fax No. +49 (0) 621-33 9 22 39

eMail: mail@bihl-wiedemann.de

### **From:**

Firm

Name: \_\_\_\_\_

Dept. \_\_\_\_\_

Street \_\_\_\_\_

Position: \_\_\_\_\_

City \_\_\_\_\_

Tel.: \_\_\_\_\_

Fax: \_\_\_\_\_

eMail: \_\_\_\_\_

### **Which manual are you using?**

Title

Publication date: \_\_\_\_\_

My opinion of the manual

Design

Yes      Partly      No

Is the table of contents clearly laid out?                 

Are the illustrations/graphics comprehensible/meaningful?                 

Are the text explanations for the illustrations sufficient?                 

Does the quality of the images meet your expectations?                 

Does the pagination encourage rapid finding of information?                 

Issue date: 28.3.2012

Your opinion is important to us!

**Content**

	Yes	Partly	No
Are the formulations/technical terms understandable?	<input type="checkbox"/>	<input type="checkbox"/>	<input type="checkbox"/>
Are the examples relevant?	<input type="checkbox"/>	<input type="checkbox"/>	<input type="checkbox"/>
Is the Manual easy to handle?	<input type="checkbox"/>	<input type="checkbox"/>	<input type="checkbox"/>
Is there important information missing? If yes, explain.	<input type="checkbox"/>	<input type="checkbox"/>	<input type="checkbox"/>

Comments:

---

---

---

---

---



**Bihl  
+ Wiedemann**  
•••

*Automatisierungstechnik*