

mitsubishi
TRANSISTORIZED
FREQUENCY INVERTER

FREQROL-F2

Service Manual

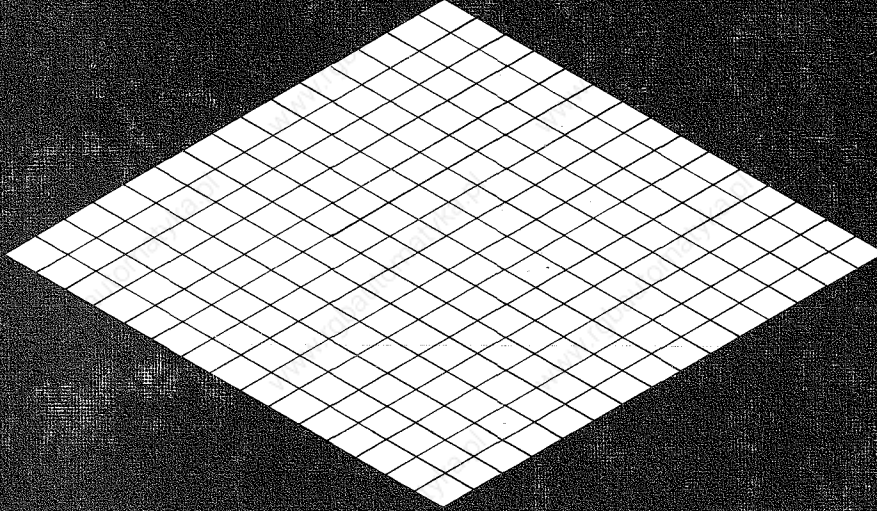

SERVICE

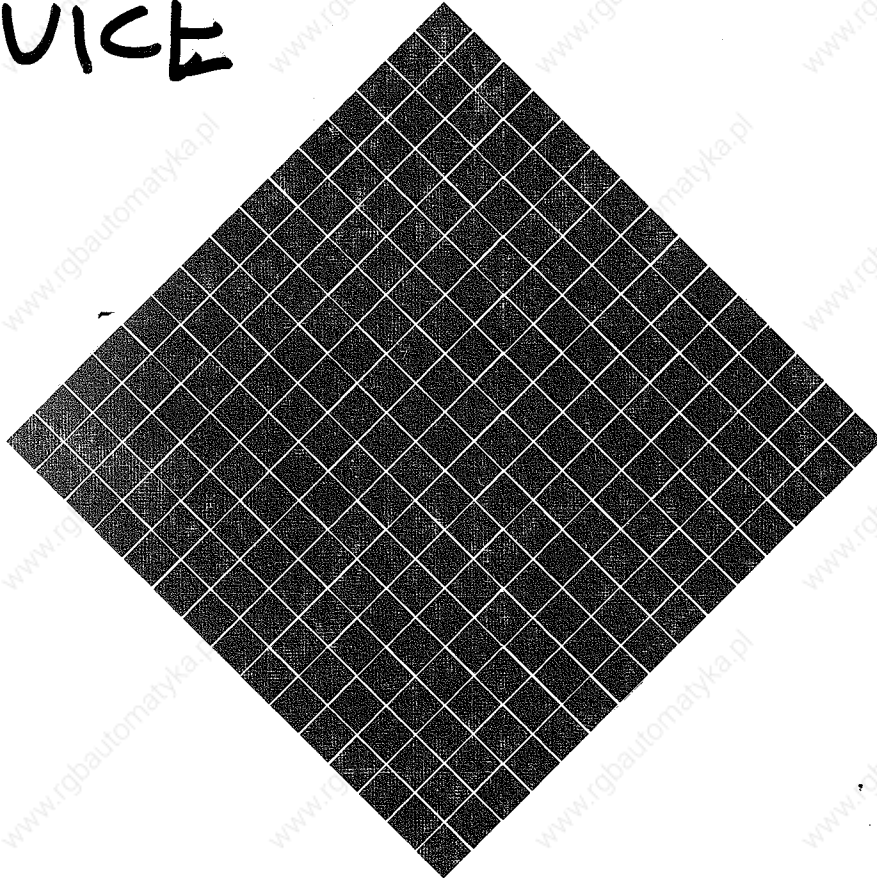

US version

CU (NA) 2622-A



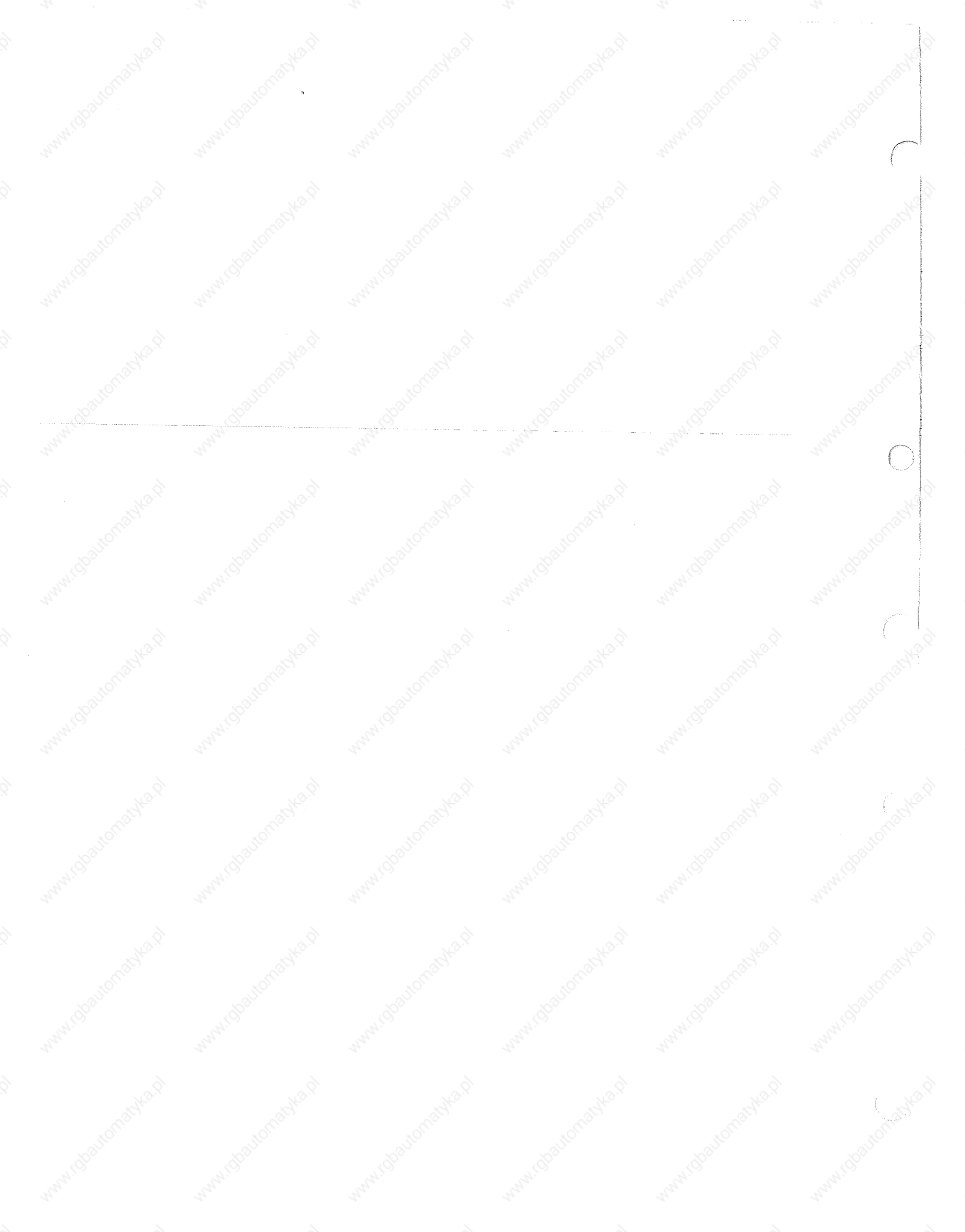

CONTENTS

1. SCOPE OF MANUAL	3	1
2. BASIC CONCEPTIONS ABOUT THE INVERTER OPERATION	4	2
3. STANDARD SPECIFICATION	5	3
3.1 208/230VAC Series	5	
3.2 460VAC Series	6	
4. CONSTRUCTIONS	7	4
4.1 Outlooks	7	
5. SELECTION OF THE INVERTER	11	5
5.1 Output Rating of the Inverter	11	
5.2 Starting Torque and Starting Current of Motor	13	
5.3 Acceleration/Deceleration Time	14	
5.4 Selection of Brake Unit	17	
6. MAIN CIRCUIT DESCRIPTIONS	22	6
6.1 Converter Module	22	
6.2 Initial In-rush Current Suppress Resistor and Contactor	23	
6.3 Main Circuit Capacitor (Smoothing Capacitor)	25	
6.4 DC Current Transformer (DC-CT)	27	
6.5 Transistor Module (Transistor Chopper)	29	
7. CONTROL CARD	32	7
7.1 Card Application	32	
7.2 Basic Operation of the Control Card	33	
7.3 Fault Indicating Lamp	35	
8. SOME OPERATION PRINCIPLES OF THE TOTAL SYSTEM OF THE INVERTER	36	8
8.1 Stall Prevention	36	
8.2 Electronic Thermal Relay	38	
8.3 Ground Fault Protection	40	
9. FUSING	41	9
10. POWER FACTOR IMPROVING REACTOR	42	10
11. RADIO INTERFERENCE NOISE	43	11
11.1 Propagation Path of Noise	43	
11.2 Noise Measuring Method	43	
11.3 Measures Against Radio Noise	44	
11.4 The Type and Outline of Filter	45	

12. APPLICATION OF INVERTER	46
12.1 Efficiency and Heat Generation Amount of Inverter.....	46
12.2 Heat Generation Amount of Inverter and Cooling of Panel	47
13. WIRING	49
13.1 Wiring Diagram	49
13.2 Input/Output Terminals	50
13.3 Terminal Arrangement	51
14. MAINTENANCE AND CHECKING	54
14.1 Measuring Methods for Voltage and Current of Various Parts	54
14.2 Cause of Protective Function Working and Countermeasure	56
14.3 Troubleshooting	58
14.4 Investigation of Parts in p.c.b	71
14.5 Periodic Checking	79
14.6 Checking up of the P.C.B. and Normal Waveforms	80
15. REPLACEMENT OF THE PARTS	93
15.1 General	93
15.2 Replacement of the Printed Circuit Board FRF2-CB(A) and FRF2-DR	95
15.3 Smoothing Capacitors	98
15.4 Diode and Transistor Modules	100
15.5 Cooling Fan (Ventilator)	101
15.6 DC-CT (DC Current Transformer)	102
15.7 Operation Panel	103
16. SOME MISCELLANEOUS INFORMATIONS	104
16.1 To Change the Rated Power Supply Voltage from 230V into 208V Vice Versa	104
17. TROUBLE CALL	105
17.1 Confirmation Items at Trouble Call from Your Customer	105
18. SPARE PARTS	107
19. DRAWINGS	114
19.1 FR-F2-750B and 1500B	114
19.2 FR-F2-750 throu. FR-F2-3700	115
19.3 FR-F2-5.5K and FR-F2-7.5K	116
19.4 FR-F2-11K throu. FR-F2-30K	117
19.5 FR-F2-37K	118
19.6 FR-F2-45K and FR-F2-55K	119
19.7 FR-F2-H3700 throu. FR-F2-H7.5K	120
19.8 FR-F2-H11K and FR-F2-H15K	121
19.9 FR-F2-H22K	122
19.10 FR-F2-H30K throu. FR-F2-H55K	123

12

13

14

15

16

17

18

19

1. SCOPE OF MANUAL

The scope of this manual is to explain the basic idea about the operation of the inverter trouble shootings and parts replacements. Some pictures which show the appearance of the inverter and waveforms and drawings are included.

We hope that this manual is helpful for you to service and maintain our products.

CAUTION

1. READ THIS MANUAL CAREFULLY BEFORE STARTING THE CHECKING UP OF THE INVERTER.
2. DISCONNECT THE POWER SUPPLY BEFORE THE INSPECTION OR THE REPLACEMENT OF ANY PARTS.
3. WAIT FOR A WHILE UNTIL THE CHARGE INDICATING LAMP GOES OUT.
4. ONLY THE ELECTRICAL PERSONNEL SHOULD BE ALLOWED TO CHECK AND INSPECT THE INVERTER.

2. BASIC CONCEPTIONS ABOUT THE INVERTER OPERATION

The FR-F2 inverter made up of the converter, the inverter and the control circuit as shown in Fig. 2.1.

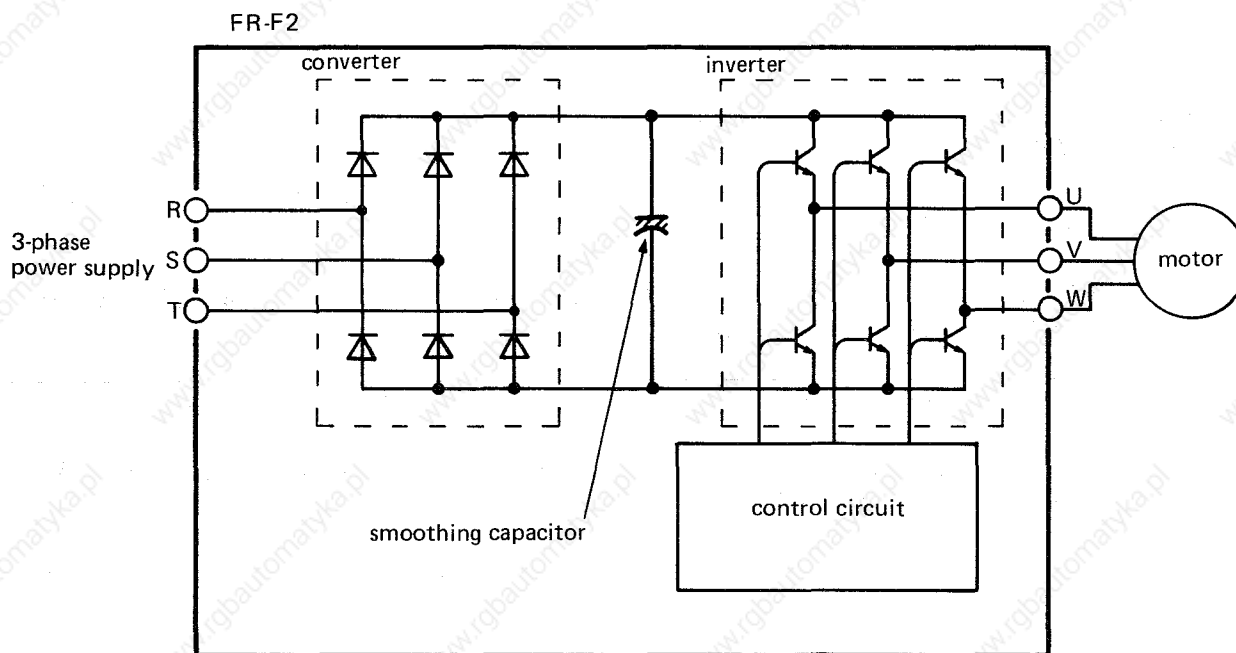

Fig. 2.1 FR-F2 Main Circuit Constructions

The three phase AC power supply is rectified into DC voltage by the converter (diode module) and smoothed by the smoothing capacitor. This DC voltage is chopped and modulated into PWM (pulse width modulation) AC voltage by the inverter (transistor module) but its frequency is different from the one of the input power supply. That output frequency is controlled by the control circuit in the printed circuit board.

In the case of the induction motor, the rotor speed N (rpm) is given by the following formula.

$$N \text{ (rpm)} = \frac{120 \cdot f}{p} (1-s)$$

where, f : given frequency
 p : number of poles
 s : slip of rotor

For example, when a 4-pole motor is driven by the 60Hz power supply and if the rotor slip is 5%, the motor will rotate at the speed of

$$N = \frac{120 \cdot 60 \cdot (1 - 0.05)}{4} = 1710 \text{ rpm}$$

3. STANDARD SPECIFICATION

FREQROL-F₂

3. STANDARD SPECIFICATION

3.1 208/230V AC Series

Item \ Type		FR-F ₂ -750B-U (750-U)	FR-F ₂ -1500B-U (1500-U)	FR-F ₂ -2200-U	FR-F ₂ -3700-U	FR-F ₂ -5.5K-U	FR-F ₂ -7.5K-U	
Output rating	Nominal output (HP)	1/2	1	2	3	5	7.5	10
	Output capacity (kVA)	2.0		3.2	4.4	6.8	9.6	13.1
	Rated output current (A)	5		8	17		24	33
	Max. output voltage	3-phase, 208V AC or 230V AC (*1)						
Power source requirement (kVA)		2.5	4.5	5.5	9	12	17	
Weight (lbs.)		9.9	11	13.2		18.7	19.8	
Construction		Enclosed type (IP20)						
Power supply	Voltage/frequency	3-phase 208V AC or 230V AC 60Hz						
	Permissive voltage regulation	208V ± 10% or 230V ± 10%						
	Permissive frequency regulation	60Hz ± 5%						

Item \ Type		FR-F ₂ -11K-U	FR-F ₂ -15K-U	FR-F ₂ -22K-U	FR-F ₂ -30K-U	FR-F ₂ -37K-U	FR-F ₂ -45K-U	FR-F ₂ -55K-U
Output rating	Nominal output (HP)	15	20	30	40	50	60	75
	Output capacity (kVA)	18.3	24.3	36	46	58	70	86
	Rated output current (A)	46	61	90	115	145	175	215
	Max. output voltage	3-phase, 280V AC or 230V AC (*1)						
Power source requirement (kVA)		20	28	41	52	66	80	100
Weight (lbs.)		44.1	55.1	66.1	88.2	132.3	154.3	176.4
Construction		Open type (IP00)						
Power supply	Voltage/frequency	3-phase, 208V AC or 230V AC 60Hz						
	Permissive voltage regulation	208V ± 10% or 230V ± 10%						
	Permissive frequency regulation	60Hz ± 5%						

Note: (*1) If the source voltage drops, the output voltage larger than the source voltage is not guaranteed.

Common specifications

Item		Description
Control specification	Control method	Sinusoidal PWM, voltage control
	Frequency range	6 to 50Hz/6 to 60Hz selectable (Operation starts at 3Hz. Frequency upper limit is provided.)
	Frequency resolution	0.25Hz (0.125Hz only in acceleration/deceleration for models larger than 5.5K)
	Frequency accuracy	±0.5% (77°F ± 18°F)
	Voltage/frequency ratio	Selectable in 4 steps (two steps each for normal torque and reduced torque)
	Overcurrent capacity	150% for one min.
	Frequency setting signal	0 to 5V DC, 0 to 10V DC/4 to 20mA selectable.
	Acceleration/deceleration time	0.2–3.0 sec. (in 0.2 sec. increments), 1–15 sec. (in 1 sec. increments), 10–150 sec. (in 10 sec. increments) selectable
	Regenerative braking torque	Approx. 20% of rated motor torque
Environmental conditions	Protective function	Protection against stalls caused by overcurrent, protection against stall caused by regenerative overvoltage, overcurrent protection, regenerative overvoltage protection, overload protection (electronic thermal relay), instantaneous power failure protection, thermo detect of the heatsink, ground fault protection at load side (*2)
	Ambient temperature	14°F to 122°F (to be free from freezing)
	Ambient humidity	Less than 90% (to be free from condensation)
	Atmosphere	To be free from corrosive gases and dense dust
	Altitude	Below 3,000 ft above sea level
Vibration		Less than 0.5G

Note: (*2) FR-K-5.5K-U or higher model equipped with thermo detect of the heatsink.

3. STANDARD SPECIFICATION

FREQROL-F2

3.2 460V AC Series

Item	Type	FR-F ₂ -H3700-U	FR-F ₂ -H5.5K-U	FR-F ₂ -H7.5K-U	FR-F ₂ -H11K-U	FR-F ₂ -H15K-U
Output rating	Nominal output (HP)	5	7.5	10	15	20
	Output capacity (kVA)	7.2	9.6	13.5	18.3	24.7
	Rated output current (A)	9	12	17	23	31
	Max. output voltage	3-phase, 460V AC (*1)				
Power source requirement (kVA)	9	12	17	20	28	
Weight (lbs.)	18.7	26.4	26.4	59.5	59.5	
Construction		Enclosed type (IP20)		Open type (IP00)		
Power supply	Voltage/frequency	3-phase, 460V AC 60Hz				
	Permissible voltage regulation	460V ±10%				
	Permissible frequency regulation	60Hz ±5%				

Model	FR-F ₂ -H22K-U	FR-F ₂ -H30K-U	FR-F ₂ -H37K-U	FR-F ₂ -H45K-U	FR-F ₂ -H55K-U	
Output rating	Nominal output (HP)	30	40	50	60	70
	Output capacity (kVA)	34	45	56	69	88
	Rated output current (A)	43	57	71	87	110
	Max. output voltage	3-phase, 460V AC (*1)				
Power source capacity (kVA)	41	52	66	80	100	
Weight (lbs.)	70.5	143.3	143.3	187.4	187.4	
Construction	Open type (IPO0)					
Power supply	Voltage, frequency	3-phase, 460V AC 60 Hz				
	Permissible voltage regulation	460V ±10%				
	Permissible frequency regulation	60Hz ±10%				

Note: (*1) If the source voltage drops, the output voltage larger than the source voltage is not guaranteed.

Common specifications

Item	Description	
Control specification	Control method	Sinusoidal PWM, voltage control
	Frequency range	6 to 50Hz/6 to 60Hz selectable (Operation starts at 3Hz. Frequency upper limit is provided.)
	Frequency resolution	0.25Hz (0.125Hz only in acceleration/deceleration for models larger than 5.5K)
	Frequency accuracy	±0.5% (77°F ± 18°F)
	Voltage/frequency ratio	Selectable in 4 steps (two steps each for normal torque and reduced torque)
	Overcurrent capacity	150% for one min.
	Frequency setting signal	0 to 5V DC, 0 to 10V DC/4 to 20mA selectable.
	Acceleration/deceleration time	0.2–3.0 sec. (in 0.2 sec. increments), 1–15 sec. (in 1 sec. increments), 10–150 sec. (in 10 sec. increments) selectable
	Regenerative braking torque	Approx. 20% of rated motor torque
	Protective function	Protection against stalls caused by overcurrent, protection against stall caused by regenerative overvoltage, overcurrent protection, regenerative overvoltage protection, overload protection (electronic thermal relay), instantaneous power failure protection, thermo detect of the heatsink, ground fault protection at load side (*2)
Environmental conditions	Ambient temperature	14°F to 122°F (to be free from freezing)
	Ambient humidity	Less than 90% (to be free from condensation)
	Atmosphere	To be free from corrosive gases and dense dust
	Altitude	Below 3,000 ft above sea level
	Vibration	Less than 0.5G

Note: (*2) FR-K-5.5K-U or higher model equipped with thermo detect of the heatsink.

4. CONSTRUCTIONS

4.1 Outlooks

FR-F2 inverter series has two different kinds of construction. One is the plastic cover type and another is the steel box type. These two types of FR-F2 are used in the following manner.

From 1HP up to 10HPPlastic cover type

From 15HP up to 75HPSteel box type

4

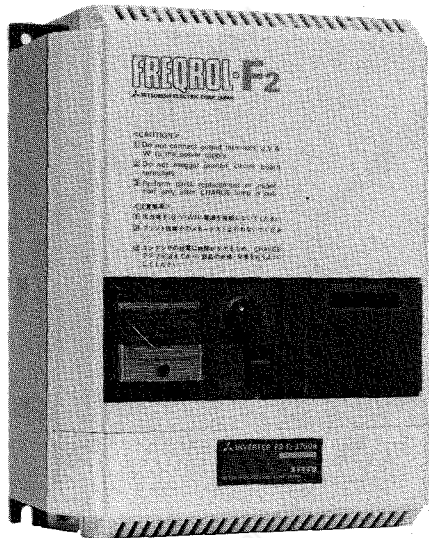

B843076-5

(a) Plastic cover type

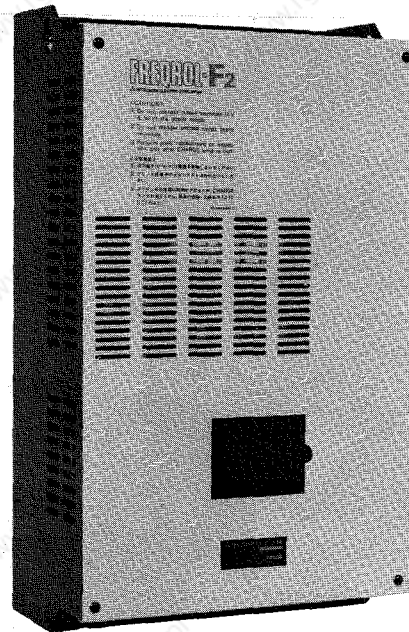

B843091-5

(b) Steel cover type

Fig. 4.1 Outlooks of FR-F2 Inverter

From view point of internal construction, the FR-F2 inverter is divided into two series, one is FR-F2-750B-U, FR-F2-1500B-U, and all other FR-F2 series. These constructions are shown in Fig. 4.2, Fig. 4.3 and Fig. 4.4.

4

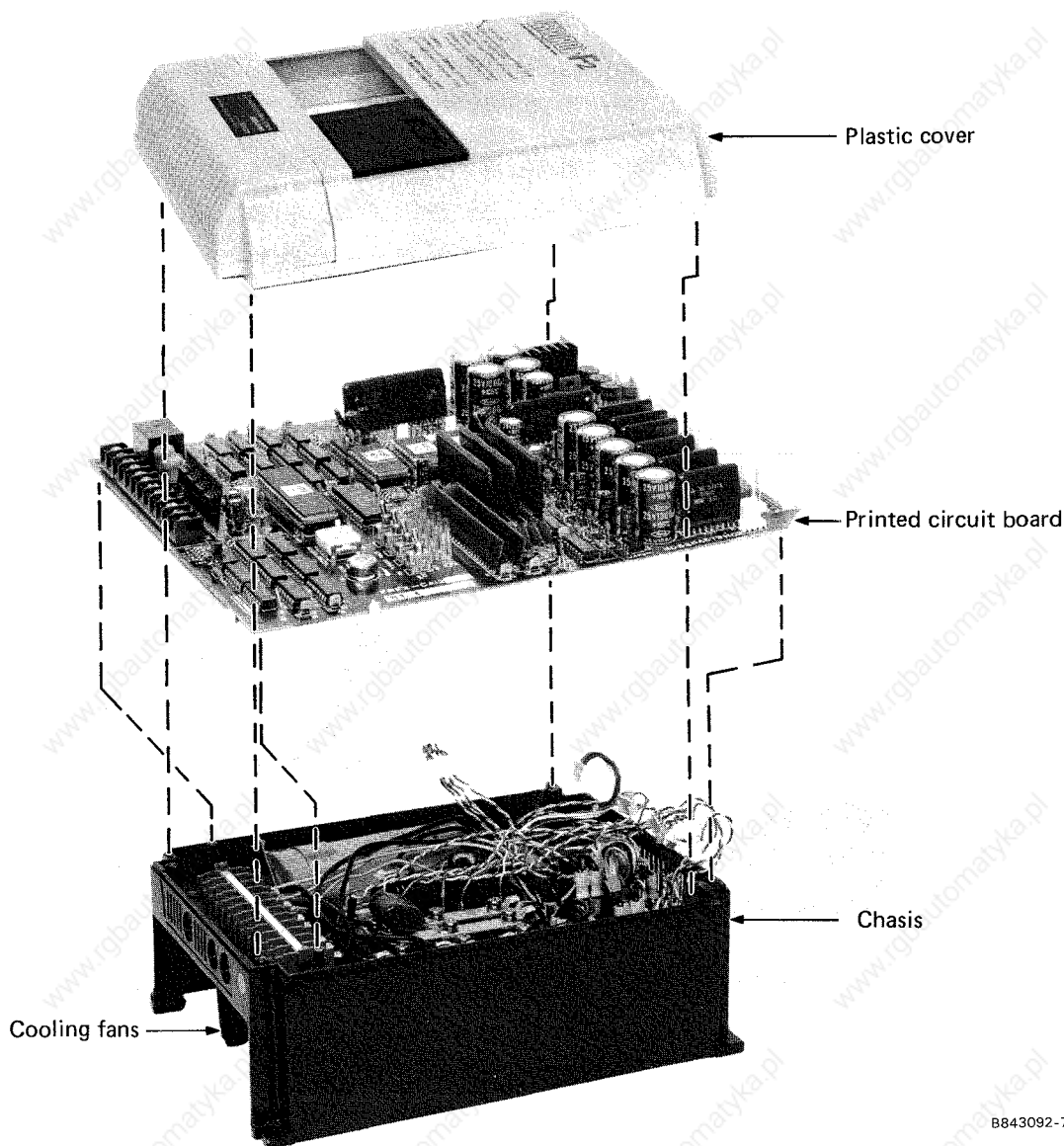
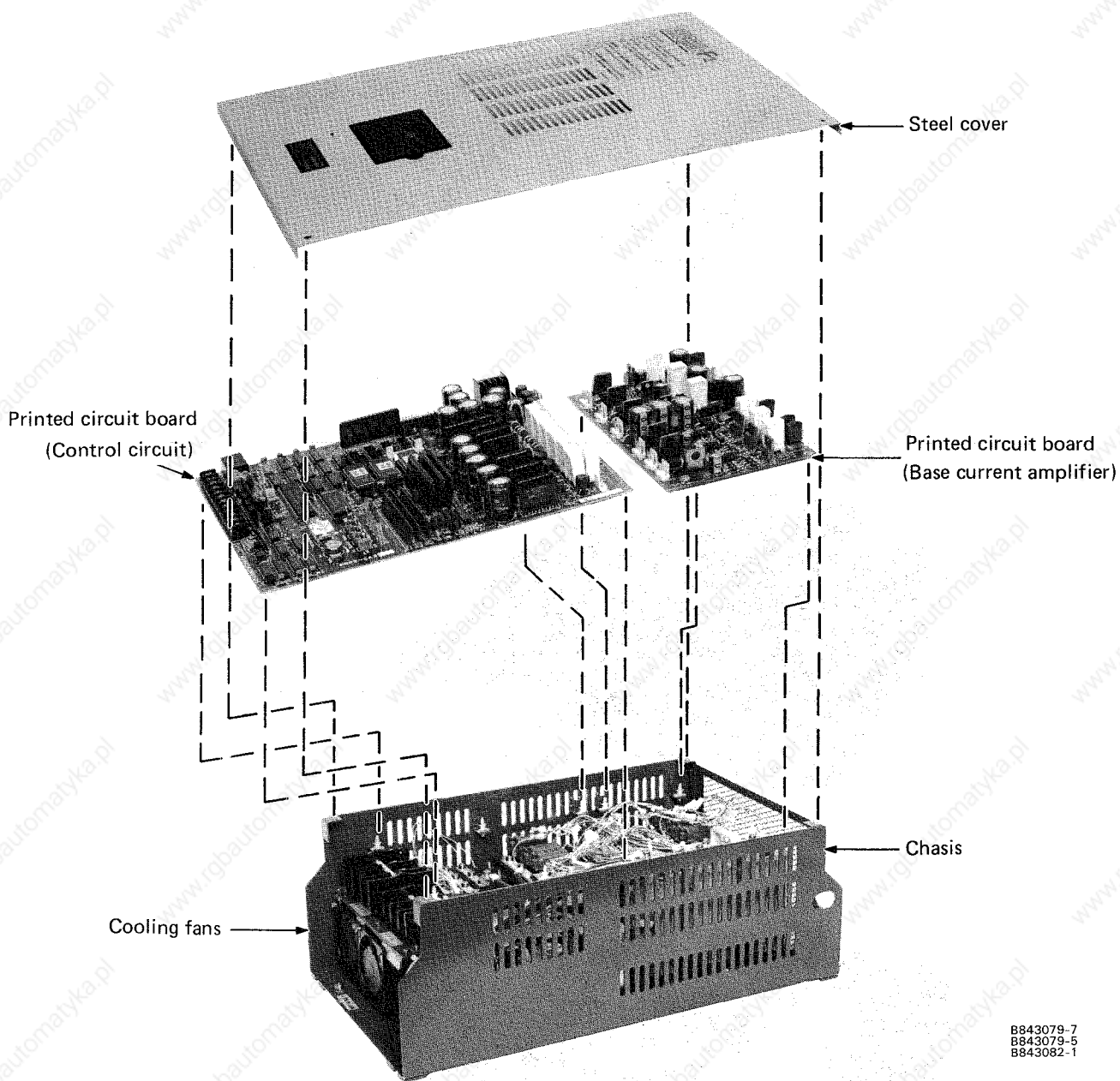

Fig. 4.2 Internal View of Plastic Cover Type FR-F2

(FR-F2-750-U through 7.5K-U)
(and H3700-U through H7.5K-U)



4

B843079-7
B843079-5
B843082-1

Fig. 4.3 Internal View of Steel Cover Type FR-F2

(FR-F2-11K-U through 55K-U
and H11K-U thru H55K-U)

4

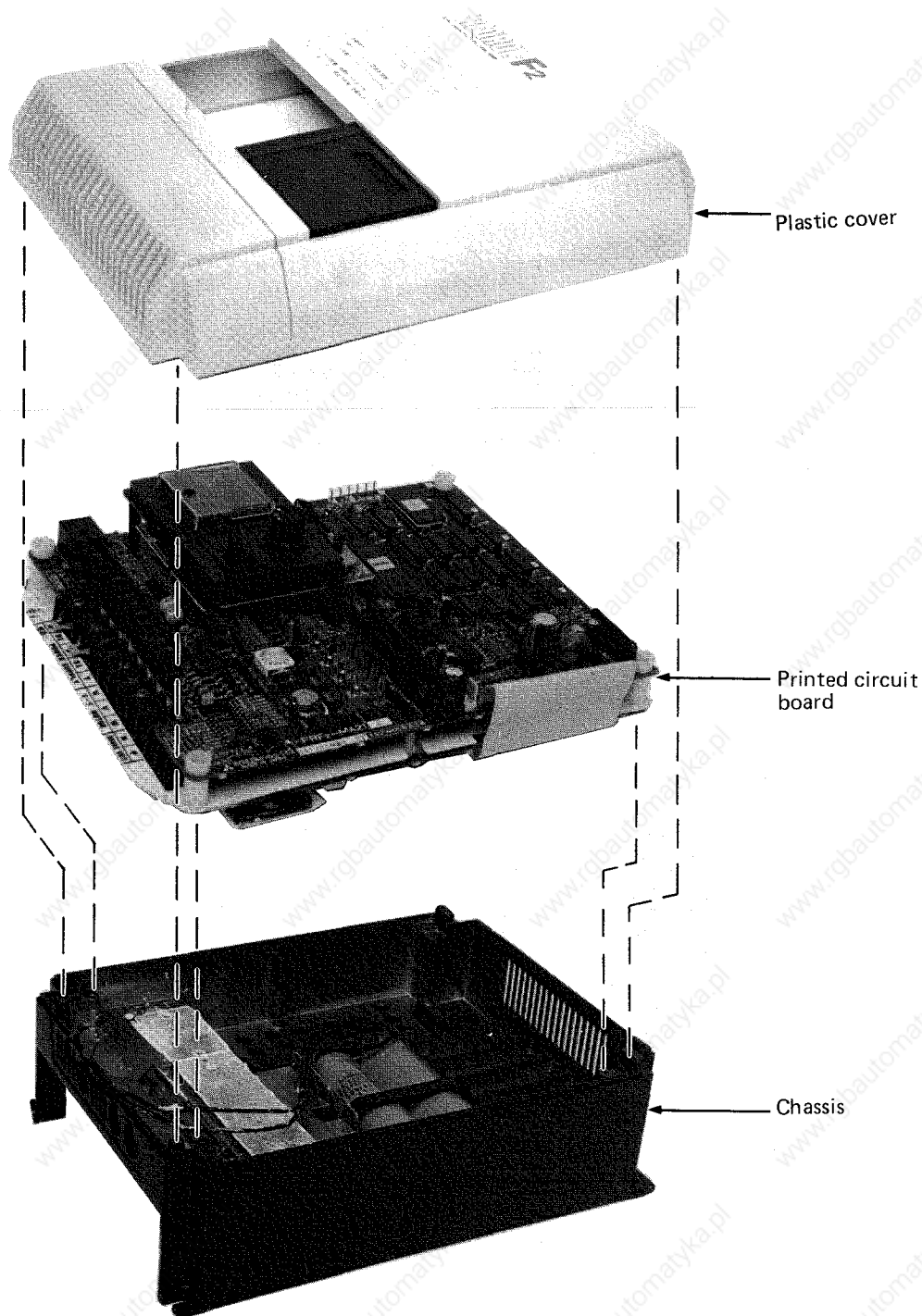

8854175-1
8854175-3
8854175-5

Fig. 4.4 Internal View of FR-F2-750B-U and 1500B-U.

5. SELECTION OF THE INVERTER

5.1 Output Rating of the Inverter

The output capacity of inverter is calculated on the basis of rated output current value.

$$\text{inverter output capacity (kVA)} = \sqrt{3} \times \text{maximum output voltage (V)} \times \text{rated output current (A)} \times 10^{-3}$$

The rated output current is the current value which the inverter can be continuously operated at the rated output voltage, and it is always required to use the inverter below or at this current value. When current more than the rated output current of inverter flows, overcurrent resistance amount is determined as an allowable value. This amount is generally 150% rated for one minute for general-purpose inverters. However, it is sometimes 120% one minute for inverters for pumps and fans. At the time of starting or instantaneous overload, it is required to use the inverter below this value. The capacities of general-purpose inverters are classified by the rated capacity (kW) of motor. However, this output capacity applies to the case where one general-purpose squirrel-cage induction motor with two to six poles is operated without special restriction on starting time or starting torque. When a special motor or multiple motors are operated in parallel by one inverter, or when an operation pattern or load torque is specified, it is required to select an inverter with capacity proportional to the condition.

5.1.1 Operation of one motor

Select a capacity which meets the following condition:

$$\text{Inverter rated output current} \geq \text{motor rated current}$$

5.1.2 Operation of multiple motors

Select a capacity which meets the following condition:

$$\text{Inverter rated output current} \geq \text{total of rated currents of simultaneously-operated motors}$$

However, when several motors are directly started in succession, it is required to select a capacity so that total of input currents to motors, including the starting current at the time of direct start, may be lower than the overcurrent resistance amount of inverter, and in actuality an extremely large capacity is required for the inverter. In this case, it is often the case that installation of an inverter for each motor results in lower cost.

5.1.3 Light motor load

When load is extremely light in relation to the rated torque of the operation motor, motor current greatly reduces as compared to rated current. Therefore, low cost may be achieved by the application of inverter with small output capacity as compared to motor capacity. However, the following precautions must be taken for determining the output capacity:

In the general-purpose inverter, exciting current of 30 to 50% of motor rated current flows even at no load. For this reason, an inverter with extremely small output capacity cannot be used.

At light load, even if an effective current value is equal, the ripple rate of current is larger as compared to that at the time of rated load. In a transistor inverter, since protection against overcurrent is provided by detecting instantaneous crest value of motor current, overcurrent stall prevention protective function is activated at the crest value due to ripple even if effective current is small. Therefore, if the motor is started, speed is not increased, or an overcurrent protective function is activated, resulting in failure such as motor stop. Fig. 5.1 shows the input current waveforms of two types (30HP and 10HP) of motors which are driven by the sine wave PWM type inverter. Even if the 30HP motor has light load and is equivalent in rated current to the 10HP motor, the input current ripple and current crest value of 30HP motor with light load are larger than those of the rated current of 10HP motor as shown in Fig. 5.1 (b)(c). As described above, the output capacity of inverter cannot be extremely reduced even at light load. For the transistor inverter, the capacity of inverter is basically determined depending on that of motor. In light load operation, however, it is possible to reduce the capacity to that of an inverter which is smaller by one rank, by considering operating conditions, such as starting conditions.

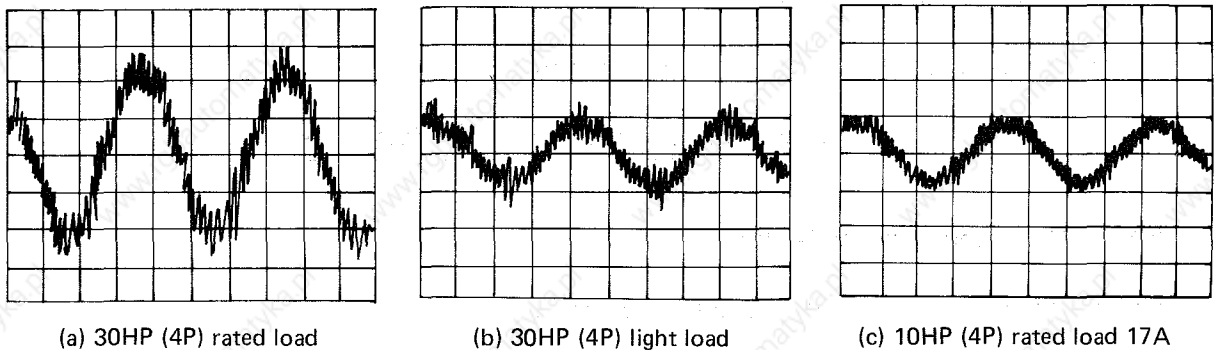

Fig. 5.1 Input Current of Motor [25A/div., 5ms./div.]

5.2 Starting Torque and Starting Current of Motor

When a general-purpose motor is directly started by commercial power source, starting current six to seven times as large as motor rated current flows and also motor starting torque 1.5 to 2.5 times as large as rated torque can be obtained.

However, the starting and accelerating characteristics of motor, which is combined with an inverter, are restricted by the current characteristics of the combined inverter, and therefore, are different from those in direct starting by commercial power source. In other words, since the motor is accelerated with current at the time of motor start and acceleration kept lower than the current limit level of inverter (generally, 150% of rated current), starting torque and accelerating torque are smaller than those of direct start by commercial power source. Fig. 5.2 and 5.3 shown examples of speed vs. torque and current characteristic curves of general-purpose motor. When the motor is combined with a rated-capacity inverter, the torque at speed corresponding to the intersecting point with the 150% current value (rated current reference of inverter) and the current characteristics of each frequency is the maximum torque (short-time rating) generated by the motor. The starting torque at the speed of 0 rpm is 110% (A) point) in the example below.

When the capacity of inverter to be combined is increased by one rank, the starting torque and maximum torque increase, as shown in Fig. 5.2, proportional to the increase of current limit level. When the starting torque and maximum torque are insufficient, the increase of inverter capacity by one rank is one of effective methods.

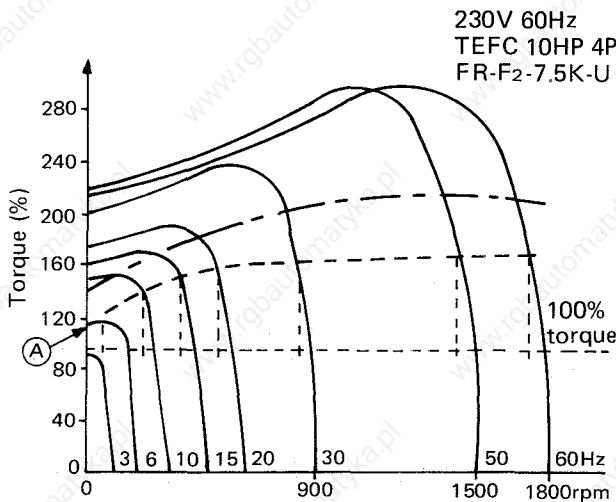

Fig. 5.2 Speed vs. Torque Curve

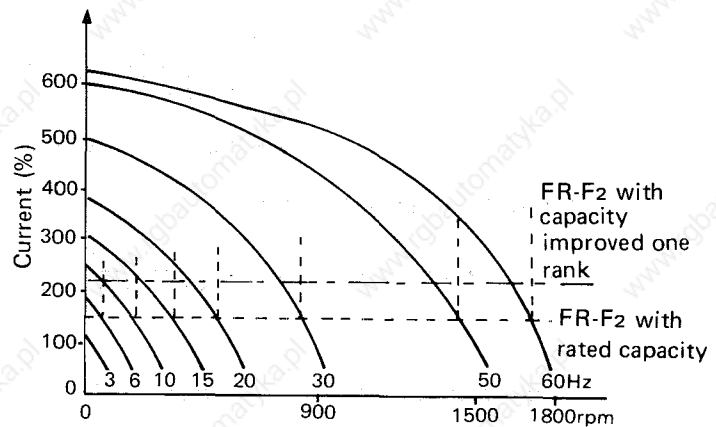

Fig. 5.3 Speed vs. Current Curve

Since motor torque changes in proportion to the square of voltage, it is influenced by the output voltage of inverter. In Model FR-F2 and FR-K inverters, when the input voltage (line voltage) of inverter reduces, the output voltage may sometimes reduce slightly, resulting in decrease of starting torque. (The starting current of motor also reduces.)

5.3 Acceleration/Deceleration Time

To hold the starting current of motor to within the overcurrent resistance amount of inverter, the motor is started at 3Hz without regard to the capacity and type of inverter, and the output frequency of inverter is gradually increased in increments indicated by frequency resolution. When the motor is decelerated from the preset frequency by the inverter, the output frequency of inverter is gradually decreased in order to prevent excessive direct-current bus voltage of inverter due to regenerative energy from the motor. For such reasons, when the motor is accelerated and decelerated by the inverter, it is required to set the acceleration time and deceleration time of output frequency ranging from zero to maximum frequency.

5.3.1 Setting of acceleration time and deceleration time

Acceleration time or deceleration time should be set longer than the acceleration time or deceleration time determined from the motor torque, load torque and inertia inherent in the motor and load (GD^2 or WK^2).

When acceleration time is set too short, overcurrent (OCT) protection circuit is activated, causing a tripping of the inverter. When deceleration time is set too short, overcurrent (OCT) or regenerative overvoltage (OVT) protection circuit is activated, causing a tripping of the inverter.

5.3.2 Calculation of acceleration time and deceleration time

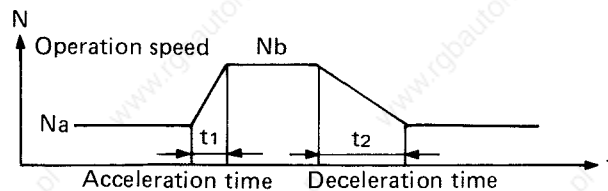

Fig. 5.4 Setting of Acceleration/Deceleration Time

(1) Simplified calculation formula of acceleration and deceleration time

$$\text{Acceleration time } ts_1 = \frac{GD^2 \times \Delta N}{375 \times (T_M \times \alpha - T_{Lmax})} (\text{sec.}) \text{ or } \frac{WK^2 \times \Delta N}{1230 \times (T_M \times \alpha - T_{Lmax})} (\text{sec.}) \quad (5.1)$$

$$\text{Deceleration time } ts_2 = \frac{GD^2 \times \Delta N}{375 \times (T_M \times \beta + T_{Lmin})} (\text{sec.}) \text{ or } \frac{WK^2 \times \Delta N}{1230 \times (T_M \times \beta + T_{Lmin})} (\text{sec.}) \quad (5.2)$$

where GD^2 (WK^2): Total GD^2 (WK^2) = motor GD^2 (WK^2) + load GD^2 (WK^2)
 (value converted into motor shaft torque)
 (GD^2 : $kg \cdot m^2$, WK^2 : $lb \cdot ft^2$, m & ft . in diameter)

ΔN : difference in motor speed before and after acceleration/deceleration $N_b - N_a$ (rpm)

T_M : motor rated torque

$$T_M = \frac{974 \times P}{N} (\text{kg} \cdot \text{m}) \text{ or } T_M = \frac{5250 \times \text{HP}}{N} (\text{lb} \cdot \text{ft.}) \quad (5.3)$$

T_{Lmax} : maximum load torque (converted into motor shaft torque) ($kg \cdot m$)

T_{Lmin} : minimum load torque (converted into motor shaft torque) ($kg \cdot m$)

α : mean acceleration torque coefficient

β : mean deceleration torque coefficient (regenerative torque coefficient)

P : motor output (kW)

HP: motor output (HP)

N : motor rated speed (rpm)

5. SELECTION OF THE INVERTER

FREQROL-F₂

Torque Ratio		FR-F ₂		FR-K	
		V/F = CONST.	V/F = REDUC.	6 to 60Hz	60 to 120Hz
α		1.1	0.9	1.1	0.77
β	Without brake unit	0.2	0.2	Short time 0.7 0.2 for FR-K-11k and models with larger capacity and 400V class	Short time 0.46 0.13 for FR-K-11k and models with larger capacity and 400V class
	With brake unit (retarding torque:50%)	0.5	0.5	0.5	0.33
	With brake unit (retarding torque:100%)	1.0	1.0	1.0	0.67

Note: Set the interval of the ACCEL/DECEL dial time from zero to maximum output frequency of inverter. Therefore, set a value which is larger than the above calculated value of acceleration/deceleration time x maximum speed/ΔN.

Table 5.1 Acceleration/Deceleration Torque Ratios with Standard Combination of Motor, Inverter and Brake Unit

Note: 1m = 3.28ft.
1kg = 2.205lb.

$$1\text{kg}\cdot\text{m}^2 = 2.205\text{lb.} \times (3.28\text{ft.})^2 = 23.72\text{lb.}\cdot\text{ft}^2$$

$$\begin{aligned} \star \quad WK^2 (\text{lb.}\cdot\text{ft}^2) &= 23.72 \times GD^2 (\text{kg}\cdot\text{m}^2) \\ &\quad (m \ \& \ \text{ft. is by diameter)} \\ GD^2 (\text{kg}\cdot\text{m}^2) &= 0.0422 \times WK^2 (\text{lb.}\cdot\text{ft}^2) \end{aligned}$$

$$1\text{kg}\cdot\text{m} = 2.205\text{lb.} \times 3.28\text{ft.} = 7.23\text{lb.}\cdot\text{ft.}$$

$$\begin{aligned} \star \quad \text{Torque (lb.}\cdot\text{ft.)} &= 7.23 \times \text{Torque (kg}\cdot\text{m)} \\ \text{Torque (kg}\cdot\text{m)} &= 0.138 \times \text{Torque (lb.}\cdot\text{ft.)} \end{aligned}$$

$$1\text{kW} = 0.75 \times \text{HP}$$

(2) Calculation and setting of acceleration/deceleration time

Calculate and set the acceleration and deceleration times, independent of frequency range applied, as follows:

- (a) When the maximum frequency is of 60Hz pattern, calculate ts_1 and ts_2 from the expressions (5.1) and (5.2) using α and β for frequency range 6 to 60Hz, determined from Table 5.1 and $Na = 0$, $Nb = 7200/\text{number of poles}$.

With calculated results, set the ACCEL/DECEL dial as follows:

$$\text{Acceleration time} > ts_1 \dots\dots\dots (5.4)$$

$$\text{Deceleration time} > ts_2 \dots\dots\dots (5.5)$$

For better response, set the time as short as possible within the permissible range. When gradual acceleration/deceleration is required, set the required time.

5

Example

When ODP 5HP 4P motor and FR-F2-3700-U inverter (without brake unit) are used to drive a conveyor under the following conditions, determine the acceleration and deceleration times as follows:

In this case, $GD_M^2 = 0.062\text{kg}\cdot\text{m}^2$ ($WK_M^2 = 1.47\text{lb}\cdot\text{ft}^2$), $GD_L^2 = 0.15\text{kg}\cdot\text{m}^2$ ($WK_L^2 = 3.56\text{lb}\cdot\text{ft}^2$), $T_{Lmax} = 1.5\text{kg}\cdot\text{m}$ ($10.85\text{lb}\cdot\text{ft}$), $T_{Lmin} = 1.2\text{kg}\cdot\text{m}$ ($8.68\text{lb}\cdot\text{ft}$), and set acceleration and deceleration times as short as possible.

$$GD_T^2 = 0.062 + 0.15 = 0.212\text{kg}\cdot\text{m}^2$$

$$WK_T^2 = 1.47 + 3.56 = 5.03\text{lb}\cdot\text{ft}^2$$

$$\Delta N = Nb - Na = \frac{7200}{4} - 0 = 1800\text{rpm}$$

$$T_M = \frac{974 \times 3.7}{1750} = 2.06\text{kg}\cdot\text{m}$$

$$T_M = \frac{5250 \times 5}{1750} = 15.0\text{lb}\cdot\text{ft}$$

Let $\alpha = 1.1$ and $\beta = 0.2$,

$$ts_1 = \frac{0.212 \times 1800}{375 \times (2.06 \times 1.1 - 1.5)} = 1.33\text{sec.}$$

$$ts_1 = \frac{5.03 \times 1800}{1230 \times (15 \times 1.1 - 10.85)} = 1.3\text{sec.}$$

$$ts_2 = \frac{0.212 \times 1800}{375 \times (2.06 \times 0.2 + 1.2)} = 0.63\text{sec.}$$

$$ts_2 = \frac{5.03 \times 1800}{1230 \times (15 \times 0.2 + 8.68)} = 0.63\text{sec.}$$

Thus, set the acceleration time to 2sec. and the deceleration time to 1sec..

5.4 Selection of Brake Unit

To shorten acceleration time, increase the capacity of inverter and also the capacity of motor. To shorten deceleration time, add a brake unit (option).

To decelerate a motor by an inverter, gradually reduce output frequency at the deceleration time set by the DECEL dial (which is also used as an ACCEL dial in the FR-F2 series). When an attempt is made to decelerate the motor at an interval of time shorter than the motor coast-to stop time, the motor acts as an induction generator because it is rotated at over synchronous speed of given frequency. Therefore, its rotating energy is partially consumed by the motor winding and partially accumulated in the capacitor of inverter. The brake unit serves to absorb this energy. The energy is consumed by the discharging resistor, and as a result, the braking action of motor is obtained. β in Table 5.1 indicates a brake torque ratio at the time of deceleration in relation to the rated torque of motor.

5.4.1 Selecting procedure of type BU brake unit

Brake torque is not manually adjustable in the brake unit. However, when the brake unit is combined with the inverter, the setting of required deceleration pattern (with DECEL dial) allows the motor to be decelerated with the brake torque automatically adjusted.

The brake unit suitable for individual applications can be determined as follows:

- (1) Calculate brake torque necessary to decelerate in the deceleration pattern selected.

$$T_B = \frac{GD^2 \cdot (N_1 - N_2)}{375t} - T_L \text{ (kg}\cdot\text{m)} \text{ or } T_B = \frac{WK^2 \cdot (N_1 - N_2)}{1230t} - T_L \text{ (lb}\cdot\text{ft)}$$

- (2) Perform the following calculation to know how much percentage is the calculated TB in reference to the rated torque of motor used.

$$\text{Brake torque (\%)} = \frac{T_B}{T_M} \times 100$$

- (3) Select a brake unit, of which intersecting point of brake torque (%) and deceleration time (t) exists below the characteristic curve of the motor used, from brake unit data.

Example

It is desired to decelerate from 1,750rpm to 0rpm in two seconds by use of a 5HP 4P motor under the following conditions:

Load torque (converted to motor shaft torque):

$$10\% \text{ of motor torque} = 0.2(\text{kg}\cdot\text{m}) = 1.4(\text{lb}\cdot\text{ft})$$

Load GD^2 (converted to motor shaft torque):

$$10 \text{ times of motor } GD^2 = 0.73(\text{kg}\cdot\text{m}) \text{ or } WK^2 = 17.3(\text{lb}\cdot\text{ft}^2)$$

Motor rated torque: 5HP 4P = 2.03(kg·m) = 14.7(lb·ft)

Then, the brake unit requires brake torque obtained by the following expression:

$$T_B = \frac{(0.073 + 0.73) \times (1750 - 0)}{375 \times 2} - 0.2 \quad T_B = \frac{(1.73 + 17.3) \times (1750 - 0)}{1230 \times 2} - 1$$

$$= 1.67(\text{kg}\cdot\text{m}) \quad = 12.1(\text{lb}\cdot\text{ft})$$

$$\text{Brake torque(\%)} = \frac{T_B}{T_M} \times 100 = \frac{1.67}{2.03} \times 100 = 83(\%) \text{ or } \frac{12.1}{14.7} \times 100 = 82(\%)$$

5. SELECTION OF THE INVERTER

FREQROL-F2

Therefore, 83% brake torque is required. Since the motor is stopped in two seconds, the BU-3700 brake unit can be selected for this application because of the braking capacity of BU-3700, 8 seconds in continuous, which is longer than 2 seconds.

From the repeating duty cycle capability which is shown in Fig. 5.6, the BU-3700 brake unit can be used by 9% duty cycle.

$$\frac{T_2}{T_1} \times 100 = 9, T_2 = 2\text{sec.} \quad \text{Thus } T_1 = (100/9) \times 2 = 22.1\text{sec.}$$

Repeated braking is possible once in 22.1sec.

In addition to this calculation, the motor should be examined if it can withstand the repeated duty

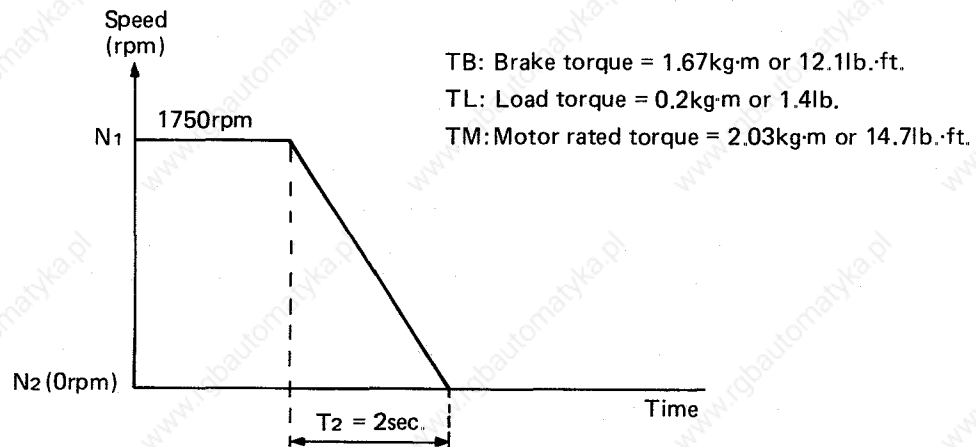

Fig. 5.5 Speed vs. Time Curve at Brake Unit

5. SELECTION OF THE INVERTER

FREQROL-F2

VOLTAGE	Motor (HP)		1	2	3	5	7.5	10	15	20
	Brake Torque	30 sec.								
200V Series	50%	30 sec.	BU-1500		BU-3700		BU-7.5K		BU-15K	
	100%	30 sec.	BU-1500	BU-3700	BU-7.5K		BU-15K		2 x BU-15K	
460V Series	50%	30 sec.	BU-H7.5K						BU-H15K	
	100%	30 sec.	BU-B7.5K				BU-H15K		BU-H30K	

VOLTAGE	Motor (HP)		30	40	50	60	75
	Brake Torque	30 sec.					
200V Series	50%	30 sec.	2 x BU-15K		3 x BU-15K		4 x BU-15K
	100%	30 sec.	3 x BU-15K	4 x BU-15K	5 x BU-15 k	6 x BU-15K	7 x BU-15K
460V Series	50%	30 sec.	BU-H30K		2 x BU-H30K		
	100%	30 sec.	2 x BU-H30K		3 x BU-H30K		4 x BU-H30K

2 x = two units are connected parallel.

Table 5.2 Type of Brake Unit

Brake unit	Discharge resister,		Quantity of series connection	Specification of resistor	Wire
BU-1500	300 W	50 Ω	1	QGZ1S 300W 50Ω	AWG# 14
BU-3700	300 W	10 Ω	3	ORGZ1B 200W 10Ω	AWG# 14
BU-7.5K	450 W	5 Ω	4	QRGZ1B 300W 5Ω	AWG# 12
BU-15K	600 W	2 Ω	6	QRGZ1B 400W 2Ω	AWG# 12
BU-H7.5K	300 W	10 Ω	6	QRGZ1B 200W 10Ω	AWG# 14
BU-H15K	450 W	5 Ω	8	QRGZ1B 300W 5Ω	AWG# 12
BU-H30K	600 W	2 Ω	12	QRGZ1B 400W 2Ω	AWG# 12

Table 5.3 Type of Brake Resistors

5. SELECTION OF THE INVERTER

FREQROL-F2

BU-1500 Short time rating (200V series)

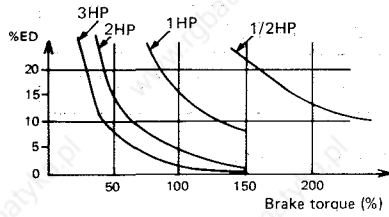
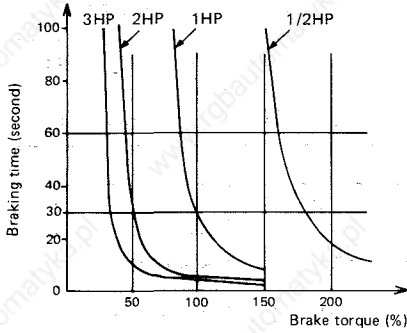

BU-3700 Short time rating (200V series)

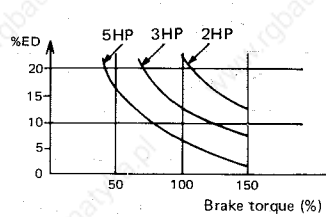
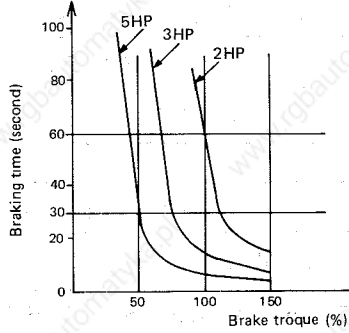

BU-7.5K Short time rating (200V series)

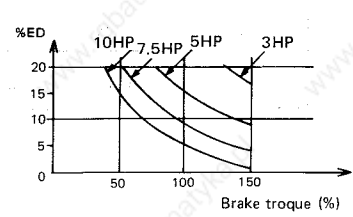
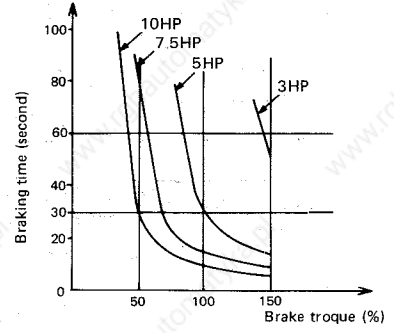

BU-15K Short time rating (200V series)

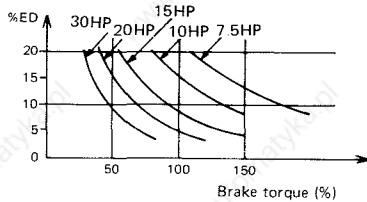
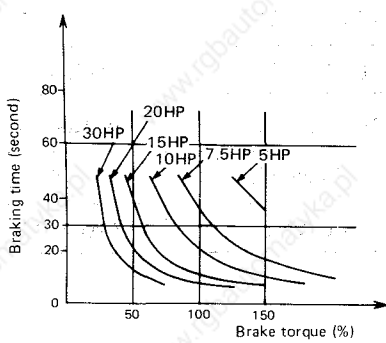

BU-H7.5K Short time rating (460V used)

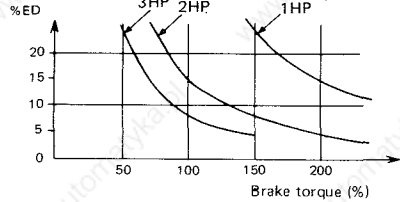
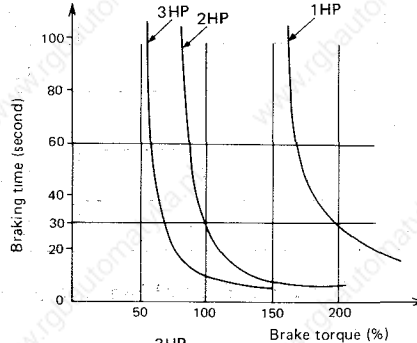

BU-H7.5K Short time rating (460V used)

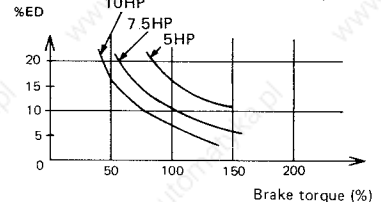
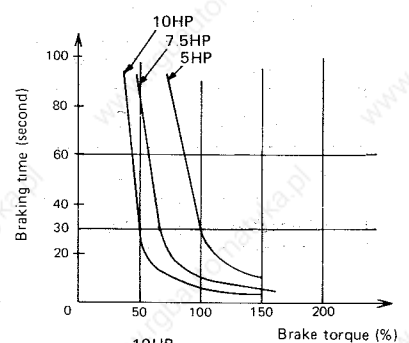

5

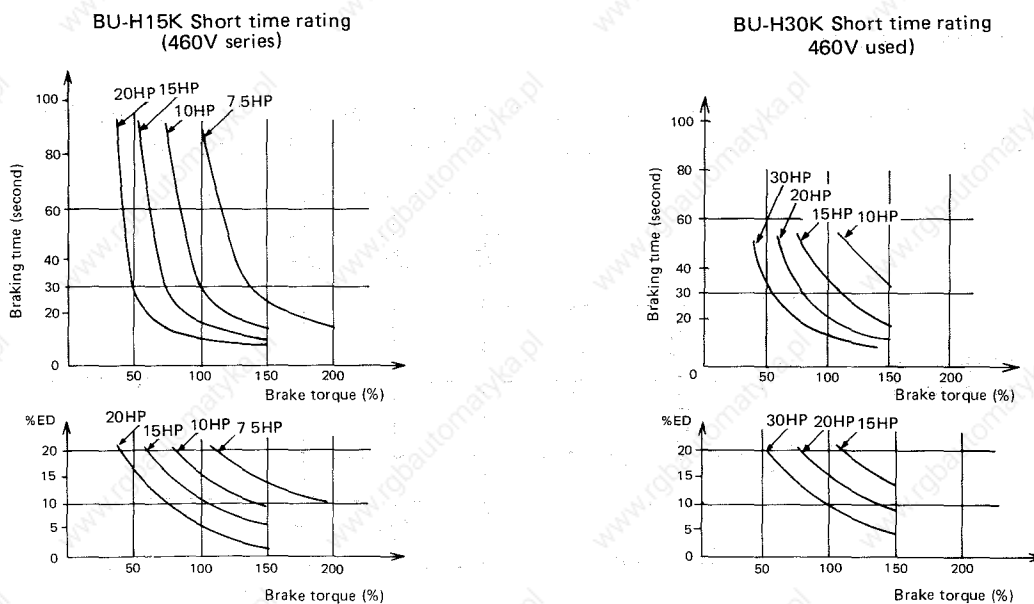

Fig. 5.6 Characteristics of brake unit

5

6. MAIN CIRCUIT DESCRIPTIONS

6.1 Converter Module

The function of the converter module is to rectify and convert the input AC three phase voltage into DC voltage. This converter is protected from line surge by the surge suppressor.

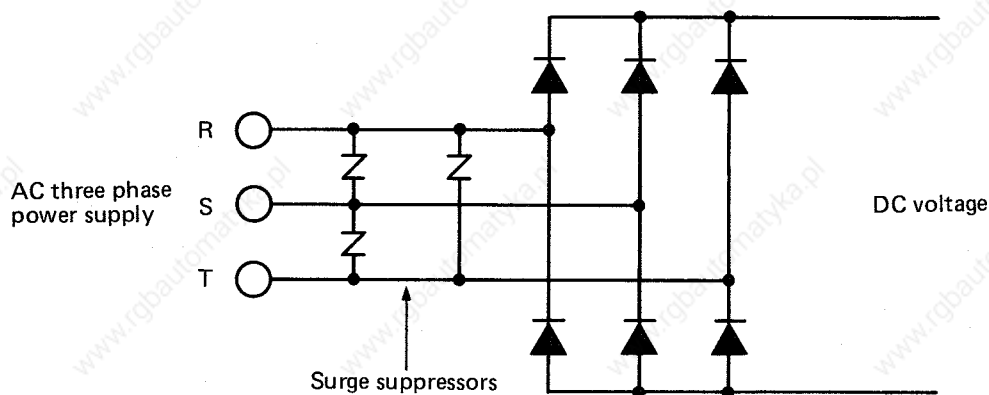

Fig. 6.11 Converter Circuit

Parts used in this circuit are listed below.

	Inverter type	Diode module	Surge suppressor
200V class	FR-F2-750B-U FR-F2-1500B-U	D20VT80 x 1	TNR23G471 x 3
	FR-F2-750-U FR-F2-1500-U FR-F2-2200-U FR-F2-3700-U FR-F2-5.5K-U FR-F2-7.5K-U	RM10TA-H x 1 RM10TA-H x 1 RM15TA-H x 1 RM15TA-H x 1 PT768 x 1 PT768 x 1	TNR23G471 x 3
	FR-F2-11K-U FR-F2-15K-U FR-F2-22K-U FR-F2-30K-U FR-F2-37K-U FR-F2-45K-U FR-F2-55K-U	PD608 x 3 PD608 x 3 PD1008 x 3 PD1008 x 3 BKO-C1922H01 x 1 BKO-C1922H02 x 1 BKO-C1922H02 x 1	BKO-C1915H02 x 1
	FR-F2-H3700-U thru. H7.5K-U FR-F2-H11K-U FR-F2-H15K-U FR-F2-H22K-U FR-F2-H30K-U thru. H55K-U	RM20TA-2H x 1 RM30-DZ-2H x 3 RM30-DZ-2H x 3 RM60-DZ-2H x 3 RM100-DZ-2H x 3	BKO-C1972H01 x 1 BKO-C1821H01 x 1

Table 6.1 Parts List of The Converter

6.2 Initial In-rush Current Suppress Resistor and Contactor

As the large capacitor is connected to the output of the converter, when the Inverter power is turned on, large amounts of current flow into the capacitor instantaneously. To suppress this large amount of current in such a short duration, resistors are connected between the output of the converter and the smoothing capacitor.

This resistor is short circuited by the relay contacts soon after the power is on. For small size inverters, only a relay is used in this circuit, but for larger size inverters, the combination of the relay and the on-delay timer are used.

The setting of this timer is about 0.1 seconds.

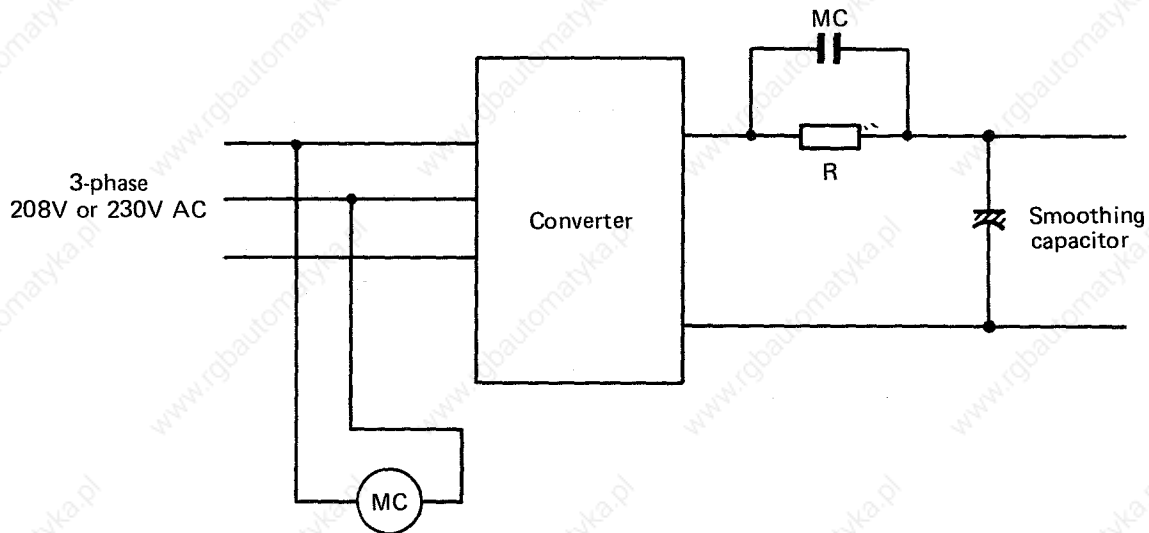

(a) For inverters up to 10HP

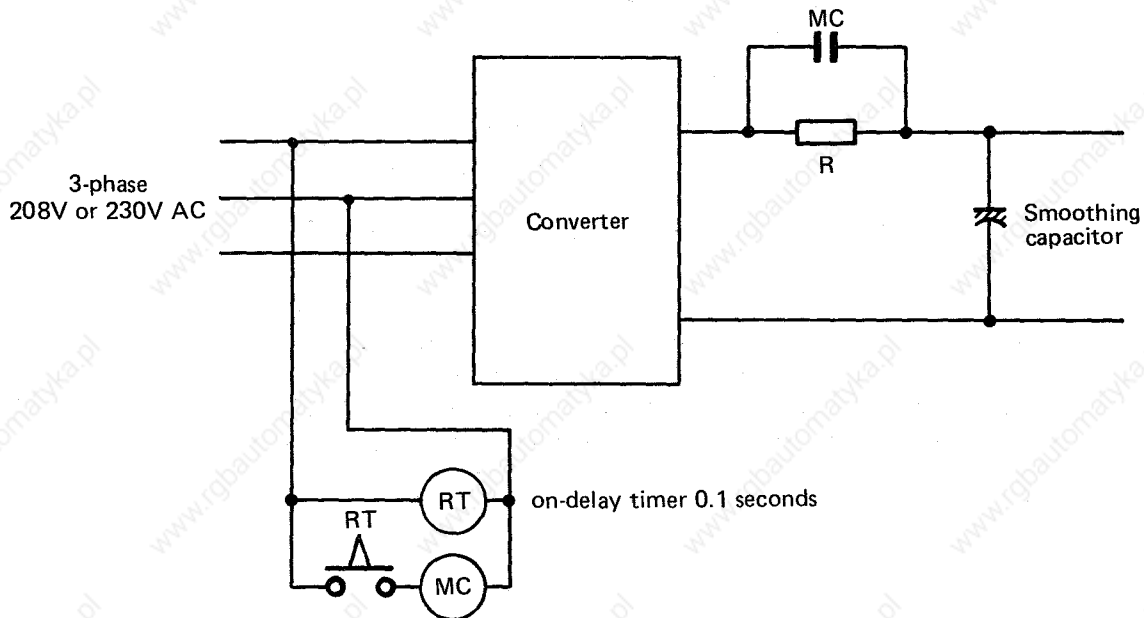

(b) For inverters 15HP through 75HP

Fig. 6.2.1 Initial Suppress Circuit for 200V class Inverter

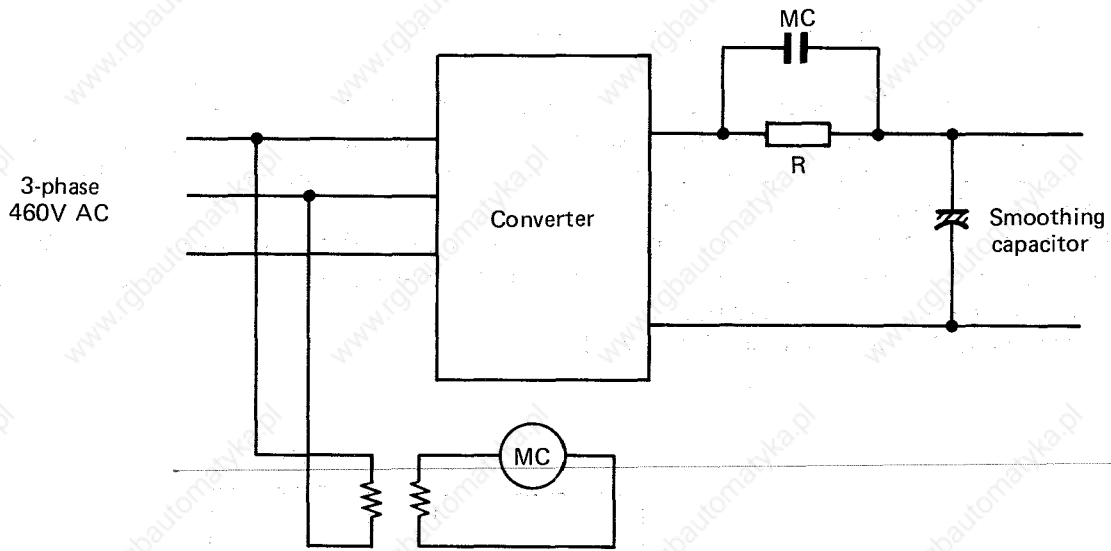

(a) For inverters up to 10HP

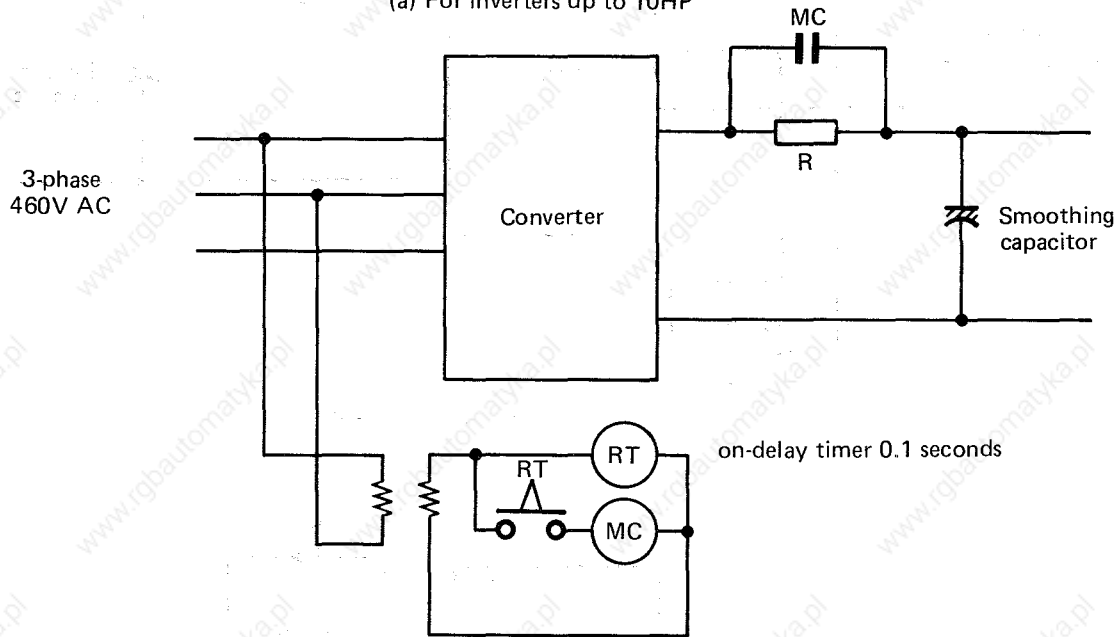

(b) For inverters 20HP thru. 75HP

Fig. 6.2.2 Initial In-rush Current Suppress Circuit for 460V Class Inverter

Note: The designing criteria for this relay and resistor is on the assumption that the power on and off is performed only few times per one day, i.e. the contact of the relay and the power capability of the resistor can not endure the heavy duty usage. So, the power on and off should be performed couple of times per one day.

6. MAIN CIRCUIT DESCRIPTIONS

FREQROL-F2

Inverter capacity		Relay (RA)	Timer	Resistor (R1)		
200V class	FR-F2-750B-U	TV24D1-0	Not used	MFS10N2R0K x 1		
	FR-F2-1500B-U	DF24D1		MFS15N2R0K x 1		
	FR-F2-750-U	JH1A BKO-C1967H04		MZS15A020K x 1		
	FR-F2-1500-U			MZS15A020K x 1		
	FR-F2-2200-U			MFS30A010K x 1		
	FR-F2-3700-U			MFS30A010K x 1		
	FR-F2-5.5K-U			SA11RM-208V AC	MHS40A0R5K x 1	
	FR-F2-7.5K-U	SA11RM-208V AC		MHS40A0R5K x 1		
	FR-F2-11K-U	SA12RM-208V AC		DRS-N2-A0P5 200V AC	MHS40B0R5K MHS 4088	x 2
	FR-F2-15K-U	SK20-208V AC				x 4
	FR-F2-22K-U	SK25-208V AC				
	FR-F2-30K-U	SK35-208V AC				
	FR-F2-37K-U	SK50-200V AC				
	FR-F2-45K-U	SK80-200V AC				
FR-F2-55K-U	SK80-200V AC					
460V class	FR-F2-H3700-U thru. H7.5K-U	SA10RM-200V AC	Not used	MFS30A010K x 2		
	FR-F2-H11K-U	SA11RM-200V AC	DRS-N2-A0P5 200V AC	MHS40B0R5K MHS-4088 x 4		
	FR-F2-H15K-U	SA11RM-200V AC				
	FR-F2-H22K-U	SA12RM-200V AC				
	FR-F2-H30K-U	SK20-200V AC				
	FR-F2-H37K-U	SK20-200V AC				
	FR-F2-H45K-U	SK35-200V AC				
	FR-F2-H55K-U	SK35-200V AC				

Note: x1 or x4 shows the number of the parts used in parallel connection.

Table 6.2 Specifications of The Parts Used in The In-rush Current Suppress Circuit

6.3 Main Circuit Capacitor (Smoothing Capacitor)

DC voltage rectified by the converter is smoothed by the main circuit smoothing capacitor. Ratings and specifications for these capacitors are shown in the Table 6.3.

Notice that this capacitor has its limited life time usually from 3 years up to 5 years and it depends on the load and the ambient temperature of the inverter, so this capacitor should be maintained and replaced periodically in every 3 to 5 years. When a capacitor is reaching to the end of its life time, the capacity of the capacitor goes down and as a result, the ripple of the output voltage will increase which leads to the unstable operation of the motor. If a inverter is continued to be used under this condition, the capacitor would result in the break down finally.

Inverter type		Type of capacitor	Quantity
200V class	FR-F2-750B-U	600 μ F BKO-C1935H03	1
	FR-F2-1500B-U		2
	FR-F2-750-U	600 μ F BKO-C1935H02	1
	FR-F2-1500-U	1200 μ F BKO-C1876H08	1
	FR-F2-2200-U	2400 μ F BKO-C1876H09	1
	FR-F2-3700-U	2400 μ F BKO-C1876H09	1
	FR-F2-5.5K-U	2000 μ F BKO-C1876H03	2
	FR-F2-7.5K-U	2400 μ F BKO-C1876H09	2
	FR-F2-11K-U	3200 μ F BKO-C1920H01	2
	FR-F2-15K-U		3
	FR-F2-22K-U		4
	FR-F2-30K-U		6
	FR-F2-37K-U		7
	FR-F2-45K-U		8
FR-F2-55K-U	10		
460V class	FR-F2-H3700-U	1500 μ F BKO-C1944H04	2
	FR-F2-H5.5K-U		4
	FR-F2-H7.5K-U		4
	FR-F2-H11K-U	4000 μ F BKO-C1944H06	4
	FR-F2-H15K-U		4
	FR-F2-H22K-U		6
	FR-F2-H30K-U		8
	FR-F2-H37K-U		8
	FR-F2-H45K-U		10
	FR-F2-H55K-U		10

Table 6.3 Specifications of Smoothing Capacitor

Note: Voltage ratings are 350V DC for 200V class and 400V DC for 460V class inverter. For the 460V class inverter, two groups of capacitors are connected in series.



B848298-7

Fig. 6.3 Outlook of Main Circuit Capacitor

6.4 DC Current Transformer (DC-CT)

To detect the output current, two DC-CTs are installed in the DC-BUS circuit as shown in Fig. 6.4.1.

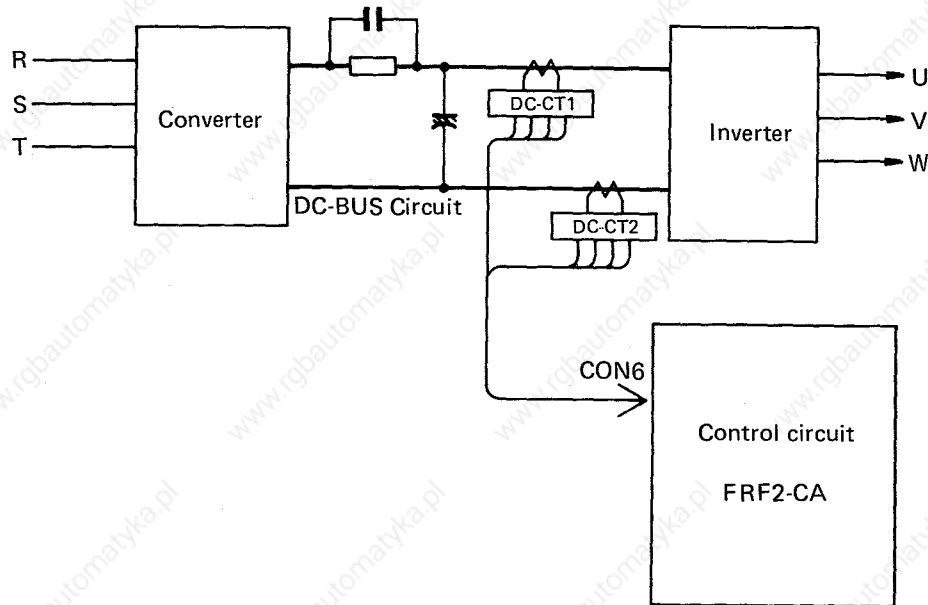

Fig. 6.4.1 DC-CT Connection Diagram

6

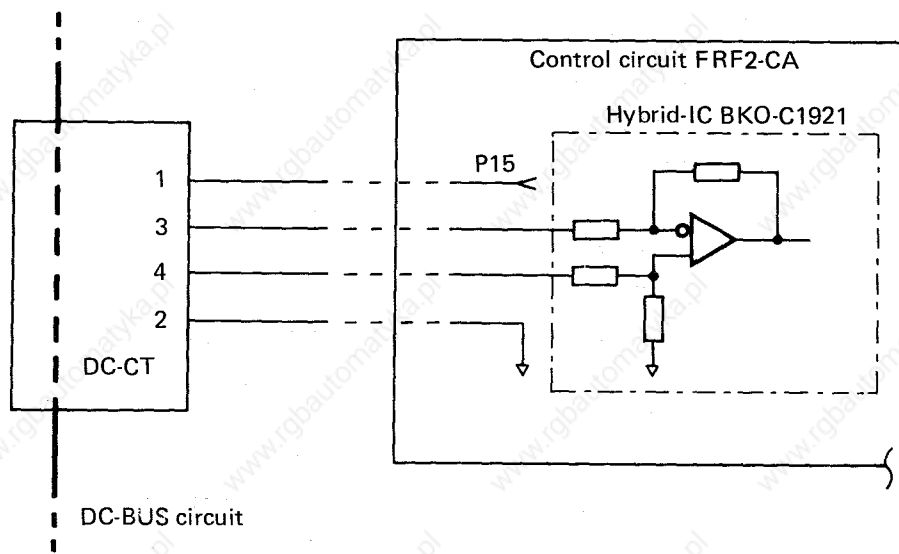
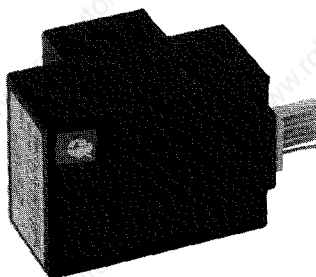

Fig. 6.4.2 Function of DC-CT



B843085-5

Fig. 6.4.3 Outlook of DC-CT

6. MAIN CIRCUIT DESCRIPTIONS

FREQROL-F2

The function of the DC-CT is to convert the amounts of the main circuit DC current into the DC output voltage. The rated output voltage is 50mV at the rated current. But as this output signal is the differential signal, it is impossible to measure this voltage directly at the output terminal of the DC-CT. In the control card (printed circuit board), the output signal from the DC-CT is connected to the hybrid IC type BKO-C1921 as shown in Fig. 6.4.2. This hybrid IC functions as a differential amplifier which produces the signal of 50mV per rated current.

At the checking or the replacement of this part, the following precautions must be taken.

1. The DC-CT is vulnerable to the static electricity. So do not touch any measuring tools, including the multimeter, to the terminal of the DC-CT at any time.
2. When carrying or storing the DC-CT, use the antistatic electricity container.
3. At the replacement, take care to keep the same turning number of the main circuit wiring. For types of this DC-CT, refer to Table 6.4.

Inverter type		DC-CT type	Quantity	
200V class	FR-F2-750B-U	BKO-C1977H13	2	
	FR-F2-1500B-U	BKO-C1977H14	2	
	FR-F2-750-U	BKO-C1909H02	2	
	FR-F2-1500-U	BKO-C1909H03	2	
	FR-F2-2200-U	BKO-C1909H05	2	
	FR-F2-3700-U	BKO-C1909H05	2	
	FR-F2-5.5K-U	BKO-C1909H06	2	
	FR-F2-7.5K-U	BKO-C1909H07	2	
	FR-F2-11K-U	BKO-C1909H08	2	
	FR-F2-15K-U	BKO-C1909H09	2	
	FR-F2-22K-U	BKO-C1909H11	2	
	FR-F2-30K-U	BKO-C1909H12	2	
	FR-F2-37K-U	BKO-C1909H13	2	
	FR-F2-45K-U	BKO-C1909H14	2	
	FR-F2-55K-U	BKO-C1909H15	2	
	460V class	FR-F2-H3700-U	BKO-C1909H29	2
		FR-F2-H5.5K-U	BKO-C1909H17	2
FR-F2-H7.5K-U		BKO-C1909H17	2	
FR-F2-H11K-U		BKO-C1909H19	2	
FR-F2-H15K-U		BKO-C1909H19	2	
FR-F2-H22K-U		BKO-C1909H21	2	
FR-F2-H30K-U		BKO-C1909H23	2	
FR-F2-H37K-U		BKO-C1909H23	2	
FR-F2-H45K-U		BKO-C1909H25	2	
FR-F2-H55K-U		BKO-C1909H25	2	

Table 6.4 Types of DC-CT

6.5 Transistor Module (Transistor Chopper)

(1) Circuit diagram of transistor module

The transistor module used in the FR-F2 inverter has two kinds of circuit constructions. One of them is, as shown in Fig. 6.5.1, the type which includes six transistors in one package and another one includes two transistors in one package as shown in Fig. 6.5.2. The former one is applied to the transistor type QM15TC-H, QM20TC-H and the latter one is applied to all other types of transistor.

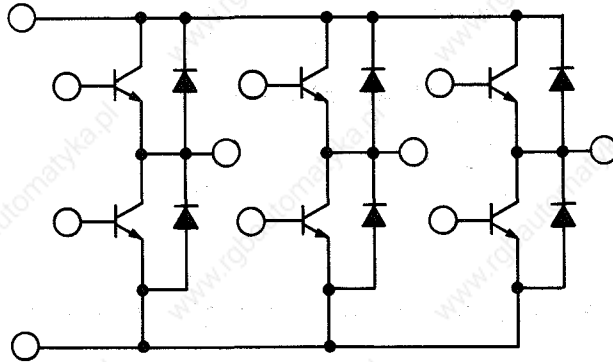

Fig. 6.5.1 Six Transistors Type Module (Applied to the QM15TC-H and QM20TC-H)

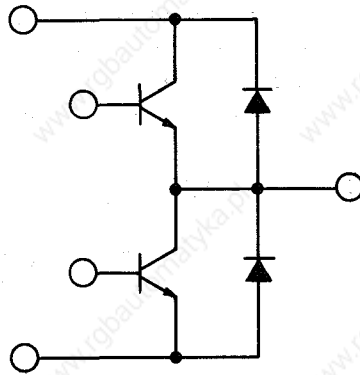
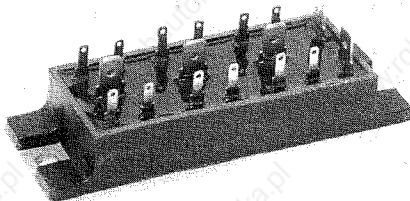

Fig. 6.5.2 Two Transistors Type Module (Applied to all other types of module)

As shown in Fig. 2.1., transistor chopper circuit requires at least six transistors. So, when the six transistors packed type module is used, only one transistor module is used.

But in the case of two transistors packed type module, at least three transistor modules are required and the number of the transistor modules used in the circuit depends on the output rated current of the inverter because of the parallel connection of transistor modules.



B843083-7

Fig. 6.5.3 Outlook of Six Transistors Packed Type Module

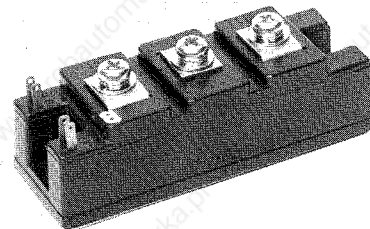

B843083-9

Fig. 6.5.4 Outlook of Two Transistors Packed Type Module

(2) Inspection and checking of transistor module

As the power transistor is connected in the "Darlington Connection" as shown in Fig. 6.5.5, the inspection result is a little different from one of a usual transistor. So, inspect the power transistor in the following manner.

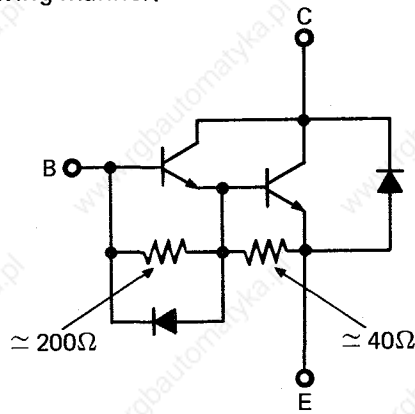

Fig. 6.5.5 Darlington Connection of Power Transistor

(a) Power-on inspection

Under the condition of the driving of the inverter, inspect and check the voltage waveform between the emitter (E) and the base (B). If the power transistor is in its normal operations, the inspected waveforms is like Fig. 6.5.6 (a). If it is not normal, the amplitude of the waveform is somehow lower than the normal one as shown in Fig. 6.5.6 (b).

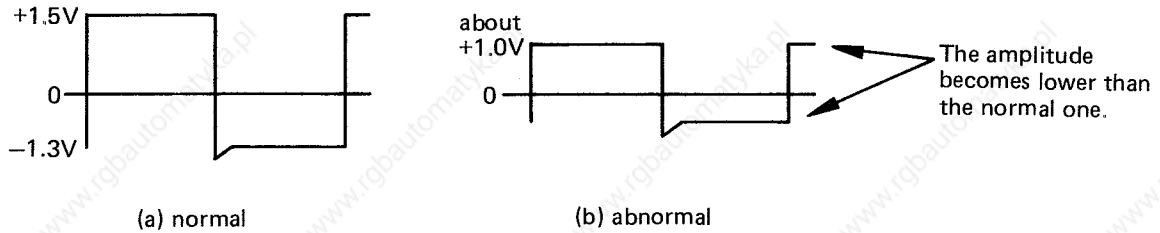

Fig. 6.5.6 B-E Waveform of Power Transistor

CAUTION

Be careful not to touch any conductive parts of the inverter during the power on inspection. Electrical shock may cause a serious injury.

(b) Power-off inspection

Take out the power transistor to be inspected and check via the following Fig. 6.5.7.

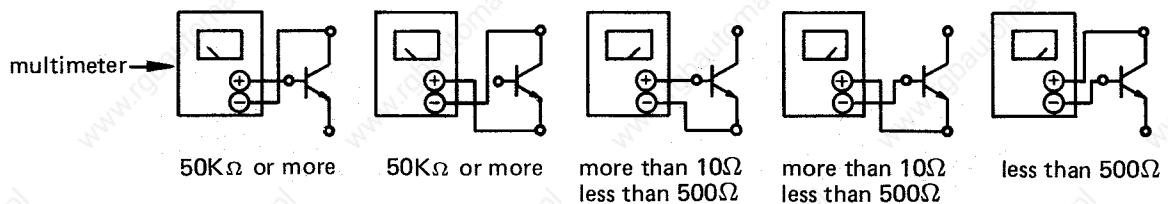

Fig. 6.5.7 Checking of Normal Transistor

Note:

Use silicon compound between the transistor and the heatsink at the replacement of the transistor.

6. MAIN CIRCUIT DESCRIPTIONS

FREQROL-F2

For details of the types of power transistors, refer to Table 6.5.

Inverter type	Type of transistor	Quantity	
200V class	FR-F2-750B-U	QM15TC-H BKO-C1982H02	1
	FR-F2-1500B-U	QM20TC-H BKO-C1982H03	1
	FR-F2-750-U	QM15TB-H BKO-C1905H03	1
	FR-F2-1500-U	QM20DX-H BKO-C1869H02	3
	FR-F2-2200-U	QM50DY-H BKO-C1869H03	3
	FR-F2-3700-U	QM50DY-H BKO-C1869H03	3
	FR-F2-5.5K-U	QM50DY-H BKO-C1869H03	3
	FR-F2-7.5K-U	QM100DY-H BKO-C1819H02	3
	FR-F2-11K-U	QM150DY-H BKO-C1945H01	3
	FR-F2-15K-U	QM100DY-H BKO-C1819H02	6
	FR-F2-22K-U	QM150DY-H BKO-C1945H02	6
	FR-F2-30K-U	QM150DY-H BKO-C1945H03	9
	FR-F2-37K-U	QM100DY-H BKO-C1819H04	12
	FR-F2-45K-U	QM150DY-H BKO-C1945H03	9
	FR-F2-55K-U	QM150DY-H BKO-C1945H04	12
460V class	FR-F2-H3700-U	QM25DY-2HA BKO-C1851H02	3
	FR-F2-H5.5K-U	QM50DY-2HA BKO-C1851H03	3
	FR-F2-H7.5K-U	QM50DY-2HA BKO-C1851H03	3
	FR-F2-H11K-U	QM100DY-2HA BKO-C1851H04	3
	FR-F2-H15K-U	QM100DY-2HA BKO-C1851H04	3
	FR-F2-H22K-U	QM100DY-2HA BKO-C1851H04	6
	FR-F2-H30K-U	QM100DY-2HA BKO-C1851H04	6
	FR-F2-H37K-U	QM100DY-2HA BKO-C1851H04	6
	FR-F2-H45K-U	QM100DY-2HA BKO-C1851H04	9
	FR-F2-H55K-U	QM100DY-2HA BKO-C1851H04	9

Table 6.5 Type Designations of Power Transistors

6

7. CONTROL CARD

7.1 Card Application

The control card type "FRF2-CB or CA" and "FRF2-DR" are applied in the following manner.

- FRF2-CB.....Main control card
- FRF2-DR.....Driver amplifier card for 230V class inverter
- FRF2-HR.....Driver amplifier card for 460V class inverter

Inverter type		Type of control card	Type of driver amplifier card		
200V class	FR-F2-750B-U FR-F2-1500B-U	FRF2-MA12 FRF2-MA22	Not used		
	FR-F2-750-U FR-F2-1500-U FR-F2-2200-U FR-F2-3700-U	FRF2-CB12(CA12)			
	FR-F2-5.5K-U FR-F2-7.5K-U	FRF2-CB32(CA32)			
	FR-F2-11K-U FR-F2-15K-U FR-F2-22K-U FR-F2-30K-U FR-F2-37K-U	FRF2-CB31(CA31)		FRF2-DR1	
	FR-F2-45K-U FR-F2-55K-U			FRF2-DR2	
	460V class	FR-F2-H3700-U FR-F2-H5.5K-U FR-F2-H7.5K-U FR-F2-H11K-U FR-F2-H15K-U		FRF2-CB36(CA36)	Not used
		FR-F2-H22K-U			FRF2-HDR1
		FR-F2-H30K-U FR-F2-H37K-U FR-F2-H45K-U FR-F2-H55K-U		FRF2-CB35(CA35)	FRF2-HDR2

Table 7.1 Application of The Control Card

7. CONTROL CARD

FREQROL-F2

Note: Each printed circuit board does not have any compatibility. Use exactly the same cards as listed in Table 7.1 at the replacement of the control card.

Note: The character "A" of FRF2-CA means the version of the control card and new version has the compatibility with old one.

EX. FRF2-CA12 and FRF2-CB12 is compatible.

7.2 Basic Operation of the Control Card

The block diagram of FRF2-CB is shown in Fig. 7.1.

As shown in the block diagram, the speed command, the accel and decel setting signal or other signals are given to the microprocessor through the interface circuit.

The microprocessor produces both the frequency command and the voltage command according to the frequency command and the F/V pattern. These digital signals produced by the microprocessor are converted into the pulse train signal by the read only memory (ROM). These pulse train signals are changed into the base current signal which is required to drive the main circuit transistor module.

For inverters whose capacity is 15HP or more (for 200V class) or 30HP or more (for 460V class), the basic current amplifying card type FRF2-DR (for 200V class) or FRF2-HDR (for 460V class) are provided.

According to the base current signal, the main circuit transistor module converts the DC voltage into the required PWM (Pulse Width Modulation) alternative voltage.

The DC-BUS current detected by two DC-CTs is given to the logic circuit (IC BKO-C1921) together with the DC-BUS voltage which is isolated by the IC BKO-C1913. According to the logic circuit determined by the IC BKO-C1914, the stall prevention signal is given to the microprocessor and other fault signals (Ground fault, overload, overcurrent tripping, overvoltage, and instantaneous power failure) are activated.

The signal from the thermal sensor is also given to this control card. This thermal sensor is normally coiled and mounted to the inverter 7.5HP or more (200V class) and 10HP or more (460V class). The block diagram of the p.c.b., FRF2-MA12 and -MA22 for new type B series are the same as FRF2-CA series, but as the power circuits of the inverter are mounted on the p.c.b., input transformer, converter module, transistor module, initial inrush current suppress resistor, contactor and two DC current transformers are also mounted on the same p.c.b.. But the smoothing capacitors are not mounted on the p.c.b.. Therefore, the type and the outollk of those components and the internal construction of B type (FR-F2-750B-U and 1500B-U) are different from the all other FR-F2 series.

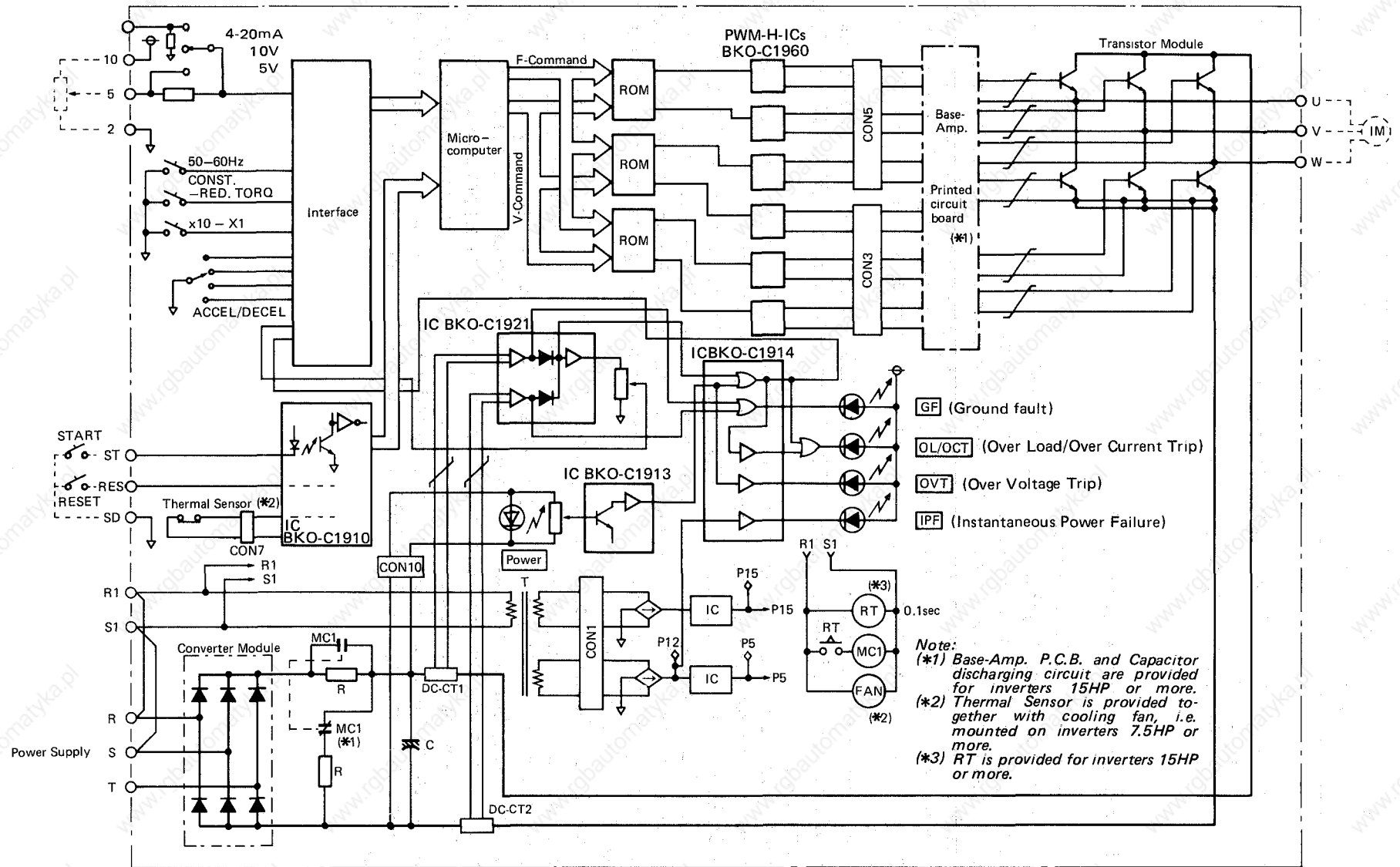

Fig. 7.1 Block Diagram of Control Card FRF2-CB(A)

Note:
 (*1) Base-Amp. P.C.B. and Capacitor discharging circuit are provided for inverters 15HP or more.
 (*2) Thermal Sensor is provided together with cooling fan, i.e. mounted on inverters 7.5HP or more.
 (*3) RT is provided for inverters 15HP or more.

7. CONTROL CARD

FREQROL-F2

7.3 Fault Indicating Lamp

The functions of fault indicators are as listed below.

GF (Ground fault)	At least one of motor input leads U, V and W is grounded. The principle of the detection is that two current feedbacks from two DC-CTs are always checked. Once the signal from one of DC-CTs goes to half of the other DC-CT, it is determined to have a ground fault condition. If the value of current is under 30 percent of inverter rated current, this GF detector does not work.
OL (Overload)	When the stall prevention works, this lamp lights up. The details of the stall prevention are mentioned later. (8.1)
OCT (Overcurrent trip)	If the output current exceeded 165% of the inverter's rated output current, that is defined as the overcurrent and this lamp lights up.
OVT (Overvoltage trip)	If the DC-BUS voltage exceeded the DC-BUS's overvoltage level, this lamp lights up.
IPF (Instantaneous power failure)	If the momentary power failure is longer than 15msec but shorter than about 80msec, this lamp lights up.
OCT & OVT (Light up in the same time)	If both of these lamps light up in the same time, it means that the electronic thermal relay worked because of overloading.

Note: Only one lamp is provided for two functions OL and OCT. In the case of OCT, the lamp remains lit. But in the case of OL, the lamp will blink.

7

8. SOME OPERATION PRINCIPLES OF THE TOTAL SYSTEM OF THE INVERTER**8.1 Stall Prevention****(1) Stall prevention at the acceleration mode.**

If while in the acceleration mode the output current exceeds the 150% of the rated current of the inverter, the microprocessor activates the stall prevention. During this operation, the microprocessor stops increasing the output frequency and decreases it according to the set deceleration time slope until the output current goes down below 150%. When that current gets back below 150%, the microprocessor resumes its normal operation and the output frequency is increased according to the slope of the accel-time setting.

During the stall prevention, the fault indicating lamp will blink.

If fault indicating lamp blinks during the acceleration, the accel-time setting must be prolonged. If this setting is too short, overcurrent tripping (OCT) will occur.

(2) Stall prevention at the deceleration mode.

During deceleration, once the DC-BUS voltage exceeds the stall prevention level, the stall prevention is activated. In the case of deceleration, the microprocessor does not reduce the output frequency. In this case the output frequency is kept constant during the stall prevention mode.

Like the case of the acceleration, if fault indicating lamp blinks during the deceleration, the decel-time setting must be prolonged.

(3) Stall prevention at the constant speed operation

Even under the constant speed operation, once the output current exceeds its 150% rating, the output frequency is reduced according to the decel-time setting until the current comes down below 150%. Thus OCT is avoided, and as a result, the stall of the motor which is caused by the OCT or OVT can be prevented.

Fig. 8.1 shows the functioning of the stall prevention.

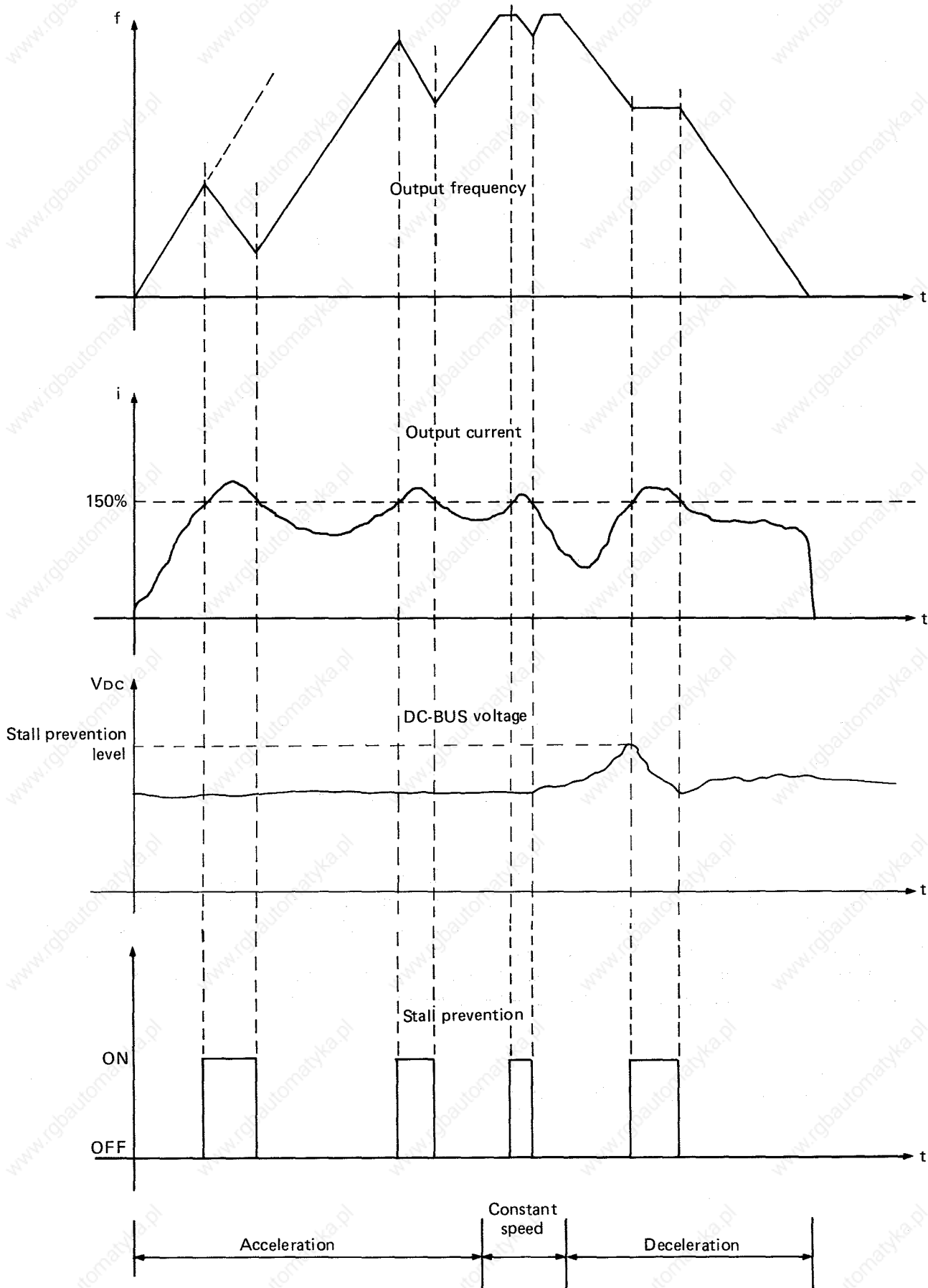

8

Fig. 8.1 Stall Prevention Timing Chart

8.2 Electronic Thermal Relay

In almost every cases, the inverter is used with a conventional induction motor which is cooled by the fan installed on the shaft of the motor. Thus the cooling capability of the motor depends on the speed of the rotor.

If the motor is driven by the commercial power supply, since it is driven in a constant speed, this cooling capability is no problem. But once the motor is driven by the inverter, the given frequency is changed from almost 0Hz up to a frequency higher than the commercial frequency. So, when the motor is driven by the low frequency, the current which is given to the motor must be reduced. In this case, conventional thermal relay does not work at all. And a new device which replaces conventional thermal relay must be introduced. The electronic thermal relay was developed for this purpose.

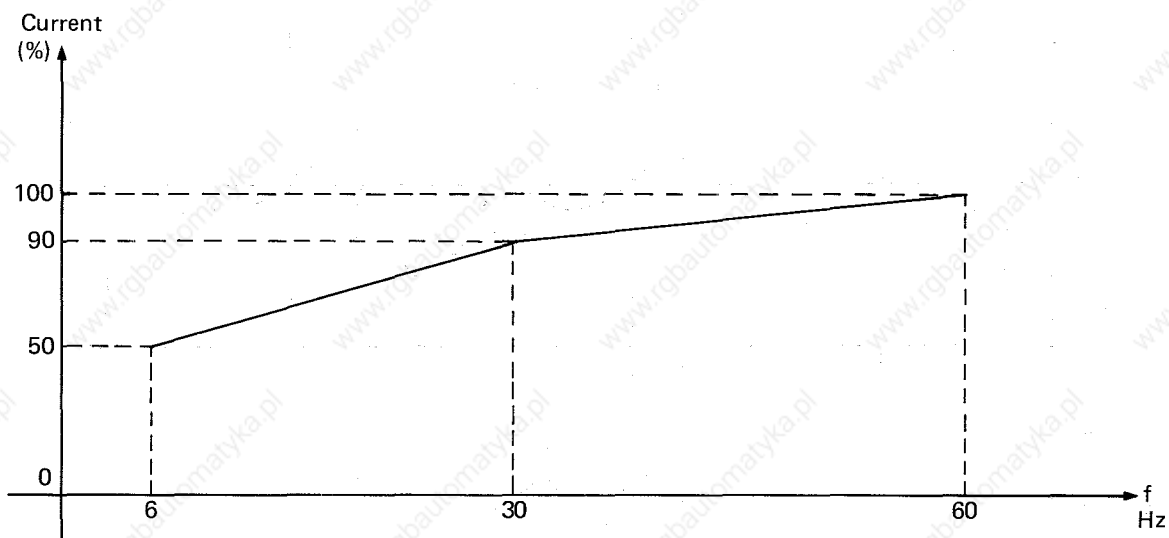

Fig. 8.2.1 Current Reduction Characteristics of Motors

As shown in Fig. 8.2.1, the current of the motor must be reduced when the operation speed is low. The motor current is always given to the microprocessor and protected according to the operation speed. Fig. 8.2.2 shows the current (%) v.s. time characteristics of the electronic thermal relay. For this electronic thermal relay, 100% current is defined by the rated current of the inverter. So, since the usual rated current of the motor is different from that of the inverter, the potentiometer labeled TH on the printed circuit board must be adjusted according to the following formula.

$$\text{Setting position (\%)} = \frac{\text{motor's rated current}}{\text{inverter's rated current}} \times 100$$

The electronic thermal relay is valid only when a single motor is driven by the inverter. If two or more motors are driven by one inverter, the potentiometer should be set to the full clockwise position and the conventional thermal relay must be installed to each motor.

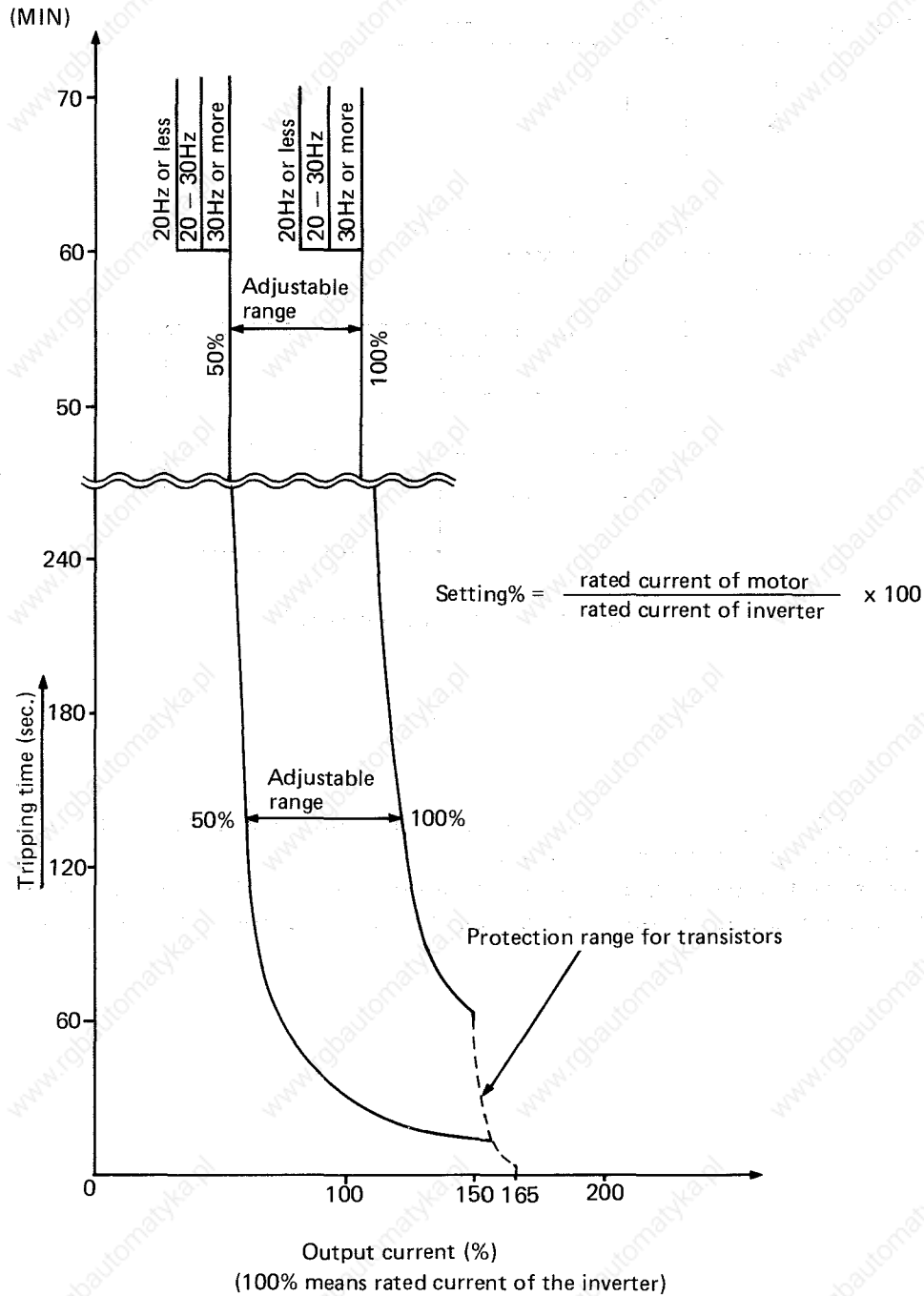

Fig. 8.2.2 Output Current vs. Tripping Time of Electronic Thermal Relay

Note: Full right position and 100% setting are the same

8.3 Ground Fault Protection

FR-F₂ inverter is equipped with the ground fault protective function.

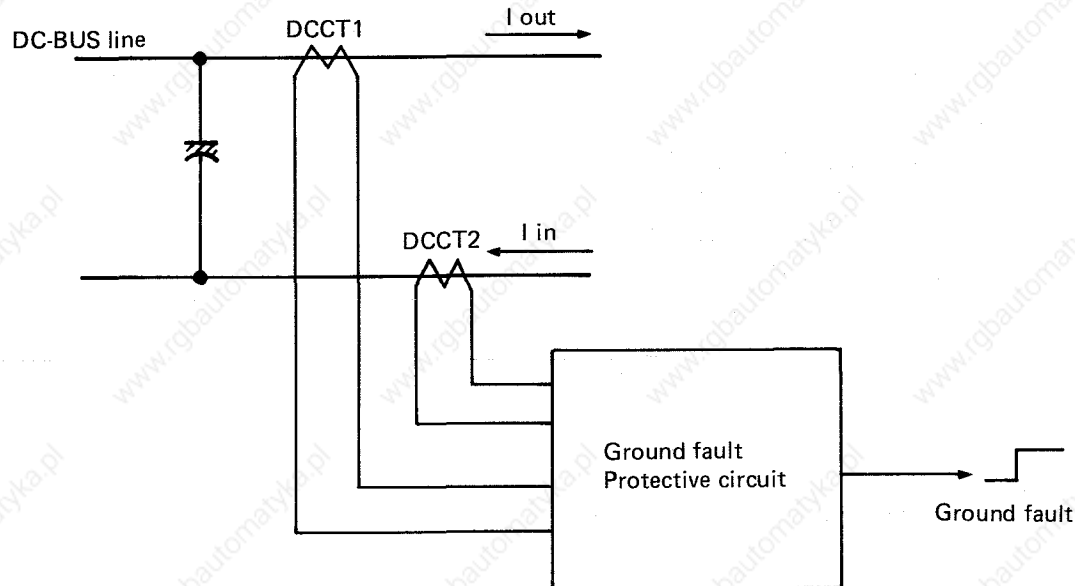

Fig. 8.3 Ground Fault Protective Circuit

As shown in Fig. 8.3, two currents, I_{out} and I_{in} , are always checked and compared by the protective circuit in the printed circuit board.

When either of two currents goes down to half of the other, the ground fault tripping is activated. This protection is not for detection of ground leakage current in milli-amperes.

9. FUSING

To protect elements in the inverter, it is recommended to install semi-conductor protection fuses (fast acting fuses) at the input of the inverter. Specifications of fuses are listed in the Table. 7.1.

Inverter type		Fuse rated current	Device I ² t	In-rush I ² t
200V class	FR-F2-750B(750)-U, 1500B(1500)-U	25 amps (rms)	413 A ² sec.	23 A ² sec.
	FR-F2-2200, 3700-U	35 amps (rms)	540 A ² sec.	182 A ² sec.
	FR-F2-5.5K-U	60 amps (rms)	4150 A ² sec.	608 A ² sec.
	FR-F2-7.5K-U	60 amps (rms)	4150 A ² sec.	729 A ² sec.
	FR-F2-11K-U	100 amps (rms)	6000 A ² sec.	973 A ² sec.
	FR-F2-15K-U	125 amps (rms)	6000 A ² sec.	730 A ² sec.
	FR-F2-22K-U	180 amps (rms)	17000 A ² sec.	973 A ² sec.
	FR-F2-30K-U	200 amps (rms)	17000 A ² sec.	2919 A ² sec.
	FR-F2-37K-U	300 amps (rms)	36400 A ² sec.	3406 A ² sec.
	FR-F2-45K-U	350 amps (rms)	80000 A ² sec.	3893 A ² sec.
FR-F2-55K-U	400 amps (rms)	80000 A ² sec.	3865 A ² sec.	
460V class	FR-F2-H3700-U	35 amps (rms)	660 A ² sec.	115 A ² sec.
	FR-F2-H5.5K, H7.5K-U	35 amps (rms)	660 A ² sec.	228 A ² sec.
	FR-F2-H11K, H15K-U	75 amps (rms)	6000 A ² sec.	458 A ² sec.
	FR-F2-H22K-U	110 amps (rms)	6000 A ² sec.	610 A ² sec.
	FR-F2-H30K, H37K-U	150 amps (rms)	16500 A ² sec.	915 A ² sec.
	FR-F2-H45K, H55K-U	200 amps (rms)	16500 A ² sec.	1524 A ² sec.

Table 9.1 Specifications of Fuses

In the table, "Device I²t" shows permissible I²t of the diode in the converter, and "In-rush I²t" shows the amount of the input current caused by the smoothing capacitor at the power on. Thus the fuse should be chosen following the criteria of the following formula:

- (1) Permissible I²t of the fuse > In-rush I²t
- (2) Melting I²t of the fuse ≤ device I²t

As an example, fuses made by INTERNATIONAL RECTIFIER Co. are selected in Table 9.2.

Inverter type		Type of Fuses
200V class	FR-F2-750B(750) throu. 2200-U	SF25 x 25
	FR-F2-3700-U	SF25 x 40
	FR-F2-5.5K-U	SF25 x 60
	FR-F2-7.5K-U	SF25 x 80
	FR-F2-11K-U	SF25 x 100
	FR-F2-15K-U	SF25 x 125
	FR-F2-22K-U	SF25 x 180
	FR-F2-30K-U	SF25 x 200
	FR-F2-37K-U	SF25 x 300
	FR-F2-45K-U	SF25 x 350
	FR-F2-55K-U	SF25 x 400
460V class	FR-F2-H3700-U	SF50P40
	FR-F2-H5.5K, H7.5K-U	SF50P40
	FR-F2-H11K, H15K-U	SF50P75
	FR-F2-H22K-U	SF50P110
	FR-F2-H30K, H37K-U	SF50P150
	FR-F2-H45K, H55K-U	SF50P200

Table 9.2 Example of Fuses

10. POWER FACTOR IMPROVING REACTOR

As the input current of the inverter is different from the usual three phase AC current, as shown in Fig. 10.1, the input power factor is lower than 1.0. To improve the power factor, the power factor improving reactor listed below can be used.

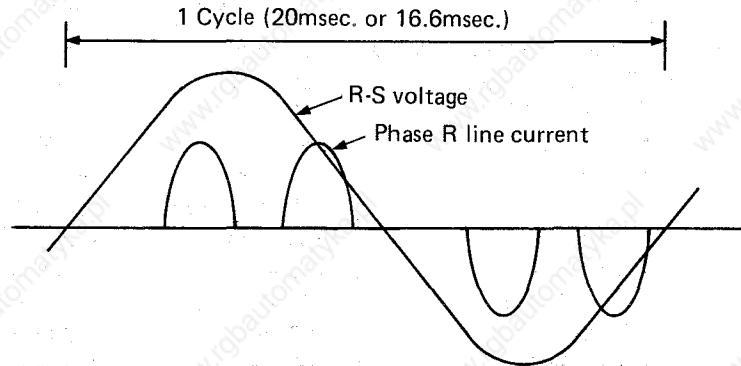

Fig. 10.1 Input Current Waveform of Inverter

Inverter type		Reactor rated current	Inductance	Type
200V class	FR-F2-750-U (750B-U)	5.5 amps	9 mH	BKO-C1969-H02
	FR-F2-1500-U (1500B-U)	9 amps	5.5 mH	BKO-C1969-H03
	FR-F2-2200-U	13 amps	4.0 mH	BKO-C1969-H04
	FR-F2-3700-U	22 amps	2.2 mH	BKO-C1969-H05
	FR-F2-5.5K-U	29 amps	1.7 mH	BKO-C1969-H06
	FR-F2-7.5K-U	44 amps	1.1 mH	BKO-C1969-H07
	FR-F2-11K-U	58 amps	0.84 mH	BKO-C1969-H08
	FR-F2-15K-U	81 amps	0.6 mH	BKO-C1969-H09
	FR-F2-22K-U	120 amps	0.4 mH	BKO-C1969-H10
	FR-F2-30K-U	150 amps	0.33 mH	BKO-C1969-H11
	FR-F2-37K-U	190 amps	0.25 mH	BKO-C1969-H12
	FR-F2-45K-U	230 amps	0.21 mH	BKO-C1969-H13
	FR-F2-55K-U	290 amps	0.17 mH	BKO-C1969-H14
	460V class	FR-F2-H3700-U	12 amps	7.4 mH
FR-F2-H5.5K-U		16 amps	5.6 mH	BKO-C1974-H02
FR-F2-H7.5K-U		23 amps	4.0 mH	BKO-C1974-H03
FR-F2-H11K-U		31 amps	3.0 mH	BKO-C1974-H04
FR-F2-H15K-U		42 amps	2.3 mH	BKO-C1974-H05
FR-F2-H22K-U		58 amps	1.7 mH	BKO-C1974-H06
FR-F2-H30K-U		76 amps	1.3 mH	BKO-C1974-H07
FR-F2-H37K-U		95 amps	1.0 mH	BKO-C1974-H09
FR-F2-H45K-U		115 amps	0.84 mH	BKO-C1974-H10
FR-F2-H55K-U		147 amps	0.66 mH	BKO-C1974-H11

Table 10.1 Types of Power Factor Improving Reactor

11. RADIO INTERFERENCE NOISE

When the motor is driven by the inverter, high-frequency noise is radiated by the inverter. Like the power supply noise, this noise gives great influence on the frequency band of 10MHz or lower. When this noise enters a radio receiver, noise may be generated from the radio. The following explains methods of restricting the radio noise, propagation paths of it and measuring methods of it.

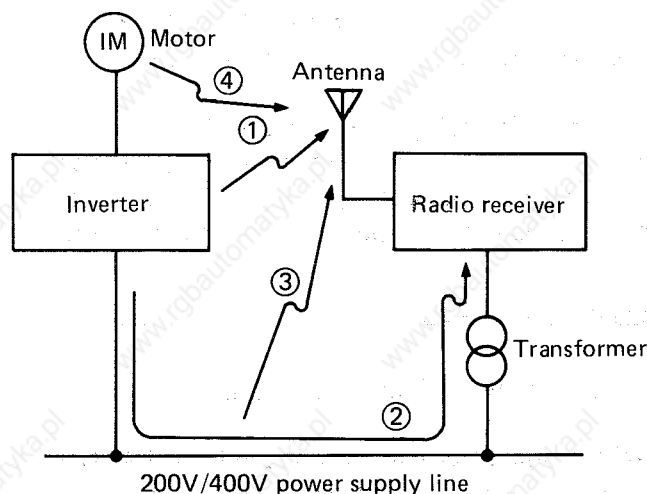

Fig. 11.1 Propagation Paths of Radio Noise

11.1 Propagation Path of Noise

Possible propagation paths of radio wave noise from the noise source to the hindered receiver are mainly as shown in Fig. 11.1.

(a) Direct radiation

Noise which is directly radiated by the noise source as airborne wave and enters the antenna or circuit of receiver.

(b) Direct transmission

Noise current which is transmitted through the power cable and flows into the receiver.

(c) Radiation (induction) from power supply cable

Noise which has leaked to the power supply cable, is radiated from the distribution line, and enters the receiver.

(d) Radiation from power cable

Noise which is radiated from wiring between the inverter and motor and enters the receiver.

11.2 Noise Measuring Method

(a) Measurement of noise terminal voltage

Method of measuring the strength of disturbing wave, which flows out to the power supply cable of disturbance generating equipment as disturbing wave voltage of the distribution cable to which the equipment is connected.

The unit of measurement is represented in dB ($1\mu\text{V} = 0\text{dB}$).

(b) Measurement of noise field strength

Method of measuring the strength of electric field, which is radiated from the disturbance generating equipment to the air, with an antenna. The measuring distance between the equipment and antenna is specified 10 m or 3 m.

The unit of measurement is represented in dB ($1 \mu\text{V}/\text{m} = 0\text{dB}$).

(c) There is another method of measuring disturbing electric power and discontinuous noise (click) of contact equipment depending on the type of noise.

As described above, the disturbing wave noises differ greatly depending on the differences of propagation paths and the types of noise measuring methods. In order to compare the actual damage of radio receiver by the disturbing wave, the measurement of noise field strength is the most suitable because the propagation path (a), (c) or (d) gives the greatest influence.

11.3 Measures Against Radio Noise

Radio noise can be reduced by the following methods:

- (a) Connect the radio noise filter exclusively used for FREQROL (FR-BIF) to the inverter input power supply terminals (R, S, T phases), and positively ground the grounding wire. This is effective when the wiring distance between inverter and motor is short. (Fig. 11.2)

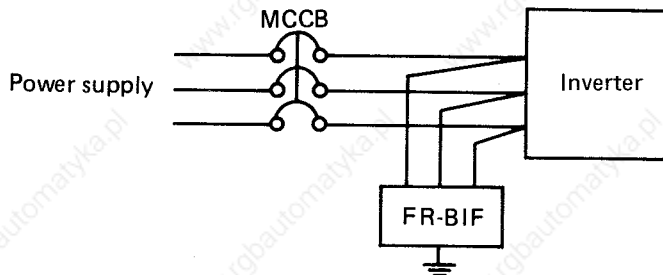

Fig. 11.2

- (b) Place the inverter inside a steel box (without instrument ports or indicator light ports) and ground the steel box.
- (c) Connect the noise filter to the I/O terminals of inverter, and place the inverter and cables in ground pipe. Minimize the length of grounding wire and completely ground. (Fig. 11.3)

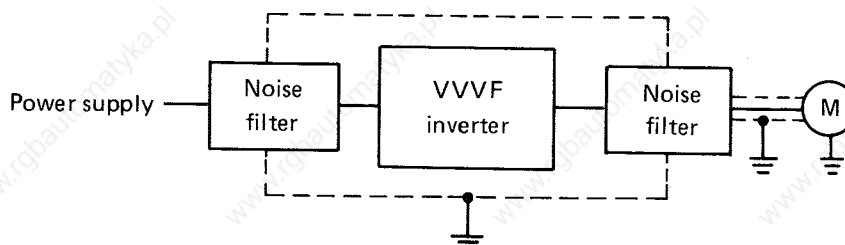

Fig. 11.3

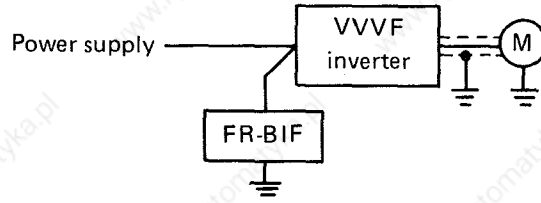

Fig. 11.4

11.4 The Type and Outline of Filter

Type	FR-BIF	for 200V class inverter
	FR-BIF-H	for 460V class inverter

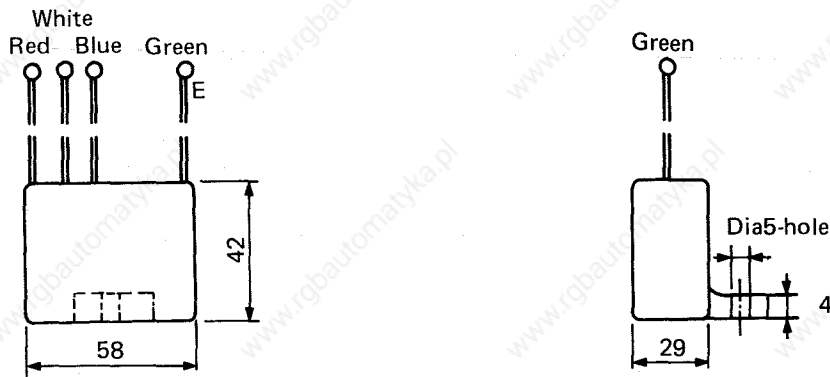

Fig. 11.5 Dimensions of Radio Interference Filter

- Note:
- (1) Connect wiring of the filter to terminals of the inverter directly and wire them as short as possible.
 - (2) Effective for the noise lower than 10MHz.
 - (3) Earth the wire "E" by the earthing resistance of less than 100ohms.

12. APPLICATION OF INVERTER

12.1 Efficiency and Heat Generation Amount of Inverter

The inverter efficiency is the conversion efficiency of inverter and is obtained by the following expression by use of the input power of inverter and the output power of inverter (input power of motor):

$$\text{Inverter efficiency (\%)} = \frac{\text{Inverter output power (kW)}}{\text{Inverter input power (kW)}} \times 100 = \frac{\text{Inverter output power}}{\text{Inverter output power} + \text{Inverter losses}} \times 100$$

As is obvious from the above expression, the inverter efficiency is determined by the loss of inverter itself. The loss generated by the inverter can be classified into losses of transistor inverter section (approx. 50%), converter section (approx. 15%), cooling fan (approx. 5%), control circuit (5 to 15%) and others (AC reactor).

Among the above losses, the loss amounts of inverter section and converter section vary according to load current and control method. However, the loss of control circuit is almost uniform irrespective of capacity.

Therefore, when the motor has a small capacity and light load, the inverter efficiency is low. However, when the motor has a large capacity, the efficiency is 95 to 97% as shown in Fig. 12.1. Although the loss of cooling fan is relatively little, power is always consumed. Therefore, when the inverter is stopped for a long time, the inverter may be separated from the power supply.

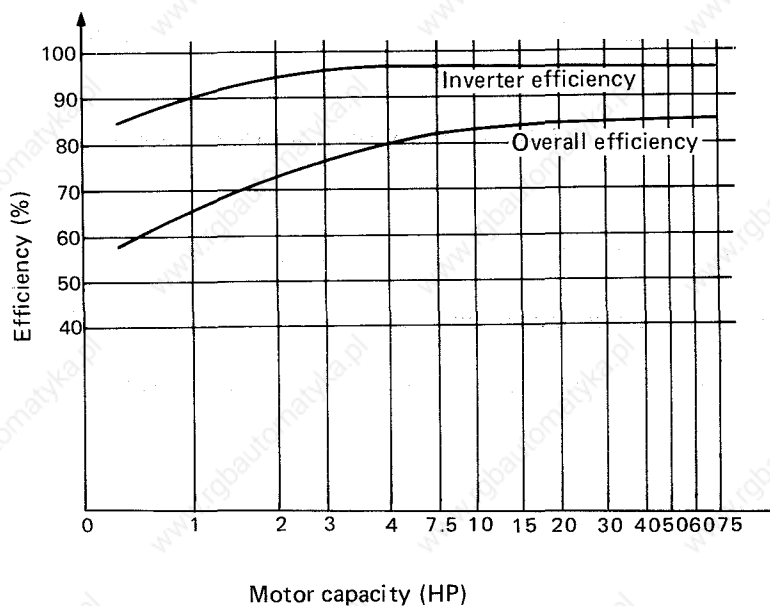

Fig. 12.1 Inverter Efficiency

- Note:
1. Inverter efficiency
Indicates efficiency of inverter single unit.
 2. Overall efficiency
Indicates a value of "inverter efficiency" x "motor efficiency".
 3. Above value is based on motor load ratio of 100%, 60Hz.

12.2 Heat Generation Amount of Inverter and Cooling of Panel

The heat generation amount of inverter due to generated loss is as shown in Table 12.1. In the design of control panel, it is required to set the panel interior temperature to less than the maximum allowable temperature of inverter unit. The rise of temperature inside the control panel can generally be obtained by the following expression:

$$\text{Temperature rise (deg)} = \frac{\text{Loss generated by inverter} + \text{Loss generated by other instrument inside panel (W)}}{K1 \times \text{panel radiation surface area (m}^2\text{)} + K2 \times \text{ventilation air volume (l/min)}}$$

$$\text{Temperature rise (deg)} < \text{panel ambient temperature (}^\circ\text{C)} - \text{inverter unit maximum allowable temperature (}^\circ\text{C)}$$

where, K1, K2 = constants determined by structure of control panel

Examples of inverter containing panels are shown in Table 12.1.

Inverter Capacity	Enclosed Dustproof Type (IP5X or NEMA12)			Control Panel with Fan (IP3X or Fan Cooled NEMA1)
	Loss (at rating)	Area required for radiation	General box dimensions (unit: inch)	Box dimensions (reference) (unit: inch)
FR-F2-750(750B)-U	102 W	1.98 m ²	15.7W x 15.7D x 39.4H	—
FR-F2-1500(1500B)-U	130 W	2.52 m ²	15.7W x 15.7D x 55.1H	—
FR-F2-3700-U	195 W	3.78 m ²	23.6W x 15.7D x 63.0H	—
FR-F2-5.5K-U	290 W	5.62 m ²	27.6W x 23.6D x 74.8H	—
FR-F2-7.5K-U	395 W	7.65 m ²	39.8W x 23.6D x 74.8H	23.6W x 15.7D x 47.2H
FR-F2-11K-U	580 W	11.2 m ²	63.0W x 23.6D x 82.7H	23.6W x 23.6D x 63.0H
FR-F2-15K-U	790 W	15.3 m ²	86.6W x 23.6D x 90.6H	23.6W x 23.6D x 63.0H
FR-F2-22K-U	1160 W	22.5 m ²	98.4W x 39.4D x 90.6H	23.6W x 23.6D x 74.8H
FR-F2-30K-U	1470 W	28.5 m ²	137.8W x 39.4D x 90.6H	27.6W x 23.6D x 82.7H
FR-F2-37K-U	1700 W	32.9 m ²	157.5W x 39.4D x 90.6H	27.6W x 23.6D x 82.7H
FR-F2-45K-U	1940 W	37.6 m ²	157.5W x 39.4D x 90.6H	27.6W x 23.6D x 82.7H
FR-F2-55K-U	2200 W	42.6 m ²	157.5W x 39.4D x 90.6H	27.6W x 23.6D x 82.7H

Table 12.1 Required Radiation Area of Inverter Panel

Note:

- 1. Values in the table vary depending on operating conditions and ambient temperature. The values have been calculated, assuming that the panel interior temperature rise is 50° F or less. (Heat generated by other than the inverter is not taken into consideration.)*
- 2. Values in the table indicate the areas which are effective for radiation. Ventilation air amount is regarded as 0 for the enclosed dustproof type.*
- 3. It is recommended to install 10HP and models with larger capacity in a clean room such as an electric chamber instead of applying an enclosed type.*
- 4. A fan having 7000ℓ/min or larger air volume should be used for the open type. The values in the table are based on the fan which has one fan. (Heat generated by other than the inverter is not taken into consideration.) Fully pass air through the inverter.*
- 5. Values similar to those in the table also apply to the 460V series.*

13. WIRING

13.1 Wiring Diagram

Fig. 13.1 shows standard wiring for FR-F2 inverter.

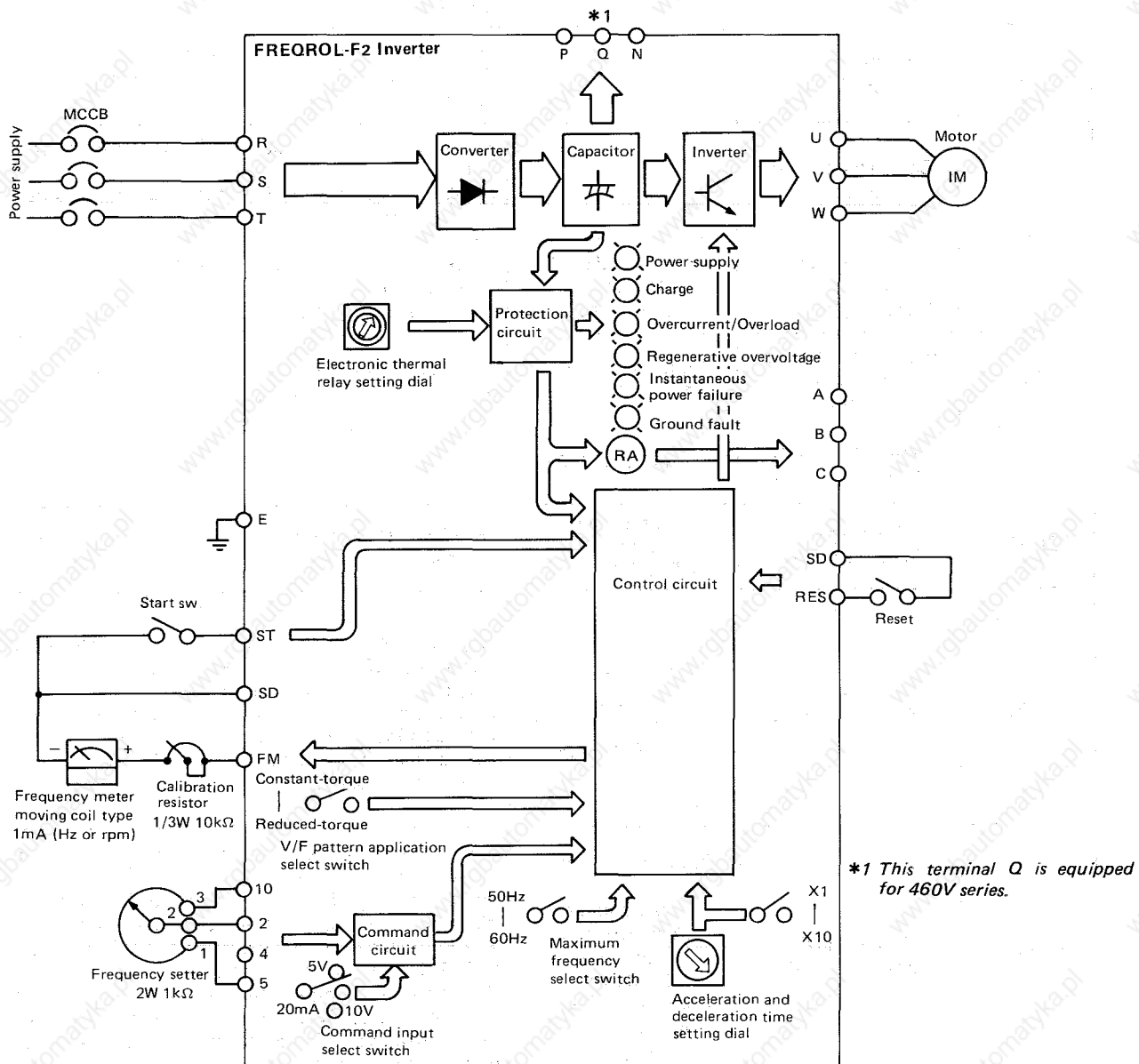

Fig. 13.1 Wiring Diagram of FR-F2

13.2 Input/Output Terminals

Terminal symbol	Terminal name	Rating	Description
R.S.T.	AC power supply input terminal	Three-phase 208V, 230V or 460V 60Hz	
E	Ground terminal		Grounding wire should be connected to this terminal and the control panel in which inverter is incorporated.
U.V.W.	Inverter output terminal		Motor is connected to these terminals. The output voltage does not exceed the input voltage.
P.N.	Converter output terminal		Terminals for connection of regenerative brake unit. Never connect any device other than brake unit to these terminals.
10-5	Power supply terminal for frequency setting	5V DC \pm 0.2V DC Max. load current: 6mA	These terminals are used to supply power source to an externally connected frequency setter (speed control) such as variable resistor.
2-5	Frequency setting signal input terminal	Input resistance: 11K Ω \pm 1K Ω	With signal at 5V (or 10V), the output frequency is maximum (50Hz or 60Hz).
4-5	Frequency setting signal input terminal	4 throu. 20mA DC	
ST-SD	Start signal input terminal	Input resistance: 2.5K Ω "OPEN" for stop	"ST-SD" is short-circuited for start, and opened for stop.
FM-SD	Output terminal for frequency meter	Max. load current: 1mA Photocoupler insulated Pulse train output	Approximately 5V DC is obtained at maximum frequency (50Hz or 60Hz) and output voltage is in proportion with the frequency. Connect moving-coil type ampere meter (1mA DC) with terminals FM and SD. Use calibration variable resistor 10K Ω 1/3W by inserting it in series.
RES-SD	Reset signal input terminal	Input resistance: 4.7K Ω Open voltage 14 to 20V DC Photocoupler insulated Controllable with open collector output	These terminals are used for resetting in case of tripping of any protective means. When reset signal is given, the control circuit is initialized and the inverter and converter are shut off. The reset signal input should last for at least 0.1sec. ("RES-SD" should be closed). The initial resetting at the time the power is turned on is automatically accomplished (about 0.2 to 0.4 sec. is necessary for automatic resetting after the power is turned on).
A-C B-C	Output terminal for alarm	Contact output: 115V AC 0.3A 30V DC 0.3A	These terminals are used to output a signal of normal-closed contact. Signal is "OPEN" if any protective means trips or the power is interrupted, and used to control an externally connected alarming device. When signal is output, the inverter is shut off and motor stops after free running.

13.3 Terminal Arrangement

13.3.1 FR-F2-750(750B)-U to 7.5K-U

- (1) When the front lower lid is removed, two plastic cover mounting screws will appear. Remove these screws and slide the cover upward to remove the plastic cover.
- (2) The control P.C. board is secured in position with screws (for models of rating smaller than FR-F2-3700-U), and support (for models FR-F2-5.5K-U and 7.5K-U).

Fig. 13.2 FR-F2-750(750B)-U to 3700-U

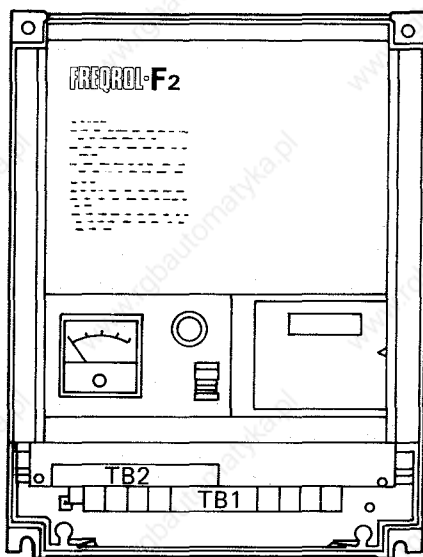

Terminal arrangement

TB2

A	B	C	10	2	5	4	ST	SD	RES	SD	FM
---	---	---	----	---	---	---	----	----	-----	----	----

(M3)

TB1

		R	R1	S	ST	T	U	V	W	N	P
--	--	---	----	---	----	---	---	---	---	---	---

Fig. 13.3 FR-F2-5.5K-U and 7.5K-U

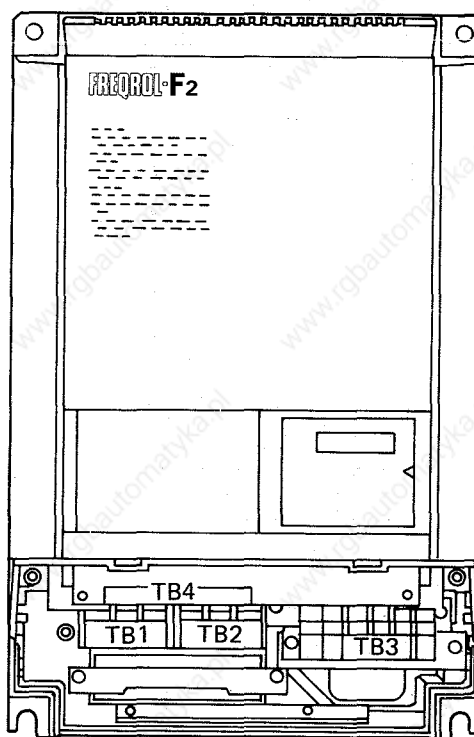

Terminal arrangement

TB4

A	B	C	10	2	5	4	ST	SD	RES	SD	FM
---	---	---	----	---	---	---	----	----	-----	----	----

(M3)



TB1

R	S	T
---	---	---

(M5)

TB2

U	V	W
---	---	---

(M5)

TB3

N	P	R1	S1
---	---	----	----

(M5)

13. WIRING

FREQROL-F₂

13

13.3.2 FR-F₂-11K-U to 55K-U

- (1) Remove four front cover mounting screws.
- (2) The control P.C. board is secured in position with board supports.

FR-F₂-11K-U, 15K-U, 30K-U, 45K-U

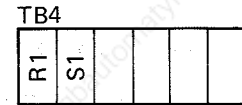
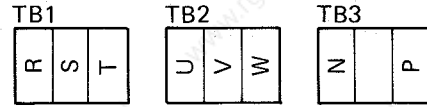
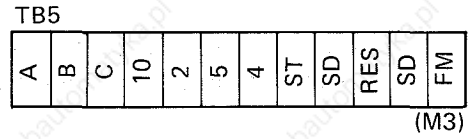
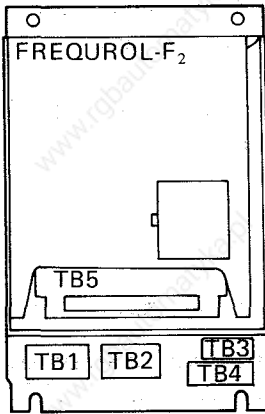

FR-F₂-22K-U, 37K-U

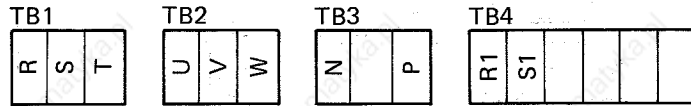
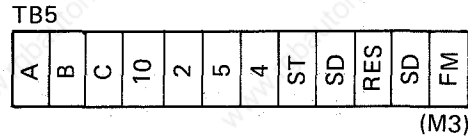
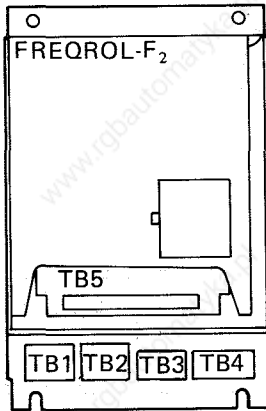

FR-F₂-55K-U

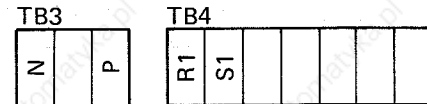
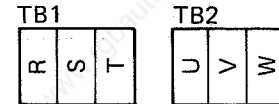
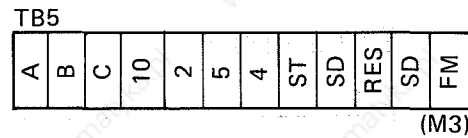
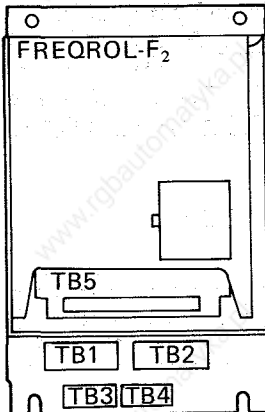

	Input Terminals (R, S, T)	Output Terminals (U, V, W)	R - N	R1, S1
FR-F ₂ -11K-U	M6	M6	M4	M3.5
FR-F ₂ -15K-U	M8	M6	M4	M3.5
FR-F ₂ -22K-U	M8	M8	M4	M3.5
FR-F ₂ -30K-U	M10	M8	M5	M3.5
FR-F ₂ -37K-U	M10	M8	M5	M3.5
FR-F ₂ -45K-U	M12	M10	M5	M3.5
FR-F ₂ -55K-U	M12	M12	M5	M3.5

13.3.3. FR-F₂-H3700-U to H7.5K-U

- (1) When the front lower led is removed, two plastic cover mounting screws will appear. Remove these screws and slide the cover upward to remove the plastic cover.
- (2) The control P.C. board is secured in position with support.

Fig. 13.5 FR-F₂-H3700-U, H5.5K-U, H7.5K-U

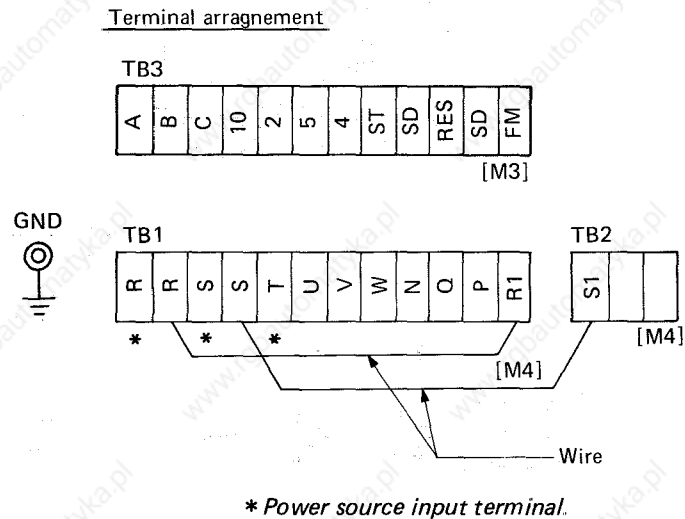
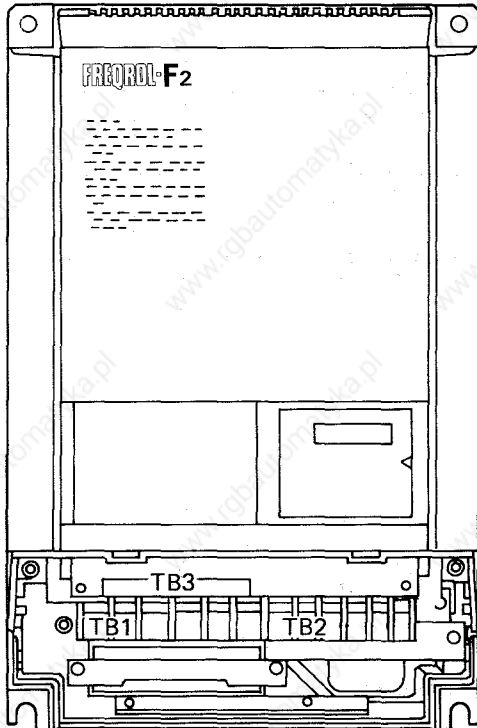

13.3.4 FR-F₂-H111K-U to H55K-U

- (1) Remove four front cover mounting screws.
- (2) The control P.C. board is secured in position with board supports.

FR-F₂ FR-F₂-H111K to H55K

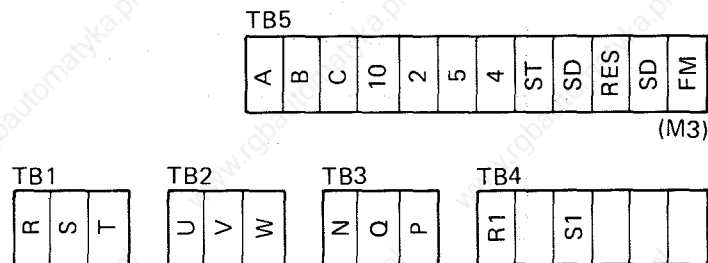
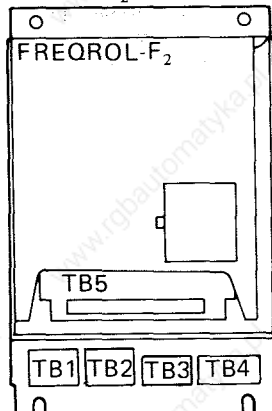

14. MAINTENANCE AND CHECKING

14.1 Measuring Methods for Voltage and Current of Various Parts

Since voltage and current of the inverter's primary and secondary may contain higher harmonic waves, the data will be different by measuring instruments and measuring circuits.

When measuring with instruments for commercial frequency use, apply meters listed in the table and circuits shown in the Fig. 14.1.

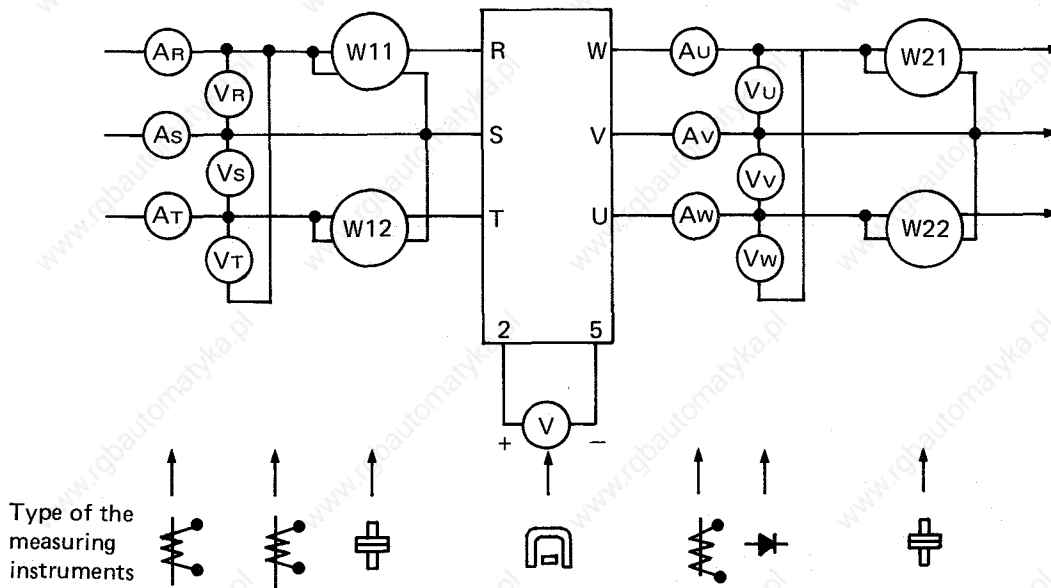

Fig. 14.1 Measuring Points and Instruments

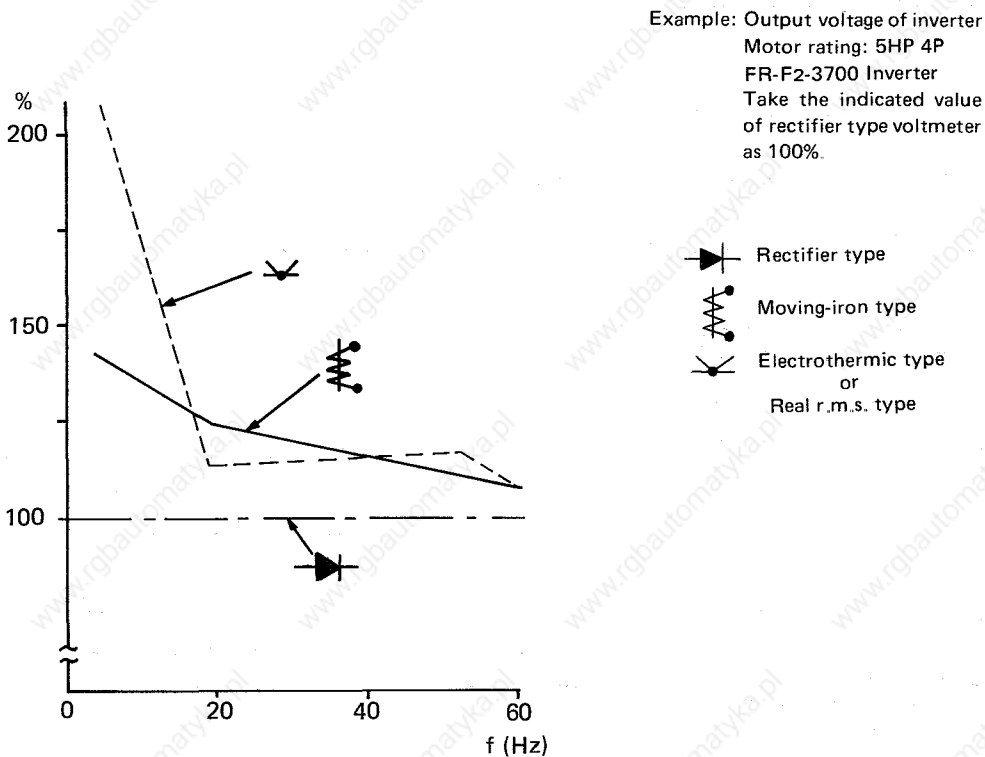

Fig. 14.2 Difference of Indicated Value with Various Measuring Instruments

Measured item	Measured point	Measuring instrument	Remarks (standard value)
Power supply voltage V_1	Across R-S, S-T, T-R	Moving iron type	Commercial voltage
Power supply current I_1	Line current	Moving iron type	
Source power P_1	R, S, T and R-S, S-T	Dynamometer type	$P_1 = W_{11} + W_{12}$
Power factor at source side Pf_1	Measure line voltage, current and power, then calculate from those values. $Pf_1 = \frac{P_1}{\sqrt{3} V_1 \cdot I_1} \times 100\%$		
Output voltage V_2	Across U-V, V-W, W-U	Rectifier type	Voltage dependent on V/F pattern, difference between each phase is 1% or less.
Output current I_2	Line current U, V, W	Moving iron type	No more than inverter rated current, difference between each phase is 1% or less.
Output power P_2	U, V, W and U-V, V-W	Dynamometer type	$P_2 = W_{21} + W_{22}$
Output power factor Pf_2	Calculate like as power factor of source side $Pf_2 = \frac{P_2}{\sqrt{3} V_2 \cdot I_2} \times 100\%$		
Converter output	Across P-N	Multimeter (*1)	Charge lamp lights at 10V DC or more $1.35 \times V_1$ In regeneration, max. 380V.
Frequency setting signal	Between 2-5	Moving coil type (Multimeter etc. will do) (Internal resistance 50kΩ or more)	0 - 100V DC or 0 - 5V DC
Freq. setting	Between 10-5	Moving coil type (Multimeter etc. will do) (Internal resistance 50kΩ or more)	5V DC
Frequency meter signal	Between FM-SD	Moving coil type (Multimeter etc. will do) (Internal resistance 50kΩ)	About 5V DC at max. freq. (with freq. meter connected)
START signal	Between ST-SD	Moving coil type (Multimeter etc. will do) (Internal resistance 50kΩ or more)	When open, 13 - 19V DC ON voltage, 1V DC or less
Reset	Between RES-SD	Moving coil type (Multimeter etc. will do) (Internal resistance 50kΩ or more)	OFF voltage, 13V DC or more

Table 14.1 Measured Points and Their Normal Results

Note: 1. Multimeter means handy type simplified meter.

2. Digital meter

(1) A handy type digital meter is usually the rectifier type meter.

(2) Other digital meters are usually the electro thermic type meter (shows real rms value).

14.2 Cause of Protective Function Working and Countermeasure

The protective functions and the countermeasure protective functions shall operate with such various causes as described below. If any protective functions should operate, find the cause according to the following examination summary to perform the countermeasure.

Trouble	Cause	Examination summary and complementary description	Countermeasure
Overcurrent Trip (OCT)	Acceleration or deceleration time is too short.	Overload indicating lamp (OL) blinks during acceleration or deceleration.	Make acceleration/deceleration time (ACCEL/DECEL) longer.
	Output side of the inverter is opened and closed by a magnetic contactor.	Check if the sequence is made to put on the inverter start signal (ST) before closing output side magnetic switch.	As it may be commercial line started, capacity of the inverter shall be selected so that line start current does not exceed the inverter rated current.
	Instant peak load is applied.	Overload indicating lamp (OL) lights instantly.	<ul style="list-style-type: none"> ○ Improve the machine side not to apply peak load. ○ Increase the inverter capacity 1 or 2 ratings.
	Heavy load is applied.	Though acceleration or deceleration time is increased, motor can't rotate because of overcurrent.	<ul style="list-style-type: none"> ○ Since static friction torque is larger than starting motor torque of 10Hz or less, increase motor and inverter capacity.
	Power factor improving capacitor and surge absorbing capacitor are installed at the output side of the inverter.	Because capacitor impedance is small to higher harmonic, overcurrent may flow.	Remove the capacitors. If previously installed, and if power factor improving is necessary, insert the power factor improving AC reactor in the input side.
	Output side of the inverter is short circuited	Overload indicating lamp (OL) lights on.	Remove the short circuiting cause.
	Mechanical (friction) brake (such as brake motor or magnetic brake) interferes with the inverter.	Check if the brake is applied without resetting the inverter.	At the same time with brake indication, the inverter shall be reset (short circuit between RES-SD). Power supply for the coil of AC magnetic brake must be taken from the primary side of the inverter.
	Starting again during motor coasting (inertia running after the power supply cut off).	Since the inverter operates from 3Hz, motor becomes regenerative running and cause overcurrent. Free run occurs when following: <ul style="list-style-type: none"> ○ Inverter power supply OFF. ○ Inverter output OFF. (As changing over of multi speed motors or pole change motor.) <ul style="list-style-type: none"> ○ Reset signal and thermal relay trip. 	It shall be started after completely stopped. When automatic operation, it should be started after completely stopped by using timers or something similar.

Trouble	Cause	Examination summary and complementary description	Countermeasure
Overcurrent Trip (OCT)	When temperature detecting relay for heat dissipating fin is activated.	When the temperature of heat dissipating fin lowers after the inverter has stopped, temperature detective relay may automatically reset, it will be line started to cause over-current trip.	Because of the trouble of the cooling fan, or of interference with ventilation of heat dissipating fin, temperature may rise. So it should be relieved from these causes.
	External noise.	If overcurrent trip operates besides the above mentioned cause, noise may be expected. In detail, examine with synchroscope.	Frequency setting signal circuit shall be wired with the twisted or the shielded. The shield shall be connected only at one point to terminal "5", and never to ground earth or other earth circuit (of instrument and the likes). The shield shall be connected to terminal "5" and never to earth or similar circuits. The circuits mentioned above should be wired isolated from power circuit or others as possible.
Regenerative Overvoltage (OVT) Trip	Deceleration time is too short.	If energy made by regenerative brake increases the capacitive voltage over the limit value, it will operate.	<ul style="list-style-type: none"> ○ The deceleration should be set longer. ○ Brake unit should be provided.
	Regenerative operation is grown during constant speed running. (Negative torque is generated.)	<ul style="list-style-type: none"> ○ In case of work shaft of cylindrical cylinder, internal cylinder, or of regulating wheel of centerless grinder, it should be checked that those may be rotated be grinding wheels. ○ Is these any down load to perpendicular of inclined carrier? 	<ul style="list-style-type: none"> ○ Brake unit should be provided.
Instantaneous Power Failure (IPF) Trip	Instantaneous power failure occurred.	When instantaneous power failure of 15 to 55m sec. has occurred, it will light and the inverter will stop.	<ul style="list-style-type: none"> ○ It indicates that the cause of the inverter stop is instantaneous power failure. ○ Reset the inverter, and then start again. ○ Improve the power supply equipment.
Ground Fault Trip (GF)	Output side of the inverter is grounded.	Ground Fault indicating lamp (GF) lights on.	It should recover from short circuit. To avoid any more trouble, insulating transformers must be installed at the input side.

14.3 Troubleshooting

If trouble occurs with the system and it has lost any functions, perform the following checks to identify the cause and remedy, referring to the troubleshooting chart. If the cause cannot be identified, or trouble is attributable to the inverter itself, or any part is found damaged, consult the nearest authorized service center or factory service department.

Troubleshooting chart

(1) Motor does not run.

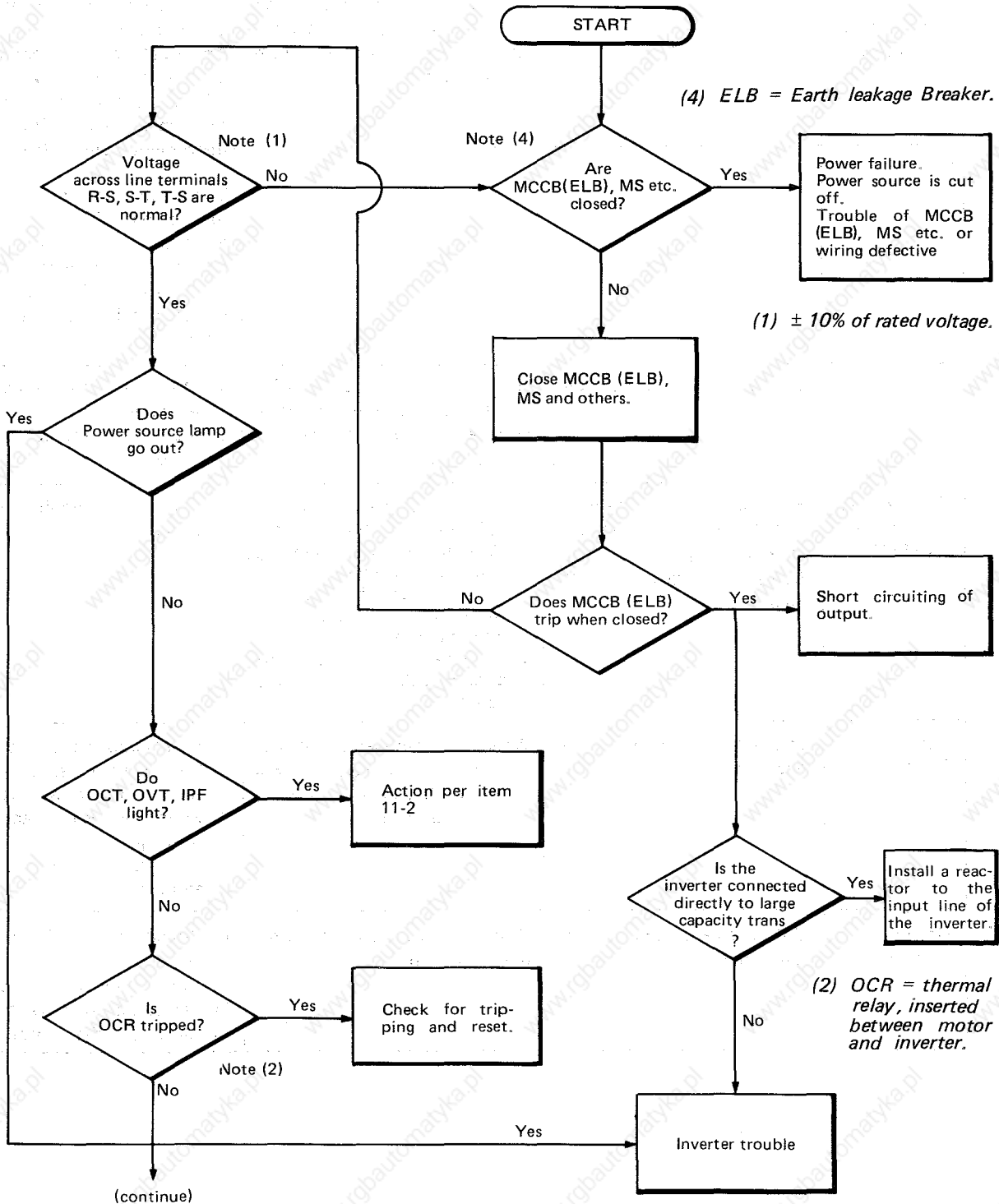

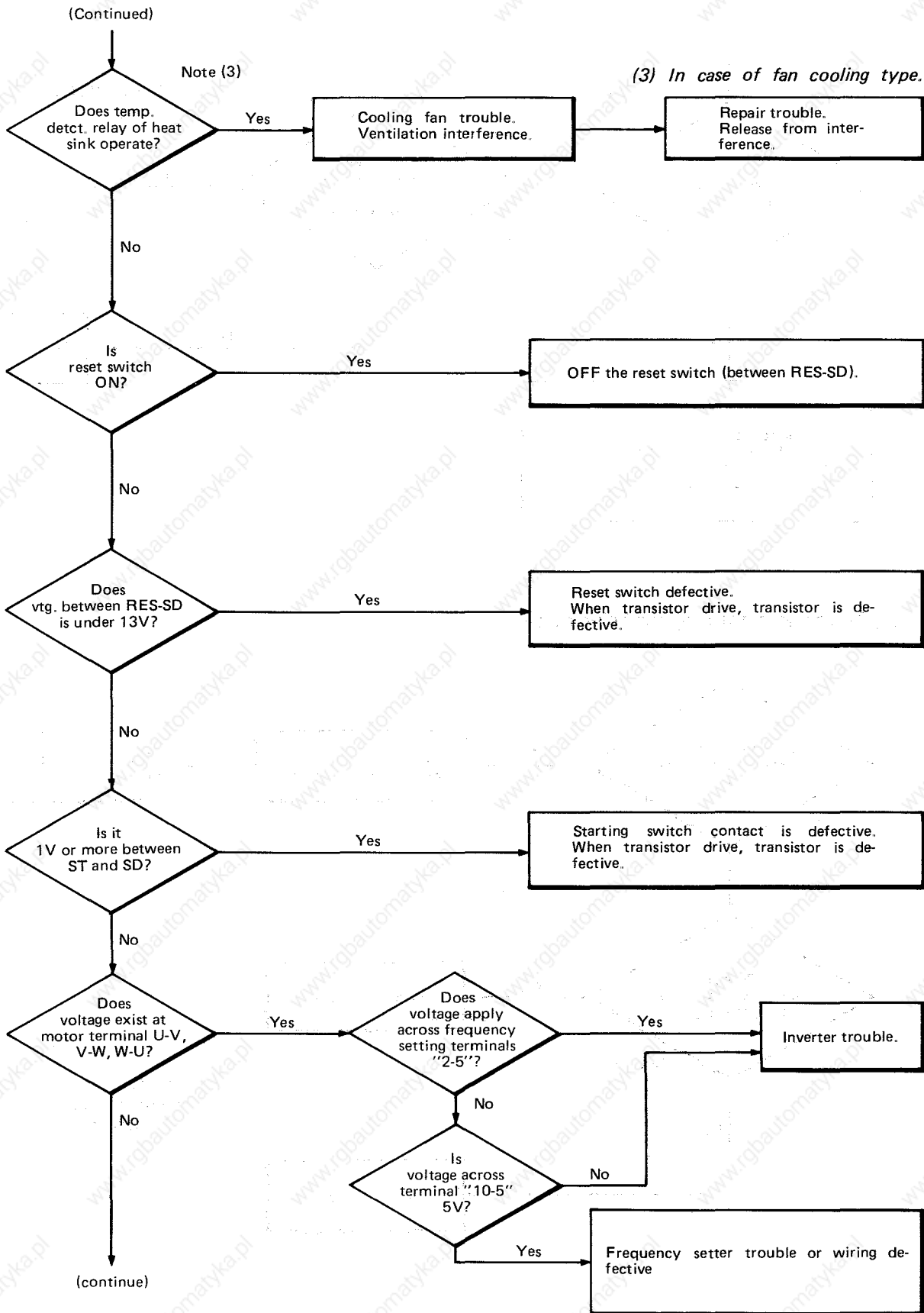

14

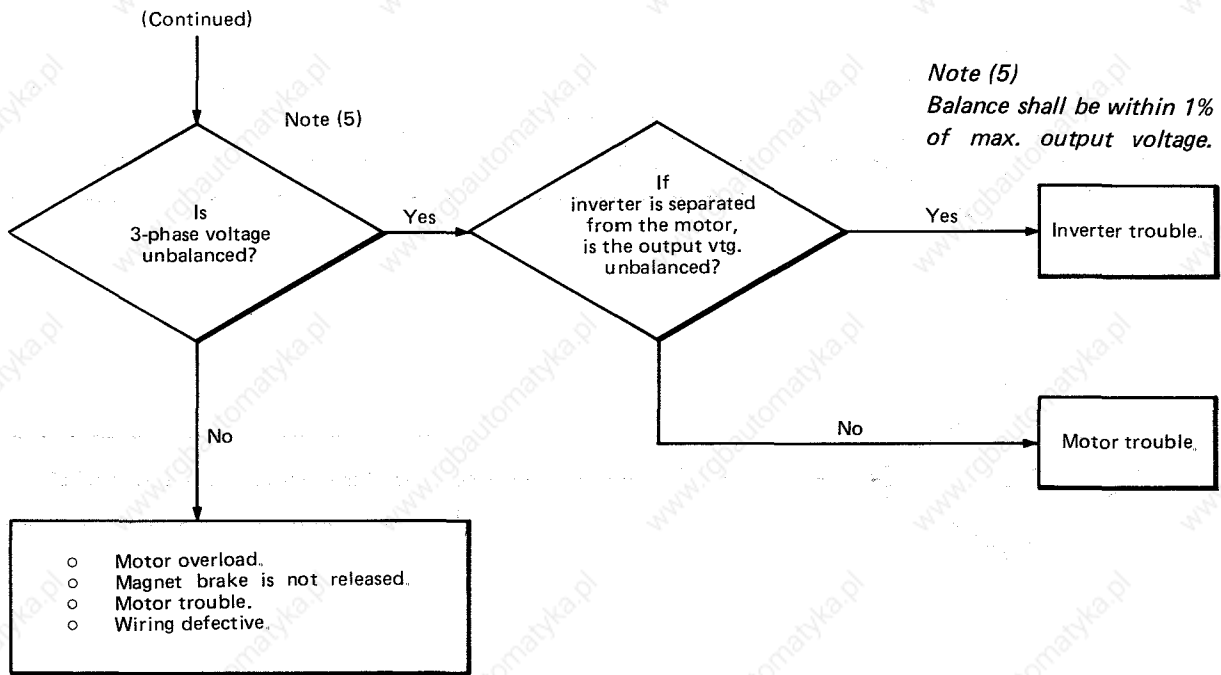

(2) Motor does not run, but being noisy.

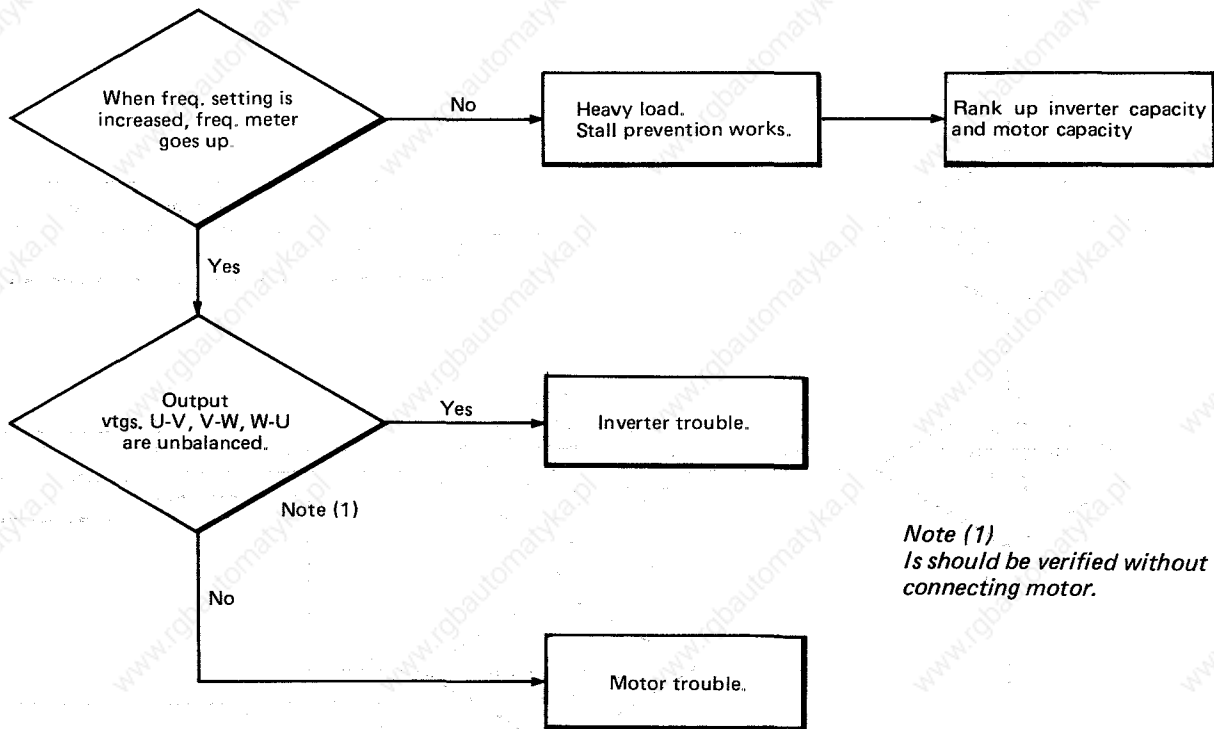

(3) Motor runs at constant speed, but can not vary the speed.

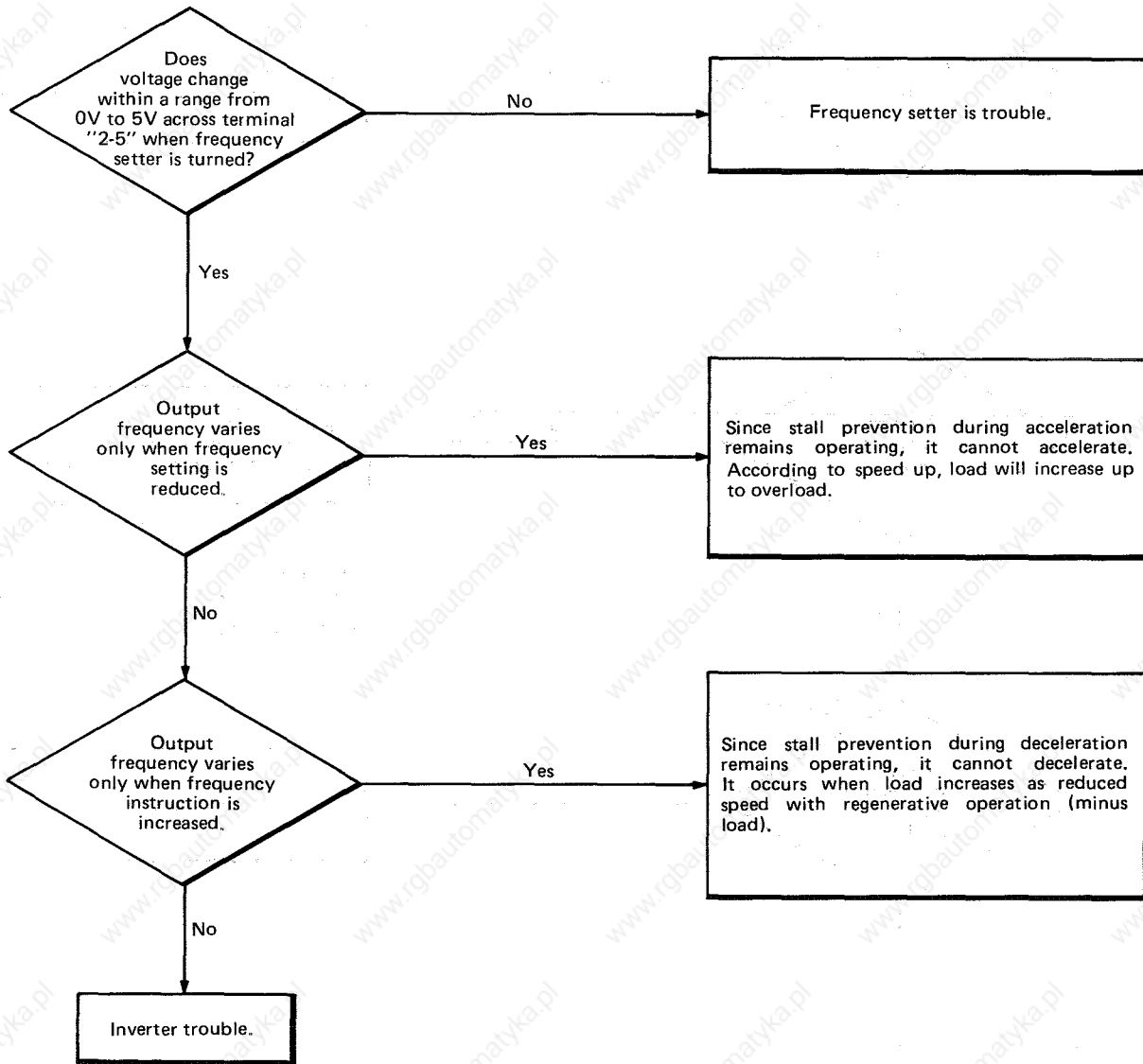

(4) Motor overheats abnormally.

14

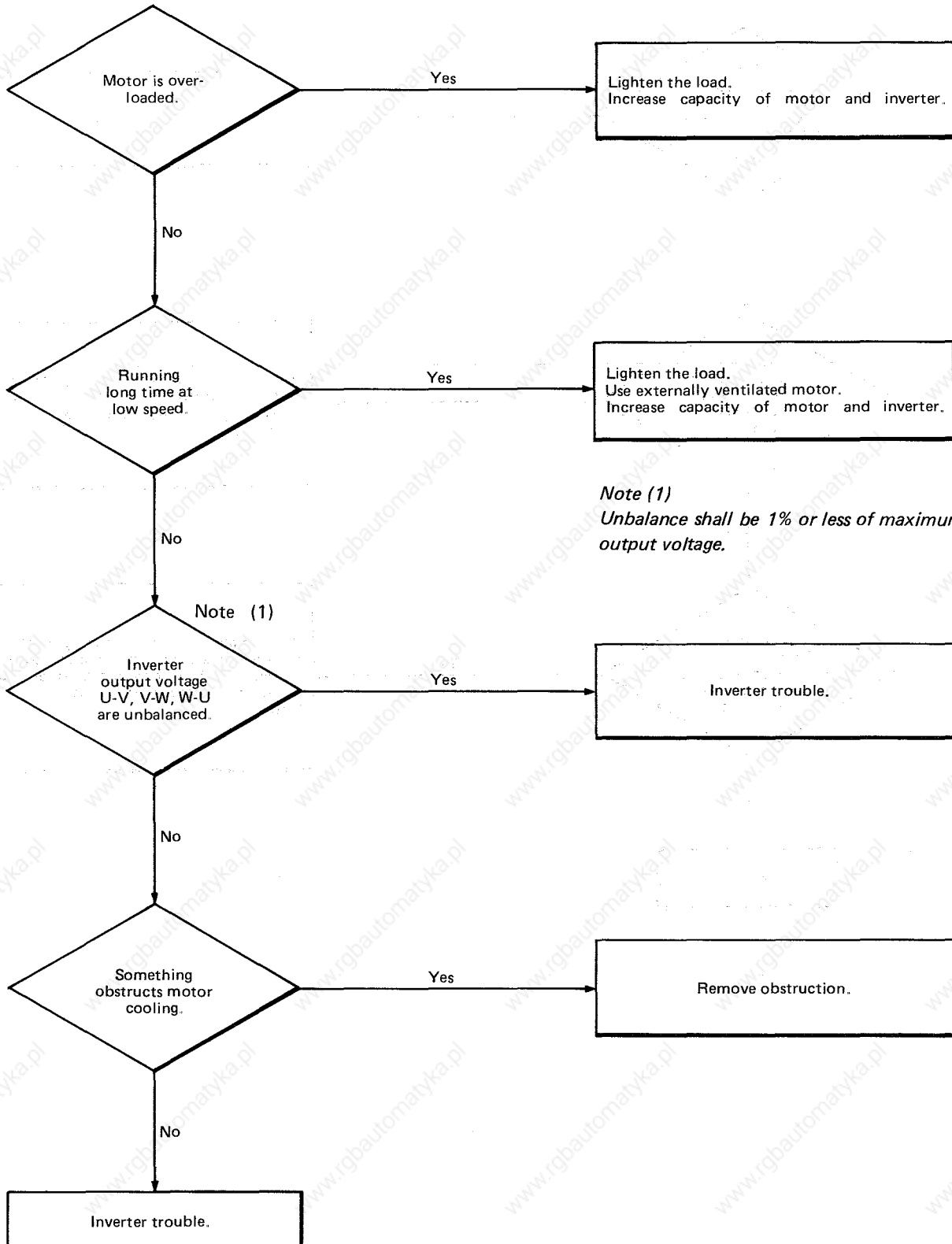

(5) Motor revolution is not smooth.

14

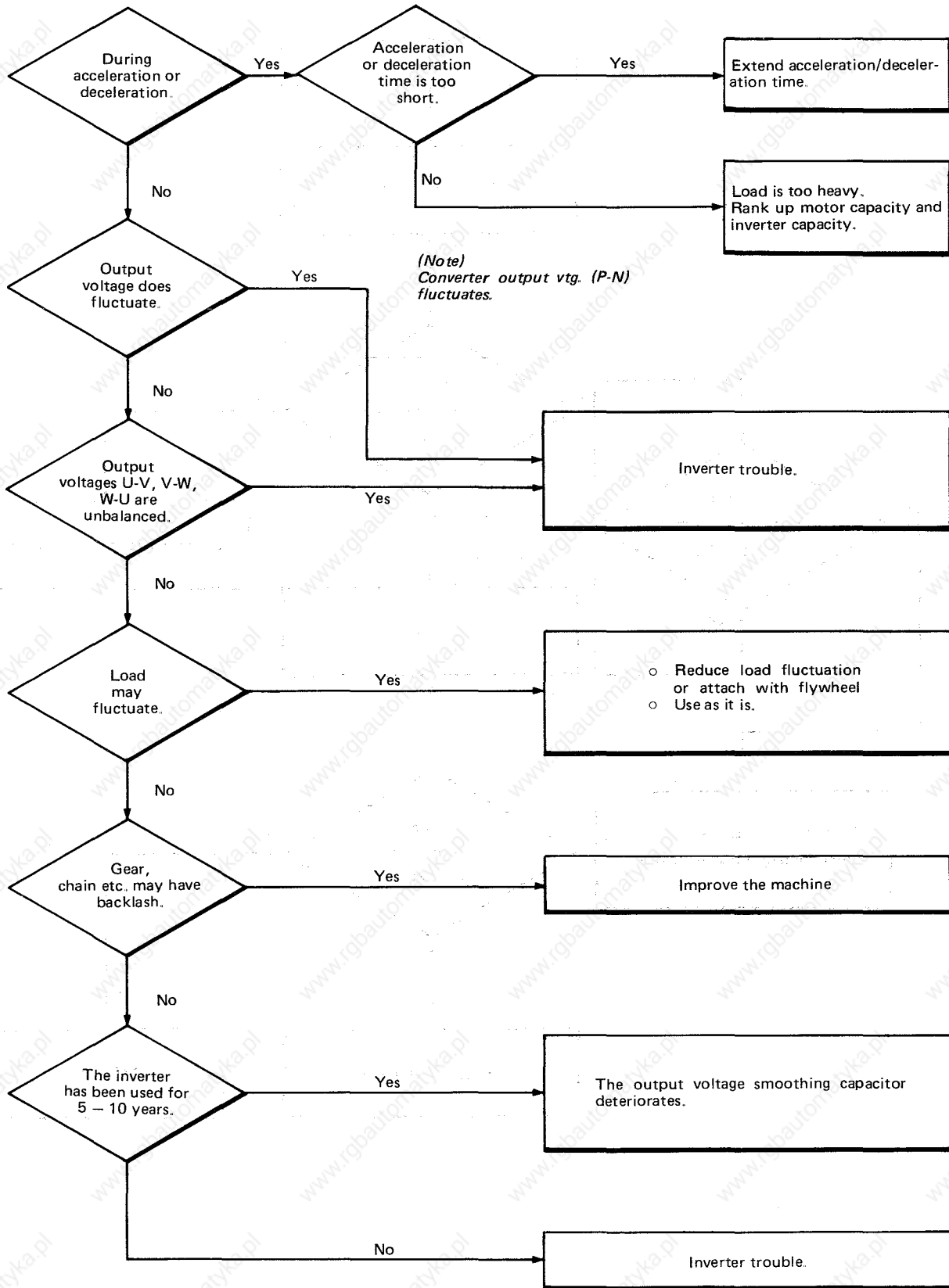

(6) IPF lamp lights

14

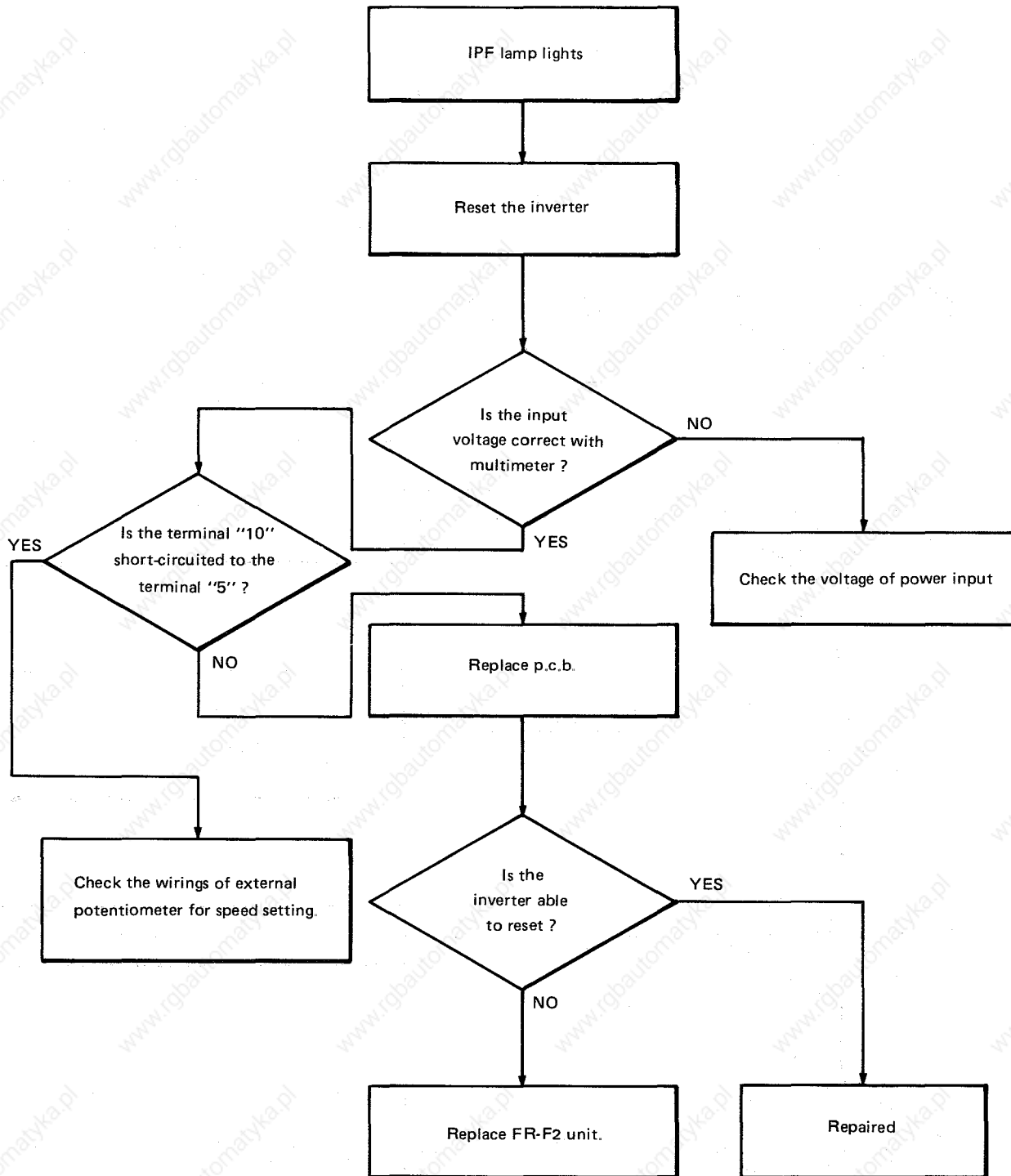

(7) Only OCT/OL lamp lights and inverter does not run.

14

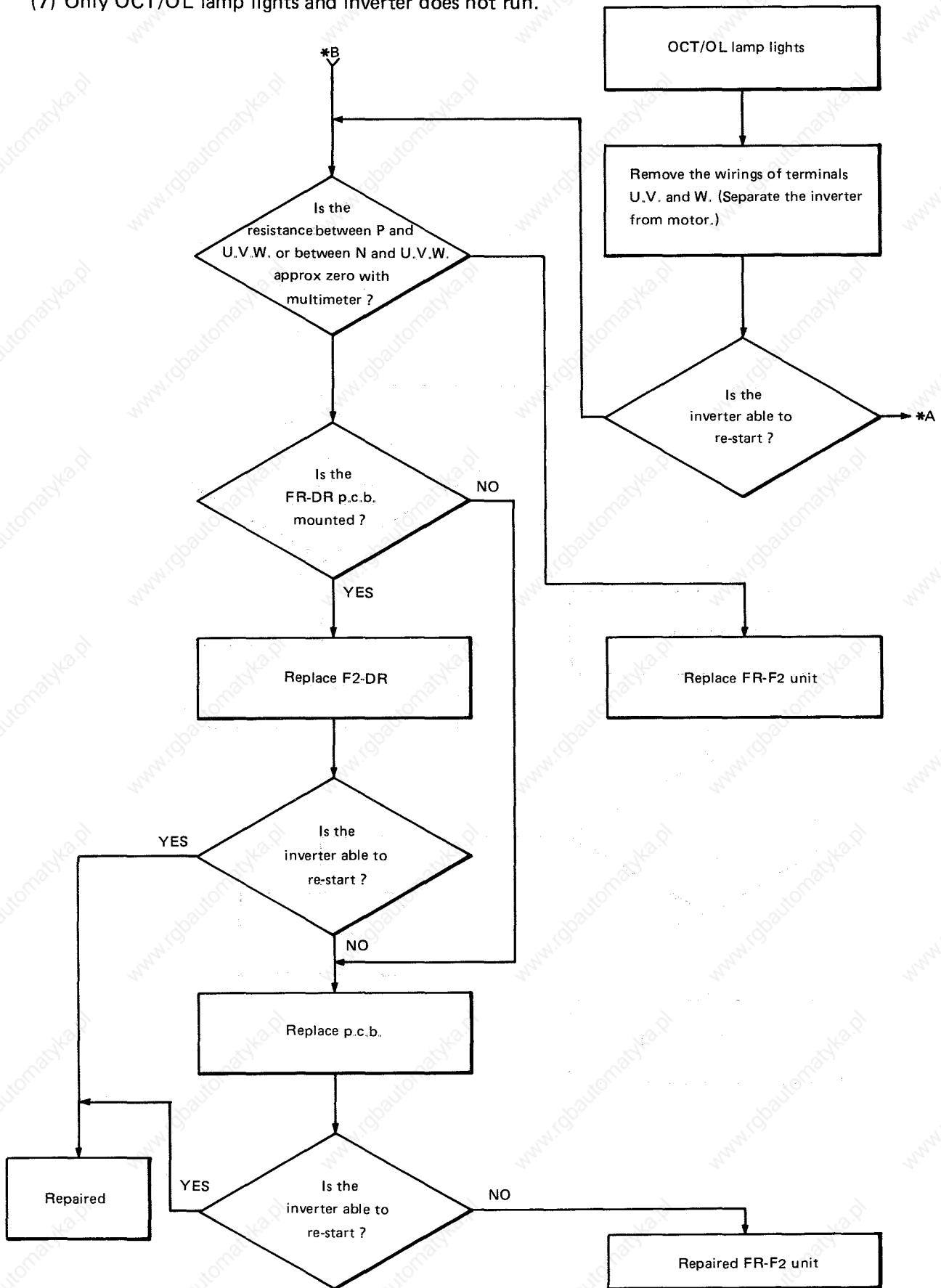

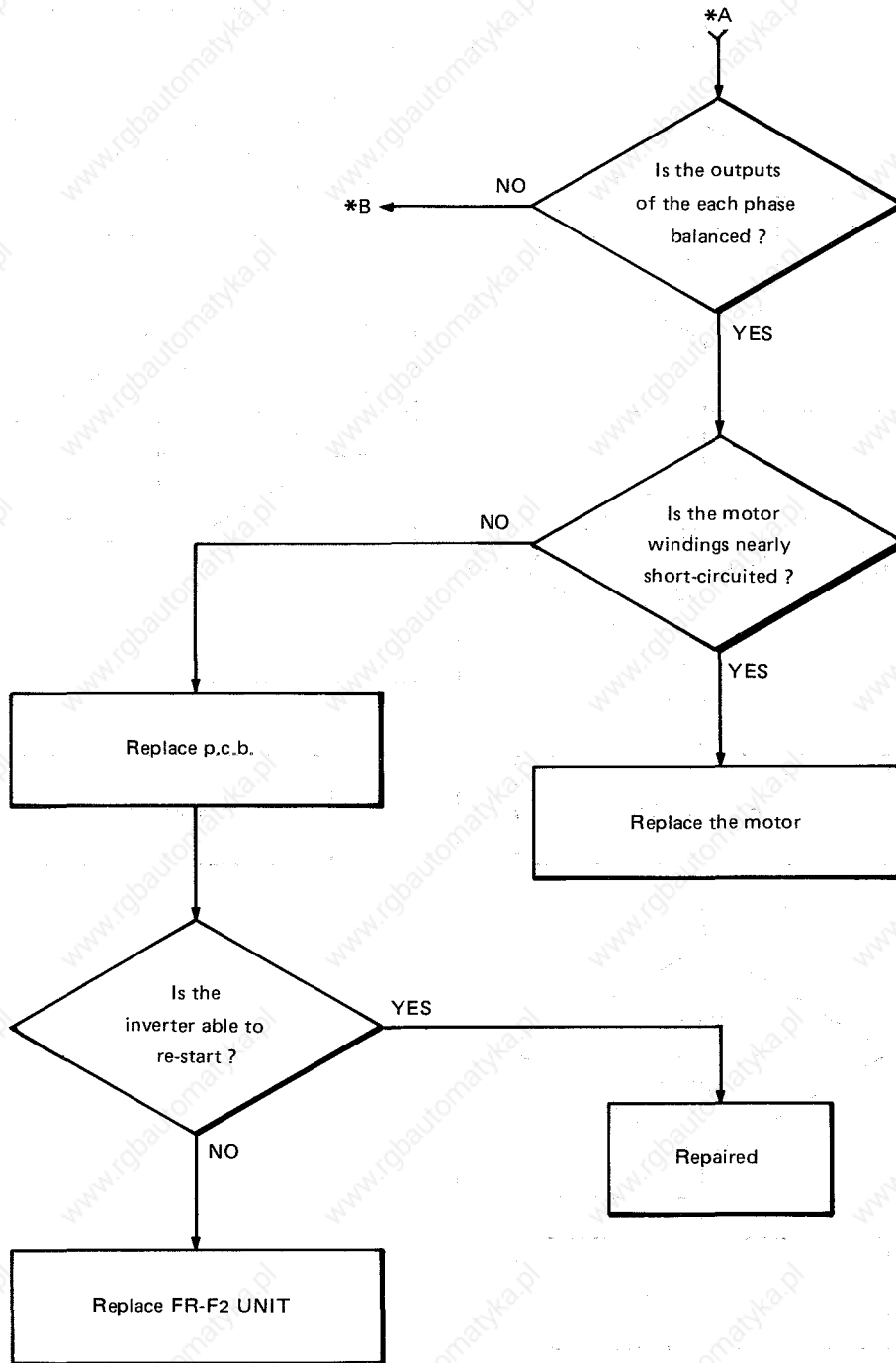

(8) GF lamp lights and inverter does not run.

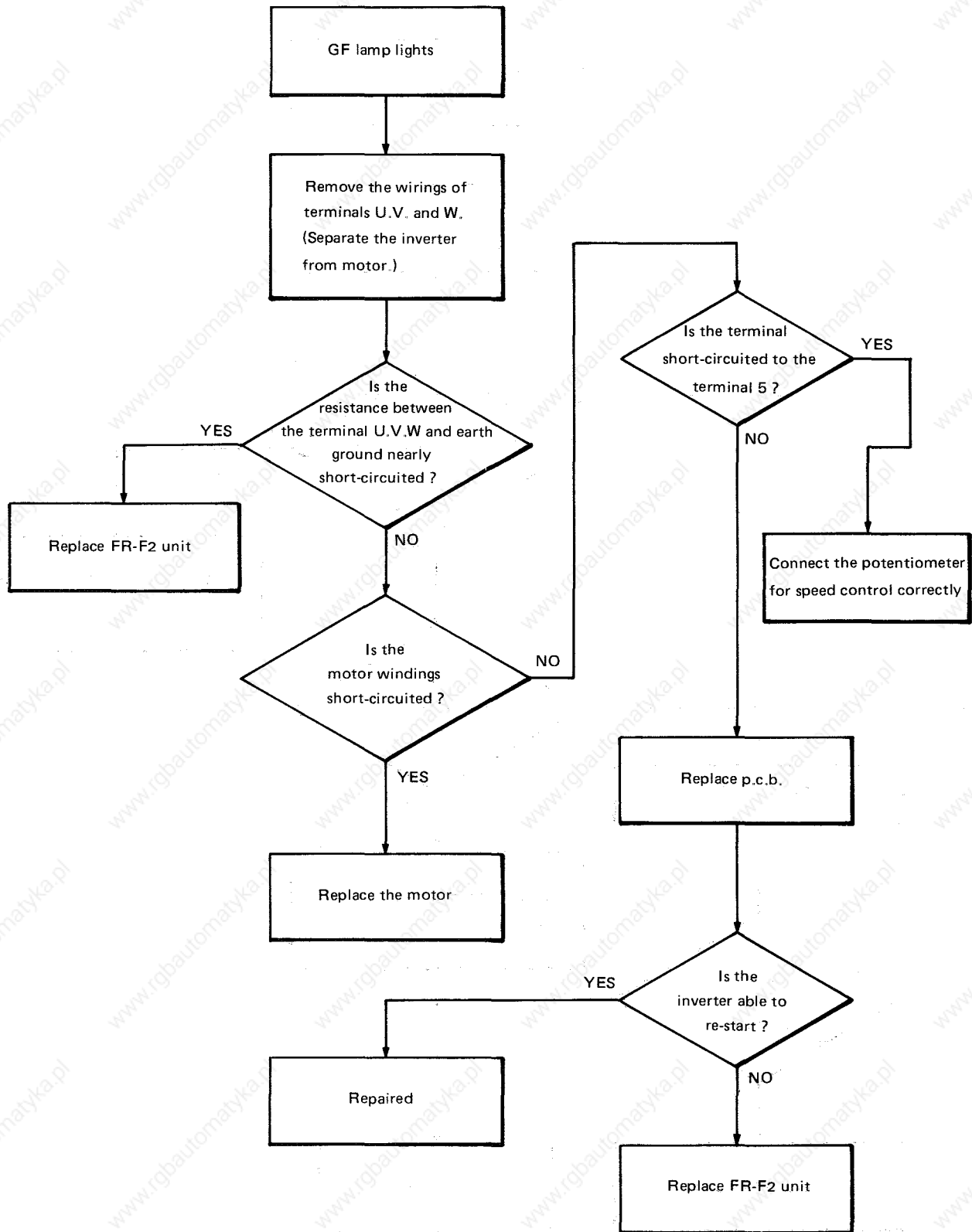

(9) OCT/OL lamp and OVT lamp light and inverter does not run.

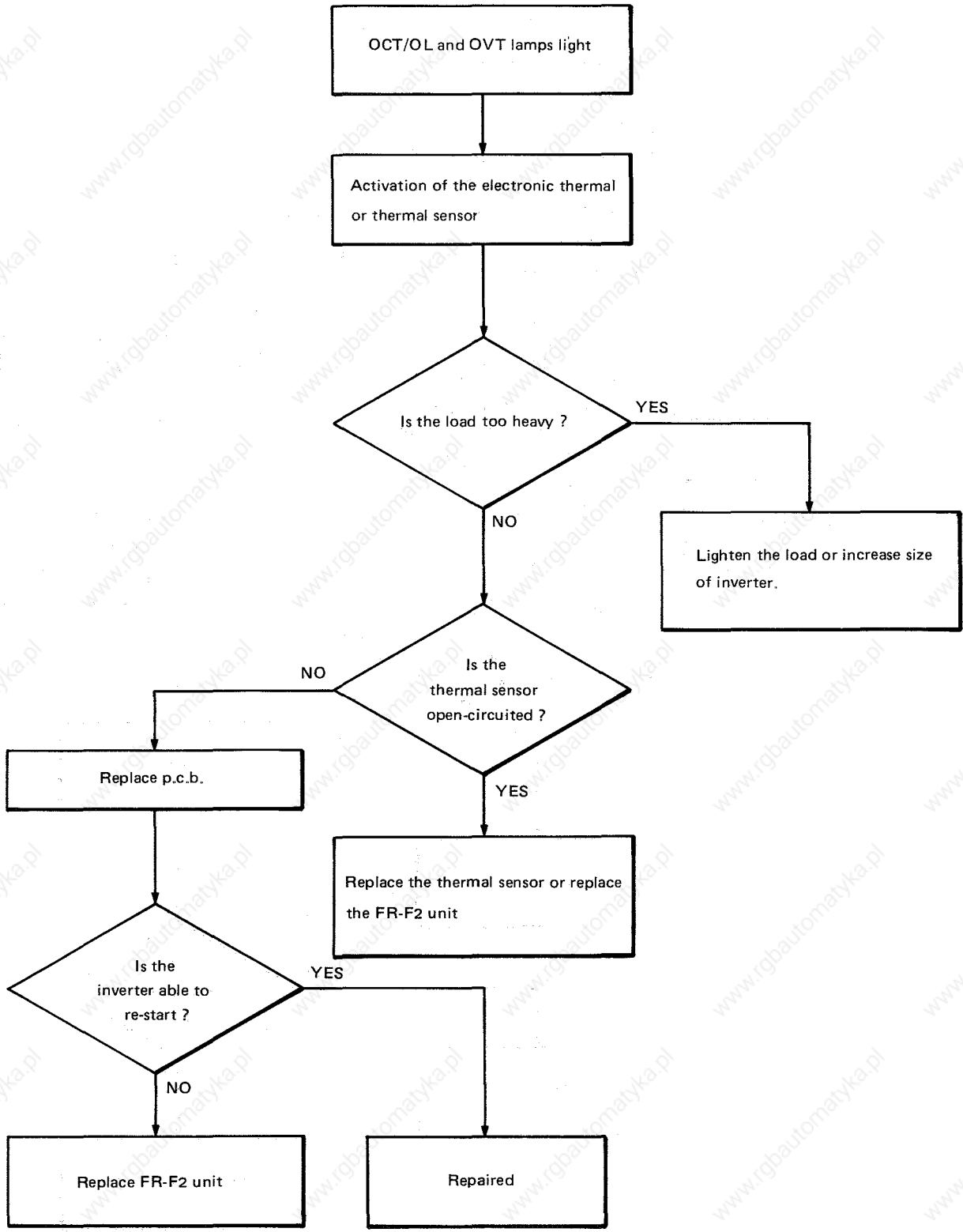

14

(10) Only OVT lamp lights.

14

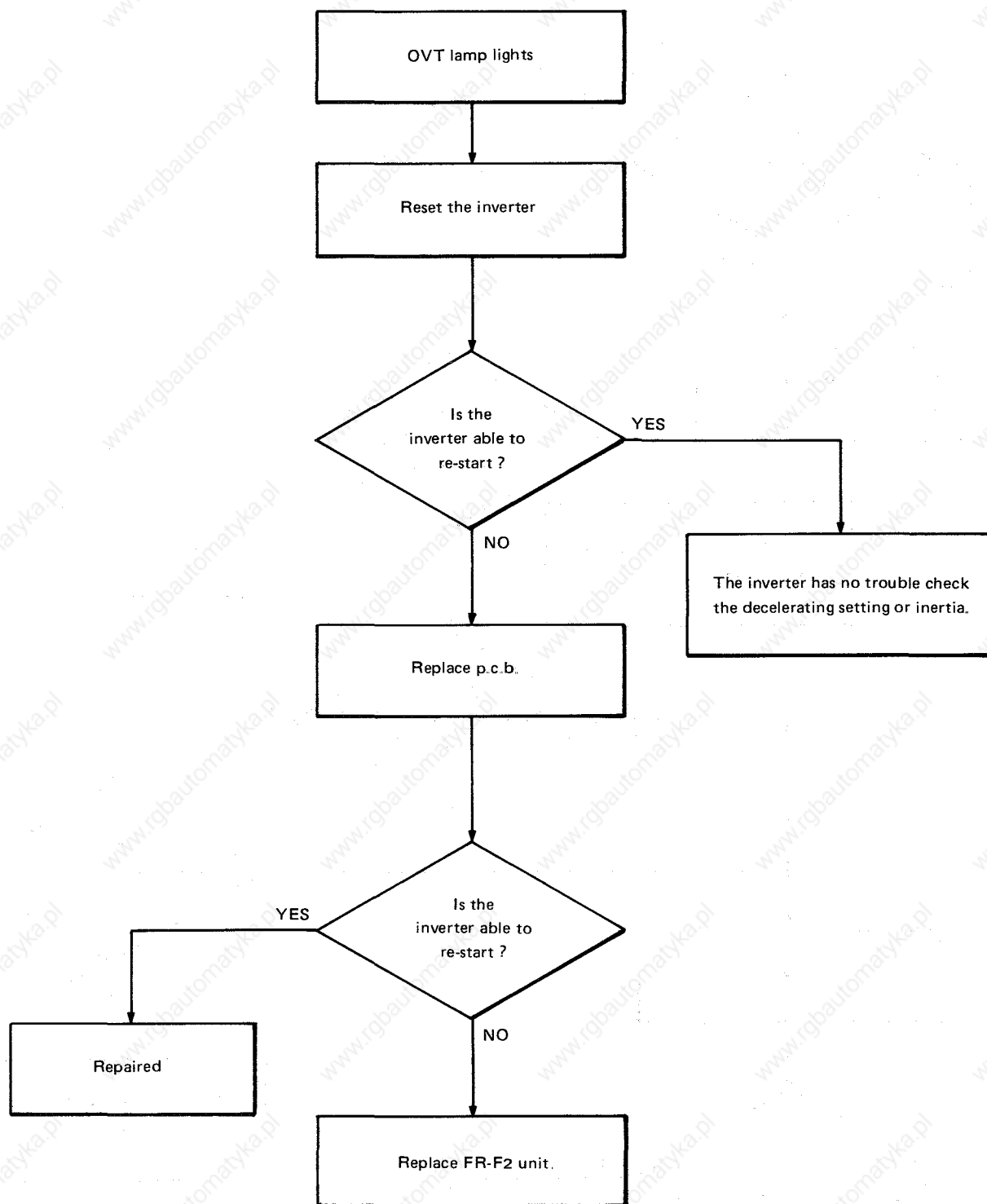

(11) Any alarm lamp does light but inverter does not run.

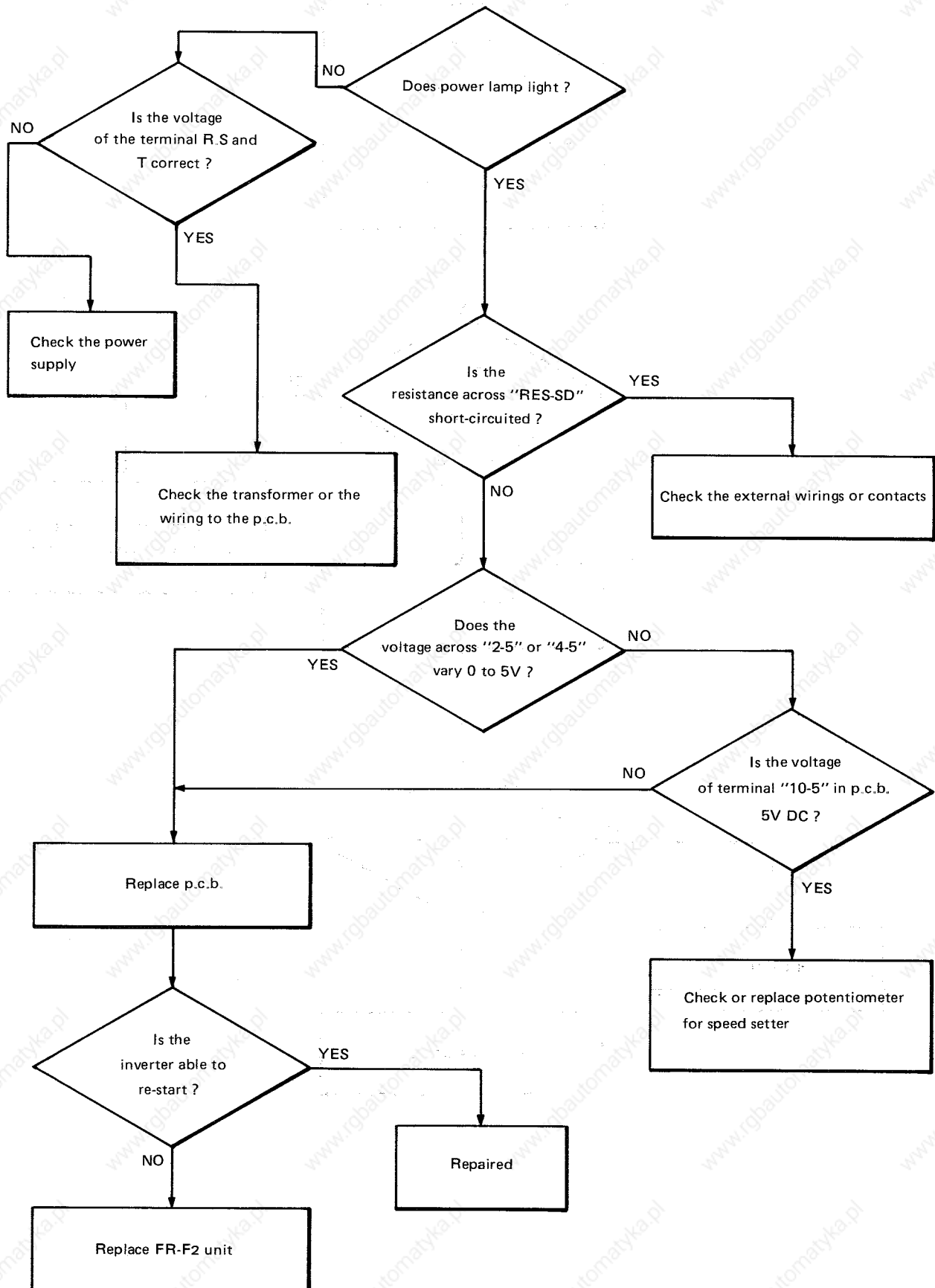

14

14.4 Investigation of parts on p.c.b.

(1) Alarm lamp Light at power supply on.

14

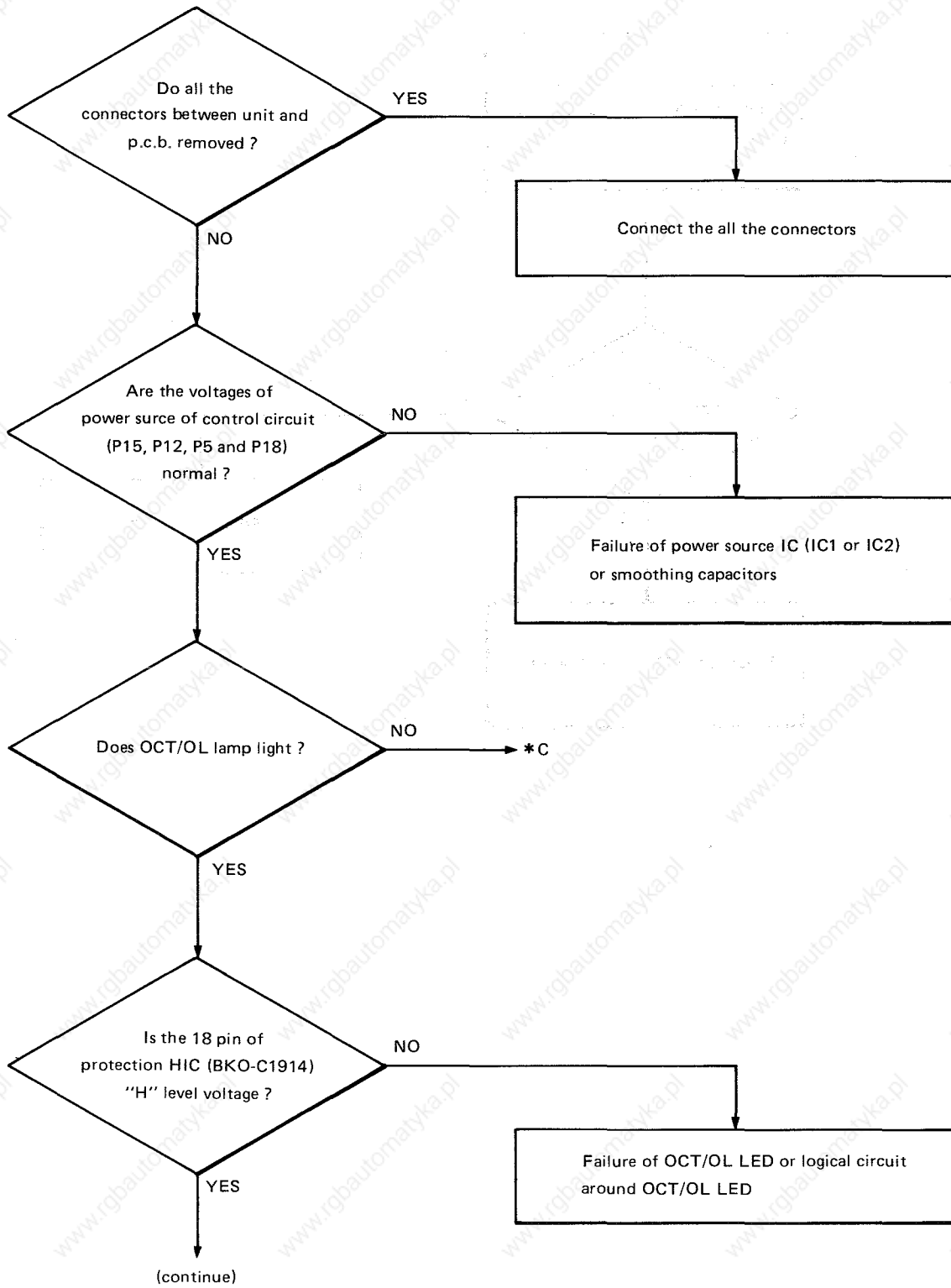

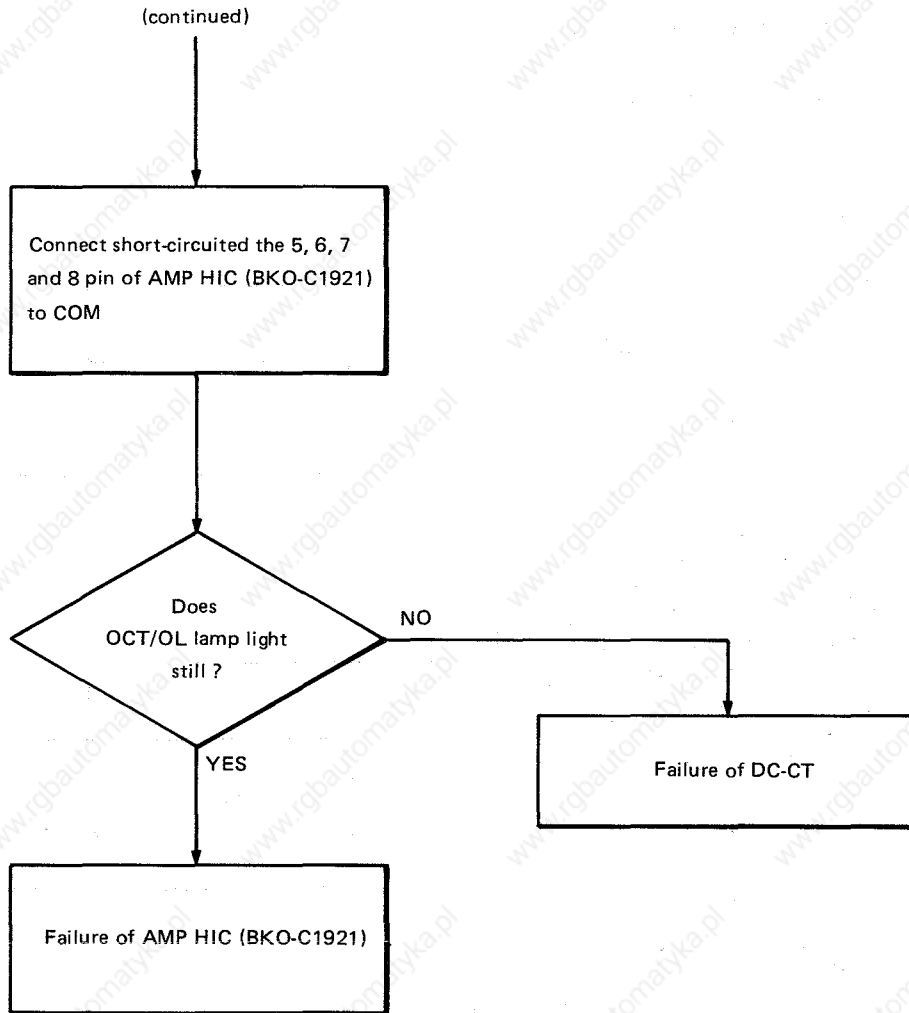

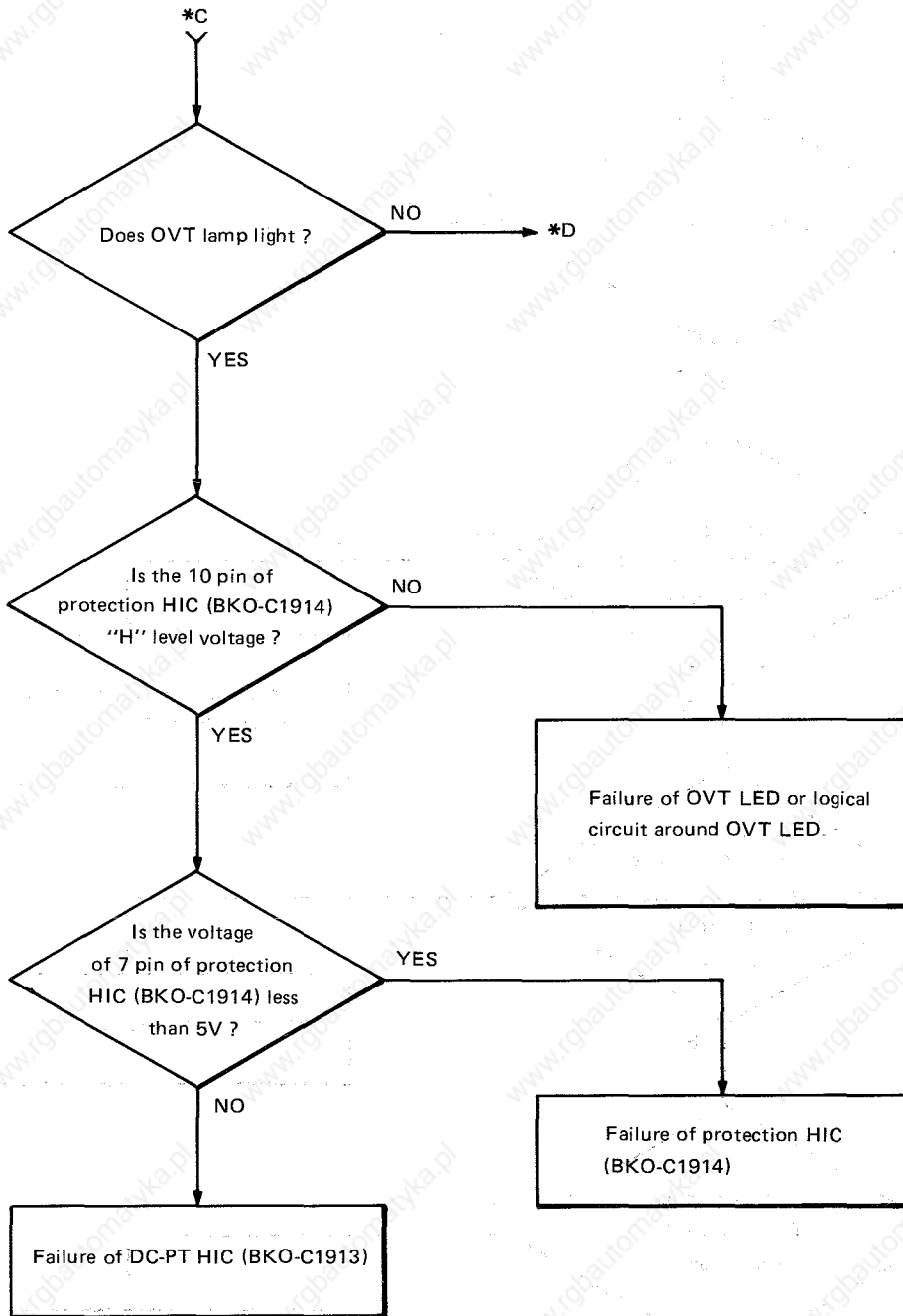

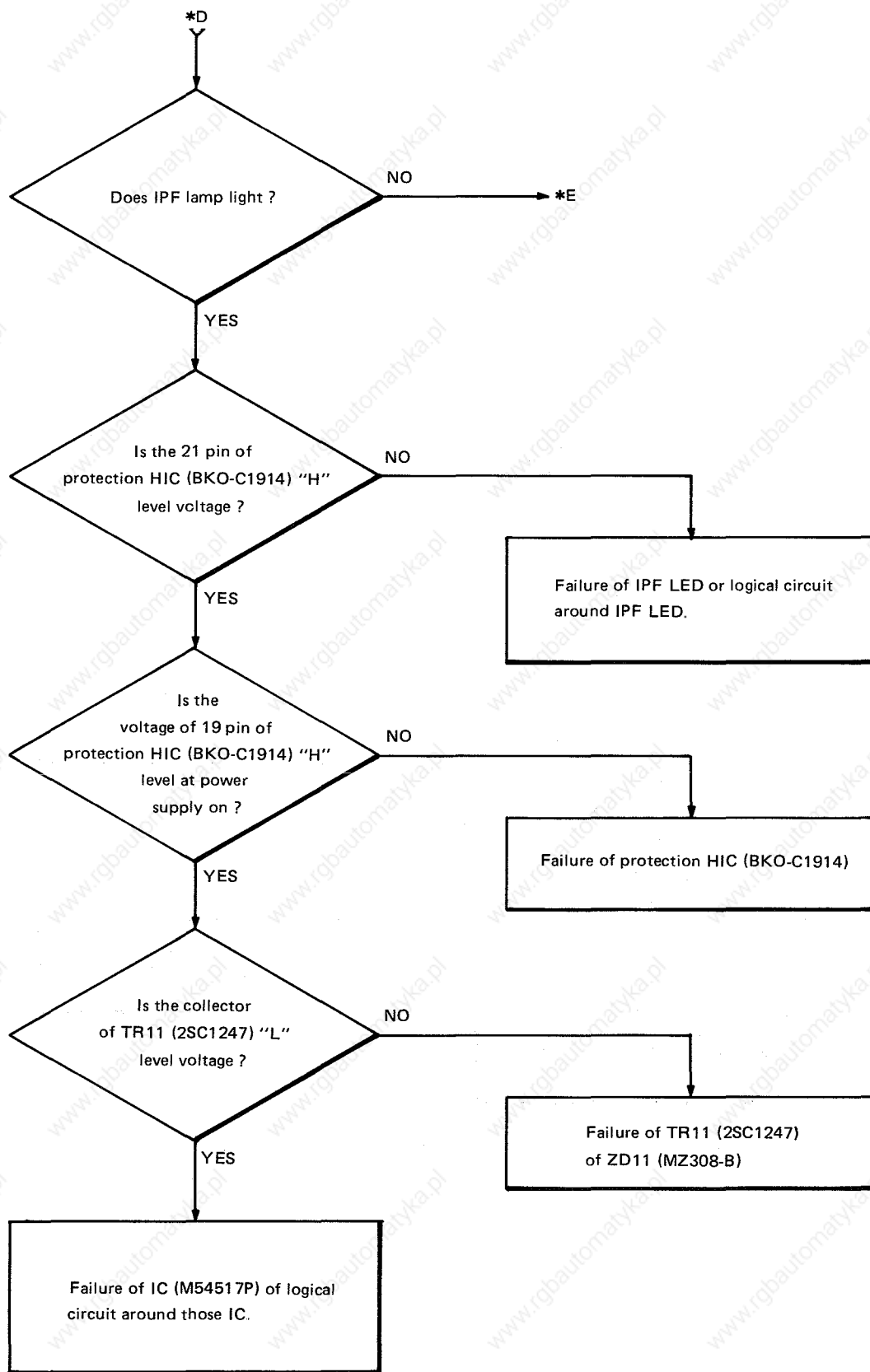

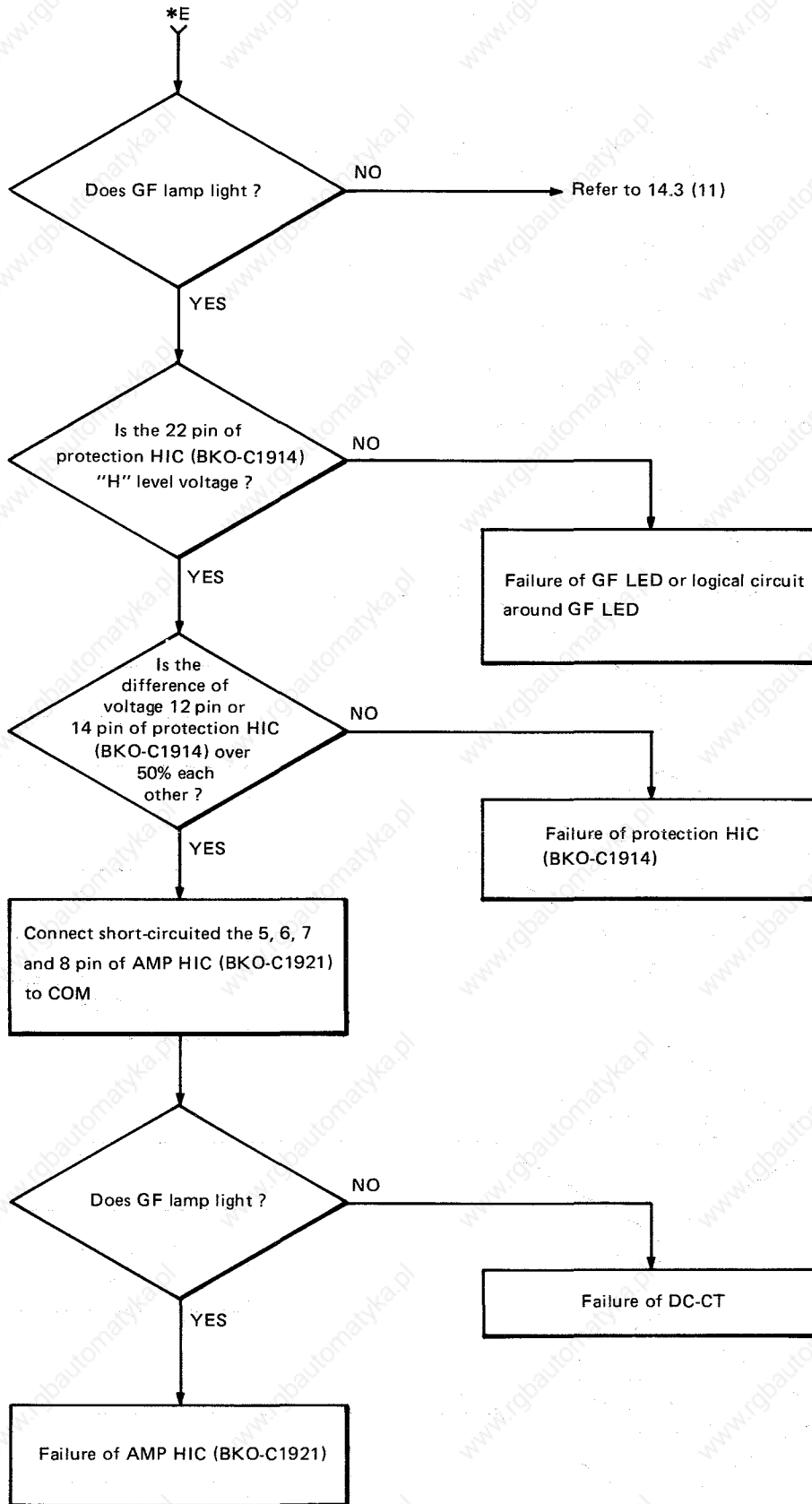

(2) Alarm lamp does not light at power supply on.

14

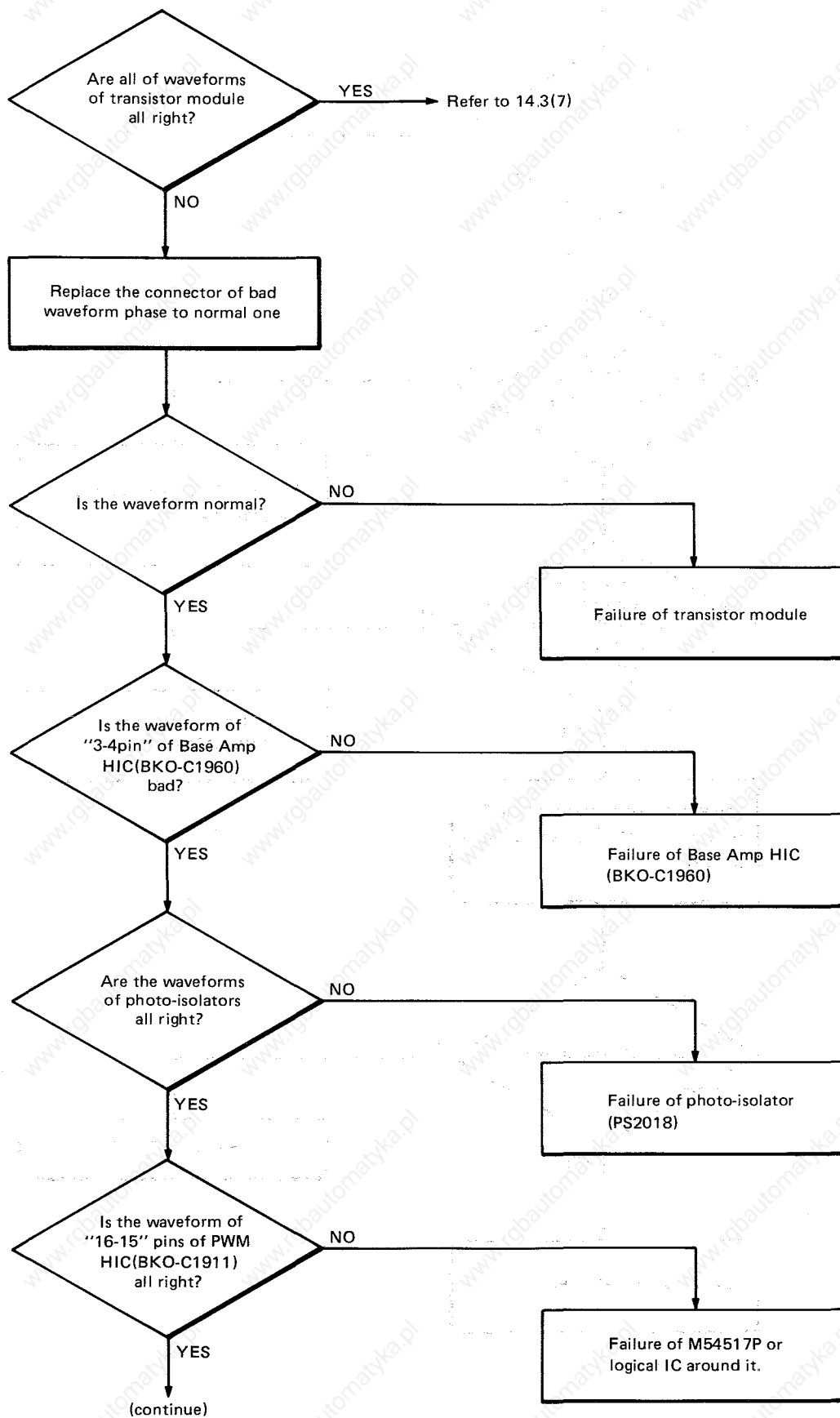

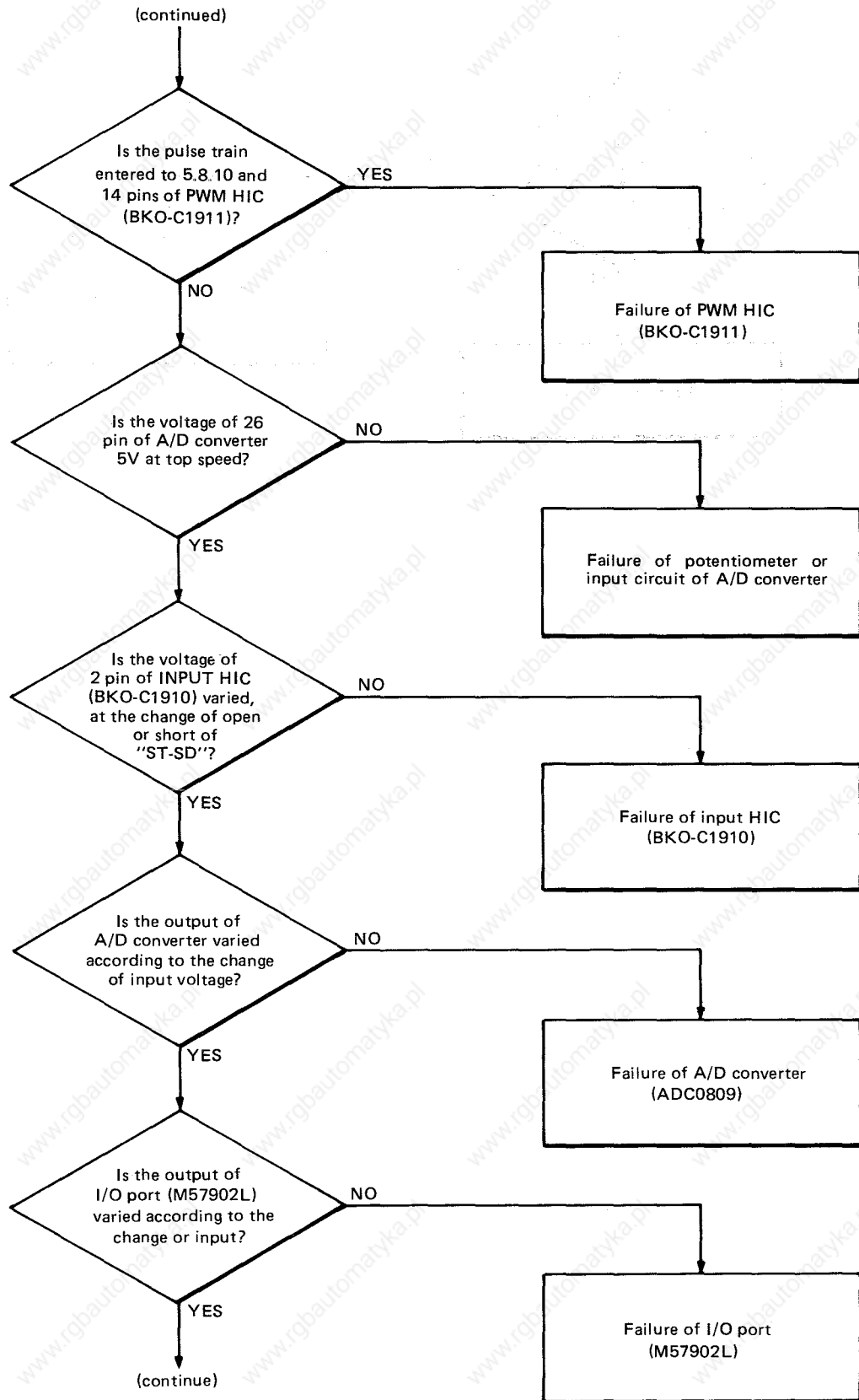

14

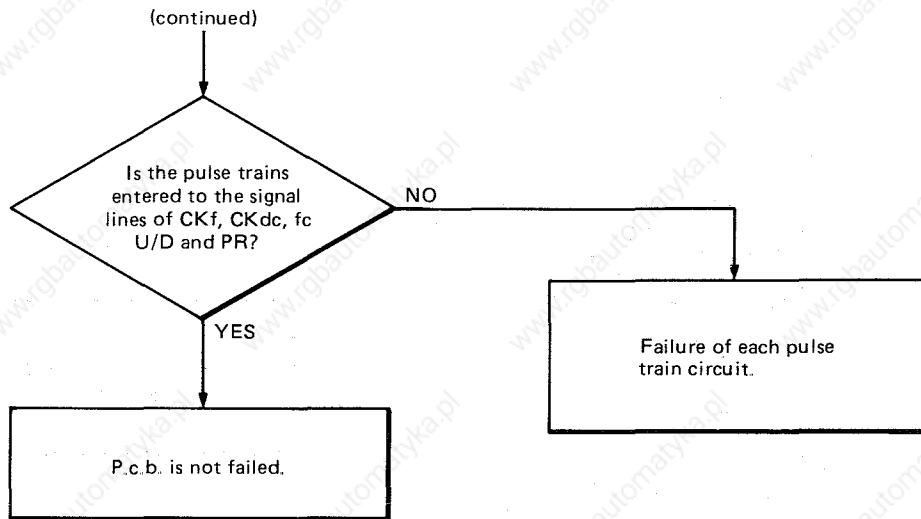

14.5 Periodic Checking

The FREQROL-F2 is of static type, requiring almost no daily maintenance. However, the following checking and maintenance should be practiced in order to assure trouble-free operation.

- (1) Since the capacitor in the inverter remains charged at high voltage for a while after the inverter is turned off, start the checking after making sure "CHARGE" lamp in the setting panel goes out.
- (2) Check the inverter interior for dust from time to time and clean if necessary.
- (3) Check the wiring parts condition. Replace defective wiring part if found, or address to us.
- (4) To check insulation using a megger, disconnect the FREQROL-F2 control circuits from the circuit subjected to the insulation test so that the test voltage is not applied to the control circuit.

To check the FREQROL-F2 control circuits, use a multi-meter.

14.6 Checking the P.C.B. and the Normal Waveforms

14.6.1 Front view of P.C.B. and checking points

(1) FRF2-MA12,22

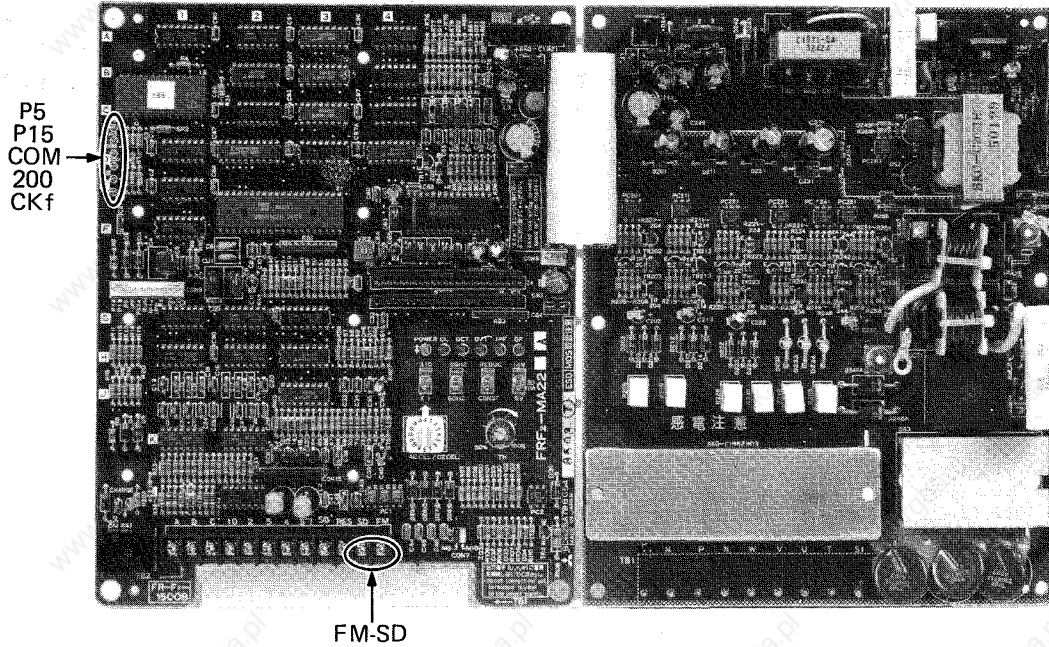

B854166-1

Fig. 14.6.1 Front View of FRF2-MA12 and 22.

(2) FRF2-CA12 & -CB12

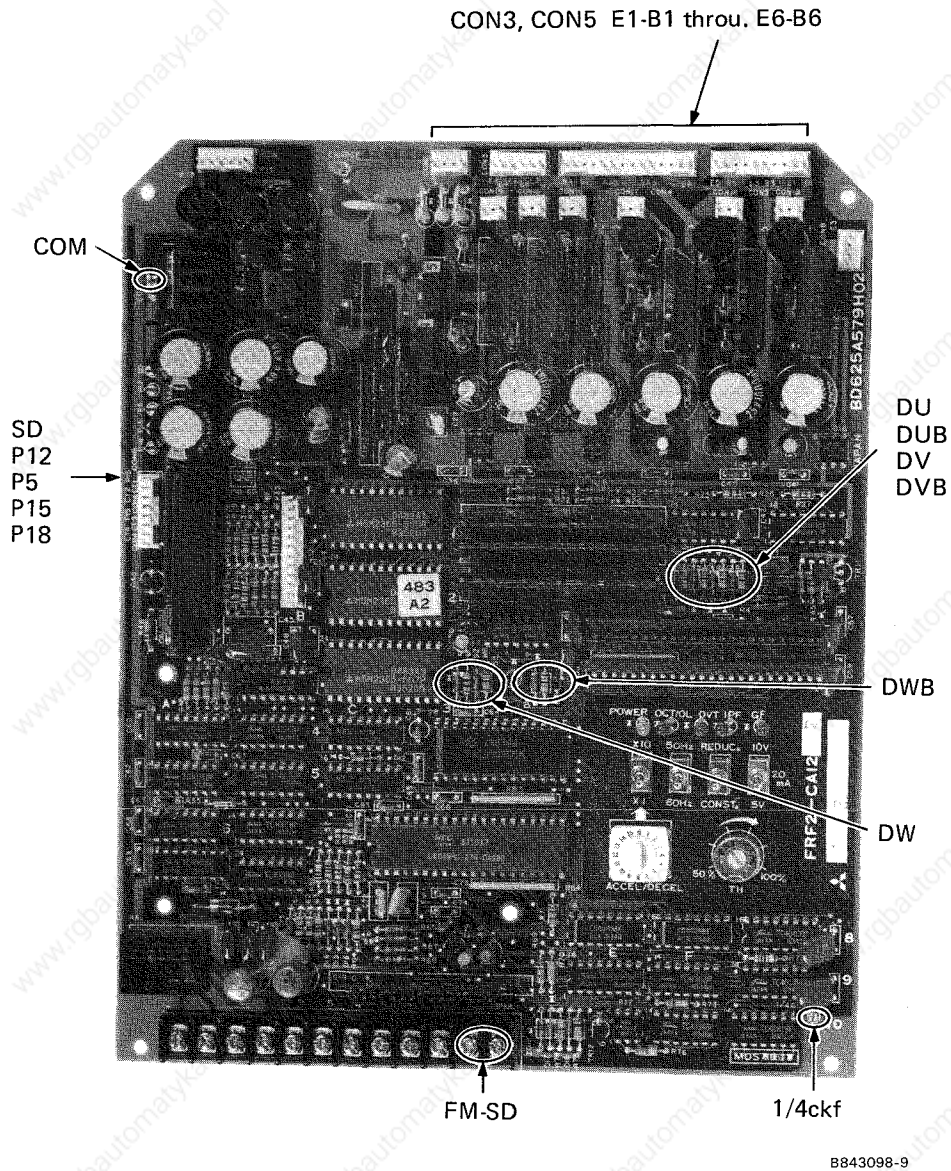
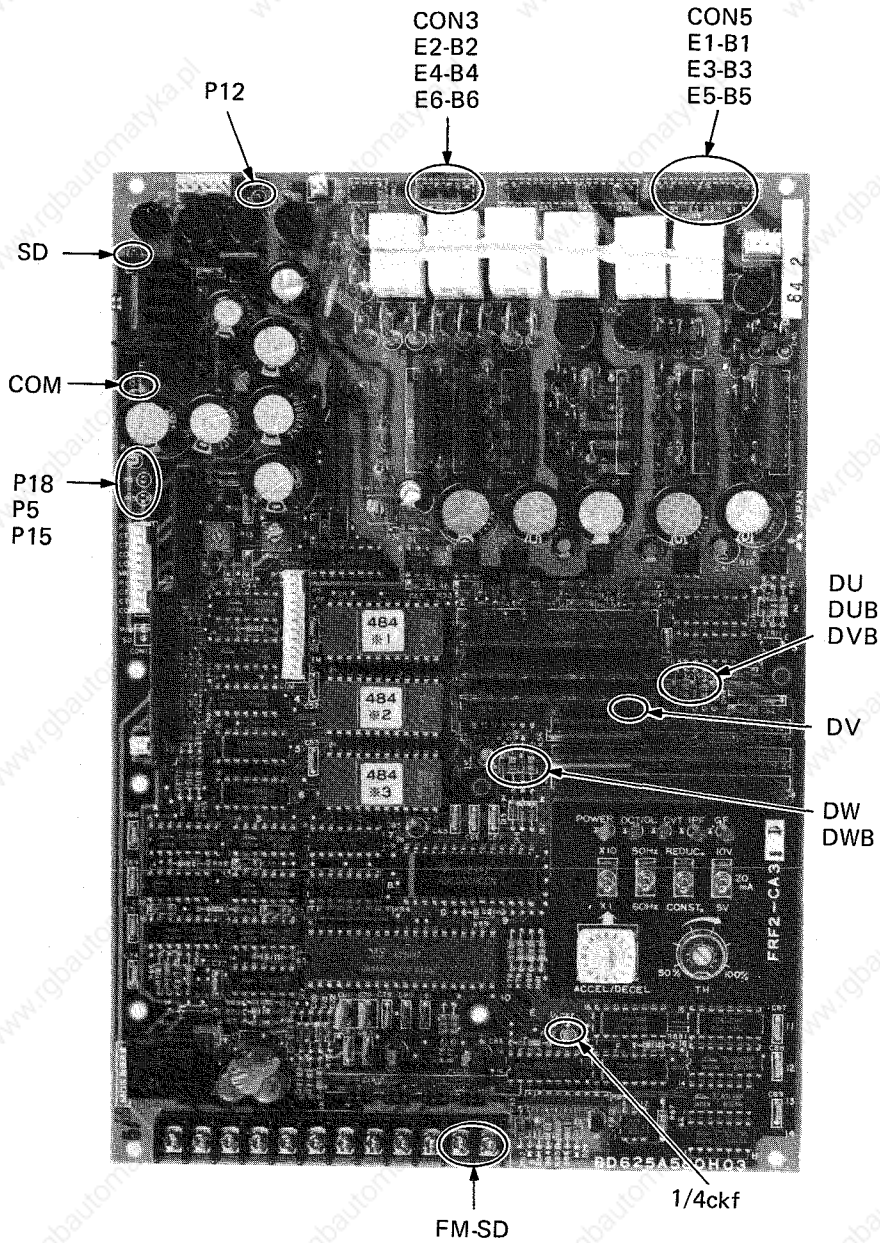

Fig. 14.6.2 Front View of FRF2-CA12

(3) FRF2-CA31 & -CB31

14



B843098-1

Fig. 14.6.3 Front View of FRF2-CA31

(4) FRF2-CA32 & -CB32

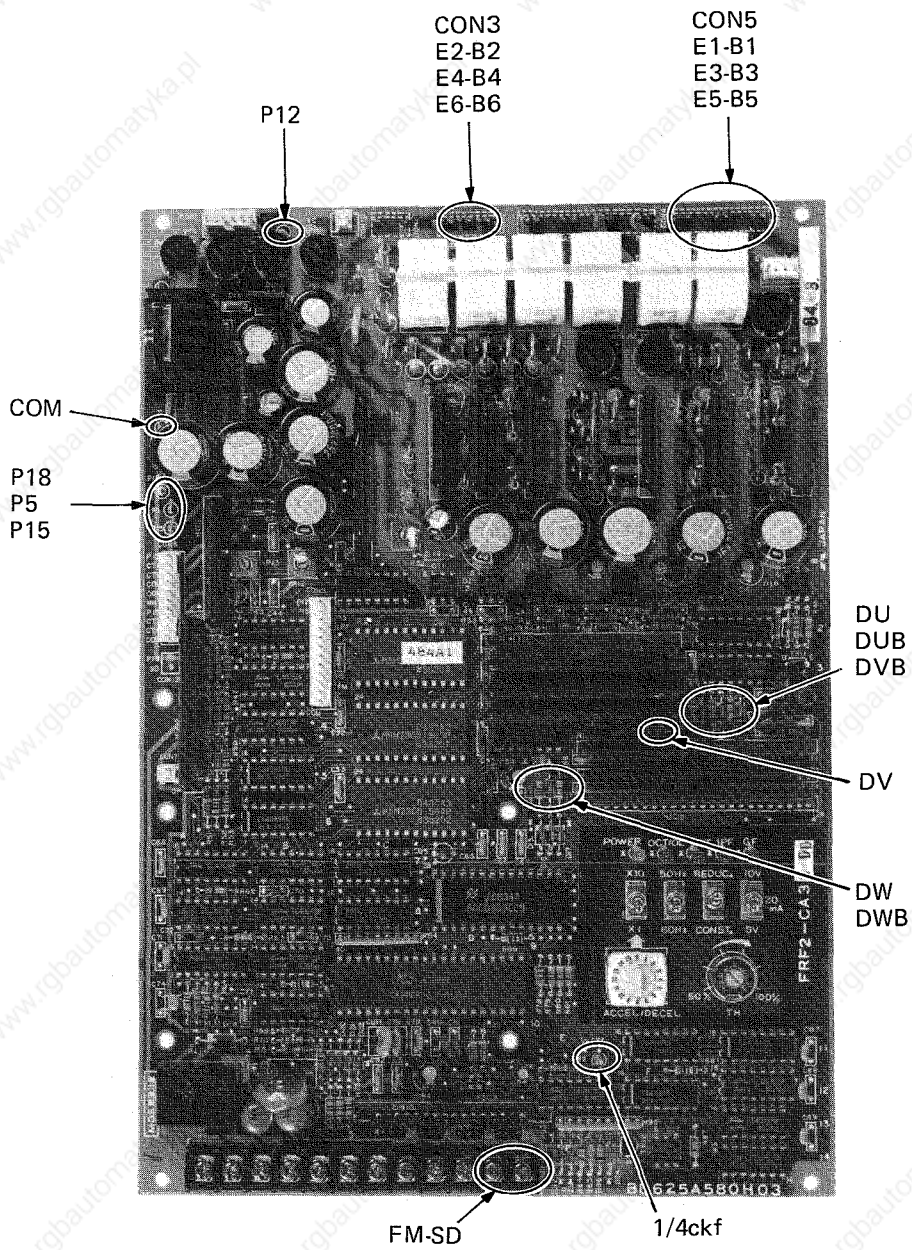

B843097-9

Fig. 14.6.4 Front View of FRF2-CA32

(5) FRF2-CA35 &-CB35

14

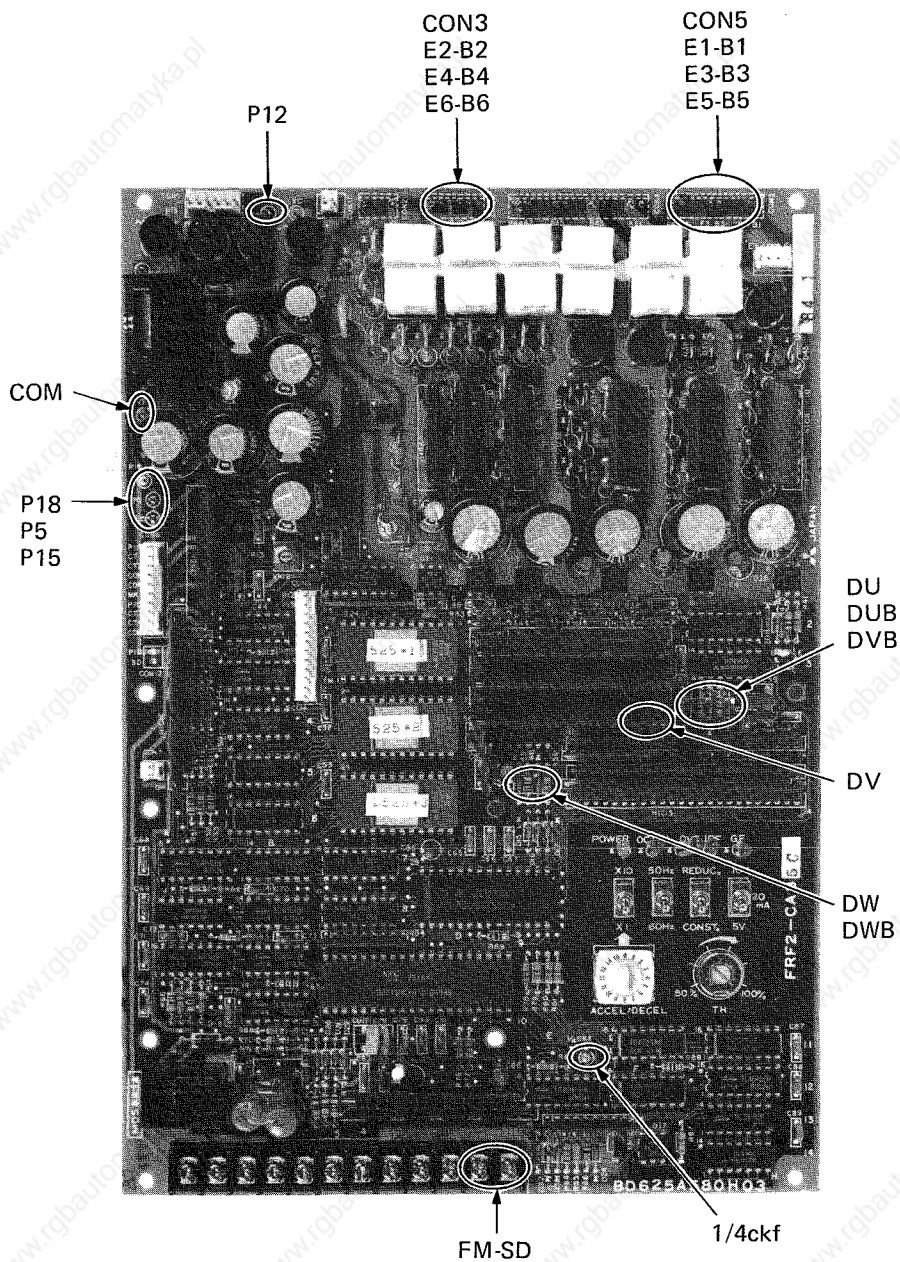

B843098-3

Fig. 14.6.5 Front View of FRF2-CA35

(6) FRF2-CA36 & -CB36

14

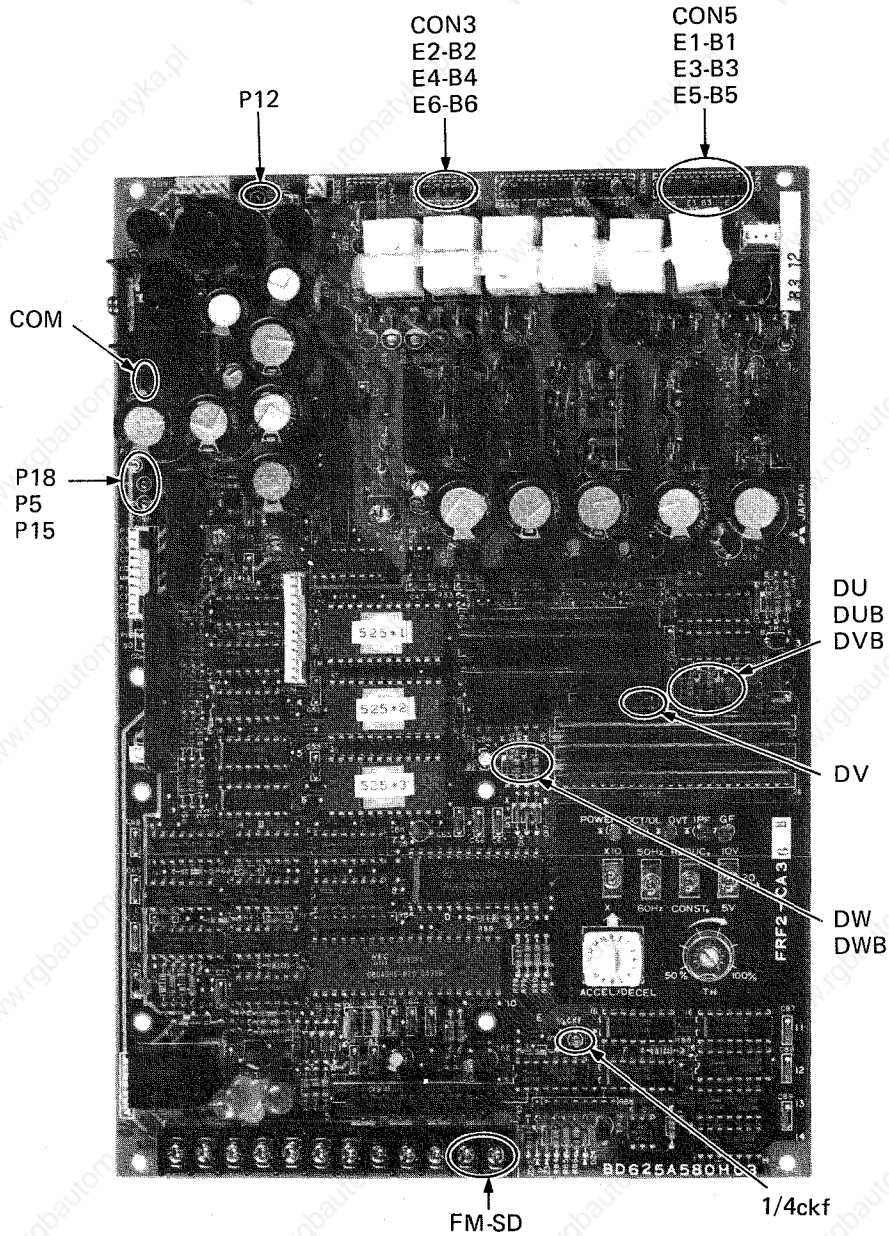

B843098-7

Fig. 14.6.6 Front View of FRF2-CA36

(7) FRF2-DR1

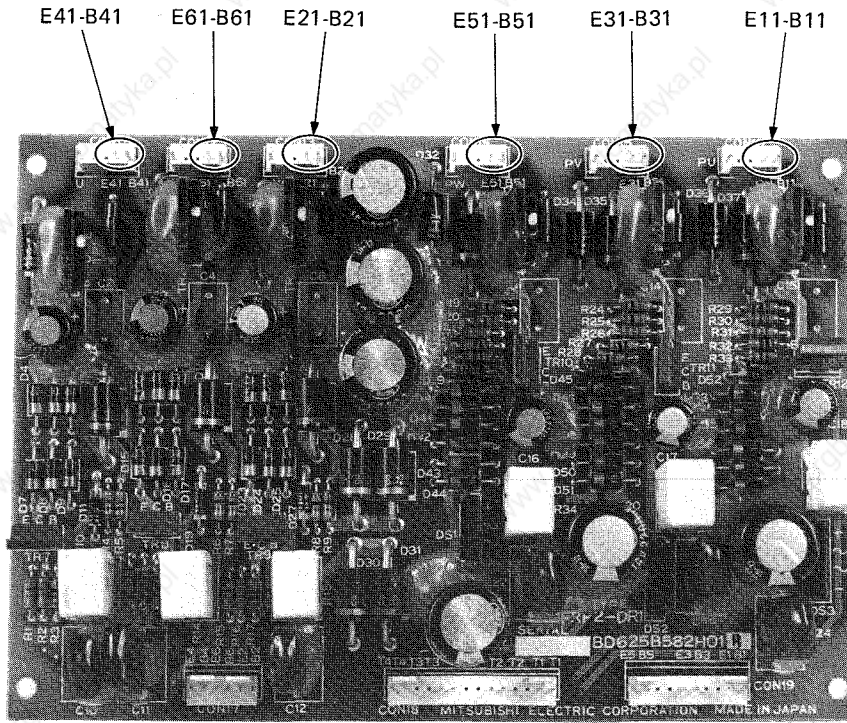

Fig. 14.6.7 Front View of FRF2-DR1

B843097-5

(8) FRF2-HDR1

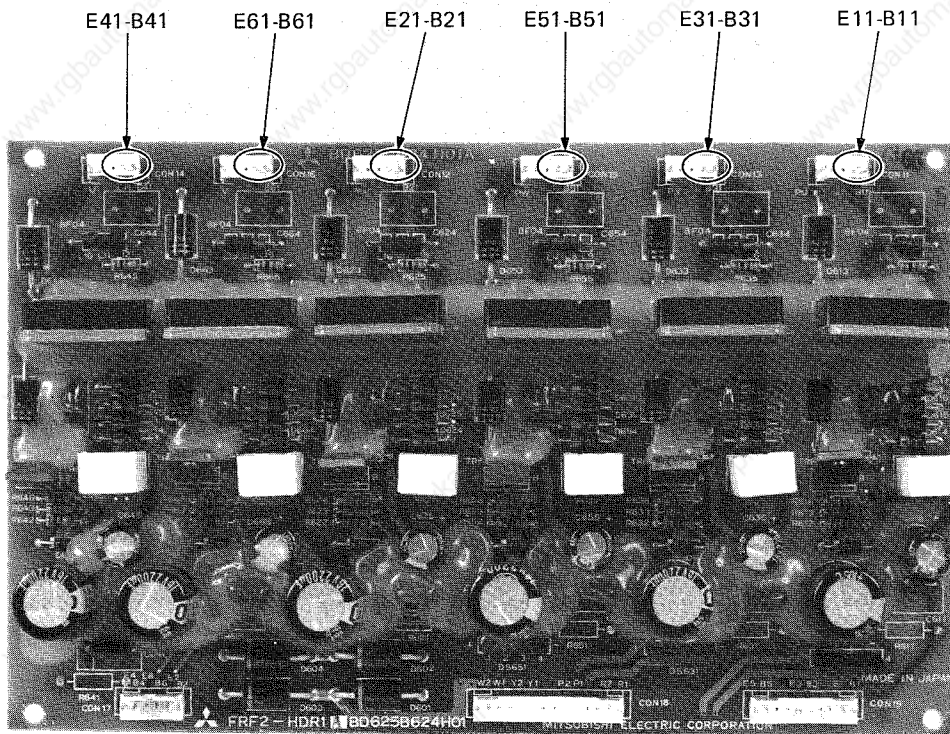

Fig. 14.6.8 Front View of FRF2-HDR

B843098-5

(9) FRF2-DR2

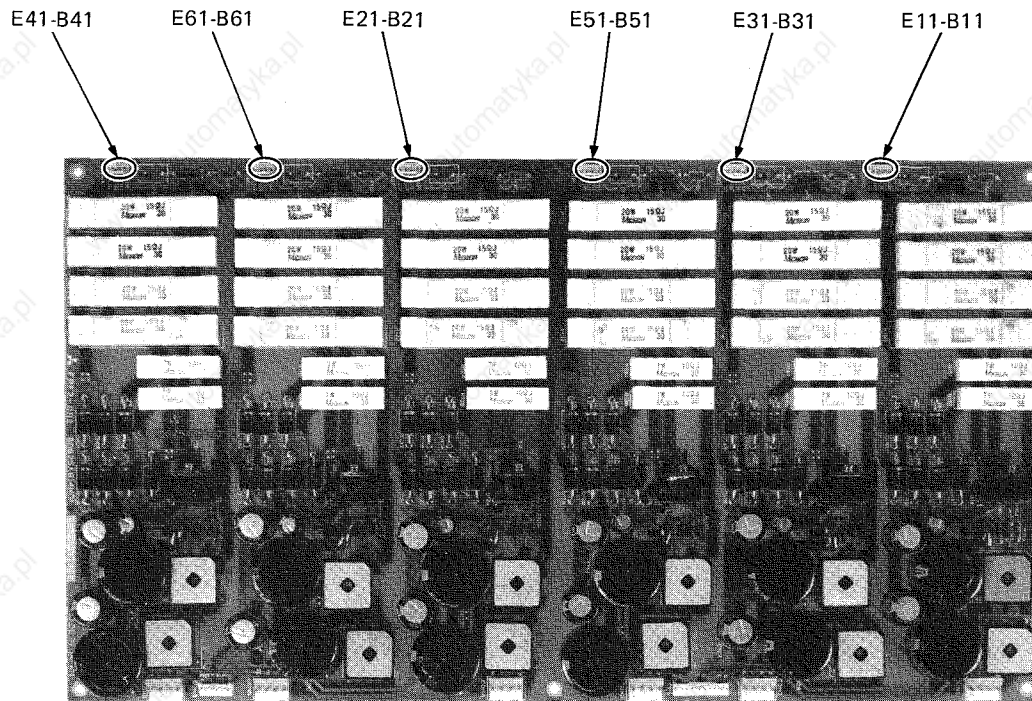

Fig. 14.6.9 Front View of FRF2-DR2

B843097-3

(10) FRF2-HDR2

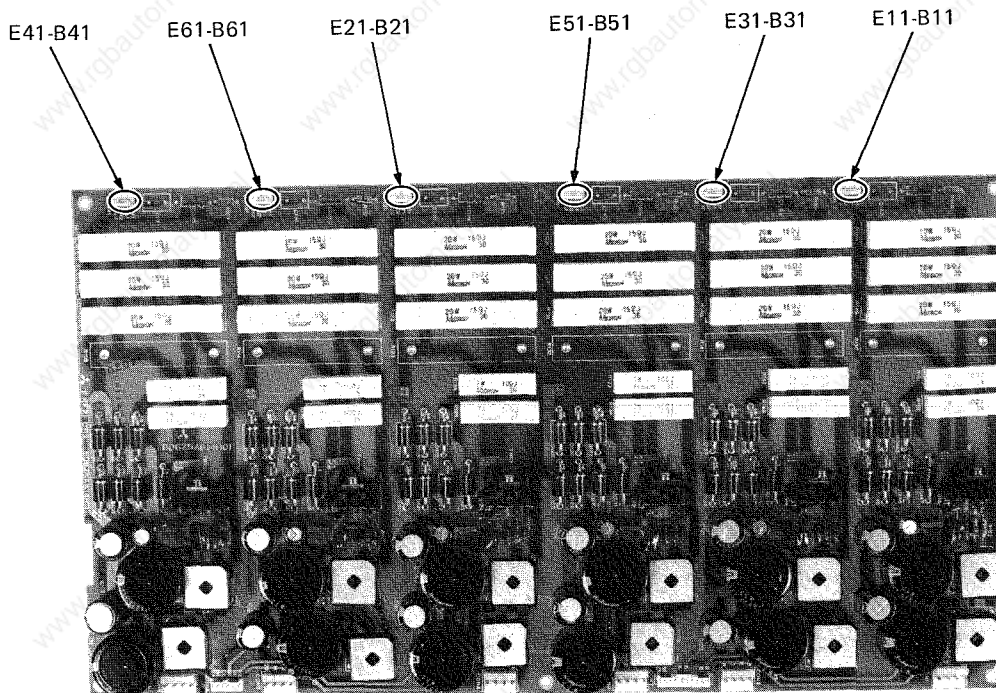

Fig. 14.6.10 Front View of FRF2-HDR2

B843097-1

14.6.2 Checking the DC power supply

Voltages of DC power supplies are as follows.

Checking terminal	Normal voltage
P15 – COM	15V ± 0.6V
P18 – COM	14 throu. 24V
P12 – COM	11.5V ± 1V
P5 – COM	5.0V ± 0.15V

14.6.3 Clock pulse for microcomputer and power supply P18

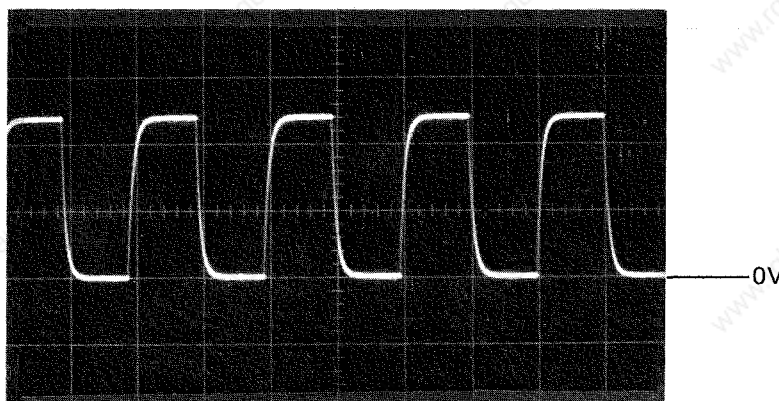

1/4 ckf – COM

2V/div.

5micro sec./div.

If you see the same waveform as shown above, the microprocessor is being driven by the normal clock pulse.

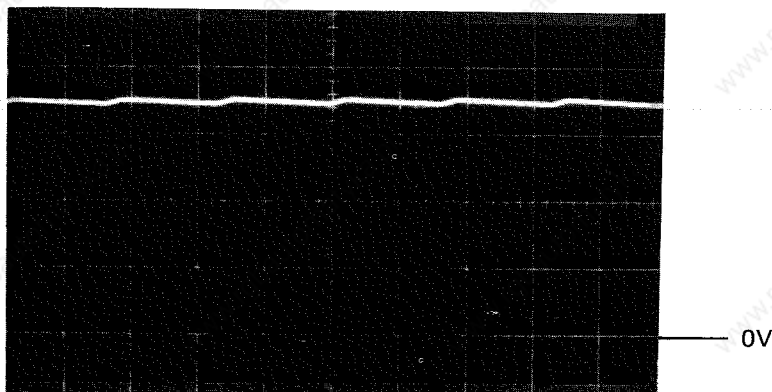

P18 – COM

5V/div.

5m sec./div.

14.6.4 Output voltage (Main circuit)

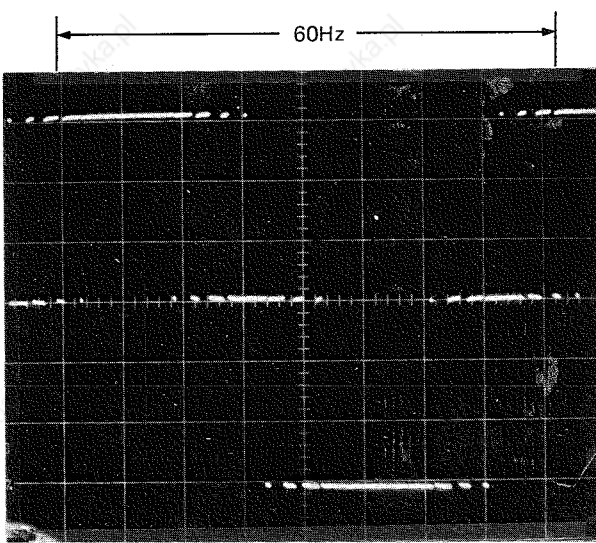

U-V, V-W or W-U
100V/div.
2m sec./div.
60Hz drive

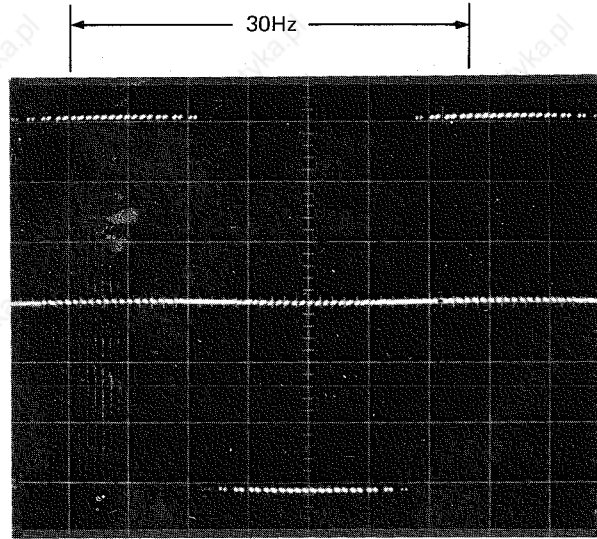

U-V, V-W or W-U
100V/div.
5m sec./div.
30Hz drive

If you see the same waveform as show above, the inverter is ok.
Even though the motor is disconnected from the inverter, you should observe the same waveform as shown above. This waveform does not depend on the load.

14.6.5 Base-emitter voltage of transistor modules

(1) Inverter Driver P.C.B. FRF2-DR1, DR2, HDR1, HDR2 is mounted.

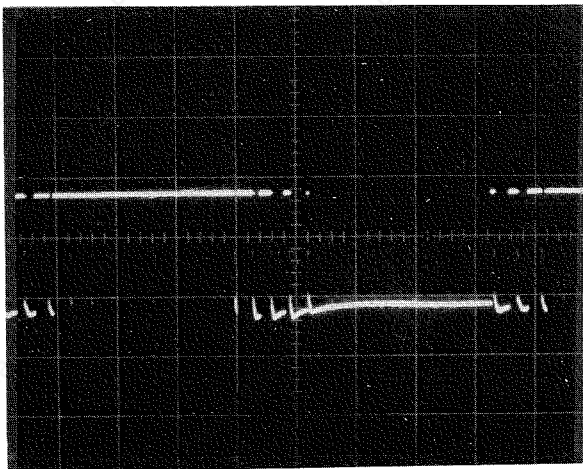

B11-E11, B21-E21, B31-E31, B41-E41, B51-E51 or B61-E61
2V/div.
5m sec./div.
60Hz drive

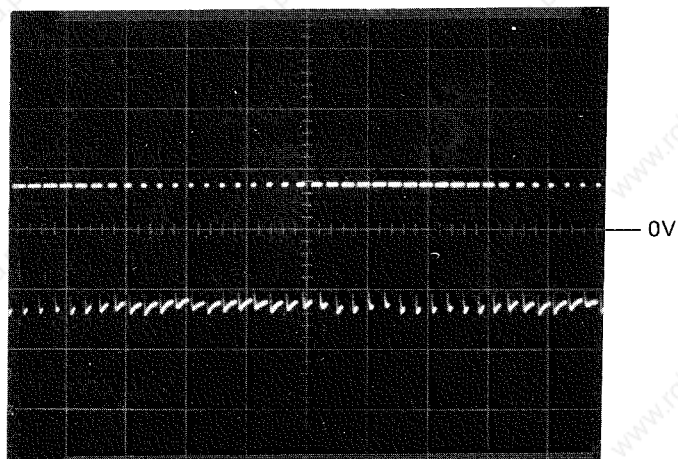

30Hz drive

(2) Inverter Driver P.C.B. is not mounted (smaller than 15HP)

14

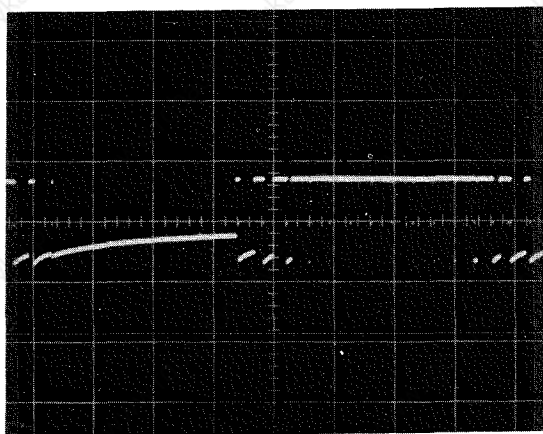

60Hz drive
Base-Emitter
2V/div.
2m sec./div.

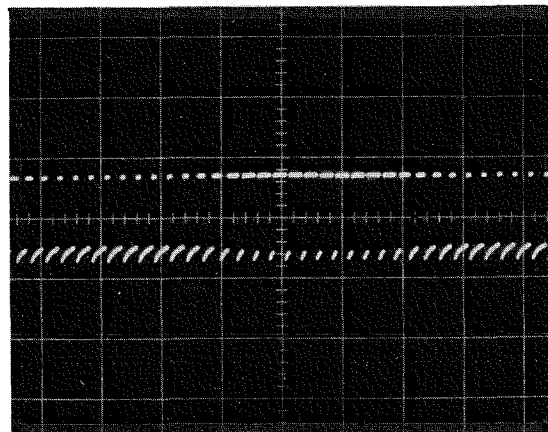

30Hz drive
Base-Emitter
2V/div.
2m sec./div.

14.6.6. Output of base-current amplifier

14

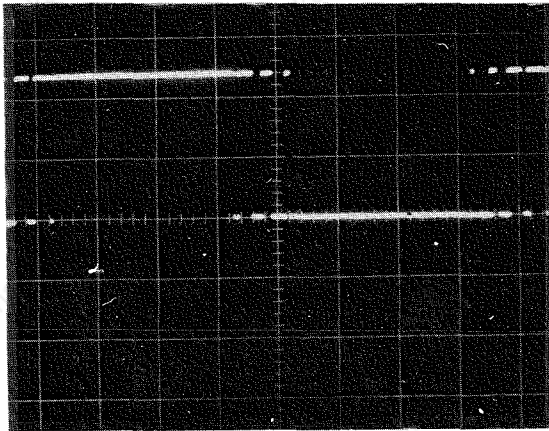

60Hz drive
DU-COM, DV-COM or DW-COM
2V/div.
2m sec./div.

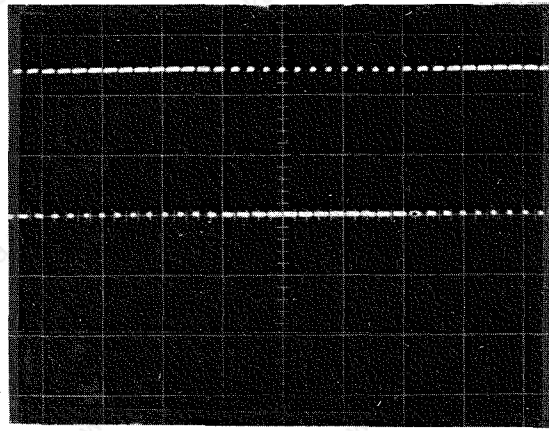

30Hz drive
DU-COM, DV-COM or DW-COM
2V/div.
5m sec./div.

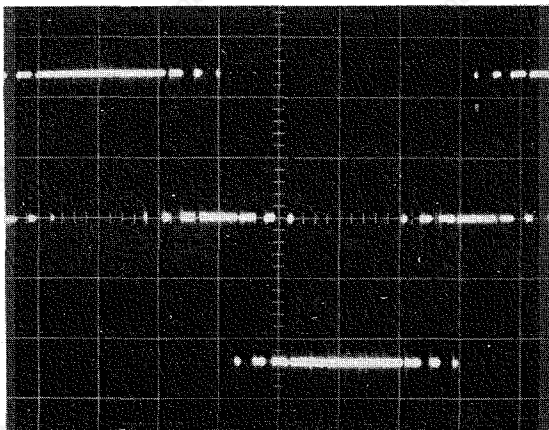

60Hz drive
DU-DV, DV-DW or DW-DU
2V/div.
2m sec./div.

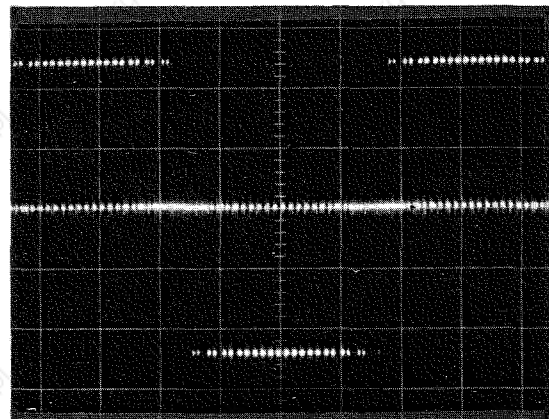

30Hz drive
DU-DV, DV-DW or DW-DU
2V/div.
2m sec./div.

If you see the same waveform as shown above, P.C.B. FRF2-CA or FRF2-MA is ok.

14.6 Output of terminal FM

14

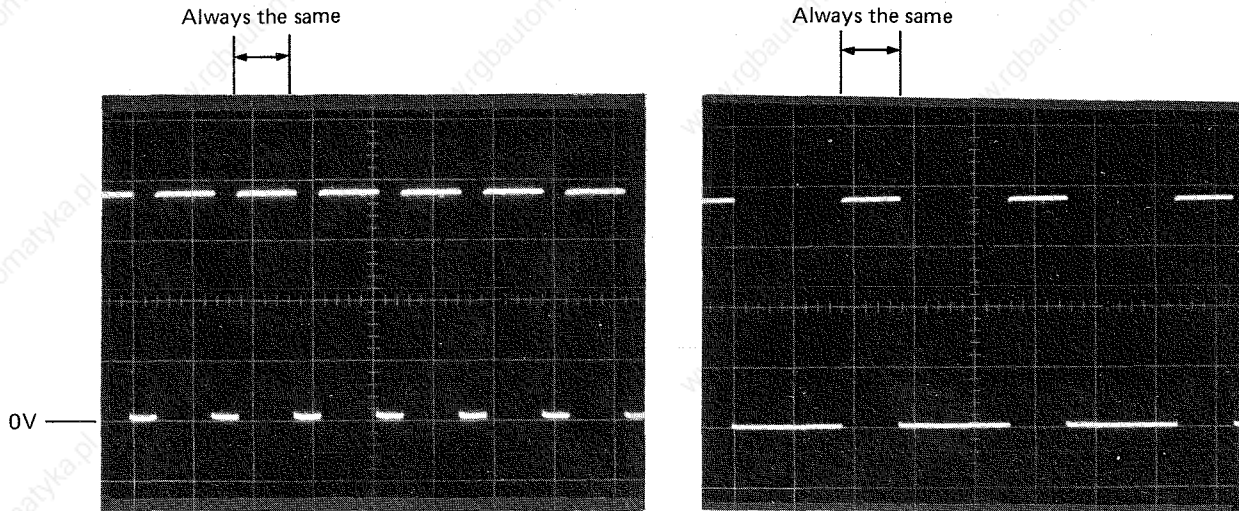

60Hz drive
FM-SD
2V/div.
0.5m sec./div.

30Hz drive
FM-SD
2V/div.
0.5m sec./div.

As shown above, the pulse width during the on-time is always the same and the frequency f is;

$$f = 24 \times \text{driving frequency}$$

For example, when you are driving at the frequency of 60Hz,

$$f = 24 \times 60 = 1440\text{Hz}$$

15. REPLACEMENT OF THE PARTS

CAUTION

1. At any inspection or checking, be sure that the power supply is disconnected.
2. Even after the disconnection, wait until the charge indication lamp "CHARGE" goes out. (Usually for one or two minutes).

Note: For the FR-F2 series inverter, the charge indicating lamp is provided independently from the power indicating lamp. Nevertheless, in the case of FR-F2-750B-U and FR-F2-1500B-U, the power indicating lamp works for both the power indication and the charge indication.

15

15.1 General

- (1) Disconnect the power supply.
- (2) Wait until the "charge" indication lamp goes out.
- (3) Remove the screws from the front cover and remove the cover. And you can see the printed circuit board as shown in Fig. 15.1.1, Fig. 15.1.2 and Fig. 15.1.3.

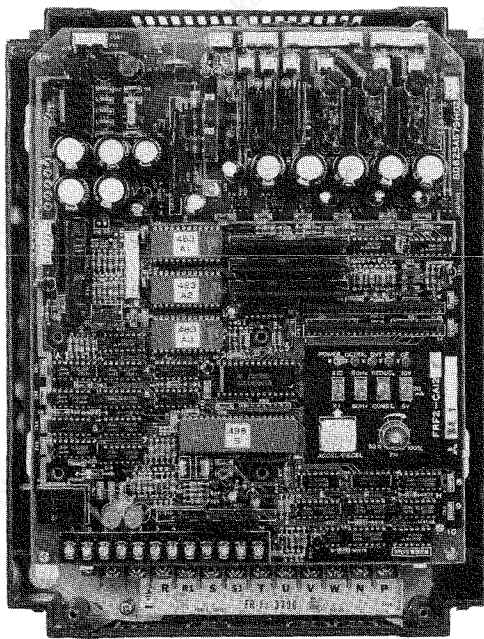

B843080-9

Plastic cover type

Fig. 15.1.1 Outlook of FR-F2-750-U up to 7.5K-U

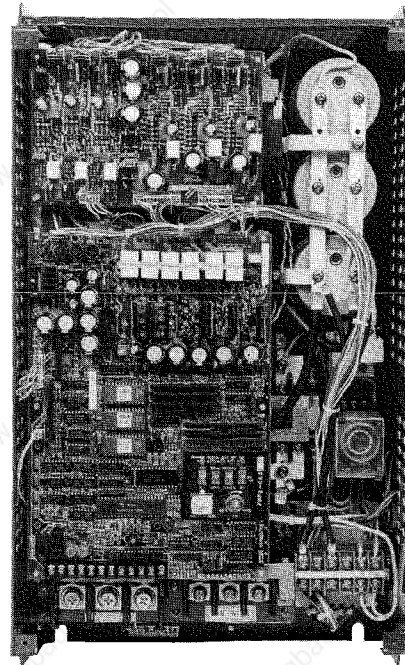

B843091-7

Steel cover type

Fig. 15.1.2 Outlook FR-F2-11K-U over

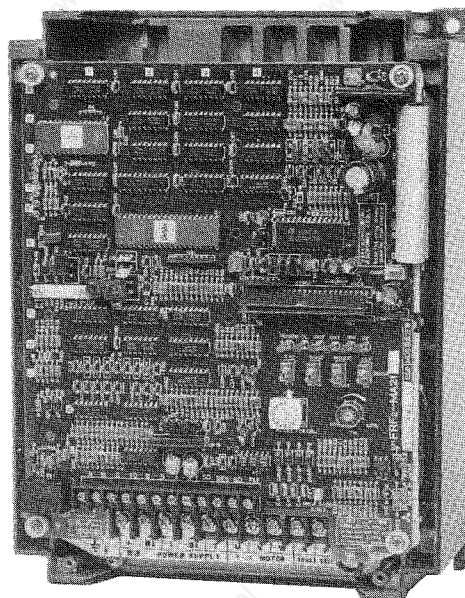
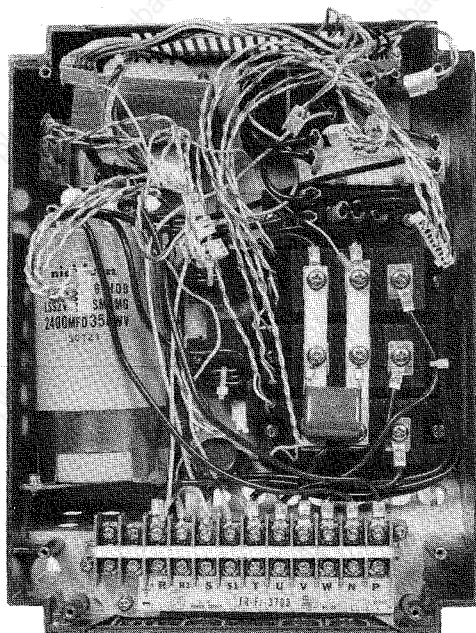

Fig. 15.1.3 Outlook of FR-F2-750B-U and 1500B-U

(4) Disconnect all the wiring to the terminal block and remove the printed circuit board from the chassis then you can see the main-circuit wirings. (See Fig. 15.1.4). But in the case of FR-F2-750B-U and FR-F2-1500B-U all the main circuit is mounted on the printed circuit board and once it is removed all the left are the chassis and the smoothing capacitor. (See Fig. 15.2.3).



B854166-5

Plastic cover type

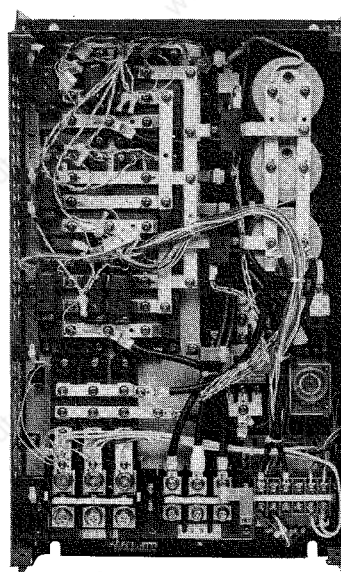

B843092-9

Steel cover type

Fig. 15.1.4 Front View of FR-F2 after The P.C.B. Removed

15.2 Replacement of the Printed Circuit Board FRF2-CB (CA) and FRF2-DR

As mentioned in Sec. 7.1, FR-F2 series have two kinds of Printed circuit board, FRF2-CA and FRF2-DR.

Referring to Table 7.1, replace the printed circuit board with the proper one.

CAUTION

Many ICs mounted on the printed circuit board are vulnerable to static electricity. Be sure not to touch any ICs with your hands at replacement. The printed circuit board is usually kept in special sacks which protect ICs from static electricity field. So, it should not be taken out from the sack if it is not necessary.

15

No re-adjustment is required after the exchange with the new printed circuit board, but set the potentiometer "TH" and other setting switches of the new P.C.B. to the same positions as the old P.C.B.

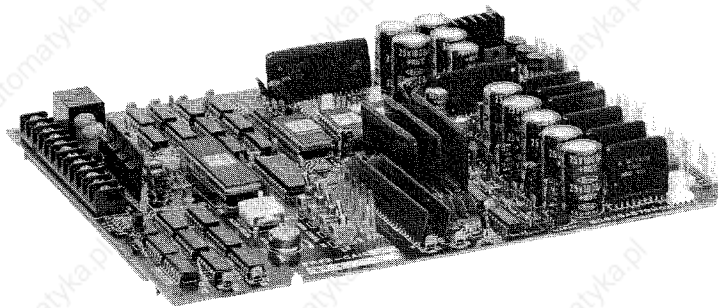

B843082-3

Fig. 15.2.1 Outlook of Printed Circuit Board FRF2-CA12, 32, 36 & -CB12, 32, 36

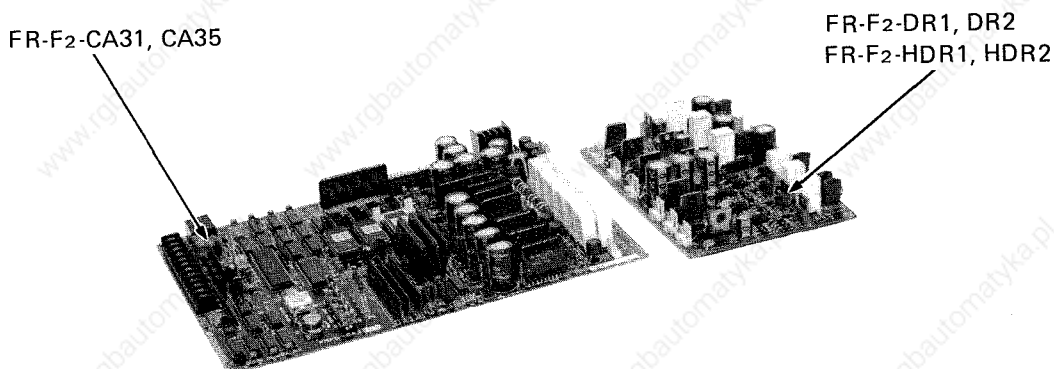

B843079-3

Fig. 15.2.2 Outlook of Printed Circuit Board FRF2-CA31, 35 and FRF2-DR1, 2, HDR1, 2

15

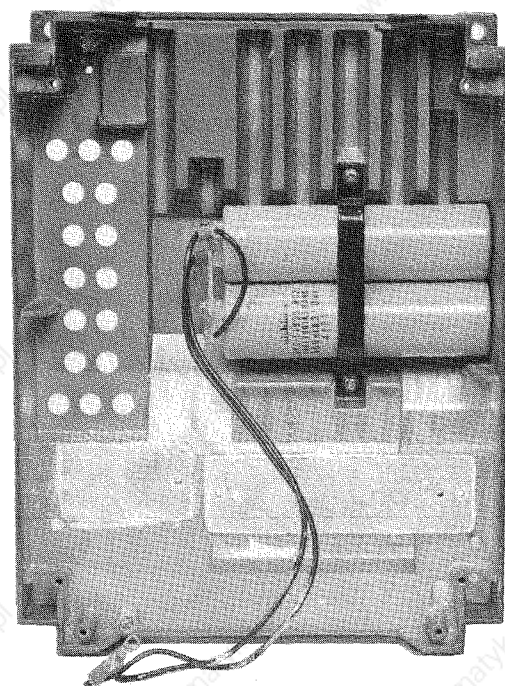

8854166-7

Fig. 15.2.3 Front View of FR-F2-750B-U and 1500B-U after the P.C.B. Removed

No readjustment is required after the exchange with the new printed circuit board, but set the potentiometer and other setting switches of the new P.C.B. to the same position as one of the old P.C.B. (See Fig. 15.2.1).

15

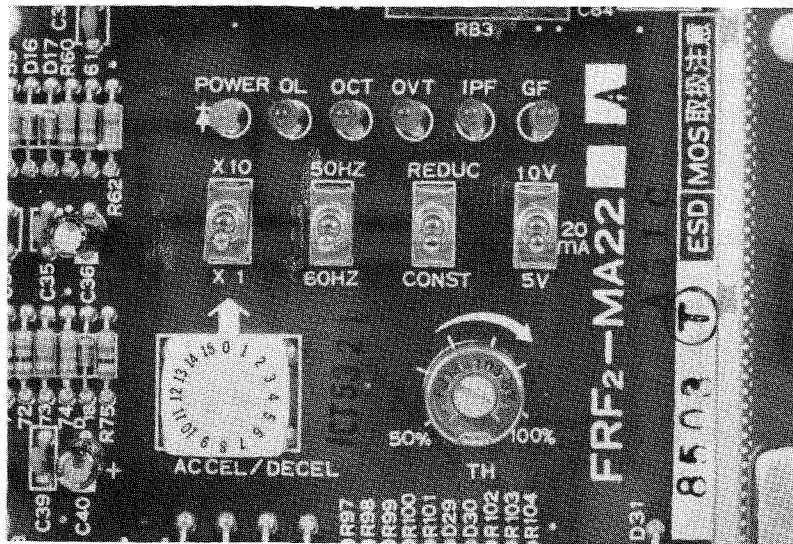

B854166-3

Fig. 15.2.4 Setting Switches

Note: As shown in Fig. 15.2.5, when you've exchanged the printed circuit board of FR-F2-750B-U, 1500B-U take care to push and bend the flat cable so that the flat cable can keep the distance from the chassis. (To keep the noise resistration capacity)

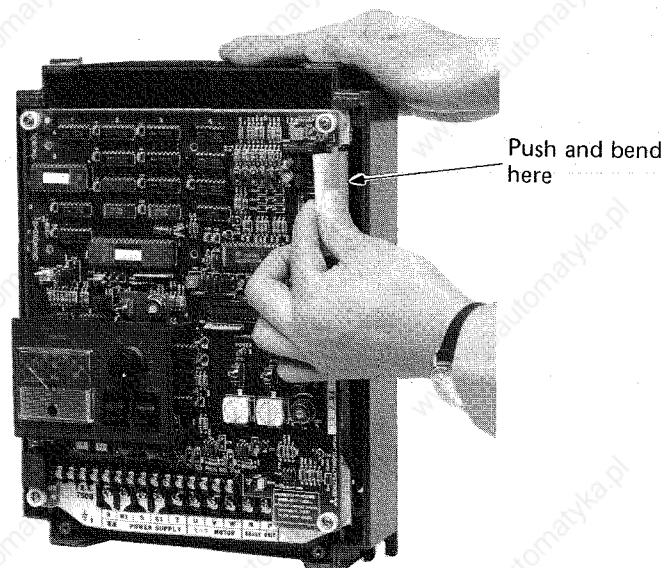

Fig. 15.2.5 Push and Bend The Flat Cable

B843083-3

15.3 Smoothing Capacitors

Smoothing capacitors used in the small size inverters are, as shown in Fig. 15.3.1, wired by the wires, and capacitors used in the large size inverters are, as shown in Fig. 15.3.2, wired by the buses. For the bus wired type, disconnect bus line wirings first, and then take out capacitors. For taking out capacitors and removing wiring, refer to Fig. 15.3.3 and Fig. 15.3.4.

CAUTION

It takes a couple of minutes for capacitors to discharge its electricity, and touching the conductive part of the capacitor while some it has charged electricity will cause electrical shock. Wait until the charge indicating lamp goes out after disconnecting the power supply and check it up that the capacitor has completely discharged.

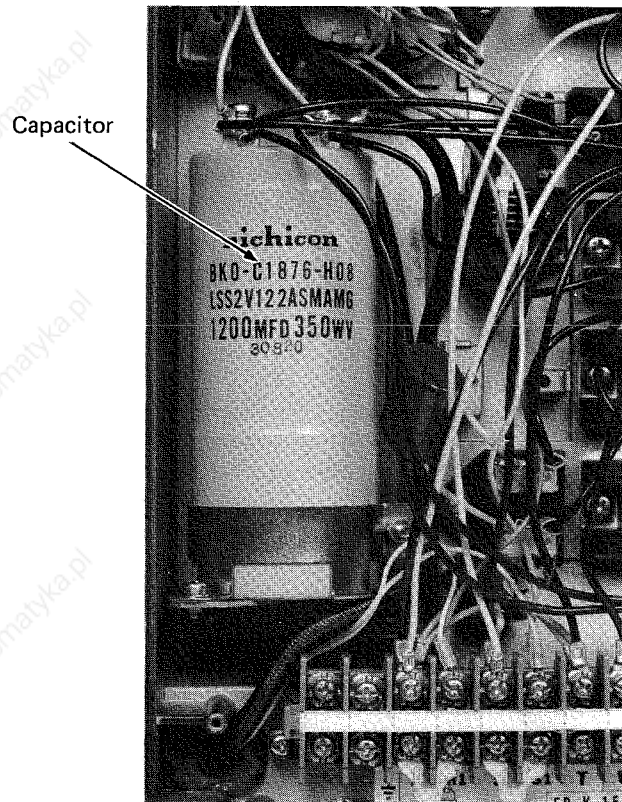

B843075-7

Fig. 15.3.1 Capacitor of Small Size Inverter

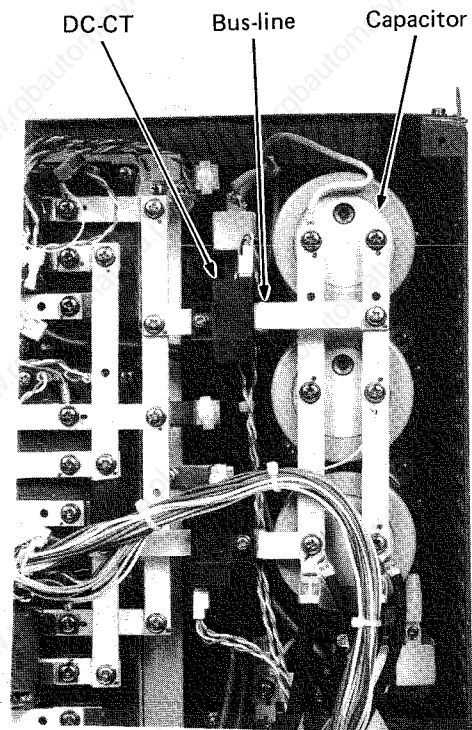

B843082-7

Fig. 15.3.2 Capacitor of Large Size Inverter

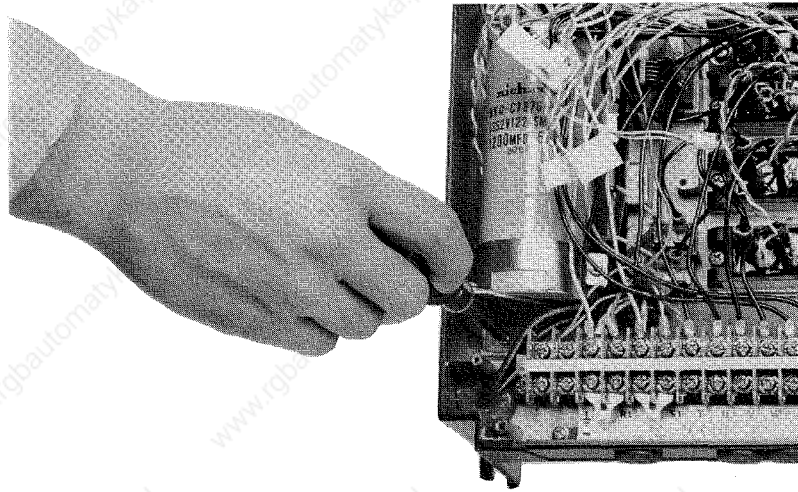

B843071-3

Fig. 15.3.3 Taking out Capacitor from Chassis

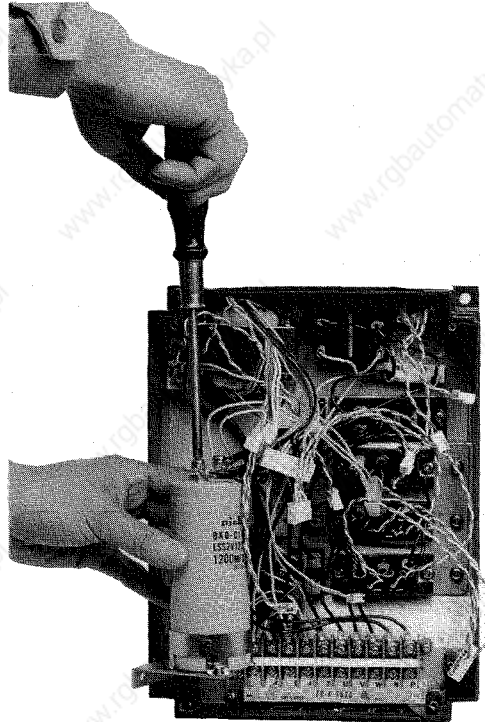

B843071-5

Fig. 15.3.4 Removing Wiring

15.4 Diode and Transistor Modules

Referring to Table 6.1 and Table 6.5, select a suitable component to exchange. Disconnect the wiring to the component and take it out from the chassis. Paint silicon grease onto the conductive surface of the new component so that the dissipated power can flow from the component to the heat sink easily.

Then, re-assemble the new component carefully.

NOTE:

1. *As mentioned above, paint the silicon grease at the exchange of the component. Unless you paint the silicon grease, the rated output power of the inverter cannot be guaranteed.*

2. *Even though the name of the transistors are the same, each same type of transistor has a couple of different Hfe (current gain).
When more than two transistors are connected in parallel, the same Hfe of the transistor must be connected in one parallel connection. So, take care to change all of the transistors which are connected in parallel at the replacement of the broken transistor with the transistors of the same Hfe.
The rank of Hfe is indicated on the surface of the transistor by the white painted alphabet like A, B, C, D, E, F, G, H, Y or Z.*

3. *Be careful to control the mounting torque at the mounting of these components. The mounting torque for each component are;
Transistor module15 – 20kg·cm
Diode module20 – 30kg·cm*

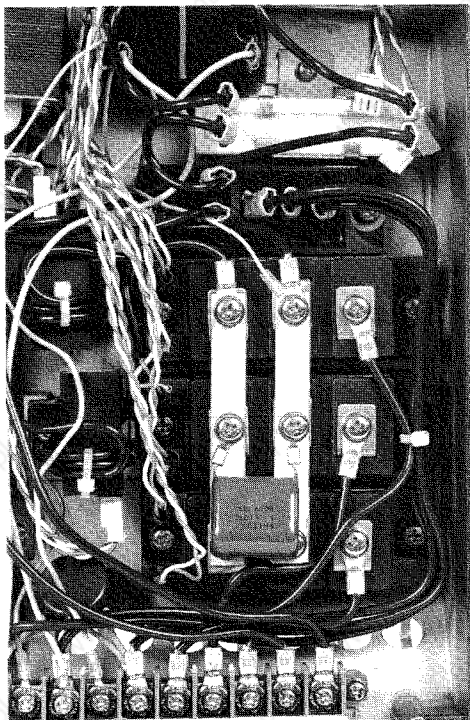

B843080-5

(a) Small size inverter

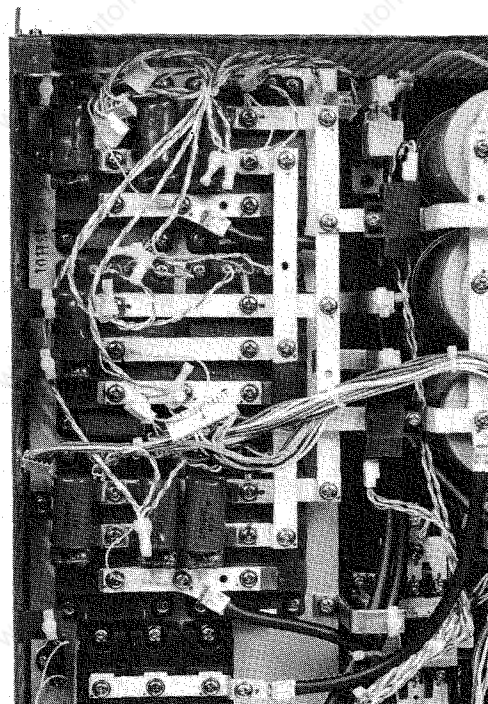

B843082-5

(b) Large size inverter
(Transistors are connected in parallel)

Fig. 15.4. Front View of Assembled Diode and Transistors

15.5 Cooling Fan

Types of the fan used in the FR-F2 inverter are shown in Table 15.1 Referring to this table, select a suitable fan to exchange. Fig. 15.5.1 shows the fan mounted in the small size inverter and Fig. 15.5.2 shows the larger size inverter.

Inverter capacity		Type of fan	Quantity
200V class	FR-F2-5.5K-U	N3951MV BKO-C1792H01	1
	FR-F2-7.5K-U		1
	FR-F2-11K-U	8550MVL BKO-C1942H01	2
	FR-F2-15K-U		2
	FR-F2-22K-U		4
	FR-F2-30K-U	HS4556MVL BKO-C1943H01	4
	FR-F2-37K-U	HS4556MVL BKO-C1943H01	2
	FR-F2-45K-U		4
	FR-F2-55K-U		4
	460V class	FR-F2-H7.5K-U	N3951MV BKO-C1792H01
FR-F2-H11K-U		8550MVL BKO-C1942H01	2
FR-F2-H15K-U			3
FR-F2-H22K-U			
FR-F2-H30K-U		HS4556MVL BKO-C1943H01	4
FR-F2-H37K-U			
FR-F2-H45K-U			4
FR-F2-H55K-U			

Table 15.1 Types of Fan Used in FR-F2

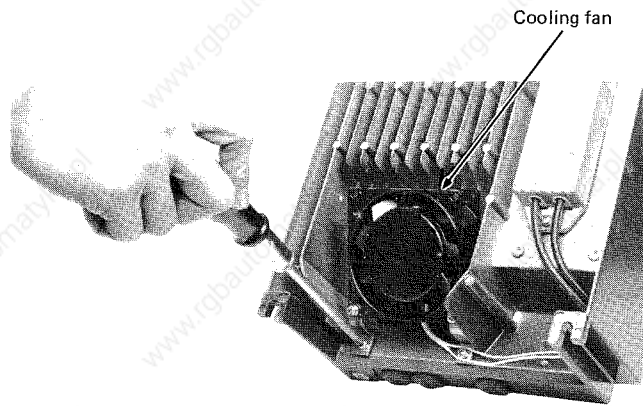

B843072-1

Fig. 15.5.1 Cooling Fan Mounted in the Small Size Inverter

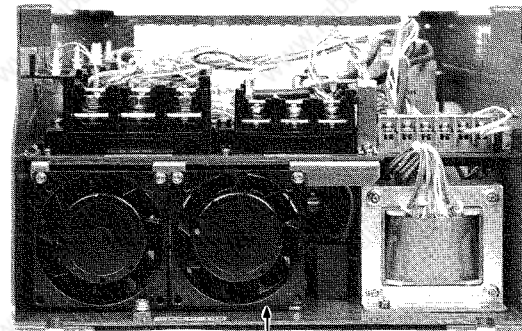

B843079-1

Fig. 15.5.2 Cooling Fan Mounted in the Large Size Inverter

15.6 DC-CT (DC current transformer)

Even though the appearances of the DC-CT is the same as DC-CT's used for various capacities of the inverters, the rated output voltages are different from each other.

Referring to the Table 6.4, select the suitable DC-CT according to the inverter's capacity.

This type of DC-CT is vulnerable to static electricity. So, pay attention at the exchange not to touch the conductive part of the DC-CT nor perform the inspection or the test by the multimeter or other instruments.

Note: The DC-CT had been adjusted for each capacity of the inverter. Do not turn the potentiometer which is located on the surface of the DC-CT.

If the wire is wound through the DC-CT more than one turn, be careful to wind the wire in the same turns at the exchange.

The outlook of the DC-CT is shown in Fig. 6.4.3.

15.7 Operation Panel

To take out the operation panel, you must loose the four screws from the backside of the printed circuit board.

So, take out the printed circuit board at first from the inverter and then disconnect all the wiring from the terminal block. In the next, loose the four screws, which mount the operation panel to the printed circuit board, from the backside of the P.C.B.

Now, exchange the operation panel with the new one, re-connect all the wiring and mount the P.C.B. to the inverter.

Once you've finished all the procedure to resume the normal operation, drive the inverter and turn the potentiometer on the operation panel to the right carefully.

Check out that all the operation is 'OK' and then turn the potentiometer to the right fully. The maximum operation speed is automatically limited to 50Hz or 60Hz according to the selection of the maximum frequency selection switch located on the printed circuit board.

Then, calibrate the frequency meter using the potentiometer on the operation panel.

An outlook of the operation panel is shown in Fig. 15.7.1.



B843085-9

Fig. 15.7.1 Outlook of Operation Panel

16. SOME MISCELLANEOUS INFORMATIONS

16.1 To change the Rated Power Supply Voltage From 230V into 208V or Vice Versa

FR-F2 inverter which was produced for the power supply of 230V AC cannot be used for the supply of 208V, i.e. FR-F2 has two ratings for input power supply and each rating must be used properly according to the input voltage.

In this section, the way to change the rating for the input power supply from 230V to 208V or vice versa is explained.

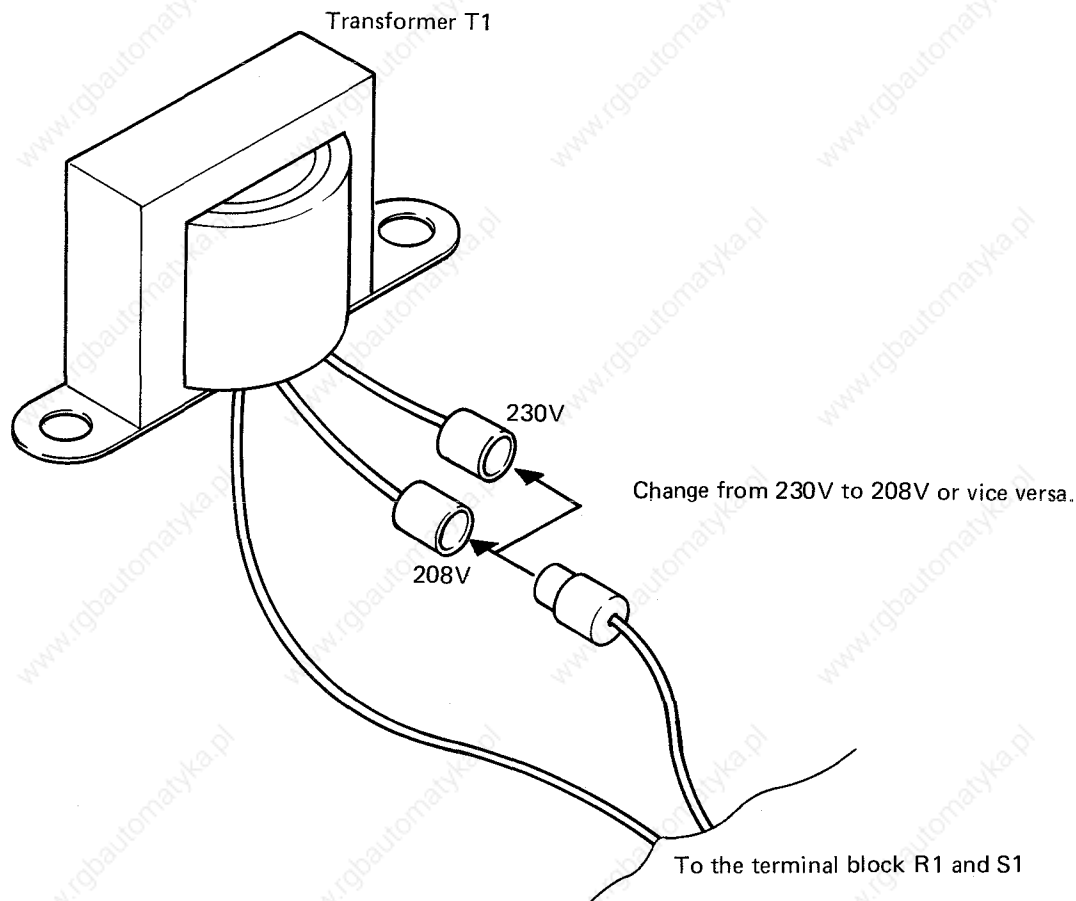

Fig. 16.1 Connection to T1 for 208V and 230V

As shown in Fig. 16.1, the transformer T1 has three wires for the primary winding and two of them are for the input of 230V and 208V. If you want to change the power supply rating, change the connection for this wiring to the proper wire. The ratings are indicated on the white tube.

Note: In the case of FR-F2-750B-U and FR-F2-1500B-U, there is no changing part for the power supply rating and you can use both 208V and 230V without doing anything.

17. TROUBLE CALL

17.1 Confirmation Items at Trouble Call from Your Customer

If you received the trouble call from your customer, you should ask the customer about the condition of the inverter as follows.

- (1) Type FR-K, F2 230V or 460V series?
- (2) Input voltage
- (3) Option
- (4) Motor specification, HP poles
- (5) Application (ex. pump, fan or conveyor etc.)
- (6) Fault indication lamp
- (7) Accel/decel setting
- (8) Maximum frequency (FR-K only), 60Hz, 120Hz or 240Hz?
- (9) The frequency of failure occurrence, once or frequently?
- (10) The time of failure occurrence, at accelerating or decelerating?
- (11) How many years the inverter has been used?
- (12) External wirings
- (13) The instruments for checking which the customer provides
- (14) Customer's name, address address and telephone no.

You should note those informations to the following sheet from your customer and answer how to countermeasure according to the trouble-shooting items.

17. TROUBLE CALL

FREQROL-F2

INVERTER TROUBLE SHEET

DATE

SIGN

CUSTOMER	NAME		ADDRESS		TEL		
TYPE	FR-	230V 460V	HP	SERIAL			
OPTION				APPLICATION			
MOTOR	MANUFACTURER		HP	No. of pole			
DATE OF OCCURRENCE	ONCE FREQUENTLY						
ALARM LAMP	ALARM (K series)	AT POWER ON		MODE : PAM·COMB·PWM (only FR-E)			
MOTOR CONDITIONS	MOTOR DOES NOT RUN. MOTOR REVOLUTION IS NOT SMOOTH. MOTOR CAN NOT VARY THE SPEED. MOTOR OVERHEATS ABNORMALLY. MOTOR DOES NOT RUN BUT BEING NOISY.	WHEN DID THE FAILURE OCCUR?	AT STARTING		SETTING	APPLICATION : (only FR-E)	
			AT ACCELERATING			ACCEL. : X	
			AT DECELERATING			DECEL. : X	
			AT NORMAL OPERATING () Hz		VOLTAGE AND CURRENT	V/F PATTERN : CONST·REDUC (only FR-F2)	
			OTHERS			INPUT VOLTAGE : V Hz	
						OUTPUT CURRENT : A	
				INSULATION : OHM			
				OTHERS :			
INVERTER CONDITIONS							
COUNTERMEASURE							
ANSWER TO THE CUSTOMER							

17

18. SPARE PARTS

(1) Diode module (Diode stack)

	Inverter type	Diode module	Working quantity
200V class	FR-F2-750B-U	D20VT80	1
	FR-F2-1500B-U		1
	FR-F2-750-U	RM10TA-H	1
	FR-F2-1500-U	RM10TA-H	1
	FR-F2-2200-U	FM15TA-H	1
	FR-F2-3700-U	RM15TA-H	1
	FR-F2-5.5K-U	PT758	1
	FR-F2-7.5K-U	PT758	1
	FR-F2-11K-U	PD608	3
	FR-F2-15K-U	PD608	3
	FR-F2-22K-U	PD1008	3
	FR-F2-30K-U	PD1008	3
	FR-F2-37K-U	BKO-C1922H01	1
	FR-F2-45K-U	BKO-C1922H02	1
	FR-F2-55K-U	BKO-C1922H02	1
460V class	FR-F2-H3700-U throu. H7.5K-U	RM20TA-2H	1
	FR-F2-H11K-U	RM30-DZ-2H	3
	FR-F2-H15K-U	RM30-DZ-2H	3
	FR-F2-H22K-U	RM60-DZ-2H	3
	FR-F2-H30K-U throu. H55K-U	RM100-DZ-2H	3

(2) Transistor module

	Inverter type	Type of transistor	Quantity
200V class	FR-F2-750B-U	QM15TC-H BKO-C1982H02	1
	FR-F2-1500B-U	QM20TC-H BKO-C1982H03	1
	FR-F2-750-U	QM15TB-H BKO-C1905H03	1
	FR-F2-1500-U	QM20DX-H BKO-C1869H02	3
	FR-F2-2200-U	QM50DY-H BKO-C1869H03	3
	FR-F2-3700-U	QM50DY-H BKO-C1869H03	3
	FR-F2-5.5K-U	QM50DY-H BKO-C1869H03	3
	FR-F2-7.5K-U	QM100DY-H BKO-C1819H02	3
	FR-F2-11K-U	QM150DY-H BKO-C1945H01	3
	FR-F2-15K-U	QM100DY-H BKO-C1819H02	6
	FR-F2-22K-U	QM150DY-H BKO-C1945H02	6
	FR-F2-30K-U	QM150DY-H BKO-C1945H03	9
	FR-F2-37K-U	QM100DY-H BKO-C1819H04	12
	FR-F2-45K-U	QM150DY-H BKO-C1945H03	9
	FR-F2-55K-U	QM150DY-H BKO-C1945H04	12
460V class	FR-F2-H3700-U	QM25DY-2HA BKO-C1851H02	3
	FR-F2-H5.5K-U	QM50DY-2HA BKO-C1851H03	3
	FR-F2-H7.5K-U	QM50DY-2HA BKO-C1851H03	3
	FR-F2-H11K-U	QM100DY-2HA BKO-C1851H04	3
	FR-F2-H15K-U	QM100DY-2HA BKO-C1851H04	3
	FR-F2-H22K-U	QM100DY-2HA BKO-C1851H04	6
	FR-F2-H30K-U	QM100DY-2HA BKO-C1851H04	6
	FR-F2-H37K-U	QM100DY-2HA BKO-C1851H04	6
	FR-F2-H45K-U	QM100DY-2HA BKO-C1851H04	9
	FR-F2-H55K-U	QM100DY-2HA BKO-C1851H04	9

(3) DC-CT (DC current transformer)

Inverter type	DC-CT type	Quantity		
200V class	FR-F2-750B-U	BKO-C1977H13	2	
	FR-F2-1500B-U	BKO-C1977H14	2	
	FR-F2-750-U	BKO-C1909H02	2	
	FR-F2-1500-U	BKO-C1909H03	2	
	FR-F2-2200-U	BKO-C1909H05	2	
	FR-F2-3700-U	BKO-C1909H05	2	
	FR-F2-5.5K-U	BKO-C1909H06	2	
	FR-F2-7.5K-U	BKO-C1909H07	2	
	FR-F2-11K-U	BKO-C1909H08	2	
	FR-F2-15K-U	BKO-C1909H09	2	
	FR-F2-22K-U	BKO-C1909H11	2	
	FR-F2-30K-U	BKO-C1909H12	2	
	FR-F2-37K-U	BKO-C1909H13	2	
	FR-F2-45K-U	BKO-C1909H14	2	
	FR-F2-55K-U	BKO-C1909H15	2	
	460V class	FR-F2-H3700-U	BKO-C1909H29	2
		FR-F2-H5.5K-U	BKO-C1909H17	2
		FR-F2-H7.5K-U	BKO-C1909H17	2
		FR-F2-H11K-U	BKO-C1909H19	2
FR-F2-H15K-U		BKO-C1909H19	2	
FR-F2-H22K-U		BKO-C1909H21	2	
FR-F2-H30K-U		BKO-C1909H23	2	
FR-F2-H37K-U		BKO-C1909H23	2	
FR-F2-H45K-U		BKO-C1909H25	2	
FR-F2-H55K-U		BKO-C1909H25	2	

(4) Transformer

Inverter type		Specification	Working quantity
		208/230V or 460V	
200V class	FR-F2-750, 1500-U	BKO-C1917H11	1
	FR-F2-750B, 1500B-U	BKO-C1971H04 and BKO-C2021H01	1
	FR-F2-2200, 3700-U	BKO-C1917H06	1
	FR-F2-5.5K-U	BKO-C1979H01	1
	FR-F2-7.5K-U	BKO-C1979H01	1
	FR-F2-11K-U thru. 37K-U	BKO-C1979H02	1
	FR-F2-45K-U thru. 55K-U	BKO-C1979H02 and BKO-C1946H02	1
460V class	FR-F2-H3700-U thru. H7.5K-U	BKO-C1979H03 and BKO-C1952H11	1
	FR-F2-H11K, H15K	BKO-C1979H04 and BKO-C1952H12	1
	FR-F2-H12K-U	BKO-C1979H05 and BKO-C1952H12	1
	FR-F2-H30K-U thru. H55K-U	BKO-C1979H06 and BKO-C1952H13 and BKO-C1951H02	1

(5) Smoothing capacitor

Inverter type		Type of capacitor	Quantity
200V class	FR-F2-750B-U	600 μ F BKO-C1935H03	1
	FR-F2-1500B-U		2
	FR-F2-750-U	600 μ F BKO-C1935H02 1200 μ F BKO-C1876H08 2400 μ F BKO-C1876H09 2400 μ F BKO-C1876H09 2000 μ F BKO-C1876H03 2400 μ F BKO-C1876H09	1
	FR-F2-1500-U		1
	FR-F2-2200-U		1
	FR-F2-3700-U		1
	FR-F2-5.5K-U		2
	FR-F2-7.5K-U		2
	FR-F2-11K-U		3200 μ F BKO-C1920H01
	FR-F2-15K-U	3	
	FR-F2-22K-U	4	
	FR-F2-30K-U	6	
	FR-F2-37K-U	7	
	FR-F2-45K-U	8	
FR-F2-55K-U	10		
460V class	FR-F2-H3700-U	1500 μ F BKO-C1944H04	2
	FR-F2-H5.5K-U		4
	FR-F2-H7.5K-U		4
	FR-F2-H11K-U	4000 μ F BKO-C1944H06	4
	FR-F2-H15K-U		4
	FR-F2-H22K-U		6
	FR-F2-H30K-U		8
	FR-F2-H37K-U		8
	FR-F2-H45K-U		10
	FR-F2-H55K-U		10

(6) Magnetic contactor and Control Relay

	Inverter type	Specification	Working quantity
200V class	FR-F2-750B-U	TV24D1-0	1
	FR-F2-1500B-U	DR24D1	1
	FR-F2-750-U	JH1A BKO-C1967H04	1
	FR-F2-1500-U		1
	FR-F2-2200-U		1
	FR-F2-3700-U		1
	FR-F2-5.5K-U		SA11RM-208V AC
	FR-F2-7.5K-U	SA11RM-208V AC	1
	FR-F2-11K-U	SA12RM-208V AC	1
	FR-F2-15K-U	SK20-208V AC	1
	FR-F2-22K-U	SK25-208V AC	1
	FR-F2-30K-U	SK35-208V AC	1
	FR-F2-37K-U	SK50-200V AC	1
	FR-F2-45K-U	SK80-200V AC	1
FR-F2-55K-U	SK80-200V AC	1	
400V class	FR-F2-H3700-U throu. H7.5K-U	SA10RM-200V AC	1
	FR-F2-H11K-U	SA11RM-200V AC	1
	FR-F2-H15K-U	SA11RM-200V AC	1
	FR-F2-H22K-U	SA12RM-200V AC	1
	FR-F2-H30K-U	SK20-200V AC	1
	FR-F2-H37K-U	SK20-200V AC	1
	FR-F2-H45K-U	SK35-200V AC	1
	FR-F2-H55K-U	SK35-200V AC	1

(7) Timer relay

	Inverter type	Specification	Working quantity
200V class	FR-F2-750(750B)-U throu. 7.5K-U	Not used	—
	FR-F2-11K-U throu. 55K-U	DRS-N2 AOP5 220V AC*	1
460V class	FR-F2-H3700-U throu. H7.5K-U	Not used	—
	FR-F2-H11K-U throu. H55K-U	DRS-N2 AOP5 220V AC*	1

18. SPARE PARTS

FREQROL-F2

(8) Resistor (In-rush current suppression resistor)

Inverter type	Type	Quantity
200V class	FR-F2-750B-U FR-F2-1500B-U	MZS10N2R0K 1
	FR-F2-750-U FR-F2-1500-U	MFS15AO20K 1 MFS15AO20K 1
	FR-F2-2200-U FR-F2-3700-U	MFS30AO10K 1 MFS30AO10K 1
	FR-F2-5.5K-U FR-F2-7.5K-U	MHS40AOR5K MHS-4087 1 MHS40AOR5K MHS-4087 1
	FR-F2-11K-U FR-F2-15K-U	MHS40BOR5K MHS-4088 1 MHS40BOR5K MHS-4088 2
	FR-F2-22K-U FR-F2-30K-U throu. 55K-U	MHS40BOR5K MHS-4088 2 MHS40BOR5K MHS-4088 4
	FR-F2-H3700-U throu. H7.5K-U	MFS30AO10K 2
	FR-F2-H11K-U throu. H55K-U	MHS40BOR5K MHS-4088 2

(9) Resistor (Base current control resistor)

Used for only FR-F2-750(750B)-U, 1500(1500B)-U, 3700-U

Inverter type	Type	Quantity
200V class	FR-F2-750(750B)-U	MNS03N500K 6
	FR-F2-1500(1500B)-U throu. 3700-U	MNS03N300K 6

Note(*): The coil rating depends on the voltage rating of the power supply.

18. SPARE PARTS

FREQROL-F2

(10) Resistor (Smoothing capacitor balancing resistor)

Used for only 460V class inverter

Inverter type		Type	Quantity
460V class	FR-F2-H3700-U	ML80W20KOHM BKO-C1968H01	2
	FR-F2-H5.5K-U and H7.5K-U	ML80W20KOHM BKO-C1968H01	2
	FR-F2-H11K-U and H15K-U	KHZ30W 20KOHM	4
	FR-F2-H22K-U	KHZ30W 20KOHM	6
	FR-F2-H30K-U and H37K-U	MY220W5KOHM BKO-C1968H02	2
	FR-F2-H45K-U and H55K-U	MY220W4KOHM BKO-C1968H03	2

(11) Surge suppressor (VAR)

Inverter type		Type	Quantity
200V class	FR-F2-750-U(750B-U) thru. 7.5K-U	TNR 23G471	3
	FR-F2-11K-U thru. 55K-U	BKO-C1915H02	1
460V class	FR-F2-H3700-U thru. H22K-U	BKO-C1972H01	1
	FR-F2-H30K-U thru. H55K-U	BKO-C1821H01	1

(12) Cooling fan

Inverter type		Type	Quantity
200V class	FR-F2-750(750B)-U thru. 3700-U	Not used	—
	FR-F2-5.5K-U	N3951MV BKO-C1792H01	1
	FR-F2-7.5K-U	N3951MV BKO-C1792H01	1
	FR-F2-11K-U	8550MVL BKO-C1942H01	2
	FR-F2-15K-U	8550MVL BKO-C1942H01	2
	FR-F2-22K-U	8550MVL BKO-C1942H01	4
	FR-F2-30K-U	N3951MV BKO-C1792H02 and HS4556MVL BKO-C1943H01	1 4
	FR-F2-37K-U	HS4556MVL BKO-C1943H01	2
	FR-F2-45K-U	HS4556MVL BKO-C1943H01	4
	FR-F2-55K-U	HS4556MVL BKO-C1943H01	4
460V class	FR-F2-H3700-U	Not used	—
	FR-F2-H5.5K-U	N3951MVL BKO-C1792H01	1
	FR-F2-H7.5K-U	N3951MVL BKO-C1792H01	1
	FR-F2-H11K-U	8550MVL BKO-C1942H01	2
	FR-F2-H15K-U	8550MVL BKO-C1942H01	2
	FR-F2-H22K-U	8550MVL BKO-C1942H02	4
	FR-F2-H30K-U	HS4556MVL BKO-C1943H01	4
	FR-F2-H37K-U	HS4556MVL BKO-C1943H01	4
	FR-F2-H45K-U	HS4556MVL BKO-C1943H01	4
	FR-F2-H55K-U	HS4556MVL BKO-C1943H01	4

18. SPARE PARTS

(13) Thermo-detector (Overheat detector, OHD)

This device is used for ventilated type inverters i.e. from FR-F2-5.5K up to FR-F2-55K and from FR-F2-H7.5K up to FR-F2-H55K.

SpecificationOHD-100B

Working quantity1

(14) Printed circuit board

	Inverter type	Type	Quantity
200V class	** FR-F2-750B-U	FRF2-MA12	1
	**FR-F2-1500B-U	FRF2-MA22	1
	FR-F2-750-U throu. 3700-U	FRF2-CB12	1
	FR-F2-5.5K-U and 7.5K-U	FRF2-CB32	1
	FR-F2-11K-U throu. 37K-U	FRF2-CB31 and FRF2-DR1	each 1
	FR-F2-45K-U throu. 55K-U	FRF2-CB31 and FRF2-DR2	each 1
460V class	FR-F2-H3700-U throu. H15K-U	FRF2-CB36	1
	FR-F2-H22K-U	FRF2-CB35 and FRF2-HDR1	each 1
	FR-F2-H30K-U throu. H55K-U	FRF2-CB35 and FRF2-HDR2	each 1

*Note (**): The character "B" of FRF2-CB means the version of the control card and the new version has the compatibility with old one.*

EX. FRF2-CA12 and FRF2-CB12 are compatible.

19. DRAWINGS

19.1 FR-F2-750B-U and 1500B-U

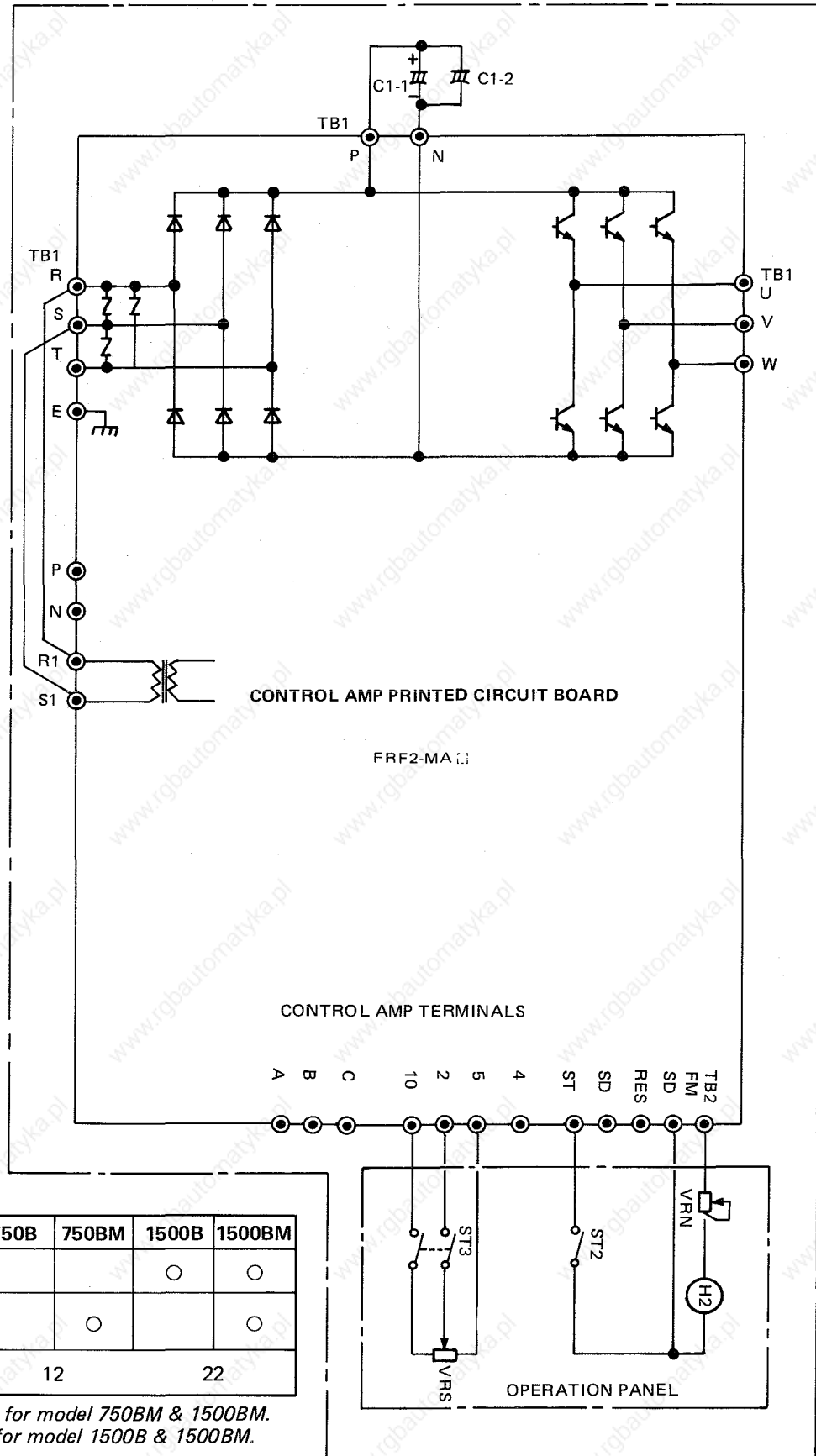

NOTE:

	750B	750BM	1500B	1500BM
C1-2			○	○
OPERATION PANEL		○		○
FR-F2-MA	12		22	

- Operation panel for model 750BM & 1500BM.
- Capacitor C1-2 for model 1500B & 1500BM.

19

19.2 FR-F2-750-U throu. FR-F2-3700-U

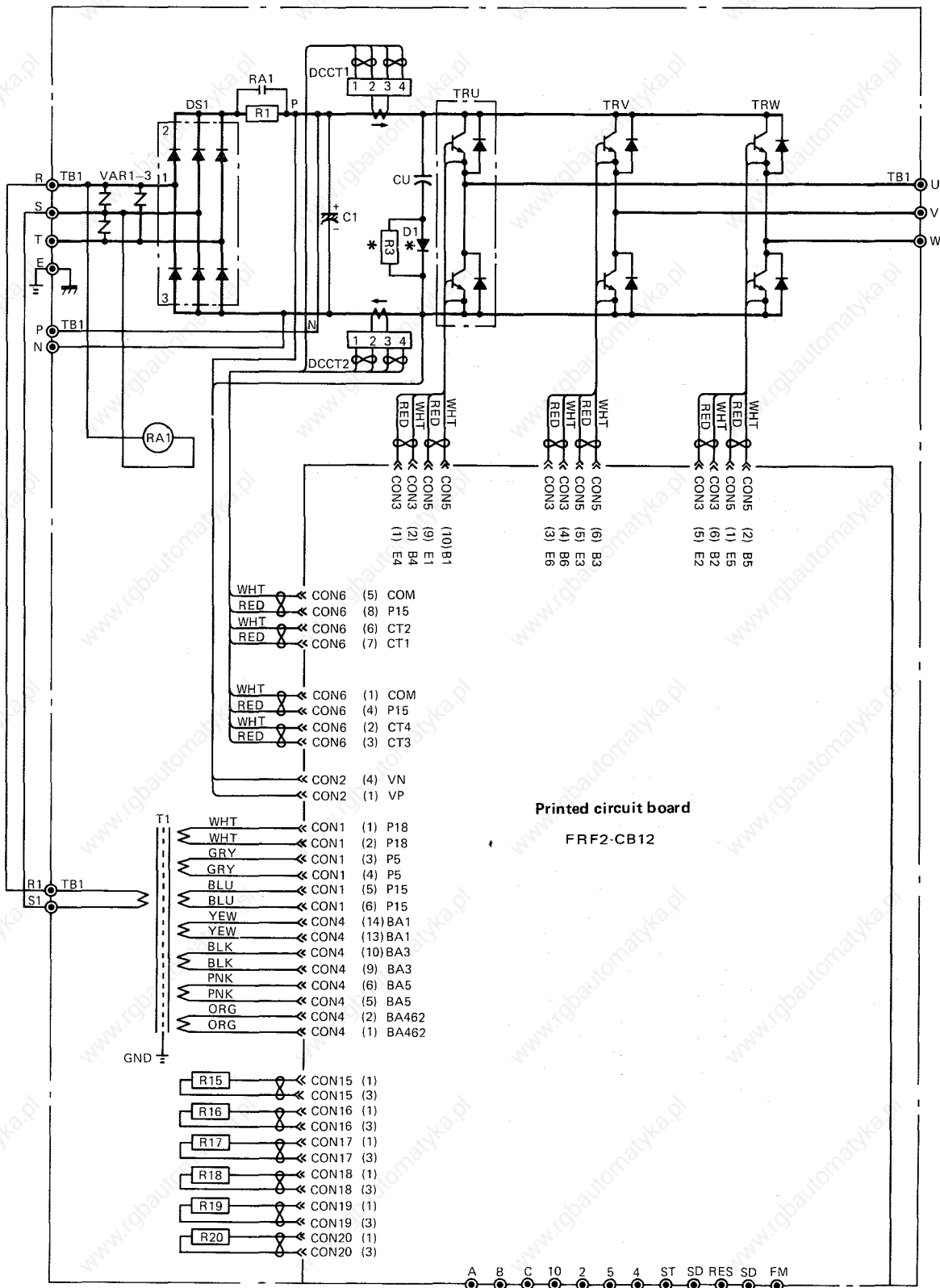

Note: Parts marked by * are provided only for FR-F2-750-U.

19.3 FR-F2-5.5K-U and FR-F2-7.5K-U

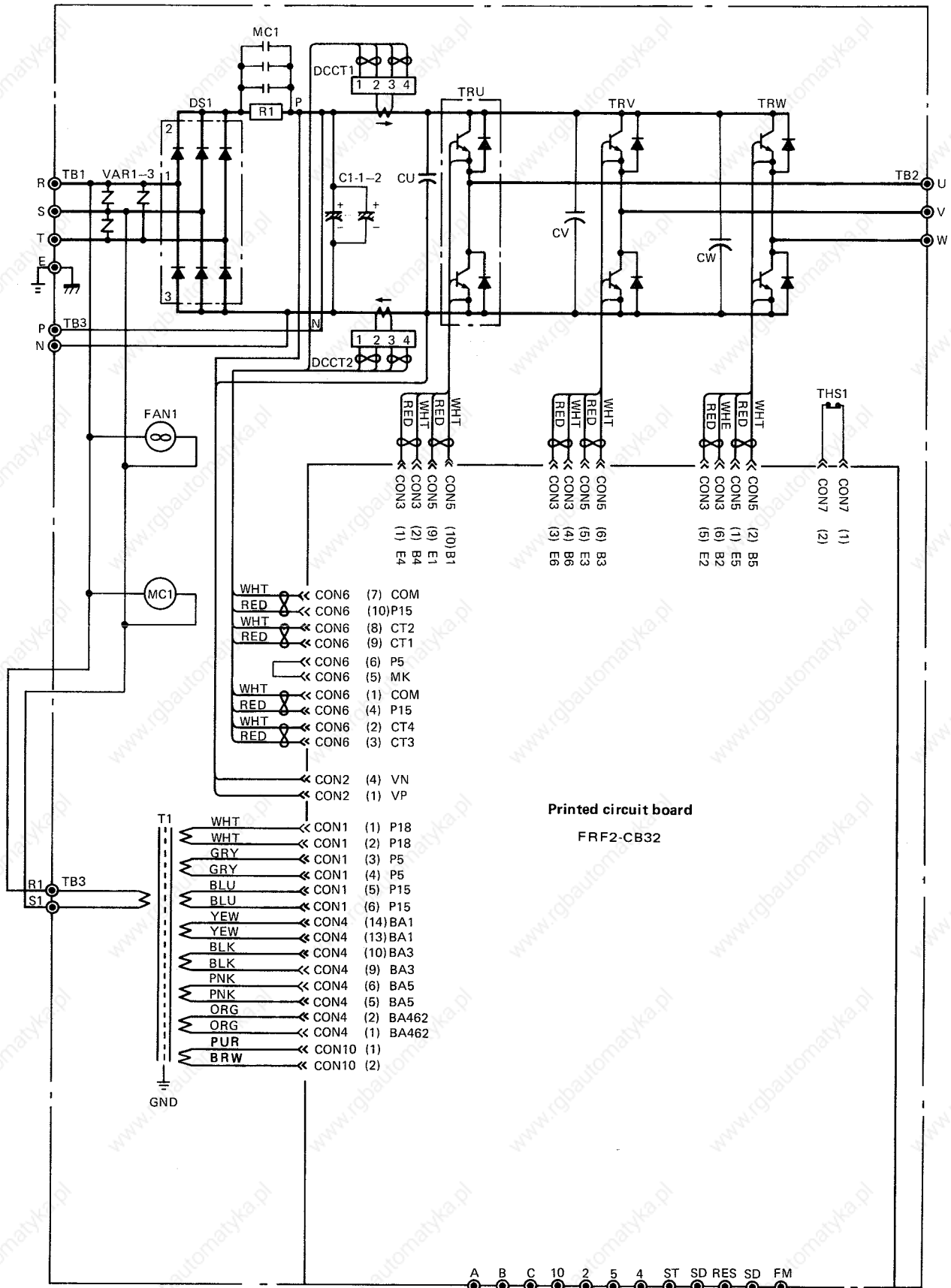

19.4 FR-F2-11K-U throu. FR-F2-30K-U

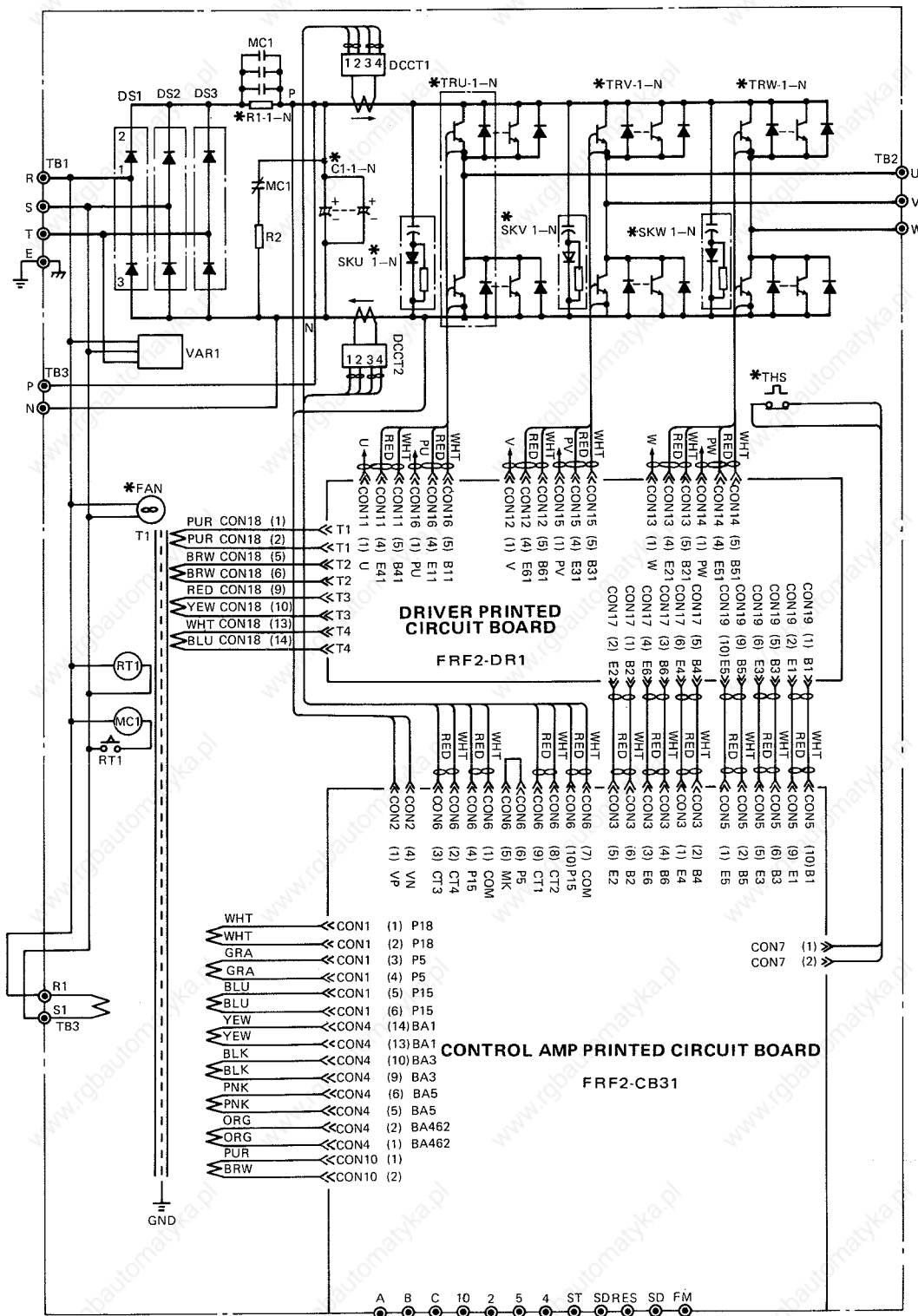

Note: Number of parts used for marked by * are

	TR	C1	R1	SK	FAN	THS
11K	1	2P	1	4P	2P	1
15K	2P	3P	2S	6P	2P	1
22K	2P	2P	2S	9P	4P	1
30K	3P	6P	2S2P	12P	5P	2S

P: Parallel
S: Series

19.5 FR-F2-37K-U

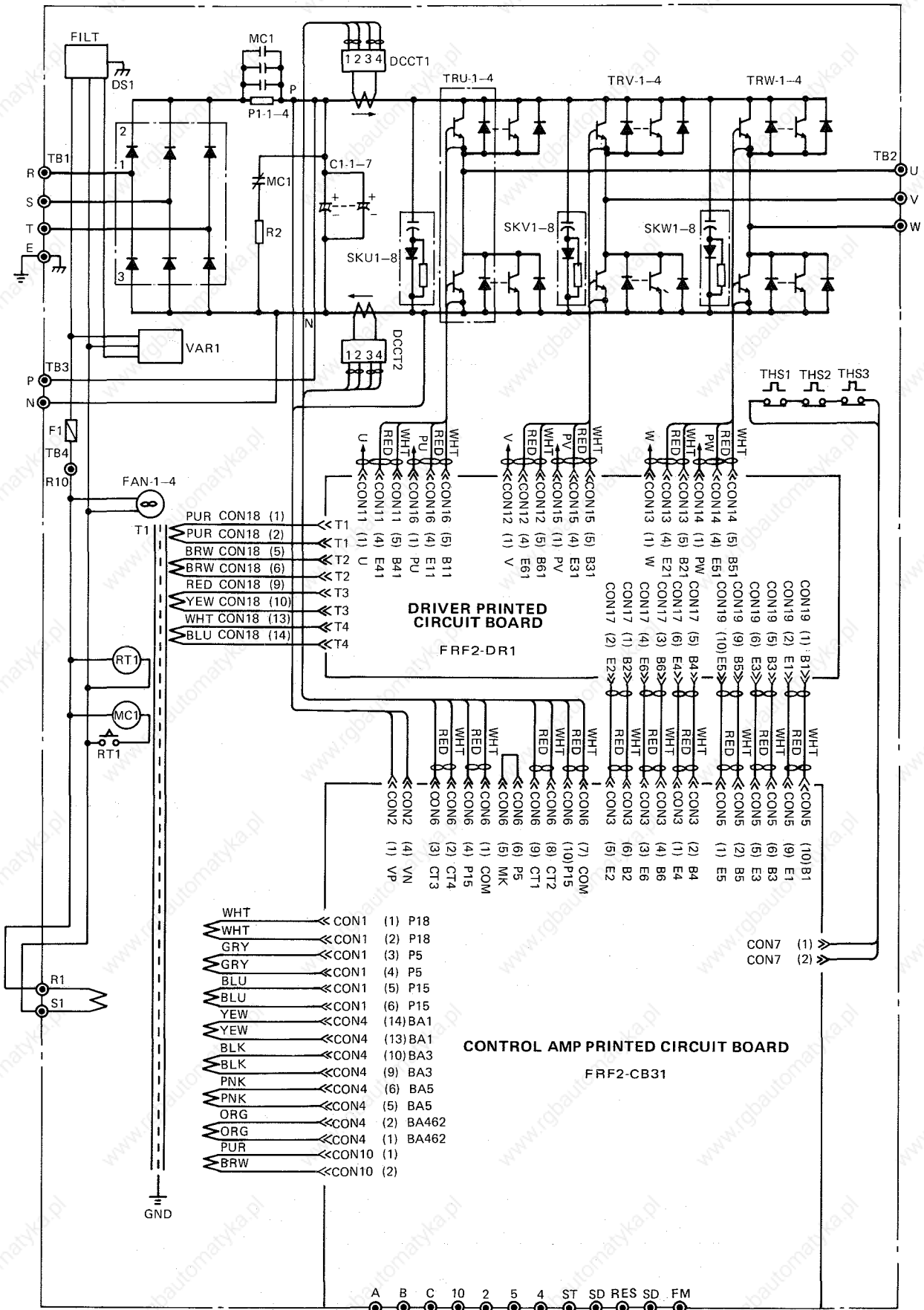

19.6 FR-F2-45K-U and FR-F2-55K-U

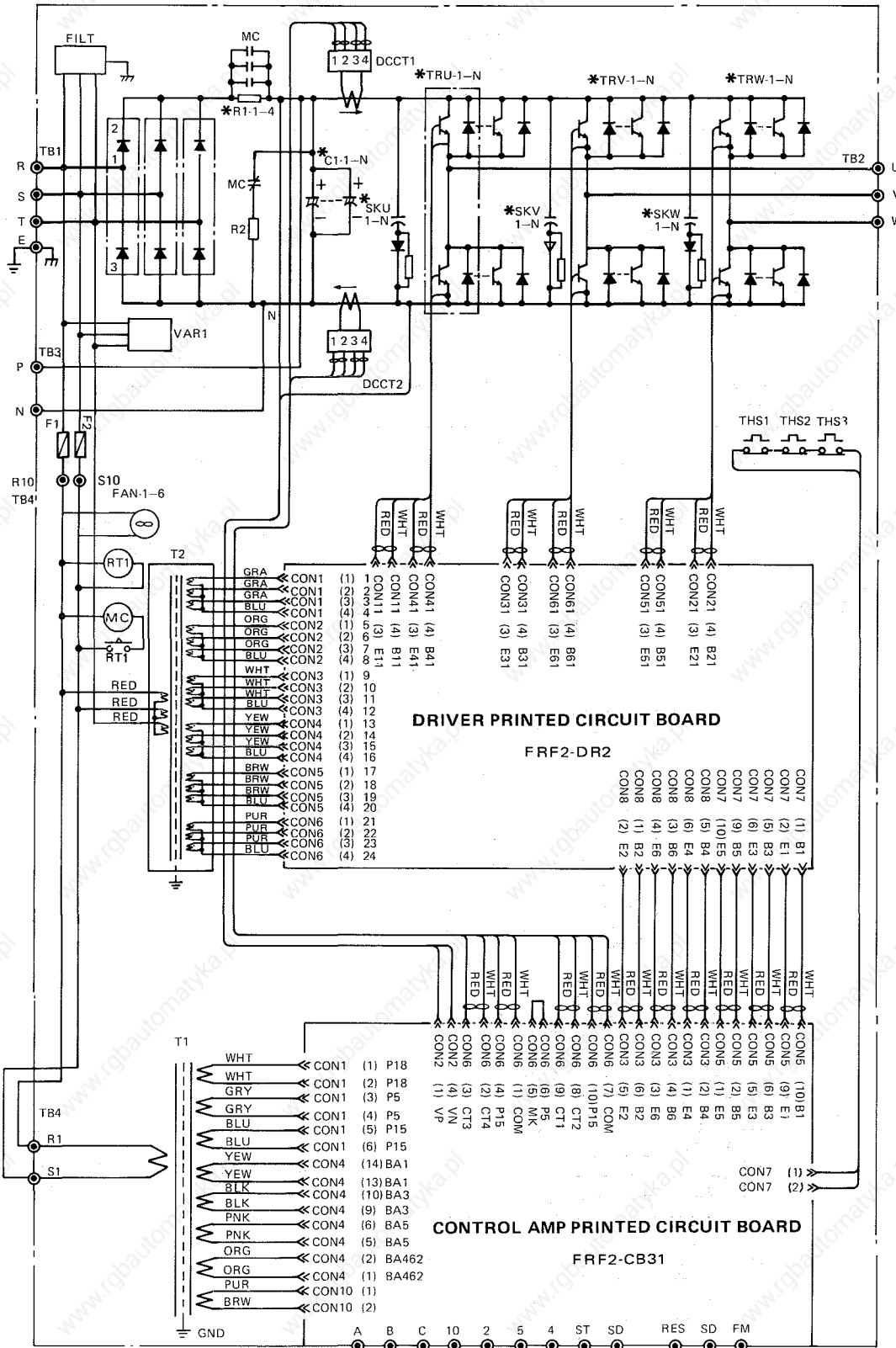

Note: Number of parts marked by * are

	TR	C1	SK	R1
45K	3P	8P	30	2S2P
55K	4P	10P	36	2S2P

P: Parallel
S: Series

19.7 FR-F2-H3700-U thru. FR-F2-H7.5K-U

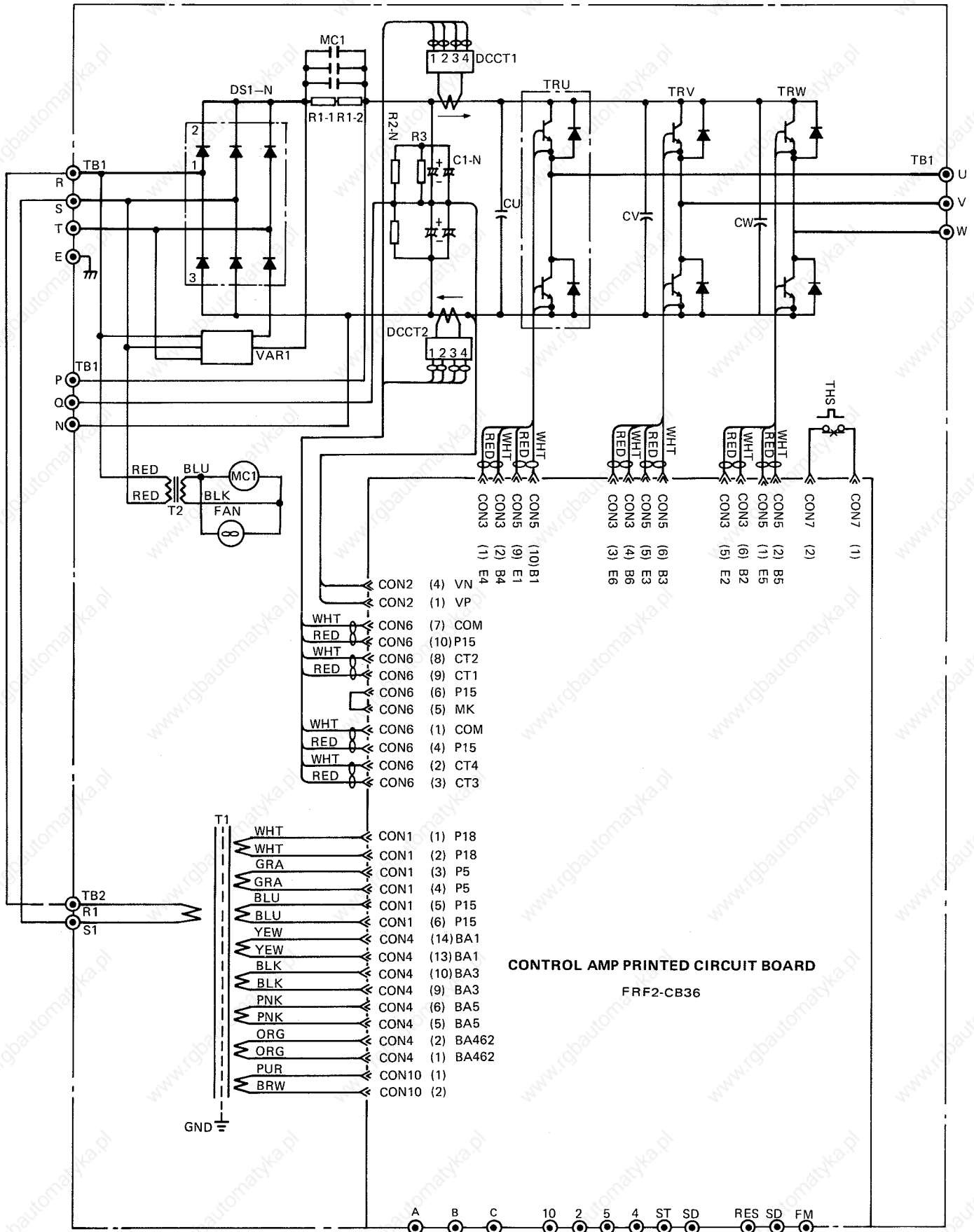

19.8 FR-F2-H11K-U and FR-F2-H15K-U

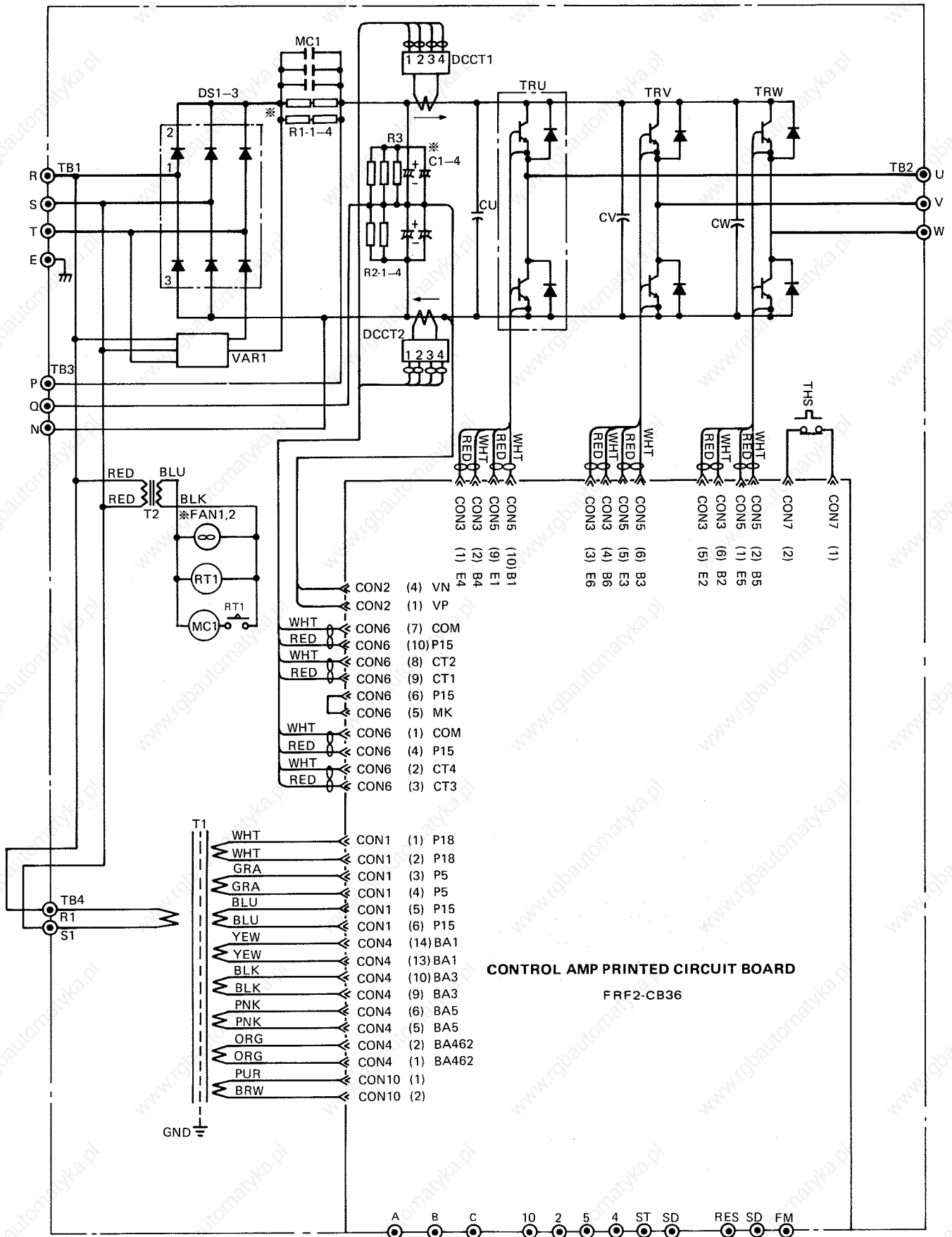

19.9 FR-F2-H22K-U

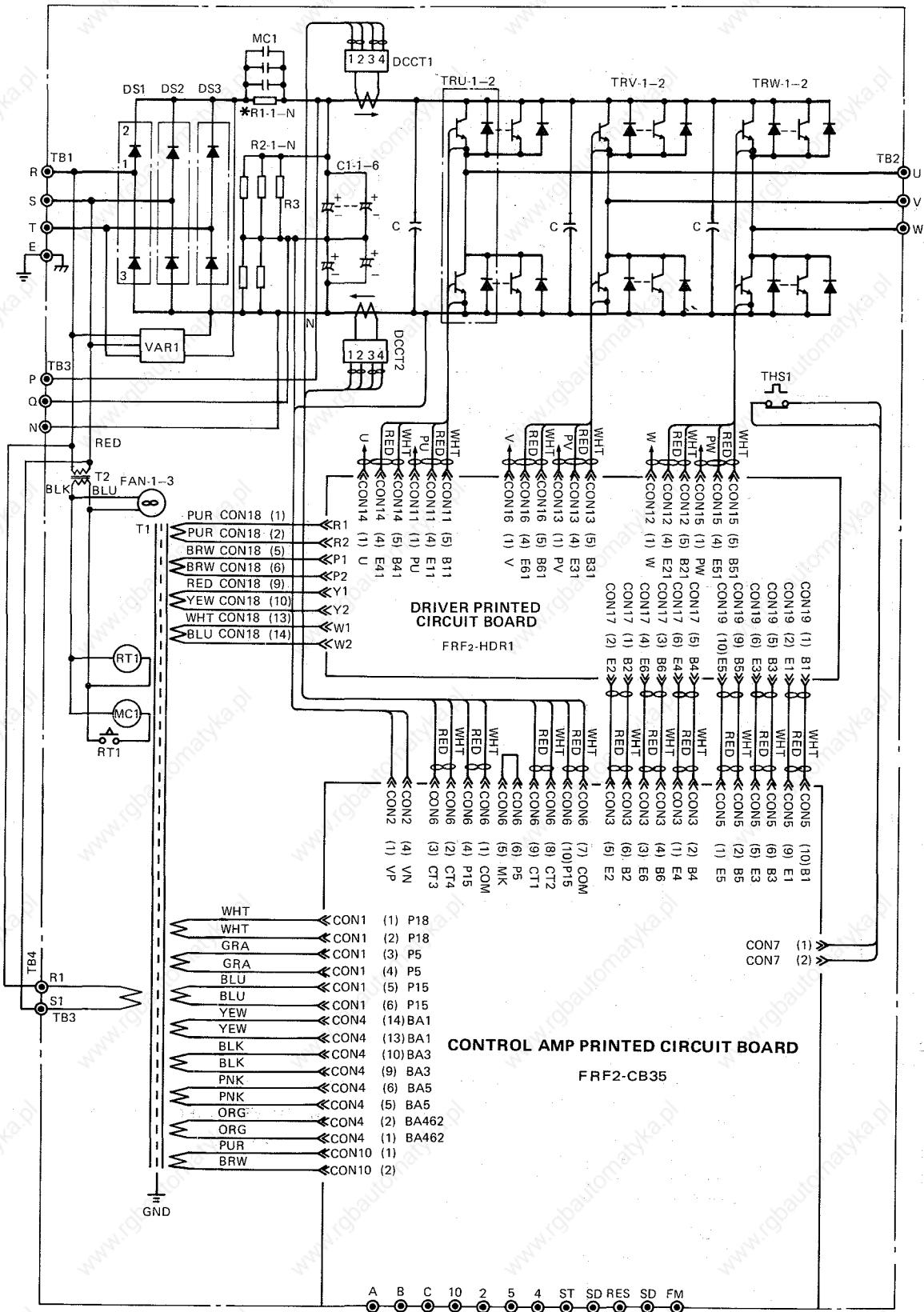

NOTE: Number of used parts marked by * are,

TR	C1	R1	R2	C
2P	2S3P	4S	3S3P	6P

P: Parallel
S: Series

19.10 FR-F2-H30K-U throu. FR-F2-H55K-U

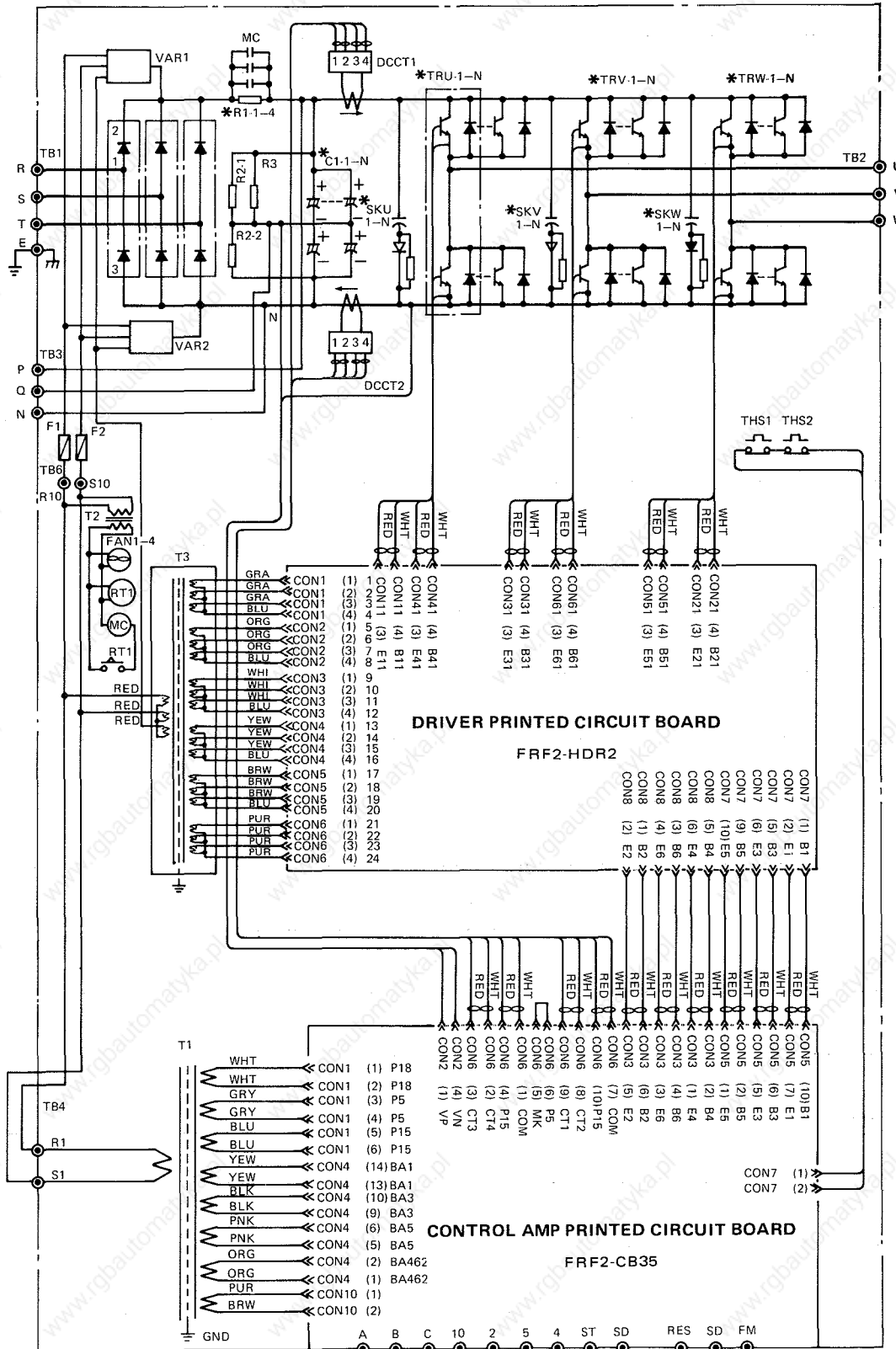

Note: Number of Parts marked by * are

	TR	C1	SK	R1
30, 37kw	2P	2S4P	4	4S
45, 55kw	3P	2S5P	6	4S

P: Parallel
S: Series

MEMO

A series of horizontal dashed lines for writing.

www.rgbautomatyka.pl



MITSUBISHI ELECTRIC CORPORATION

HEAD OFFICE: MITSUBISHI DENKI BLDG. MARUNOUCHI, TOKYO 100, TELEX: J24532, CABLE: MELGO, TOKYO
NAGOYA WORKS: 1-14, YADA-MINAMI 5, HIGASHI-KU, NAGOYA, JAPAN