

Dimensions

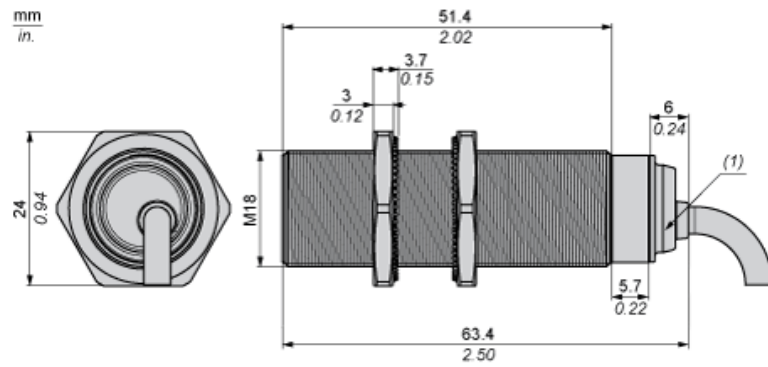

(1) LED

Minimum Mounting Distances

Side by side



$e (1) \geq 6 \text{ mm} / 0.63 \text{ in.}$

Face to face



$e (2) \geq 100 \text{ mm} / 3.94 \text{ in.}$

Facing a metal object



$e (3) \geq 25 \text{ mm} / 0.98 \text{ in.}$