

## Technical Documentation

---



AC synchronous servomotors

**SER3xx / RIG3xx**

Order no.: 0098 441 113 218

Edition: V1.02 09.2004

Berger Lahr GmbH & Co. KG  
Breslauer Str. 7  
D-77933 Lahr

## Important information

The drive systems described here are products for general use that conform to the state of the art in technology and are designed to prevent any dangers. However, drives and drive controllers that are not specifically designed for safety functions are not approved for applications where the functioning of the drive could endanger persons. The possibility of unexpected or unbraked movements can never be totally excluded without additional safety equipment. For this reason personnel must never be in the danger zone of the drives unless additional suitable safety equipment prevents any personal danger. This applies to operation of the machine during production and also to all service and maintenance work on drives and the machine. The machine design must ensure personal safety. Suitable measures for prevention of property damage are also required.

For more information see the chapter on safety.

Not all product types are available in all countries. Please see the current catalogue for the availability of products.

We reserve the right to make technical changes.

All information refers to specifications and not to assured properties.

Most product designations are registered trademarks of their proprietors, even when not specifically noted.

## Table of Contents

<b>Important information</b> .....	<b>-2</b>
<b>Table of Contents</b> .....	<b>-3</b>
<b>Writing conventions and symbols</b> .....	<b>-5</b>
<b>1 Introduction</b>	
1.1 Motor families .....	1-1
1.2 Motor overview: SER3xx and RIG3xx servomotors ..	1-3
1.3 Options, accessories and wiring .....	1-3
1.4 Type code overview and name plate .....	1-4
1.5 Directives and standards .....	1-6
1.6 Declaration of conformity .....	1-7
<b>2 Safety</b>	
2.1 Qualification of personnel .....	2-1
2.2 Intended use .....	2-1
2.3 Hazard categories .....	2-2
2.4 Safety instructions .....	2-3
<b>3 Technical Data</b>	
3.1 SER3xx .....	3-1
3.1.1 SER3xx general .....	3-1
3.1.2 SER36x .....	3-5
3.1.3 SER39x .....	3-19
3.1.4 SER311x .....	3-33
3.2 RIG3xx .....	3-46
3.2.1 RIG3xx general .....	3-46
3.2.2 RIG39x .....	3-50
3.2.3 RIG311x .....	3-61
3.3 PLE and PLS gearbox .....	3-72
3.3.1 PLE gearbox .....	3-73
3.3.2 PLS gearbox .....	3-75
3.3.3 Gearbox models .....	3-77
<b>4 Installation</b>	
4.1 Before assembly .....	4-2
4.2 Installation of the motor .....	4-2
4.3 Electrical installation .....	4-5
4.3.1 Connecting the motor .....	4-5
4.3.2 Electrical control of the holding brake .....	4-6

---

4.4	Plugs and plug assignments . . . . .	4-8
4.4.1	Calculation of the plug insertion space . . . . .	4-12
<b>5</b>	<b>Commissioning</b>	
5.1	Preparing for commissioning . . . . .	5-1
5.2	Running commissioning . . . . .	5-2
<b>6</b>	<b>Diagnostics and troubleshooting</b>	
6.1	Mechanical faults . . . . .	6-1
6.2	Electrical faults . . . . .	6-1
<b>7</b>	<b>Service, maintenance and disposal</b>	
7.1	Service address . . . . .	7-1
7.2	Maintenance . . . . .	7-2
<b>8</b>	<b>Glossaries</b>	
8.1	Terms and Abbreviations . . . . .	8-1
<b>9</b>	<b>Index</b>	

## Writing conventions and symbols

### *Work steps*

If work steps must be carried out in sequence, they are shown as follows:

- Special prerequisites for the following work steps
- ▶ Step 1
- ◁ Important response to this work step
- ▶ Step 2

If a response to a work step is specified, this will inform you that the step has been carried out correctly.

Unless otherwise stated, the individual instruction steps must be carried in the given sequence.

### *Lists*

Lists can be sorted alphanumerically or by priority. Lists are structured as follows:

- Point 1
- Point 2
  - Subpoint to 2
  - Subpoint to 2
- Point 3

### *Making work easier*



Information on making work easier can be found at this symbol:

*This offers supplementary information on making work easier.*

*See the chapter on safety for an explanation of the safety instructions.*



# 1 Introduction

## 1.1 Motor families

We offer market-oriented positioning and automation solutions based on proven production products. The well-designed combination of motor, with gearbox if applicable, and the drive electronics offers the optimum solution for virtually every dynamic motion task up to 8 kW.

This takes into account that in modern drive technology the demands on systems are becoming higher and higher. This includes particularly:

- Positioning accuracy
- Speed accuracy
- Constant torque
- Control range
- Dynamics
- Overload capacity
- Availability

There are also different motor series available for different applications. Not all motor types are available with all output controllers.

### SER3xx AC synchronous servomotors

Our AC synchronous servomotors have a very high power density and enable highly dynamic positioning drives at a particularly economical price-power ratio.

Our servomotors are compatible to the standard servo connection dimensions for flexible solutions of problems. The AC synchronous servomotors are fitted with an absolute sensor system as standard equipment, the SinCos® (SRS) Singleturn. When using the Hiperface® interface between motor-sensor system and device the motor and current controller parameters are internally initialised. This greatly simplifies the commissioning procedure.

An AC synchronous servomotor module consists of the AC synchronous servomotor and the associated controller. Optimum power can only be reached when motor and controller are optimally matched.

*Features* Our AC synchronous servomotors are characterised by:

- **High power density** with the use of the latest magnetic materials and optimised motor design concept. Motors are shorter with comparable torques.
- **High pulse torques**, maximum up to four times continuous standstill torque.
- **Economical**, with a strong standard series we can offer a compact and powerful AC synchronous servomotor.

**AC synchronous servomotors with integrated RIG3xx gearbox**

Our RIG3xx AC synchronous servomotors have virtually the same properties as the SER3xx AC synchronous servomotors. In this series of motors a gearbox with a ratio of 4:1 is integrated into the drive. As a result of this integration the RIG motors are only slightly longer than the SER motors without gearbox and are significantly shorter than SER motors with a flanged gearbox. This is because part of the gearbox is actually in the drive and so it is more than just leaving out a flange cover.

**VRDM3xx 3-phase stepper motors**

Our 3-phase stepper motors are extremely robust, maintenance-free drives. They carry out stepper motions which are controlled by a positioning controller.

The 3-phase stepper motors can be operated at very high resolution depending on the controller electronics, e.g. 19200 steps per revolution are possible with our controllers.

Options such as speed monitoring and holding brake with robust, low-play planetary gearboxes extend the application options.

*Features* Our 3-phase stepper motors are:

- **Strong**, the optimised internal geometry of the motor offers a high power density; i.e. up to 50% greater torque compared to conventional stepper motors of comparable size.
- **Quiet**, the sinus commutation of the Twin Line power electronics and the special mechanical design give a very quiet and virtually resonance-free stepper motor.
- **Economical** with the higher power density, simpler wiring and compact Twin Line power electronics.

**For a detailed description of the stepper motors see the separate documentation.**



## 1.2 Motor overview: SER3xx and RIG3xx servomotors

Short overview: Motor data

Type	$M_{d0}$ Nm	$M_{Pd_{max}}$ Nm	$P_{d_{max}}$ kW	$M_{max}$ Nm
SER36x	0.32 - 0.90	0.28 - 0.50	0.35 - 0.63	1.3 - 3.6
SER39x	1.1 - 3.6	0.6 - 1.8	0.38 - 0.85	4.0 - 14.5
SER311x	4.5 - 13.4	2.3 - 6.7	1.06 - 2.25	18.0 - 48.0
RIG39x	4.3 - 11.25	2.3-6.6	0.37-1.03	15.5 - 22.0
RIG311x	17.8 - 38.8	8.1-19.4	1.0-2.03	70 - 76

$M_{d0}$  = continuous torque

$M_{Pd_{max}}$  = torque at max. continuous power

$P_{d_{max}}$  = max. continuous power

$M_{max}$  = max. torque

## 1.3 Options, accessories and wiring

Our motors are optionally available with:

- various sensor systems
- holding brake
- angled and rotatable plug connectors
- various protection classes

For the options see the technical data in the various motor descriptions.

The following accessories are available:

- controller for holding brake
- wiring

Fully finished motor and sensor system wiring precisely designed for our drive systems ensures that motor and power amplifier are perfectly connected.

## 1.4 Type code overview and name plate

The type code is explained below. The type code is shown with all delivery options for the specific motor size for every motor size.

Example:	<b>SER 3 X X / 3 L 3 S M O T O IP41 X X X XX XXX</b>
Motor type: SER or RIG	<b>SER</b> 3 X X / 3 L 3 S M O T O IP41 X X X XX XXX
Phase count	SER <b>3</b> X X / 3 L 3 S M O T O IP41 X X X XX XXX
Size (flange)	SER 3 <b>X X</b> / 3 L 3 S M O T O IP41 X X X XX XXX
Length:	SER 3 X <b>X</b> / 3 L 3 S M O T O IP41 X X X XX XXX
Pole pair count:	SER 3 X X / <b>3</b> L 3 S M O T O IP41 X X X XX XXX
Moment of inertia of rotor:	SER 3 X X / 3 <b>L</b> 3 S M O T O IP41 X X X XX XXX
Winding identification:	SER 3 X X / 3 L <b>3</b> S M O T O IP41 X X X XX XXX
Winding circuit:	SER 3 X X / 3 L 3 <b>S</b> M O T O IP41 X X X XX XXX
Sensor system:	SER 3 X X / 3 L 3 S <b>M</b> O T O IP41 X X X XX XXX
Sensor system resolution:	SER 3 X X / 3 L 3 S M <b>O</b> T O IP41 X X X XX XXX
Plug connector:	SER 3 X X / 3 L 3 S M O <b>T</b> O IP41 X X X XX XXX
Holding brake:	SER 3 X X / 3 L 3 S M O T <b>O</b> IP41 X X X XX XXX
Protection class:	SER 3 X X / 3 L 3 S M O T O <b>IP41</b> X X X XX XXX
Gearbox type:	SER 3 X X / 3 L 3 S M O T O IP41 <b>X</b> X X XX XXX
Gear ratio:	SER 3 X X / 3 L 3 S M O T O IP41 X <b>X</b> X XX XXX
Motor shaft design:	SER 3 X X / 3 L 3 S M O T O IP41 X X <b>X</b> XX XXX
Centring collar:	SER 3 X X / 3 L 3 S M O T O IP41 X X X <b>XX</b> XXX
Temperature sensor:	SER 3 X X / 3 L 3 S M O T O IP41 X X X XX <b>XXX</b>

Explanation of name plate The name plate shows the most important motor data:

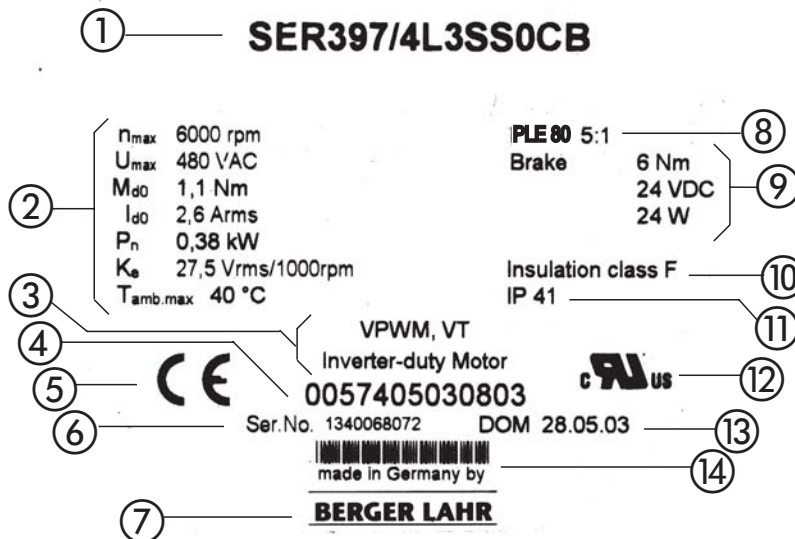

Number		Meaning
1	SER3...	Motor type, see type code
2	$n_{max}$ $U_{max}$ $M_{d0}$ $I_{d0}$ $P_n$ $K_e$ $T_{amb,max}$	max. speed r.m.s. value of converter voltage nominal torque at standstill nominal current at standstill nominal power voltage constant maximum ambient temperature
3	VPWM VT Inverter-duty motor	variable PWM variable torque motor for converter operation only
4		order no.
5	CE	CE mark
6	Ser.No.	serial number
7	BERGER LAHR	manufacturer's name and logo
8	PLx	gearbox type and gear ratio
9	Brake	information on brake: - holding torque - nominal voltage - power consumption
10	Insulation Class F	temperature class
11	IP 41	protection class by case
12	cUR	cUR mark
13	DOM	date of manufacture
14	Barcode	barcode

## 1.5 Directives and standards

The EC directives define the minimum requirements - particularly safety requirements - applicable to a product and must be complied with by all manufacturers and dealers marketing the product in the member states of the European Union (EU).

The EC directives describe the main requirements for a product. The technical details are laid down in the harmonized standards, which are published in Germany as the DIN EN standards. If there is not yet any EN standard applicable to a particular product area, existing technical standards and regulations will apply.

*CE mark* With the declaration of conformity and the CE mark on the product the manufacturer certifies that the product complies with the requirements of all relevant EC directives. The drive systems described here can be used anywhere in the world.

*EC Machine Directive* The drive systems described here are not machines as defined by the EC Machine Directive (89/392/EEC) but components for installation in machines. They do not have moving parts designed for specific purposes. However, they can be components of a machine or system.

The manufacturer must certify that the complete system conforms to the machine directive with the CE mark.

*EC EMC Directive* The EC Electromagnetic Compatibility Directives (89/336/EEC) applies to products that cause electromagnetic interference or whose operation may be adversely affected by electromagnetic interference.

Conformity with the EMC Directive can only be expected of our drive systems after correct installation in the machine. The information on ensuring electromagnetic compatibility given in the chapter on "Installation" must be followed to ensure that the drive system in the machine or system is EMC-compatible and that the product can legally be operated.

*EC Low-Voltage Directive* The EC Low-Voltage Directive (73/23/EEC) lays down safety requirements for 'electrical apparatus' as protection against the risks that can originate in such devices and can be created in response to external influences.

The drive systems described here comply with the EN 50178 Standard as per the Low-Voltage Directive.

*Standards for safe operation of our drive systems* DIN 332-2: Centre hole, 60° with thread

DIN 6885: Parallel keys, grooves

DIN 42955: Concentricity of shaft ends

DIN EN 50178: Fitting power systems with electronic equipment

DIN EN 50347: Centring diameter, hole circle, fastening screws

DIN EN 60034-ff: Rotating electrical machines

DIN EN 60068-2-ff: Environmental tests

DIN EN 60664: Insulation coordination

UL1004: Motor classification under UL

1.6 Declaration of conformity

<p><b>EC Declaration of Conformity</b> <b>Year 2004</b></p>		<p><b>BERGER LAHR</b></p> <p>BERGER LAHR GmbH &amp; Co.KG Breslauer Str. 7 D-77933 Lahr</p>
<p><input type="checkbox"/> according to EC Directive on Machinery 98/37/EEC  <input type="checkbox"/> according to EC Directive EMC 89/336/EEC  <input checked="" type="checkbox"/> according to EC Directive Low Voltage 73/23/EEC                  The above mentioned directives have been changed by CE Marking Directive 93/68/EEC</p>		
<p>We declare that the products listed below meet the requirements of the mentioned EC Directives with respect to design, construction and version distributed by us. This declaration becomes invalid with any modification on the products not authorized by us.</p>		
Designation:		3 Phase Servo Motor with/without integrated gear
Type:		SER3xxx/xL, RIG3xx/4L
Product number:		0x54xxxxxxxx, 0x55xxxxxxxx, 0x56xxxxxxxx, 0x57xxxxxxxx 0x58xxxxxxxx
Applied harmonized standards, especially:	EN 60034-1:2000 EN 60034-5:2001 EN 60664-1:2003 EN 60664-3:2003	Temperature class F Protection class according product documentation Insulation Insulation
Applied national standards and technical specifications, especially:	UL 1004 the valid product documentation	
<p style="text-align: center;"><b>Berger Lahr GmbH &amp; Co. KG</b></p> <p>Company stamp: Postfach 11 80 · D-77901 Lahr Breslauer Str. 7 · D-77933 Lahr</p>		
Date/ Signature:	16 February 2004	
Name/ Department:		Wolfgang Brandstätter/R & D

0098 441 113 218, V1.02, 09.2004



## 2 Safety

### 2.1 Qualification of personnel

Commissioning, operation and maintenance must be conducted by trained electrical and controller technicians only.

The technicians must be familiar with the contents of all technical documentation relevant to this product.

The technicians must have sufficient training, knowledge and experience to recognise and avoid dangers.

The technicians must be familiar with the relevant standards, regulations and safety regulations that must be observed during installation, operation and maintenance of the product.

### 2.2 Intended use

The drive systems described here are products for general use that conform to the state of the art in technology and are designed to prevent any dangers. However, drives and drive controllers that are not specifically designed for safety functions are not approved for applications where the functioning of the drive could endanger persons. The possibility of unexpected or unbraked movements can never be totally excluded without additional safety equipment. For this reason personnel must never be in the danger zone of the drives unless additional suitable safety equipment prevents any personal danger. This applies to operation of the machine during production and also to all service and maintenance work on drives and the machine. The machine design must ensure personal safety. Suitable measures for prevention of property damage are also required.

In the system configuration described the drive systems must be used in industrial applications only and must have a fixed connection only.

In all cases the applicable safety regulations and the specified operating conditions, such as environmental conditions and specified technical data, must be observed.

The drive systems may be commissioned and operated only after installation in accordance with EMC requirements and the product-specific specifications.

To prevent personal injury and damage to property damaged drive systems must not be installed or operated.

Changes and modifications of the drive systems are not permitted and if made all no warranty and liability will be accepted.

The drive system must be operated only with the specified wiring and approved accessories. In general, use only original accessories and spare parts.

The drive systems must not be operated in an environment subject to explosion hazard (ex area).

## 2.3 Hazard categories

Safety notes and general information are indicated by hazard messages in the manual. In addition there are symbols and instructions affixed to the product that warn of possible hazards and help to operate the product safely.

Depending on the seriousness of the hazard, the messages are divided into three hazard categories.



### **DANGER!**

DANGER indicates an imminently hazardous situation, which, if not avoided, **will result** in death, serious injury, or equipment damage.



### **WARNING!**

WARNING indicates a potentially hazardous situation, which, if not avoided, **can result** in death, serious injury, or equipment damage.



### **CAUTION!**

CAUTION indicates a potentially hazardous situation, which, if not avoided, **can result** in injury or equipment damage.



## 2.4 Safety instructions



### **DANGER!**

#### **Electric shock, fire or explosion**

- Only technicians who are familiar with and understand the contents of this manual and the other relevant manuals are authorized to work on and with this drive system.
- Before working on the drive system:
  - Switch off power to all terminals.
  - Place a sign "DO NOT SWITCH ON" on the switch and lock to prevent its being switched on.
  - Allow the DC bus capacitors to discharge (see power amplifier manual).
  - Check that there is no power.
- Do not short-circuit DC bus or touch unshielded components or screws of the terminals under voltage.
- Install all covers and close the housing doors before applying power.
- The motor generates voltage when the shaft is rotated. Lock the shaft of the motor to prevent rotation before starting work on the drive system.
- AC voltages may jump over unused wires in the motor cable. Isolate unused wires at both ends of the motor cable.
- The system manufacturer is responsible for compliance with all applicable regulations relevant to earthing the drive system. Extend the earth through the motor cable with an additional earth at the motor housing.



### 3 Technical Data

The following pages contain information on our SER3xx and RIG3xx motor families and an overview of gearboxes.

#### 3.1 SER3xx

##### 3.1.1 SER3xx general

The motors of the SER3xx series are 6-pole or 8-pole AC synchronous servomotors.

They are distinguished by:

- high power density
- integrated thermal winding monitoring
- insulation test voltage in accordance with DIN EN 60034-1 (IEC 60034-1)
- temperature class F in accordance with DIN EN 60034-1 (IEC 60034-1)
- vibration grade R in accordance with DIN EN 60034-14 (IEC 60034-14)
- shaft eccentricity and axial precision in accordance with DIN 42955 N (IEC 60072-1)
- colour: black RAL 9005

*Environmental influences: ambient operating climate*

Temperature (t)	-20°C to +40°C
Humidity	75%rh annual average 95%rh on 30 days (non-condensing)

*Environmental influences: ambient climate for transport and storage*

The motors must be in a dry, dust-free and vibration-free environment during transport and storage. The storage and transport temperature must remain in the range given below; in case of doubt the storage area must be air-conditioned.

The storage period is primarily determined by the durability of the lubricants in the warehouses and should be less than 36 months. Occasional operation of the drive solution is recommended to ensure that it still operates.

Storage and transport temperature	-25°C to +70°C
-----------------------------------	----------------

*Service life* The service life of the motors when operated correctly is limited primarily by the bearing life.

The following operating conditions can in some cases significantly reduce the service life:

- Installation altitude above 1000 m over sea level
- Rotary movement exclusively within a fixed angle of 100°
- Operation under vibration stress greater than 20 m/s<sup>2</sup>
- Allowing sealing rings to run dry
- Wetting gaskets with aggressive media

*Maximum angular acceleration* The maximum angular acceleration must not exceed 200000 rad/sec<sup>2</sup> for motors of the SER3x series.

*IP protection* The motors meet the following IP protection accordance with DIN EN 60034-5:

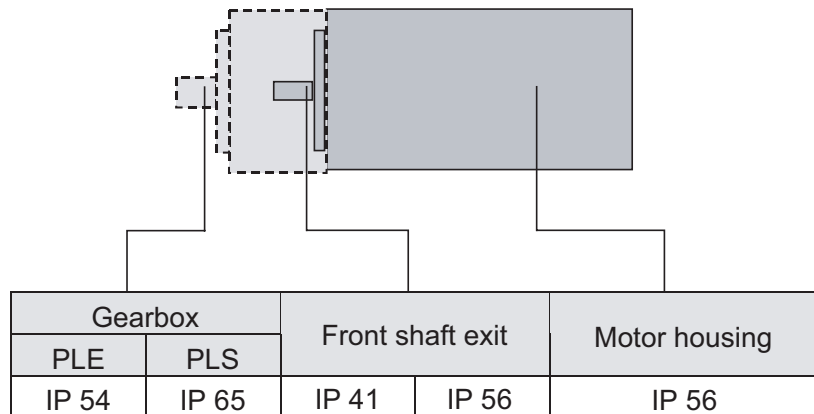

The motors can also optionally be fitted with a radial shaft seal to place them in protection class IP56. However, this restricts the maximum speed to 6000 min<sup>-1</sup>. With installation position IM V3 (drive shaft vertical, shaft end up) only protection class IP41 is guaranteed.

*Note the following:*



- The radial shaft sealing ring is prelubricated.
- Allowing the seals to run dry increases friction and greatly reduces the service life of the sealing rings.

*Overview of IP protection*

<b>First digit</b>		<b>Second digit</b>	
<b>Protection against foreign bodies</b>		<b>Protection against water</b>	
0	no protection	0	no protection
1	foreign body > 50mm	1	vertically falling drops
2	foreign body > 12mm	2	diagonally falling drops (75°-90°)
3	foreign body > 2.5mm	3	spray water
4	foreign body > 1mm	4	splashing water
5	dust-protected	5	jet water
6	dust-proof	6	heavy sea
		7	immersion
		8	continuous immersion

**3.1.1.1 Position capture (sensor)****Standard position capture***SinCos (SRS50) Singleturn*

This sensor system measures an absolute value within one revolution after being switched on and continues to count incrementally from this point.

Resolution	depends on controller
Measurement range absolute	1 revolution
Error limit of the digital absolute value depending on the controller	±1.5 minutes of arc
Precision of the incremental position evaluation	±0.75 minutes of arc
Pulse shape	sinus
Supply voltage	7-12V (8V recommended)
Supply current	max. 80mA (without load)

For more information see [www.stegmann.de](http://www.stegmann.de)

**Optional position capture**

As an alternative to the standard sensor system the motors can also be ordered with one of the following sensor systems:

*SinCos (SRM50) Multiturn*

This sensor system measures an absolute value within 4096 revolutions after being switched on and continues to count incrementally from this point.

Resolution	depends on controller
Measurement range absolute	4096 revolutions
Error limit of the digital absolute value depending on the controller	±1.5 minutes of arc
Precision of the incremental position evaluation	±0.75 minutes of arc
Pulse shape	sinus
Supply voltage	7-12V (8V recommended)
Supply current	max. 80mA (without load)

For more information see [www.stegmann.de](http://www.stegmann.de)

*Resolver*

This sensor system is very robust. Absolute position capture is possible within one revolution.

Resolution	depends on the controller
Measurement range absolute	1 revolution
Precision of the incremental position evaluation	±6 minutes of arc
Input voltage	7V <sub>eff</sub>
Input current	max. 38mA

*Digital encoder (DiCoder)*

This sensor system is an optical (incremental) system. It is only available for the SER39x and SER311x motor series, it is not available for SER36x.

Resolution	1024 and 4096 bars/revolution
Measurement range absolute	1 revolution
Precision	±2 minutes of arc
Signals	A, B, C, commutation
Pulse shape	rectangular
Supply voltage	5V ± 10%
Supply current	max. 50mA (without load)

For more information see [www.stegmann.de](http://www.stegmann.de)

## 3.1.2 SER36x

The 6-pole AC synchronous motors of the SER36x series are available in the SER364, SER366, SER368 and SER3610 models. The edge length of the flange is 57.2 mm. The table shows the motor-specific data:

Motor-specific data

Motor type			SER364	SER366	SER368	SER3610
<b>Nominal data</b>						
Nominal power	$P_N$	kW	0.35	0.55	0.6	0.63
Nominal speed <sup>1)</sup>	$n_N$	$\text{min}^{-1}$	12000	12000	12000	12000
Nominal continuous torque	$M_{dN}$	Nm	0.28	0.44	0.48	0.5
Continuous torque <sup>2)</sup>	$M_{d0}$	Nm	0.32	0.54	0.75	0.9
<b>Maximum values</b>						
Max. winding voltage	$U_{\max}$	$V_{AC}$	230	230	230	230
		$V_{DC}$	325	325	325	325
Max. voltage against PE		$V_{AC}$	300	300	300	300
Max. torque	$M_{\max}$	Nm	1.3	2.15	3.0	3.6
Max. allowable speed	$n_{\max}$	$\text{min}^{-1}$	12000	12000	12000	12000
Max. continuous power	$P_{d\max}$	kW	0.326	0.553	0.603	0.628
Torque at max. continuous power	$M_{Pd\max}$	Nm	0.28	0.44	0.48	0.5
Speed at max. continuous power	$n_{Pd\max}$	$\text{min}^{-1}$	12000	12000	12000	12000
<b>Mechanical values</b>						
Rotor moment of inertia	$J_R$	$\text{kgcm}^2$	0.1	0.18	0.26	0.34
Total length <sup>3)</sup>	L	mm	126	144	163	181
Mass <sup>3)</sup>	m	kg	1.1	1.4	1.7	2.0

1) for max. power

2) at 20 rpm; for  $n=0$  max. 89%

3) without holding brake

Measured values were determined on motor with flanges (steel plate 300\*300\*10mm); ambient temperature 25°C; no sealing ring on the drive shaft

Winding-specific data

Motor type	Winding <sup>1)</sup>	Continuous torque <sup>2)</sup>	Continuous current <sup>2)</sup>	Nominal continuous torque		Nominal continuous current		Nominal speed	Nominal power	Max. torque	Max. current <sup>3)</sup>	Voltage constant <sup>4)</sup>	Winding resistance	Winding inductivity	Winding inductivity
		$M_{d0}$	$I_{d0}$	$M_{dN}$	$I_{dN}$	$n_N$	$P_N$	$M_{max}$	$I_{max}$	$k_{EU\_V}$	$R_{U\_V}$	$L_{qU\_V}$	$L_{dU\_V}$		
		Nm	A <sub>rms</sub>	$U_N = 230\text{ V AC}$				Nm	A <sub>rms</sub>	V <sub>rms</sub>	Ohm	mH	mH		
				Nm	A <sub>rms</sub>	min <sup>-1</sup>	kW	Nm	A <sub>rms</sub>	V <sub>rms</sub>	Ohm	mH	mH		
SER364	3S	0.29	2.0	0.26	1.8	12000	0.32	1.3	11.5	9.1	4.7	9.2	7.9		
	5S	0.29	1.3	0.27	1.2	10000	0.28	1.3	7.3	13.5	11.1	21.8	19.2		
	7S	0.29	1.0	0.28	0.95	8000	0.23	1.3	5.7	18.0	18.9	37.9	33.4		
SER366	3S	0.54	2.75	0.44	2.3	12000	0.55	2.15	13.5	12.0	3.7	7.9	7.1		
	5S	0.54	1.8	0.46	1.5	9000	0.43	2.15	8.5	18.2	9.1	21.0	18.6		
	7S	0.54	1.25	0.49	1.2	6000	0.30	2.15	6	26.4	17.4	37.5	32.9		
SER368	3S	0.75	3.05	0.48	2.0	12000	0.60	3	15.3	14.9	3.4	7.6	6.7		
	5S	0.75	2.1	0.55	1.6	8500	0.49	3	10.5	21.7	7.3	15.9	14.0		
	7S	0.75	1.15	0.65	1.0	4300	0.29	3	6	39.0	23.7	53.0	46.7		
SER3610	3S	0.9	3.53	0.5	2.1	12000	0.62	3.6	17.5	15.4	2.7	6.0	5.2		
	5S	0.9	2.3	0.62	1.6	8000	0.51	3.6	11.5	23.8	6.1	14.0	12.5		
	7S	0.9	1.2	0.78	1.1	3700	0.30	3.6	6	46.4	23.0	54.0	47.0		

1) Definition of winding see type code

2) at 20 rpm; for n=0 max. 89%

3) SER364:max. 0.8sec; SER366:max.1.0sec; SER368:max. 1.2sec; SER3610:max. 1.4 sec.

4) r.m.s. value at 1000 rpm



Torque characteristic SER364

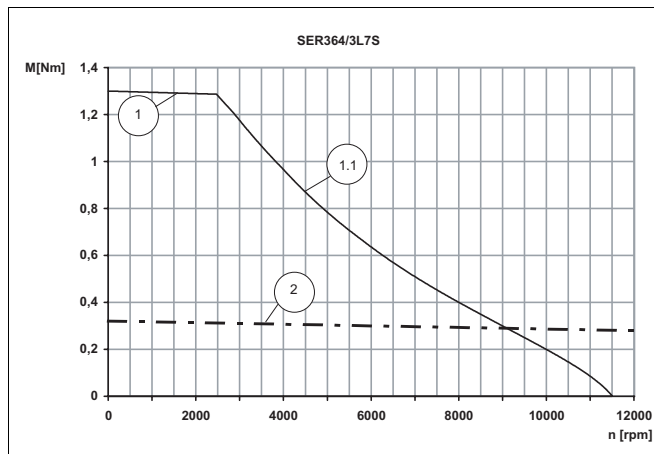
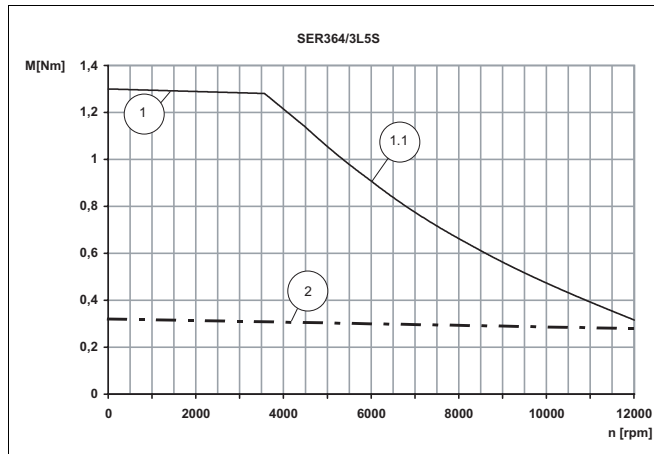
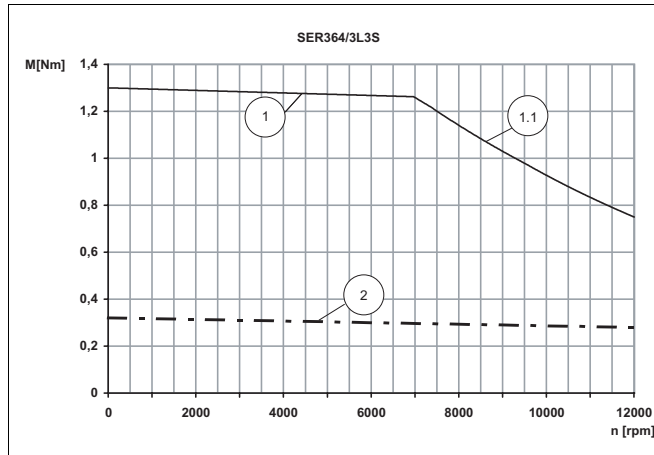

- 1 Peak motor torque
- 1.1 Speed limit at 230V<sub>eff</sub>
- 2 Continuous torque of motor

Torque characteristic SER366

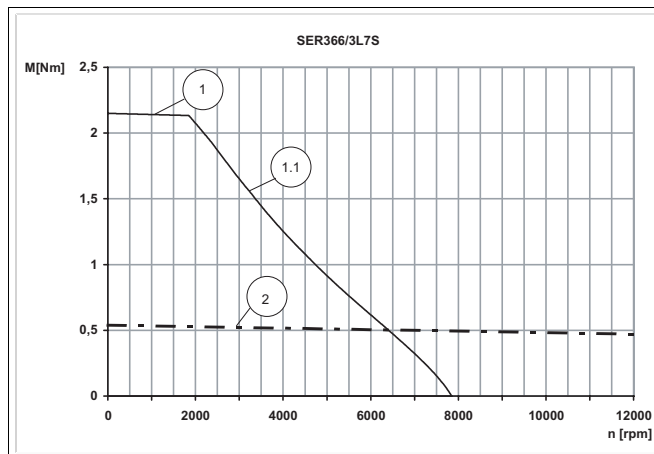
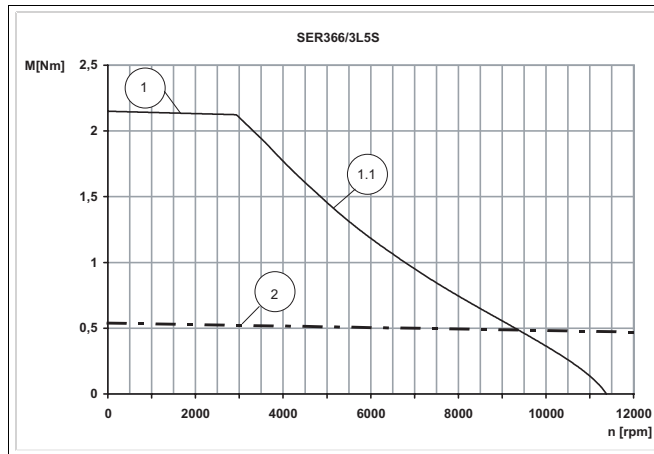
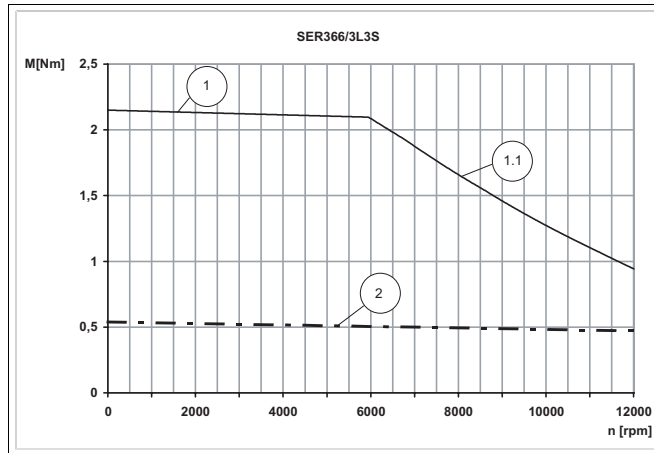

- 1 Peak motor torque
- 1.1 Speed limit at 230V<sub>eff</sub>
- 2 Continuous torque of motor

Torque characteristic SER368

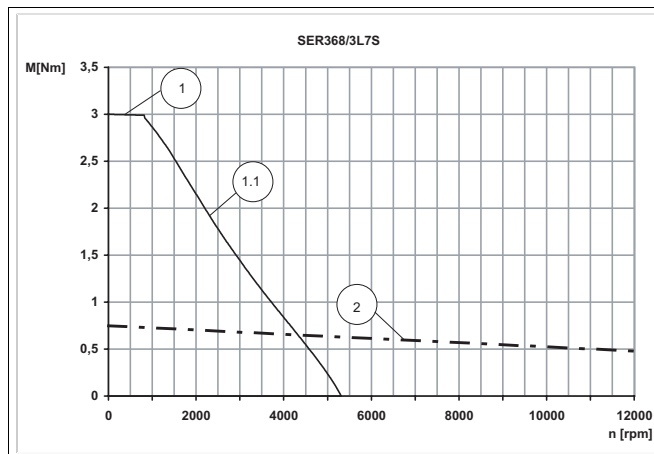
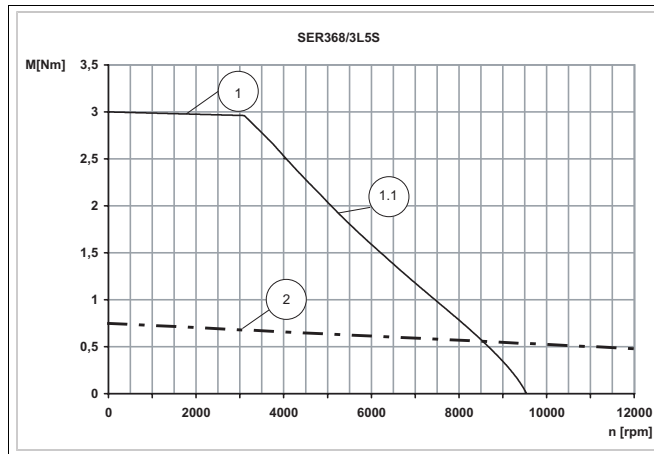
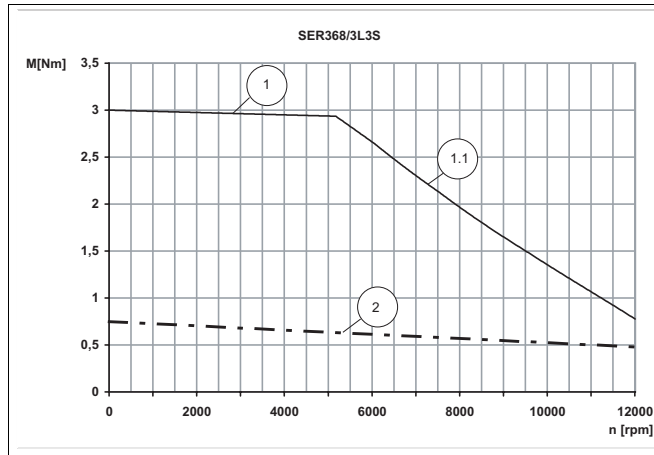

- 1 Peak motor torque
- 1.1 Speed limit at 230V<sub>eff</sub>
- 2 Continuous torque of motor

Torque characteristic SER3610

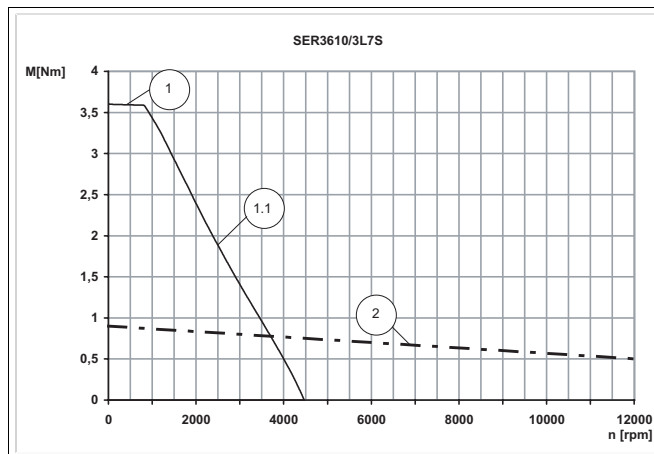
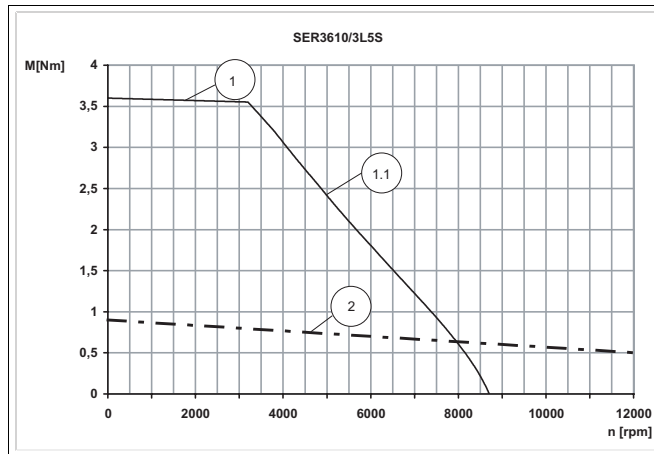
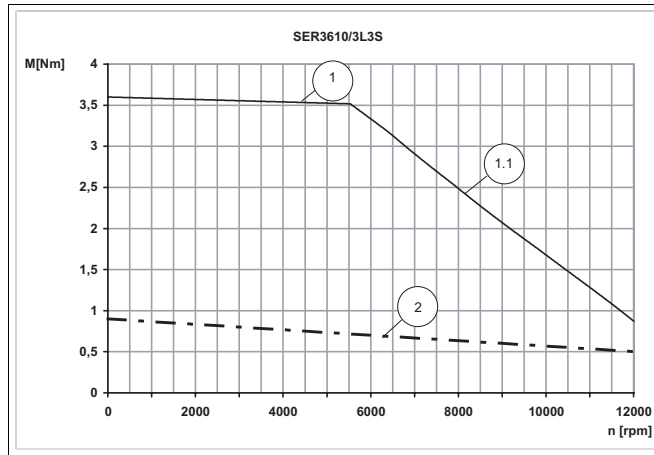

- 1 Peak motor torque
- 1.1 Speed limit at 230V<sub>eff</sub>
- 2 Continuous torque of motor

Shaft load SER 36x The following conditions apply:

- nominal storage life  $I_{10h} = 20000h^1$
- speed  $n = 4000 \text{ min}^{-1}$
- ambient temperature = 40° C
- peak torque = 10% ED
- nominal torque = 100% ED

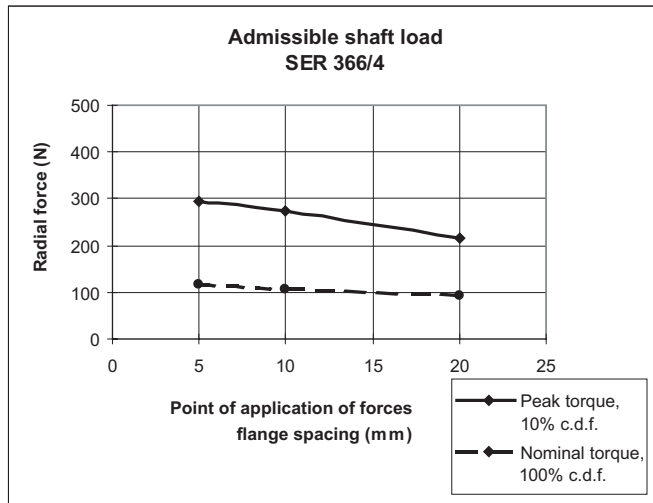
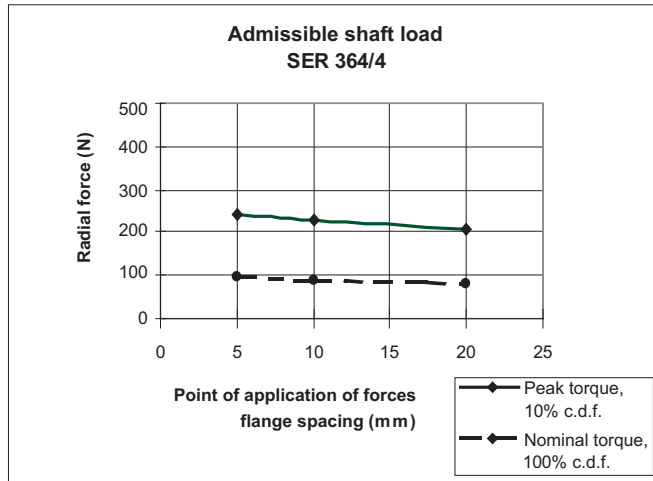

0098 441 113 218, V1.02, 09.2004

1. in operating hours at a failure probability of 10%

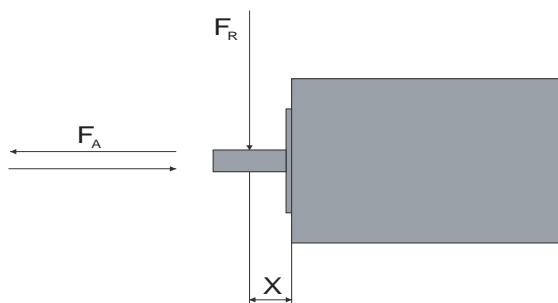
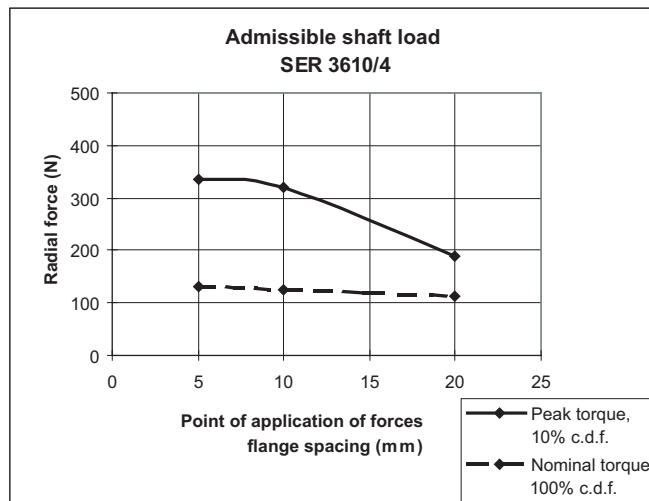
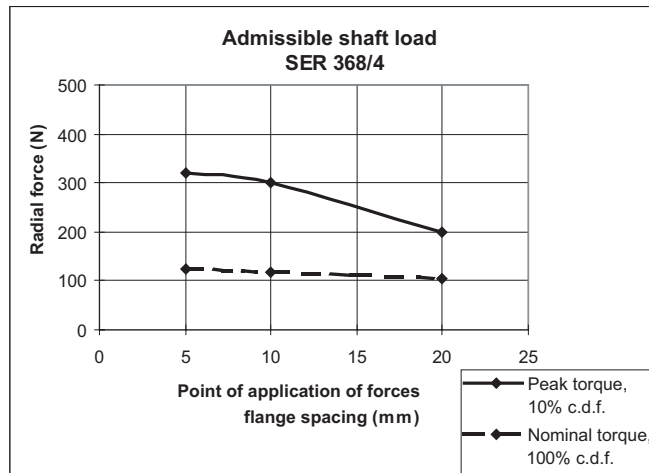

The action point of the forces depends on the motor size:  
SER36x: X=10 mm

*Maximum shaft forces SER36x*

When these conditions apply the maximum forces shown in the table below can act on the shaft:

Motor type	max. radial force front FR		max. axial force tension/ compression FA	
	N	N	N	N
	10% ED	100% ED	10% ED	100% ED
SER364	231	89	300	104
SER366	275	107	300	104
SER368	302	117	300	104
SER3610	320	124	300	104

**Note the following:**

- Radial and axial limit loads must not be applied simultaneously
- The permissible press-on force on the shaft end must not be exceeded
- The shaft extension is corrosion-proof
- The customer must not replace the bearing

*Maximum press-on force*

The maximum press-on force is related to the loading ratio of the bearing. The use of assembly paste (e.g. Klüberpaste 46 MR 401) on the shaft and drive element simplifies pressing on.

If the output shaft is threaded, we advise you to push the output element onto the output shaft. This prevents any axial force from acting on the bearing.

Alternatively the output shaft may be also shrunk on, clamped or glued.

3.1.2.1 Motor models

The flexible modular system and a modern model management offer the models described below. Under the schematic view the type code shows all the models that can be ordered for this motor size.

Schematic view SER36x

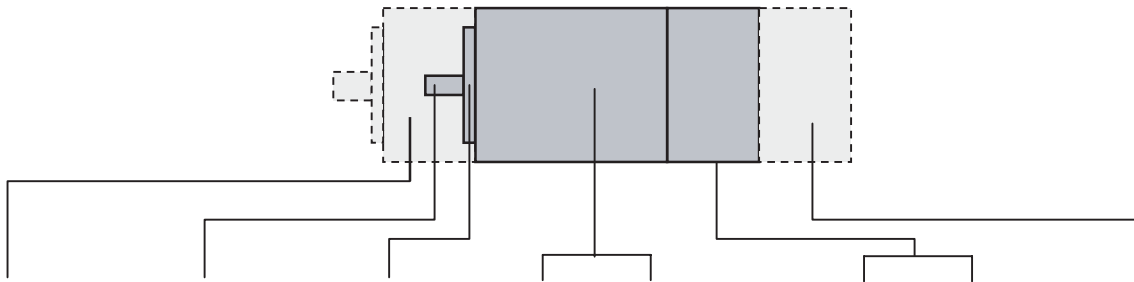

Gearbox	Shaft design	Centring collar	Size	Length	Voltage	Connection type	Options
3:1	Ø 9 mm <sup>1)</sup>	Ø 50 mm	6	4	230V <sub>AC</sub> / 325V <sub>DC</sub>	Plug	Holding brake
5:1		Ø 40 mm		6			Position capture <sup>2)</sup>
8:1				8			Plug connection <sup>3)</sup>
				10			

1) Protection class shaft extension standard: IP 41 - Option: IP 56 with shaft sealing ring, with installed length IM V3 (drive shaft vertical, shaft end up) only safety class IP 41 is guaranteed

2) Type of position capture (sensor system) Standard: Singleturn Encoder SinCos (SRS)  
Options: Multiturn Encoder Sincos (SRM), Resolver

3) Plug connection: Standard = straight; option= 90° angled and rotatable by 310°



Type code SER36x

Example:	SER 3 X X / 3 L 3 S M O T O IP41 X X X XX XXX
Phase count: 3	SER 3 X X / 3 L 3 S M O T O IP41 X X X XX XXX
Size (flange): 6 (57.2 mm)	SER 3 X X / 3 L 3 S M O T O IP41 X X X XX XXX
Length: 4 - 126 mm 6 - 145 mm 8 - 163 mm 10 - 182 mm	SER 3 X X / 3 L 3 S M O T O IP41 X X X XX XXX
Pole pair count: 3	SER 3 X X / 3 L 3 S M O T O IP41 X X X XX XXX
Moment of inertia of rotor: L = low moment of inertia	SER 3 X X / 3 L 3 S M O T O IP41 X X X XX XXX
Winding identification: 3; 5; 7	SER 3 X X / 3 L 3 S M O T O IP41 X X X XX XXX
Winding circuit: S = star D = delta	SER 3 X X / 3 L 3 S M O T O IP41 X X X XX XXX
Sensor system: S = SinCos SingleTurn (S) <sup>1)</sup> M = SinCos MultiTurn (O) <sup>1)</sup> R = resolver (O)	SER 3 X X / 3 L 3 S M O T O IP41 X X X XX XXX
Sensor system resolution: 0 for sensor systems S, M, R <sup>2)</sup>	SER 3 X X / 3 L 3 S M O T O IP41 X X X XX XXX
Plug connector: C = straight (Standard) T = 90° angled (O) <sup>3)</sup>	SER 3 X X / 3 L 3 S M O T O IP41 X X X XX XXX
Holding brake: O - without brake (S) B - with brake (O)	SER 3 X X / 3 L 3 S M O T O IP41 X X X XX XXX
Protection class: IP41 - without shaft sealing ring (S) IP56 - with shaft sealing ring (O) <sup>4)</sup>	SER 3 X X / 3 L 3 S M O T O IP41 X X X XX XXX
Gearbox type: <sup>5)</sup> 2 - PLE 60 A - PLS 70	SER 3 X X / 3 L 3 S M O T O IP41 X X X XX XXX
Gear ratio: <sup>5)</sup> 3 - 3:1; 5 - 5:1; 8 - 8:1	SER 3 X X / 3 L 3 S M O T O IP41 X X X XX XXX
Motor shaft design: K - parallel key DIN 6885 O - without parallel key/without gear-box	SER 3 X X / 3 L 3 S M O T O IP41 X X X XX XXX
Centring collar: 50 - 50 mm (S) 40 - 40 mm (O) 00 - with gearbox	SER 3 X X / 3 L 3 S M O T O IP41 X X X XX XXX
Temperature sensor: PTC - PTC NTC - NTC	SER 3 X X / 3 L 3 S M O T O IP41 X X X XX XXX

1) (S) = Standard, (O) = Option

2) 1024 sine/cosine Periods / revolution for SinCos Single/Multiturn; 1 pole pair for resolver

3) 90° angled - rotatable by 310°

4) IP 56 with shaft sealing ring, with installation position IM V3 (drive shaft vertical, shaft end up) only safety class IP 41 is guaranteed

5) see gearbox type code

3.1.2.2 Dimensional drawing

Dimensions SER36x

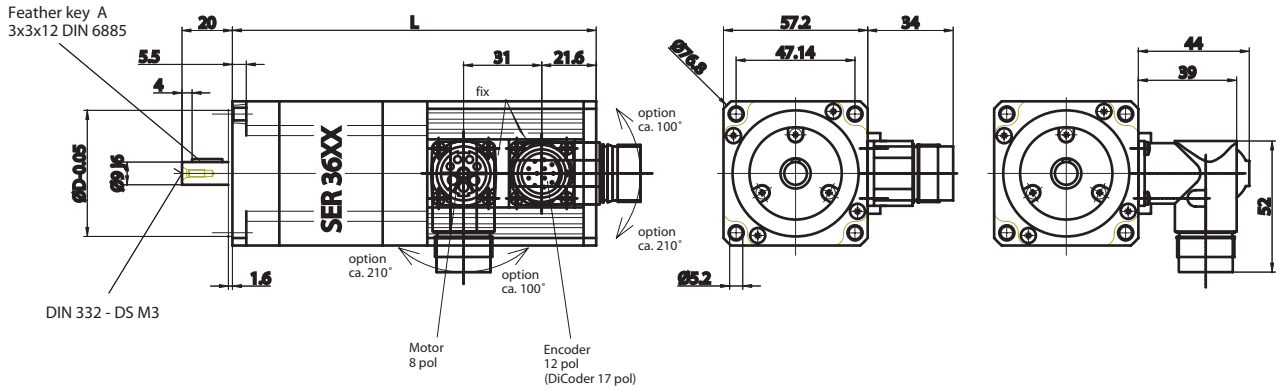

	SER 364	SER 366	SER 368	SER 3610
L (length without brake) [mm]	126	144	163	181
L (length with brake) [mm]	166	184	203	221

3.1.2.3 Options

**Holding brake**

*Holding brake SER36x*

The holding brake is an electromagnetic spring-pressure brake. It holds the motor axis after the motor current is switched off, including after power failure and EMERGENCY STOP. A holding brake is required particularly for torque loads caused by weight forces, such as occur with Z-axes in handling technology. The control is described in Chapter 4.3.2 "Electrical control of the holding brake".



**WARNING!**

**Loss of braking power by wear.**

Incorrect use of the holding brake causes accelerated wear and loss of braking power.

- Do not use the brake as a service brake.

**Technical Data**

Nominal voltage [DC]	24 V ±10%
Holding torque	1.2 Nm
Electrical pick-up power	10 W
Moment of inertia	0.07 kgcm <sup>2</sup>
Make time (brake ventilation)	14 ms
Break time (close brake)	13 ms
Mass	approx. 0.3 kg

### Position capture

*SinCos Multiturn sensor system  
(SRM50)*

This sensor system measures an absolute value within 4096 revolutions after being switched on and continues to count incrementally from this point.

*Resolver sensor system*

This sensor system is a very robust absolute system. Absolute position capture is possible within one revolution.

The data for the sensor systems can be found in Chapter 3.1.1.1 "Position capture (sensor)".

### Gearbox



### CAUTION!

#### The gearbox can be destroyed by overload.

Exceeding the allowable torques will cause accelerated wear, shaft breakage or blocking.

- Do not exceed the peak gearbox torque in any operating status.
- Limit the motor torque if there is a danger of destruction of the gearbox by peak torques.
- Limit the torque in short-time operation (e.g. in an EMERGENCY STOP situation) to twice the continuous gearbox output torque  $M_{dG}$

*Gearbox in general*

Our servomotors can be combined with the standard gearboxes for your application. The following tables show our motor and gearbox combinations.

The listed measured values were determined by continuous output of the maximum torque through the gearbox in your application (maximum acceleration and shortest cycle times to maximum torque).

Under normal operation peak torques cannot be output continuously without thermal overload of the motor. If the gearbox is selected in accordance with the specified values, it will remain in the safe range.

If the motors are not used in the maximum torque range, other gearboxes can be selected in accordance with our combination options.



*If you have any special requirements in addition to the standard range, please contact our technical support.*

The values in **bold** in the table indicate that the torque is restricted by the gearbox or motor. Uneconomical combinations are indicated with x; the gearbox is overdimensioned or underdimensioned. The index "G" refers to the gearbox output shaft.

*Gearbox type PLE* Economical precision planetary gearbox

M d0	Motor	Gearbox	3:1	3:1	3:1	5:1	5:1	5:1	8:1	8:1	8:1
M <sub>d0</sub> Nm			M <sub>d0G</sub> <sup>1)</sup> Nm	M <sub>dG</sub> <sup>2)</sup> Nm	M <sub>maxG</sub> <sup>3)</sup> Nm	M <sub>d0G</sub> <sup>1)</sup> Nm	M <sub>dG</sub> <sup>2)</sup> Nm	M <sub>maxG</sub> <sup>3)</sup> Nm	M <sub>d0G</sub> <sup>1)</sup> Nm	M <sub>dG</sub> <sup>2)</sup> Nm	M <sub>maxG</sub> <sup>3)</sup> Nm
0,32	SER364	PLE 60	0,96	12	<b>3,9</b>	1,6	16	<b>6,5</b>	2,56	15	<b>10,4</b>
054	SER366	PLE 60	1,62	12	<b>6,45</b>	2,7	16	<b>10,75</b>	4,32	<b>15</b>	17,2
0,75	SER368	PLE 60	2,25	12	<b>9</b>	3,75	16	<b>15</b>	6	<b>15</b>	24
0,9	SER3610	PLE 60	2,7	12	<b>10,8</b>	4,5	<b>16</b>	18	7,2	<b>15</b>	28,8

1) M<sub>d0G</sub> Nominal torque at low speed = guide value for selection of the gearbox

2) M<sub>dG</sub> Gearbox output torque (continuous torque)

3) M<sub>maxG</sub> Max. output torque with this motor - (theoretical value, calculated from max. motor torque M<sub>max</sub> \*ratio)

For more information on the gearboxes see Chapter 3.3 “PLE and PLS gearbox”.

*Gearbox type PLS* High-quality low-play planetary gearbox

A PLS 70 gearbox can be attached for greater precision. With the gear ratio 8:1 at high torques it is an economical alternative.

For more information on the gearboxes see Chapter 3.3 “PLE and PLS gearbox”.

## 3.1.3 SER39x

The 8-pole AC synchronous motors of the SER39x series are available in the SER397, SER3910, SER3913 and SER3916 models. The edge length of the flange is 85 mm. The table shows the motor-specific data:

Motor-specific data

Motor type			SER397	SER3910	SER3913	SER3916
<b>Nominal data</b>						
Nominal power	$P_N$	kW	0.35	0.69	1.0	0.84
Nominal speed <sup>1)</sup>	$n_N$	$\text{min}^{-1}$	6000	6000	6000	5000
Nominal continuous torque	$M_{dN}$	Nm	0.55	1.1	1.6	1.6
Continuous torque <sup>2)</sup>	$M_{d0}$	Nm	1.1	2.2	2.9	3.6
<b>Maximum values</b>						
Max. winding voltage	$U_{\max}$	$V_{AC}$	480	480	480	480
		$V_{DC}$	680	680	680	680
Max. voltage against PE		$V_{AC}$	300	300	300	300
Max. torque	$M_{\max}$	Nm	4	8	11.5	14.5
Max. allowable speed	$n_{\max}$	$\text{min}^{-1}$	6000	6000	6000	6000
Max. continuous power	$P_{d\max}$	kW	0.38	0.69	1.06	0.85
Torque at max. continuous power	$M_{Pd\max}$	Nm	0.6	1.1	1.7	1.8
Speed at max. continuous power	$n_{Pd\max}$	$\text{min}^{-1}$	6000	6000	6000	4500
<b>Mechanical values</b>						
Rotor moment of inertia	$J_R$	$\text{kgcm}^2$	0.85	1.6	2.4	3.2
Total length <sup>3)</sup>	L	mm	141	171	201	231
Mass <sup>3)</sup>	m	kg	2.2	3.3	4.4	6.1

1) for max. power

2) at 20 rpm; for  $n=0$  max. 89%

3) without holding brake

Measured values were determined on motor with flanges (steel plate 300\*300\*10mm); ambient temperature 25°C; no sealing ring on the drive shaft

Winding-specific data

	Motor type		Winding-specific data												Winding-specific data						
	Winding <sup>1)</sup>		U <sub>N</sub> = 230 V AC				U <sub>N</sub> = 400 V AC				U <sub>N</sub> = 480 V AC				M <sub>max</sub>	I <sub>max</sub>	V <sub>rms</sub> kEU_V	R <sub>U_V</sub>	L <sub>qU_V</sub>	L <sub>dU_V</sub>	
	Nm	M <sub>d0</sub>	M <sub>dN</sub>	I <sub>dN</sub>	n <sub>N</sub>	P <sub>N</sub>	M <sub>dN</sub>	I <sub>dN</sub>	n <sub>N</sub>	P <sub>N</sub>	M <sub>dN</sub>	I <sub>dN</sub>	n <sub>N</sub>	P <sub>N</sub>	M <sub>max</sub>	I <sub>max</sub>	V <sub>rms</sub> kEU_V	R <sub>U_V</sub>	L <sub>qU_V</sub>	L <sub>dU_V</sub>	
	A <sub>rms</sub>	I <sub>d0</sub>	Nm	A <sub>rms</sub>	min <sup>-1</sup>	kW	Nm	A <sub>rms</sub>	min <sup>-1</sup>	kW	Nm	A <sub>rms</sub>	min <sup>-1</sup>	kW	Nm	A <sub>rms</sub>	V <sub>rms</sub> kEU_V	Ohm	mH	mH	
SER397	3S	1.1	2.6	0.6	1.5	6000	0.38	0.6	1.5	6000	0.38	0.6	1.5	6000	0.38	4.0	12.0	27.5	3.7	13.6	11.7
	7S	1.1	1.3	0.8	1.0	3600	0.30	0.6	0.7	6000	0.38	0.6	0.7	6000	0.38	4.0	6.0	50.7	13	47.9	40.9
SER3910	3S	2.2	3.0	1.6	2.1	4000	0.67	1.1	1.8	6000	0.69	1.1	1.8	6000	0.69	8.0	13.5	47.2	5.4	20.3	17.6
	7S	2.2	1.7	1.8	1.4	2200	0.42	1.5	1.2	4000	0.63	1.3	1.1	4700	0.64	8.0	8.0	83.2	13.7	60.7	51.5
SER3913	3S	2.9	3.7	2.1	2.9	3800	0.84	1.7	2.5	6000	1.06	1.7	2.5	6000	1.06	11.5	18.0	49.5	3.3	14.1	12.2
	5S	2.9	2.5	2.5	2.1	2500	0.65	2.0	1.8	4500	0.94	1.8	1.6	5500	1.04	11.5	12.0	72.3	7.5	30.3	26.1
	7S	2.9	1.3	2.6	1.2	1200	0.33	2.5	1.1	2300	0.60	2.4	1.1	2600	0.65	11.5	6.0	141.6	27.5	115	98.6
SER3913	3S	3.6	4.4	1.9	2.5	4000	0.80	1.1	1.7	6000	0.69	1.1	1.7	6000	0.69	14.5	22.0	51.5	2.65	10.2	8.4
	5S	3.6	3.5	2.3	2.3	3000	0.72	1.6	1.9	5000	0.84	1.1	1.1	6000	0.69	14.5	17.5	65.0	4.2	18.6	15.8
	7S	3.6	2.1	2.8	1.8	1800	0.53	2.2	1.5	3300	0.76	2	1.2	3800	0.80	14.5	10.5	103.6	10.4	51.8	41.4

- 1) Definition of winding see type code
- 2) at 20 rpm; for n=0 max. 89%
- 3) max. 2.5 sec.
- 4) r.m.s. value at 1000 rpm

## SER397 torque characteristic

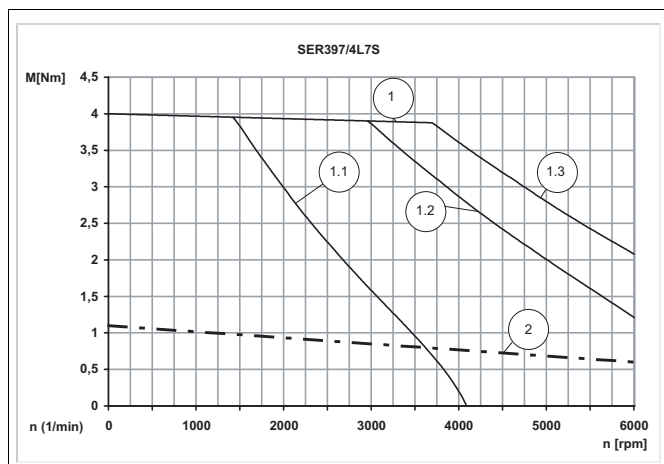
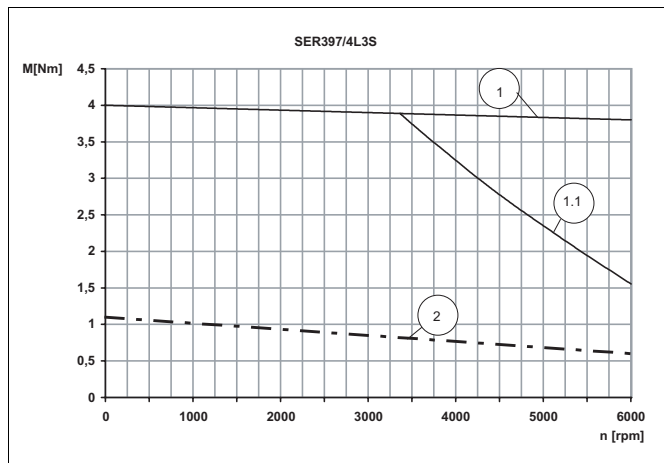

- 1 Peak torque of motor
- 1.1 Speed limit at  $230V_{eff}$
- 1.2 Speed limit at  $400V_{eff}$
- 1.3 Speed limit at  $480V_{eff}$
- 2 Continuous torque of motor

SER3910 torque characteristic

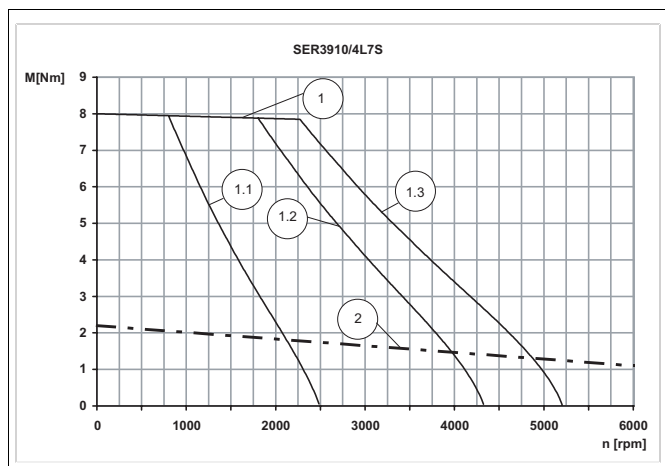
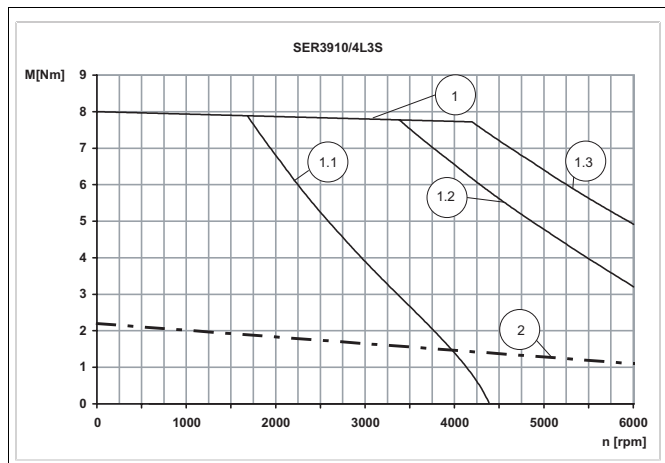

- 1 Peak torque of motor
- 1.1 Speed limit at 230V<sub>eff</sub>
- 1.2 Speed limit at 400V<sub>eff</sub>
- 1.3 Speed limit at 480V<sub>eff</sub>
- 2 Continuous torque of motor



SER3913 torque characteristic

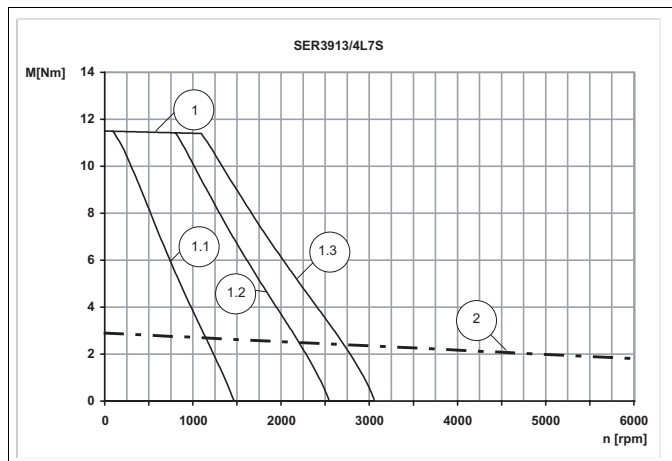
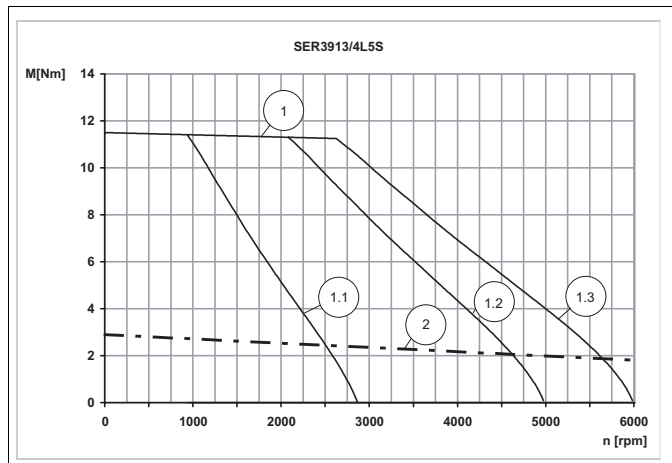
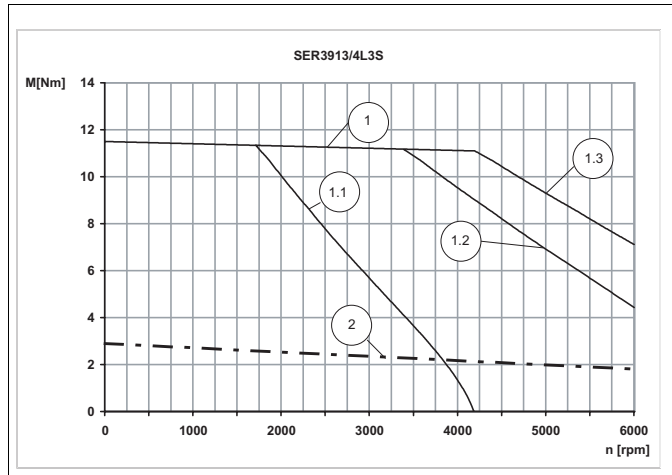

- 1 Peak torque of motor
- 1.1 Speed limit at 230V<sub>eff</sub>
- 1.2 Speed limit at 400V<sub>eff</sub>
- 1.3 Speed limit at 480V<sub>eff</sub>
- 2 Continuous torque of motor

SER3916 torque characteristic

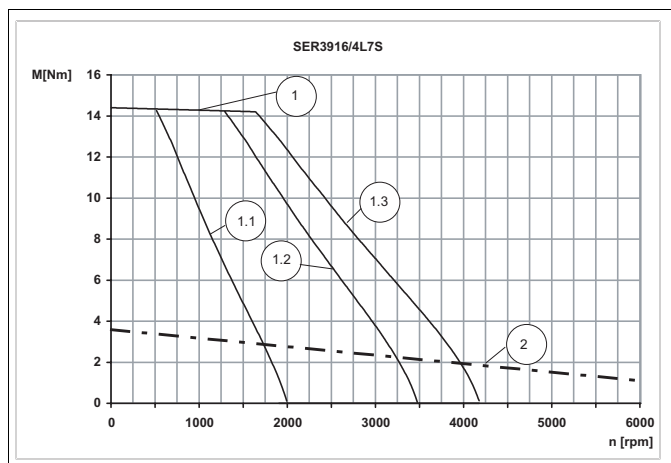
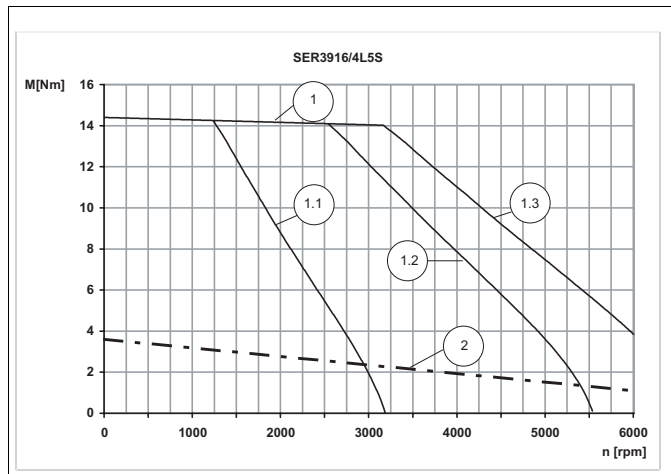
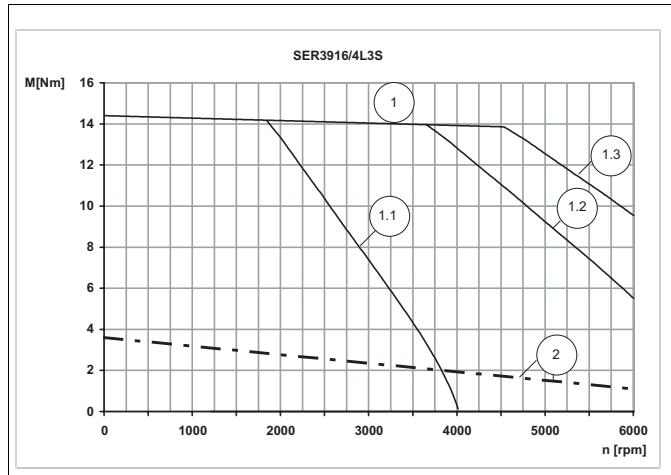

- 1 Peak torque of motor
- 1.1 Speed limit at 230V<sub>eff</sub>
- 1.2 Speed limit at 400V<sub>eff</sub>
- 1.3 Speed limit at 480V<sub>eff</sub>
- 2 Continuous torque of motor

Shaft load SER 39x The following conditions apply:

- nominal storage life  $I_{10h} = 20000h^1$
- speed  $n = 4000 \text{ min}^{-1}$
- ambient temperature = 40° C
- peak torque = 10% ED
- nominal torque = 100% ED

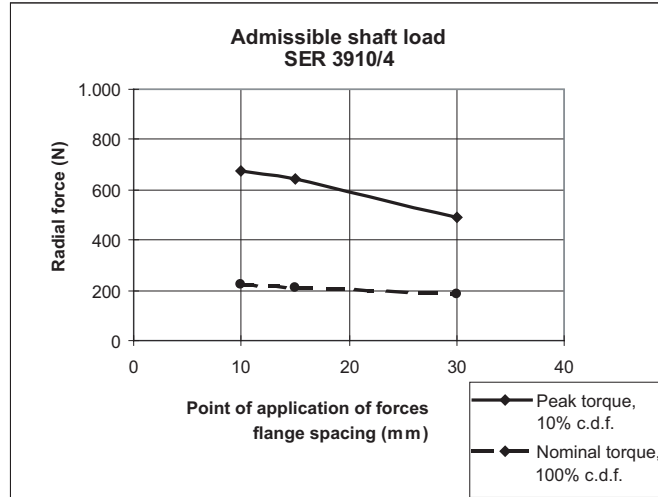
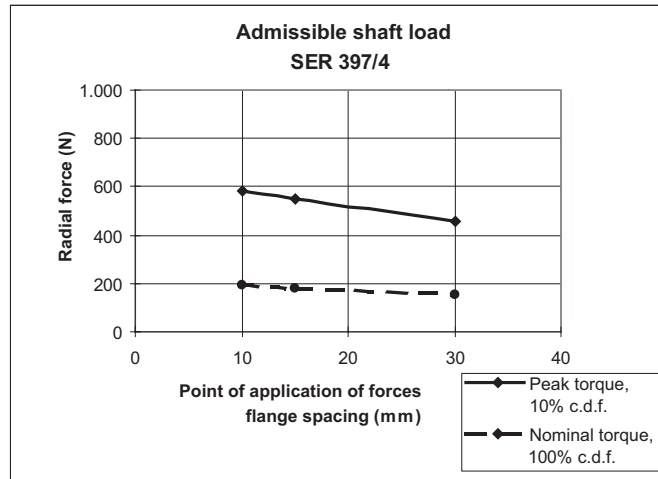

0098 441 113 218, V1.02, 09.2004

1. in operating hours at a failure probability of 10%

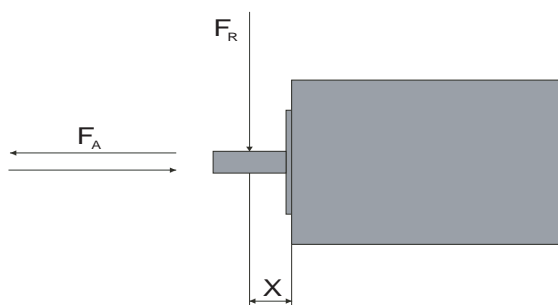
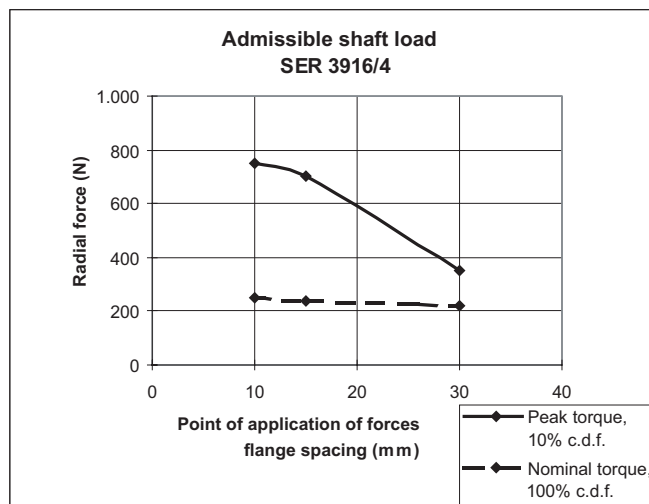
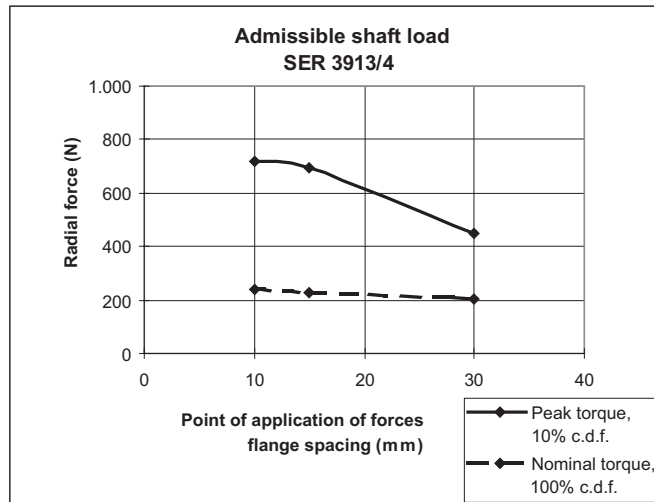

The action point of the forces depends on the motor size: SER39x: X=15 mm

*Maximum shaft forces SER39x*

When these conditions apply the maximum forces shown in the table below can act on the shaft:

Motor type	max. radial force front FR		max. axial force tension/ compression FA	
	N	N	N	N
	10% ED	100% ED	10% ED	100% ED
SER397	600	340	520	450
SER3910	520	450	520	450
SER3913	500	430	520	450
SER3916	500	450	520	450

**Note the following:**

- Radial and axial limit loads must not be applied simultaneously
- The permissible press-on force on the shaft end must not be exceeded
- The shaft extension is corrosion-proof
- The customer must not replace the bearing

*Maximum press-on force*

The maximum press-on force is related to the loading ratio of the bearing. The use of assembly paste (e.g. Klüberpaste 46 MR 401) on the shaft and drive element simplifies pressing on.

If the output shaft is threaded, we advise you to push the output element onto the output shaft. This prevents any axial force from acting on the bearing.

Alternatively the output shaft may be also shrunk on, clamped or glued.

3.1.3.1 Motor models

The flexible modular system and a modern model management offer the models described below. Under the schematic view the type code shows all the models that can be ordered for this motor size.

Schematic view SER39x

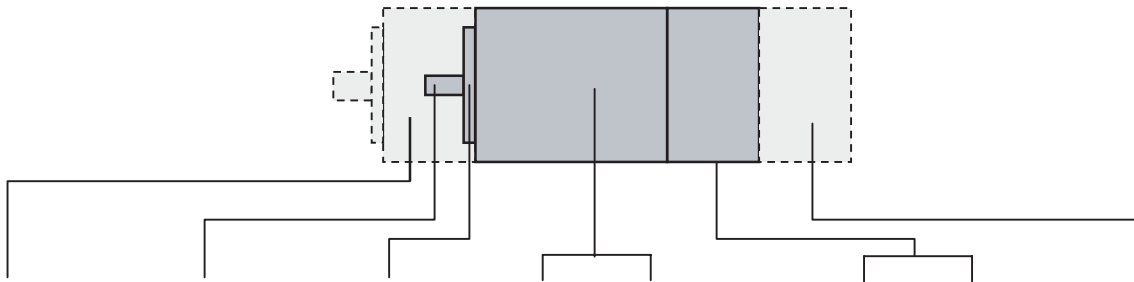

Gearbox	Shaft design	Centring collar	Size	Length	Voltage	Connection type	Options
3:1	Ø 14 mm <sup>1)</sup>	Ø 50 mm	9	7	230V <sub>AC</sub> / 325V <sub>DC</sub>	Plug	Holding brake
5:1		Ø 73 mm		10	480V <sub>AC</sub> / 680V <sub>DC</sub>		Position capture <sup>2)</sup>
8:1		Ø 80 mm		13			Plug connection <sup>3)</sup>
				16			

1) Protection class shaft extension standard: IP 41 - Option: IP 56 with shaft sealing ring, with installed length IM V3 (drive shaft vertical, shaft end up) only safety class IP 41 is guaranteed

2) Type of position capture (sensor system) Standard: Singleturn Encoder SinCos (SRS)

Options: Multiturn Encoder Sincos (SRM), Resolver, digital encoder DiCoder

3) Plug connection: Standard = straight; option= 90° angled and rotatable by 310°

Type code SER39x

Example:	SER 3 X X / 4 L 3 S M O T O IP41 X X X XX XXX
Phase count: 3	SER 3 X X / 4 L 3 S M O T O IP41 X X X XX XXX
Size (flange): 9 (85 mm)	SER 3 X X / 4 L 3 S M O T O IP41 X X X XX XXX
Length: 7 - 141 mm 10 - 171 mm 13 - 201 mm 16 - 231 mm	SER 3 X X / 4 L 3 S M O T O IP41 X X X XX XXX
Pole pair count: 4	SER 3 X X / 4 L 3 S M O T O IP41 X X X XX XXX
Moment of inertia of rotor: L = low moment of inertia	SER 3 X X / 4 L 3 S M O T O IP41 X X X XX XXX
Winding identification: 3; 5; 7	SER 3 X X / 4 L 3 S M O T O IP41 X X X XX XXX
Winding circuit: S = star D = delta	SER 3 X X / 4 L 3 S M O T O IP41 X X X XX XXX
Sensor system: S = SinCos SingleTurn (S) <sup>1)</sup> M = SinCos MultiTurn (O) <sup>1)</sup> R = resolver (O)	SER 3 X X / 4 L 3 S M O T O IP41 X X X XX XXX
Sensor system resolution: 0 for sensor systems S, M, R <sup>2)</sup> 0 = 1024 lines for DiCoder 6 = 4096 lines for DiCoder	SER 3 X X / 4 L 3 S M O T O IP41 X X X XX XXX
Plug connector: C = straight (S) T = 90° angled (O) <sup>3)</sup>	SER 3 X X / 4 L 3 S M O T O IP41 X X X XX XXX
Holding brake: O - without brake (S) B - with brake (O)	SER 3 X X / 4 L 3 S M O T O IP41 X X X XX XXX
Protection class: IP41 - without shaft sealing ring (S) IP56 - with shaft sealing ring (O) <sup>4)</sup>	SER 3 X X / 4 L 3 S M O T O IP41 X X X XX XXX
Gearbox type: <sup>5)</sup> 3 - PLE 80; 4 - PLE 120	SER 3 X X / 4 L 3 S M O T O IP41 X X X XX XXX
Gear ratio: <sup>5)</sup> 3 - 3:1; 5 - 5:1; 8 - 8:1	SER 3 X X / 4 L 3 S M O T O IP41 X X X XX XXX
Motor shaft design: K - parallel key DIN 6885 O - without parallel key/without gear-box	SER 3 X X / 4 L 3 S M O T O IP41 X X X XX XXX
Centring collar: 80 - 80 mm (S) 73 - 73 mm (O) 50 - 50 mm (O) 00 - with gearbox	SER 3 X X / 3 L 4 S M O T O IP41 X X X XX XXX
Temperature sensor: PTC - PTC NTC - NTC	SER 3 X X / 3 L 4 S M O T O IP41 X X X XX XXX

1) (S) = Standard, (O) = Option

2) 1024 sine/cosine periods/revolution for SinCos Single/Multiturn; 1 pole-paired for resolver

3) 90° angled - rotatable by 310°

4) IP 56 with shaft sealing ring, with installed position IM V3 only safety class IP 41 is guaranteed

5) see gearbox type code

3.1.3.2 Dimensional drawing

Dimensions SER39x

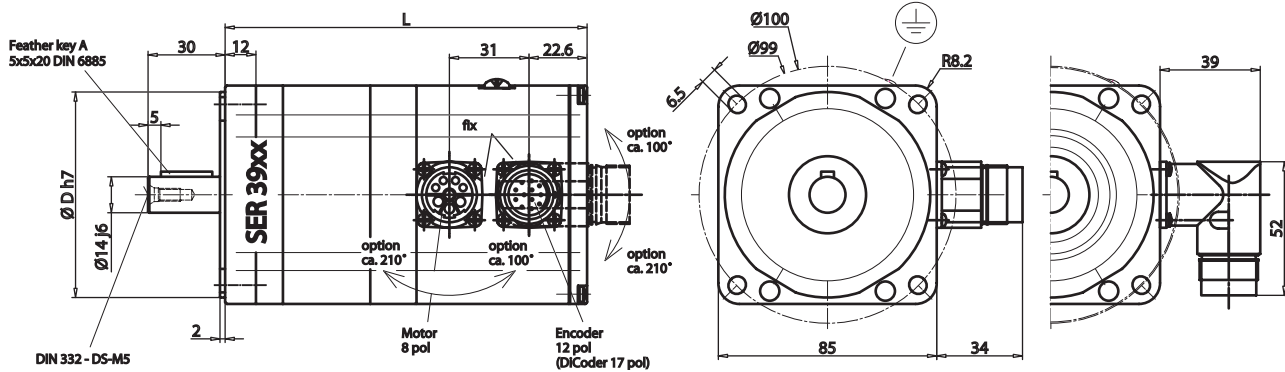

	SER 397	SER 3910	SER 3913	SER 3916
L (length without brake) [mm]	141	171	201	231
L (length with brake) [mm]	187	217	247	277

3.1.3.3 Options

**Holding brake**

*Holding brake SER39x*

The holding brake is an electromagnetic spring-pressure brake. It holds the motor axis after the motor current is switched off, including after power failure and EMERGENCY STOP. A holding brake is required particularly for torque loads caused by weight forces, such as occur with Z-axes in handling technology. The control is described in Chapter 4.3.2 "Electrical control of the holding brake".



**WARNING!**

**Wear or high temperature will cause loss of braking power.**

Incorrect use of the holding brake causes accelerated wear and loss of braking power. Heat reduces the holding torque.

- Do not use the brake as a service brake.
- At operating temperatures over 80°C do not exceed a maximum of 50% of the specified holding torque when using the brake.

**Technical Data**

Nominal voltage [DC]	24 V ±10%
Holding torque	6 Nm
Electrical pick-up power	24 W
Moment of inertia	0.2 kgcm <sup>2</sup>
Make time (brake ventilation)	40 ms
Break time (close brake)	20 ms
Mass	approx. 1.8 kg



### Position capture

*SinCos Multiturn sensor system  
(SRM50)*

This sensor system measures an absolute value within 4096 revolutions after being switched on and continues to count incrementally from this point.

*Resolver sensor system*

This sensor system is a very robust absolute system. Absolute position capture is possible within one revolution.

*Digital encoder sensor system  
(DiCoder)*

This sensor system is an optical (incremental) system.

The data for the sensor systems can be found in Chapter 3.1.1.1 "Position capture (sensor)".

### Gearbox



### CAUTION!

#### The gearbox can be destroyed by overload.

Exceeding the allowable torques will cause accelerated wear, shaft breakage or blocking.

- Do not exceed the peak gearbox torque in any operating status.
- Limit the motor torque if there is a danger of destruction of the gearbox by peak torques.
- Limit the torque in short-time operation (e.g. in an EMERGENCY STOP situation) to twice the continuous gearbox output torque  $M_{dG}$

*Gearbox in general*

Our servomotors can be combined with the standard gearboxes for your application. The following tables show our motor and gearbox combinations.

The listed measured values were determined by continuous output of the maximum torque through the gearbox in your application (maximum acceleration and shortest cycle times to maximum torque).

Under normal operation peak torques cannot be output continuously without thermal overload of the motor. If the gearbox is selected in accordance with the specified values, it will remain in the safe range.

If the motors are not used in the maximum torque range, other gearboxes can be selected in accordance with our combination options.



*If you have any special requirements in addition to the standard range, please contact our technical support.*

The values in **bold** in the table indicate that the torque is restricted by the gearbox or motor. Uneconomical combinations are indicated with x; the gearbox is overdimensioned or underdimensioned. The index "G" refers to the gearbox output shaft.

*Gearbox type PLE* Economical precision planetary gearbox

M d0	Motor	Gearbox	3:1	3:1	3:1	5:1	5:1	5:1	8:1	8:1	8:1
M <sub>d0</sub> Nm			M <sub>d0G</sub> <sup>1)</sup> Nm	M <sub>dG</sub> <sup>2)</sup> Nm	M <sub>maxG</sub> <sup>3)</sup> Nm	M <sub>d0G</sub> <sup>1)</sup> Nm	M <sub>dG</sub> <sup>2)</sup> Nm	M <sub>maxG</sub> <sup>3)</sup> Nm	M <sub>d0G</sub> <sup>1)</sup> Nm	M <sub>dG</sub> <sup>2)</sup> Nm	M <sub>maxG</sub> <sup>3)</sup> Nm
1,1	SER397	PLE 80	3,3	40	<b>13,2</b>	5,5	50	<b>22</b>	8,8	50	<b>35,2</b>
2,2	SER3910	PLE 80	6,6	40	<b>26,4</b>	11	50	<b>44</b>	17,6	<b>50</b>	70,4
2,9	SER3913	PLE 80	8,7	40	<b>34,8</b>	14,5	<b>50</b>	58	23,2	<b>50</b>	92,8
3,6	SER3916	PLE 80	10,8	<b>40</b>	43,2	18	<b>50</b>	72	28,8	<b>50</b>	115,2
2,2	SER3910	PLE 120	x	x	x	x	x	x	17,6	120	<b>70,4</b>
2,9	SER3913	PLE 120	x	x	x	14,5	110	<b>58</b>	23,2	120	<b>92,8</b>
3,6	SER3916	PLE 120	10,8	80	<b>43,2</b>	18	110	<b>72</b>	28,8	120	<b>115,2</b>

1) M<sub>d0G</sub> Nominal torque at low speed = guide value for selection of the gearbox

2) M<sub>dG</sub> Gearbox output torque (continuous torque)

3) M<sub>maxG</sub> Max. output torque with this motor - (theoretical value, calculated from max. motor torque M<sub>max</sub> \*ratio)

For more information on the gearboxes see Chapter 3.3 “PLE and PLS gearbox”.

*Gearbox type PLS* High-quality low-play planetary gearbox

M d0	Motor	Gearbox	3:1	3:1	3:1	5:1	5:1	5:1	8:1	8:1	8:1
M <sub>d0</sub> Nm			M <sub>d0G</sub> <sup>1)</sup> Nm	M <sub>dG</sub> <sup>2)</sup> Nm	M <sub>maxG</sub> <sup>3)</sup> Nm	M <sub>d0G</sub> <sup>1)</sup> Nm	M <sub>dG</sub> <sup>2)</sup> Nm	M <sub>maxG</sub> <sup>3)</sup> Nm	M <sub>d0G</sub> <sup>1)</sup> Nm	M <sub>dG</sub> <sup>2)</sup> Nm	M <sub>maxG</sub> <sup>3)</sup> Nm
1,1	SER397	PLS 70	3,3	30	<b>13,2</b>	5,5	50	<b>22</b>	8,8	37	<b>35,2</b>
2,2	SER3910	PLS 70	6,6	30	<b>26,4</b>	11	50	<b>44</b>	17,6	<b>37</b>	70,4
2,9	SER3913	PLS 70	8,7	<b>30</b>	34,8	14,5	<b>50</b>	58	23,2	<b>37</b>	92,8
3,6	SER3916	PLS 70	10,8	<b>30</b>	43,2	18	<b>50</b>	72	28,8	<b>37</b>	115,2
2,2	SER3910	PLS 90	x	x	x	x	x	x	17,6	<b>62</b>	70,4
2,9	SER3913	PLS 90	8,7	75	<b>34,8</b>	14,5	110	<b>58</b>	23,2	<b>62</b>	92,8
3,6	SER3916	PLS 90	10,8	75	43,2	18	110	<b>72</b>	28,8	<b>62</b>	115,2
2,2	SER3910	PLS 115	x	x	x	x	x	x	17,6	148	<b>70,4</b>
2,9	SER3913	PLS 115	x	x	x	x	x	x	23,2	148	<b>92,8</b>
3,6	SER3916	PLS 115	x	x	x	x	x	x	28,8	148	<b>115,2</b>

1) M<sub>d0G</sub> Nominal torque at low speed = guide value for selection of the gearbox

2) M<sub>dG</sub> Gearbox output torque (continuous torque)

3) M<sub>maxG</sub> Max. output torque with this motor - (theoretical value, calculated from max. motor torque M<sub>max</sub> \*ratio)

For more information on the gearboxes see Chapter 3.3 “PLE and PLS gearbox”.

## 3.1.4 SER311x

The 8-pole AC synchronous motors of the SER311x series are available in the SER31112, SER31117, SER31122 and SER31127 models. The edge length of the flange is 110 mm. The table shows the motor-specific data:

Motor-specific data

Motor type			SER 31112	SER 31117	SER 31122	SER 31127
<b>Nominal data</b>						
Nominal power	$P_N$	kW	1.0	1.4	2.0	2.2
Nominal speed <sup>1)</sup>	$n_N$	$\text{min}^{-1}$	4700	4000	4000	3200
Nominal continuous torque	$M_{dN}$	Nm	2.2	3.3	5.0	6.7
Continuous torque <sup>2)</sup>	$M_{d0}$	Nm	4.2	6.6	10	13.4
<b>Maximum values</b>						
Max. winding voltage	$U_{\max}$	$V_{AC}$	480	480	480	480
		$V_{DC}$	680	680	680	680
Max. voltage against PE		$V_{AC}$	300	300	300	300
Max. torque	$M_{\max}$	Nm	16.8	25	38	48
Max. allowable speed	$n_{\max}$	$\text{min}^{-1}$	6000	6000	4500	4500
Max. continuous power	$P_{d\max}$	kW	1.03	1.38	2.09	2.25
Torque at max. continuous power	$M_{Pd\max}$	Nm	2.1	3.3	5.0	6.7
Speed at max. continuous power	$n_{Pd\max}$	$\text{min}^{-1}$	4700	4000	4000	3200
<b>Mechanical values</b>						
Rotor moment of inertia	$J_R$	$\text{kgcm}^2$	4	8	11.6	15.5
Total length <sup>3)</sup>	L	mm	132	180	228	276
Mass <sup>3)</sup>	m	kg	5.0	8.0	11.0	13.0

1) for max. power

2) at 20 rpm; for  $n=0$  max. 89%

3) without holding brake

Measured values determined on motor with flanges (steel plate 300\*300\*10mm); ambient temperature 25°C; no sealing ring on the drive shaft

Winding-specific data

Motor type	Winding <sup>1)</sup>		U <sub>N</sub> = 230 V <sub>AC</sub>				U <sub>N</sub> = 400 V <sub>AC</sub>				U <sub>N</sub> = 480 V <sub>AC</sub>				M <sub>max</sub>		I <sub>max</sub> <sup>3)</sup>		Voltage constant <sup>4)</sup>		Winding resistance		Winding inductivity		Winding inductivity							
	Nm	M <sub>d0</sub>	A <sub>rms</sub>	I <sub>d0</sub>	Nominal continuous torque		Nominal continuous current		Nominal speed		Nominal power		Nominal continuous torque		Nominal continuous current		Nominal speed		Nominal power		Nm	M <sub>max</sub>	A <sub>rms</sub>	I <sub>max</sub>	V <sub>rms</sub>	k <sub>EU_V</sub>	Ohm	R <sub>U_V</sub>	mH	L <sub>qU_V</sub>	mH	L <sub>dU_V</sub>
					M <sub>dN</sub>	I <sub>dN</sub>	n <sub>N</sub>	P <sub>N</sub>	M <sub>dN</sub>	I <sub>dN</sub>	n <sub>N</sub>	P <sub>N</sub>	M <sub>dN</sub>	I <sub>dN</sub>	n <sub>N</sub>	P <sub>N</sub>																
SER31112	3S	4.2	6.0	2.5	3.5	4000	1.05	1.5	2.1	6000	0.94	1.5	2.1	6000	0.94	16.8	30.0	43.3	1.5	12.6	9.7											
	5S	4.2	3.6	3.3	2.8	2200	0.76	2.5	2.1	4000	1.05	2.0	1.7	5000	1.05	16.8	18.0	70.7	4	34.1	26.6											
	7S	4.2	1.8	4.0	1.7	1000	0.42	3.4	1.5	2000	0.71	3.2	1.4	2400	0.80	16.8	9.0	140.0	18.1	141	107											
SER31117	3S	6.6	6.6	3.6	3.8	3300	1.24	1.5	1.7	6000	0.94	1.5	1.7	6000	0.94	25.0	32.0	58.4	1.2	11.3	8.3											
	5S	6.6	5.0	4.2	3.3	2400	1.06	3.3	2.6	4000	1.38	2.6	2.1	4900	1.33	25.0	24.0	82.0	2.3	21.2	15.4											
	7S	6.6	2.7	5.5	2.3	1250	0.72	4.6	2.0	2250	1.05	4.5	1.9	2500	1.18	25.0	12.5	148.4	7.4	70.2	51.8											
SER31122	5S	10.0	7.0	4.5	3.0	2250	1.06	5.0	3.5	4000	2.09	4.6	3.3	4300	2.07	38.0	32.0	90.9	1.7	17.2	12.4											
	7S	10.0	3.6	8.2	3.0	1000	0.86	7.5	2.8	2000	1.57	7.2	2.6	2250	1.70	38.0	16.5	176	5.7	62.5	45.7											
SER31127	5D	13.4	9.2	8.5	6.0	2200	1.96	4.5	3.2	4000	1.88	3.4	2.3	4500	1.60	48.0	45.0	88.2	1.3	14.5	10.9											
	7S	13.4	5.1	10.8	4.2	1100	1.25	9.0	3.7	2000	1.88	7.8	3.1	2500	2.04	48.0	25.0	160	3.75	41.5	29.9											

- 1) Definition of winding see type code
- 2) at 20 rpm; for n=0 max. 89%
- 3) max. 2.5 sec.
- 4) r.m.s. value at 1000 rpm

Torque characteristic SER31112

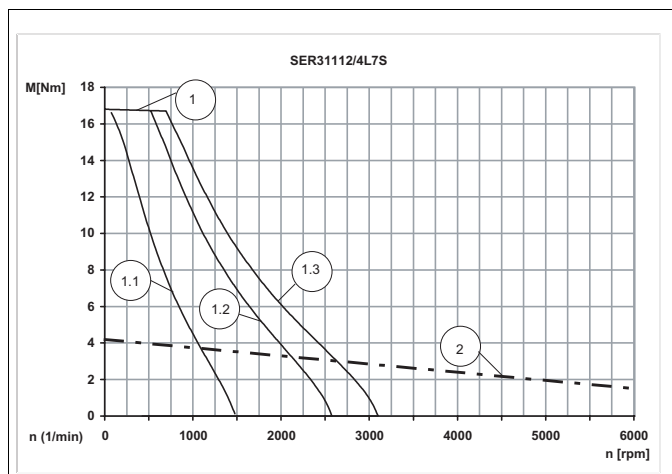
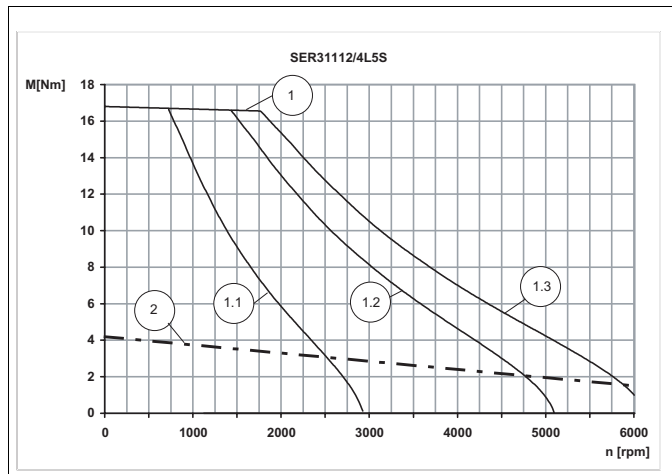
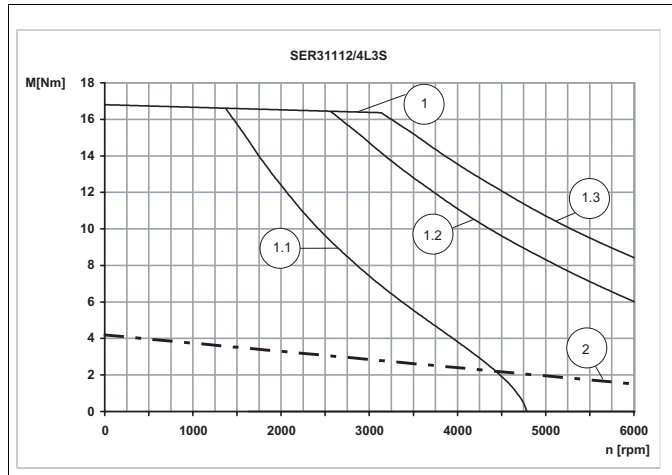

- 1 Peak torque of motor
- 1.1 Speed limit at 230V<sub>eff</sub>
- 1.2 Speed limit at 400V<sub>eff</sub>
- 1.3 Speed limit at 480V<sub>eff</sub>
- 2 Continuous torque of motor

0098 441 113 218, V1.02, 09.2004

Torque characteristic SER31117

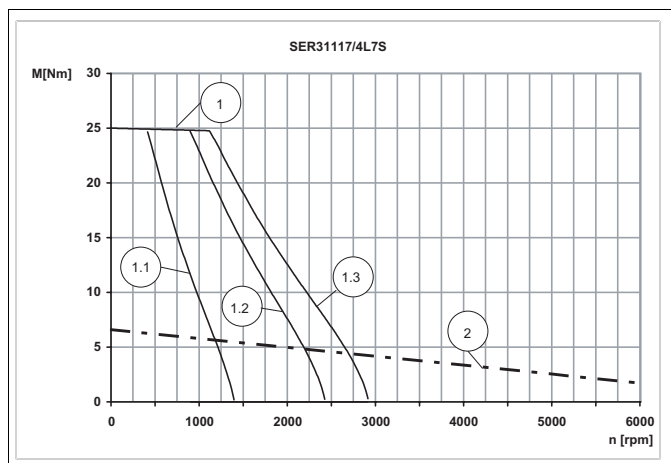
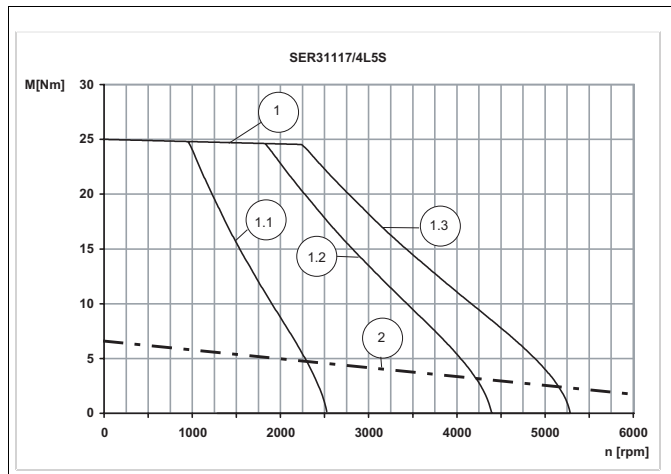
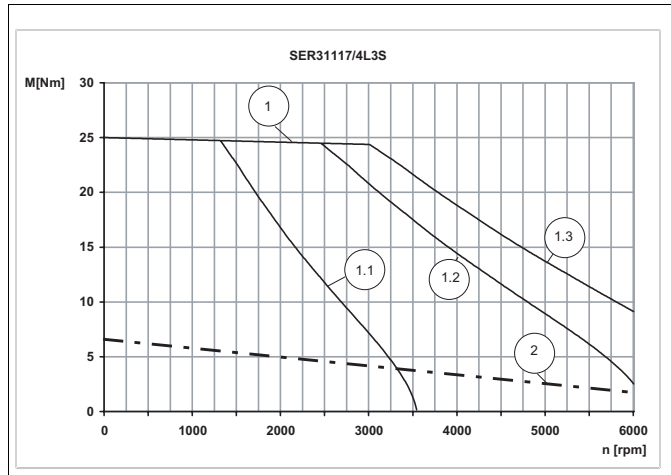

- 1 Peak torque of motor
- 1.1 Speed limit at 230V<sub>eff</sub>
- 1.2 Speed limit at 400V<sub>eff</sub>
- 1.3 Speed limit at 480V<sub>eff</sub>
- 2 Continuous torque of motor

Torque characteristic SER31122

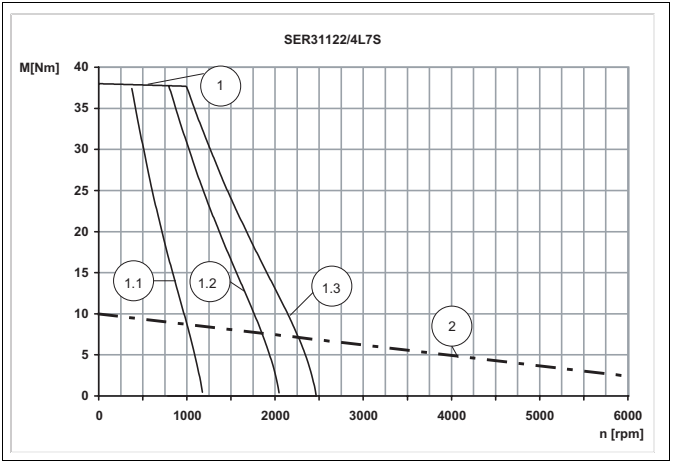

- 1 Peak torque of motor
- 1.1 Speed limit at 230V<sub>eff</sub>
- 1.2 Speed limit at 400V<sub>eff</sub>
- 1.3 Speed limit at 480V<sub>eff</sub>
- 2 Continuous torque of motor

Torque characteristic SER31127

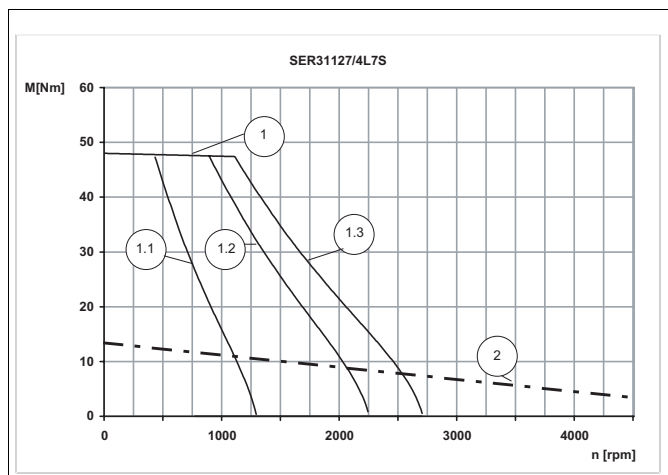
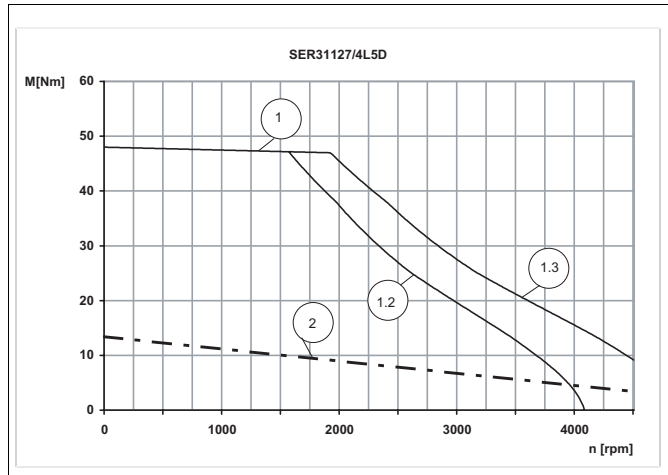

- 1 Peak torque of motor
- 1.1 Speed limit at 230V<sub>eff</sub>
- 1.2 Speed limit at 400V<sub>eff</sub>
- 1.3 Speed limit at 480V<sub>eff</sub>
- 2 Continuous torque of motor

Shaft load SER 311x

The following conditions apply:

- nominal storage life  $I_{10h} = 20000h^1$
- speed  $n = 4000 \text{ min}^{-1}$
- ambient temperature = 40° C
- peak torque = 10% ED
- nominal torque = 100% ED

1. in operating hours at a failure probability of 10%



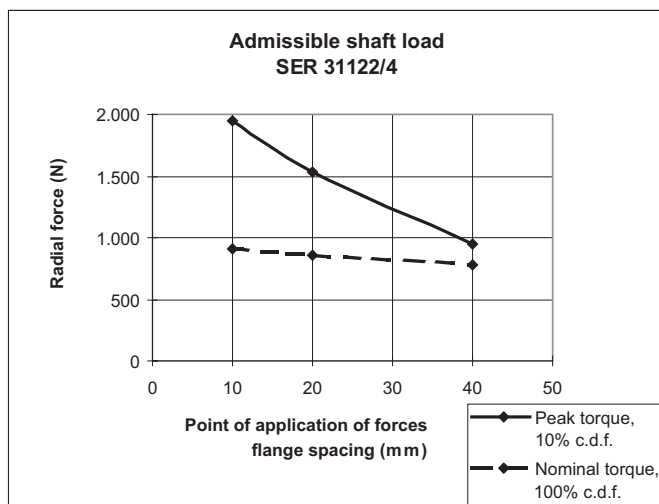
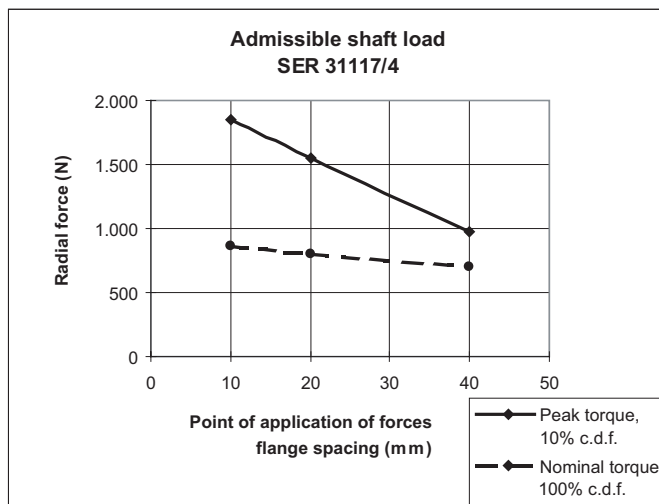
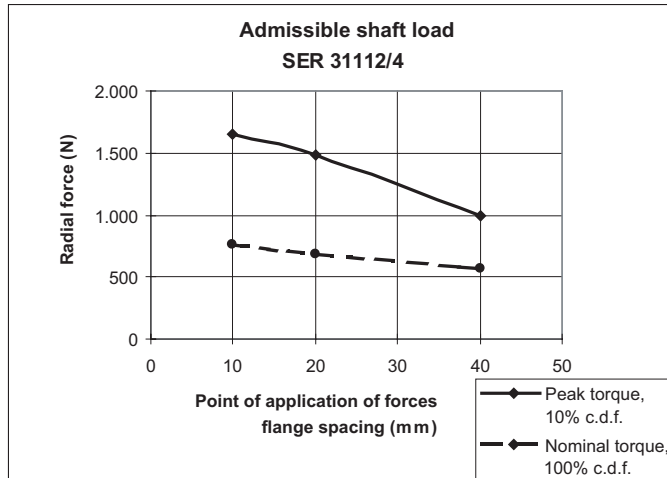

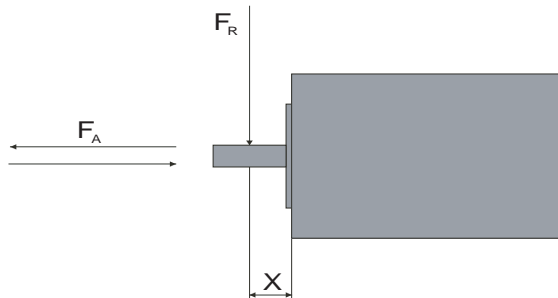
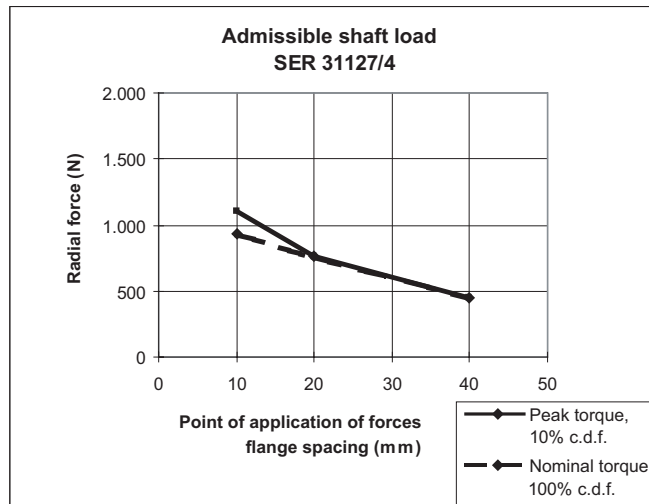

The action point of the forces depends on the motor size:  
 SER311x: X=20mm

Maximum shaft forces SER311x

When these conditions apply the maximum forces shown in the table below can act on the shaft:

Motor type	max. radial force front FR		max. axial force tension/compression FA	
	N	N	N	N
	10% ED	100% ED	10% ED	100% ED
SER31112	1480	690	900	600
SER31117	1550	800	900	600
SER31122	1530	860	900	600
SER31127	760	760	900	600



**Note the following:**

- Radial and axial limit loads must not be applied simultaneously
- The permissible press-on force on the shaft end must not be exceeded
- The shaft extension is corrosion-proof
- The customer must not replace the bearing

*Maximum press-on force* The maximum press-on force is related to the loading ratio of the bearing. The use of assembly paste (e.g. Klüberpaste 46 MR 401) on the shaft and drive element simplifies pressing on.

If the output shaft is threaded, we advise you to push the output element onto the output shaft. This prevents any axial force from acting on the bearing.

Alternatively the output shaft may be also shrunk on, clamped or glued.

### 3.1.4.1 Motor models

The flexible modular system and a modern model management offer the models described below. Under the schematic view the type code shows all the models that can be ordered for this motor size.

Schematic view  
SER311x

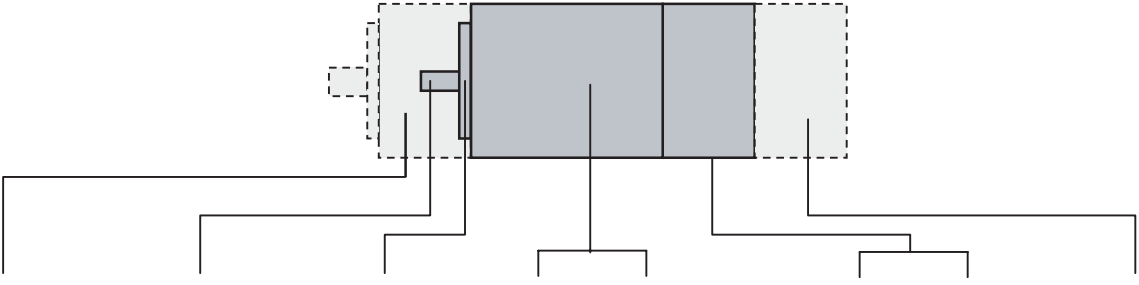

Gearbox	Shaft design	Centring collar	Size	Length	Voltage	Connection type	Options
3:1	Ø 19 mm <sup>1)</sup>	Ø 56 mm	11	12	230V <sub>AC</sub> / 325V <sub>DC</sub>	Plug	Holding brake
5:1		Ø 95 mm		17	480V <sub>AC</sub> / 680V <sub>DC</sub>		Position capture <sup>2)</sup>
8:1		Ø 110 mm		22			Plug connection <sup>3)</sup>
				27			

1) Protection class shaft extension standard: IP 41 - Option: IP 56 with shaft sealing ring, with installed length IM V3 (drive shaft vertical, shaft end up) only safety class IP 41 is guaranteed

2) Type of position capture (sensor system) Standard: Singleturn Encoder SinCos (SRS)  
Options: Multiturn Encoder SinCos (SRM), Resolver, digital encoder DiCoder

3) Plug connection: Standard = straight; option= 90° angled and rotatable by 310°

Type code SER311x

Example:	SER 3 X X / 4 L 3 S M O T O IP41 X X X XX XXX
Phase count: 3	SER 3 X X / 4 L 3 S M O T O IP41 X X X XX XXX
Size (flange): 11 (110 mm)	SER 3 X X / 4 L 3 S M O T O IP41 X X X XX XXX
Length: 12 - 132 mm 17 - 180 mm 22 - 228 mm 27 - 276 mm	SER 3 X X / 4 L 3 S M O T O IP41 X X X XX XXX
Pole pair count: 4	SER 3 X X / 4 L 3 S M O T O IP41 X X X XX XXX
Moment of inertia of rotor: L = low moment of inertia	SER 3 X X / 4 L 3 S M O T O IP41 X X X XX XXX
Winding identification: 3; 5; 7	SER 3 X X / 4 L 3 S M O T O IP41 X X X XX XXX
Winding circuit: S = star; D = delta	SER 3 X X / 4 L 3 S M O T O IP41 X X X XX XXX
Sensor system: S = SinCos SingleTurn (S) <sup>1)</sup> M = SinCos MultiTurn (O) <sup>1)</sup> R = resolver (O)	SER 3 X X / 4 L 3 S M O T O IP41 X X X XX XXX
Sensor system resolution: 0 for sensor systems S, M, R <sup>2)</sup> 0 = 1024 lines for DiCoder 6 = 4096 lines for DiCoder	SER 3 X X / 4 L 3 S M O T O IP41 X X X XX XXX
Plug connector: C = straight (S) T = 90° angled (O) <sup>3)</sup>	SER 3 X X / 4 L 3 S M O T O IP41 X X X XX XXX
Holding brake: O - without brake (S) B - with brake (O)	SER 3 X X / 4 L 3 S M O T O IP41 X X X XX XXX
Protection class: IP41 - without shaft sealing ring (S) IP56 - with shaft sealing ring (O) <sup>4)</sup>	SER 3 X X / 4 L 3 S M O T O IP41 X X X XX XXX
Gearbox type: <sup>5)</sup> 3 - PLE 80; 4 - PLE 120	SER 3 X X / 4 L 3 S M O T O IP41 X X X XX XXX
Gear ratio: <sup>5)</sup> 3 - 3:1; 5 - 5:1; 8 - 8:1	SER 3 X X / 4 L 3 S M O T O IP41 X X X XX XXX
Motor shaft design: K - parallel key DIN 6885 O - without parallel key/without gear- box	SER 3 X X / 4 L 3 S M O T O IP41 X X X XX XXX
Centring collar: 95 - 95 mm (S) 11 - 110 mm (O) 56 - 56 mm (O) 00 - with gearbox	SER 3 X X / 3 L 4 S M O T O IP41 X X X XX XXX
Temperature sensor: PTC - PTC NTC - NTC	SER 3 X X / 3 L 4 S M O T O IP41 X X X XX XXX

1) (S) = Standart, (O) = Option  
 2) 1024 sine/cosine periods/revolution for SinCos Single/Multiturn; 1 pole-paired for resolver  
 3) 90° angled - rotatable by 310°  
 4) IP 56 with shaft sealing ring, with installation position IM V3 (drive shaft vertical, shaft end up) safety class IP 41 is guaranteed only  
 5) see gearbox type code

3.1.4.2 Dimensional drawing

Dimensions SER311x

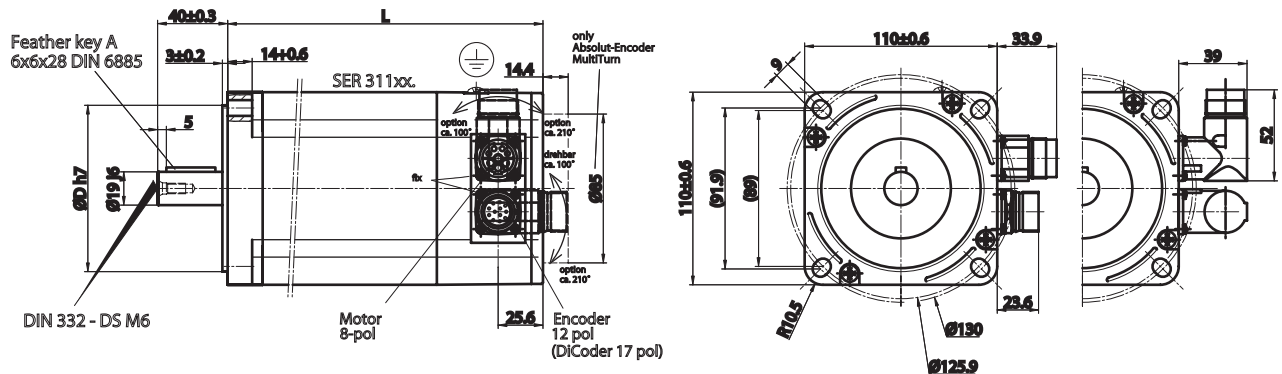

	SER 31112	SER 31117	SER 31122	SER 31127
L (length) [mm]	132	180	228	276
LB (length with brake) [mm]	198	246	294	342

3.1.4.3 Options

**Holding brake**

*Holding brake SER311x*

The holding brake is an electromagnetic spring-pressure brake. It holds the motor axis after the motor current is switched off, including after power failure and EMERGENCY STOP. A holding brake is required particularly for torque loads caused by weight forces, such as occur with Z-axes in handling technology. The control is described in Chapter 4.3.2 "Electrical control of the holding brake".



**WARNING!**

**Wear or high temperature will cause loss of braking power.**

Incorrect use of the holding brake causes accelerated wear and loss of braking power. Heat reduces the holding torque.

- Do not use the brake as a service brake.
- At operating temperatures over 80°C do not exceed a maximum of 50% of the specified holding torque when using the brake.

**Technical Data**

Nominal voltage [DC]	24 V ±10%
Holding torque	16 Nm
Electrical pick-up power	28 W
Moment of inertia	0.35 kgcm <sup>2</sup>
Make time (brake ventilation)	60 ms
Break time (close brake)	30 ms
Mass	approx. 3 kg

**Position capture**

*SinCos Multiturn sensor system (SRM50)*

This sensor system measures an absolute value within 4096 revolutions after being switched on and continues to count incrementally from this point.

*Resolver sensor system*

This sensor system is a very robust absolute system. Absolute position capture is possible within one revolution.

*Digital encoder sensor system (DiCoder)*

This sensor system is an optical (incremental) system.

The data for the sensor systems can be found in Chapter 3.1.1.1 "Position capture (sensor)".

**Gearbox**



**CAUTION!**

**The gearbox can be destroyed by overload.**

Exceeding the allowable torques will cause accelerated wear, shaft breakage or blocking.

- Do not exceed the peak gearbox torque in any operating status.
- Limit the motor torque if there is a danger of destruction of the gearbox by peak torques.
- Limit the torque in short-time operation (e.g. in an EMERGENCY STOP situation) to twice the continuous gearbox output torque  $M_{dG}$

*Gearbox in general*

Our servomotors can be combined with the standard gearboxes for your application. The following tables show our motor and gearbox combinations.

The listed measured values were determined by continuous output of the maximum torque through the gearbox in your application (maximum acceleration and shortest cycle times to maximum torque).

Under normal operation peak torques cannot be output continuously without thermal overload of the motor. If the gearbox is selected in accordance with the specified values, it will remain in the safe range.

If the motors are not used in the maximum torque range, other gearboxes can be selected in accordance with our combination options.



*If you have any special requirements in addition to the standard range, please contact our technical support.*

The values in **bold** in the table indicate that the torque is restricted by the gearbox or motor. Uneconomical combinations are indicated with x; the gearbox is overdimensioned or underdimensioned. The index "G" refers to the gearbox output shaft.

## Gearbox type PLE Economical precision planetary gearbox

M d0	Motor	Gearbox	3:1	3:1	3:1	5:1	5:1	5:1	8:1	8:1	8:1
M <sub>d0</sub> Nm			M <sub>d0G</sub> <sup>1)</sup> Nm	M <sub>dG</sub> <sup>2)</sup> Nm	M <sub>maxG</sub> <sup>3)</sup> Nm	M <sub>d0G</sub> <sup>1)</sup> Nm	M <sub>dG</sub> <sup>2)</sup> Nm	M <sub>maxG</sub> <sup>3)</sup> Nm	M <sub>d0G</sub> <sup>1)</sup> Nm	M <sub>dG</sub> <sup>2)</sup> Nm	M <sub>maxG</sub> <sup>3)</sup> Nm
4,51	SER31112	PLE 80	13,5	<b>40</b>	54	22,5	<b>50</b>	90	36	<b>50</b>	144
4,5	SER31112	PLE 120	13,5	80	<b>54</b>	22,5	110	<b>90</b>	36	<b>120</b>	144
6,6	SER31117	PLE 120	19,8	80	<b>79,2</b>	33	<b>110</b>	132	52,8	<b>120</b>	211,2
10,0	SER31122	PLE 120	30	<b>80</b>	120	50	<b>110</b>	200	80	<b>120</b>	320
13,42	SER31127	PLE 120	40,2	<b>80</b>	160,8	67	<b>110</b>	268	107,2	<b>120</b>	428,8
6,69	SER31117	PLE 160	x	x	x	33	450	<b>132</b>	52,8	450	<b>211,2</b>
10,0	SER31122	PLE 160	30	400	<b>120</b>	50	450	<b>200</b>	80	450	<b>320</b>
13,4	SER31127	PLE 160	40,2	400	<b>160,8</b>	67	450	<b>268</b>	107,2	450	<b>428,8</b>

1) M<sub>d0G</sub> Nominal torque at low speed = guide value for selection of the gearbox

2) M<sub>dG</sub> Gearbox output torque (continuous torque)

3) M<sub>maxG</sub> Max. output torque with this motor - (theoretical value, calculated from max. motor torque M<sub>max</sub> \*ratio)

For more information on the gearboxes see Chapter 3.3 "PLE and PLS gearbox".

## Gearbox type PLS High-quality low-play planetary gearbox

M d0	Motor	Gearbox	3:1	3:1	3:1	5:1	5:1	5:1	8:1	8:1	8:1
M <sub>d0</sub> Nm			M <sub>d0G</sub> <sup>1)</sup> Nm	M <sub>dG</sub> <sup>2)</sup> Nm	M <sub>maxG</sub> <sup>3)</sup> Nm	M <sub>d0G</sub> <sup>1)</sup> Nm	M <sub>dG</sub> <sup>2)</sup> Nm	M <sub>maxG</sub> <sup>3)</sup> Nm	M <sub>d0G</sub> <sup>1)</sup> Nm	M <sub>dG</sub> <sup>2)</sup> Nm	M <sub>maxG</sub> <sup>3)</sup> Nm
4,5	SER31112	PLS 90	13,5	75	<b>54</b>	22,5	110	<b>90</b>	36	<b>62</b>	144
6,6	SER31117	PLS 90	19,8	<b>75</b>	79,2	33	<b>110</b>	132	52,8	<b>62</b>	211,2
10,0	SER31122	PLS 90	30	<b>75</b>	120	50	<b>110</b>	200	x	x	x
13,4	SER31127	PLS 90	40,2	<b>75</b>	160,82	67	<b>110</b>	268	x	x	x
4,5	SER31112	PLS 115	x	x	x	x	x	x	36	148	<b>144</b>
6,6	SER31117	PLS 115	x	x	x	33	210	<b>132</b>	52,8	<b>148</b>	211,2
10,0	SER31122	PLS 115	30	150	<b>120</b>	50	210	<b>200</b>	80	<b>148</b>	320
13,4	SER31127	PLS 115	40,2	<b>150</b>	160,8	67	<b>210</b>	268	107,2	<b>148</b>	428,8
6,6	SER31117	PLS 142	x	x	x	x	x	x	52,8	450	<b>211,2</b>
10,0	SER31122	PLS 142	x	x	x	x	x	x	80	450	<b>320</b>
13,4	SER31127	PLS 142	40,2	400	<b>160,8</b>	67	700	<b>268</b>	107,2	450	<b>428,8</b>

1) M<sub>d0G</sub> Nominal torque at low speed = guide value for selection of the gearbox

2) M<sub>dG</sub> Gearbox output torque (continuous torque)

3) M<sub>maxG</sub> Max. output torque with this motor - (theoretical value, calculated from max. motor torque M<sub>max</sub> \*ratio)

For more information on the gearboxes see Chapter 3.3 "PLE and PLS gearbox".

### 3.2 RIG3xx

#### 3.2.1 RIG3xx general

*Series RIG3xx* The motors of the RIG3xx series are 8-pole AC synchronous servomotors with a 4:1 ratio gearbox integrated into the motor.

They are distinguished by:

- high power density
- integrated thermal winding monitoring
- insulation test voltage in accordance with DIN EN 60034-1 (IEC 60034-1)
- insulation class F in accordance with DIN EN 60034-1 (IEC 60034-1)
- vibration grade R in accordance with DIN EN 60034-14 (IEC 60034-14)
- shaft eccentricity and axial precision in accordance with DIN 42955 N (IEC 60072-1)
- colour: black RAL 9005
- very short design
- highly dynamic

*Environmental influences: ambient operating climate*

Temperature (t)	-20°C to +40°C
Humidity	75%rh annual average 95%rh on 30 days (non-condensing)

*Environmental influences: ambient climate for transport and storage*

The motors must be in a dry, dust-free and vibration-free environment during transport and storage. The storage and transport temperature must remain in the range given below; in case of doubt the storage area must be air-conditioned.

The storage period is primarily determined by the durability of the lubricants in the warehouses and should be less than 36 months. Occasional operation of the drive solution is recommended to ensure that it still operates.

Storage and transport temperature	-25°C to +70°C
-----------------------------------	----------------

*Service life* The service life of the motors when operated correctly is limited primarily by the bearing life.

The following operating conditions can in some cases significantly reduce the service life:

- Installation altitude above 1000 m over sea level
- Rotary movement exclusively within a fixed angle of 100°
- Operation under vibration stress greater than 20 m/s<sup>2</sup>
- Allowing sealing rings to run dry
- Wetting gaskets with aggressive media



*Maximum angular acceleration* The maximum angular acceleration for motors of the RIG3xx series must not exceed 200000 rad/sec<sup>2</sup>, measured at the motor shaft.

*IP protection* The motors meet the following IP protection accordance with DIN EN 60034-5:

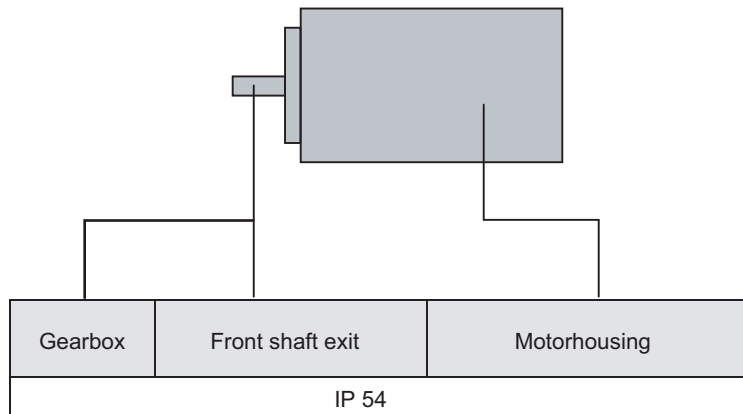

*Note the following:*

- The radial shaft sealing ring is prelubricated.
- Allowing the seals to run dry increases friction and greatly reduces the service life of the sealing rings.

*Overview of IP protection*

<b>First digit</b>		<b>Second digit</b>	
<b>Protection against foreign bodies</b>		<b>Protection against water</b>	
0	no protection	0	no protection
1	foreign body > 50mm	1	vertically falling drops
2	foreign body > 12mm	2	diagonally falling drops (75°-90°)
3	foreign body > 2.5mm	3	spray water
4	foreign body > 1mm	4	splashing water
5	dust-protected	5	jet water
6	dust-proof	6	heavy sea
		7	immersion
		8	continuous immersion

3.2.1.1 Position capture (sensor)

**Standard position capture**

*SinCos (SRS50) Singleturn*

This sensor system measures an absolute value within one revolution after being switched on and continues to count incrementally from this point.

Resolution	depends on controller
Measurement range absolute	1 revolution
Error limit of the digital absolute value depending on the controller	±1.5 minutes of arc
Precision of the incremental position evaluation	±0.75 minutes of arc
Pulse shape	sinus
Supply voltage	7-12V (8V recommended)
Supply current	max. 80mA (without load)

For more information see [www.stegmann.de](http://www.stegmann.de)

**Optional position capture**

As an alternative to the standard sensor system the motors can also be ordered with one of the following sensor systems:

*SinCos (SRM50) Multiturn*

This sensor system measures an absolute value within 4096 revolutions after being switched on and continues to count incrementally from this point.

Resolution	depends on controller
Measurement range absolute	4096 revolutions
Error limit of the digital absolute value depending on the controller	±1.5 minutes of arc
Precision of the incremental position evaluation	±0.75 minutes of arc
Pulse shape	sinus
Supply voltage	7-12V (8V recommended)
Supply current	max. 80mA (without load)

For more information see [www.stegmann.de](http://www.stegmann.de)

*Resolver*

This sensor system is very robust. Absolute position capture is possible within one revolution.

Resolution	depends on the controller
Measurement range absolute	1 revolution
Precision of the incremental position evaluation	±6 minutes of arc
Input voltage	7V <sub>eff</sub>
Input current	max. 38mA

*Digital encoder (DiCoder)* This sensor system is an optical (incremental) system. It is only available for the SER39x and SER311x motor series, it is not available for SER36x.

Resolution	1024 and 4096 bars/revolution
Measurement range absolute	1 revolution
Precision	±2 minutes of arc
Signals	A, B, C, commutation
Pulse shape	rectangular
Supply voltage	5V ± 10%
Supply current	max. 50mA (without load)

For more information see [www.stegmann.de](http://www.stegmann.de)

3.2.2 RIG39x

The 8-pole AC synchronous motors of the SER39x series are available in the RIG397, RIG3910 and RIG3913 models. The edge length of the flange is 85 mm. The table shows the motor-specific data:

Motor-specific data

Motor type			RIG397	RIG3910	RIG3913
<b>Nominal data</b>					
Nominal power	$P_N$	kW	0.315	0.667	1.04
Nominal speed <sup>1)</sup>	$n_N$	$\text{min}^{-1}$	1500	1500	1500
Nominal continuous torque	$M_{dN}$	Nm	2.15	4.25	6.2
Continuous torque <sup>2)</sup>	$M_{d0}$	Nm	4.3	8.5	11.25
<b>Maximum values</b>					
Max. winding voltage	$U_{\max}$	$V_{AC}$	480	480	480
		$V_{DC}$	680	680	680
Max. voltage against PE		$V_{AC}$	300	300	300
Max. torque	$M_{\max}$	Nm	15.5	22 <sup>3)</sup>	22 <sup>3)</sup>
Max. allowable speed	$n_{\max}$	$\text{min}^{-1}$	1500	1500	1500
Max. continuous power	$P_{d\max}$	kW	0.37	0.67	1.03
Torque at max. continuous power	$M_{Pd\max}$	Nm	2.33	4.27	6.60
Speed at max. continuous power	$n_{Pd\max}$	$\text{min}^{-1}$	1500	1500	1500
<b>Mechanical values</b>					
Rotor moment of inertia <sup>4)</sup>	$J_R$	$\text{kgcm}^2$	13	26	39
Total length <sup>5)</sup>	L	mm	143	173	203
Mass <sup>5)</sup>	m	kg	2.4	3.5	4.6

1) for max. power

2) at 20 rpm; for  $n=0$  max. 89%

3) output torque of the gearbox limits torque

4) measured at the output shaft

5) without holding brake

## Winding-specific data

	Motor type		Winding-specific data																		
	Winding <sup>1)</sup>		U <sub>N</sub> = 230 V <sub>AC</sub>				U <sub>N</sub> = 400 V <sub>AC</sub>				U <sub>N</sub> = 480 V <sub>AC</sub>				M <sub>max</sub>						
	Nm	M <sub>d0</sub>	M <sub>dN</sub> Nominal continuous torque		I <sub>dN</sub> Nominal continuous current		n <sub>N</sub> Nominal speed		P <sub>N</sub> Nominal power		M <sub>dN</sub> Nominal continuous torque		I <sub>dN</sub> Nominal continuous current		n <sub>N</sub> Nominal speed		P <sub>N</sub> Nominal power		M <sub>max</sub> Max. torque		
	A <sub>rms</sub>	I <sub>d0</sub>	Nm	A <sub>rms</sub>	min <sup>-1</sup>	kW	Nm	A <sub>rms</sub>	min <sup>-1</sup>	kW	Nm	A <sub>rms</sub>	min <sup>-1</sup>	kW	Nm	A <sub>rms</sub>	V <sub>rms</sub>	Ohm	mH	mH	
RIG397	3S	4.3	2.6	2.3	1.5	1500	0.37	2.3	1.5	1500	0.37	2.3	1.5	1500	0.37	15.5	12.0	27.5	3.7	13.6	11.7
	7S	4.3	1.3	3.1	1.0	900	0.29	2.3	0.7	1500	0.37	2.3	0.7	1500	0.37	15.5	6.0	50.7	13	47.9	40.9
RIG3910	3S	8.8	3.0	6.2	2.1	1000	0.65	4.3	1.8	1500	0.67	4.3	1.8	1500	0.67	22.0	13.5	47.2	5.4	20.3	17.6
	7S	8.5	1.7	7.0	1.4	550	0.41	5.8	1.2	1000	0.61	5.0	1.1	1175	0.62	22.0	8.0	83.2	13.7	60.7	51.5
RIG3913	3S	11.3	3.7	8.1	2.9	950	0.81	6.6	2.5	1500	1.03	6.6	2.5	1500	1.03	22.0	18.0	49.5	3.3	14.1	12.2
	5S	11.3	2.5	9.7	2.1	625	0.63	7.8	1.8	1125	0.91	7.0	1.6	1375	1.01	22.0	12.0	72.3	7.5	30.3	26.1

1) Definition of winding see type code

2) at 20 rpm; for n=0 max. 89%

3) max. 2.5 sec.

4) r.m.s. value at 1000 rpm based on the rotor speed, not output speed

Torque characteristic RIG397

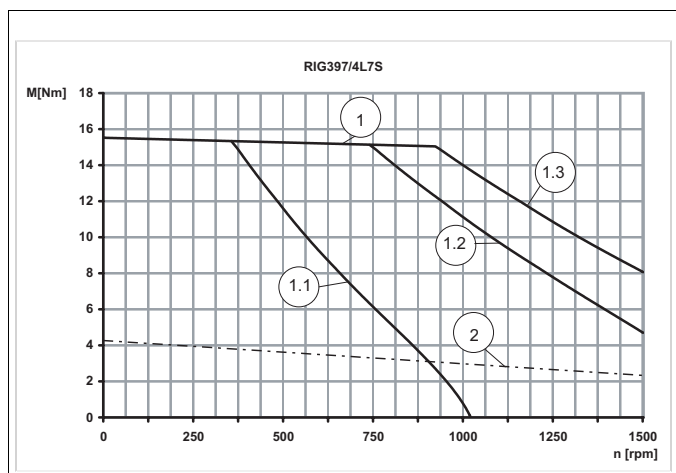
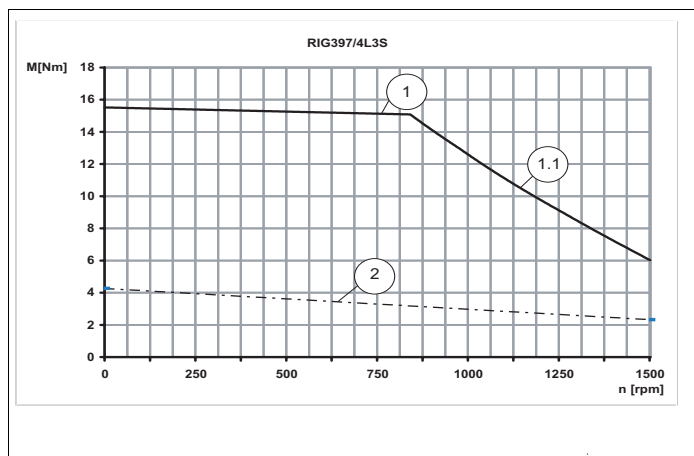

- 1 Peak torque of motor
- 1.1 Speed limit at 230V<sub>eff</sub>
- 1.2 Speed limit at 400V<sub>eff</sub>
- 1.3 Speed limit at 480V<sub>eff</sub>
- 2 Continuous torque of motor

Torque characteristic RIG3910

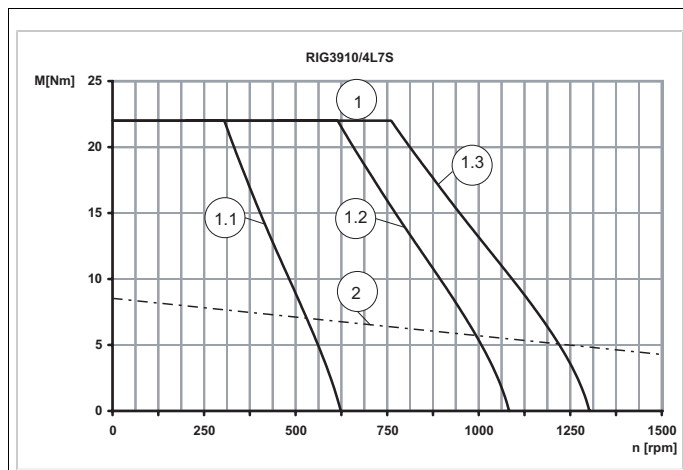
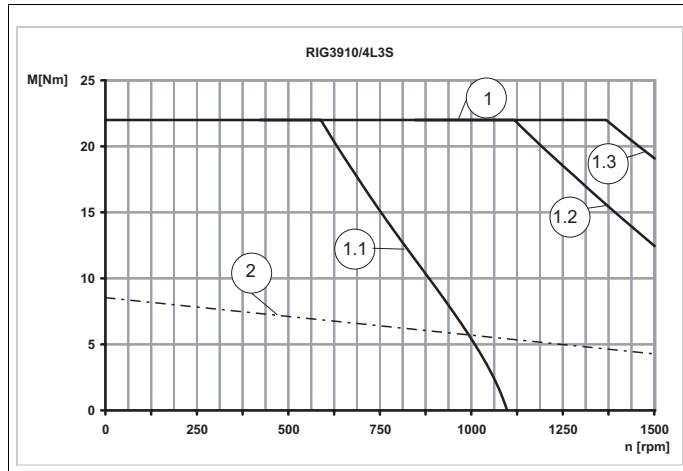

- 1 Peak torque of motor
- 1.1 Speed limit at 230V<sub>eff</sub>
- 1.2 Speed limit at 400V<sub>eff</sub>
- 1.3 Speed limit at 480V<sub>eff</sub>
- 2 Continuous torque of motor

Torque characteristic RIG3913

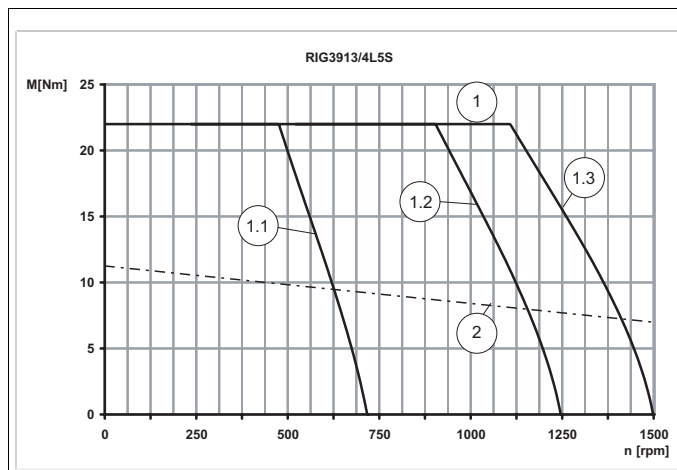
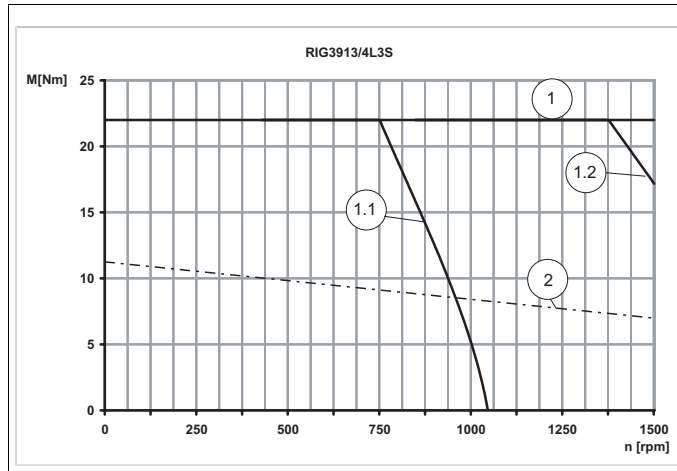

- 1 Peak torque of motor
- 1.1 Speed limit at 230V<sub>eff</sub>
- 1.2 Speed limit at 400V<sub>eff</sub>
- 1.3 Speed limit at 480V<sub>eff</sub>
- 2 Continuous torque of motor

Shaft load RIG 39x

The following data are applicable when force is applied to the centre of the shaft stub and the following conditions:

- nominal storage life  $I_{10h} = 20000h^1$
- speed  $n = 4000 \text{ min}^{-1}$
- ambient temperature = 40° C
- peak torque = 10% ED
- nominal torque = 100% ED

1. in operating hours at a failure probability of 10%



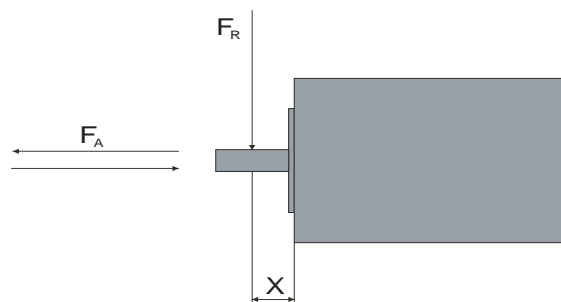
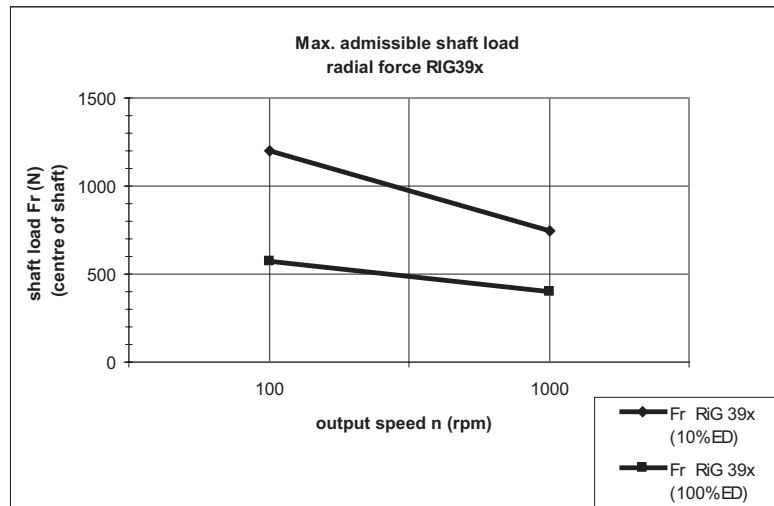
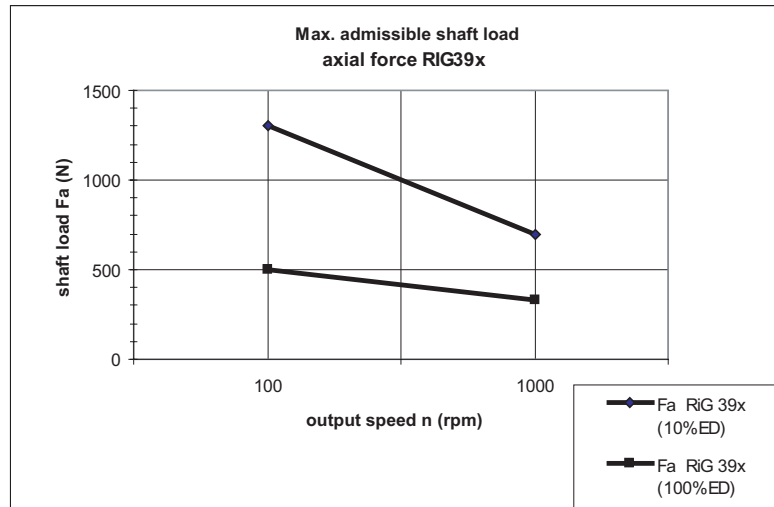

The action point of the forces depends on the motor size:  
 RIG39x: X=20mm

Max. shaft forces for RIG39x

When these conditions apply the maximum forces shown in the table below can act on the shaft:

Motor type	max. radial force front FR		max. axial force tension/compression FA	
	N	N	N	N
	10% ED	100% ED	10% ED	100% ED
RIG397	1200	570	1300	500
RIG3910	1200	570	1300	500
RIG3913	1200	570	1300	500



**Note the following:**

- Radial and axial limit loads must not be applied simultaneously
- The permissible press-on force on the shaft end must not be exceeded
- The shaft extension is corrosion-proof
- The customer must not replace the bearing

For RIG39x the allowable press-on force on the shaft end is 1300N.

Maximum press-on force

The maximum press-on force is related to the loading ratio of the bearing. The use of assembly paste (e.g. Klüberpaste 46 MR 401) on the shaft and drive element simplifies pressing on.

If the output shaft is threaded, we advise you to push the output element onto the output shaft. This prevents any axial force from acting on the bearing.

Alternatively the output shaft may be also shrunk on, clamped or glued.



*The opening in the shaft end must remain open for pressure compensation (normal pressure).*

*Gearbox RIG39x  
Technical Data*

<b>Gearbox type</b>	<b>Single-stage spur-gear planetary gearbox</b>
Torsional backlash	10 arcmin
Torsional stiffness	1.8 Nm / arcmin
Ratio	4:1
Gearbox moment of inertia	0.025 kgcm <sup>2</sup>
Continuous output torque <sup>1)</sup>	22 Nm
Efficiency	99% at nominal load
Shaft material	C 45
Bearings	rolling bearings
Seal at shaft stub	IP 54 <sup>2)</sup>
Lubrication	Grease lubricated for life

1) Output torque of the gearbox in the continuous fatigue strength range of the geared parts (motor was not considered); in EMERGENCY STOP situation twice the torque is possible for a short time

2) at installation position IM V3 (drive shaft vertical, shaft end up) only safety class IP 41 is guaranteed

### 3.2.2.1 Motor models

The flexible modular system and a modern model management offer the models described below. Under the schematic view the type code shows all the models that can be ordered for this motor size.

*Schematic view RIG39x*

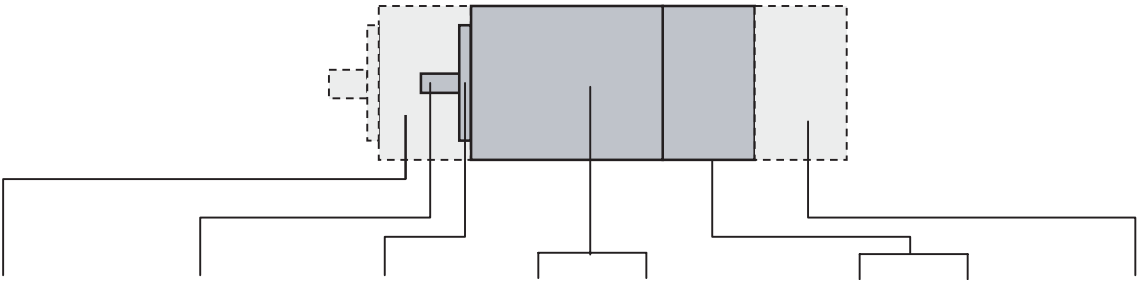

<b>Gearbox</b>	<b>Shaft design</b>	<b>Centring collar</b>	<b>Size</b>	<b>Length</b>	<b>Voltage</b>	<b>Connection type</b>	<b>Options</b>
4:1	Ø 20 mm	Ø 80 mm	9	7	230V <sub>AC</sub> / 325V <sub>DC</sub>	Plug	Holding brake
				10	480V <sub>AC</sub> / 680V <sub>DC</sub>		Position capture <sup>1)</sup>
				13			Plug connection <sup>2)</sup>

1) Type of position capture (sensor system) Standard: Singleturn Encoder SinCos (SRS)

Options: Multiturn Encoder SinCos (SRM), Resolver, digital encoder DiCoder

2) Plug connection: Standard = straight; option= 90° angled and rotatable by 310°

Type code RIG39x

Example:	RIG	3	X	X	/	4	L	3	S	M	O	T	O	IP54	X	X	X	XX	XXX
Phase count: 3	RIG	3	X	X	/	4	L	3	S	M	O	T	O	IP54	X	X	X	XX	XXX
Size (flange): 9 (85 mm)	RIG	3	X	X	/	4	L	3	S	M	O	T	O	IP54	X	X	X	XX	XXX
Length: 7 - 143 mm 10 - 173 mm 13 - 203 mm	RIG	3	X	X	/	4	L	3	S	M	O	T	O	IP54	X	X	X	XX	XXX
Pole pair count: 4	RIG	3	X	X	/	4	L	3	S	M	O	T	O	IP54	X	X	X	XX	XXX
Moment of inertia of rotor: L = low moment of inertia	RIG	3	X	X	/	4	L	3	S	M	O	T	O	IP54	X	X	X	XX	XXX
Winding identification: 3; 5; 7	RIG	3	X	X	/	4	L	3	S	M	O	T	O	IP54	X	X	X	XX	XXX
Winding circuit: S = star D = delta	RIG	3	X	X	/	4	L	3	S	M	O	T	O	IP54	X	X	X	XX	XXX
Sensor system: S = SinCos SingleTurn (S) <sup>1)</sup> M = SinCos MultiTurn (O) <sup>1)</sup> R = resolver (O)	RIG	3	X	X	/	4	L	3	S	M	O	T	O	IP54	X	X	X	XX	XXX
Sensor system resolution: 0 for sensor systems S, M, R <sup>2)</sup> 0 = 1024 lines for DiCoder 6 = 4096 lines for DiCoder	RIG	3	X	X	/	4	L	3	S	M	O	T	O	IP54	X	X	X	XX	XXX
Plug connector: C = straight (S) T = 90° angled (O) <sup>3)</sup>	RIG	3	X	X	/	4	L	3	S	M	O	T	O	IP54	X	X	X	XX	XXX
Holding brake: O - without brake (S) B - with brake (O)	RIG	3	X	X	/	4	L	3	S	M	O	T	O	IP54	X	X	X	XX	XXX
Protection class: IP54 - without shaft sealing ring <sup>4)</sup>	RIG	3	X	X	/	4	L	3	S	M	O	T	O	IP54	X	X	X	XX	XXX
Gearbox type: <sup>5)</sup> I - integrated gearbox	RIG	3	X	X	/	4	L	3	S	M	O	T	O	IP54	X	X	X	XX	XXX
Gear ratio: <sup>5)</sup> 4 - 4:1	RIG	3	X	X	/	4	L	3	S	M	O	T	O	IP54	X	X	X	XX	XXX
Motor shaft design: O - without parallel key/without gear-box	RIG	3	X	X	/	4	L	3	S	M	O	T	O	IP54	X	X	X	XX	XXX
Centring collar: 80 - 80 mm	RIG	3	X	X	/	3	L	4	S	M	O	T	O	IP54	X	X	X	XX	XXX
Temperature sensor: PTC - PTC NTC - NTC	RIG	3	X	X	/	3	L	4	S	M	O	T	O	IP54	X	X	X	XX	XXX

1) (S) = Standard, (O) = Option  
 2) 1024 sine/cosine periods/revolution for SinCos Single/Multiturn; 1 pole-paired for resolver  
 3) 90° angled - rotatable by 310°  
 4) with installation position IM V3 (drive shaft vertical, shaft end up) only guaranteed for safety class IP 41  
 5) see gearbox type code

3.2.2.2 Dimensional drawing

Dimensions RIG39x

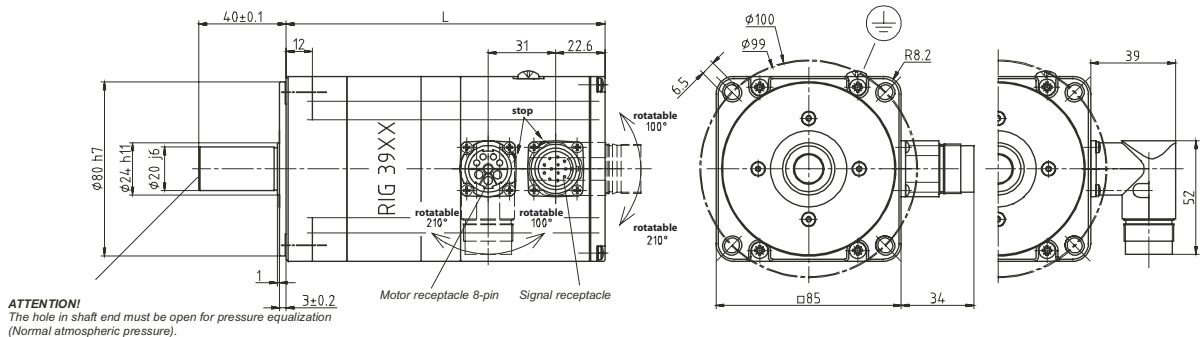

	RIG 397	RIG 3910	RIG 3913
L (length without brake) [mm]	143	173	203
L (length with brake) [mm]	189	219	249

3.2.2.3 Options

**Holding brake**

Holding brake RIG39x

The holding brake is an electromagnetic spring-pressure brake. It holds the motor axis after the motor current is switched off, including after power failure and EMERGENCY STOP. A holding brake is required particularly for torque loads caused by weight forces, such as occur with Z-axes in handling technology. The control is described in Chapter 4.3.2 "Electrical control of the holding brake".



**WARNING!**

**Wear or high temperature will cause loss of braking power.**

Incorrect use of the holding brake causes accelerated wear and loss of braking power. Heat reduces the holding torque.

- Do not use the brake as a service brake.
- At operating temperatures over 80°C do not exceed a maximum of 50% of the specified holding torque when using the brake.

**Technical Data**

Nominal voltage [DC]	24 V ±10%
Holding torque	6 Nm
Electrical pick-up power	24 W
Moment of inertia	0.2 kgcm <sup>2</sup>
Make time (brake ventilation)	40 ms
Break time (close brake)	20 ms
Mass	approx. 1.8 kg

**Position capture**

<i>SinCos Multiturn sensor system (SRM50)</i>	This sensor system measures an absolute value within 4096 revolutions after being switched on and continues to count incrementally from this point.
<i>Resolver sensor system</i>	This sensor system is a very robust absolute system. Absolute position capture is possible within one revolution.
<i>Digital encoder sensor system (DiCoder)</i>	This sensor system is an optical (incremental) system. The data for the sensor systems can be found in Chapter 3.1.1.1 "Position capture (sensor)".

## 3.2.3 RIG311x

The 8-pole AC synchronous motors of the RIG311x series are available in the RIG31112, RIG31117 and RIG31122 models. The edge length of the flange is 110 mm. The table shows the motor-specific data:

Motor-specific data

Motor type			RIG31112	RIG31117	RIG31122
<b>Nominal data</b>					
Nominal power	$P_N$	kW	0.9	1.3	1.8
Nominal speed <sup>1)</sup>	$n_N$	$\text{min}^{-1}$	1175	1000	1000
Nominal continuous torque	$M_{dN}$	Nm	8.5	12.8	19.4
Continuous torque <sup>2)</sup>	$M_{d0}$	Nm	16.2	25.6	38.8
<b>Maximum values</b>					
Max. winding voltage	$U_{\max}$	$V_{AC}$	480	480	480
		$V_{DC}$	680	680	680
Max. voltage against PE		$V_{AC}$	300	300	300
Max. torque	$M_{\max}$	Nm	70	76 <sup>3)</sup>	76 <sup>3)</sup>
Max. allowable speed	$n_{\max}$	$\text{min}^{-1}$	1500	1500	1500
Max. continuous power	$P_{d\max}$	kW	1.00	1.34	2.03
Torque at max. continuous power	$M_{Pd\max}$	Nm	8.1	12.8	19.4
Speed at max. continuous power	$n_{Pd\max}$	$\text{min}^{-1}$	1175	1000	1000
<b>Mechanical values</b>					
Rotor moment of inertia <sup>4)</sup>	$J_R$	$\text{kgcm}^2$	66	130	178
Total length <sup>5)</sup>	L	mm	145	193	241
Mass <sup>5)</sup>	m	kg	6.2	9.2	12.2

1) for max. power

2) at 20 rpm; for  $n=0$  max. 89%

3) output torque of the gearbox limits torque

4) measured at the output shaft

5) without holding brake

Winding-specific data

	Motor type		Winding specific data													Max. torque			Max. current <sup>3)</sup>			Voltage constant <sup>4)</sup>			Winding resistance			Winding inductivity		
			Winding <sup>1)</sup>				Continuous torque <sup>2)</sup>				Continuous current <sup>2)</sup>																			
	Nm	M <sub>d0</sub>	A <sub>rms</sub>	I <sub>d0</sub>	U <sub>N</sub> = 230 V <sub>AC</sub>				U <sub>N</sub> = 400 V <sub>AC</sub>				U <sub>N</sub> = 480 V <sub>AC</sub>																	
					M <sub>dN</sub>	I <sub>dN</sub>	n <sub>N</sub>	P <sub>N</sub>	M <sub>dN</sub>	I <sub>dN</sub>	n <sub>N</sub>	P <sub>N</sub>	M <sub>dN</sub>	I <sub>dN</sub>	n <sub>N</sub>	P <sub>N</sub>														
Nm	A <sub>rms</sub>	min <sup>-1</sup>	kW	Nm	A <sub>rms</sub>	min <sup>-1</sup>	kW	Nm	A <sub>rms</sub>	min <sup>-1</sup>	kW	Nm	A <sub>rms</sub>	min <sup>-1</sup>	kW	Nm	A <sub>rms</sub>	V <sub>rms</sub>	Ohm	mH	mH									
RIG31112	3S	16.3	6.0	9.7	3.5	1000	1.02	5.8	2.1	1500	0.91	5.8	2.1	1500	0.91	65.2	30.0	43.3	1.5	12.6	9.7									
	5S	16.3	3.6	12.8	2.8	550	0.74	9.7	2.1	1000	1.02	7.8	1.7	1250	1.02	76.0	18.0	70.7	4.0	34.1	26.6									
	7S	16.3	1.8	15.5	1.7	250	0.41	13.2	1.5	500	0.69	12.4	1.4	600	0.78	76.0	9.0	140.0	18.1	141	107									
RIG31117	3S	25.6	6.6	14.0	3.8	825	1.20	5.8	1.7	1500	0.91	5.8	1.7	1500	0.91	76.0	32.0	58.4	1.2	11.3	8.3									
	5S	25.6	5.0	16.3	3.3	600	1.03	12.8	2.6	1000	1.34	10.1	2.1	1225	1.29	76.0	24.0	82.0	2.3	21.2	15.4									
	7S	25.6	2.7	21.3	2.3	312	0.70	17.8	2.0	562	1.02	17.5	1.9	625	1.14	76.0	12.5	148.4	7.4	70.2	51.8									
RIG31112	5S	38.8	7.0	17.5	3.0	562	1.03	19.4	3.5	1000	2.09	17.8	3.3	1075	2.01	76.0	32.0	90.9	1.7	17.2	12.4									
	7S	38.8	3.6	31.8	3.0	250	0.83	29.1	2.8	500	1.52	27.9	2.6	562	1.65	76.0	16.5	176	5.7	62.5	45.7									

- 1) Definition of winding see type code
- 2) at 20 rpm; for n=0 max. 89%
- 3) max. 2.5 sec.
- 4) r.m.s. value at 1000 rpm based on the rotor speed, not output speed



Torque characteristic RIG31112

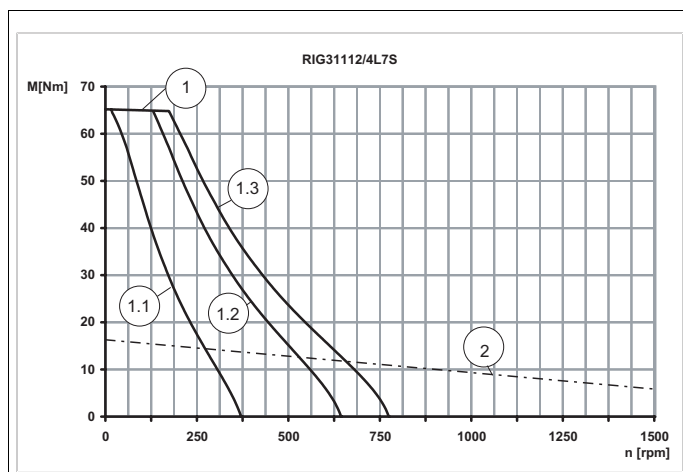
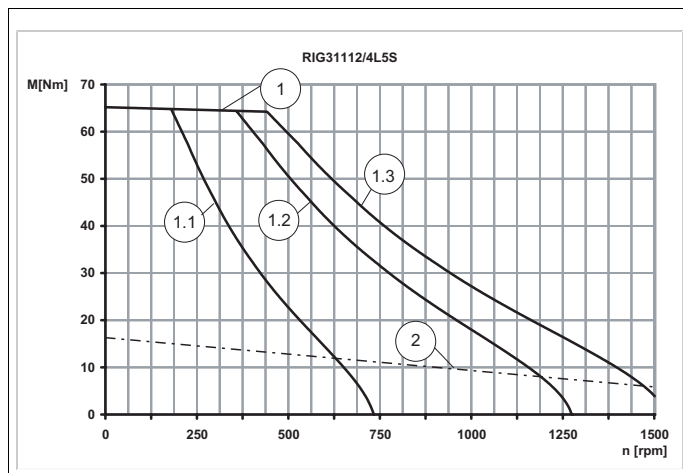
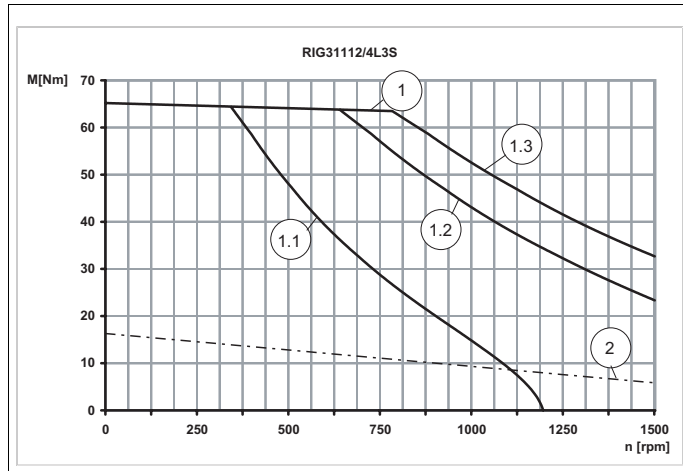

- 1 Peak torque of motor
- 1.1 Speed limit at 230V<sub>eff</sub>
- 1.2 Speed limit at 400V<sub>eff</sub>
- 1.3 Speed limit at 480V<sub>eff</sub>
- 2 Continuous torque of motor

0098 441 113 218, V1.02, 09.2004

Torque characteristic RIG31117

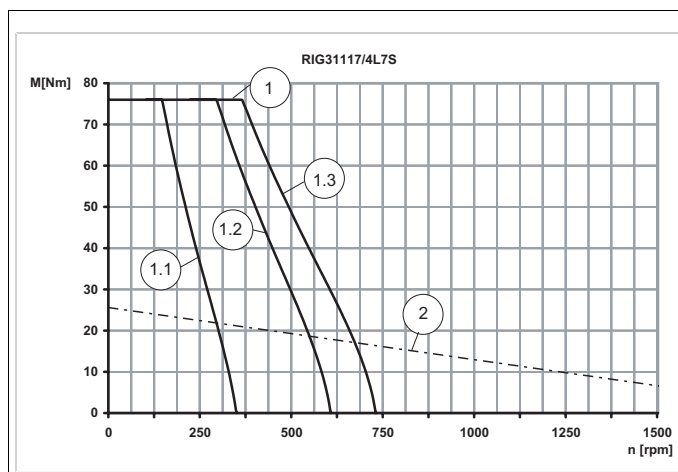
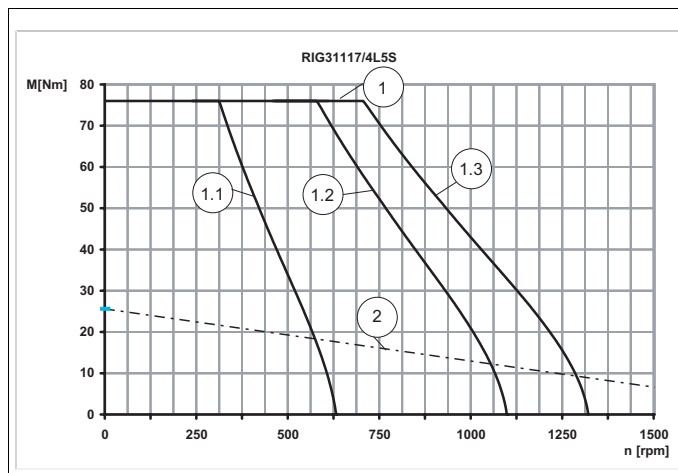
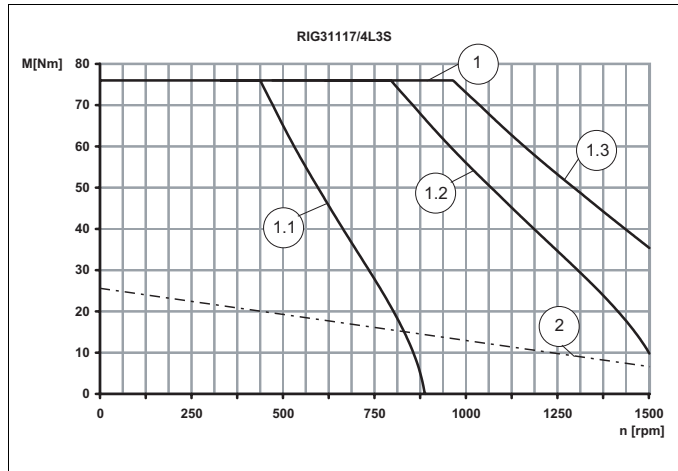

- 1 Peak torque of motor
- 1.1 Speed limit at 230V<sub>eff</sub>
- 1.2 Speed limit at 400V<sub>eff</sub>
- 1.3 Speed limit at 480V<sub>eff</sub>
- 2 Continuous torque of motor

## Torque characteristic RIG31122

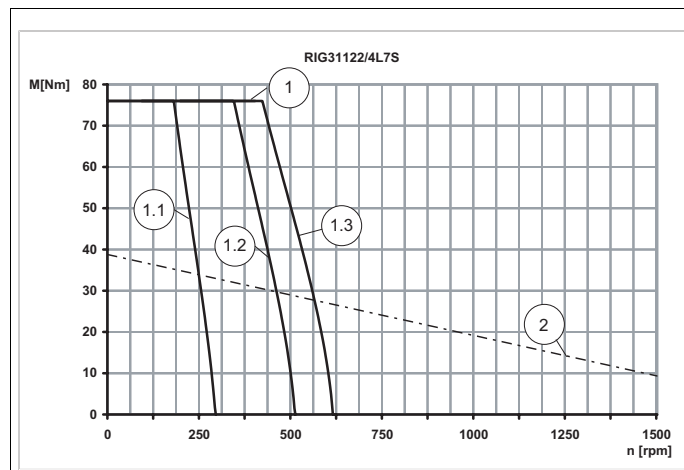
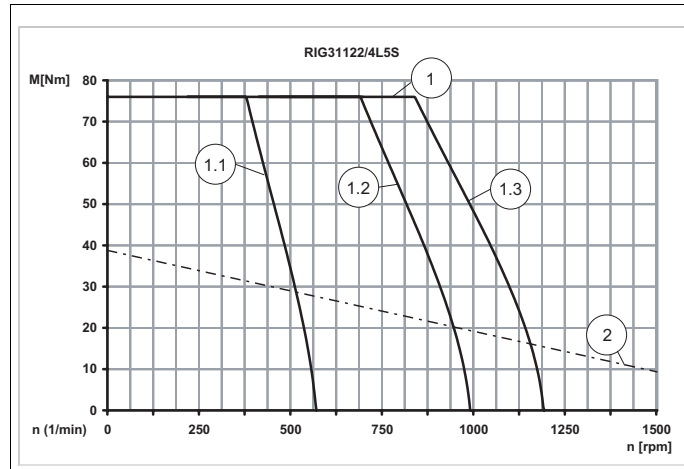

- 1 Peak torque of motor
- 1.1 Speed limit at 230V<sub>eff</sub>
- 1.2 Speed limit at 400V<sub>eff</sub>
- 1.3 Speed limit at 480V<sub>eff</sub>
- 2 Continuous torque of motor

## Shaft load RIG 311x

The following data are applicable when force is applied to the centre of the shaft stub and the following conditions:

- nominal storage life  $l_{10h} = 20000h^1$
- speed  $n = 4000 \text{ min}^{-1}$
- ambient temperature = 40° C
- peak torque = 10% ED
- nominal torque = 100% ED

1. in operating hours at a failure probability of 10%

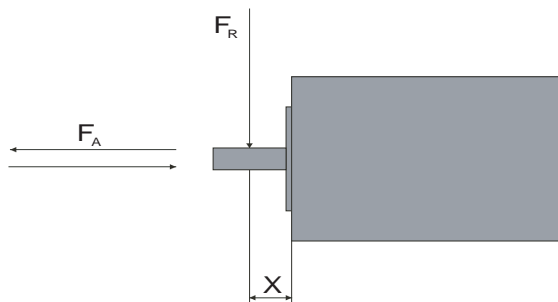
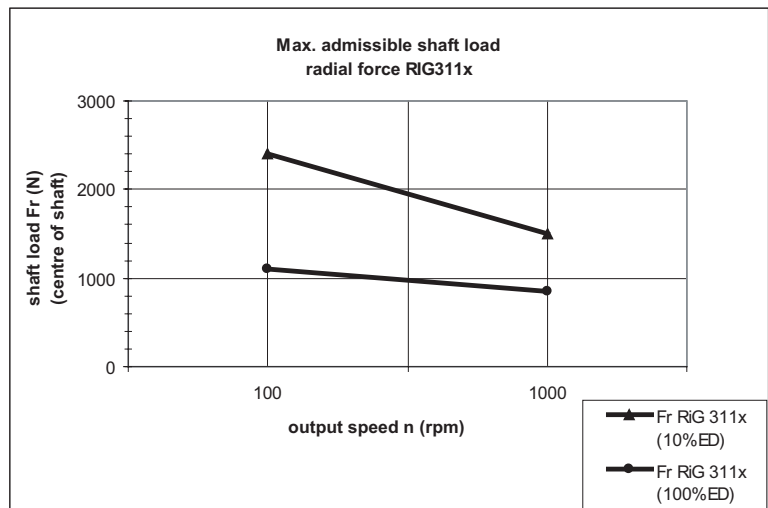
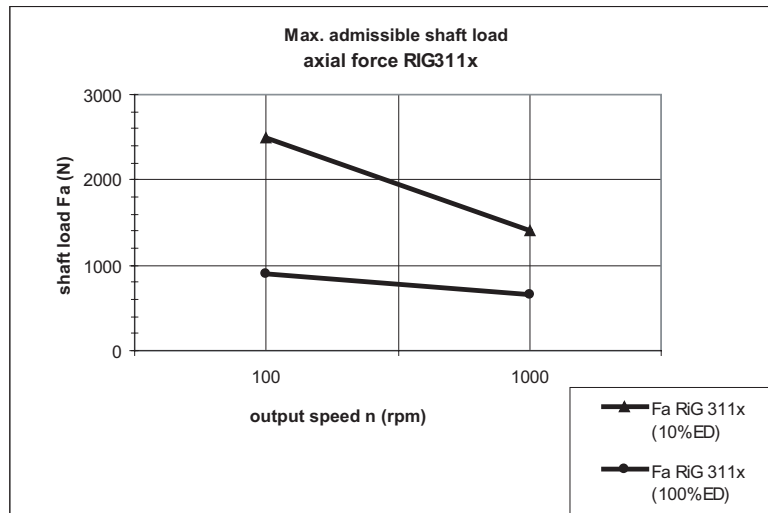

The action point of the forces depends on the motor size:  
RIG311x: X=24mm

*Max. shaft forces for RIG311x*

When these conditions apply the maximum forces shown in the table below can act on the shaft:

Motor type	max. radial force front FR		max. axial force tension/ compression FA	
	N	N	N	N
	10% ED	100% ED	10% ED	100% ED
RIG31112	2400	1100	2500	900
RIG31117	2400	1100	2500	900
RIG31122	2400	1100	2500	900



**Note the following:**

- Radial and axial limit loads must not be applied simultaneously
- The permissible press-on force on the shaft end must not be exceeded
- The shaft extension is corrosion-proof
- The customer must not replace the bearing

For RIG311x the allowable press-on force on the shaft end is 1300N.

*Maximum press-on force*

The maximum press-on force is related to the loading ratio of the bearing. The use of assembly paste (e.g. Klüberpaste 46 MR 401) on the shaft and drive element simplifies pressing on.

If the output shaft is threaded, we advise you to push the output element onto the output shaft. This prevents any axial force from acting on the bearing.

Alternatively the output shaft may be also shrunk on, clamped or glued.



*The opening in the shaft end must remain open for pressure compensation (normal pressure).*

RIG311x gearbox  
Technical Data

Gearbox type	Single-stage spur-gear planetary gearbox
Torsional backlash	8 arcmin
Torsional stiffness	5.3 Nm / arcmin
Ratio	4:1
Gearbox moment of inertia	0.13 kgcm <sup>2</sup>
Continuous output torque <sup>1)</sup>	76 Nm
Efficiency	99% at nominal load
Shaft material	C 45
Bearings	rolling bearings
Seal at shaft stub	IP 54 <sup>2)</sup>
Lubrication	Grease lubricated for life

1) Output torque of the gearbox in the continuous fatigue strength range of the geared parts (motor was not considered); in EMERGENCY STOP situation twice the torque is possible for a short time  
2) at installation position IM V3 (drive shaft vertical, shaft end up) only safety class IP 41 is guaranteed

3.2.3.1 Motor models

The flexible modular system and a modern model management offer the models described below. Under the schematic view the type code shows all the models that can be ordered for this motor size.

Schematic view  
RIG311x

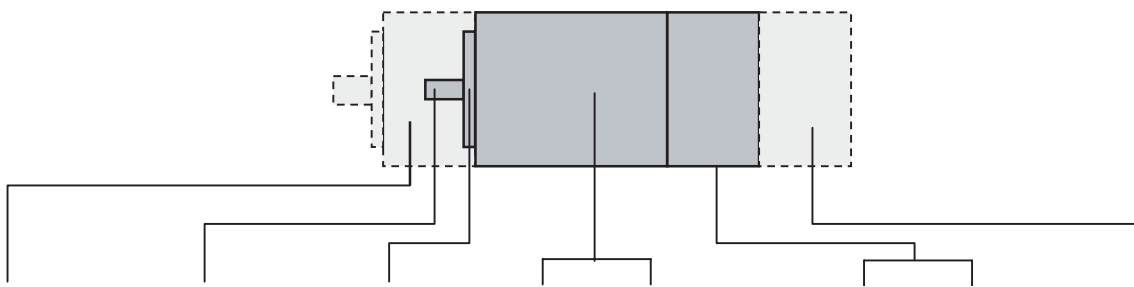

Gearbox	Shaft design	Centring collar	Size	Length	Voltage	Connection type	Options
4:1	Ø 25 mm	Ø 95 mm	11	12	230V <sub>AC</sub> / 325V <sub>DC</sub>	Plug	Holding brake
				17	480V <sub>AC</sub> / 680V <sub>DC</sub>		Position capture <sup>1)</sup>
				22			Plug connection <sup>2)</sup>

1) Type of position capture (sensor system) Standard: Singleturn Encoder SinCos (SRS)  
Options: Multiturn Encoder Sincos (SRM), Resolver, digital encoder DiCoder  
2) Plug connection: Standard = straight; option= 90° angled and rotatable by 310°

Type code RIG311x

Example:	RIG	3	X	X	/	4	L	3	S	M	O	T	O	IP41	X	X	X	XX	XXX
Phase count: 3	RIG	3	X	X	/	4	L	3	S	M	O	T	O	IP54	X	X	X	XX	XXX
Size (flange): 11 (110 mm)	RIG	3	X	X	/	4	L	3	S	M	O	T	O	IP54	X	X	X	XX	XXX
Length: 12 - 145 mm 17 - 193 mm 22 - 241 mm	RIG	3	X	X	/	4	L	3	S	M	O	T	O	IP54	X	X	X	XX	XXX
Pole pair count: 4	RIG	3	X	X	/	4	L	3	S	M	O	T	O	IP54	X	X	X	XX	XXX
Moment of inertia of rotor: L = low moment of inertia	RIG	3	X	X	/	4	L	3	S	M	O	T	O	IP54	X	X	X	XX	XXX
Winding identification: 3; 5; 7	RIG	3	X	X	/	4	L	3	S	M	O	T	O	IP54	X	X	X	XX	XXX
Winding circuit: S = star D = delta	RIG	3	X	X	/	4	L	3	S	M	O	T	O	IP54	X	X	X	XX	XXX
Sensor system: S = SinCos SingleTurn (S) <sup>1)</sup> M = SinCos MultiTurn (O) <sup>1)</sup> R = resolver (O)	RIG	3	X	X	/	4	L	3	S	M	O	T	O	IP54	X	X	X	XX	XXX
Sensor system resolution: 0 for sensor systems S, M, R <sup>2)</sup> 0 = 1024 lines for DiCoder 6 = 4096 lines for DiCoder	RIG	3	X	X	/	4	L	3	S	M	O	T	O	IP54	X	X	X	XX	XXX
Plug connector: C = straight (S) T = 90° angled <sup>3)</sup> (O)	RIG	3	X	X	/	4	L	3	S	M	O	T	O	IP54	X	X	X	XX	XXX
Holding brake: O - without brake (S) B - with brake (O)	RIG	3	X	X	/	4	L	3	S	M	O	T	O	IP54	X	X	X	XX	XXX
Protection class: IP54 - without shaft sealing ring <sup>4)</sup>	RIG	3	X	X	/	4	L	3	S	M	O	T	O	IP54	X	X	X	XX	XXX
Gearbox type: <sup>5)</sup> I - integrated gearbox	RIG	3	X	X	/	4	L	3	S	M	O	T	O	IP54	X	X	X	XX	XXX
Gear ratio: <sup>5)</sup> 4 - 4:1	RIG	3	X	X	/	4	L	3	S	M	O	T	O	IP54	X	X	X	XX	XXX
Motor shaft design: O - without parallel key/without gear-box	RIG	3	X	X	/	4	L	3	S	M	O	T	O	IP54	X	X	X	XX	XXX
Centring collar: 95 - 95 mm	RIG	3	X	X	/	3	L	4	S	M	O	T	O	IP54	X	X	X	XX	XXX
Temperature sensor: PTC - PTC NTC - NTC	RIG	3	X	X	/	3	L	4	S	M	O	T	O	IP54	X	X	X	XX	XXX

1) (S) = Standard, (O) = Option

2) 1024 sine/cosine periods/revolution for SinCos Single/Multiturn; 1 pole-paired for resolver

3) 90° angled - rotatable by 310°

4) with installation position IM V3 (drive shaft vertical, shaft end up) only guaranteed for safety class IP 41

5) see gearbox type code





**Position capture***SinCos Multiturn sensor system  
(SRM50)*

This sensor system measures an absolute value within 4096 revolutions after being switched on and continues to count incrementally from this point.

*Resolver sensor system*

This sensor system is a very robust absolute system. Absolute position capture is possible within one revolution.

*Digital encoder sensor system  
(DiCoder)*

This sensor system is an optical (incremental) system.

The data for the sensor systems can be found in Chapter 3.1.1.1 "Position capture (sensor)".

### 3.3 PLE and PLS gearbox

The AC servomotors of the SER3xx series can be combined with the gearboxes that we have selected as standard for your applications

The configurations options of the motors with the gearboxes and the resulting possible torques can be found with the corresponding motor descriptions. The common properties of the gearboxes and the size and dimensions are described here.

*PLE gearbox* The PLE planetary gearbox series is the economy alternative to the PLS planetary gearbox series. They have been developed for applications that do not require extremely low torsional play.

- low torsional play
- high output torques
- patented PCS® (precision connection)
- high efficiency (96%, depending on ratio)
- 22 ratios  $i=3, \dots, 512$
- low noise
- high quality (ISO 9001)
- any desired installation position
- simple motor attachment
- lubricated for life

*PLS gearbox* Our customers' requirements are reflected by innovative solutions in our products. The PLS series represents absolute precision and can be found in almost all aspects of mechanical engineering.

- extremely low torsional play (<3')
- high output torques
- patented NIEC® as option (optimised for high speed)
- patented PCS® (precision connection)
- high efficiency (98%, depending on ratio)
- honed gear teeth
- 14 ratios  $i=3, \dots, 100$
- low noise (<65dBA)
- high quality (ISO 9001)
- any desired installation position
- simple motor attachment
- lubricated for life

### 3.3.1 PLE gearbox

#### Technical data PLE gearboxes

Size of PLE		40	60	80	120	160
Service life	h	10000	10000	10000	10000	10000
Max. radial force <sup>1) 2)</sup>	N	200	500	950	2000	6000
Max. axial force <sup>1) 2)</sup>	N	200	600	1200	2800	8000
Torsional play	arcmin	<30	<20	<12	<8	<6
Number of ratios		1	1	1	1	1
Efficiency at full load	%	96	96	96	96	96
Case material		Aluminium	Aluminium	Aluminium	Aluminium	Aluminium
Surface		black anodised	black anodised	black anodised	black anodised	black anodised
Shaft material		C 45	C 45	C 45	C 45	C 45
Bearings		roller bearing	roller bearing	roller bearing	roller bearing	roller bearing
Degree of protection <sup>3)</sup>		IP 54	IP 54	IP 54	IP 54	IP 54
Lubrication		life lubrication	life lubrication	life lubrication	life lubrication	life lubrication
Operating temperature <sup>4)</sup>	°C	-25 to +90, shortly +120	-25 to +90, shortly +120	-25 to +90, shortly +120	-25 to +90, shortly +120	-25 to +90, shortly +120
Weight	kg	0.35	0.9	2.1	6.0	18

1) the details are based on min. 10000 h service life with an output shaft speed of  $n_2 = 100\text{min}^{-1}$  and application factor  $KA=1$  and S1 operating mode for electric machines and  $T=30^\circ\text{C}$

2) based on the centre of the output shaft

3) at installation position IM V3 (drive shaft vertical, shaft end up) only safety class IP 41 is guaranteed

4) based on the case surface

All information refers to a single-stage gearbox.

3.3.1.1 Dimensional drawing

Dimensions PLE gearboxes

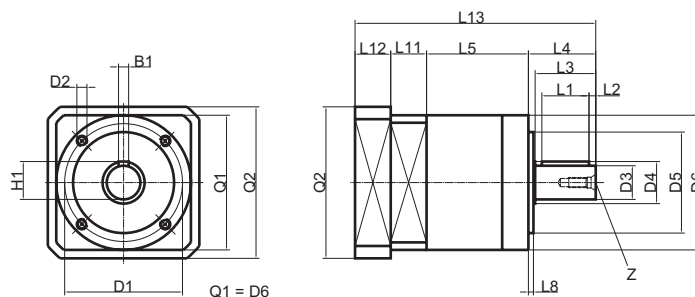

Size of PLE		60	80	80	120	160
Combination options		SER36x	SER39x	SER311x	SER39x SER311x	SER311x
Flange hole circle	D1	52	70	70	100	145
Screw-in thread	D2	M5*8	M6*10	M6*10	M10*16	M12*20
Shaft diameter	D3	14	20	20	25	40
Shaft stub	D4	17	25	25	35	55
Centring	D5	40	60	60	80	130
Case diameter	D6	60	80	80	115	160
Adapter flange cross section	Q2	60	90	115	115	140
Centring hole <sup>1)</sup>	Z	M5*12	M6*16	M6*16	M10*22	M16*36
Parallel key height <sup>2)</sup>	H1	16	22.5	22.5	28	43
Parallel key width <sup>2)</sup>	B1	5	6	6	8	12
Parallel key length <sup>2)</sup>	L1	25	28	28	40	65
Distance from shaft end	L2	2.5	4	4	5	8
Shaft length to collar	L3	30	36	36	50	80
Output shaft length	L4	35	40	40	55	87
Case length	L5	47	60.5	60.5	74	104
Output centring collar	L8	3	3	3	4	5
Intermediate flange length	L11	8.2	12	12	25.5	-
Adapter flange length	L12	16	21.2	31.2	21.8	64.5
Total length	L13	106.2	133.7	143.7	176.3	255.5

1) Centring hole DIN 332, sheet 2, form DS

2) Parallel key height DIN 6885 T1

All information refers to a single-stage gearbox.

### 3.3.2 PLS gearbox

#### Technical data PLS gearboxes

Size of PLS		70	90	115	142
Service life	h	20000	20000	20000	20000
Max. radial force <sup>1) 2)</sup>	N	3000	4000	5000	8000
Max. axial force <sup>1) 2)</sup>	N	6000	9000	12000	19000
Torsional play	arcmin	<3	<3	<3	<3
Number of ratios		1	1	1	1
Efficiency at full load	%	98	98	98	98
Case material		Aluminium	Aluminium	Aluminium	Aluminium
Surface		black anodised	black anodised	black anodised	black anodised
Shaft material		C 45	C 45	C 45	C 45
Bearings		roller bearing	roller bearing	roller bearing	roller bearing
Degree of protection <sup>3)</sup>		IP 54	IP 54	IP 54	IP 54
Lubrication		Life lubrication	Life lubrication	Life lubrication	Life lubrication
Operating temperature <sup>4)</sup>	°C	-25 to +100, shortly +124	-25 to +100, shortly +124	-25 to +100, shortly +124	-25 to +100, shortly +124
Weight	kg	3.0	4.3	9.0	15.4

1) the details are based on min. 20000 h service life with an output shaft speed of  $n_2=100^{-1}$  and application factor  $KA=1$  and S1 operating mode for electric machines and  $T=30^{\circ}\text{C}$

2) based on the centre of the output shaft and 50% ED

3) at installation position IM V3 (drive shaft vertical, shaft end up) only safety class IP 41 is guaranteed

4) based on the case surface

All information refers to a single-stage gearbox.

3.3.2.1 Dimensional drawing

Dimensions PLS gearboxes

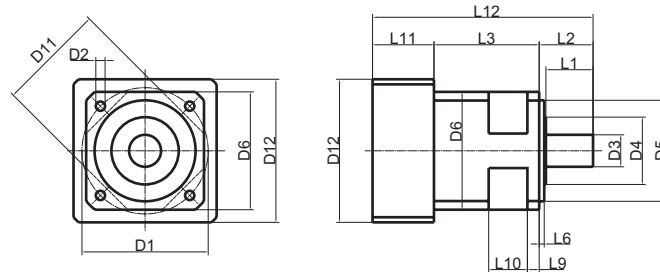

Size of PLS		70	70	90	90	115	142
Combination options		SER36x	SER39x	SER39x	SER311x	SER39x SER311x	SER311x
Flange hole circle	D1	75	75	100	100	130	165
Screw-in hole	D2	5.5	5.5	6.5	6.5	8.5	11
Shaft diameter	D3	19	19	22	22	32	40
Shaft stub	D4	40	40	50	50	55	65
Centring	D5	60	60	80	80	110	130
Gearbox cross section	D6	70	70	90	90	115	140
Cut-out	D11	64	64	87	87	115	140
Motor flange cross section	D12	70	90	90	115	115	140
Shaft length to collar	L1	28	28	36	36	58	80
Output shaft length	L2	32	32	41.5	41.5	64.5	87
Case length	L3	62.5	62.5	69	69	77.5	102
Output centring collar	L6	3	3	3	3	4	5
Flange thickness	L9	7	7	8	8	14	20
Cut-out width	L10	23	23	30	30	34	52
Motor flange length	L11	29.5	36.5	40	50	46	64.5
Total length	L12	124	131	150.5	160.5	188	253.5

All information refers to a single-stage gearbox.

3.3.3 Gearbox models

<i>Type code gearboxes</i>	
Example:	SER 3 X X / 4 L 3 S M O T O IP41 X X X XX XXX
Gearbox type:	SER 3 X X / 4 L 3 S M O T O IP41 X X X XX XXX
2 - PLE 60 (S) <sup>1)</sup>	
3 - PLE 80 (S)	
4 - PLE 120 (S)	
5 - PLE 160 (a.A.)	
A - PLS 70 (S)	
B - PLS 90 (S)	
C - PLS 115 (S)	
D - PLS 142 (a.A.)	
E - PLS 190 (a.A.)	
H - WPLE 60 (a.A.)	
I - Integrated (RIG)	
J - WPLE 80 (a.A.)	
K - WPLE 120 (a.A.)	
O - without gearbox	
P - WPLS 70 (a.A.)	
Q - WPLS 90 (a.A.)	
R - WPLS 115 (a.A.)	
S - WPLS 142 (a.A.)	
T - WPLS 190 (a.A.)	
Gear ratio:	SER 3 X X / 4 L 3 S M O T O IP41 X X X XX XXX
3 - 3:1 (S)	
4 - 4:1 (a.A.)	
5 - 5:1 (S)	
8 - 8:1 (S)	
9 - 9:1 (a.A.)	
A - 10:1 (a.A.)	
B - 12:1 (a.A.)	
C - 15:1 (a.A.)	
D - 16:1 (a.A.)	
E - 20:1 (a.A.)	
F - 25:1 (a.A.)	
G - 32:1 (a.A.)	
H - 40:1 (a.A.)	
I - 60:1 (a.A.)	
J - 64:1 (a.A.)	
K - 80:1 (a.A.)	
L - 100:1 (a.A.)	
M - 120:1 (a.A.)	
N - 160:1 (a.A.)	
O - without gearbox	
P - 200:1 (a.A.)	
Q - 256:1 (a.A.)	
R - 320:1 (a.A.)	
S - 512:1 (a.A.)	

1) (S) = Standard, (a.A.) = on request





## 4 Installation



### **DANGER!**

#### **Electric shock, fire or explosion**

- Only technicians who are familiar with and understand the contents of this manual and the other relevant manuals are authorised to work on and with this drive system.
- Before working on the drive system:
  - Switch off power to all terminals.
  - Place a sign "DO NOT SWITCH ON" on the switch and lock to prevent its being switched on.
  - Allow the DC bus capacitors to discharge (see power amplifier manual).
  - Check that there is no power.
- Do not short-circuit DC bus or touch unshielded components or screws of the terminals under voltage.
- Install all covers and close the housing doors before applying power.
- The motor generates voltage when the shaft is rotated. Lock the shaft of the motor to prevent rotation before starting work on the drive system.
- AC voltages may jump over unused wires in the motor cable. Isolate unused wires at both ends of the motor cable.
- The system manufacturer is responsible for compliance with all applicable regulations relevant to earthing the drive system. Extend the earth through the motor cable with an additional earth at the motor housing.



### **WARNING!**

#### **Strong electromagnetic fields may cause injury and interference.**

Motors can generate strong localised electrical and magnetic fields. This can cause interference in sensitive devices.

- Keep persons with pacemakers clear of the motor.
- Do not place any sensitive devices near the motor.

## 4.1 Before assembly

- Read this manual carefully, particularly the chapter on safety and follow all safety instructions. Familiarise yourself with the power controller manual also. This will minimise the accident risk and prevent damage to the drive and to your system.
- Before assembly obtain all required tools, instruments, testing aids and equipment.
- Before assembly check the drive system for visible damage caused by incorrect transport or storage. Damaged drive systems must not be installed to prevent any danger to persons or the machine.
- Check the name plate to ensure that the motor is actually suitable for the intended application.
- Make sure that the required environmental conditions for operation will be maintained.
- The shaft ends of the SER and RIG servomotors are coated to prevent corrosion. The coating must be removed with standard industrial cleaners and a soft cloth. Follow the safety instructions of the manufacturer of the cleaning agent. Avoid direct skin and sealing material contact with the preserving agent or the industrial cleaner. Make sure that there is no corrosion damage to the motor flange or the shaft ends.
- Make sure that the attachment for the motor flange is stable, clean, free of chips and does not oscillate or vibrate. Check that the system side conforms with all dimensions and tolerances.
- With a motor with a holding brake check that the brake reaches the holding torque specified in the data sheet.

## 4.2 Installation of the motor



### WARNING!

**Electrostatic discharges may cause injury and damage to the drive.**

In rare cases electrostatic discharges (ESD) at the shaft caused by a fault in the sensor system may cause unexpected motions of the drive and damage the system.

- Use conductive components (e.g. antistatic belts) or other suitable measures for preventing charge separation by motion

**CAUTION!****Failure of the drive by mechanical damage.**

If the maximum allowable forces on the shaft are exceeded, this will result in accelerated bearing wear or shaft breakage.

- Do not exceed the maximum allowable axial and radial forces.
- Protect the shaft against impact.
- Do not exceed the maximum allowable axial force even when pressing on output components.

**CAUTION!****The gearbox can be destroyed by overload.**

Exceeding the allowable torques will cause accelerated wear, shaft breakage or blocking.

- Do not exceed the peak gearbox torque in any operating status.
- Limit the motor torque if there is a danger of destruction of the gearbox by peak torques.
- Limit the torque in short-time operation (e.g. in an EMERGENCY STOP situation) to twice the continuous gearbox output torque  $M_{dG}$

**CAUTION!****Hot surfaces can cause burns and damage to system components!**

The drive temperature can exceed 100°C in some conditions.

- Avoid contact with the hot drive.
- Do not place heat-sensitive components in the immediate vicinity of the drive.
- Follow the actions described for heat dissipation.
- Check the temperature of the drive during the test run.

**WARNING!****Danger of injury and damage to system components by loss of degree of protection**

Foreign bodies, deposits or humidity can cause unexpected device responses.

- Prevent any foreign bodies from entering the terminal unit.
- Check that seals and cable glands are correctly seated.

*Installation position* Our motors can be installed in any desired position; under DIN EN 60034-7 the following installation positions are defined and approved:

- IM B5 drive shaft horizontal
- IM V1 drive shaft vertical, shaft end down
- IM V3 drive shaft vertical, shaft end up



### **WARNING!**

**Unexpected motion and destruction of the drive may cause injury.**

If drives are installed with the shaft end up (IM V3) and liquid collects at the shaft end over an extended period, it may enter the drive and damage it.

- Prevent liquid from collecting at the shaft end for extended periods.

*Installation* When attaching the motor to fastening flange, make sure that the motor is carefully aligned and has an even contact. Carefully tighten all fastening screws to the specified torque and ensure that there is no tension.

*Attaching output components* Attach output components such as pulleys, clutch etc. with suitable equipment and tools. The maximum effective axial and radial forces on the shaft must not exceed the values specified for the maximum shaft load. If the output component is incorrectly attached, the sensor for position capture may be damaged.

Follow the installation directions of the manufacturer of the output component. Both motor and output component must be precisely aligned both axially and radially. Neglect will result in noisy running, bearing damage and fast wear.

## 4.3 Electrical installation

### 4.3.1 Connecting the motor

Our motors are not designed for direct connection to mains power; they must be operated with a suitable power amplifier.



#### **WARNING!**

##### **Unexpected motion may cause injury and damage to the system**

Drives can make unexpected movements if incorrectly connected or because of other faults.

- Operate the motor with approved power amplifiers only. Even if power amplifiers are similar, different adjustment of the sensor system may be a source of danger.
- Check the wiring. Compatibility is not assured even with matching connectors for power connections and sensor system from a different manufacturer.
- Only start the system if there are no persons or materials in the danger zone and the system can be operated safely.
- Conduct test runs first without coupled loads.
- Do not touch the shaft of the motor or the attached output components.



#### **WARNING!**

##### **Interference with signals and devices may cause injury**

Distorted signals can cause unexpected device responses.

- Install the wiring in accordance with the EMC requirements.
- Check compliance with the EMC requirements, particularly in an environment subject to strong interference.



#### **CAUTION!**

##### **Overheating the plug may cause fire.**

The power plug connector may overheat and fuse contacts by arcing if the plug is not correctly connected and the cap is not tightly screwed in place.

- Make sure that plug is correctly connected and the plug cap is tight.

Motor and sensor system plugs can be removed and reconnected under power.

*Fully finished motor and sensor system connections in many different lengths are available for our drive solutions. Contact your dealer.*



*EMC requirement:  
Run motor wiring alone* When planning the wiring make sure that the motor wiring is laid separately. It must never be laid in a conduit together with power, control or sensor lines or fastened parallel with wiring clamps.

*EMC requirement:  
motor and motor sensor wiring* Motor leads and motor sensor cables are especially critical signal lines. Use the cables recommended by your local representative. They must be tested for EMC safety and must be suitable for trailing cables.

The motor wiring and the motor sensor wiring on the drive solution must be laid out over a wide area with low resistance on the unit, the switch cabinet output and on the motor.

- ▶ Lay out motor and motor sensor wiring without interruption (do not install switch components) from the motor and sensor to the unit. If a line has to be interrupted, shielded connections and metal casing must be used to prevent interference.
- ▶ Lay the motor wiring at least 20 cm from the signal wiring. If the distance is less than this, the motor cable and signal cables must be separated by grounded screening plates.
- ▶ For long lines bonding conductors with a suitable cross section must be used

*EMC requirement:  
Mains and motor connection* Great care is required when connecting the mains power and the motor to the power controller, because the danger of uncontrolled overcoupling is greatest here.

- ▶ Lay mains and motor wiring well apart (> 25 cm).
- ▶ Keep motor wiring as short as possible.
- ▶ Keep unshielded leads of the motor wiring (e.g. U,V,W) on the device and motor as short as possible.

This is the only way to prevent the formation of active and passive antennas.

*EMC requirement:  
Earth band* Connect the motor to earth with an earth band > 8mm<sup>2</sup> to ensure correct function without interference.

*fully fabricated  
Motor and sensor system wiring* Use only the fully fabricated and tested connection lines that we supply for the motor connection and to connect the sensor system. They are optimally designed for these drive solutions.

Place the sleeve of the motor wiring on the motor plug connector and tighten the screw cap. Proceed in the same way with the sensor system connection line. Connect the motor wiring and the sensor system wiring with the power controller as specified by the circuit diagram of the power controller. If your motor is fitted with a holding brake, please follow the instructions on 4.3.2 "Electrical control of the holding brake".

*PE conductor connection* For safety reasons a redundant PE conductor connection is recommended.

### 4.3.2 Electrical control of the holding brake

A motor with a holding brake requires appropriate control logic which releases the brake exactly at the start of a rotary motion and fixed the motor axis when the motor is stopped.

*Control circuit*

Use a suitable holding brake controller, such as the Berger Lahr TLHBC. The current of the brake voltage must be reduced after approximately 100 ms, otherwise the additional heating will make it impossible to guarantee the published torque characteristics. The holding brake controller must have safe electrical isolation of the brake power supply and comply with EMC standard DIN EN 8008-3.

*Special feature of SER36x*



#### **CAUTION!**

##### **Brake malfunction!**

The brake cannot release because of incorrect voltage.

- Check the voltage polarity. If the voltage polarity is incorrect the brake will not release.
- Check the voltage. The brake may close again if the voltage exceeds the specified value.

## 4.4 Plugs and plug assignments

*Motor connection*

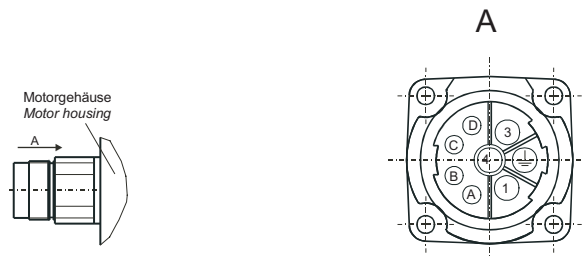

Manufacturer: Intercontec,  
power plug connector 8-pole, BEGA089NN0000 0002 000

PIN	Assignments
1	U
2	PE
3	W
4	V
A	brake +
B	brake -
C	not assigned
D	not assigned



*Sensor connection  
SinCos Encoder*

Sensor plug SinCos Encoder (SINGLE-TURN and MULTI-TURN)

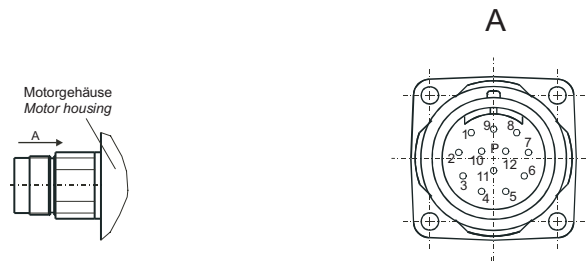

Manufacturer: Intercontec,  
signal plug connector 12-pole, AEGA052NN0000 1250 000

PIN	Assignments
1	Temperature sensor PTC/NTC
2	Temperature sensor PTC/NTC
3	not assigned
4	REF SIN
5	REF COS
6	Data+ RS 485
7	Data- RS 485
8	+ SIN
9	+ COS
10	$U_s$ 7-12 V
11	GND
12	not assigned

PTC: S+M, Model B59135-M155-A70

NTC: S+M, Model B57227

Sensor connection  
Resolver

Sensor plug resolver

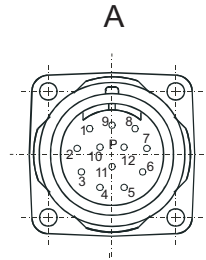
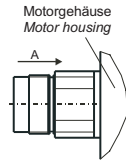

Manufacturer: Intercontec,  
signal plug connector 12-pole, AEGA052NN0000 1250 000

PIN	Assignments
1	Temperature sensor PTC/NTC
2	Temperature sensor PTC/NTC
3	not assigned
4	- SIN
5	- COS
6	REF +
7	REF -
8	+ SIN
9	+ COS
10	not assigned
11	not assigned
12	not assigned

PTC: S+M, Model B59135-M155-A70

NTC: S+M, Model B57227

Sensor connection  
Digital Encoder

Digital encoder sensor plug (DiCoder)

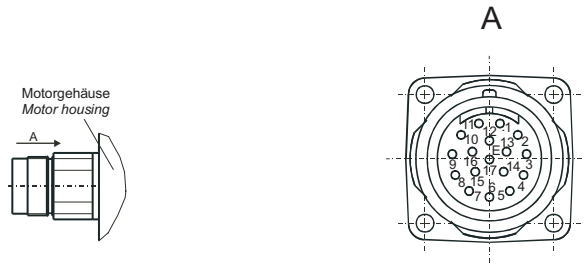

Manufacturer: Intercontec,  
signal plug connector 17-pole, AEGA113NN0000 013 000

PIN	Assignments
1	Temperature sensor PTC/NTC
2	Temperature sensor PTC/NTC
3	Sense (plus)
4	A negation
5	B negation
6	Hall A
7	Hall B
8	A
9	B
10	Hall C
11	^ 5V
12	+ 5V
13	index pulse C
14	index pulse C negation
15	Hall A negation
16	Hall B negation
17	Hall C negation

PTC: S+M, Model B59135-M155-A70  
NTC: S+M, Model B57227

### 4.4.1 Calculation of the plug insertion space

Principle diagram

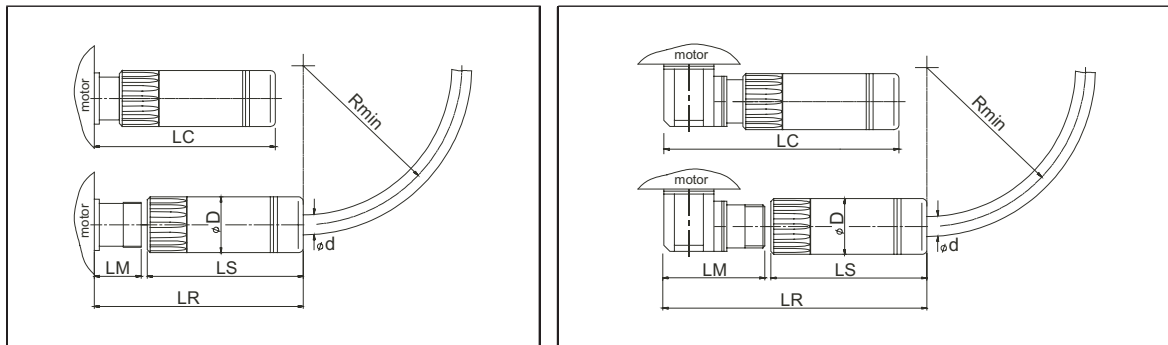

**General rule** The following applies as a general rule for calculation of the plug insertion space  $R_{min}$ :

- stationary wiring:  $R = 7.5 \cdot d$
- trailing cables (moving):  $R = 7.5 \cdot d$

With the allowable temperatures a distinction is made between stationary and moving:

- stationary wiring:  $-40^{\circ}\text{C}$  to  $+85^{\circ}\text{C}$
- trailing cables (moving):  $-20^{\circ}\text{C}$  to  $+85^{\circ}\text{C}$

#### 4.4.1.1 Plug technical data

Dimensions (mm)	Motor plug	Sensor system plug
D	28	26
LS	79	54
LR	115	80
LC	95	65
LM	34	24

Table 4.1 Plug data (see diagram above)

Cross section (mm <sup>2</sup> )	d (mm)	Tolerance (mm)	Allowable voltage (V)
1.5	10.5	± 0.3	800
2.5	14.3	± 0.3	800
4	16.3	± 0.3	800

Table 4.2 Motor connection wiring data

Cross section (mm <sup>2</sup> )	d (mm)	Tolerance (mm)
	8.8	± 0.2

Table 4.3 Sensor connection wiring data

## 5 Commissioning



### **DANGER!**

#### **Electric shock, fire or explosion**

- Only technicians who are familiar with and understand the contents of this manual and the other relevant manuals are authorised to work on and with this drive system.
- Before working on the drive system:
  - Switch off power to all terminals.
  - Place a sign "DO NOT SWITCH ON" on the switch and lock to prevent its being switched on.
  - Allow the DC bus capacitors to discharge (see power amplifier manual).
  - Check that there is no power.
- Do not short-circuit DC bus or touch unshielded components or screws of the terminals under voltage.
- Install all covers and close the housing doors before applying power.
- The motor generates voltage when the shaft is rotated. Lock the shaft of the motor to prevent rotation before starting work on the drive system.
- AC voltages may jump over unused wires in the motor cable. Isolate unused wires at both ends of the motor cable.
- The system manufacturer is responsible for compliance with all applicable regulations relevant to earthing the drive system. Extend the earth through the motor cable with an additional earth at the motor housing.

### 5.1 Preparing for commissioning

#### Before commissioning check

- ▶ the correct mechanical installation: take particular note of correctly installed screws at the flange and tension-free alignment of the motor.
- ▶ the correctly conducted electrical installation: in particular check the PE conductor connections and earth connections. Make sure that all connections on the motor and to the power controller are correctly made and connected and that cable fasteners are tight.
- ▶ the correct isolation of unused reserve wires: unused lines must be correctly isolated at both ends, because induction currents may also flow in unused wires in drive systems.
- ▶ the guards to prevent contact: the appropriate guards must be installed to prevent contact with electrical and mechanical or moving parts.
- ▶ the environmental and operation conditions: make sure that the specified environmental conditions are maintained and that the

drive solution matches the operating conditions as specified on the name plate.

- ▶ the output components: check that the output components, which may be already installed, are balanced and precisely aligned.
- ▶ the parallel key at the shaft end of the motor: if you have a motor with a parallel key groove and parallel key, the parallel key must not be inserted when commissioning without output component or it must be appropriately secured.
- ▶ the function of the holding brake: check that the holding torque of the brake as specified in the data sheet is reached. Make sure that the holding brake is ventilated after applying the brake voltage.

## 5.2 Running commissioning



### WARNING!

#### Unexpected motion may cause injury and damage to the system

Drives can make unexpected movements if incorrectly connected or because of other faults.

- Operate the motor with approved power amplifiers only. Even if power amplifiers are similar, different adjustment of the sensor system may be a source of danger.
- Check the wiring. Compatibility is not assured even with matching connectors for power connections and sensor system from a different manufacturer.
- Only start the system if there are no persons or materials in the danger zone and the system can be operated safely.
- Conduct test runs first without coupled loads.
- Do not touch the shaft of the motor or the attached output components.



### WARNING!

#### Rotating parts may cause injury and damage to the system.

Rotating parts may cause injuries and may catch clothing or hair. Loose parts or parts that are unbalanced may be thrown clear.

- After installation check all rotating parts (parallel keys, clutch, ..).
- Use a guard as protection against rotating parts.

**WARNING!****Danger of injury and damage to system components by unbraked motor.**

In case of power failure and faults that cause the power amplifier to switch off, the motor will no longer be actively braked and will run on to a mechanical stop, possibly at high speed.

Overload or faults can cause danger by failure of the holding brake. Incorrect use of the holding brake results in accelerated wear and failure.

- Do not use the internal brake as a service brake.
- If necessary, use a damped mechanical stop or a service brake.
- Check the function of the brake.
- In addition, secure the danger area to prevent entry.
- The brake function must be checked again after frequent EMERGENCY STOP braking operations.

**WARNING!****Danger of injury from falling parts.**

The motor may move as a result of the reaction torque, tip and fall.

- Fasten the motor securely to prevent it from breaking loose during strong acceleration.

**CAUTION!****Hot surfaces can cause burns and damage to system components!**

The drive temperature can exceed 100°C in some conditions.

- Avoid contact with the hot drive.
- Do not place heat-sensitive components in the immediate vicinity of the drive.
- Follow the actions described for heat dissipation.
- Check the temperature of the drive during the test run.





## 6 Diagnostics and troubleshooting

### 6.1 Mechanical faults

Error	Cause	Troubleshooting
excessive heat	overload	reduce load
	brake not open	check brake controller
	excessive dirt	clean motor
whistling or knocking noise	defective bearing	contact service
grinding noise	rotating output component is grinding	align output component
radial oscillation	output component incorrectly aligned	align output component
	output component unbalanced	balance output component
	shaft bent	contact service
	resonance in fastening	check stiffness of motor fastening
axial oscillation	output component incorrectly aligned	align output component
	output component impacts	check output component
	resonance in fastening	check stiffness of motor fastening

### 6.2 Electrical faults

Error	Cause	Troubleshooting
motor does not run or runs heavily	overload	reduce load
	error in power controller	check power controller
	connection line defective or not connected, phase/interturn fault	check connection lines
	temperature sensor in motor and temperature evaluation of power controller do not match (NTC/PTC)	check, contact service
excessive heat	overload	reduce power
heat build-up at connection terminals	plug loosened or not tightened	tighten plug



## 7 Service, maintenance and disposal



### **DANGER!**

#### **Electric shock, fire or explosion**

- Only technicians who are familiar with and understand the contents of this manual and the other relevant manuals are authorised to work on and with this drive system.
- Before working on the drive system:
  - Switch off power to all terminals.
  - Place a sign "DO NOT SWITCH ON" on the switch and lock to prevent its being switched on.
  - Allow the DC bus capacitors to discharge (see power amplifier manual).
  - Check that there is no power.
- Do not short-circuit DC bus or touch unshielded components or screws of the terminals under voltage.
- Install all covers and close the housing doors before applying power.
- The motor generates voltage when the shaft is rotated. Lock the shaft of the motor to prevent rotation before starting work on the drive system.
- AC voltages may jump over unused wires in the motor cable. Isolate unused wires at both ends of the motor cable.
- The system manufacturer is responsible for compliance with all applicable regulations relevant to earthing the drive system. Extend the earth through the motor cable with an additional earth at the motor housing.

### 7.1 Service address



*If you have any questions please contact your local dealer. Your dealer will be happy to give you the name of a customer service outlet in your area.*

Have any repairs to our drive systems conducted only by a repair service that we have certified. Do not make any mechanical or electrical modifications to the drive components. We will not honour the warranty or accept any liability if unauthorised modifications are made or the system is opened.

Repairs cannot be made with the device installed.

## 7.2 Maintenance



### WARNING!

**Danger of injury and damage to system components by unbraked motor.**

In case of power failure and faults that cause the power amplifier to switch off, the motor will no longer be actively braked and will run on to a mechanical stop, possibly at high speed. Overload or faults can cause danger by failure of the holding brake. Incorrect use of the holding brake results in accelerated wear and failure.

- Do not use the internal brake as a service brake.
- If necessary, use a damped mechanical stop or a service brake.
- Check the function of the brake.
- In addition, secure the danger area to prevent entry.
- The brake function must be checked again after frequent EMERGENCY STOP braking operations.



*Before all work on the drive system consult the chapters on Installation and Commissioning to see what precautions and processes must be observed.*

The following maintenance work is required after **50-100 operating hours**:

*Check connections*

Check all connection lines and plug connectors regularly for damage. Damage can occur particularly with lines in trailing cables or lines subject to other mechanical loads. Replace defective lines immediately.

*Lubricating shaft sealing ring*

To retain the protection class (IP 56) in motors with shaft sealing rings, lubricant must be inserted between the sealing lip of the radial shaft sealing ring and the shaft with a suitable non-metallic tool. If the shaft sealing rings are allowed to run dry the life of the sealing rings will be significantly reduced.

The following maintenance work is required after **500 operating hours or 1 year**:

*Cleaning the motor*

Clean dust and dirt off the motor, otherwise the heat dissipation of the motor will be less effective. Insufficient heat dissipation to the ambient air may increase the temperature in the bearings excessively and adversely affect the bearing lubricant. In addition, the temperature monitor may stop the drive unit even though all other conditions are within limits.

*Tightening all fasteners*

Tighten all mechanical and electrical threaded connections to the specified torque. Check the screw caps on the connection lines.

*Holding brake torque*

Check the holding torque of the brake.

## 8 Glossaries

### 8.1 Terms and Abbreviations

<i>Axial forces</i>	Tension or compression forces acting longitudinally on the shaft
<i>Centring collar</i>	centric protrusion on the motor flange to ensure precise assembly.
<i>Degree of protection</i>	The degree of protection is a standardised specification for electrical equipment that describes the protection against the entry of foreign bodies and water (for example, IP20)
<i>DiCoder</i>	digital encoder from the Stegmann company, digital sensor system for position capture
<i>EMC</i>	Electromagnetic compatibility
<i>Holding brake</i>	brake that only prevents the motor from rotating without power after it has stopped (e.g. a Z-axis lowering). It must not be used as a service brake for braking motion.
<i>Length</i>	length of motor without optional equipment (such as brake or gearbox)
<i>Multiturn</i>	sensor system for position capture of the SinCos type; after start-up it measures an absolute value within 4096 revolutions and continues to count incrementally from this point
<i>NIEC®</i>	patented process that increases the volume in the gearbox during heat build-and thus reduces the pressure on the shaft sealing ring. For fast-running applications at high torques.
<i>NTC</i>	resistance with negative temperature coefficient. Resistance value is reduced as the temperature rises.
<i>PCS®</i>	patented process for maximum precision when connecting the motor shaft to the pinion.
<i>PTC</i>	resistance with positive temperature coefficient. Resistance value is increased as the temperature rises.
<i>Radial forces</i>	forces that act radially on the shaft
<i>Shaft sealing ring</i>	a special sealing ring between the fixed flange and the rotating shaft; it increases the protection class of the motor flange. Regular lubrication of the shaft sealing ring is essential and the allowable maximum speed of the motor shaft must not be exceeded.
<i>SinCos®</i>	sensor system from the Stegmann company for position capture with an analogue sine/cosine signal; starts with absolute value and continues to count incrementally from that value.
<i>Singleturn</i>	sensor system for position capture of the SinCos type; after start-up it measures an absolute value within one revolution and continues to count incrementally from this point.
<i>Size</i>	defined by the flange size in the type code



## 9 Index

### A

Abbreviations 8-1

### B

Brake  
SER39x 3-30

### C

CE mark 1-6  
Commissioning 5-1  
preparation 5-1  
running 5-2

### D

Danger classes 2-2  
Diagnostics 6-1  
Digital encoder (DiCoder) 3-4, 3-49  
Dimensional drawing, see Dimensions  
Dimensions  
RIG311x 3-70  
RIG39x 3-59  
SER311x 3-43  
SER36x 3-16  
SER39x 3-30  
Disposal 7-1

### E

EMC  
motor cables and sensor wiring 4-6  
Requirement  
Earth band 4-6  
Mains and motor connection 4-6  
Run motor wiring alone 4-6  
environmental conditions 3-1, 3-46  
Environmental influences  
RIG3xx 3-1, 3-46

### H

Holding brake  
SER39x 3-30

### I

Intended use 2-1

### M

Maintenance 7-1  
Multiturn 3-4, 3-48

**P**

Press-on force, maximum  
RIG311x 3-67  
RIG39x 3-56

**R**

Resolver 3-4, 3-48

**S**

Schematic view  
SER39x 3-28  
Sensor  
Digital encoder 3-4, 3-49  
Multiturn 3-4, 3-48  
Resolver 3-4, 3-48  
Singleturn 3-3, 3-48  
Service 7-1  
Service address 7-1  
SinCos Multiturn 3-4, 3-48  
SinCos Singleturn 3-3, 3-48  
Singleturn 3-3, 3-48

**T**

Technical data 3-1  
Terms 8-1  
Troubleshooting 6-1

**W**

Winding-specific data  
RIG39x 3-51  
SER39x 3-20