

Absolute Maximum Ratings		Values		Units	
Symbol	Conditions ¹⁾	... 101 D	... 121 D		
V _{CES}		1000	1200	V	
V _{CGR}	R _{GE} = 20 kΩ	1000	1200	V	
I _C	T _{case} = 25/80 °C	22/15		A	
I _{CM}	T _{case} = 25/80 °C	44/30		A	
V _{GES}		± 20		V	
P _{tot}	per IGBT, T _{case} = 25 °C	150		W	
T _J , T _{stg}		-55 ... +150		°C	
V _{isol}	AC, 1 min	2 500		V	
humidity	DIN 40 040	Class F			
climate	DIN IEC 68 T.1	55/150/56			
Inverse Diode					
I _F = - I _C		22		A	
I _{FM} = - I _{CM}		44		A	
Characteristics					
Symbol	Conditions ¹⁾	min.	typ.	max.	Units
V _{(BR)CES}	V _{GE} = 0, I _C = 0,5 mA	≥ V _{CES}	-	-	V
V _{GE(th)}	V _{GE} = V _{CE} , I _C = 1 mA	4,5	5,5	6,5	V
I _{CES}	V _{GE} = 0 } T _J = 25 °C	-	-	0,5	mA
	V _{CE} = V _{CES} } T _J = 125 °C	-	-	2	mA
I _{GES}	V _{GE} = 20 V, V _{CE} = 0	-	-	100	nA
V _{CEsat}	V _{GE} = 15 V } T _J = 25 °C	-	3,5	4	V
	I _C = 22 A } T _J = 150 °C	-	4,9	5,5	V
g _{fs}	V _{CE} = 20 V, I _C = 22 A	5,5	9	-	S
C _{CHC}	per IGBT	-	-	60	pF
C _{ies}	V _{GE} = 0	-	2	-	nF
C _{oes}	V _{CE} = 25 V	-	160	-	pF
C _{res}	f = 1 MHz	-	65	-	pF
L _{CE}		-	-	20	nH
t _{d(on)}	V _{CC} = 600 V	-	40 ³⁾	-	ns
t _r	V _{GE} = 15 V	-	100 ³⁾	-	ns
t _{d(off)}	I _C = 22 A	-	150 ³⁾ /150 ⁴⁾	-	ns
t _f	R _{Gon} = R _{Goff} = 3,3 Ω	-	500 ³⁾ /100 ⁴⁾	-	ns
W _{off12} ⁵⁾	T _J = 125 °C	-	1,3 ⁴⁾	-	mWs
W _{off23} ⁵⁾		-	0,7 ⁴⁾	-	mWs
Inverse Diode SKM 22 GD 101 D					
V _F = V _{EC}	I _F = 22 A, V _{GE} = 0; (T _J = 125 °C)	-	2,2 (1,8)	2,7	V
t _{rr}	T _J = 25 °C ²⁾	-	-	-	ns
	T _J = 125 °C ²⁾	-	100	-	ns
Q _{rr}	T _J = 25/125 °C ²⁾	-	1/4	-	μC
f _s	f _s = t _f / (t _{rr} - t _f)	-	1 ²⁾	-	
Inverse Diode SKM 22 GD 121 D					
V _F = V _{EC}	I _F = 22 A, V _{GE} = 0; (T _J = 125 °C)	-	2,7 (2,2)	3,2	V
t _{rr}	T _J = 25 °C ²⁾	-	-	-	ns
	T _J = 125 °C ²⁾	-	120	-	ns
Q _{rr}	T _J = 25/125 °C ²⁾	-	1,1/4,5	-	μC
f _s	f _s = t _f / (t _{rr} - t _f)	-	1 ²⁾	-	
Thermal Characteristics					
R _{thjc}	per IGBT	-	-	0,8	°C/W
R _{thjc}	per diode	-	-	1,3	°C/W
R _{thch}	per module	-	-	0,05	°C/W

Cases and mechanical data see page B 6 – 78

¹⁾ T_{case} = 25 °C, unless otherwise specified
²⁾ I_F = - I_C, V_R = 600 V, - di_F/dt = 800 A/μs, V_{GE} = 0

³⁾ resistive load
⁴⁾ inductive load
⁵⁾ see fig. 21; R_{Goff} = 19 Ω

SEMITRANS® M IGBT Modules

SKM 22 GD 101 D
 SKM 22 GD 121 D

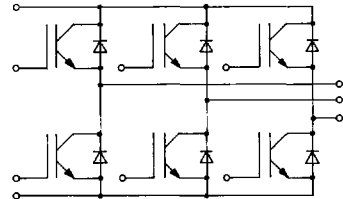
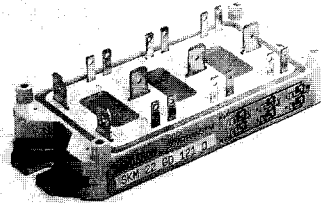

Features

- MOS input (voltage controlled)
- N channel
- Low saturation voltage
- Very low tail current
- Low temperature sensitivity
- Breakdown proof
- High short circuit capability
- No latch-up
- Fast inverse diodes
- Isolated copper baseplate
- Large clearances and creepage distances
- UL recognized, file no. E 63 532

Typical Applications

- DC servo and robot drives
- Self-commutated inverters
- AC motor speed control
- Uninterruptible power supplies
- General power switching applications
- Pulse frequencies above 15 kHz

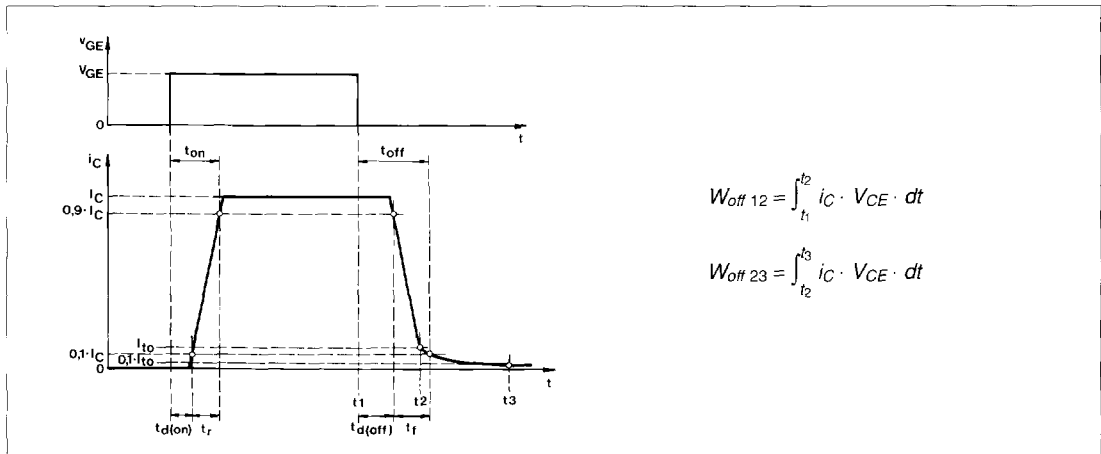

Fig. 21 Switching times and turn-off energies

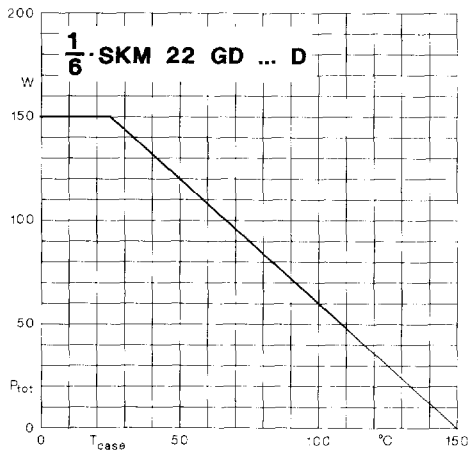

Fig. 22 Rated power dissipation vs. temperature

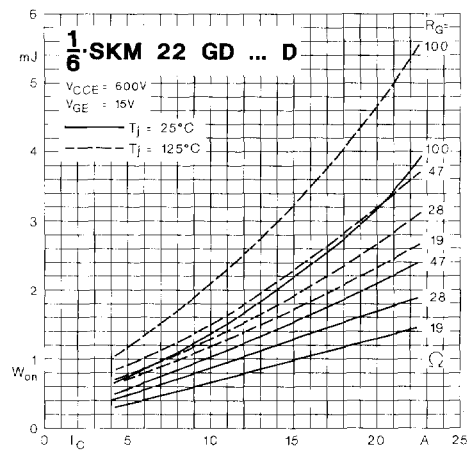

Fig. 23 Turn-on energy dissipation per pulse

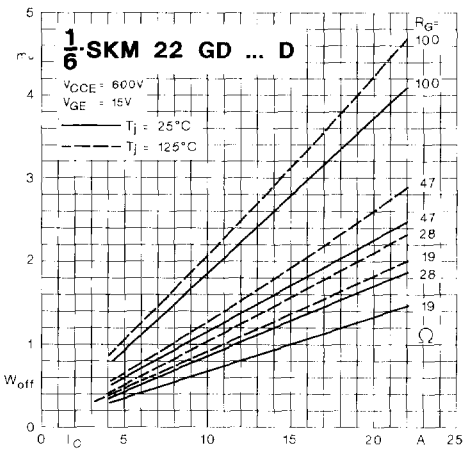

Fig. 24 Turn-off energy dissipation per pulse

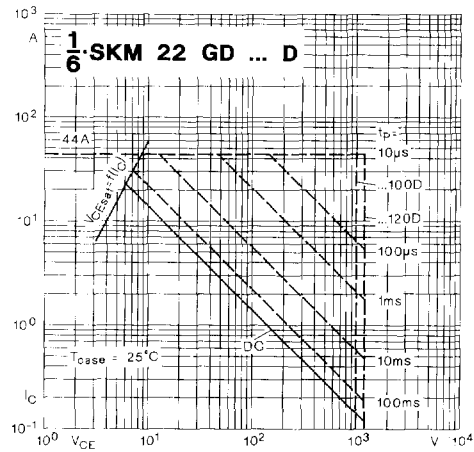

Fig. 25 Maximum safe operating area

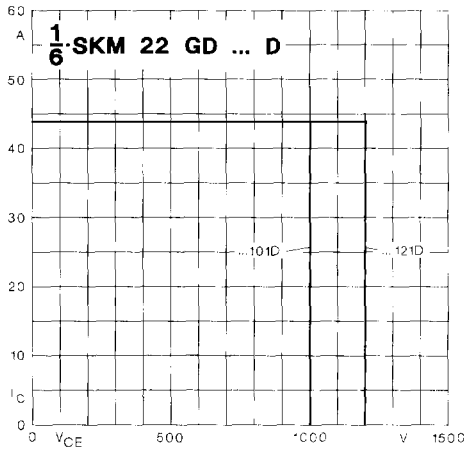

Fig. 26 Turn-off safe operating area

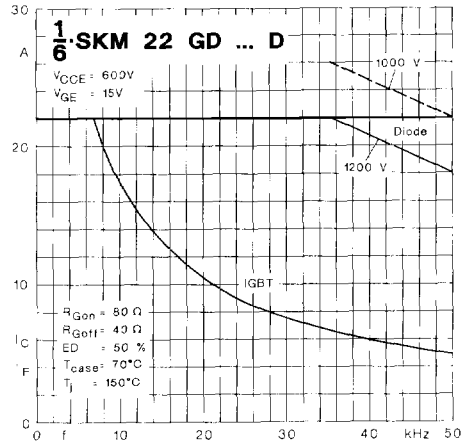

Fig. 27 Rated current vs. pulse frequency

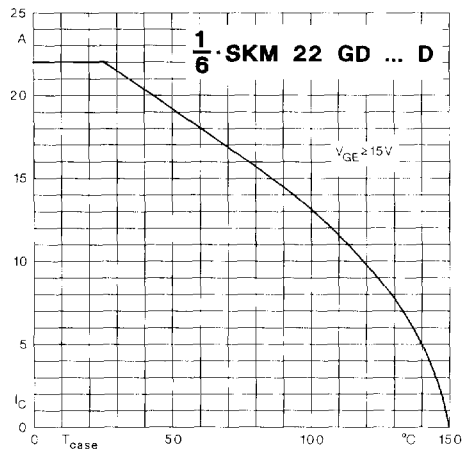

Fig. 28 Rated current vs. temperature

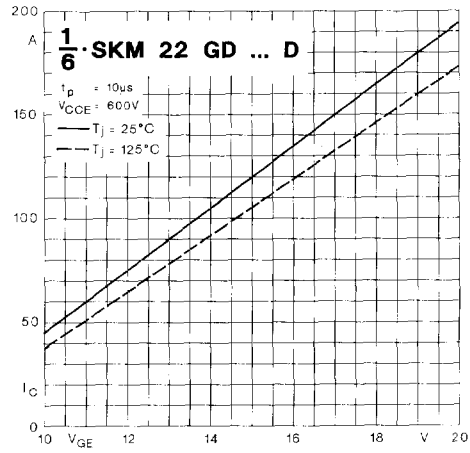

Fig. 29 Short-circuit current vs. turn-on gate voltage

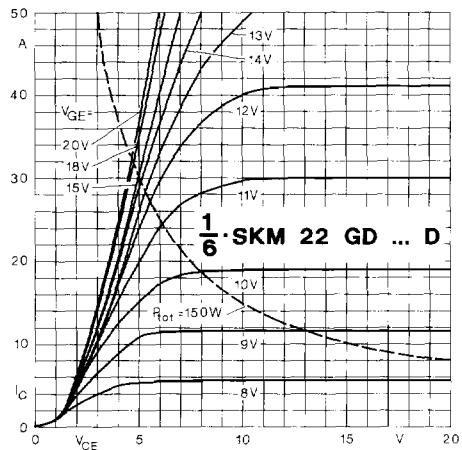

Fig. 30 Output characteristic

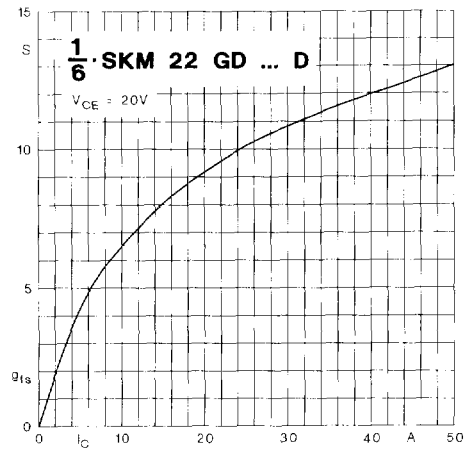

Fig. 31 Forward transconductance

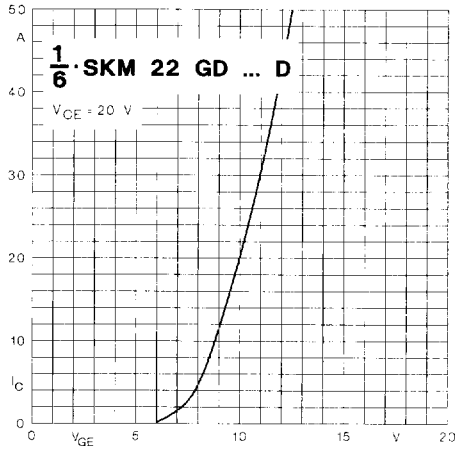

Fig. 32 Transfer characteristic

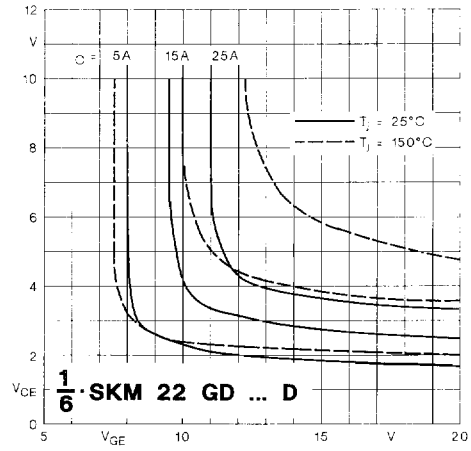

Fig. 33 Saturation characteristics

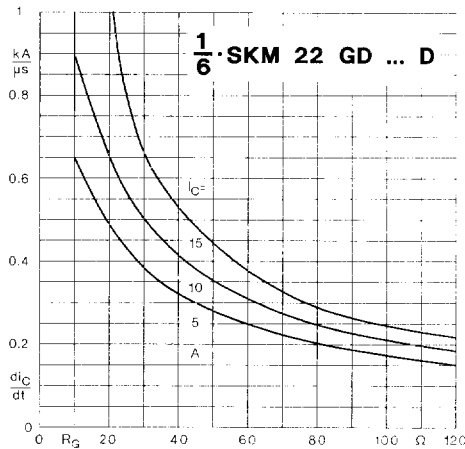

Fig. 34 Rate of rise of collector current

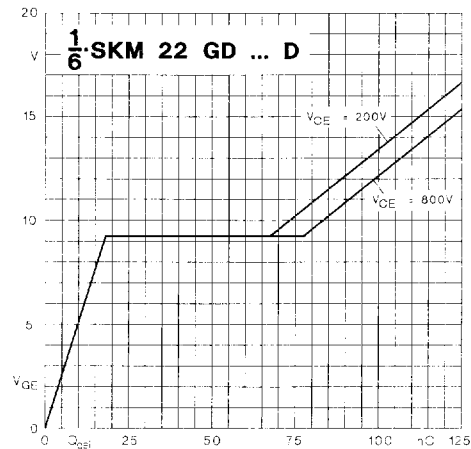

Fig. 35 Gate charge characteristic

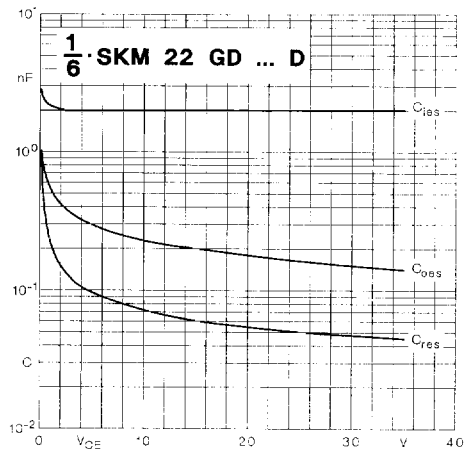

Fig. 36 Capacitances vs. collector-emitter voltage

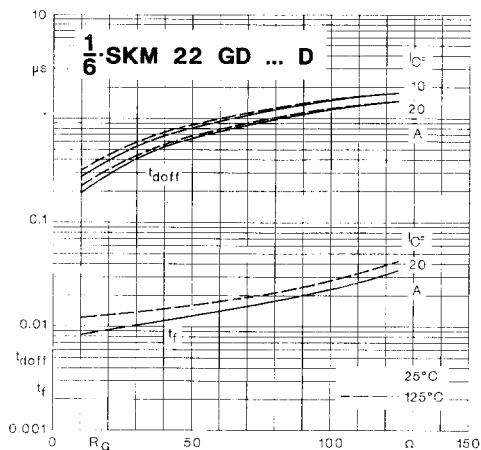

Fig. 37 Switching times vs. gate resistor

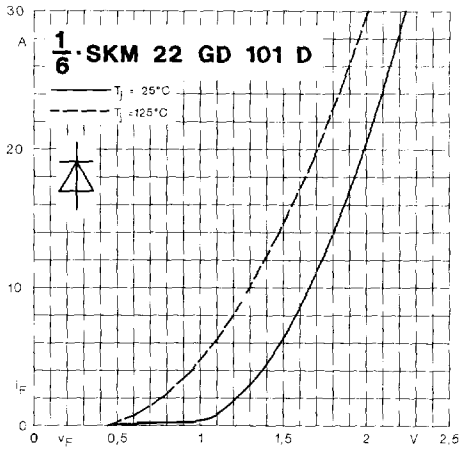

Fig. 38 a Diode forward characteristic

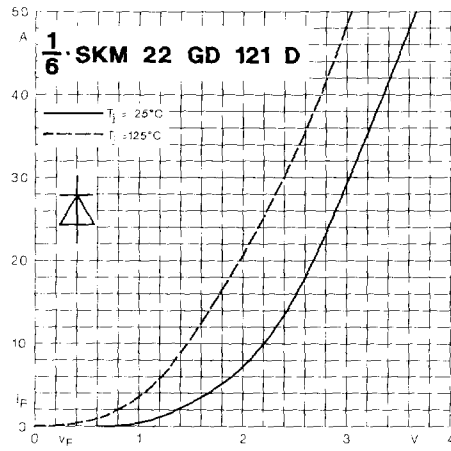

Fig. 38 b Diode forward characteristic

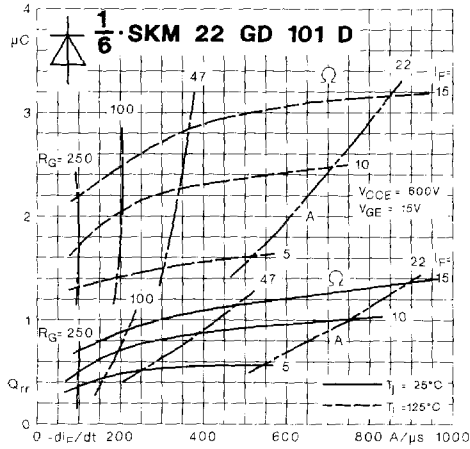

Fig. 39 a Diode recovered charge

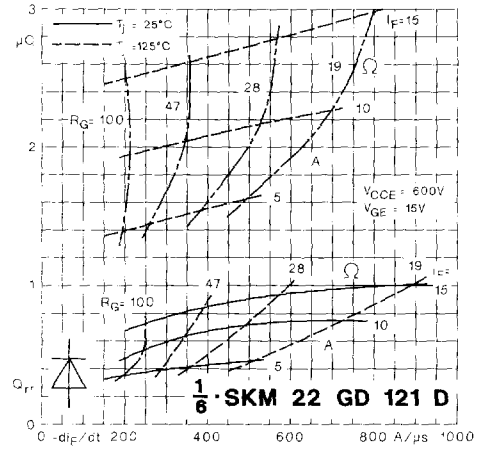

Fig. 39 b Diode recovered charge

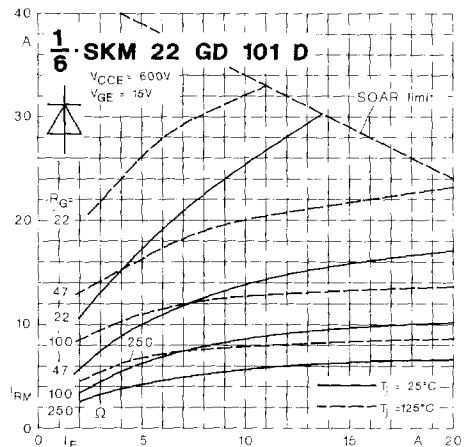

Fig. 40 a Diode peak reverse recovery current (I_{FR})

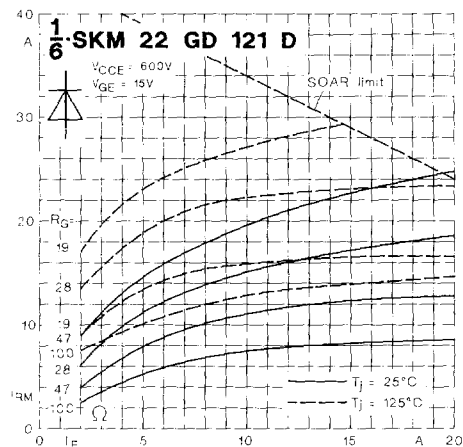

Fig. 40 b Diode peak reverse recovery current (I_{FR})

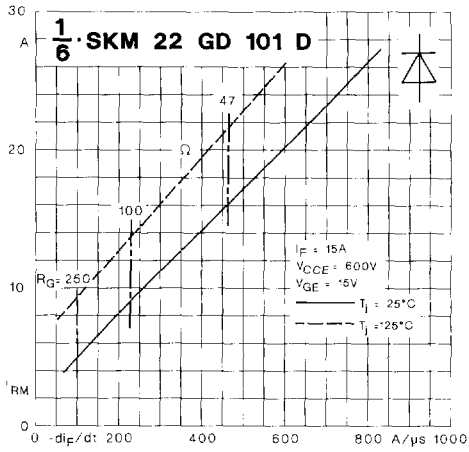

Fig. 41 a Diode peak reverse recovery current ($-di_F/dt$)

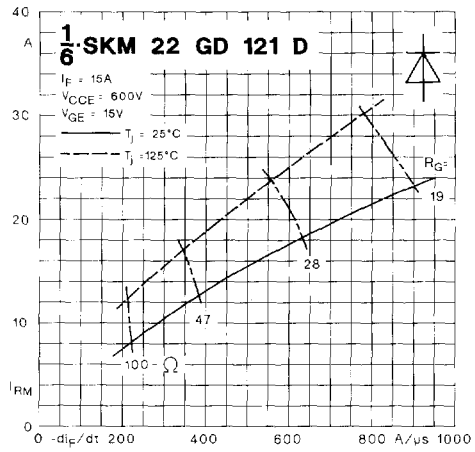

Fig. 41 b Diode peak reverse recovery current ($-di_F/dt$)

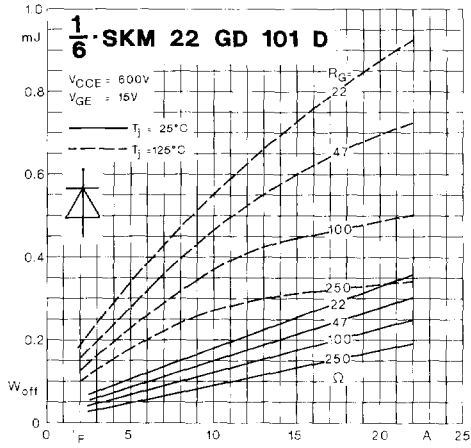

Fig. 42 a Diode turn-off energy dissipation per pulse

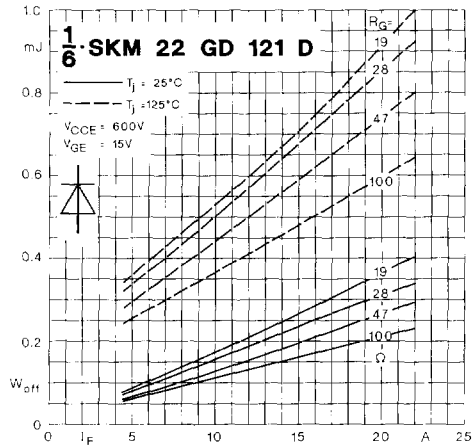

Fig. 42 b Diode turn-off energy dissipation per pulse

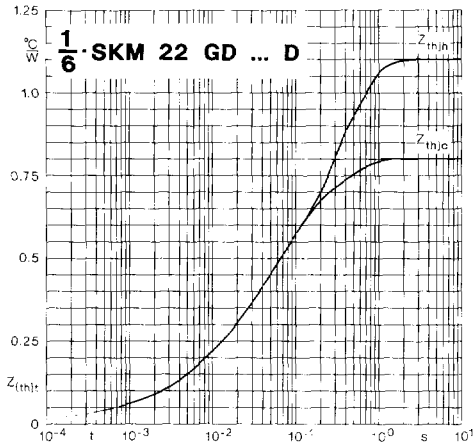

Fig. 51 Transient thermal impedance

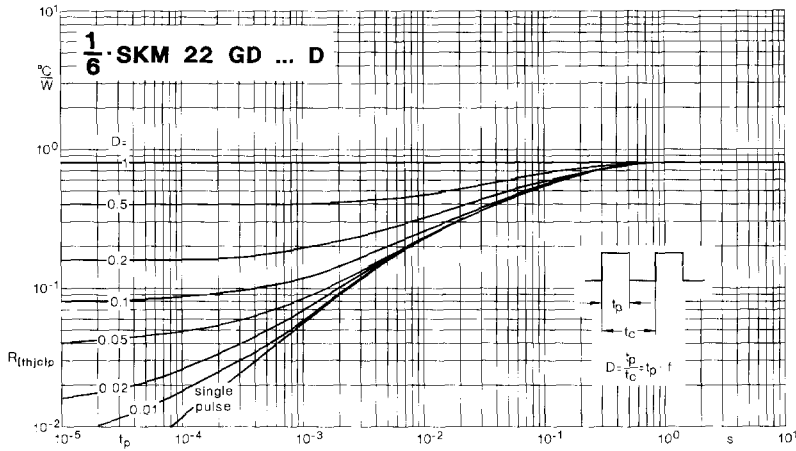

Fig. 52 Thermal impedance under pulse conditions

SKM 22 GD 101 D

SKM 22 GD 121 D

Case D 28

UL recognized, file no. E 63 532

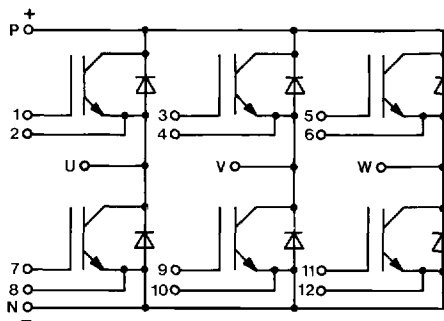
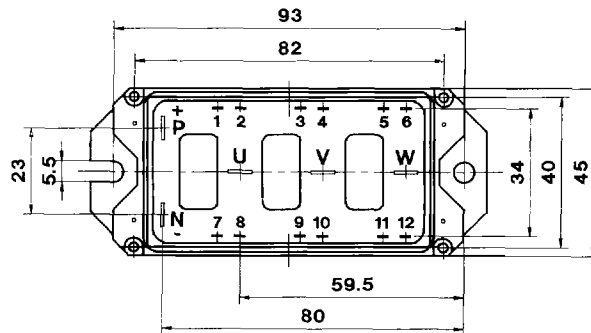
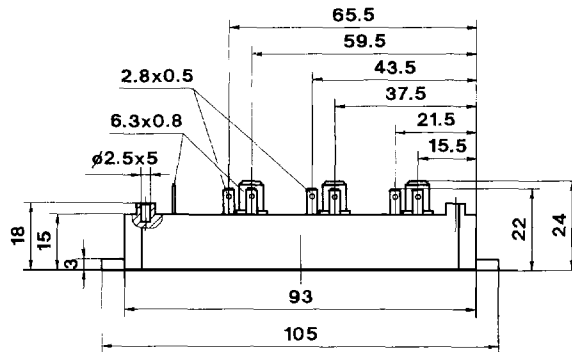

Dimensions in mm

Mechanical Data		Values			Units
Symbol	Conditions	min.	typ.	max.	
M ₁	to heatsink, SI Units	4	—	6	Nm
	to heatsink, US Units	35	—	53	lb.in.
a		—	—	5x9,81	m/s ²
w		—	—	190	g

This is an electrostatic discharge sensitive device (ESDS). Please observe the international standard IEC 747-1, Chapter IX.