

MP-Series Low-inertia Brushless Servo Motors with 75 mm or Smaller Frame Sizes

Catalog Numbers MPL-A1510, MPL-A1520, MPL-A1530, MPL-A210, MPL-A220, MPL-A230, MPL-B1510, MPL-B1520, MPL-B1530, MPL-B210, MPL-B220, MPL-B230

Topic	Page
Important User Information	2
Catalog Number Explanation	3
About the MP-Series Low-inertia Motors	4
Before You Begin	4
Install the Motor	9
Product Dimensions	13
Motor Load Force Ratings	15
Connector Data	17
Remove and Install a Shaft Key	18
Motor Cables and Accessory Kits	19
Specifications	20
Additional Resources	21

Important User Information

Read this document and the documents listed in the additional resources section about installation, configuration, and operation of this equipment before you install, configure, operate, or maintain this product. Users are required to familiarize themselves with installation and wiring instructions in addition to requirements of all applicable codes, laws, and standards.

Activities including installation, adjustments, putting into service, use, assembly, disassembly, and maintenance are required to be carried out by suitably trained personnel in accordance with applicable code of practice.

If this equipment is used in a manner not specified by the manufacturer, the protection provided by the equipment may be impaired.

In no event will Rockwell Automation, Inc. be responsible or liable for indirect or consequential damages resulting from the use or application of this equipment.

The examples and diagrams in this manual are included solely for illustrative purposes. Because of the many variables and requirements associated with any particular installation, Rockwell Automation, Inc. cannot assume responsibility or liability for actual use based on the examples and diagrams.

No patent liability is assumed by Rockwell Automation, Inc. with respect to use of information, circuits, equipment, or software described in this manual.

Reproduction of the contents of this manual, in whole or in part, without written permission of Rockwell Automation, Inc., is prohibited.

Throughout this manual, when necessary, we use notes to make you aware of safety considerations.



WARNING: Identifies information about practices or circumstances that can cause an explosion in a hazardous environment, which may lead to personal injury or death, property damage, or economic loss.



ATTENTION: Identifies information about practices or circumstances that can lead to personal injury or death, property damage, or economic loss. Attentions help you identify a hazard, avoid a hazard, and recognize the consequence.

IMPORTANT Identifies information that is critical for successful application and understanding of the product.

Labels may also be on or inside the equipment to provide specific precautions.



SHOCK HAZARD: Labels may be on or inside the equipment, for example, a drive or motor, to alert people that dangerous voltage may be present.



BURN HAZARD: Labels may be on or inside the equipment, for example, a drive or motor, to alert people that surfaces may reach dangerous temperatures.



ARC FLASH HAZARD: Labels may be on or inside the equipment, for example, a motor control center, to alert people to potential Arc Flash. Arc Flash will cause severe injury or death. Wear proper Personal Protective Equipment (PPE). Follow ALL Regulatory requirements for safe work practices and for Personal Protective Equipment (PPE).

Catalog Number Explanation

MP L - x x xx x - x J 7 x A A

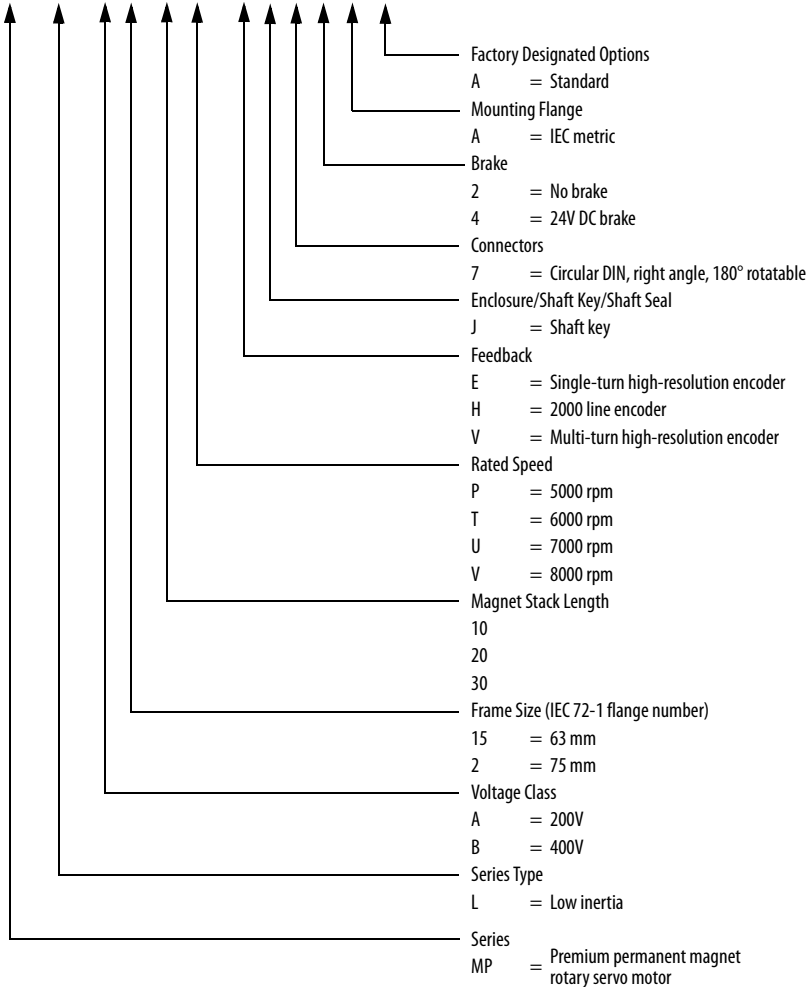

About the MP-Series Low-inertia Motors

MP-Series™ low-inertia (Bulletin MPL) motors feature single-turn or multi-turn high resolution encoders, and are available with 24V DC brakes. These compact brushless servo motors meet the demanding requirements of high-performance motion systems.

Before You Begin

Remove all packing material from within and around the item. After unpacking, verify the nameplate catalog number against the purchase order.



ATTENTION: To avoid personal injury and damage to the motor, do not lift or handle the motor by the motor shaft. The cap on the shaft can come loose and cause you to drop the motor.

1. Remove the motor carefully from its shipping container.
2. Visually inspect the motor for any damage.
3. Examine the motor frame, front output shaft, and mounting pilot for any defects.
4. Notify the carrier of any shipping damage immediately.

Keep the original packing material in case you need to return the product for repair or transport it to another location. Use both the inner and outer packing cartons to provide adequate protection for a unit returned for service.



ATTENTION: Do not attempt to open and modify the motor. Modifications that can be performed in the field are described in this manual. Do not perform modification that are not described in this manual.

Only an authorized Allen-Bradley repair center can service this item. Refer to Rockwell Automation Support for assistance to locate the nearest repair center.

Store or operate your motor in a clean and dry location within the environmental conditions listed in [Specifications on page 20](#).

Removing the Shaft Cap

Use your hand to remove the protective cap that is installed on the motor shaft or pry off the cap with a screwdriver. Do not use a hammer or other tools as they can damage the motor shaft.

Prolonging Motor Life

Proper design and maintenance can increase the life of a servo motor. Follow these guidelines to maximize the life of a servo motor within your environment:

- Always provide a drip loop in each cable to carry liquids away from the connection to the motor.

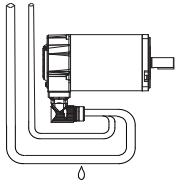

The cable enters beneath the motor and forms a drip loop.

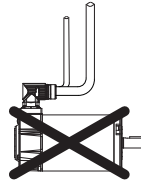

The cable enters above the motor and does not form a drip loop.

- If possible, provide shields that protect the motor housing, shaft seals, and their junctions from contamination by foreign matter or fluids.
- Shaft seals are subject to wear and require periodic inspection and replacement. Replacement is recommended every 3 months, not to exceed 12 months, depending on use. Refer to [Shaft Seal Kits on page 19](#) for more information.
- Inspect the motor and seals for damage or wear on a regular basis. If damage or excessive wear is observed, replace the item.
- The brake option on this servo motor is a spring-set holding brake that releases when voltage is applied to the brake coil. A separate power source is required to disengage the brake. This power source can be applied by a servo motor controller or manual operator control.

If system main power fails, holding brakes can withstand occasional use as stopping brakes. However, this creates rotational mechanical backlash that can cause damage to the system, increase brake wear, and reduce brake life.

IMPORTANT Holding brakes are not designed to stop rotation of the motor shaft, and they are not intended to be used as a safety device. They are designed to hold a motor shaft at 0 rpm for up to the rated brake holding torque.

Follow these steps to prevent motor shaft rotation.

1. Command the servo drive to 0 rpm.
2. Verify the motor is at 0 rpm.
3. Engage the brake.
4. Disable the drive.

Disabling the drive removes the potential for brake wear caused by a badly-tuned servo system oscillating the shaft.

Using Shaft Seals

An additional seal is required on the motor shaft near the motor front bearing, if the shaft is exposed to fluids or significant amounts of fine dust. This includes lubricating oil from a gearbox. An IP66 rating for the motor requires the use of a shaft seal and environmentally sealed connectors/cables. The additional seal is not recommended in applications where the motor shaft area is free of liquids or fine dust, and a lower rating is sufficient:

- Refer to [Specifications on page 20](#) for a brief description of the IP rating for these MP-Series motors.
- Refer to [Shaft Seal Kits on page 19](#) to find the catalog numbers of seal kits available for your motor.
- Refer to Kinetix® Motion Accessories Specifications, publication [GMC-TD004](#), to find environmentally sealed connectors and cables compatible with the MP-Series motors.

Using Couplings and Pulleys

Mechanical connections to the motor shaft, such as couplings and pulleys, require a torsionally rigid coupling or a reinforced timing belt. The high dynamic performance of servo motors can cause couplings, pulleys, or belts to loosen or slip over time. A loose or slipping connection can cause system instability and damage the motor shaft. All connections between the system and the servo motor shaft must be rigid to achieve acceptable response from the system. Periodically inspect connections to verify their rigidity.

When mounting couplings or pulleys to the motor shaft, be sure that the connections are properly aligned and that axial and radial loads are within the specifications of the motor. Refer to [Shaft Seal Kits](#) for guidelines to achieve 20,000 hours of motor bearing life.



ATTENTION: Damage can occur to the motor bearings and the feedback device if sharp impact to the shaft is applied during installation of couplings and pulleys. Damage to the feedback device can result by applying leverage from the motor mounting face to remove devices mounted on the motor shaft.

Do not strike the shaft, couplings, or pulleys with tools during installation or removal. Use a wheel puller applying pressure from the user end of the shaft to remove any friction-fit or stuck device from the motor shaft.

Preventing Electrical Noise

Electromagnetic interference (EMI), commonly called noise, can adversely impact motor performance by inducing stray signals.

Follow these guidelines to prevent the effects of EMI:

- Isolate the power transformers, or install line filters on all AC input power lines.
- Separate signal cables from motor cabling and power wiring. Do not route signal cables with motor and power wires, or over the vent openings of servo drives.

- Ground all equipment by using a single-point parallel ground system that employs ground bus bars or large straps. If necessary, use additional electrical noise reduction techniques to reduce EMI in noisy environments.

Refer to System Design for Control of Electrical Noise Reference Manual, publication [GMC-RM001](#), for additional information on reducing the effects of EMI by improving the system level electromagnetic compatibility (EMC).

Build and Install the Cables

Correct cable routing and careful cable construction improves system electromagnetic compatibility (EMC).

Follow these guidelines to build and install the cables:

- Keep the wire lengths as short as possible.
- Route noise sensitive wiring (encoder, serial, and I/O) away from input power and motor power wiring.
- Separate cables by 0.3 m (1 ft) minimum for every 9 m (30 ft) of parallel run.
- Ground both ends of the encoder cable shield and twist the signal wire pairs to prevent EMI from other equipment.



ATTENTION: High voltage can be present on the shield of a power cable, if the shield is not grounded.

Verify that there is a connection to ground for any power cable shield.



ATTENTION: MP-Series motors produce leakage current in the protective earthing conductor that exceeds 3.5 mA AC and/or 10 mA DC.

Be sure to properly ground the motor cables per the drive installation instructions.

Shield the Power Cable

Follow these steps to shield the power cable.

1. Verify the separate signal wire shield connects to the overall chassis ground by looping back each of the signal wire pairs as shown in the diagram.
2. Clamp all three shields together at the power cable (chassis) ground connection on the drive.



ATTENTION: High voltage can be present on the shields of a power cable, if the shields are not grounded.

Verify there is a connection to ground for all shields in the power cable.

Power Cable Shielding

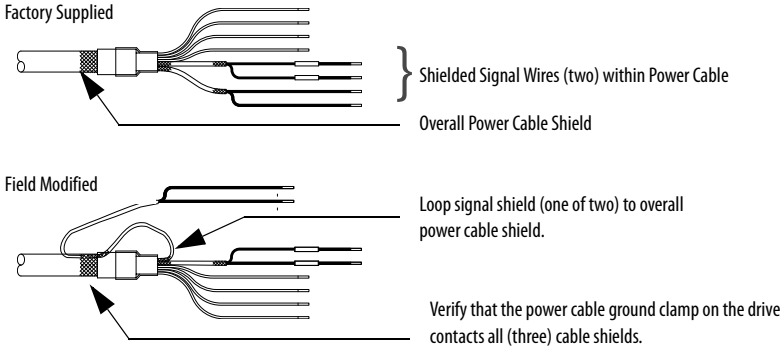

Brake Control and Power Regulation

The DC power source for a permanent magnet brake, such as that on the MP-Series servo motor with 75 mm (2.95 in.) or smaller frame, requires a DC power supply with low ripple voltage.

A motor brake requires relay contacts to open and remove power to the brake coil. Removing power causes the brake to mechanically engage, but it also can cause electrical arcing to occur at the contacts until the residual brake power sufficiently dissipates. A customer supplied diode is recommended to prevent electrical arcing at the brake relay contacts. Substituting a metal oxide varistor (MOV) for the diode can reduce the time to mechanically engage the brake. The following diagram shows typical customer supplied components for brake control, including an arc suppressing diode or MOV.

Arc Suppression in the Motor Brake Circuit

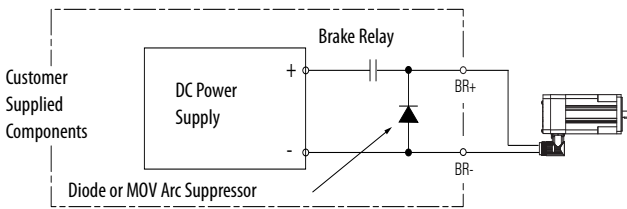

The Kinetix 6000 drive from Rockwell Automation has a brake control relay that includes a MOV arc suppressor. Customer-supplied arc suppression is not required in this case, unless power consumption by the brake requires an external brake relay.

Install the Motor

MP-Series motors include a mounting pilot for aligning the motor on the machine. Preferred fasteners are stainless steel. The installation must comply with all local regulations and use equipment and installation practices that promote safety and electromagnetic compatibility.



ATTENTION: Unmounted motors, disconnected mechanical couplings, loose shaft keys, and disconnected cables are dangerous if power is applied.

Lock-out and tag-out disassembled equipment (restrict electrical power).

Before applying power to the motor, remove the shaft key and other mechanical couplings that can be thrown from the shaft.



ATTENTION: Make sure that cables are installed and restrained to prevent uneven tension or flexing at the cable connections.

Excessive and uneven lateral force on the cable can inhibit environmental sealing as the cable flexes.

Change Connector Orientation

You can rotate the connector housing up to 180°. This lets you adjust the connector to a position that best protects the connection from possible environmental contaminants while providing cable access.



ATTENTION: Connectors are designed to be rotated into a fixed position during motor installation, and remain in that position without further adjustment. Do not rotate the connector multiple times, and do not use tools or excessive force to rotate the connector. Excessive rotation or force can damage the connector seal and reduce the international protection (IP) rating of the motor as outlined in [Specifications on page 20](#).

The circular DIN connector housing can be rotated up to 180° in either direction.

Follow these steps to rotate a DIN connector.

1. Mount and fully seat a mating cable on either the feedback or power/brake connector.
2. Grasp the mated connector and cable plug with your hands and slowly rotate them to the outside of the motor.



ATTENTION: Apply force to only the motor connector and cable plug. Do not apply force to the cable extending from the cable plug. Do not use tools (for example, pliers and vise-grips) to rotate the connector.

3. Repeat these steps for the other connector.

Mount the Motor

Follow these steps to mount the motor.



ATTENTION: Damage can occur to the motor bearings and the feedback device if sharp impact to the shaft is applied during installation of couplings and pulleys.

Do not strike the shaft, couplings, or pulleys with tools during installation or removal.

1. Provide sufficient clearance, heatsink mass, and air flow for the motor so it stays within the operating temperature range of 0...40 °C (32...104 °F).

Do not enclose the motor unless cooling air is forced across the motor, and keep other heat producing devices away from the motor. Heatsink requirements are listed in a footnote to the [Specifications on page 20](#).



ATTENTION: Outer surfaces of the motor can reach high temperatures of 125 °C (275 °F) during operation.

Take precautions to prevent accidental contact with hot surfaces. Consider motor surface temperature when selecting motor mating connections and cables.

2. Verify the axial and radial shaft loads of your application do not exceed those listed in the [Motor Load Force Ratings on page 15](#).
3. Position the motor with the cable connections beneath the motor.
Refer to [Removing the Shaft Cap on page 4](#) for a visual reference of correct motor and cable positioning.
4. Properly mount and align the motor:
 - Bulletin MPL motors include a mounting pilot for aligning the motor on a machine.
 - The index pulse occurs on a 2000 line encoder when the shaft key is aligned with the connectors.
 - Make sure belt loading is within the motor limits, and all belts and pulleys are properly aligned.
 - Follow manufacturer recommendations for gearboxes, pulleys, or other motor accessories.

Attach the Motor Cables

Follow these steps to attach the feedback and power/brake cables after the motor is mounted.



ATTENTION: Servo drive power must be turned off before connecting or disconnecting the cables to the motor, and if a cable is left disconnected at the motor end.

Arcing or unexpected motion can occur if the feedback, power, or brake cables are connected or disconnected while power is applied to the servo drive.



ATTENTION: Be sure that cables are installed and restrained to prevent uneven tension or flexing at the cable connectors. Provide support at 3 m (10 ft) intervals throughout the cable run.

Excessive and uneven lateral force at the cable connectors can result in the connector's environmental seal opening and closing as the cable flexes, or wires separating at the cable gland.

1. If you are using the **Threaded DIN (M4) Cable Plugs**, install the O-rings.

An O-ring on the connector is necessary to achieve the maximum environmental rating.

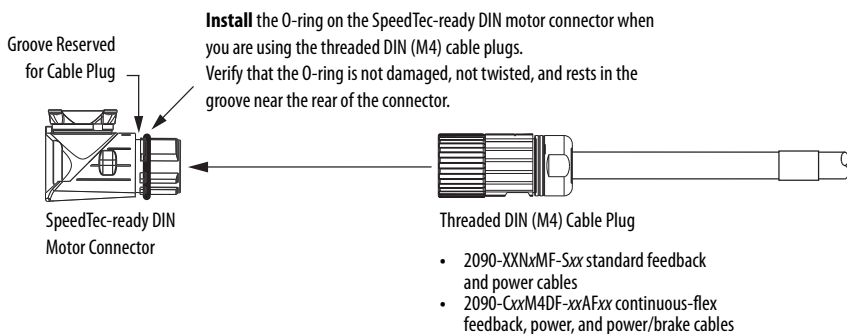

Do not install the O-ring on the SpeedTec-ready DIN motor connector.

2. If you are using the **SpeedTec DIN (M7) Cable Plugs**, do not install the O-rings.

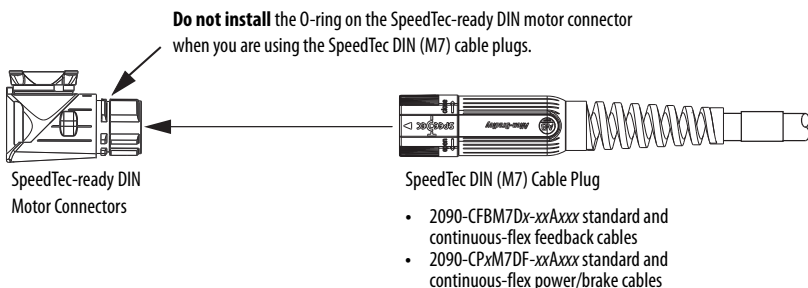

3. Form a drip loop in the cable (see [page 5](#)).

- Carefully align the flat surface on the feedback or the power/brake cable plug (shown in the diagram) with the flat surface on the motor connector.

IMPORTANT The motor orientation shown is used to clearly show the alignment marker on each cable socket.

The recommended motor orientation when installed positions the connectors at the bottom of the motor.

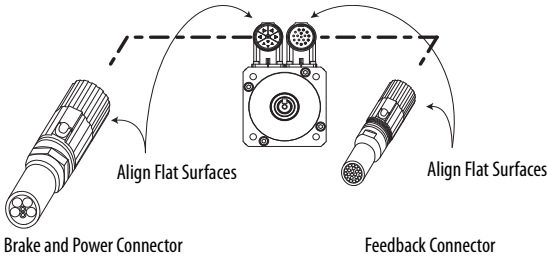

- Hand tighten the collar on the plug to fully seat it on the connector:
 - Threaded DIN (M4) cable plugs require five to six revolutions.
 - SpeedTec DIN (M7) cable plugs require approximately one-quarter of a revolution.

TIP A fully-seated threaded plug leaves a small opening, approximately 1...4 mm (0.04...0.16 in.), between the connector and the plug.

Do not apply excessive force when mating the cable plug with the motor connector. If the plug and connector do not go together with light hand force, realign the flat surfaces and try again.



ATTENTION: Align the keyed connectors and hand-tighten the recommended number of turns.

If you cannot tighten the connectors by hand, verify that the keyed connectors are properly aligned. Do not use tools (for example, pliers and vise-grips) to tighten the connectors.

Product Dimensions

This section provides dimensions for the motors.

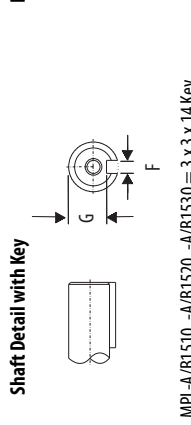
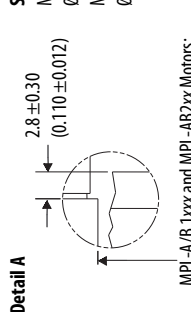
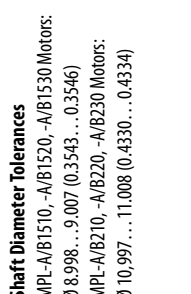
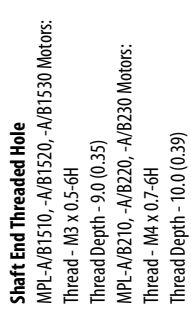
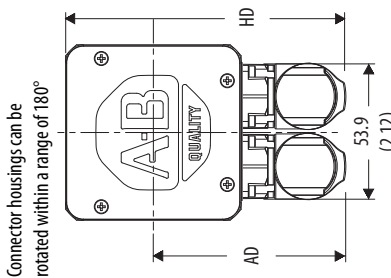
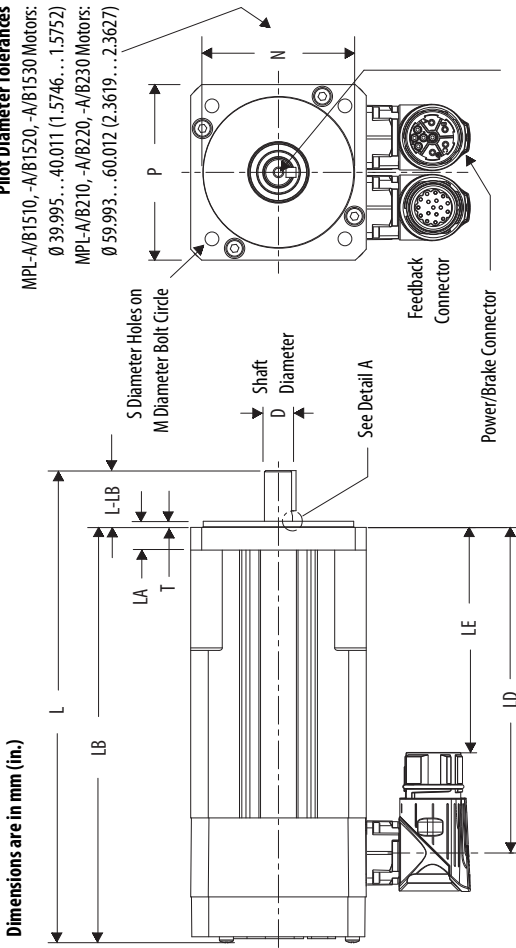

MPL-A/B15xx and MPL-A/B2xx Motor Dimensions

Motors are designed to metric dimensions. Inch dimensions are approximate conversions from millimeters. Dimensions without tolerances are for reference.

Motor Cat. No.	AD mm (in.)	HD mm (in.)	T mm (in.)	LA mm (in.)	LD ⁽¹⁾ mm (in.)	LE ⁽¹⁾ mm (in.)	L ⁽¹⁾ mm (in.)	LB ⁽¹⁾ mm (in.)	L-LB ⁽²⁾ mm (in.)	D ⁽³⁾ mm (in.)	M mm (in.)	S ⁽⁴⁾ mm (in.)	N ⁽³⁾ mm (in.)	P mm (in.)	G ⁽³⁾ mm (in.)	F ⁽³⁾ mm (in.)
MPL-A/B1510					78.3 (3.08)	37.8 (1.49)	133.2 (5.25)	113.5 (4.47)								
MPL-A/B1520	68.9 (2.71)	96.4 (3.80)	2.50 (0.098)	9.0 (0.35)	91.3 (3.60)	50.9 (2.00)	146.2 (5.76)	126.5 (4.98)	19.7 (0.776)	9.0 (0.35)	63.0 (2.480)	5.80 (0.228)	40.0 (1.57)	55.0 (2.17)	7.2 (0.283)	3.0 (0.118)
					116.3 (4.58)	76.7 (2.98)	171.2 (6.74)	151.5 (5.96)								
MPL-A/B1530																
MPL-A/B210	76.2 (3.00)	111.2 (4.38)	2.50 (0.098)	9.0 (0.35)	78.6 (3.09)	38.4 (1.51)	137.3 (5.40)	114.6 (4.51)								
					104.1 (4.10)	63.9 (2.52)	162.8 (6.41)	140.1 (5.52)	22.7 (0.894)	11.0 (0.43)	75.0 (2.953)	5.80 (0.228)	60.0 (2.36)	70.0 (2.76)	8.5 (0.335)	4.0 (0.157)
MPL-A/B230					129.6 (5.10)	89.4 (3.52)	188.3 (7.41)	165.6 (6.52)								

(1) If ordering an MPL-A/B1510, MPL-A/B1520, or MPL-A/B1530 motor with brake, add 36.1 mm (1.421 in.) to dimension L and LB, and add 33.4 mm (1.32 in.) to LD and LE.
 If ordering an MPL-A/B210, A/B220, or A/B230 motor with brake, add 39.0 mm (1.535 in.) to dimension L and LB, and add 24.7 mm (0.97 in.) to LD and LE.

(2) Tolerance for this dimension is ±0.7 mm (±0.028 in.).

(3) For keyway, shaft diameter, and pilot diameter tolerances, see [page 15](#).

(4) Tolerance for this dimension is +0.3 mm (+0.012 in.).

Tolerances and Supplemental Dimensions

Shaft, Pilot, and Keyway Tolerances	MPL-A/B15xx	MPL-A/B2xx
Shaft Runout (T.I.R.)	0.030 (0.0012)	0.035 (0.0014)
Pilot Eccentricity (T.I.R.)	0.08 (0.0031)	0.08 (0.0031)
Max Face Runout (T.I.R.)	0.08 (0.0031)	0.08 (0.0031)
Keyway Depth (G)	7.10 ... 7.20 (0.280 ... 0.283)	8.40 ... 8.50 (0.331 ... 0.335)
Keyway Width (F)	2.971 ... 2.996 (0.117 ... 0.118)	3.97 ... 4.00 (0.156 ... 0.157)

Motor Load Force Ratings

Motors are capable of operating with a sustained shaft load. The location of the radial and axial load force is shown in the figure, and maximum values are listed.

Loads are measured in pounds, kilograms are mathematical conversions.

Load Forces on Shaft

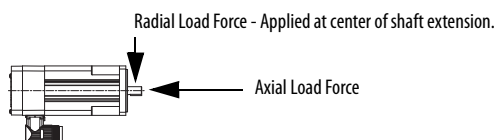

The following tables represent 20,000 hour L_{10} bearing fatigue life at various loads and speeds. This 20,000 hour life does not account for possible application-specific life reduction that can occur due to bearing grease contamination from external sources.

Radial Load Force Ratings

Motor Cat. No.	1000 rpm		2000 rpm		3500 rpm		4000 rpm		at Max Speed		
	kg	(lb)	kg	(lb)	kg	(lb)	kg	(lb)	kg	(lb)	rpm
MPL-A/B1510	24	(52)	19	(41)	—	—	15	(33)	12	(26)	8000
MPL-A/B1520	25	(56)	20	(45)	—	—	16	(36)	14	(30)	7000
MPL-A/B1530	28	(62)	22	(49)	—	—	18	(39)	15	(32)	7000
MPL-A/B210	24	(52)	19	(41)	—	—	15	(32)	12	(26)	8000
MPL-A/B220	27	(59)	21	(47)	18	(39)	—	—	15	(33)	6000
MPL-A/B230	29	(64)	23	(51)	19	(42)	—	—	17	(37)	5000

Axial Load Force Ratings (maximum radial load)

Motor Cat. No.	1000 rpm		2000 rpm		3500 rpm		4000 rpm		at Max Speed		
	kg	(lb)	kg	(lb)	kg	(lb)	kg	(lb)	kg	(lb)	rpm
MPL-A/B1510	15	(33)	10	(22)	—	—	7	(15)	5	(10)	8000
MPL-A/B1520	14	(31)	10	(22)	—	—	6	(13)	4	(9)	7000
MPL-A/B1530	13	(29)	9	(20)	—	—	6	(13)	4	(8)	7000
MPL-A/B210	15	(33)	10	(22)	—	—	7	(15)	5	(10)	8000
MPL-A/B220	14	(30)	9	(20)	7	(15)	—	—	5	(10)	6000
MPL-A/B230	13	(28)	9	(19)	6	(13)	—	—	5	(10)	5000

Axial Load Force Ratings (zero radial load)

Motor Cat. No.	1000 rpm		2000 rpm		3500 rpm		4000 rpm		at Max Speed		
	kg	(lb)	kg	(lb)	kg	(lb)	kg	(lb)	kg	(lb)	rpm
MPL-A/B1510	24	(53)	17	(37)	—	—	12	(26)	8	(18)	8000
MPL-A/B1520	24	(53)	17	(37)	—	—	12	(26)	9	(19)	7000
MPL-A/B1530	24	(53)	17	(37)	—	—	12	(26)	9	(19)	7000
MPL-A/B210	24	(53)	17	(37)	—	—	12	(26)	8	(18)	8000
MPL-A/B220	24	(53)	17	(37)	13	(28)	—	—	10	(22)	6000
MPL-A/B230	24	(53)	17	(37)	13	(28)	—	—	10	(22)	5000

Connector Data

This table provides the signal descriptions for the feedback, power, and brake pinouts on the connectors.

M23 Feedback and Power/Brake Pin Descriptions

Pin	High Resolution Encoder MPL-Axxx (230V)	High Resolution Encoder MPL-Bxxx (460V)	Incremental Encoder MPL-A/B/xxxx-Hxxxx	Pin	M23 Power/Brake MPL-Axxx and MPL-Bxxx	
1	Sin+	Sin+	A+	A	Phase U ⁽¹⁾	
2	Sin-	Sin-	A-	B	Phase V ⁽¹⁾	
3	Cos+	Cos+	B+	C	Phase W ⁽¹⁾	
4	Cos-	Cos-	B-	D	Ground	
5	Data+	Data+	I+	E	Reserved	
6	Data-	Data-	I-	F	BR+	
7	Reserved	Reserved	Reserved	G	BR-	
8			Reserved	+5 V DC	H	Reserved
9					Common	
10			+9V DC	Reserved		
11	Reserved	Common	Reserved			
12	TS+	TS+		TS+		
13	TS-	TS-	TS-			
14	Reserved	Reserved	S1			
15			S2			
16			S3			
17						

M23 Power/Brake Connector

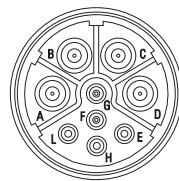

M23 Feedback Connector

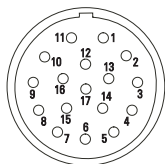

(1) The U, V, and W power phases can also be labeled as R, S, and T respectively.

Remove and Install a Shaft Key

Shaft keys are constructed of steel. The specified tolerance provides an interference fit (slightly larger than the opening) for a secure and rigid connection.



ATTENTION: Do not strike the motor's shaft, couplings, or pulleys with tools during installation or removal of the shaft key.

Damage can occur to the motor bearings and the feedback device if a sharp impact is applied to the shaft during installation of couplings and pulleys, or to remove the shaft key, or if leverage is applied from the motor mounting face to remove devices mounted on the motor shaft.

Apply a constant pressure, with a wheel puller, to the user end of the shaft to remove a friction fit or stuck device.

To remove a shaft key, perform one of these actions:

- Lift the key by grasping it with a pliers or similar tool.
- Lever the key with a screwdriver inserted between the key and the slot.

To install a shaft key, follow these steps.

1. Verify the replacement key matches the keyway in the shaft and the mating mechanical connection (for example, a coupling or pulley) before proceeding.
2. Align the front of the key with the front of the motor shaft.
This prevents the radiused end-of-cut at the motor end of the keyway from interfering with correct seating of the key.
3. Support the underside of the shaft diameter with a fixture, and use a controlled press device to apply a constant force across the top surface to press the key into the shaft.

Shaft Key Installation

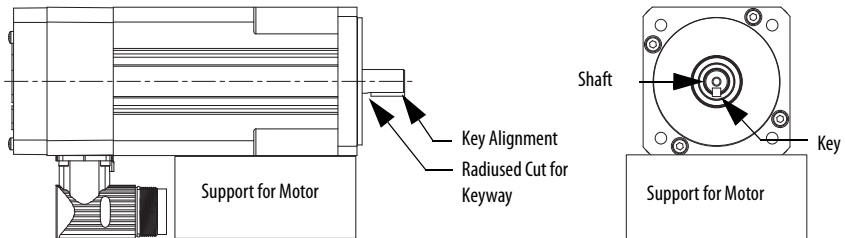

Motor Cables and Accessory Kits

This section describes accessories that are available for MP-Series low-inertia motors.

Motor Cables

Factory manufactured feedback and power cables are available in standard cable lengths. They provide the sealing needed to achieve environmental ratings and shield termination.

For a complete listing of available cables, contact your nearest Rockwell Automation sales office or refer to the Kinetix Motion Accessories Specifications Technical Data, publication

[GMC-TD004](#).

Shaft Seal Kits

IMPORTANT Shaft seals must be lubricated. Lubricant is supplied with the shaft seal kits.

Third-party shaft seals are not approved for use with these motors. The use of third-party shaft seals voids any implied or expressed warranties.

A shaft seal is a barrier that can prevent moisture and particles from entering the motor bearings.

Shaft seals are subject to wear and require periodic inspection and replacement. Replacement is recommended every 3 months, not to exceed 12 months, depending on use.

Catalog numbers for the motors and corresponding replacement Nitrile shaft seal kits are listed in the table.

Motor Cat. No.	Shaft Seal Kit Cat. No.
MPL-x15xx or MPL-x2xx	MPL-SSN-F63/F75

For instructions on how to install a shaft seal, refer to the Shaft Seal Kit Installation Instructions, publication [2090-IN012](#).

Specifications

Always store a motor in a clean and dry location within these environmental conditions. Appropriate mounting, cabling, and a shaft seal can be required to attain a specific IP rating. Exterior surfaces of the MP-Series small frame servo motors are made from these materials.

Attribute	Value
Temperature, operating	0...40 °C (32...104 °F) ⁽⁴⁾
Temperature, storage	-30...70 °C (-22...158 °F)
Relative humidity, storage	5...95% noncondensing
Atmosphere, storage	Noncorrosive
Shock	20g peak, 6 ms duration
Vibration	2.5 g, 30...2000 Hz
Ingress Protection Codes ⁽¹⁾ ⁽²⁾	
IP50	Motor without a shaft seal, mounted in the shaft up direction
IP51	Motor without a shaft seal, mounted in the shaft horizontal direction
IP53	Motor without a shaft seal, mounted in the shaft down direction
IP66 ⁽³⁾	Motor with an optional shaft seal
Material by Location	
Housing	Aluminum
Shaft	39NiCrMo3 or 1144 steel (respectively per UNI7845 or ASTM-A311 Class B)
Shaft key	Carbon steel

(1) IP ratings are determined with Rockwell Automation cables connected to the motor.

(2) IP rating applies to a motor mounted as described.

(3) This rating is for dust tightness and powerful water jets ejecting water, not cleaning agents.

(4) To obtain this thermal rating, follow these mounting guidelines:

- Mount the MPL-x15xx motor on a surface with heat dissipation equivalent to a 203.2 x 203.2 x 6.35 mm (8 x 8 x 0.25 in.) aluminum heatsink.
- Mount the MPL-x2xx motor on a surface with heat dissipation equivalent to a 254.0 x 254.0 x 6.35 mm (10 x 10 x 0.25 in.) aluminum heatsink.

Additional Resources

These documents contain additional information concerning related products from Rockwell Automation.

Resource	Description
Kinetix 5500 Servo Drives User Manual, publication 2198-UM001	Provides information on installing, configuring, startup, troubleshooting, and applications for your Kinetix servo drive system.
Kinetix 6200 and Kinetix 6500 Modular Servo Drives User Manual, publication 2094-UM002	
Kinetix 6000 Multi-axis Servo Drive User Manual, publication 2094-UM001	
Kinetix 300 EtherNet/IP Indexing Servo Drives User Manual, publication 2097-UM001	
Kinetix 350 Single-axis EtherNet/IP Servo Drives User Manual, publication 2097-UM002	
Kinetix Motion Control Selection Guide, publication GMC-SG001	Specifications, motor/servo-drive system combinations, and accessories for Kinetix motion control products.
Kinetix Rotary Motion Specifications Technical Data, publication GMC-TD001	Provides product specifications for MP-Series (Bulletin MPL, MPM, MPF, MPS) rotary motors.
Kinetix Motion Accessories Specifications, publication GMC-TD004	Provides product specifications for Bulletin 2090 motor and interface cables, low-profile connector kits, drive power components, and other servo drive accessory items.
Shaft-seal Kit Installation Instructions, publication 2090-IN012	Information on the installation of a shaft seal on this and other servo motors.
Allen-Bradley Industrial Automation Glossary, publication AG-7.1	A glossary of industrial automation terms and abbreviations.
System Design for Control of Electrical Noise Reference Manual, publication GMC-RM001	How to minimize and control system-level noise.
Rockwell Automation Product Certification website http://www.rockwellautomation.com/products/certification/	Declarations of Conformity (DOC) for Rockwell Automation products.

You can view or download publications at <http://www.rockwellautomation.com/literature/>. To order paper copies of technical documentation, contact your local Allen-Bradley distributor or Rockwell Automation sales representative.

Rockwell Automation Support

Rockwell Automation provides technical information on the Web to assist you in using its products.

At <http://www.rockwellautomation.com/support> you can find technical and application notes, sample code, and links to software service packs. You can also visit our Support Center at <https://rockwellautomation.custhelp.com/> for software updates, support chats and forums, technical information, FAQs, and to sign up for product notification updates.

In addition, we offer multiple support programs for installation, configuration, and troubleshooting. For more information, contact your local distributor or Rockwell Automation representative, or visit <http://www.rockwellautomation.com/services/online-phone>.

Installation Assistance

If you experience a problem within the first 24 hours of installation, please review the information that's contained in this manual. You can also contact a special Customer Support number for initial help in getting your product up and running.

United States or Canada	1.440.646.3434
Outside United States or Canada	Use the Worldwide Locator at http://www.rockwellautomation.com/rockwellautomation/support/overview_page , or contact your local Rockwell Automation representative.

New Product Satisfaction Return

Rockwell Automation tests all of its products to help ensure that they are fully operational when shipped from the manufacturing facility. However, if your product is not functioning and needs to be returned, follow these procedures.

United States	Contact your distributor. You must provide a Customer Support case number (call the phone number above to obtain one) to your distributor to complete the return process.
Outside United States	Please contact your local Rockwell Automation representative for the return procedure.

Documentation Feedback

Your comments will help us serve your documentation needs better. If you have any suggestions on how to improve this document, complete this form, publication [RA-DU002](#), available at <http://www.rockwellautomation.com/literature/>.

Rockwell Automation maintains current product environmental information on its website at <http://www.rockwellautomation.com/rockwellautomation/about-us/sustainability-ethics/product-environmental-compliance.page>.

Allen-Bradley, Rockwell Software, MP-Series, Kinetix, and Rockwell Automation are trademarks of Rockwell Automation, Inc.

Trademarks not belonging to Rockwell Automation are property of their respective companies.

Rockwell Otomasyon Ticaret A.Ş., Kar Plaza İş Merkezi E Blok Kat:6 34752 İçerenköy, İstanbul, Tel: +90 (216) 5698400

www.rockwellautomation.com

Power, Control and Information Solutions Headquarters

Americas: Rockwell Automation, 1201 South Second Street, Milwaukee, WI 53204-2496 USA, Tel: (1) 414.382.2000, Fax: (1) 414.382.4444
Europe/Middle East/Africa: Rockwell Automation NV, Pegasus Park, De Kleetlaan 12a, 1831 Diegem, Belgium, Tel: (32) 2 663 0600, Fax: (32) 2 663 0640
Asia Pacific: Rockwell Automation, Level 14, Core F, Cyberport 3, 100 Cyberport Road, Hong Kong, Tel: (852) 2887 4788, Fax: (852) 2508 1846

Publication MP-IN006D-EN-P - January 2015

Supersedes Publication MP-IN006C-EN-P - January 2014

Copyright © 2015 Rockwell Automation, Inc. All rights reserved. Printed in the U.S.A.