

SKT 600



Capsule Thyristor

Line Thyristor

SKT 600

Features

- Hermetic metal case with ceramic insulator
- Capsule package for double sided cooling
- Shallow design with single sided cooling
- International standard case
- Off-state and reverse voltages up to 1800 V
- Amplifying gate

Typical Applications

- DC motor control (e. g. for machine tools)
- Controlled rectifiers (e. g. for battery charging)
- AC controllers (e. g. for temperature control)
- Recommended snubber network e. g. for $V_{VRMS} \leq 400$ V:
 $R = 33 \Omega / 32$ W, $C = 1 \mu F$

V_{RSM} V	V_{RRM}, V_{DRM} V	$I_{TRMS} = 1400$ A (maximum value for continuous operation) $I_{TAV} = 600$ A (sin. 180; DSC; $T_c = 86$ °C)		
900	800	SKT 600/08D		
1300	1200	SKT 600/12E		
1500	1400	SKT 600/14E		
1700	1600	SKT 600/16E		
1900	1800	SKT 600/18E		

Symbol	Conditions	Values	Units
I_{TAV}	sin. 180; $T_c = 100$ (85) °C;	437 (620)	A
I_D	2 x P8/180; $T_a = 45$ °C; B2 / B6 2 x P8/180 F; $T_a = 35$ °C; B2 / B6	400 / 560 1060 / 1500	A A
I_{RMS}	2 x P8/180; $T_a = 45$ °C; W1C	440	A
I_{TSM}	$T_{vj} = 25$ °C; 10 ms $T_{vj} = 125$ °C; 10 ms	11500 10000	A A
i^2t	$T_{vj} = 25$ °C; 8,3 ... 10 ms $T_{vj} = 125$ °C; 8,3 ... 10 ms	660000 500000	A ² s A ² s
V_T	$T_{vj} = 25$ °C; $I_T = 2400$ A	max. 2	V
$V_{T(TO)}$	$T_{vj} = 125$ °C	max. 1	V
r_T	$T_{vj} = 125$ °C	max. 0,4	mΩ
I_{DD}, I_{RD}	$T_{vj} = 125$ °C; $V_{RD} = V_{RRM}; V_{DD} = V_{DRM}$	max. 80	mA
t_{gd}	$T_{vj} = 25$ °C; $I_G = 1$ A; $di_G/dt = 1$ A/μs	1	μs
t_{gr}	$V_D = 0,67 * V_{DRM}$	2	μs
$(di/dt)_{cr}$	$T_{vj} = 125$ °C	max. 125	A/μs
$(dv/dt)_{cr}$	$T_{vj} = 125$ °C; SKT ...D / SKT ...E	max. 500 / 1000	V/μs
t_q	$T_{vj} = 125$ °C,	100 ... 200	μs
I_H	$T_{vj} = 25$ °C; typ. / max.	150 / 500	mA
I_L	$T_{vj} = 25$ °C; typ. / max.	500 / 2000	mA
V_{GT}	$T_{vj} = 25$ °C; d.c.	min. 3	V
I_{GT}	$T_{vj} = 25$ °C; d.c.	min. 200	mA
V_{GD}	$T_{vj} = 125$ °C; d.c.	max. 0,25	V
I_{GD}	$T_{vj} = 125$ °C; d.c.	max. 10	mA
$R_{th(j-c)}$	cont.; DSC	0,038	K/W
$R_{th(j-c)}$	sin. 180; DSC / SSC	0,04 / 0,082	K/W
$R_{th(j-c)}$	rec. 120; DSC / SSC	0,045 / 0,093	K/W
$R_{th(c-s)}$	DSC / SSC	0,007 / 0,014	K/W
T_{vj}		- 40 ... + 125	°C
T_{stg}		- 40 ... + 130	°C
V_{isol}		-	V~
F	mounting force	10 ... 13	kN
a			m/s ²
m	approx.	240	g
Case		B 10	



SKT

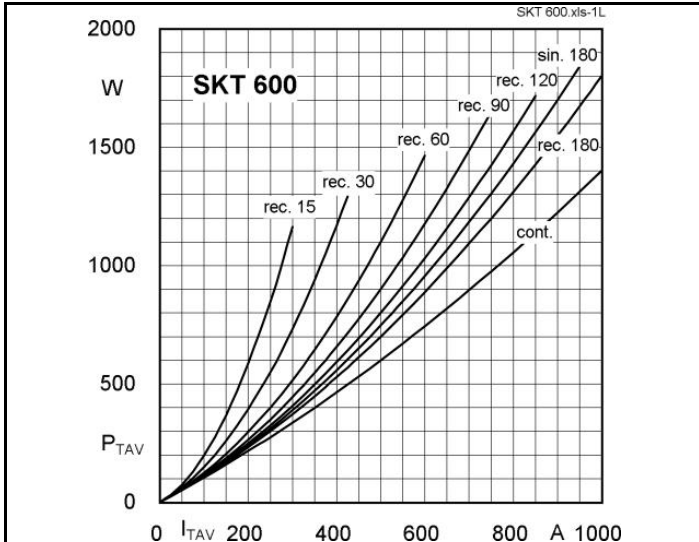

Fig. 1L Power dissipation vs. on-state current

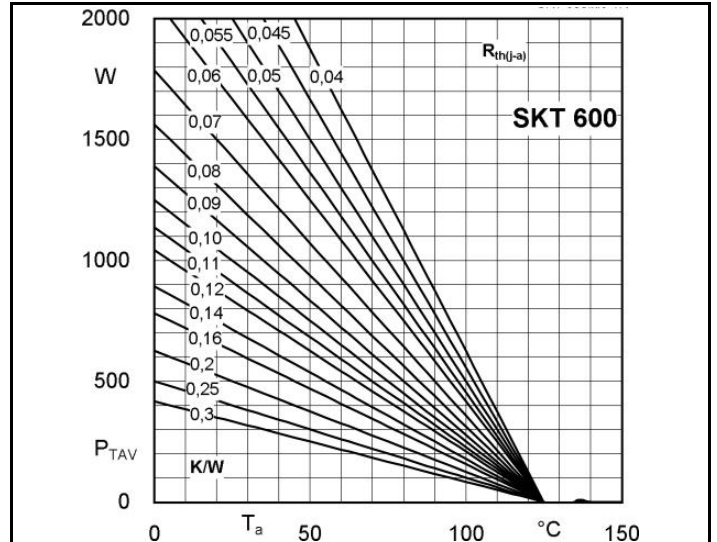

Fig. 1R Power dissipation vs. ambient temperature

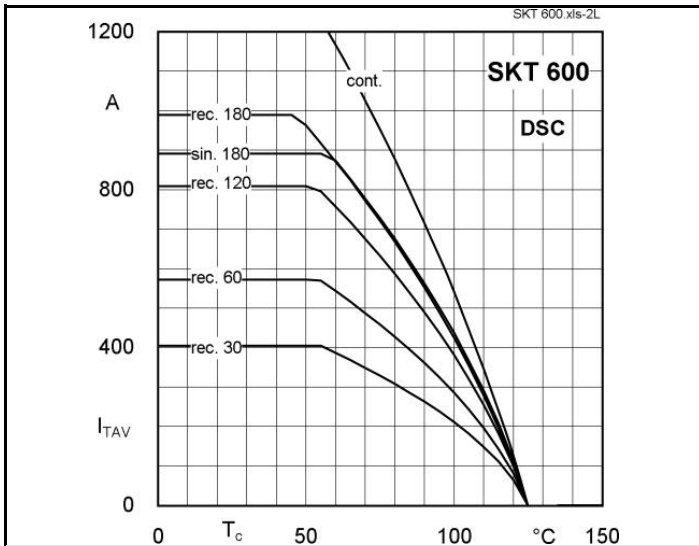

Fig. 2L Rated on-state current vs. case temperature

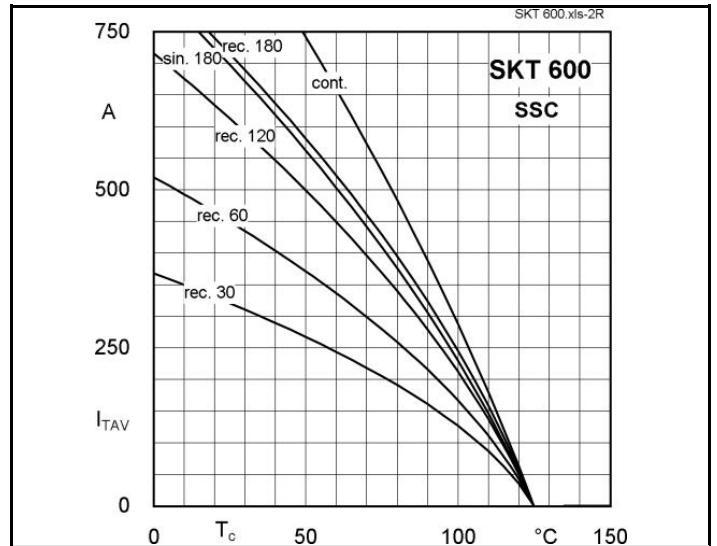

Fig. 2R Rated on-state current vs. case temperature

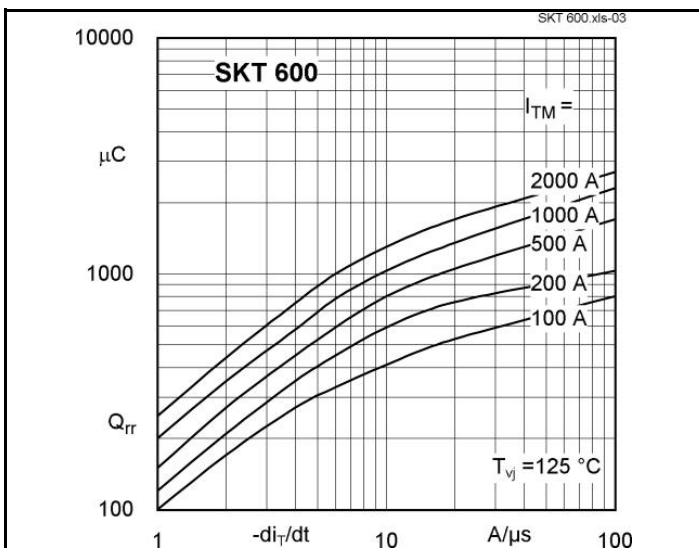

Fig. 3 Recovered charge vs. current decrease

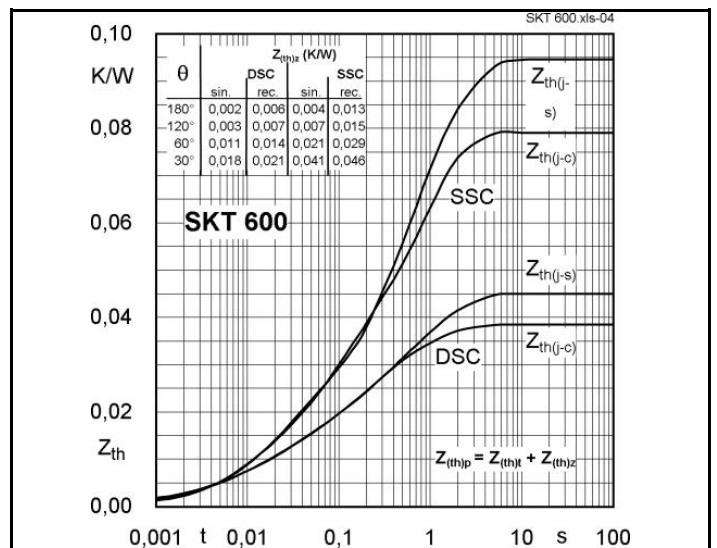
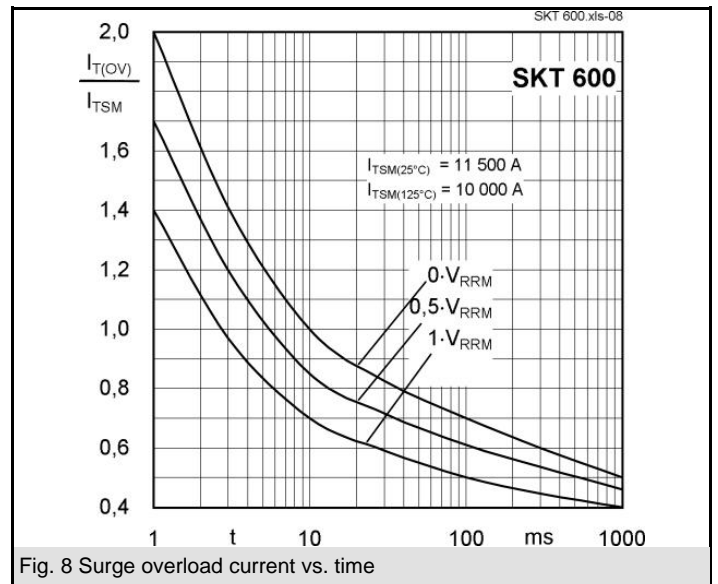
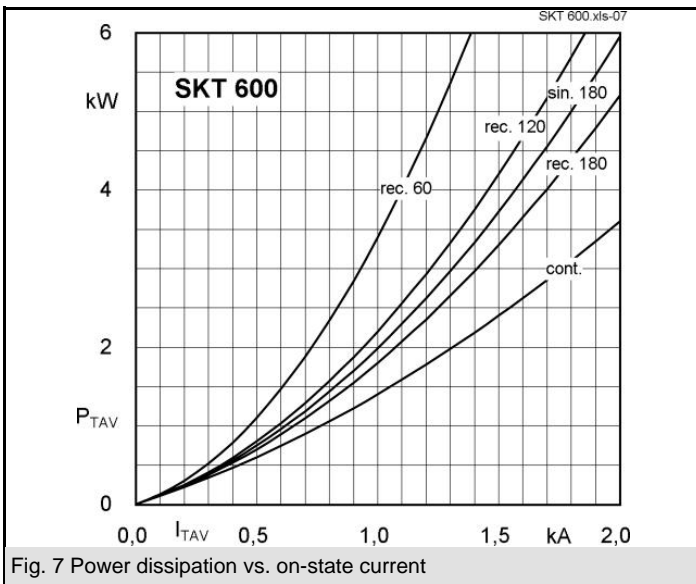
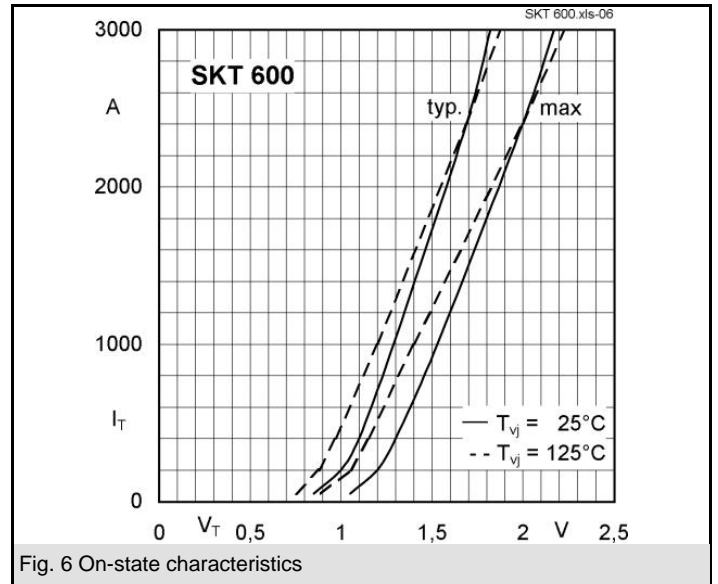
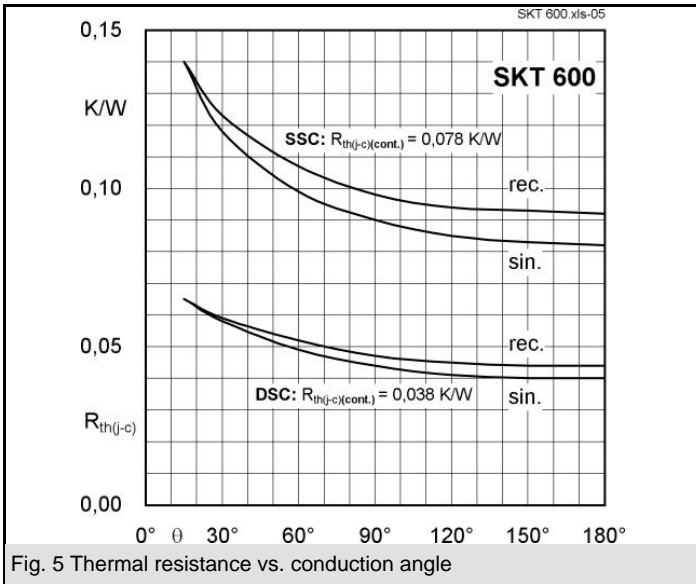
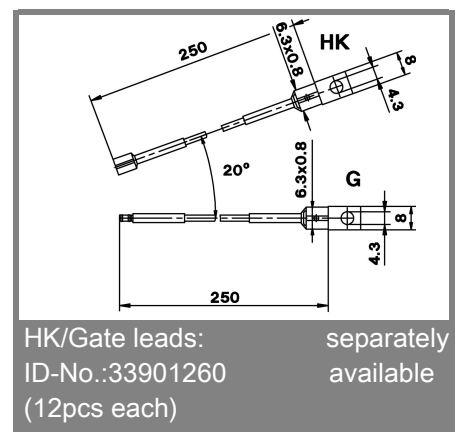
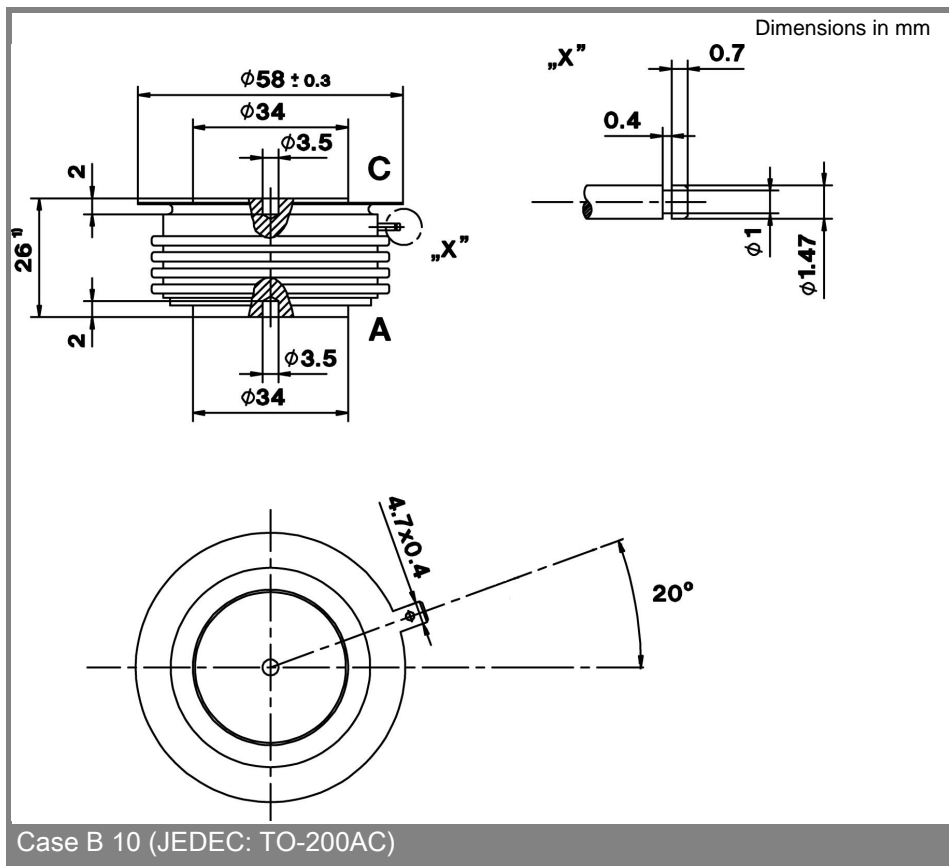
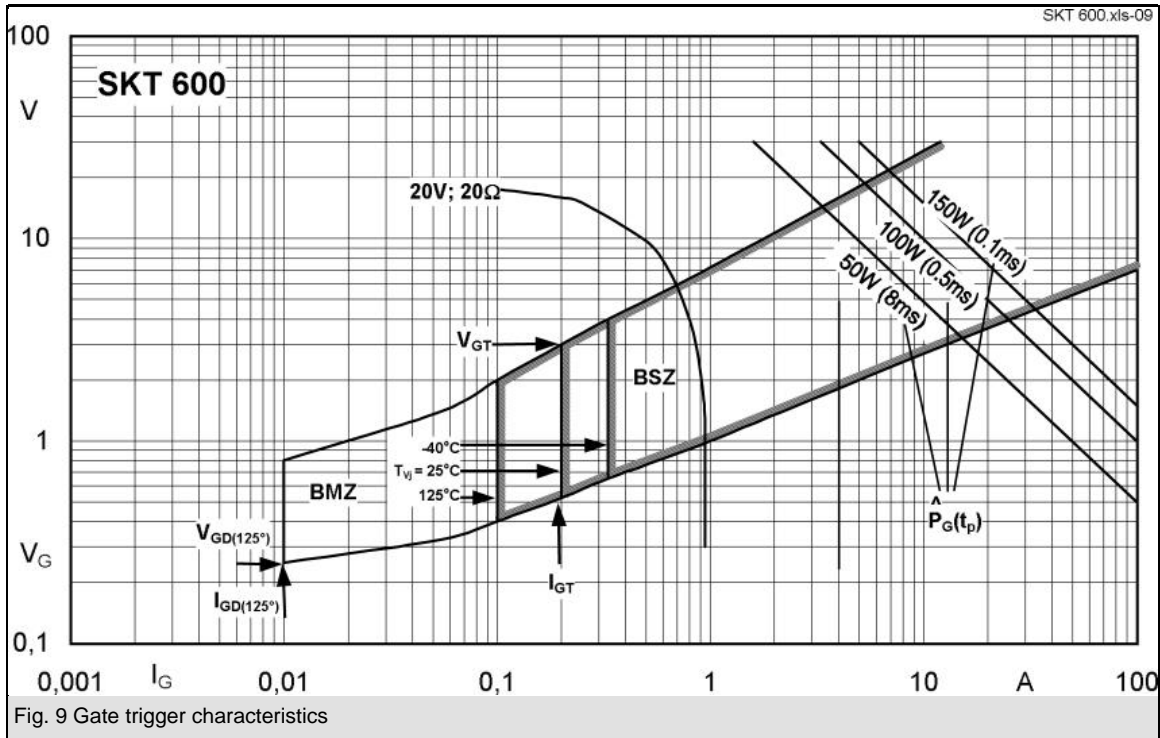

Fig. 4 Transient thermal impedance vs. time





This technical information specifies semiconductor devices but promises no characteristics. No warranty or guarantee expressed or implied is made regarding delivery, performance or suitability.