

Technical Description

DEA Digital In/Output System

Ord.-No.: VIPA DEA-HB34E
Rev. 99/49

Technical Data

	DEA-BG05	DEA-BG08	DEA-BG06	DEA-BG09	DEA-BG04	DEA-BG07 (Rev. 2 and following)
Number of inputs:	64	64	—	—	32	32
Number of outputs:	—	—	64	64	32	32
Galvanic isolation:	yes	no	yes	no	yes	no
Inputs:						
Input voltage:						
- Rated value:	24 V DC	24 V DC	—	—	24 V DC	24 V DC
- "0" signal:	-30 V ... +5 V	-30 V ... +5 V	—	—	-30 V ... +5 V	-30 V ... +5 V
- "1" signal:	+14 V ... +33 V	+14 V ... +33 V	—	—	+14 V ... +33 V	+14 V ... +33 V
Input current "1" signal:	7 mA	5 mA	—	—	7 mA	5 mA
Output:						
Supply voltage:						
- Rated value:	—	—	24 V DC	24 V DC	24 V DC	24 V DC
- Permissible range:	—	—	19 V ... 33 V	19 V ... 33 V	19 V ... 33 V	19 V ... 33 V
Output voltage:						
- Rated value:	—	—	0,5 A	0,5 A	0,5 A	0,5 A
- Permissible range:	—	—	4 mA ... 0,6 A	4 mA ... 0,6 A	4 mA ... 0,6 A	4 mA ... 0,6 A
Current consumption:						
internal 5V:	100 mA	100 mA	500 mA	250 mA	450 mA	300 mA
external 24V:	—	—	150 mA	150 mA	100 mA	100 mA
Address adjustable in steps by:	8	8	8	8	4	4
Front view:						

Connector pin assignment:

IB: Input Byte
OB: Output Byte

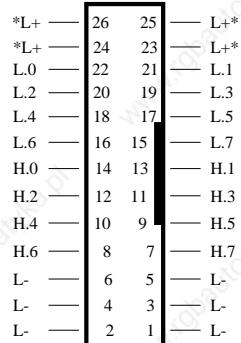

* only for outputs

L+ = supply voltage 24 V
L- = grounding 24 V

L.x = low-byte, bit-no. x
H.x = high-byte, bit-no. x

connector strip on DEA-BG0X

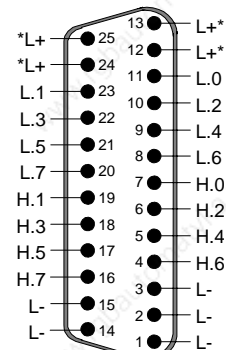

sub miniatur connector UB4X

Switch settings (Addressrange F000...F0FF)

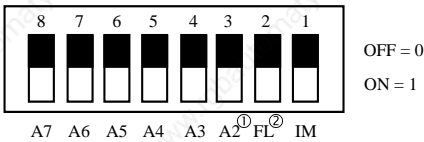

- ① only for BG04/07, otherwise without function
- ② only for BG04/05/07/08, otherwise without function

SW8 ... SW3 = address bit 7 ... address bit 2

SW2 = OFF: Read input bytes **directly** (asynchronous)
 = ON: **All** input bytes of the module are latched with reading byte 0 (**synchronous**).

SW1 = OFF: The module can be placed in **slot 0...6**.
 = ON: The module can **only placed in IM-Slot**.

Setting of the Base address (in P-I/O-area)

The modules BG04 and BG07 can be addressed on steps by **4 bytes**:

Adr.	0	4	8	12	16	20	24	28	32	36	40	44	48	52	56	60
SW8	0	0	0	0	0	0	0	0	0	0	0	0	0	0	0	0
SW7	0	0	0	0	0	0	0	0	0	0	0	0	0	0	0	0
SW6	0	0	0	0	0	0	0	0	1	1	1	1	1	1	1	1
SW5	0	0	0	0	1	1	1	1	0	0	0	0	1	1	1	1
SW4	0	0	1	1	0	0	1	1	0	0	1	1	0	0	1	1
SW3	0	1	0	1	0	1	0	1	0	1	0	1	0	1	0	1

Adr.	64	68	72	76	80	84	88	92	96	100	104	108	112	116	120	124
SW8	0	0	0	0	0	0	0	0	0	0	0	0	0	0	0	0
SW7	1	1	1	1	1	1	1	1	1	1	1	1	1	1	1	1
SW6	0	0	0	0	0	0	0	0	1	1	1	1	1	1	1	1
SW5	0	0	0	0	1	1	1	1	0	0	0	0	1	1	1	1
SW4	0	0	1	1	0	0	1	1	0	0	1	1	0	0	1	1
SW3	0	1	0	1	0	1	0	1	0	1	0	1	0	1	0	1

The modules BG05, BG06, BG08 and BG09 can be addressed in steps by **8 bytes**:

Adr.	0	8	16	24	32	40	48	56	64	72	80	88	96	104	112	120
SW8	0	0	0	0	0	0	0	0	0	0	0	0	0	0	0	0
SW7	0	0	0	0	0	0	0	0	1	1	1	1	1	1	1	1
SW6	0	0	0	0	1	1	1	1	0	0	0	0	1	1	1	1
SW5	0	0	1	1	0	0	1	1	0	0	1	1	0	0	1	1
SW4	0	1	0	1	0	1	0	1	0	1	0	1	0	1	0	1

Slots for DEA-modules in the S5-115U from Siemens

The following summary shows possible plug in positions (marked by x) on card Racks.

	PS	CPU	0	1	2	3	4	5	6	IM
DEA-BG XX (CR 700-1)			x							x
DEA-BG XX (CR 700-2)			x	x	x	x	x	x	x	x
DEA-BG XX (CR 700-3)			x	x	x	x	x	x	x	x

	PS	CPU	0	1	2	3	IM
DEA-BG XX (CR 700-0LA)			x				x
DEA-BG XX (CR 700-0LB)			x	x	x	x	x

	PS	0	1	2	3	4	5	6	7
DEA-BG XX (ER 701-0)									
DEA-BG XX (ER 701-1)									
DEA-BG XX (ER 701-2)							x	x	
DEA-BG XX (ER 701-3)		x	x	x	x	x	x	x	

The card racks 701-2 and 701-3 can also central be connected (IM 305 o. IM 306).

Please note

- For the non-floating modules BG07, BG08 and BG09 there has to be an external electrical connection on the central ground point between 5V ground (GND switchgear cubicle) and 24V (GND power supply).
- It is not permitted to run the modules on the slots 0...6 if the IM-switch is set.
- It is not permitted to supply the modules BG04, BG06, BG07 and BG09 from an external feed (e.g. for manual operation via switch) directly on the outputs (picture 1).

However, the following connections are permitted:

1. If there are separate power supplies for the operation of the Programmable Controller and the switches then the switching outputs have to be connected via the mixer diodes D_M (picture 2). Besides this a free-wheeling diode D_F is necessary because in this case the integrated free-wheeling diode does not work in this operating mode.
2. Using **one** power supply for the Programmable Controller and the switches is an alternative to the above mentioned connection (picture 3).

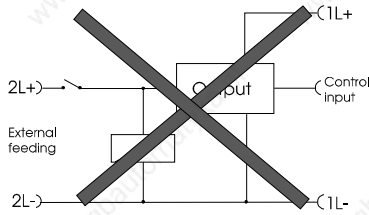

Picture 1

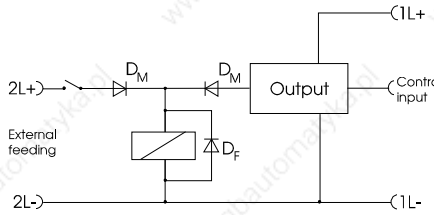

Picture 2

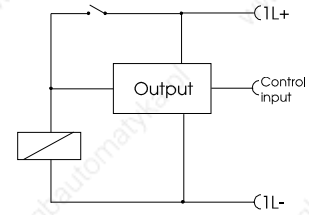

Picture 3

Setup

Input setup with DEA-UB48

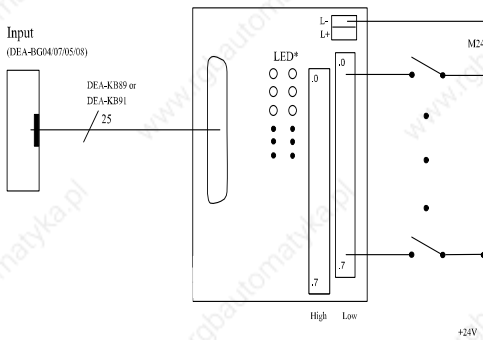

Output setup with DEA-UB48 (0,5A)

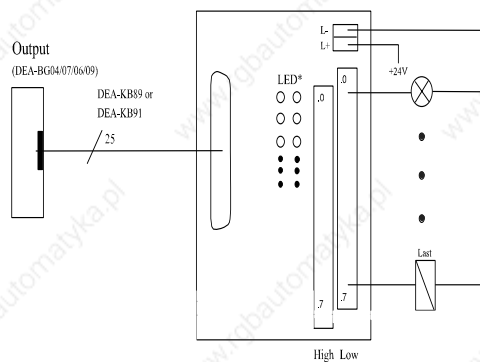

DEA-UB48
On the UB48 the high and the low byte are positioned behind each other.
*:LED indicator.

Output setup with DEA-UB46 or UB47 (2A)

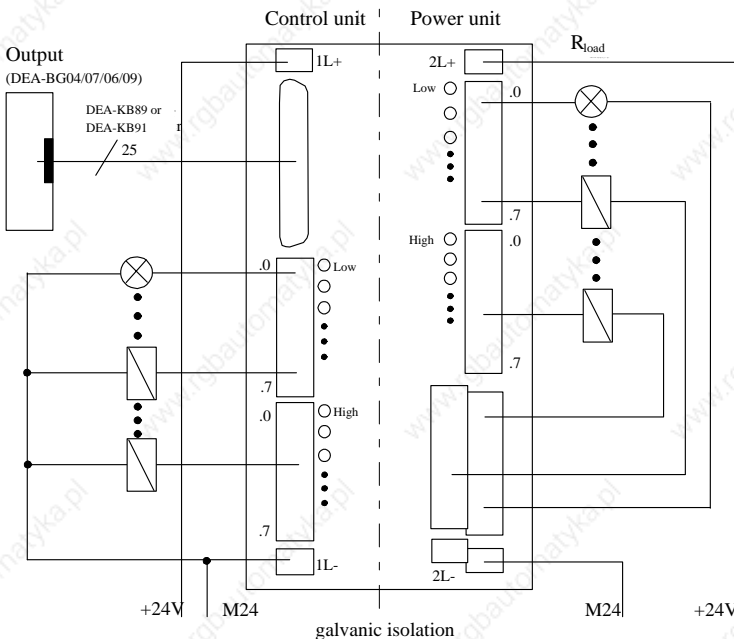

DEA-UB46 / UB47

Inputs:

- Input voltage:
- Rated: +24V DC
 - "0" signal: -5V...+2V
 - "1" signal: +12V...+33V
- input current "1" signal: 10 mA

Outputs 1L:

same specification as the output modules (DEA-BG04/07/06/09)

Outputs 2L:

- Supply voltage: 15V...33V
Output current : max. 2A (16 utp.)
max. 3A (6 Outp.)
max. 4A (2 Outp.)

Connection protect.: electronic
The output will be immediately deactivated with an $R_{load} < 1\Omega$. To reactivate the output then the short-circuit must be removed and the output has to set anew with the user program.