

USER'S MANUAL

SOFTWARE VERSION 2.09
Edition 01.04.2008

GEFRAN spa via Sebina, 74
25050 Provaglio d'Isèo (BS) ITALIA
Tel. 0309888.1 - Fax 0309839063
Internet: <http://www.gefran.com>



1 • INSTALLATION

• Dimensions and cut-out; panel mounting

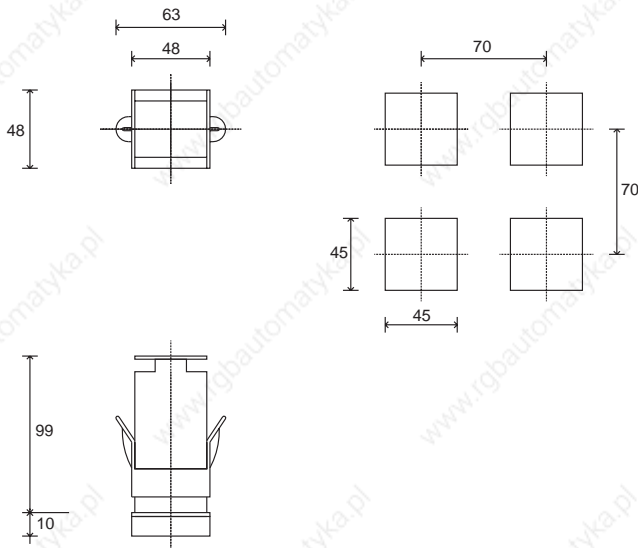

For correct and safe installation, follow the instructions and observe the warnings contained in this manual.

Panel mounting:

To fix the unit, insert the brackets provided into the seats on either side of the case. To mount two or more units side by side, respect the cut-out dimensions shown in the drawing.

CE MARKING: EMC conformity (electromagnetic compatibility) with EEC Directive 89/336/CEE with reference to the generic Standard EN50082-2 (immunity in industrial environments) and EN50081-1 (emission in residential environments). BT (low voltage) conformity respecting the Directive 73/23/CEE modified by the Directive 93/68.

MAINTENANCE: Repairs must be done only by trained and specialized personnel. Cut power to the device before accessing internal parts.

Do not clean the case with hydrocarbon-based solvents (Petrol, Trichlorethylene, etc.). Use of these solvents can reduce the mechanical reliability of the device. Use a cloth dampened in ethyl alcohol or water to clean the external plastic case.

SERVICE: GEF 600 has a service department. The warranty excludes defects caused by any use not conforming to these instructions.

2 • TECHNICAL SPECIFICATIONS

Display	2 x 4 digits, green, height 10 and 7mm
Keys	4 mechanical keys (Man/Aut, INC, DEC, F)
Accuracy	0.2% full scale ± 1 digit at 25°C room temperature
Main input (settable digital filter)	TC, RTD, PTC, NTC 60mV, 1V Ri \geq 1M Ω ; 5V, 10V Ri \geq 10K Ω ; 20mA Ri=50 Ω Sampling time 120 msec.
Type TC Thermocouples (ITS90)	J, K, R, S, T, B, E, N (IEC 584-1, CEI EN 60584-1, 60584-2) L GOST, U, G, D, C custom linearization is available
Cold junction error	0,1° / °C
RTD type (scale configurable within indicated range, with or without decimal point) (ITS90)	DIN 43760 (Pt100), JPT100
Max line resistance for RTD	20 Ω
PTC type / NTC Type	990 Ω , 25°C / 1K Ω , 25°C
Safety	detection of short-circuit or opening of probes, LBA alarm, HB alarm
°C / °F selection	configurable da tastiera/configurable from faceplate
Linear scale ranges	-1999 to 9999 with configurable decimal point position
Controls	PID, Self-tuning, on-off
pb - dt - it	0,0...999,9 % - 0,00...99,99 min - 0,00...99,99 min
Action	Heat / Cool
Control outputs	on / off, continuous
Maximum power limit heat / cool	0,0...100,0 %
Cycle time	0...200 sec
Main output type	relay, logic, continuous (0...10V / 4...20mA)
Softstart	0,0...500,0 min
Fault power setting	-100,0...100,0 %
Automatic blanking	Displays PV value, optional exclusion
Configurable alarms	Up to 3 alarm functions assignable to an output, configurable as: maximum, minimum, symmetrical, absolute/deviation, LBA, HB
Alarm masking	- exclusion during warm up - latching reset from faceplate or external contact
Type of relay contact	NO (NC), 5A, 250V/30Vdc cos ϕ =1
Logic output for static relays	24V \pm 10% (10V min at 20mA)
Triac output	20...240Vac \pm 10%, 1A max Snubberless, inductive and resistive load I 2 t = 128A 2 s
Transmitter power supply	10 / 24Vdc, max 30mA short-circuit protection
Analogue retransmission signal	10V/20mA Rload max 500 Ω resolution 12 bit
Logic inputs	Ri = 4,7K Ω (24V, 5mA) or no-voltage contact
Serial interface (optional)	RS485, isolated
Baud rate	1200, 2400, 4800, 9600, 19200
Protocol	Gefran CENCAL / MODBUS
Optional ammeter input	T.A. 50mAac, 50/60Hz, Ri = 10 Ω
Power supply (switching type)	(std) 100 ... 240Vac/dc \pm 10% (opt.) 20...27Vac/dc \pm 10%; 50/60Hz, 8VA max
Faceplate protection	IP65
Working / Storage temperature range	0...50°C / -20...70°C
Relative humidity	20 ... 85% non-condensing
Installation	Panel, plug-in from front
Weight	160g for the complete version

EMC conformity has been tested with the following connections

FUNCTION	CABLE TYPE	LENGTH
Power supply cable	1 mm 2	1 m
Relay output cable	1 mm 2	3,5 m
Digital communication wire	0,35 mm 2	3,5 m
C.T. connection cable	1,5 mm 2	3,5 m
TC input	0,8 mm 2 compensated	5 m
Pt100 input	1 mm 2	3 m

3 • DESCRIPTION OF FACEPLATE

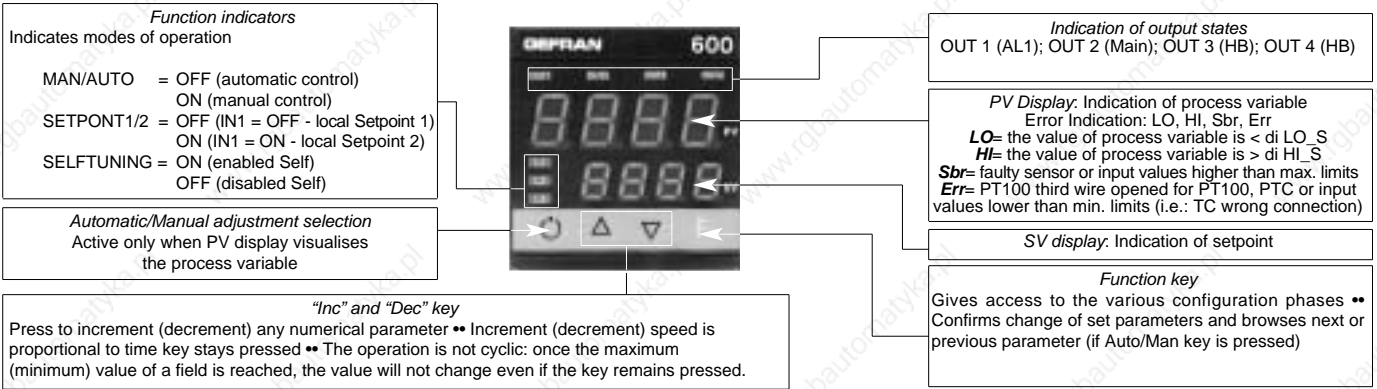

4 • CONNECTIONS

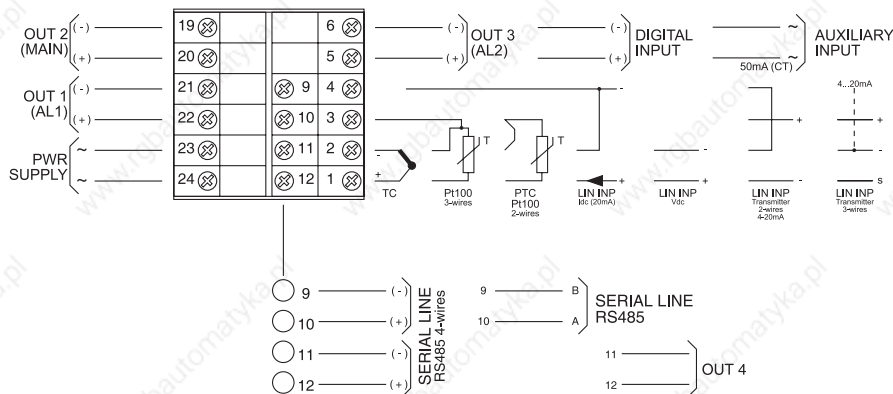

- Maximum driving torque for screws: 0,5 Nm
- Maximum Section of flexible or rigid stripped wire: 0,5 mm²
- Maximum Section of flexible or rigid stripped wire: 1,5 mm²

1) Hardware:

1.1) Factory settings:

The Gefran 600-R-R(D)-0-0-1 is factory set for PID heating, direct absolute alarm, input type "J" and access to the "EASY" programming menu (Protection level "0").

The main control output is mapped to "Out2" (terminals 19 & 20). This is noteworthy as one would intuitively consider OUT1 to be the main output. This implies that one changes the cycle time of the main control output by adjusting Ct.2 in the Out menu.

The Alarm output is mapped to Out1 (terminals 21 & 22).

1.2) Transmitter supply / Pt100:

Inside the controller are jumper settings to connect either the third wire input for Pt100 or the internal +24V(10V) transmitter voltage to terminal no. 3

Note: the factory setting of the jumper is for Pt100 input. You need to change the jumper setting to enable the +24V output on terminal no. 3 (see sketch on hardware).

The internal transmitter supply is common negative (internally linked to negative sensor input on terminal no. 2). The positive output is connected to terminal 3 via the jumper (see above).

1.3) Transmitter supply voltage:

inside the controller is a solder link to select the transmitter output voltage (24, 15, 10, 5, 1.23VDC). Factory setting is 24VDC (small track on PCB needs to be cut when changing to other voltage). (see sketch on hardware).

1.4) Digital input:

On models 600(I)-R-?-N-?-? the digital input is NOT isolated. It is common negative (terminal 6 and terminal 2). To activate the input you need to apply 24VDC to the digital input (terminals 5 and 6). Alternatively you can enable the internal 24V transmitter supply (jumper setting, see above) and use a dry contact between terminals no. 3 and no. 5

1.5) Outputs:

Type 600 controllers have up to 4 outputs, depending on the model. Each output can be mapped via software to perform one or more functions. It is for example possible to assign a combination of alarms to one output relay. It is also possible to assign the main control function to any of the outputs. If for example the relay contact on output 2 (factory setting for main control output) is damaged, you can by software change the main control function to output 1.

Factory setting: output 1 is mapped to alarm 1 and output 2 is mapped to main control (heating).

1.6) Analog output:

Type 600-R-?-C-?-? and 600-R-?-W-?-? have a small PC-board attached to the CPU board. There is a jumper setting on this board : with the jumper in place (factory default) the output is set to 0(2)-10V. When the jumper is removed the output is 0(4) to 20mA.

On the 600-R-?-C-?-? the analog output can only be used for control purposes.
 The 600-R-?-W-?-? can be configured for analog control or for analog retransmission.

Change from 0-20 (0-10V) to 4-20mA (2-10V): This is a software setting. In the "Out" menu set rL.3=64 (heat) or 65 (cool) for control purposes. For retransmission go into the "U.CAL" menu, function 1. Connect a mA (V) meter to the analog output and adjust the value (4mA or 2V) with the UP and DOWN arrow keys. The factory default setting is 0--20 mA.

• Device structure

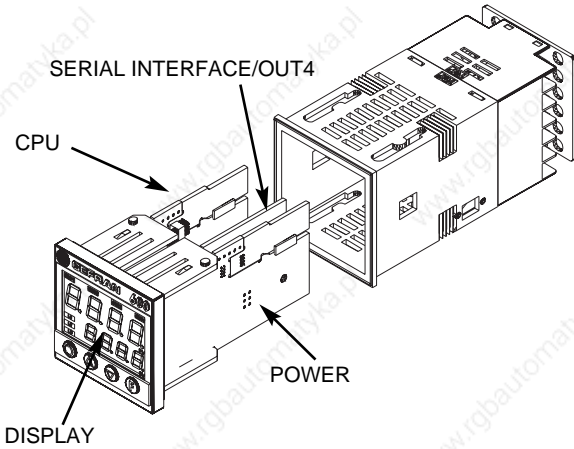

• Identification of boards

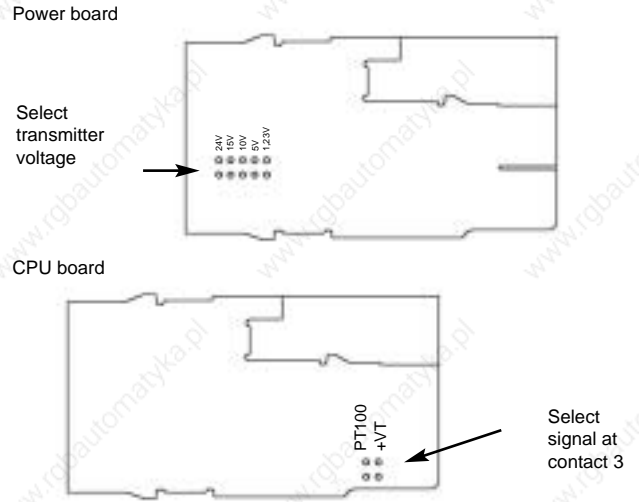

5 • PROGRAMMING and CONFIGURATION

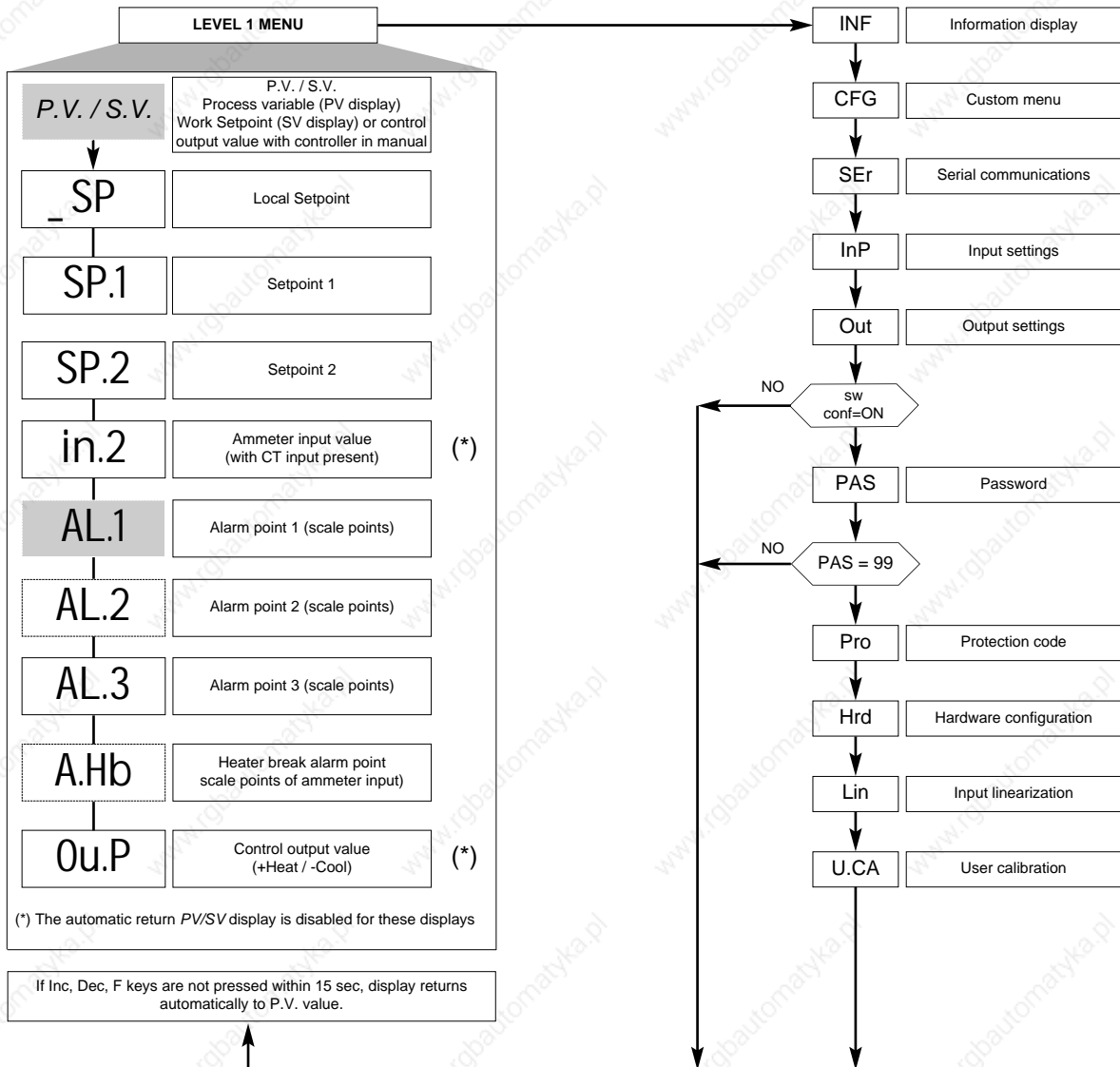

Keep the F key pressed to scroll the menus
 Release the F key to select the displayed menu
 Press the F key to access the parameters
 Keep the F key pressed to exit any menu
 Keep F + Auto/Man keys pressed for 2 sec. on any menu to go immediately to level 1 display

N.B.: Once a particular configuration is entered, all unnecessary parameters are no longer displayed



OUTPUT 2
0 = None
1 = Relay
2 = Logic
3 = Triac

INPUT /OUTPUT 3
0 = None
1 = Relay
2 = Logic
3 = Continuous
4 = Analog
5 = In TA
6 = In digital

SERIAL COMMUNICATION / OUT4
0 = None
1 = RS 485
2 = Relay

Example: 1 1 1 = R + R + RS 485

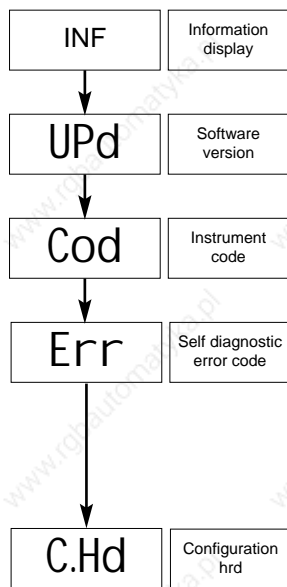

Self diagnostic error code
0 No Error
1 Lo
2 Hi
3 ERR
4 SBR

+8 error OUT2 card recognition
+16 error OUT3 card recognition

• Configuration Menus

2) Configuration menus:

2.1) Description of menus:

The programming of the 600 controller is divided into 10 menus:

INF: the information menu contains general information (software version etc.)

CFG: the configuration menu contains all parameters affecting the control behavior (enabling of self-/autotune, PID parameters, hysteresis, softstart time, loop break power etc.)

Ser: The serial communication menu only applies to controllers with serial communication. It allows selection of addresses, protocol, baud rate, Parity checking etc.

InP: the input menu contains selection of input type, the input range, filters, and limits for setpoints.

Out: the output menu allows selection of reference signals for the various alarms, alarm types, heater-and sensor failure functions, mapping of control output and alarms to the four output ports, setting of the cycle time for all PID outputs, assignment of the reference signal for the analog output.

PAS: the following menus (7-9) are password protected. Entering a password of "99" allows access to these menus:

Pro: the protection menu allows tamper proofing and restriction of access to the various menus and settings.

Hrd: the hardware configuration menu allows enabling of control via serial comms, selection of control type (PID heat, heat-cool...), the alarm types, function of the three LED's (L1---L3) , the "Auto/Manual" key, the digital input, function of the lower display...

Lin: Custom linearization for the main input can be performed in 35 steps.

U.CA: User calibration allows precision calibration of inputs and analog outputs.

2.2) Getting into the various menus:

Press and hold the "F" key on the controller down: The menus INF, CFG, Ser, InP, OuT, PASS and LEVEL 1(main menu displaying temperature and setpoint) will appear in succession.

Release the function key whenever the desired menu is displayed.

Press the button briefly to get to the first parameter in the selected menu. The parameter type is indicated in the top display, the value is shown in the bottom display.

Use the up/down arrow keys to change the parameter value.

Press the function key briefly to accept the parameter value and to move on to the next parameter.

Press and hold the "F" key down to move to other menus.

Note: It is possible that some menus do not appear while holding the function key down. This is because the protection level is preventing access to these menus. Refer to step 3.2)

Password protected menus:

Press and hold the "F" key on the controller down to get to "PAS". Release the F-key and enter the password: 99

To get into the Pro menu, press the F-key briefly.

To get into any subsequent menu (Hrd, Lin, U.CAL) press and hold the "F" key on the controller down to get to "PAS". Release the F-key and enter the password: 99

Now press and hold the function key down until the desired menu is displayed. Release the function key, then press the function key briefly to get to the first parameter in the menu.

3) Setting up the controller:

When setting up a controller it is advisable to work through the menus in the following sequence:

PAS (password=99)-Pro (enable access to menus), PAS (password=99)-Hrd, InP, Out and then CFG.

The reason is that by selecting options in a menu, some parameters in another menu become superfluous and are thus skipped, making setting-up easier.

(e.g. in ON/OFF control the h.lt and h.dt parameters are skipped)

3.1) "Pro" protection (barring access to settings):

The protection menu allows tamper proofing by restricting access to the various menus and settings. After configuring and tuning the controller we recommend setting Pro=12, thus protecting the setup, only allowing access to the control setpoint and the alarm setpoints.

Pro=0 (factory default) allows access to the "Easy" Programming menu, which contains only the most commonly used set-up parameters.

Pro=128 enables full access to all parameters.

Pro=12 allows access to the control setpoint and alarm setpoint, blocking access to all other menus.

Pro=13 will prevent changing of alarm setpoints.

Pro=14 will also prevent changes to the control setpoint.

"Easy" configuration:

(only applies to 600-R-R(D)-0-0-1 units)

The "EASY" configuration is an abbreviated version, containing only the most commonly used parameters. It is enabled by setting the protection level Pro=0. (factory default setting)

6 • "EASY" PROGRAMMING and CONFIGURATION

THE EASY CONFIGURATION IS SUITABLE FOR VERSIONS WITH TWO OUTPUTS (OUT1, OUT2). TO ACCESS THE OTHER PARAMETERS, ADD 128 TO THE Pro VALUE.

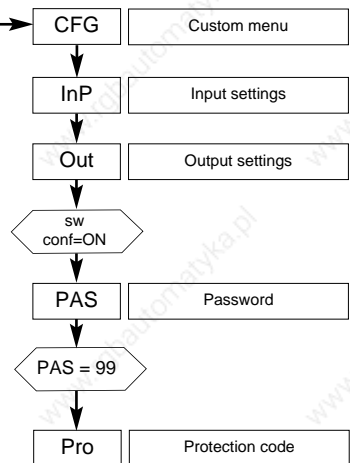
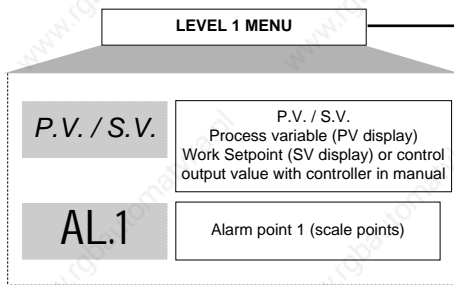

• InP

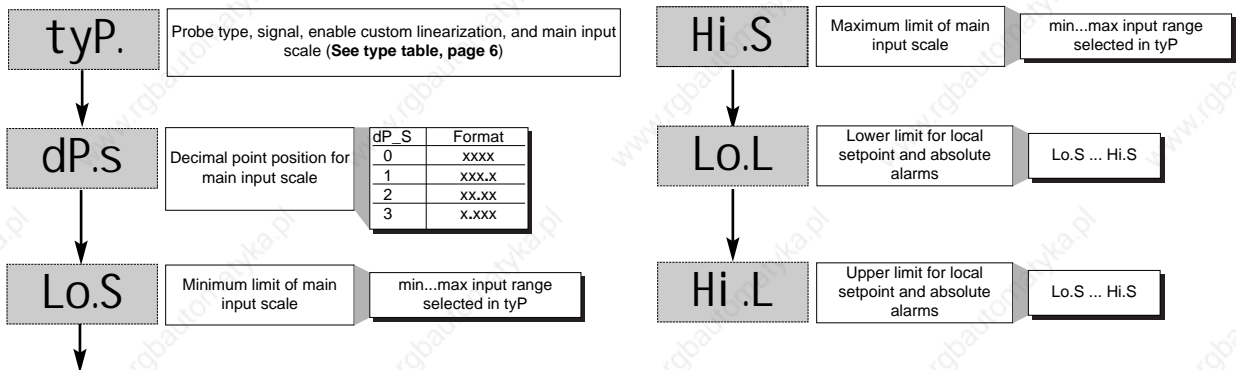

3.2.1) Input parameters (InP):

press and hold the "F" key down until you get to the InP menu, then release the "F" key.
 Press the "F" key briefly. The top display will show:
 "tyP." Use the up/down arrow keys to select the sensor input type (0=J, 2=K, 30=Pt100, see table)
 Press the "F" key briefly. The display will show:
 "dP.S" enter the number of decimal points required. (0=no decimal point, 1=one decimal point. For J, K and Pt100 sensors not more than one decimal point are possible).
 NB: See note 4.1
 Press the "F" key briefly. The top display will show:
 "Lo.S" this is the minimum sensor input scale. Leave the setting at 0 (0.0) for J or K sensors and set to -200 (-199.9) for Pt100 sensors.
 See note 4.2
 Press the "F" key briefly. The display will show:
 "Hi.S" this is the maximum sensor input scale. Set to 1000 (999.9) for J sensor, set to 1300 (999.9) for K sensor and set to 850 (850.0) for Pt100 sensors.
 NB: See note 4.1 and 4.2
 Press the "F" key briefly. The display will show:
 "Lo.L" this is the lower limit for the control and alarm setpoints.
 It prevents operators from setting the setpoints below this limit. Normal setting: Lo.L=0
 Press the "F" key briefly. The display will show:
 "Hi.L" this is the upper limit for the control and alarm setpoints. It prevents operators from setting the setpoints above this limit. Normal setting: Hi.L= Hi.S (see above)

• Out

Al.t

Alarm type 1

AL.1.t, AL.2.t, AL.3.t			
AL.x.t	Direct (high limit) Inverse (low limit)	Absolute or relative to active setpoint	Normal Symmetrical (window)
0	direct	absolute	normal
1	inverse	absolute	normal
2	direct	relative	normal
3	inverse	relative	normal
4	direct	absolute	symmetrical
5	inverse	absolute	symmetrical
6	direct	relative	symmetrical
7	inverse	relative	symmetrical

- + 8 to disable at power-on until first alarm
- + 16 to enable alarm memory
- + 32 Hys becomes delay time when alarm trips (0...999 sec.) (excluding symmetrical absolute)
- + 64 Hys becomes delay time when alarm trips (0...999 min.) (excluding symmetrical absolute)

Ct.2

Cycle time for Out2 (Heat or Cool)

1...200 sec.

3.2.2) Output parameters (Out):

Press and hold the "F" key down until you get to the OuP menu, then release the "F" key.
 Press the "F" key briefly. The top display will show:
 "Al.t" Use the up/down arrow keys to select the alarm function for the alarm output 1.
 Normal (factory default) setting: Al.t=0
 See note 4.5
 Press the "F" key briefly. The top display will show:
 "Ct.2" Use the up/down arrow keys to select the desired cycle time.
 Set Ct.2=1 If the control output switches a solidstate relay (controller type 600-R-D-0-0-1).
 Set Ct.2=20 if the control output switches a contactor or relay (controller type 600-R-R-0-0-1).
 See note 4.12

• Prot

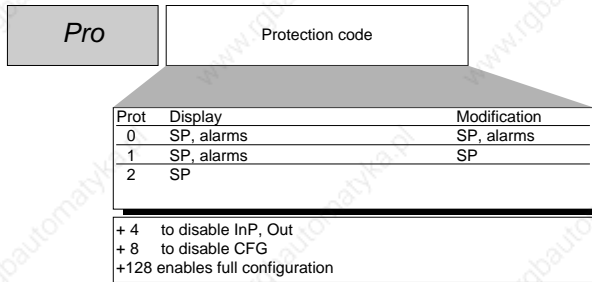

Protecting ("tamper proofing") the unit:

To get into the Prot. Menu (changing the protection level) hold the "F" key down until "PASS" appears in the top display. Release the "F" key and use the up/down arrow keys to enter the password "99". Then press the "F" key briefly. "Prot" will appear in the top display. Use the up/down arrow keys to select the desired protection level.

Typical values:

0: enabling the EASY configuration menu

128: enabling full access to all parameters

1: allowing access to EASY configuration menu, but barring access to the Alarm setpoint (view only).

2: allowing access to the EASY configuration menu, but barring access to the Alarm setpoint and disabling alarm setpoint display.

5: barring access to the InP and Out menu and barring access to the Alarm setpoint (view only). Access to the CFG menu (PID parameters) is still enabled.

13: barring access to the EASY configuration menu and barring access to the Alarm setpoint (view only). Access to the CFG menu (PID parameters) is still enabled.

Press and hold the "F" key down until you get to the level 1 menu, then release the "F" key.

• CFG

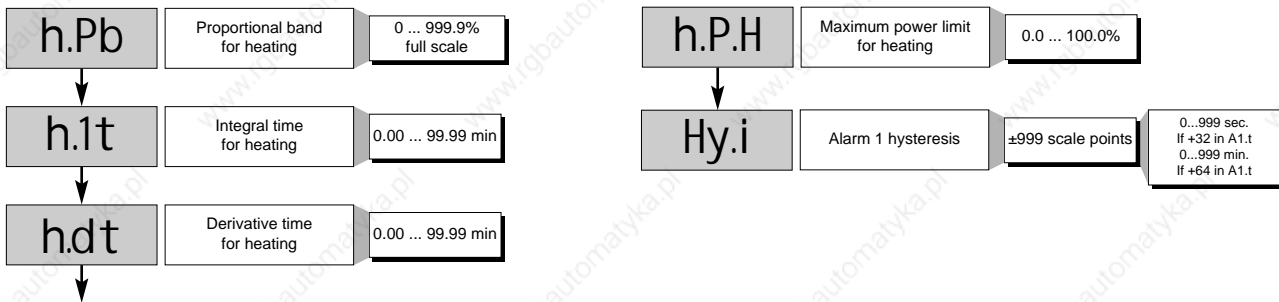

3.2.3) Configuration parameters (CFG):

Press and hold the "F" key down until you get to the CFG menu, then release the "F" key.

Press the "F" key briefly. The top display will show:

"h.Pb" Use the up/down arrow keys to select the proportional band for the main control output. The value is a % of the input range (Hi.S - Lo.S in the InP menu).

E.g. for Type "J" sensors h.Pb =4 equals 40°C (4% of 1000°C)

Press the "F" key briefly. The top display will show:

"h.It" Use the up/down arrow keys to select the integral time for the main control output. The time is set in minutes.

Press the "F" key briefly. The top display will show:

"h.dt" Use the up/down arrow keys to select the derivative time for the main control output. The time is set in minutes. (this parameter should not exceed ¼ of the h.It parameter)

See note 4.10 (PID parameters)

Press the "F" key briefly. The top display will show:

"hP.H" Normally this parameter remains set to 100 %. Use the down arrow key if you want to reduce the maximum output power of the control output. This parameter is useful if elements are rated too high for the application.

Press the "F" key briefly. The top display will show:

"hy.1" This sets the hysteresis for the Alarm output (output 1) and is a % of the input range. It should normally remain set at 0.1 Use the up/down arrow keys to change this parameter. Setting it to 100 means the alarm will latch.

Alternatively hy.1 sets the time delay before the alarm trips if the alarm type (Al.t parameter) in the Out menu is set to n+32 or n+64.

7 • COMPREHENSIVE CONFIGURATION

The comprehensive menu is enabled by setting the protection level Pro= 128:

Press and hold the "F" key down until you get to PAS then release the "F" key.

Use the UP/DOWN arrow keys to enter the password 99

Now press the "F" key briefly. The protection code Pro will be displayed.

Use UP/DOWN arrow keys to enter the protection level 128 .

• CFG

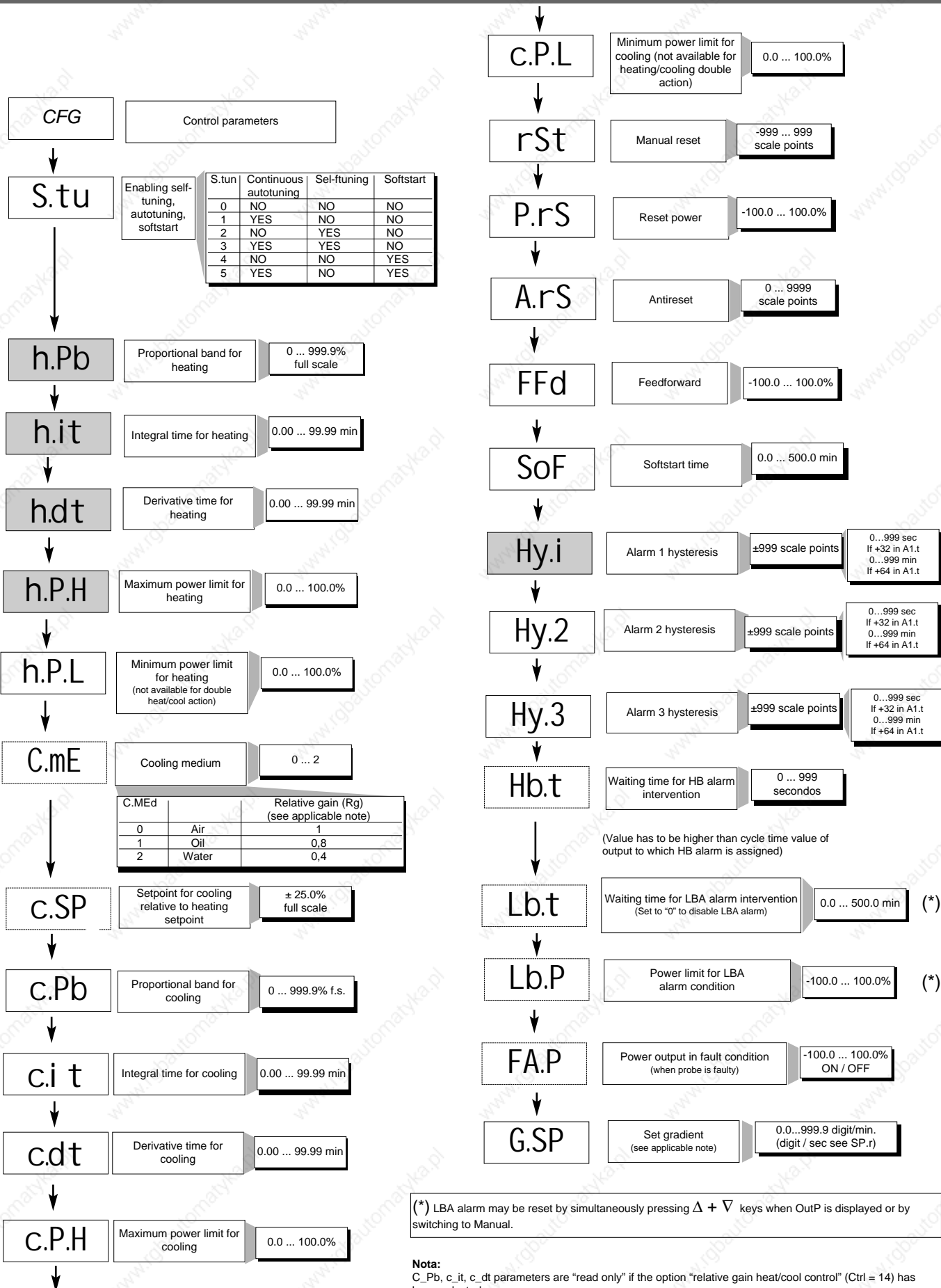

(*) LBA alarm may be reset by simultaneously pressing Δ + ∇ keys when OutP is displayed or by switching to Manual.

Nota:
C_Pb, c_it, c_dt parameters are "read only" if the option "relative gain heat/cool control" (Ctrl = 14) has been selected.

InP Input settings

SP.r Def. remote setpoint

Val.	Type of remote setpoint (from serial line)	Absolute Relative
0	Digital	Absolute
1	Digital	Relative to local setpoint

+2 set gradient in digit / sec

tyP. Probe type, signal, enable custom linearization, and main input scale

Type	Probe type	without decimal point	with decimal point
0	TC J °C	0/1000	0.0/999.9
1	TC J °F	32/1832	32.0/999.9
2	TC K °C	0/1300	0.0/999.9
3	TC K °F	32/2372	32.0/999.9
4	TC R °C	0/1750	0.0/999.9
5	TC R °F	32/3182	32.0/999.9
6	TC S °C	0/1750	0.0/999.9
7	TC S °F	32/3182	32.0/999.9
8	TC T °C	-200/400	-199.9/400.0
9	TC T °F	-328/752	-199.9/752.0
10	TC B °C	44/1800	44.0/999.9
11	TC B °F	111/3272	111.0/999.9
12	TC E °C	-100/750	-100.0/750.0
13	TC E °F	-148/1382	-148.0/999.9
14	TC N °C	0/1300	0.0/999.9
15	TC N °F	32/2372	32.0/999.9
16	L-GOST °C	0/600	0.0/600.0
17	L-GOST °F	32/1112	32.0/999.9
18	TC U °C	-200/400	-199.9/400.0
19	TC U °F	-328/752	-199.9/752.0
20	TC G °C	0/2300	0.0/999.9
21	TC G °F	32/4172	32.0/999.9
22	TC D °C	0/2300	0.0/999.9
23	TC D °F	32/4172	32.0/999.9
24	TC C °C	0/2300	0.0/999.9
25	TC C °F	32/4172	32.0/999.9
26	Ni-Ni18Mo °C	0/1100	0.0/999.9
27	Ni-Ni18Mo °F	32/2012	32.0/999.9
28	TC	CUSTOM	CUSTOM
29	TC	CUSTOM	CUSTOM
30	PT100 °C	-200/850	-199.9/850.0
31	PT100 °F	-328/1562	-199.9/999.9
32	JPT100 °C	-200/600	-199.9/600.0
33	JPT100 °F	-328/1112	-199.9/999.9
34	PTC °C	-55/120	-55.0/120.0
35	PTC °F	-67/248	-67.0/248.0
36	NTC °C	-10/70	-10.0/70.0
37	NTC °F	14/158	14.0/158.0
38	0...60 mV	-1999/9999	-199.9/999.9
39	0...60 mV	Custom scale	Custom scale
40	12...60 mV	-1999/9999	-199.9/999.9
41	12...60 mV	Custom scale	Custom scale
42	0...20 mA	-1999/9999	-199.9/999.9
43	0...20 mA	Custom scale	Custom scale
44	4...20 mA	-1999/9999	-199.9/999.9
45	4...20 mA	Custom scale	Custom scale
46	0...10 V	-1999/9999	-199.9/999.9
47	0...10 V	Custom scale	Custom scale
48	2...10 V	-1999/9999	-199.9/999.9
49	2...10 V	Custom scale	Custom scale
50	0...5 V	-1999/9999	-199.9/999.9
51	0...5 V	Custom scale	Custom scale
52	1...5 V	-1999/9999	-199.9/999.9
53	1...5 V	Custom scale	Custom scale
54	0...1 V	-1999/9999	-199.9/999.9
55	0...1 V	Custom scale	Custom scale
56	200mV..1V	-1999/9999	-199.9/999.9
57	200mV..1V	Custom scale	Custom scale
58	Cust10 V-20mA	-1999/9999	-199.9/999.9
59	Cust10 V-20mA	Custom scale	Custom scale
60	Cust 60mV	-1999/9999	-199.9/999.9
61	Cust 60mV	Custom scale	Custom scale
62	PT100-JPT	CUSTOM	CUSTOM
63	PTC	CUSTOM	CUSTOM
64	NTC	CUSTOM	CUSTOM

For custom linearization:
 - LO signal is generated with variable below Lo.S or at minimum calibration value
 - HI signal is generated with variable above Lo.S or at maximum calibration value

Max. non-linearity error for thermocouples (TC), resistors (PT100) and thermistors (PTC, NTC).
 The error is calculated as deviation from theoretical value and is expressed as percentage of full scale (in °C).

S, R range 0...1750°C; error < 0.2% f.s. (t > 300°C) / for other range; error < 0.5% f.s.
T error < 0.2% f.s. (t > -150°C)
B range 44...1800°C; error < 0.5% f.s. (t > 300°C) / range 44,0...999,9; error < 1% f.s. (t > 300°C)
U range -99,9...99,9 and -99...99°C; error < 0.5% f.s. / for other range; error < 0.2% f.s. (t > -150°C)
G error < 0.2% f.s. (t > 300°C)
D error < 0.2% f.s. (t > 200°C)
C range 0...2300; error < 0.2% f.s. / for other range; error < 0.5% f.s.
NTC error < 0.5% f.s.
Tc: J, K, E, N, L error < 0,2% f.s.
JPT100 and PTC error < 0,2% f.s.
PT100 scale -200...850°C
 Precision better than 0,2% f.s. at 25°C
 In range 0...50°C:
 • Precision better than 0,2% f.s. in range -200...400°C
 • Precision better than 0,4% f.s. in range +400...850°C (where f.s. refers to range -200... +850°C)

FLt Digital filter on input (if = 0 excludes averaging filter on sample value) 0.0 ... 20.0 sec

FLd Digital filter on input display 0 ... 9.9 scale points

dP.S Decimal point position for input scale

dP_S	Format
0	xxxx
1	xxx.x
2	xx.xx (*)
3	x.xxx (*)

(*) not available for TC, RTD, PTC and NTC scales

Lo.S Minimum limit of main input scale min...max input range selected in tyP

Hi.S Maximum limit of main input scale min...max input range selected in tyP

oFS. Offset correction of main input -999 ... 999 scale points

Ft.2 Digital filter aux. input 0.0 ... 20.0 sec

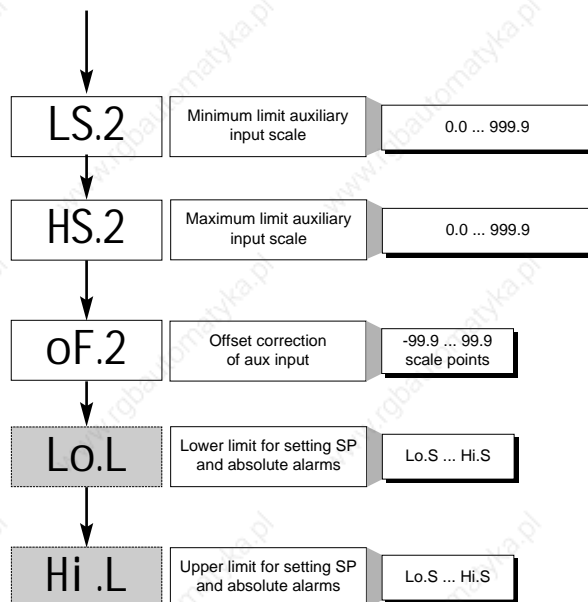

• Out

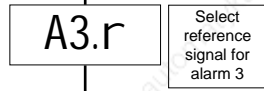
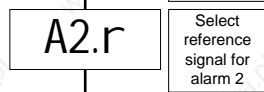
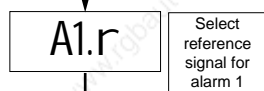
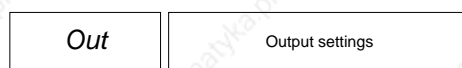

AL.1.r, AL.2.r, AL.3.r		
AL.x.r	Variable to be compared	Reference setpoint
0	PV (Process variable)	AL
1	SSP (active setpoint)	AL (only absolute)
2	PV (process variable)	AL (only relative and referred to SP1 with multiset function)]

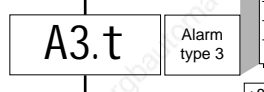
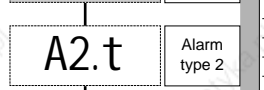
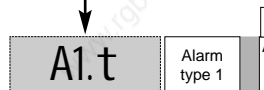

AL.1.t, AL.2.t, AL.3.t			
AL.x.t	Direct (high limit) Inverse (low limit)	Absolute or relative to active setpoint	Normal Symmetrical (window)
0	direct	absolute	normal
1	inverse	absolute	normal
2	direct	relative	normal
3	inverse	relative	normal
4	direct	absolute	symmetrical
5	inverse	absolute	symmetrical
6	direct	relative	symmetrical
7	inverse	relative	symmetrical

+8 to disable on power up until first interception
 +16 to latch alarm
 +32 Hys becomes delay time when alarm trips (0...999 sec.) (excluding symmetrical absolute)
 +64 Hys becomes delay time when alarm trips (0...999 min.) (excluding symmetrical absolute)

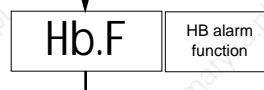

Val.	Function description
0	Relay, logic output: alarm active on load current level lower than setpoint during the ON time of the control output
1	Relay, logic output: alarm active on load current level higher than setpoint during the OFF time of the control output
2	Alarm active if one of functions 0 and 1 is true (OR logic between 0 and 1) (*)
3	For continuous heating output
7	For continuous cooling output

+0 assigned to Out1 (only for Hb_F= 0, 1, 2)
 +4 assigned to Out2 (only for Hb_F= 0, 1, 2)
 +12 assigned to Out4 (only for Hb_F= 0, 1, 2)
 +16 inverse HB alarm

(*) minimum setting is fixed at 12% of amperometric full scale

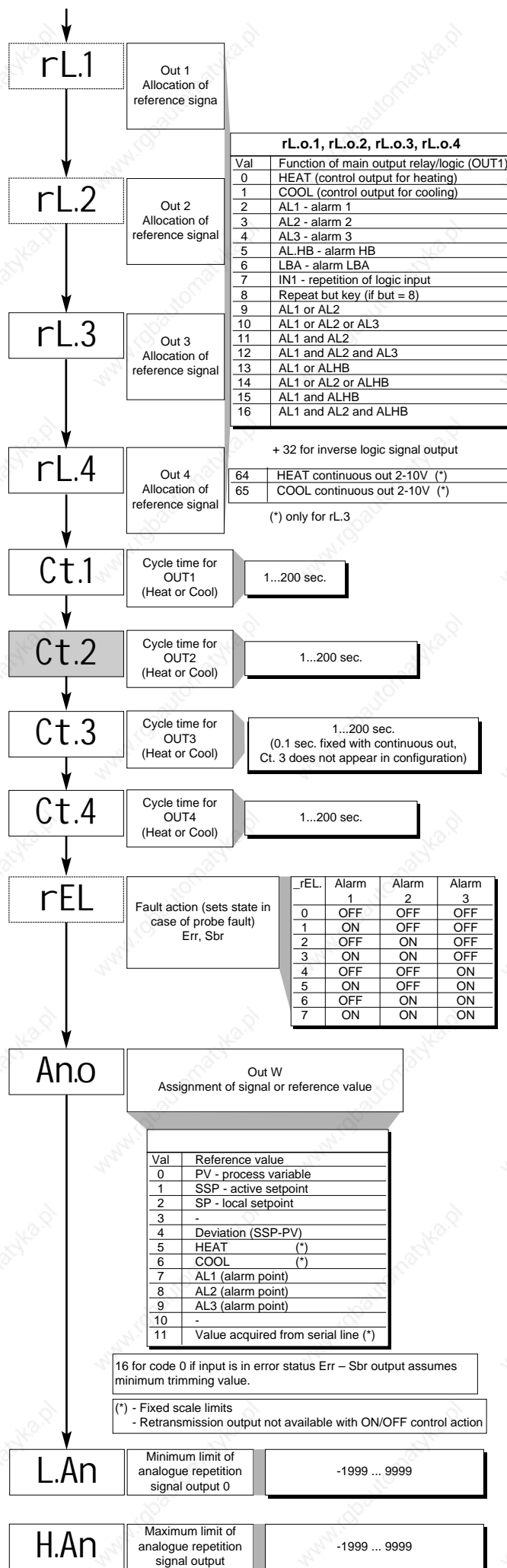

• Prot

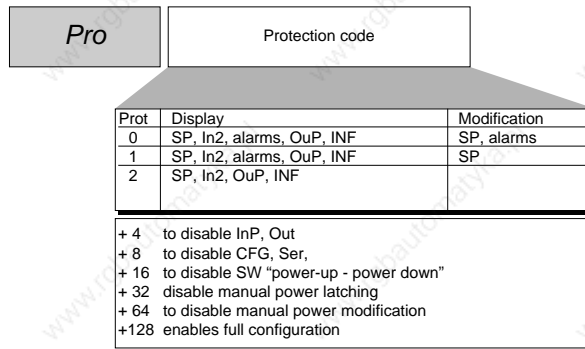

• Hrd

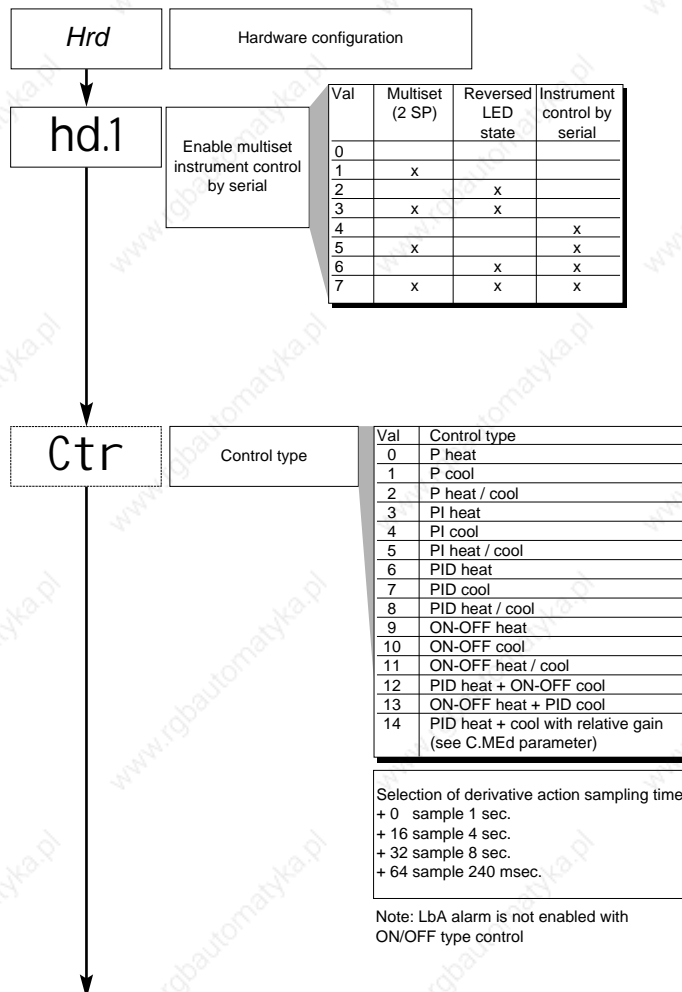

AL.n Select number of enabled alarms

AL.nr	Alarm 1	Alarm 2	Alarm 3
0	disabled	disabled	disabled
1	enabled	disabled	disabled
2	disabled	enabled	disabled
3	enabled	enabled	disabled
4	disabled	disabled	enabled
5	enabled	disabled	enabled
6	disabled	enabled	enabled
7	enabled	enabled	enabled

+ 8 to enable HB alarm
+ 16 to enable LBA alarm

but. Function of MA keys

but	
0	No function (key disenabled)
1	MAN / AUTO controller
2	LOC / REM
3	HOLD
4	Alarms memory reset
5	SP1 / SP2 Selection
6	Start / Stop selftuning
7	Start / Stop autotuning
8	Set / Reset outputs Out 1... Out 4

+ 16 disable function in configuration menu

di G. Function of digital input

dig.	
0	No function (key disenabled)
1	MAN / AUTO controller
2	LOC / REM
3	HOLD
4	Alarms memory reset
5	SP1/SP2 Selection
6	Software on/off

+ 16 for input in denied logic (NPN)
+ 32 to force logic state 0 (OFF)
+ 48 to force logic state 1 (ON)

dSP Defining SV display function

dSP	Lower display (SV) function
0	SSP - setpoint enabled
1	InP.2 - aux input
2	Control output value
3	Deviation (SSP - PV)

Ld.1
Ld.2
Ld.3

Function of LEDs

Val.	Function
0	none
1	MAN/AUTO controller
2	LOC / REM
3	HOLD
4	self-tuning enabled
5	autotuning enabled
6	IN1 repetition
7	enable serial dialogue
8	Error present
9	Softstart running
10	SP1...SP2 Indication

+ 16 LED flashes if active

• Lin

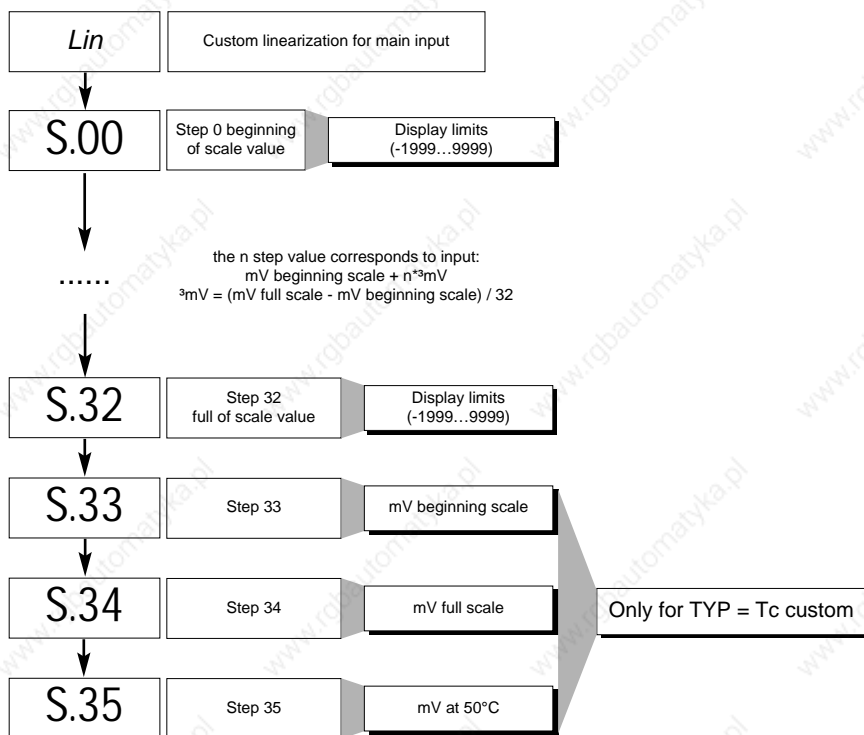

• U.CAL

U.CA	User calibration	Val	Function
		1	Analogue output (1)
		2	Input 1 - custom 10V / 20mA
		3	Input 1 - custom 60mV
		4	Custom PT100 / J PT100
		5	Custom PTC
		6	Custom NTC
		7	Input 2 - custom TA (2)

- (1) The analog output in 20mA is calibrated with accuracy higher than 0.2 % f.s.; calibrate when converting to 10V output.
 (2) In the absence of calibration, accuracy is higher than 1% f.s.; calibrate only if higher accuracy is required.

• Ser

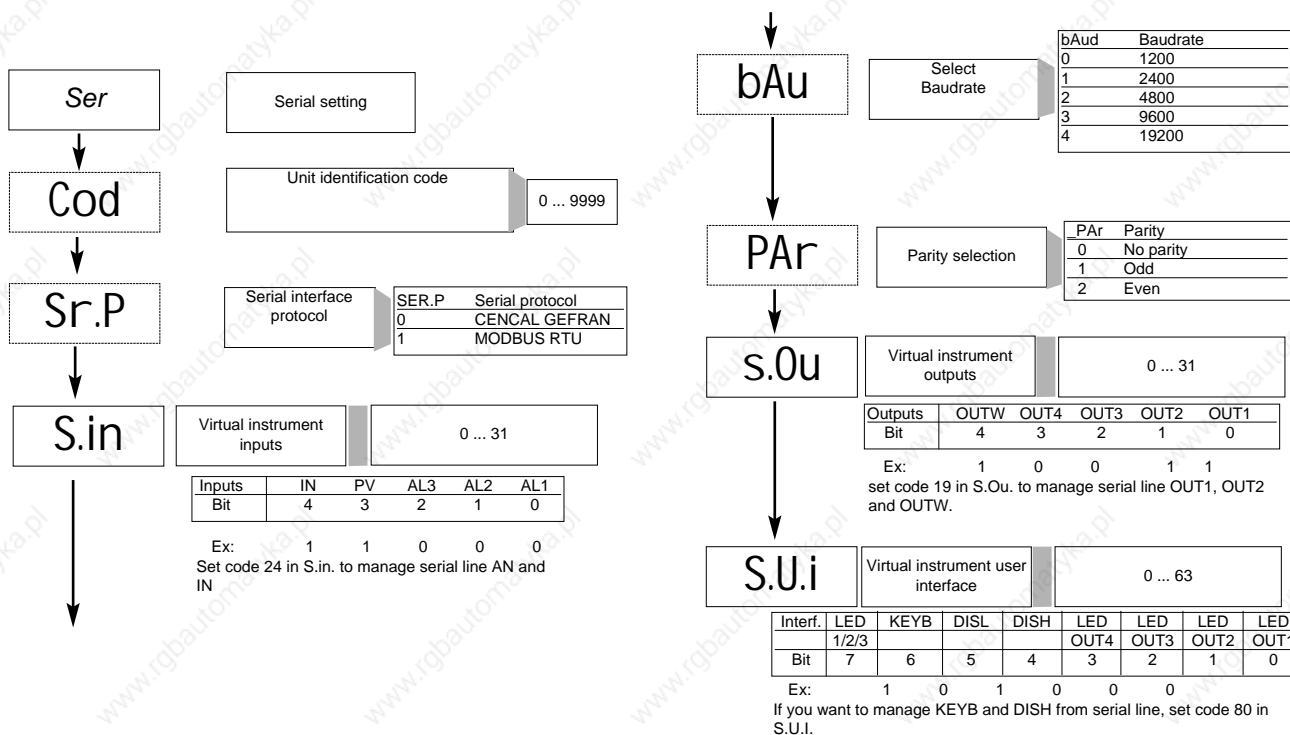

• Hardware Parameters

Press and hold the "F" key down until you get to PAS then release the "F" key.
Use the UP/DOWN arrow keys to enter the password 99
Now press and hold the "F" key until you get to the Hrd menu.
Press the "F" key briefly to move from one parameter within the menu to the next.
Use the up/down arrow keys to change the parameter value.

"hd.1" This can be used to select one or a combination of the following functions: Multiset (having 2 setpoints), Reversed LED state, or instrument control by serial communication.

"Ctr" This sets the control type. Usually Ctr=6 (PID heating) or Ctr=7 (PID cooling).

For combined heat/cool applications Ctr=12 (PID heat + ON/OFF cool, typical for extruders with air cooling) or Ctr=14 (advanced PID heat + PID cool) is useful.

See note 10

"AL.n" Use this function to select the combination of alarms you wish to enable.

See note 13

"but." Use this to program the function of the Manual/Auto key on the faceplate.

(but.=5 to switch between setpoints; but.=6 to start/stop self-tuning; but.=7 to start/stop auto-tuning)

"diG" this parameter defines the function of the digital input. The digital input serves a function similar to the M/A button, but is operated via remote switch.

(only applies to models 600-R-?-N-?-?)

"dSP" defines the value to be indicated in the lower display. Usually dSP=0, i.e. the lower display indicates the control setpoint.

See note 17

"Ld.1" This sets the function of LED 1. (4 to indicate self-tuning status; 5 to indicate auto-tuning status; 9 to indicate softstart running; 10 to indicate status of multisetpoint. Add 16 to any one of these codes to make LED flash if the associated function is active.)

"Ld.2" This sets the function of LED 2.

"Ld.3" This sets the function of LED 3.

See note 17

• Input Parameters

press and hold the "F" key down until you get to the InP menu, then release the "F" key.

Press the "F" key briefly to move from one parameter within the menu to the next.

Use the up/down arrow keys to change the parameter value.

"SP.r" (only applies to models with serial communication) defines if the remote setpoint is absolute or relative to the local setpoint.

"tyP." Selects the sensor input type: 0=J, 2=K, 30=Pt100 (see table)

For scaling of analog inputs (e.g. 0-10V, 4-20mA...) refer to note 9

"FLT" This sets the filtering of the input signal. While the filter reduces the effect of interference on the sensor wiring, it also delays the response time, thus affecting the control performance. On very fast processes (hotrunner nozzles, air heating) set FLT=0.1

On slow processes set FLT=0.5 (default)

"FLd" This filter stabilizes the display when the input variable fluctuates rapidly. It does not affect control behavior. (FLd=0.5 factory setting)

"dP.S" Enter the number of decimal points required. (0=no decimal point, 1=one decimal point). For J, K and Pt100 sensors not more than one decimal point are possible).

NB: See note 8

"Lo.S" this is the minimum sensor input scale. Leave the setting at 0 (0.0) for J or K sensors and set to -200 (199.9) for Pt100 sensors. On analog input types (e.g. 0-10V, 4-20mA...) this defines the minimum value of the input scale.

"Hi.S" this is the maximum sensor input scale. Set to 1000 (999.9) for J sensor, set to 1300 (999.9) for K sensor and set to 850 (850.0) for Pt100 sensors. On analog input types (e.g. 0-10V, 4-20mA...) this defines the maximum value of the input scale.

See note 9

"oFS." Allows offset correction of the main input. It is normally set to "0".

"FT.2" Sets the filtering of the auxiliary Input signal (applies only to 600-R-?-H-?)

"LS.2" this is the minimum auxiliary input scale (applies only to 600-R-?-H-?)

"HS.2" this is the maximum auxiliary input scale (applies only to 600-R-?-H-?)

"oF.2" Allows offset correction of the auxiliary input. It is normally set to "0"

"Lo.L" this is the lower limit for the control and alarm setpoints. It prevents operators from setting the setpoints below this limit.

"Hi.L" this is the upper limit for the control and alarm setpoints. It prevents operators from setting the setpoints above this limit.

NB: See note 9

• Output Parameters

press and hold the "F" key down until you get to the InP menu, then release the "F" key.

Press the "F" key briefly to move from one parameter within the menu to the next.

Use the up/down arrow keys to change the parameter value.

"SP.r" (only applies to models with serial communication) defines if the remote setpoint is absolute or relative to the local setpoint.

"tyP." Selects the sensor input type: 0=J, 2=K, 30=Pt100 (see table)

For scaling of analog inputs (e.g. 0-10V, 4-20mA...) refer to note 4.2

"FLt" This sets the filtering of the input signal. While the filter reduces the effect of interference on the sensor wiring, it also delays the response time, thus affecting the control performance. On very fast processes (hotrunner nozzles, air heating) set FLt=0.1

On slow processes set FLt=0.5 (default)

"FLd" This filter stabilizes the display when the input variable fluctuates rapidly. It does not affect control behavior. (FLd=0.5 factory setting)

"dP.S" Enter the number of decimal points required. (0=no decimal point, 1=one decimal point). For J, K and Pt100 sensors not more than one decimal point are possible).

NB: See note 9

"Lo.S" this is the minimum sensor input scale. Leave the setting at 0 (0.0) for J or K sensors and set to -200 (199.9) for Pt100 sensors. On analog input types (e.g. 0-10V, 4-20mA...) this defines the minimum value of the input scale.

"Hi.S" this is the maximum sensor input scale. Set to 1000 (999.9) for J sensor, set to 1300 (999.9) for K sensor and set to 850 (850.0) for Pt100 sensors. On analog input types (e.g. 0-10V, 4-20mA...) this defines the maximum value of the input scale.

See note 9

"oFS." Allows offset correction of the main input. It is normally set to "0".

"FT.2" Sets the filtering of the auxiliary Input signal (applies only to 600-R-?-H-?)

"LS.2" this is the minimum auxiliary input scale (applies only to 600-R-?-H-?)

"HS.2" this is the maximum auxiliary input scale (applies only to 600-R-?-H-?)

"oF.2" Allows offset correction of the auxiliary input. It is normally set to "0"

"Lo.L" this is the lower limit for the control and alarm setpoints. It prevents operators from setting the setpoints below this limit.

"Hi.L" this is the upper limit for the control and alarm setpoints. It prevents operators from setting the setpoints above this limit.

NB: See note 9

3.3.3) Output parameters (OuT):

Press and hold the "F" key down until you get to the OuT menu, then release the "F" key.

Press the "F" key briefly to move from one parameter within the menu to the next.

"Al.r" this sets the variable and the reference setpoint for Alarm 1.

"A2.r" same function as Al.r above but applies to Alarm 2.

"A3.r" same function as Al.r above but applies to Alarm 3.

See note 13

"Al.t" Selects the alarm function for alarm 1.

"A2.t" Selects the alarm function for alarm 2.

"A3.t" Selects the alarm function for alarm 3.

See note 17

"Hb.F" defines the Heater Break function. See note 15

"rL.1" sets the function of out1 (terminals 21 + 22). Normally rL.1=2 resulting in this output being mapped to Alarm1. For combined Heat/Cool operation this output is usually set for cooling (rL.1=1)

"rL.2" sets the function of out2 (terminals 19 + 20). Normally rL.2=0, (main output for heating)

"rL.3" sets the function of out3 (terminals 5 + 6). It only applies to units with a third output.

For controllers with analog control output (600-R-?-C---) this is set as the main output

For Heating (rL.3=0)

"rL.4" sets the function of out4 (terminals 11 + 12). It only applies to units with a fourth output.

See note 13

"Ct.1" sets the cycle time for output 1 (cooling output for Heat/cool).

"Ct.2" sets the cycle time for output 2 (main or heating output).

"Ct.3" sets the cycle time for output 3 (main or heating output).

"Ct.4" sets the cycle time for output 4 (main or heating output).

The above parameters only apply to PID control with relay or logic outputs.

Set Ct.=1 if the control output switches a solidstate relay (controller type 600-R-D-0-0-1).

Set Ct.=20 if the control output switches a contactor or relay (controller type 600-R-R-0-0-1).

Setting a shorter cycle time can adversely affect the life span of the contactor.

NB: See note 20

"rEL" sets the state to which the various alarms should revert when a sensor fault occurs.

"An.o" This applies only to units with analog retransmission (600-R?W-) and assigns the

variable to be transmitted. Apart from the input variable you can also retransmit

deviation from setpoint (An.o=4). This is useful to influence other variables in the process.

(e.g. to reduce conveyor speed when the oven temperature drops below the set value. Use the retransmission output) to feed into the variable speed drive or PLC).

Setpoints can also be retransmitted, for example where one controller provides the master setpoint for various slave units.

"L.An" sets the minimum limit ("zero") of the retransmission signal.

"H.An" sets the maximum limit ("span") of the retransmission signal

This applies only to units with analog retransmission (600-R?W-)

• Configuration Parameters

(press and hold the "F" key down until you get to the CFG menu, then release the "F" key.

Press the "F" key briefly to move from one parameter within the menu to the next

"S.tu" This enables self-tuning, auto-tuning and softstart.

See note 18

"h.Pb" Sets the proportional band for the main control output. The value is a % of the input range (Hi.S - Lo.S.) in the InP menu.

e.g. for Type "J" sensors h.Pb =4 equals 40°C (4% of 1000°C)

"h.It" Sets the integral time for the main control output. The time is set in minutes.

"h.dt" Sets the derivative time for the main control output. The time is set in minutes. (this parameter should not exceed ¼ of the h.It parameter)

See note 18

"hP.H" limits the maximum heating power. Normally this parameter remains set to 100 %.

The parameter can be reduced if elements are rated too high for the application. This reduces overshoot and also stress due to thermal expansion in the heat-up phase.

"hP.L" limits the minimum heating power. Normally this parameter remains set to 0 %.

"C.ME" only applies to PID heat/PID cool control (Ctr=14 in Hrd menu). By selecting the relevant cooling medium the PID parameters for cooling are automatically set.

"c.SP" sets the deadband between heating and cooling (only applies to heat / cool control functions). Because the controller prevents overlap between heating and cooling outputs, the deadband can be set very narrow (c.SP=2---5).

"c.Pb" Sets the proportional band for the cooling control output. The value is a % of the input range (Hi.S - Lo.S.) in the InP menu.

"c.It" Sets the integral time for the cooling control output. The time is set in minutes.

"c.dt" Sets the derivative time for the main control output. The time is set in minutes. (this parameter should not exceed ¼ of the c.It parameter)

See note 18

"cP.H" limits the maximum cooling power. Normally this parameter remains set to 100 %.

"cP.L" limits the minimum cooling power. Normally this parameter remains set to 0 %.

"rSt" Manual reset shifts the proportional band manually by a fixed amount (scale points -999 to 999), in order to remove a steady error. This function only applies to PID control. Normally rSt=0

See note 18

"P,rS" Power reset shifts the proportional band up and down about the set point by a percentage of the proportional band (0-100%). Normally P.rs=0

At 0% the proportional band is entirely below the set point.

At 50% the proportional band is centered about the set point.

At 100% the proportional band is entirely above the set point.

This function only applies to PID control.

See note 19

"A.rS" Anti reset reduces the window (scale points 0-9999) within the proportional band where integral action is active. (Normally integral action is active as soon as the process variable enters the proportional band). Outside this window integral action is deactivated. Normally A.rs=0

See note 19

"FFd" Feed forward adds a calculated proportion to the output power, and thus effectively shifts the proportional band (0-100%) up. Normally A.rs=0

See note 19

"SoF" Soft-start time is in the range 0.0 to 99.9 minutes. The soft-start action terminates when the set time has expired or when the controlled variable enters the Proportional Band.

This function is an alternative to self-tuning and if programmed it is activated each time the instrument is powered up.

"Hy.1" sets the hysteresis for the Alarm output (output 1) and is a % of the input range. It should normally remain set at 0.1 Use the up/down arrow keys to change this parameter. Setting it to 100 means the alarm will latch. Alternatively hy.1 parameter sets the time delay before the alarm trips if the alarm type (Ai.t parameter) in the Out menu is set to n+32 or n+64.

"Hy.2" sets the hysteresis for output 2 and is a % of the input range.

"Hy.3" sets the hysteresis for output 3 and is a % of the input range.

"Hb.t" sets the the waiting period for the heater break alarm (only applies to 600-R-?-H---)

"Lb.t" sets the the waiting period for the loop break alarm. (Lb.t=0 to disable)

"Lb.P" sets the default % output power under loop break conditions.

See note 14&15

"FA.P" sets the default % output power under sensor fault conditions.

See note 14

"G.SP" sets the ramping gradient.

See note 21

Press and hold the "F" key down until you get to the level 1 menu, then release the "F" key.

8 • DECIMAL POINT

When changing the decimal point the parameters Lo.S, Hi.S, oFS, Lo.L and Hi.L are affected and also the control and alarm setpoints! Make sure to check and adjust all these parameters after changing the decimal point.

For example changing the decimal point from 0 to 1 will change Hi.S from 1000 to 100.0. As a result the unit will register a sensor fault if the temperature exceeds 100°C. Set the Hi.S parameter to 999.9 to rectify this.

9 • INPUTS (SCALE, TYPE)

The input scale is defined by the parameters Lo.S and Hi.s in the CFG menu.

If the temperature falls outside the scale defined by Lo.S and Hi.s, the controller will indicate a sensor fault.

Changing the input scale also affects the proportional band in PID control because h.Pb and c.Pb are a % of the input range.

• Standard Sensor

The Gefran 600 controller allows changing of the sensor scale.

For standard temperature sensors (thermocouples, Pt100...) the Lo.S and Hi.s parameters should normally correspond with the minimum and maximum temperature scale of the particular sensor, as listed in the input table.

Example: for a type "J" thermocouple Lo.S=0 and Hi.s=1000 .

NB: When a decimal point is selected, these parameters are affected and must be reset. For instance on a sensor input type "K" setting dP.S=1 in the InP menu will change Lo.S=0 to 0.0 and Hi.s= 1300 (no decimal point) to 130.0 (with decimal point) . When the temperature rises above 130.0°C, the controller will thus indicate a sensor fault. The Hi.S parameter must therefore be reset to Hi.s=999.9 to eliminate this problem.

• Analog Inputs

For analog inputs (e.g. 4-20mA or 0-10V) Lo.S and Hi.s represent the zero and span of the input signal.

Example: input type is a temperature transmitter 4-20mA and a zero and span of -5°C and +100°C respectively (4mA representing -50°C and 20mA representing +100°C).

The correct setting for Lo.S= -50 and Hi.S= +100. If a decimal point is set (dP.S=1) then the correct setting is Lo.S= -50.0 and Hi.S= +100.0

• Custom Inputs (user calibration)

For custom Inputs the calibration (32 step) is performed in the LIN menu. The steps are numbered from 5.00 to 5.32

Example: Custom input tyP.=53 (1-5V), corresponding to a reading of 0 to 150°C

Procedure:

divide the input signal range by 32: $(5-1)/32=4/32=0.125$ V

enter the corresponding value to be displayed for each step. Since the curve is not linear, look up the matching reading for each input value on the graph or table for the input device.

step 5.00 (first step): enter value for input signal 1V (in this case "0")

step 5.01 (second step): enter value for input signal 1.125V

step 5.02 (third step): enter value for input signal 1.250V

... continue through all 32 steps, increasing the input signal by 0.125V per step and entering the corresponding value to be displayed.

step 5.32 (final step): enter value for input signal 5.0V (in this case "150")

Now set the input range in the InP menu as follows: Lo.S=0 and Hi.S=150. This will define when the input signal is out of range.

10 • CONTROL MODE

The control type is determined by the Ctr parameter in the Hrd menu.

Most commonly used setups are:

Ctr=6 PID heating (factory default setting)

Ctr=9 ON / OFF heating (the h.Pb parameter in the CFG menu sets the hysteresis, normal setting: h.Pb=0.1)

Ctr=10 ON / OFF cooling (the c.Pb parameter in the CFG menu sets the hysteresis, normal

setting: c.Pb=-0.1)

Ctr=12 PID heating, ON/OFF cooling (c.Pb sets hysteresis, same as above): This control

mode is ideally suited for extruders with air cooling using fans. In this mode the

controller prevents overlap of the heating and cooling output.

The deadband (temperature band between heating and cooling) is set by adjusting c.SP in the CFG menu. Because overlapping of heating and cooling is prevented by the controller, it is possible to set the deadband very small (e.g. c.SP=0.2), thus achieving very accurate control.

This control mode is preferable to normal PID heating (Ctr=6) using the alarm function for cooling. Normal PID heating with Alarm usually necessitates a large deadband (5-10°C) to prevent overlapping of the heat / cool operations.

Please note: you have to enable the cooling output (Out1) by setting rL.1=1 in the Out menu.

Also check that the heating output is enabled by rL.2=0 (alternatively rL.3=0 for analog control).

You also have to set the deadband c.SP in the CFG menu.

Ctr=12 PID heating, PID cooling: This control mode is ideally suited for applications where the cooling medium (air, water, oil) is controlled via a solenoid valve or motorized valve.

The deadband (temperature band between heating and cooling) is set by adjusting

c.SP (e.g. c.SP=0.2) in the CFG menu.

The PID parameters for the cooling function are automatically set by entering the relevant cooling medium in C.ME in the CFG menu (e.g. C.ME=2 for water cooling).

Check the note above regarding enabling of the cooling output.

11 • CONTROLS

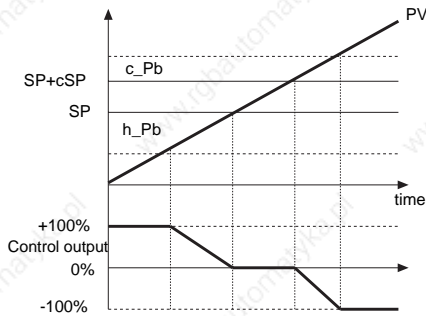

Control output with proportional action only if proportional heating band overlaps proportional cooling band.

PV = Process Value
SP+cSP = cooling setpoint
c_Pb = Proportional cooling band

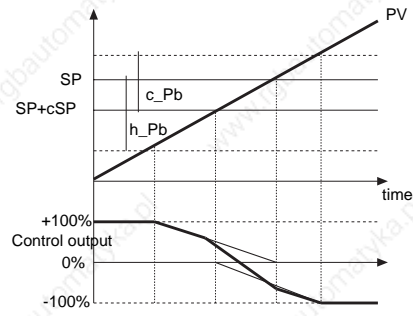

Control output with proportional action only if proportional heating band overlaps proportional cooling band.

SP = Heating Setpoint
h_Pb = proportional heating band

Heating/Cooling control with relative gain

In this control mode (enabled with Ctr = 14 parameter) the type of cooling has to be specified.

Cooling PID parameters are therefore calculated based on heating parameters according to the specified ratio.

(for example: C.ME = 1 (oil), H_Pb = 10, H_dt = 1, H_It = 4 implies: C_Pb = 12,5, C_dt = 1, C_It = 4)

We advise you to apply the following values when setting output cycle times:

Air T Cool Cycle = 10 sec.

Oil T Cool Cycle = 4 sec.

Water T Cool Cycle = 2 sec.

NB.: Cooling parameters **cannot be modified** in this mode.

Control mode:

The control type is determined by the Ctr parameter in the Hrd menu.

Most commonly used setups are:

Ctr=6 PID heating (factory default setting)

Ctr=9 ON / OFF heating (the h.Pb parameter in the CFG menu sets the hysteresis, normal setting: h.Pb=0.1)

Ctr=10 ON / OFF cooling (the c.Pb parameter in the CFG menu sets the hysteresis, normal setting: c.Pb=-0.1)

Ctr=12 PID heating, ON/OFF cooling (c.Pb sets hysteresis, same as above): This control

mode is ideally suited for extruders with air cooling using fans. In this mode the

controller prevents overlap of the heating and cooling output.

The deadband (temperature band between heating and cooling) is set by adjusting c.SP in the CFG menu. Because overlapping of heating and cooling is prevented by the controller, it is possible to set the deadband very small (e.g. c.SP=0.2), thus achieving very accurate control.

This control mode is preferable to normal PID heating (Ctr=6) using the alarm function for cooling. Normal PID heating with Alarm usually necessitates a large deadband (5-10°C) to prevent overlapping of the heat / cool operations.

Please note: you have to enable the cooling output (Out1) by setting rL.1=1 in the Out menu.

Also check that the heating output is enabled by rL.2=0 (alternatively rL.3=0 for analog control).

You also have to set the deadband c.SP in the CFG menu.

Ctr=12 PID heating, PID cooling: This control mode is ideally suited for applications where the

cooling medium (air, water, oil) is controlled via a solenoid valve or motorized valve.

The deadband (temperature band between heating and cooling) is set by adjusting

c.SP (e.g. c.SP=0.2) in the CFG menu.

The PID parameters for the cooling function are automatically set by entering the

relevant cooling medium in C.ME in the CFG menu (e.g. C.ME=2 for water cooling).

Check the note above regarding enabling of the cooling output.

12 • FAST PROCESSES

For very fast processes (e.g. air heaters and Infrared heaters) PID control performance is improved by:

-selecting a faster derivative action sampling time. This is achieved by adding 64 to the Ctr parameter in the Hrd menu (e.g. Ctr=6+64=70).

-reducing the digital input filter action by reducing FLT (e.g. FLT=0.1) in the InP menu.

-selecting the shortest possible cycle time for the control output (e.g. Ct.2=1 in the Out menu)

-using analog output (20mA, 10V) in conjunction with Thyristor drives.

13 • ALARMS

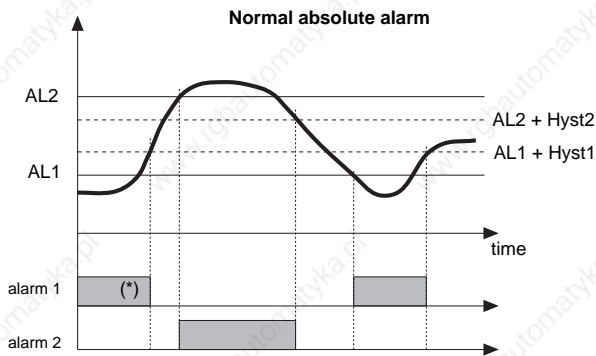

For AL1 = reverse absolute alarm (low) with positive Hyst1, AL1 t = 1
 (*) = OFF if disabled on power-up
 For AL2 = direct absolute alarm (high) with negative Hyst2, AL2 t = 0

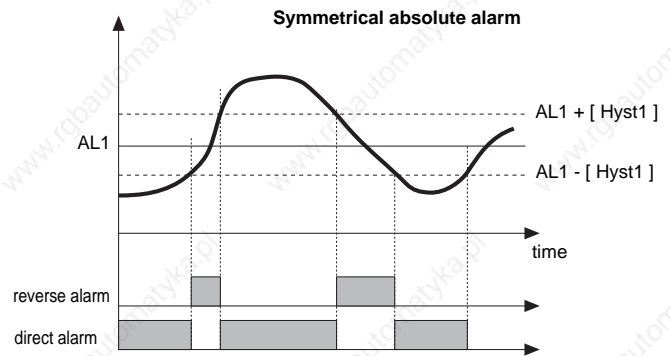

For AL1 = symmetrical Lo absolute alarm with Hyst1, AL1 t = 5
 For AL1 = symmetrical Hi absolute alarm with Hyst1, AL1 t = 4

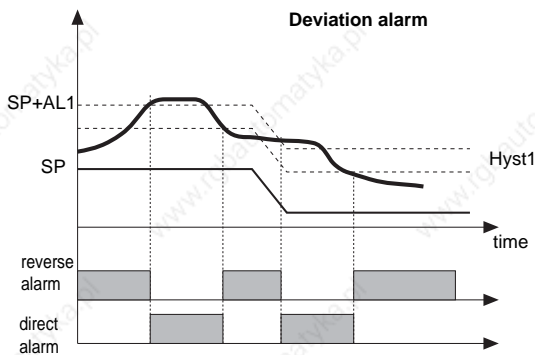

For AL1 = Lo deviation alarm with negative Hyst 1, AL1 t = 3
 For AL1 = Hi deviation alarm with negative Hyst 1, AL1 t = 2

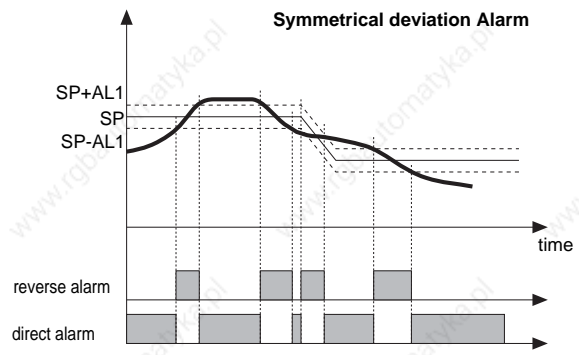

For AL1 = Symmetrical Lo deviation alarm with Hyst 1, AL1 t = 7
 For AL1 = Symmetrical Hi deviation alarm with Hyst 1, AL1 t = 6

Enabling Alarms:

Before any alarms can be configured they need to be enabled (see AL.n in the Hrd menu).

If you do not require an alarm function, set AL.n=0. This will remove the prompt for an alarm setpoint in the level1 menu.

For combined heat/cool control two outputs will be occupied. Hence you need a controller with more than two outputs (e.g. 600-R-D-R-0-1) if you want heat/cool control with alarm.

If you use a controller with only two outputs for heat/cool control (e.g 600-R-R-0-0-1), no spare output for alarm is available, hence the alarm should be disabled by setting AL.n=0

It is possible to enable up to 3 alarms. In addition the HB alarm (heater break) and the LBA (sensor fault) alarm can be activated.

Alarm outputs:

Each alarm can be assigned to any one of the available outputs (see parameters rL.1-rL.4 in the Out menu).

It is possible to assign more than one alarm to the same output. It is therefore possible to use one output relay to operate if either one (AL1 or AL2) alarm condition occurs. Alternatively the condition can be set that both alarms have to be flagged (AL1 and AL2) before the output relay operates.

Alternatively the same alarm can be assigned to more than one output. For example setting rL.1=2 and rL.3=11 will cause Relay Out1 to operate if alarm 1 is on and relay Out3 to operate if both alarm1 and alarm2 are on.

This makes alarm functions very versatile and reduces the number of output relays necessary.

Example: Extruder with heat / cool control, a contactor to shut down the machine if a high temperature condition or low temperature condition occurs, and a relay to start the process when the temperature is at operating temperature.

This would normally necessitate 5 outputs (heat, cool, high alarm, low alarm, symmetrical alarm). On the Gefran 600 this can be achieved with 4 outputs, using the 600-R-D-R-R-1.

• Alarm Reference Signals

The alarm reference signals (usually the process variable) are set by the AL.r-A3. parameters in the Out menu.

There are two variables that can cause alarms to trigger:

Firstly you can cause an alarm in response to a change in the process variable PV (e.g high temperature condition, low temperature condition etc.)

You can also cause an alarm if the control setpoint is set to excessive levels.

The reference setpoint for an alarm can either be absolute or relative to the main setpoint (see next section)

-AL.r=0 (normal setting) means the alarm will react if the main input signal is higher (lower) than the AL.1 setpoint

-AL.r=1 means the alarm will react if the main (active) setpoint is set higher (lower) than the AL.1 setpoint. (only applies to absolute alarm). This feature is useful to draw attention if the main setpoint is set to excessive levels by machine operators.

-AL.r=2 is identical to AL.r=0 except that it only applies to relative alarms, referred to the active setpoint in multiset function (special case where a second control setpoint is introduced via serial communication)

The above also applies to A2.r and A3.r

The alarm types are set by the A1.t-A3.t parameters in the Out menu.

Alarms can be set to be absolute, relative or symmetrical.

-"Direct" alarm means the alarm contact closes when the input variable (eg. Temperature) exceeds the alarm setpoint

-"Inverse" alarm means the alarm contact closes when the input variable drops below the alarm setpoint.

-"Absolute" means the setpoint is independent of the active (control) setpoint.

-"Relative" means the alarm setpoint is relative to the active (control) setpoint

• Alarm Types

-"symmetrical" means the alarm is active inside / outside a window around the control setpoint. It is used to detect abnormal deviation (positive and negative) of the input variable from setpoint.

-Alarms can be delayed by adding 32 (delay in seconds) or 64 (delay in minutes) to the selected alarm parameter. The Hy-parameter (Hy.1 -Hy.4 in CFG menu) becomes the delay time.

Examples:

Al.t=0 means that the alarm relay will close when the temperature exceeds the alarm setpoint ("high temperature alarm")

Al.t=2 and an alarm setpoint AL.1=10 means that the alarm relay will energise when the temperature rises by 10°C above the control setpoint.

Al.t=33 (1+32) and Hy.1=45 means that a low temperature alarm will come on if the low temperature condition has prevailed for 45 seconds

HB ALARM FUNCTION

This type of alarm depends on use of the current transformer (C.T.) input.

It can signal variations in load input by identifying the current value in ammeter input in the range (0 ... HS.2). It is enabled by means of configuration code (AL.n); in this case, the alarm trip value is expressed in HB scale points.

By means of code Hb.F ("Out" phase), select the type of functioning and the assigned control output.

The alarm limit setting is A.Hb.

The direct HB alarm trips when the ammeter input value is below the limit set for Hb.t seconds of the "ON" time for the selected output.

The HB alarm can be activated only with ON times greater than 0.4 seconds (excludes continuous output).

The HB alarm also checks load current during the OFF interval of the cycle time for the selected output. The HB alarm trips if the measured current exceeds approximately 12.5% of the full scale set for HB.t seconds of OFF status of the output (parameter HS.2 in InP).

The alarm is reset automatically if its cause is eliminated.

Setting limit A.Hb = 0 disables both types of HB alarms, with de-energizing of the assigned relay.

You can display the load current by selecting the item In.2. (level 1).

NOTE: ON/OFF times refer to the cycle time set for the selected output.

Continuous alarm Hb_F = 3 (7) is active for a load current value below the set limit. It is disabled if the heating (cooling) output value is below 3%.

• HOLD function

The input value and alarms are frozen while the logic input is closed.

With logic input closed, a reset turns OFF both the relay outputs and the alarms latch.

14 • SENSOR FAULT AND LOOP BREAK (LBA) ALARM

LBA loop break alarm:

The LBA alarm is enabled by setting Al.n= (between 16 and 31) in Hrd menu, but can be disabled by setting Lb.t=0 in the CFG menu.

Lb.t sets the waiting time for a LBA alarm. The % output power under fault condition is set by Lb.P in the CFG menu. An alarm output can be enabled by setting rL.1 (2, 3 or 4)=6 in the Out menu. LBA is triggered when the output power is fully on (100%) but the process variable does not respond. This will typically happen when the heating circuit is defective, a fuse is blown, the thermocouple cable is short circuited or the sensor is not mounted in position.

Apart from triggering an alarm output, the LBA alarm can be configured to force the control output into a preset % output power when a loop fault occurs. The idea is to enter an output power at which the process will continue at normal temperature without causing overheating.

NB: Do not set the Lb.t too short to avoid nuisance tripping. Do not set Lb.t too long causing overheating before output power is reduced.

• Sensor Fault

The system will indicate a sensor fault whenever the input signal falls outside the range set by Lo.S and Hi.s (InP menu).

In this condition the main control output power will default to the % set in FA.P (CFG menu).

This is a useful feature, allowing you to finish a production run before attending to a sensor fault. We recommend monitoring the % output power during normal operation (temporarily set dSP=2 in Hrd menu) and then entering this value as the FA.P parameter.

Alternatively set FA.P=0 to disable the control output (failsafe mode).

15 • HEAT BREAK ALARM (AUX. INPUT 2)

controllers with input/output 3 option ="H" monitor the load current via a 50mA secondary current transformer (refer to Gefran CT type 330200 and 330201). The load current can be displayed via the bottom SV display (set dSP=1 in Hrd menu). The scaling of the input is achieved by setting LS.2 (normally LS2=0) and HS.2 in the InP menu.

The heater Break (HB) Alarm is enabled by setting either rL.1 or rL.2 or rL.3 or rL.4=5, 13, 14, 15 or 16 and by setting Hb.F to the appropriate level (see Out menu).

A.Hb in level 1 menu sets the HB alarm setpoint.

Hb.t in the CFG menu sets the waiting period before a HB alarm is triggered.

16 • MANUAL MODE

The controller can be set into manual mode. This is achieved by setting but.=1 in the Hrd menu. It is also recommended to set either Ld.1, LD.2 or Ld.3=17 (flashing) in the the Hrd menu, thus getting LED indication if the controller is in manual mode. By operating the AUTO/MANUAL button on the faceplate the controller will switch from normal control to manual control. The PV display (bottom display) will now show the % output power. The power can be adjusted via the UP/DOWN arrow keys.

The controller will return to AUTO mode if the AUTO/MANUAL button is operated again.

17 • DISPLAY FUNCTIONS

• SV Display (bottom display)

The function of this display can be configured by setting the dSP parameter in the Hrd menu.

Normally dSP=0, showing the control setpoint. However the display can also be configured to display the value of the auxiliary input, the output power or the deviation of the process variable from the setpoint.

Display of the % output power (dSP=2) is useful to determine the output power during normal running conditions, thus obtaining the value to feed into the FA.P parameter in the CFG menu. This will then be the % output power the controller defaults to when a LBA (sensor fault) alarm occurs.

• L1, L2, L3 LED Displays

The three LEDs on the left hand side of the faceplate can be configured to indicate various conditions. The function of each LED is determined by the Ld.1-Ld.3 parameters in the Hrd menu.

The LEDs can also be configured to flash by adding 16 to the selected parameter.

Each LED can be assigned a different function. It is also possible to assign the same function to all three LEDs . e.g. setting Ld.1=Ld.2=Ld.3=24 will cause all three LEDs to flash when an error (sensor fault) occurs. This is a very visible indication.

It is recommended to assign these LEDs when any of the following features are being enabled:

Softstart, selftuning, autotuning, Manual/Auto mode.

It makes diagnostics easy if one can see in which mode the controller presently is.

18 • PID PARAMETERS, AUTOTUNE, SELFTUNE

PID parameters must be tuned to provide accurate control . There is often a tradeoff between rapid response to deviations from the setpoint , elimination of overshoot and stability of the process. PID parameters can either be tuned manually or automatically through selftuning or autotuning.

PID parameters:

The PID parameters determine the control performance and are settable in the CFG menu.

P: Proportional band:

The function of the Proportional band (see h.Pb and c.Pb) is to eliminate the cyclic overshoot/undershoot caused by thermal lag. This is achieved by reducing output power before the setpoint is reached, thus anticipating the overshoot. The closer one gets to the setpoint, the less power is provided. The proportional band is expressed as a percentage of the input scale (Hi.S-Lo.S). See example below.

A very narrow proportional band can lead to cyclic overshoot/undershoot. An excessively wide proportional band will slow down the heat up time because power is reduced too early.

Proportional control results in an error (offset).

e.g. for a type "J" input with Lo.S=0 and Hi.S=1000 and h.Pb=4.5 the proportional band is 4.5% of (1000-0)=45°C. As a result the output power of the control output will be reduced when the rising temperature enters a 45°C window below the setpoint.

I: Integral parameter

The Integral parameter (see h.it and c.it) automatically removes the error (offset) caused by the proportional control. It reduces or increases power to counteract any deviation of the process variable from setpoint. The integral parameter represents time ("Integral time") and is expressed in minutes. A long integral time results in slow correction of errors. A very fast integral time can cause ringing (oscillation) as a result of aggressive error correction.

D: Derivative parameter

The Derivative parameter (see h.dt and c.dt) counteracts rapid changes in the process variable. It is useful to reduce overshoot caused by aggressive Integral action. It also provides fast corrective action to a sudden change in the process variable. The Derivative parameter represents time ("Derivative time") and is expressed in minutes. A long Derivative time results in a strong response to a change in the process variable. Derivative time should be used with caution as it can lead to instability by overreacting to noise (electromagnetic interference) on the sensor input line. As a rule of thumb the Derivative time should be less than 25% of the Integral time. Any higher value will lead to a conflict between Integral and Derivative action, resulting in the process spiraling out of control.

• Manual Tuning

A) Enter the setpoint at its working value.

B) Set the proportional band at 0.1% (with on-off type setting).

C) Switch to automatic and observe the behavior of the variable. It will be similar to that in the figure:

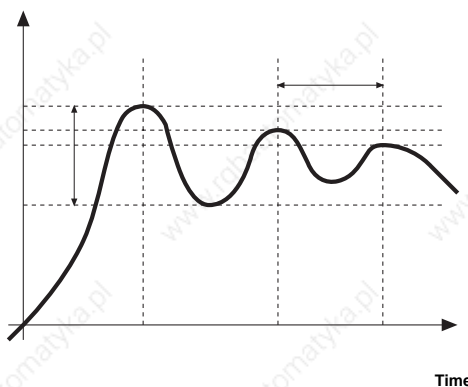

D) The PID parameters are calculated as follows: Proportional band

$$P.B. = \frac{\text{Peak}}{(V \text{ max} - V \text{ min})} \times 100$$

(V max - V min) is the scale range.

Integral time: It = 1.5 x T

Derivative time: dt = It/4

E) Switch the unit to manual, set the calculated parameters. Return to PID action by setting the appropriate relay output cycle time, and switch back to Automatic.

F) If possible, to optimize parameters, change the setpoint and check temporary response. If an oscillation persists, increase the proportional band. If the response is too slow, reduce it.

If a process is out of tune we recommend to first disable the Integral and Derivative action by setting the Integral and Derivative parameters to zero. Increase the proportional band until you obtain stability (no cyclic fluctuation). You will get a constant error (offset). Now introduce integral action. This will remove the error (offset). If excessive ringing occurs, increase the integral time. Reduce the integral time if the error reduces too slow. Now add a very short Derivative time (e.g. h.dt=0.02), not more than 25% of the Integral time.

• Selftune

Selftune is performed on a cold process (power-up) and is a once-off process. At power-up the controller will provide full power for a brief moment, then monitor rise and fall of the process variable, calculate the PID parameters and then revert to normal control. It is useful to configure one of the three LEDs L1, L2 or L3 to indicate or flash while autotuning is active.

How to activate self-tuning:

1. Activation at power-up

- 1.1 Adjust the setpoint to the required value
- 1.2 Enable selftuning by setting **Stun=2** in the **CFG** menu
- 1.3 Switch off power to the instrument and to the process
- 1.4 Make sure the process has cooled down and is far below the setpoint
- 1.5 Apply power to the controller and the process

2. Activation from keyboard

- 2.1 Adjust the setpoint to the required value
- 2.2 Enable self tuning by setting **S.tu=2** in the **CFG** menu
- 2.3 Enable stop/start self tuning via the M/A button by setting **but.=6** in the **Hrd** menu
- 2.4 Make sure the process has cooled down and is far below the setpoint Usually this is done by switching power off or disabling the heating elements
- 2.5 Apply power to the process and press the **M/A button** on the faceplate of the instrument

• Autotune

1) Continuous autotune:

Enable autotuning by setting **S.tu=1, 3 or 5** in the **CFG** menu.
The controller measures system oscillations to find the optimum.
The calculated parameters are not stored.

2) One-shot autotune:

- 2.1) Enable autotuning by setting **S.tu=8, 10 or 12** in the **CFG** menu.
 - 2.2) Enable stop/start autotuning via the M/A button by setting **but.=7** in the **Hrd** menu
 - 2.3) Initiate autotuning by pressing the M/A button on the faceplate of the instrument.
- The controller produces 10% variations from normal output power, examines the effect and optimizes PID parameters over time. It then stores the new PID parameters and automatically ends the autotuning process.
The tuning process can be ended prematurely by pressing the M/A button.

3) Automatic GO autotune:

In this mode the controller automatically triggers an autotune cycle when the process deviates from the setpoint. There are four sensitivity levels (deviation thresholds) that can be selected by choosing the appropriate **S.tu** parameter.
At power-up or after a change of setpoint, autotuning is inhibited for a time equal to five times the integral time, with a minimum of 5 minutes.

- 3.1) Deviation threshold=0.5%: **Set S.tu=24, 26 or 28** in the **CFG** Menu
- 3.2) Deviation threshold=1%: **Set S.tu=40, 42 or 44** in the **CFG** Menu
- 3.3) Deviation threshold=2%: **Set S.tu=72, 74 or 76** in the **CFG** Menu.
- 3.4) Deviation threshold=4%: **Set S.tu= 136, 138 or 140** in the **CFG** Menu.

19 • OTHER CONTROL PARAMETERS: RESET, FEED FORWARD, SAMPLING TIME

The reset facilities listed below effectively shift the proportional band in order to eliminate the error (offset) caused by proportional control. This method has its origin in the pre-microprocessor time when offset was removed by adjusting potentiometers.
We recommend that you disable the parameters below by setting them to "0".

"rSt" This function shifts the proportional band manually, by a fixed amount (scale points -999 to 999), in order to remove a steady error. It can be used instead of the automatic Integral parameter.
This function is only effective for a steady set point, as it calculates the shift according to the proportional band and not the set point for which it aims.

"P,rS" Reset power is interchangeable with Manual Reset. It shifts the proportional band up and down about the set point by a percentage of the proportional band (0-100%).
At 0% the proportional band is entirely below the set point.
At 50% the proportional band is centred about the set point.
At 100% the proportional band is entirely above the set point.
This function has no effect on on-off control.

"A.rS" Anti reset reduces the window (scale points 0-9999) within the proportional band where the integral action is calculated. Normally integral action is active as soon as the process variable enters the proportional band Outside of this window the integral time is frozen. ie: Antireset will inhibit the integral action WITHIN the proportional band. Ultimately, this will decrease overshoot.

"FFd" This function adds a calculated proportion of the set point to the output power, and thus effectively shifts the proportional band (0-100%). Like Manual Reset, it can be used instead of the integral parameter, but this function is more suited to processes that require large variations of the set point, due to its mechanism of calculating the shift according to the set point and not the proportional band itself.
The formula for this calculation is as follows:
 $OUT\%(\text{contribution of the feedforward power}) = \text{feedforward coefficient} \times (\text{Set point} - \text{LoS}) / (\text{HiS} - \text{LoS})$
This OUT% is then added to the output power.

20 • CYCLE TIME

This only applies to logic or relay outputs (output option "R" or "D"). During PID control power is increased or reduced by pulsing the output at varying duty cycle. The cycle time sets the frequency of switching of the output.

Example: if Ct.2=20 and the controller calls for 30% output power, the output will pulse at a duty cycle of 30%, thus the ON time will be 6 seconds, the OFF time will be 14 seconds, yielding a total cycle time of 20 seconds.

Contactors and relays are subject to wear and tear. Arcing across contacts during switching causes heat build up.

A shorter cycle time will therefore adversely affect the life span of the contactor/relay.

A long cycle time can cause poor control performance (cyclic fluctuation of the process variable), particularly on processes with low inertia (e.g. air heating, hotrunner nozzles...)

Typical values:

Ct.2=1 If the control output switches a solidstate relay (controller type 600-R-D-0-0-1).

Ct.2=20 if the control output switches a contactor or relay (controller type 600-R-R-0-0-1).

Ct.2= -0.1 for fast hotrunner applications (only on controller type 600-R-D-?-?-1-R62).

21 • SAFOTSTART AND GRADIENT (RAMPING) FUNCTION

• Softstart

This feature is obtained by setting S.tu=4 or 6 and by setting a softstart time in the SoF parameter (CFG menu). The purpose of softstart is to allow moisture to escape from the elements before full heating power is applied. This also reduces stress due to thermal expansion in the startup phase.

Softstart causes the output power to increase linearly when the controller is powered up. If the input variable reaches setpoint before the softstart period has expired, softstart is terminated and normal control takes over.

This feature prevents damage to elements due to moisture ingress. Elements "breathe" and the insulating material is usually hydroscopic, causing elements to fail if powered up fully after a prolonged OFF-time.

Typical setting: SoF=15 to 30 minutes

• Gradient

Gradient is set by G.SP in the CFG menu. The setpoint will ramp up to the selected level in the set period. Gradient is active at power and whenever the setpoint is changed. It is also active when the unit is switched between setpoint 1 and setpoint 2 (see hd.1 in the Hrd menu).

The purpose of the gradient is to provide smooth control without overshoot and to reduce stresses due to thermal expansion/contraction.

Please note that the SV display (bottom display) will indicate the present ramping target and not the final setpoint while ramping.

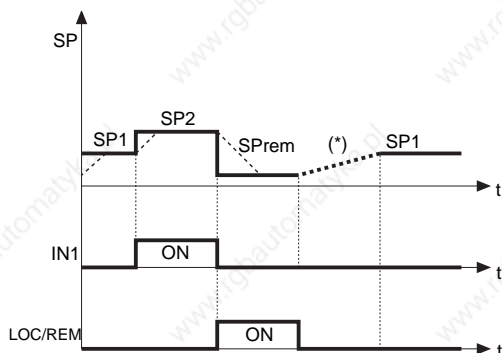

The multiset function is enabled in hd.1.

The gradient function is always enabled.

You can select between setpoint 1 and setpoint 2 with the faceplate key or with digital input.

You can display the setpoint 1-2 selection by means of LED.

SET GRADIENT: if set to $\neq 0$, the setpoint is assumed equal to PV at power-on and auto/man switchover. With gradient set, it reaches the local setpoint or the one selected.

Every variation in setpoint is subject to a gradient.

The set gradient is inhibited at power-on when self-tuning is engaged.

If the set gradient is set to $\neq 0$, it is active even with variations of the local setpoint, settable only on the relative SP menu.

The control setpoint reaches the set value at the speed defined by the gradient.

22 • SOFTWARE ON / OFF SWITCHING FUNCTION

How to switch the unit OFF: hold down the "F" and "Raise" keys simultaneously for 5 seconds to deactivate the unit, which will go to the OFF state while keeping the line supply connected and keeping the process value displayed. The SV display is OFF.

All outputs (alarms and controls) are OFF (logic level 0, relays de-energized) and all unit functions are disabled except the switch-on function and digital communication.

How to switch the unit ON: hold down the "F" key for 5 seconds and the unit will switch OFF to ON. If there is a power failure during the OFF state, the unit will remain in OFF state at the next power-up (ON/OFF state is memorized).

The function is normally enabled, but can be disabled by setting the parameter Prot = Prot +16. This function can be assigned to a digital input (d.i.G) and excludes deactivation from the keyboard.

23 • PROTECTING ("TAMPER PROOFING") THE UNIT

To get into the Prot. Menu (changing the protection level) hold the "F" key down until "PASS" appears in the top display. Release the "F" key and use the up/down arrow keys to enter the password "99". Then press the "F" key briefly. "Prot" will appear in the top display. Use the up/down arrow keys to select the desired protection level.

Typical values:

0: enabling the EASY configuration menu

128: enabling full access to all parameters

1: allowing access to EASY configuration menu, but barring access to the Alarm setpoint (view only).

2: allowing access to the EASY configuration menu, but barring access to the Alarm setpoint and disabling alarm setpoint display.

5: barring access to the InP and Out menu and barring access to the Alarm setpoint (view only). Access to the CFG menu (PID parameters) is still enabled.

13: barring access to the EASY configuration menu and barring access to the Alarm setpoint (view only). Access to the CFG menu (PID parameters) is still enabled.

24 • ACCESSORIES

• CURRENT TRANSFORMER

These transformers are used to measure currents of 50 ÷ 60Hz from 25A to 600A (nominal primary current). The peculiar characteristic of these transformers is the high number of secondary turns. This provides a very low secondary current, suitable for an electronic measurement circuit. The secondary current may be detected as voltage on a resistor.

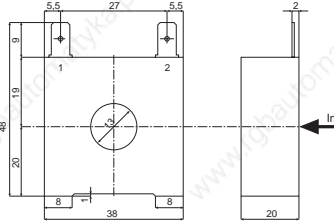
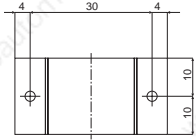
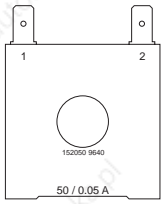

Hole for 2.9 x 9 self-threading screws

CODE	Ip / Is	Ø Secondary Wire	n	OUTPUTS	Ru	Vu	ACCURACY
TA/152 025	25 / 0.05A	0.16 mm	n _{1:2} = 500	1 - 2	40Ž	2 Vac	2.0 %
TA/152 050	50 / 0.05A	0.18 mm	n _{1:2} = 1000	1 - 2	80Ž	4 Vac	1.0 %

• ORDER CODE

COD. 330200	IN = 50Aac OUT = 50mAac
COD. 330201	IN = 25Aac OUT = 50mAac

• PTC

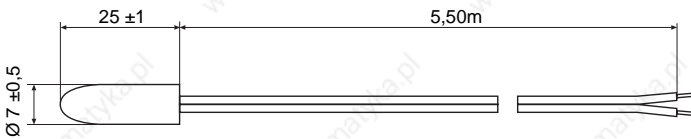

• ORDER CODE

PTC 7 x 25 5m

TECHNICAL DATA

Mod. probe:	Ambient probe
Cap material:	Plastic (Ø 7 x 25mm)
Temperature range:	-20...80°C
PTC:	R 25°C = 1Kž ±1% (KTY 81-110)
Response time:	20sec (in still air)
Isolation:	100Mž , 500Vd.c. between cap and terminals
Wire material:	Unipolar in PVC (12/0,18)
Wire length:	5,50m

• RS232 / TTL interface for GEFRAN instrument configuration



N.B. RS232 interface for PC configuration is supplied with the WINSTRUM programming software. Make connection with instrument powered but with inputs and outputs disconnected.

• ORDER CODE

COD. 1108200 Cable + Floppy

25 • APPLICATIONS

• Twin setpoint application (ramp + hold + time expiration alarm)

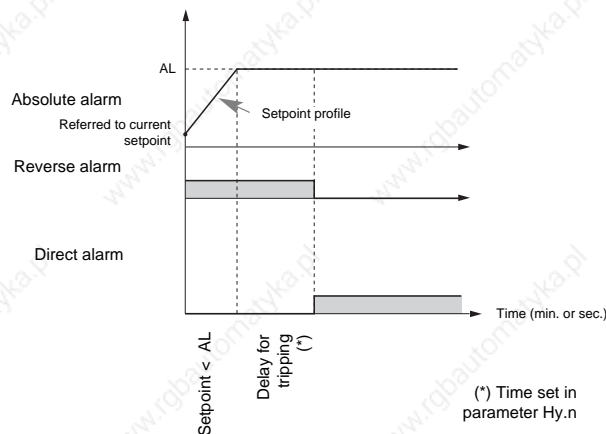

ORDER CODE

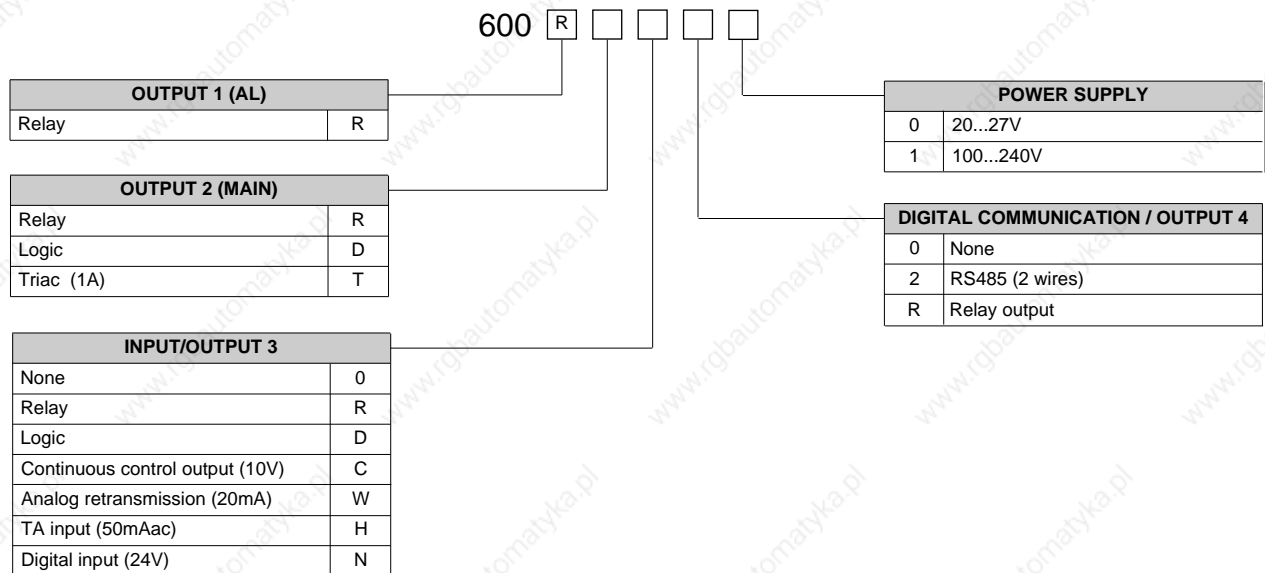

Please, contact GEFRAN sales people for the codes availability.

• WARNINGS



WARNING: this symbol indicates danger.

It is placed near the power supply circuit and near high-voltage relay contacts.

Read the following warnings before installing, connecting or using the device:

- follow instructions precisely when connecting the device.
- always use cables that are suitable for the voltage and current levels indicated in the technical specifications.
- the device has no ON/OFF switch: it switches on immediately when power is turned on. For safety reasons, devices permanently connected to the power supply require a two-phase disconnecting switch with proper marking. Such switch must be located near the device and must be easily reachable by the user. A single switch can control several units.
- if the device is connected to electrically NON-ISOLATED equipment (e.g. thermocouples), a grounding wire must be applied to assure that this connection is not made directly through the machine structure.
- if the device is used in applications where there is risk of injury to persons and/or damage to machines or materials, it MUST be used with auxiliary alarm units. You should be able to check the correct operation of such units during normal operation of the device.
- before using the device, the user must check that all device parameters are correctly set in order to avoid injury to persons and/or damage to property.
- the device must NOT be used in inflammable or explosive environments. It may be connected to units operating in such environments only by means of suitable interfaces in conformity to local safety regulations.
- the device contains components that are sensitive to static electrical discharges. Therefore, take appropriate precautions when handling electronic circuit boards in order to prevent permanent damage to these components.

Installation: installation category II, pollution level 2, double isolation

- power supply lines must be separated from device input and output lines; always check that the supply voltage matches the voltage indicated on the device label.
- install the instrumentation separately from the relays and power switching devices
- do not install high-power remote switches, contactors, relays, thyristor power units (particularly if "phase angle" type), motors, etc... in the same cabinet.
- avoid dust, humidity, corrosive gases and heat sources.
- do not close the ventilation holes; working temperature must be in the range of 0...50°C.

If the device has faston terminals, they must be protected and isolated; if the device has screw terminals, wires should be attached at least in pairs.

- **Power:** supplied from a disconnecting switch with fuse for the device section; path of wires from switch to devices should be as straight as possible; the same supply should not be used to power relays, contactors, solenoid valves, etc.; if the voltage waveform is strongly distorted by thyristor switching units or by electric motors, it is recommended that an isolation transformer be used only for the devices, connecting the screen to ground; it is important for the electrical system to have a good ground connection; voltage between neutral and ground must not exceed 1V and resistance must be less than 60hm; if the supply voltage is highly variable, use a voltage stabilizer for the device; use line filters in the vicinity of high frequency generators or arc welders; power supply lines must be separated from device input and output lines; always check that the supply voltage matches the voltage indicated on the device label.

- **Input and output connections:** external connected circuits must have double insulation; to connect analog inputs (TC, RTD) you have to: physically separate input wiring from power supply wiring, from output wiring, and from power connections; use twisted and screened cables, with screen connected to ground at only one point; to connect adjustment and alarm outputs (contactors, solenoid valves, motors, fans, etc.), install RC groups (resistor and capacitor in series) in parallel with inductive loads that work in AC (*Note: all capacitors must conform to VDE standards (class x2) and support at least 220 VAC. Resistors must be at least 2W*); fit a 1N4007 diode in parallel with the coil of inductive loads that operate in DC.

GEFRAN spa will not be held liable for any injury to persons and/or damage to property deriving from tampering, from any incorrect or erroneous use, or from any use not conforming to the device specifications.

