

WARNING

- When connecting a power cable to the GP unit, be sure the cable has been unplugged from the power outlet, so that you would not get an electric shock.
- High voltage runs in the GP unit, so if you take unit apart, there is a danger of getting an electric shock. Do not take the unit apart.
- Do not use power beyond the specified voltage range. If you do, it may cause a fire or an electric shock.
- Do not reconstruct the GP unit. It may cause a fire or an electric shock.
- Do not use the GP in an environment with flammable gas in the surrounding atmosphere. It may cause explosion.
- GP use a lithium battery for backing up its internal clock data. If the battery is incorrectly replaced, the battery may explode. To avoid the danger, do not replace the battery yourself. When the battery needs a replacement, please consult with your local GP distributor.
- Do not use touch panel switches in life-related or important disaster prevention situations. For safety related switches, such as an emergency switch. use a separate mechanical switch.
- Please design your system so that the machine will not malfunction by a communication fault between the GP and its host controller. If not, there could be a danger of injuring a person or damaging materials.

To Prevent From Damage:

- Do not hit the touch panel with a hard or heavy object, or press the touch panel with too much force, for it may cause irreparable damage.
- Do not use GP in an environment where the surrounding temperature exceeds the specification range, for it may damage the unit.
- Please ensure that liquids or metal do not enter the GP unit, for it may cause malfunction or a short.
- Please avoid using the unit in areas where sudden, large changes in temperature may occur. These changes can cause condensation to form inside the unit, possibly causing an accident.
- To prevent from heat building up inside the GP, please do not install GP where its ventilation holes may be blocked, or where heat cannot escape. Also, please avoid using or storing the GP in an extremely hot place.
- Do not operate the GP in areas with temperatures and humidity in excess of those levels specified to prevent the GP's touch panel from becoming warped or bent.
- Please avoid using or storing the GP under direct sunlight or in a dusty environment.
- This unit is a delicate equipment, so please avoid using or storing the GP unit in an environment where it can receive strong impact or vibration.
- Please avoid using or storing GP where vaporized chemicals or chemicals can stick to it.
- Do not use paint thinner or organic solvents to clean the GP unit or display.
- Because unforeseen circumstances may befall your GP unit, be sure to back up your screen data.
- After turning this unit OFF, be sure to wait a few seconds before turning ON again. If the unit is started within a few seconds, it may not start up correctly.

UL/cUL(CSA) Approval

The GP477R-EG41-24VP are UL/cUL(CSA) recognized products.
(UL file No. E182139)

■ GP477R-EG41-24VP conforms as a component to the following standards:

- EUL508
Industrial Control Equipment
- UL1604
Electrical Equipment for Use in Class I and II Division 2 and Class III Hazardous (Classified) Locations
- CAN/CSA-C22.2, Nos.142,and 213-M1987
Standard for Safety of Information Technology Equipment, including Electrical Business Equipment

GP477R-EG41-24VP (UL Registration Model : 2780027-01)

- The GP should be installed in the front face of a metal panel.
- If the GP is installed so as to cool itself naturally, be sure to install it in a vertical panel. Also, be sure that the GP is mounted at least 100mm away from adjacent structures and other equipment, otherwise, the heat generated by the GP's internal components may become higher than that allowed by UL standard requirements.
- The terminal block's earth terminal() is a protective earth terminal. Be sure to connect this terminal in accordance with UL standards.

Installation and operation instructions are provided with each GP. These installation instructions contain the following statements.

1. Power, input and output (I/O) wiring must all be in accordance with Class I, Division 2 wiring methods, Article 501-4 (b) of the National Electrical Code, NFPA 70, or as specified in Section 18-152 of the Canadian Electrical Code for units installed within Canada, and in accordance with that location's authority.
2. Suitable for use in Class I, Division2, GroupsA, B, C and D hazardous location, or nonhazardous locations only.
3. WARNING: Explosion hazard-substitution of components may impair suitability for Class I, Division2.
4. WARNING: Explosion hazard-do not disconnect equipment unless power has been switched off or the area is known to be nonhazardous.
5. WARNING: Explosion hazard-when in hazardous locations, turn off power before replacing or wiring modules.

CE Marking

GP477R-EG41-24VP is CE marked , EMC compliant products.These units also conform to EN55011 class A , EN50082-2 directives.

Package Contents

The following items are included in the package. Before using, please ensure everything is there.

■ GP unit

(GP477R-EG41-24VP)

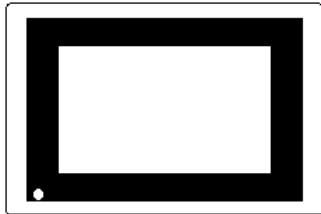

■ Installation fasteners (4 pcs)

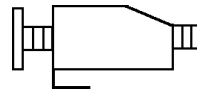

■ Handling guide 1 sheet

(this sheet)

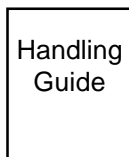

This unit has been carefully packed, with special attention to quality. However, should you find anything damaged or missing, please contact your local GP distributor immediately.

Extra-Cost Options

■ Manual

GP477R/577R Series

User's Manual

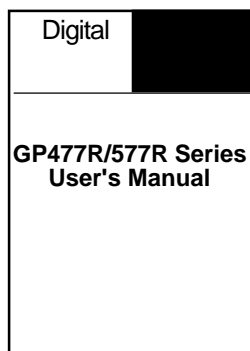

■ Cables

■ Adapters

■ Screen editor software
are optionally available.

For more information, see Digital's catalogues.

1 Names and Functions of GP Parts

Names and Functions of GP Parts are explained below.

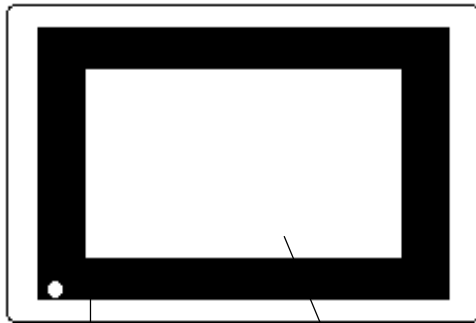

C

AB

A: Display

The monitor screen that indicates screens and data of the host.

High intensity EL display

B: Touch Panel

Runs any screen change operations and sends data to the PLC.

C: Power Lamp

Lights up when the power is turned On.
(Green LED)

D: Power Input Terminal Block

The input and ground terminals for AC power cable.

E: Auxiliary Input/Output (AUX)

Operates the Touch Switch, System Alarm, Buzzer, Run outputs, and Remote Reset inputs.

F: Serial Interface

RS-232C, RS-422 (Serial) interface. Connect to the Host.

G: Printer Interface

Connect the printer here.

H: Tool Connector

Connect the Downloading Cable, or a Bar Code Reader here.

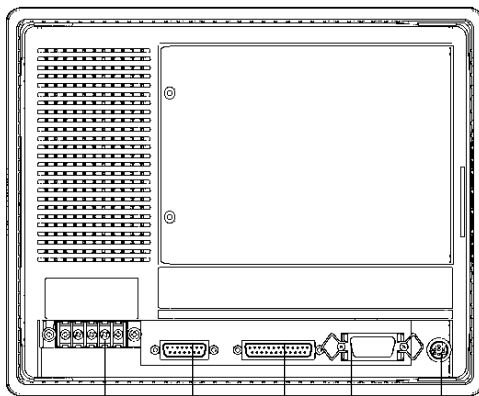

D

E

F

G

H

2 Dimensions

The drawings below illustrate the dimensions of the GP477R-EG41-24VP unit.

unit:mm

Top View

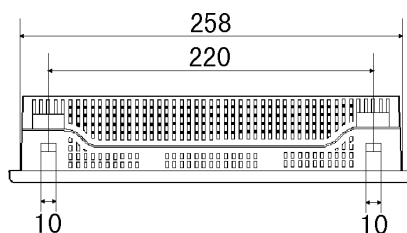

Front View

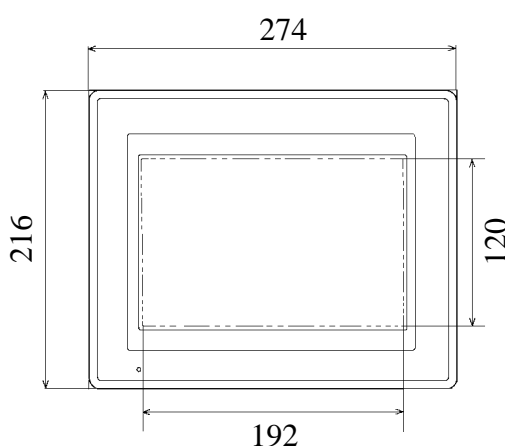

Side View

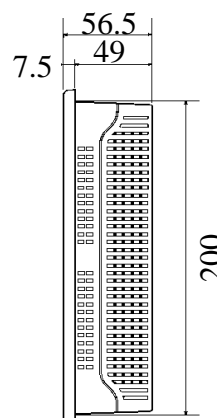

3 Serial Interface

This is GP's serial port for RS-232C and RS-422 interface. Connect GP's host here.

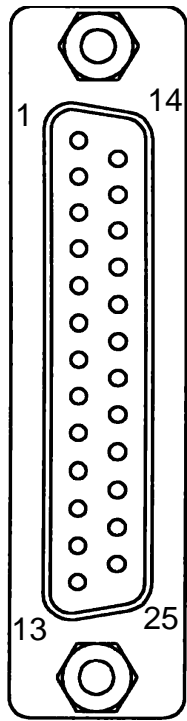

Pin #	Signal Name	Condition	Pin #	Signal Name	Condition
1	FG	Frame ground	14	VCC	5V±5% output 0.25A *
2	SD	Send data (RS-232C)	15	SDB	Send data B (RS-422)
3	RD	Receive data (RS-232C)	16	RDB	Receive data B (RS-422)
4	RS	Request send (RS-232C)	17	NC	No connection
5	CS	Clear send (RS-232C)	18	CSB	Clear send B (RS-422)
6	NC	No connection	19	ERB	Enable receive B (RS-422)
7	GND	Signal ground	20	ER	Enable receive (RS-232C)
8	CD	Carrier detect (RS-232C)	21	CSA	Clear send A (RS-422)
9	TRMX	Termination (RS-422)	22	ERA	Enable receive A (RS-422)
10	RDA	Receive data A (RS-422)	23	RESERVED	Reserved for future use
11	SDA	Send data A (RS-422)	24	NC	No connection
12	NC	No connection	25	RESERVED	Reserved for future use
13	NC	No connection			

* Pin # 14 can be used for the power supply for the user's optional equipment connected to the GP.

Recommended Connector: Dsub 25 pin plug XM2A-2501 <made by OMRON Corp.>
 Recommended Cover: Dsub 25 pin Cover XM2S-2511 <made by OMRON Corp.>
 Jack Screw XM2Z-0071 <made by OMRON Corp.>



- Use rough metric type M2.6 x 0.45p threads used to hold the cable's set (fastening) screws in place.

Recommended Cable: CO-MA-VV-SB5P x 28AWG <made by HITACHI Cable Ltd.>



- Pin # 14 is not protected, so be sure to use it only within its rated range.
- Be sure to connect this unit's SG terminal to the other unit's SG terminal. If necessary, you may also need to connect the FG terminal to the other unit's FG terminal depending on the type of the other unit you use.



When making a cable, please be aware of the following:

<For RS-422 Connection>

- The following pairs of pin #'s must be connected to each other
 ...#18 (CSB) <-> #19 (ERB)
 ...#21 (CSA) <-> #22 (ERA)
- When connecting the RS-422 cable and the #9 (TRMX) and #10 (RDA) points, a termination resistance of 100Ω is added between RDA and RDB.
- When the GP is set as a Memory Link type and the cable type is RS-422, a 4-line system must be setup.

<For RS-232C connection>

- Do not connect #9 (TRMX), #10 (RDA), #11 (SDA), #15 (SDB), #16 (RDB), #18 (CSB), #19 (ERB), #21 (CSA), and #22 (ERA).

4 Printer Interface

This is the printer interface port in the rear side of GP unit.

Pin Connection	Pin #	Signal Name
	1	<u>PSTB</u>
	2	PDB0
	3	PDB1
	4	PDB2
	5	PDB3
	6	PDB4
	7	PDB5
	8	PDB6
	9	<u>PDB7</u>
	10 ^{*1}	<u>INIT</u>
	11	BUSY
	12	NC
	13	NC
	14	GND

*1 When not using the INIT signal, the 10 pin connection becomes unnecessary.

Recommended Connector: FCN-787P014-G/R <manufactured by FUJITSU, Inc.>

Recommended Cover: FCN-780C014-D/E <manufactured by FUJITSU, Inc.>



- Do not connect to pin #12 and #13.

5 AUX Interface (Input/Output)

An auxiliary interface for touch switch output, system alarm output, RUN output, and remote reset input.

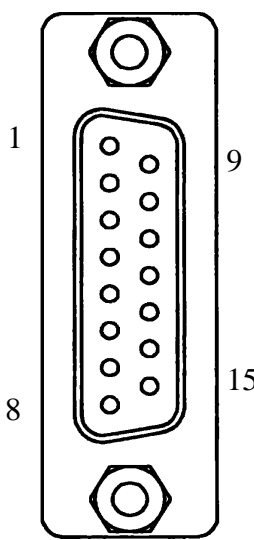
Pin Connection	Pin #	Signal Name	Contents
	1	TSW0	Touch Switch Output (8 bit)
	2	TSW1	
	3	TSW2	
	4	TSW3	
	5	TSW4	
	6	TSW5	
	7	TSW6	
	8	TSW7	
	9	RUN	Output: On in RUN mode; Off in standby mode or when the power is off.
	10	ALARM	Alarm Output: When On, GP unit alarm origin *1
	11	BUZZ	Buzzer Output
	12	DC24V	Output-Common (DC24V)
	13	AIN-C	Input-Common (DC24V)
	14	AOUT-C	Output-Common (GND)
	15	RESET	Reset Input

*1 The AUX Alarm outputs in the following two cases:

- Hardware Alarm (SCREEN MEMORY CHECKSUM ERROR)
- Software Alarm (SYSTEM ERROR, incorrect data that makes continuation of screen operation impossible.)

Recommended Connector: Dsub 15 pin Plug XM2A-1501 <made by OMRON Corp.>
 Recommended Cover: Dsub 15 pin Cover XM2S-1511 <made by OMRON Corp.>
 Jack Screw XM2Z-0071 <made by OMRON Corp.>



- Use rough metric type M2.6 x 0.45p threads used to hold the cable's set (fastening) screws in place.

6 Installation

■ Confirm the Installation Gasket's Seating

It is strongly recommended that you use the gasket.

Place the GP on a level surface with the display panel facing downward. Check that the GP's installation gasket is seated securely into the gasket's groove, which runs around the perimeter of the panel's frame.

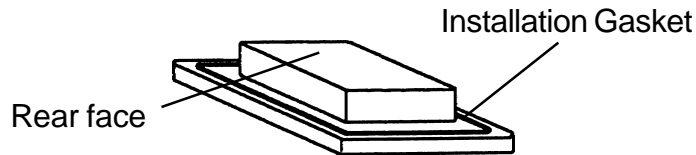

- Before installing the GP into a cabinet or panel, check that the Installation gasket is securely attached to the unit.

■ Cut a hole, and mount the GP to the panel from the front.

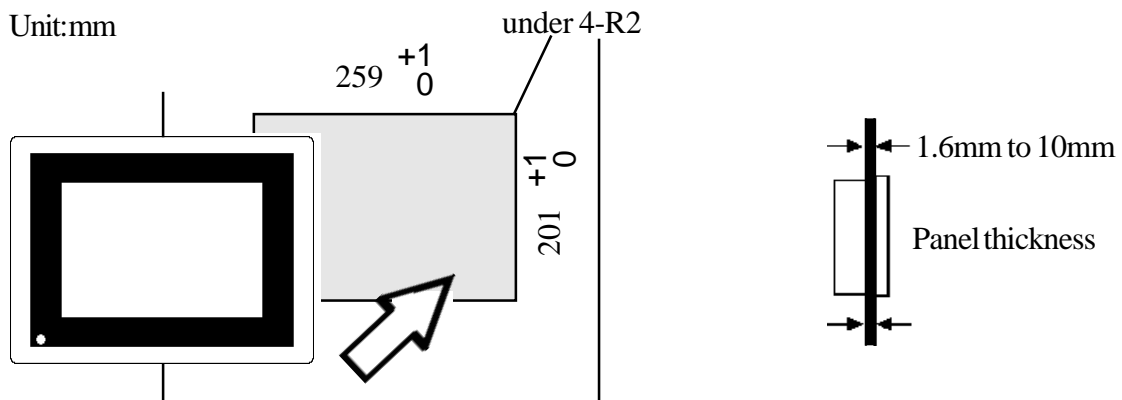

■ Attach the Installation Fasteners from behind.

Fasten the screw of the installation fasteners with a screwdriver.

The fastening torque necessary for waterproofing is 0.5-0.6N•m.

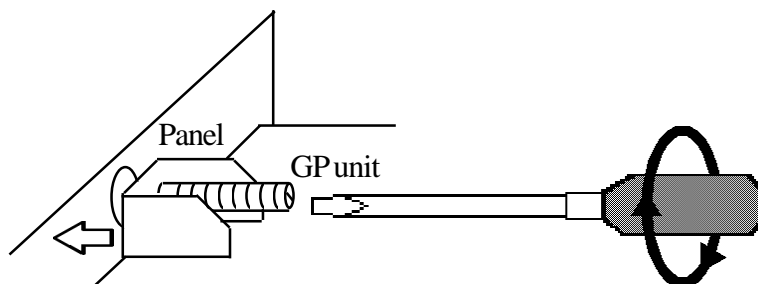

- Tightening the screws with too much force can cause a damage.

7 Wiring



WARNING

- To avoid electric shock, be sure the Power Cable is unplugged from the power outlet when connecting the cable to the GP unit.
- GP477R-EG41-24VP can only take DC24V input. If you supply power other than DC24V, you will damage its power supply and the GP unit.
- There is no power switch on the GP unit, so please use a breaker switch.
- Be sure to earth the ground terminal (⊕). If there is an accident, there is the possibility of an electrical shock from the GP.



- When the FG terminal is connected, be sure the wire is grounded. Not grounding the GP unit will result in excess noise and vibrations.



- Wherever you can, use thick wires (max. 2 mm²) for power terminals, and provide an extra twist to the wire during connection.
- Please use Ring Terminals with the size described below.
- To avoid a short among the ring terminals when the screws get loosen,

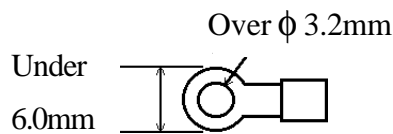

please use ring terminals with a sleeve.

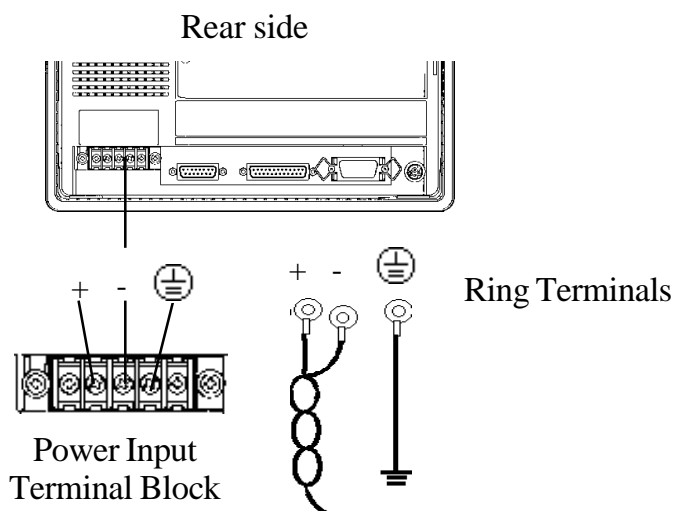

*1 Ring Terminal to use: V2-MS3 (made by JST)

Connect the power cable following the steps below.

1. Check to make sure the Power is Off.
2. With a plus screwdriver, remove the cover on the Power Input Terminal Block.
3. Disconnect the screws from the 3 terminals to be used, align the wire rings and re-insert the screws.

(Please make sure the connection of the wires are correct.)



- The torque necessary for fastening the screws is between 0.5-0.6N•m.

8 Precautions for Supplying Power

Please pay special attention to the following instructions when connecting the power cable to the GP unit.

- If the supply voltage exceeds the GP unit range, connect a voltage transformer.
- For between the line and ground, select a power supply that is low in noise. If there is an excess amount of noise, connect a noise reducing transformer.
- When supplying power to the GP unit, please separate the input/output and operation unit lines.
- To increase the noise quality, simply twist the power cable before connecting it to the GP unit.
- The power supply cable must not be bundled or kept close to main circuit lines (high voltage, high current), or input/output signal lines.
- Connect a surge absorber to deal with power surges.
- To reduce noise, make the power cable as short as possible.
- After turning this unit OFF, be sure to wait a few seconds before turning ON again. If the unit is started within a few seconds, it may not start up correctly.

9 Precaution for Grounding

- From the FG terminal at the rear side of GP unit, please take grounding exclusively [within ground resistance of 100 W].

10 Precautions for Input/Output Signal Lines

- Input and Output signal lines must be separated from the power control cables for operational circuits.
- If this is not possible, use a shielded cable and the shield should be grounded.