

# DATASHEET

**FUJI ELECTRIC**

2MBI200S-120-52

**OTHER SYMBOLS:**

2MBI200S12052, 2MBI200S120 52, 2MBI200S120-52, 2MBI200S 12052, 2MBI200S 120 52, 2MBI200S 120-52,  
2MBI200S-12052, 2MBI200S-120 52, 2MBI200S-120-52

**RGB ELEKTRONIKA AGACIAK CIACIEK  
SPÓŁKA JAWNA**

Jana Długosza 2-6 Street  
51-162 Wrocław  
Poland

✉ [biuro@rgbelektronika.pl](mailto:biuro@rgbelektronika.pl)

☎ +48 71 325 15 05



[www.rgbelektronika.pl](http://www.rgbelektronika.pl)



[www.rgbautomatyka.pl](http://www.rgbautomatyka.pl)

# YOUR PARTNER IN MAINTENANCE

Repair **this product** with RGB ELEKTRONIKA

[ORDER A DIAGNOSIS »](#)



At our premises in Wrocław, we have a fully equipped servicing facility. Here we perform all the repair works and test each later sold unit. Our trained employees, equipped with a wide variety of tools and having several testing stands at their disposal, are a guarantee of the highest quality service.

Buy **this product** at RGB AUTOMATYKA

[BUY »](#)

# DATASHEET

**FUJI ELECTRIC**

2MBI200S-120-52

**OTHER SYMBOLS:**

2MBI200S12052, 2MBI200S120 52, 2MBI200S120-52, 2MBI200S 12052, 2MBI200S 120 52, 2MBI200S 120-52,  
2MBI200S-12052, 2MBI200S-120 52, 2MBI200S-120-52

**RGB ELEKTRONIKA AGACIAK CIACIEK  
SPÓŁKA JAWNA**

Jana Długosza 2-6 Street  
51-162 Wrocław  
Poland

✉ [biuro@rgbelektronika.pl](mailto:biuro@rgbelektronika.pl)

☎ +48 71 325 15 05



[www.rgbelektronika.pl](http://www.rgbelektronika.pl)



[www.rgbautomatyka.pl](http://www.rgbautomatyka.pl)

# YOUR PARTNER IN MAINTENANCE

Repair **this product** with RGB ELEKTRONIKA

[ORDER A DIAGNOSIS »](#)



At our premises in Wrocław, we have a fully equipped servicing facility. Here we perform all the repair works and test each later sold unit. Our trained employees, equipped with a wide variety of tools and having several testing stands at their disposal, are a guarantee of the highest quality service.

Buy **this product** at RGB AUTOMATYKA

[BUY »](#)

# 2MBI200S-120

IGBT Module

## 1200V / 200A 2 in one-package

### ■ Features

- High speed switching
- Voltage drive
- Low inductance module structure

### ■ Applications

- Inverter for Motor drive
- AC and DC Servo drive amplifier
- Uninterruptible power supply
- Industrial machines, such as Welding machines

### ■ Maximum ratings and characteristics

#### ● Absolute maximum ratings (at Tc=25°C unless otherwise specified)

Item	Symbol	Rating	Unit	
Collector-Emitter voltage	V <sub>CEs</sub>	1200	V	
Gate-Emitter voltage	V <sub>GES</sub>	±20	V	
Collector current	Continuous	T <sub>c</sub> =25°C	300	A
		T <sub>c</sub> =80°C	200	A
	1ms	T <sub>c</sub> =25°C	600	A
		T <sub>c</sub> =80°C	400	A
	1ms	-I <sub>c</sub>	200	A
	-I <sub>c</sub> pulse	400	A	
Max. power dissipation	P <sub>c</sub>	1500	W	
Operating temperature	T <sub>j</sub>	+150	°C	
Storage temperature	T <sub>stg</sub>	-40 to +125	°C	
Isolation voltage *1	V <sub>is</sub>	AC 2500 (1min.)	V	
Screw torque	Mounting *2	3.5	N·m	
	Terminals *2	4.5	N·m	

\*1 : All terminals should be connected together when isolation test will be done

\*2 : Recommendable value : Mounting 2.5 to 3.5 N·m(M5 or M6)  
Terminals 3.5 to 4.5 N·m(M6)

#### ● Electrical characteristics (at T<sub>j</sub>=25°C unless otherwise specified)

Item	Symbol	Characteristics			Conditions	Unit	
		Min.	Typ.	Max.			
Zero gate voltage collector current	I <sub>CEs</sub>	–	–	1.0	V <sub>GE</sub> =0V, V <sub>CE</sub> =1200V	mA	
Gate-Emitter leakage current	I <sub>GES</sub>	–	–	0.4	V <sub>CE</sub> =0V, V <sub>GE</sub> =±20V	μA	
Gate-Emitter threshold voltage	V <sub>GE(th)</sub>	5.5	7.2	8.5	V <sub>CE</sub> =20V, I <sub>c</sub> =200mA	V	
Collector-Emitter saturation voltage	V <sub>CE(sat)</sub>	–	2.3	2.6	T <sub>c</sub> =25°C	V <sub>GE</sub> =15V, I <sub>c</sub> =200A	V
		–	2.8	–	T <sub>c</sub> =125°C		
Input capacitance	C <sub>ies</sub>	–	24000	–	V <sub>GE</sub> =0V	pF	
Output capacitance	C <sub>oes</sub>	–	5000	–	V <sub>CE</sub> =10V		
Reverse transfer capacitance	C <sub>res</sub>	–	4400	–	f=1MHz		
Turn-on time	t <sub>on</sub>	–	0.35	1.2	V <sub>CC</sub> =600V	μs	
	t <sub>r</sub>	–	0.25	0.6	I <sub>c</sub> =200A		
	t <sub>r(i)</sub>	–	0.1	–	V <sub>GE</sub> =±15V		
Turn-off time	t <sub>off</sub>	–	0.45	1.0	R <sub>G</sub> =4.7 ohm	μs	
	t <sub>f</sub>	–	0.08	0.3			
Forward on voltage	V <sub>F</sub>	–	2.3	3.0	T <sub>j</sub> =25°C	I <sub>F</sub> =200A, V <sub>GE</sub> =0V	V
		–	2.0	–	T <sub>j</sub> =125°C		
Reverse recovery time	t <sub>rr</sub>	–	–	0.35	I <sub>F</sub> =200A	μs	

#### ● Thermal resistance characteristics

Item	Symbol	Characteristics			Conditions	Unit
		Min.	Typ.	Max.		
Thermal resistance	R <sub>th(j-c)</sub>	–	–	0.085	IGBT	°C/W
	R <sub>th(j-c)</sub>	–	–	0.18	Diode	°C/W
	R <sub>th(c-f)*2</sub>	–	0.025	–	the base to cooling fin	°C/W

\*2 : This is the value which is defined mounting on the additional cooling fin with thermal compound

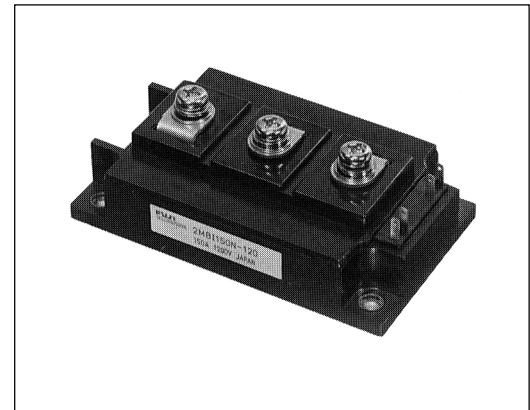

### ■ Equivalent Circuit Schematic

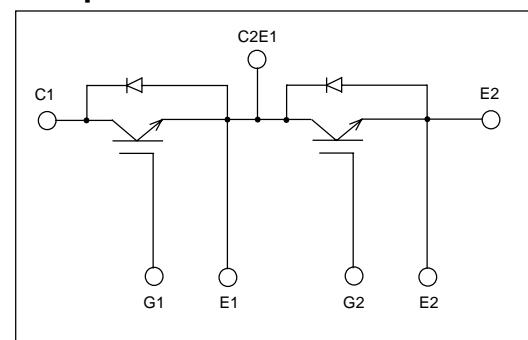

■ Characteristics (Representative)

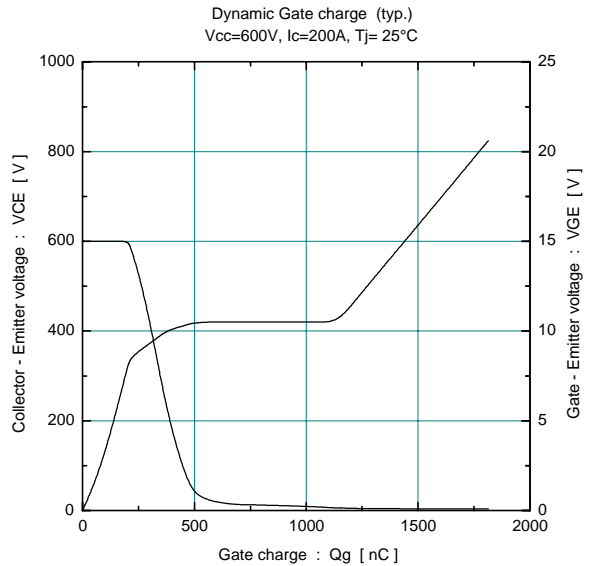
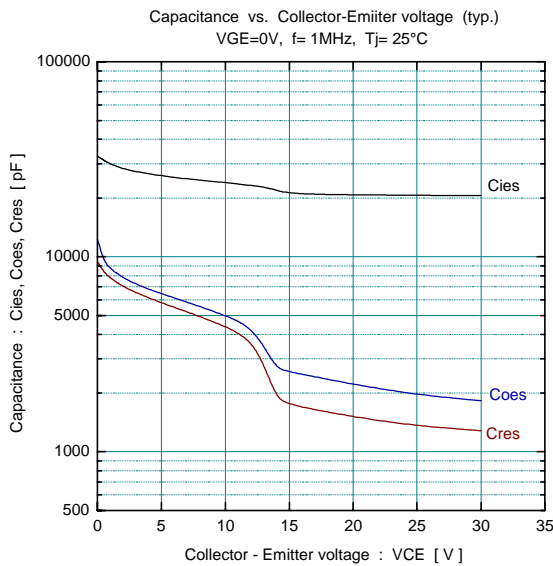
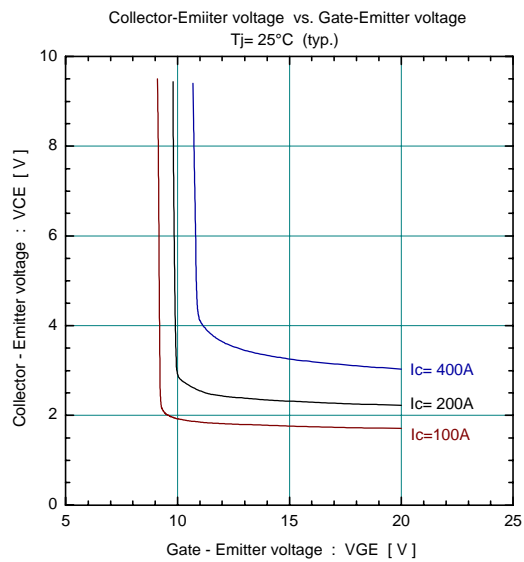
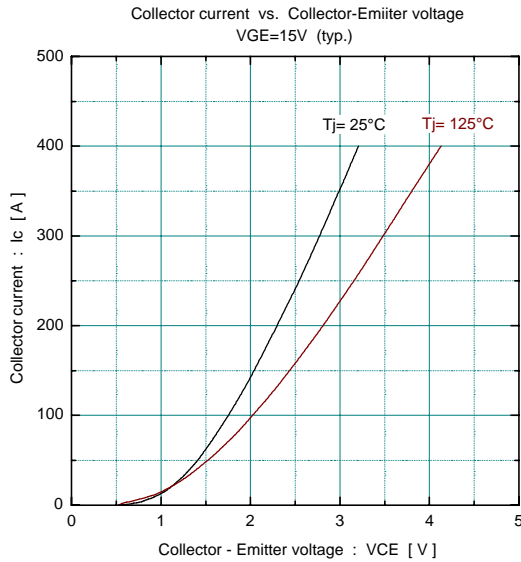
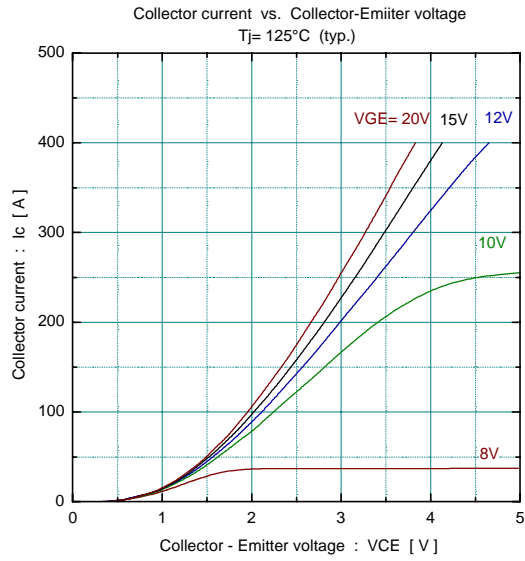
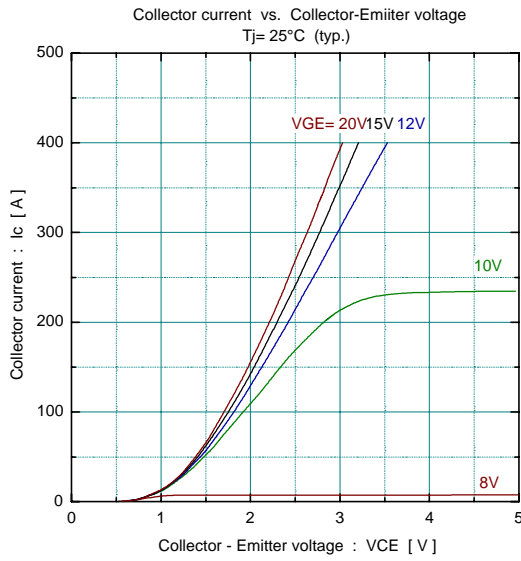

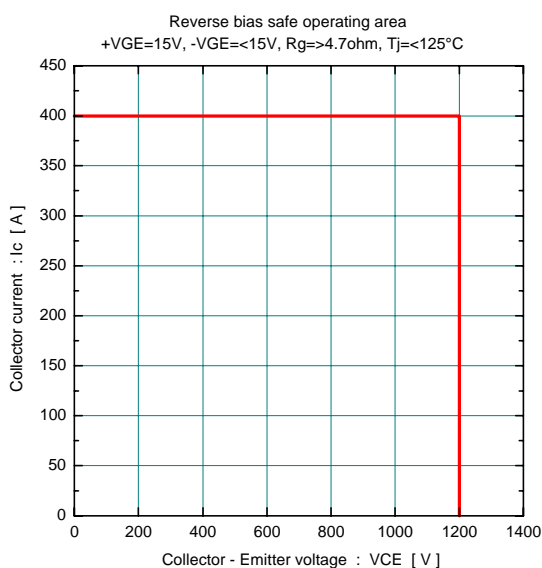
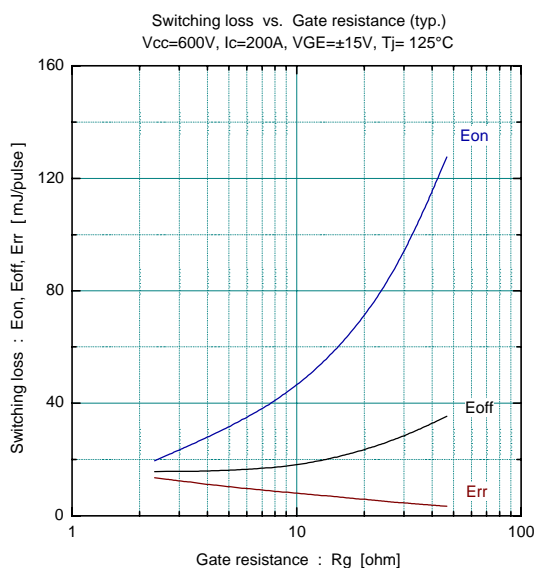
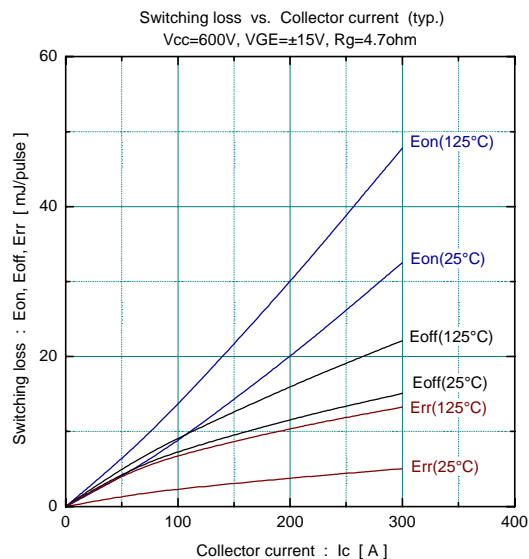
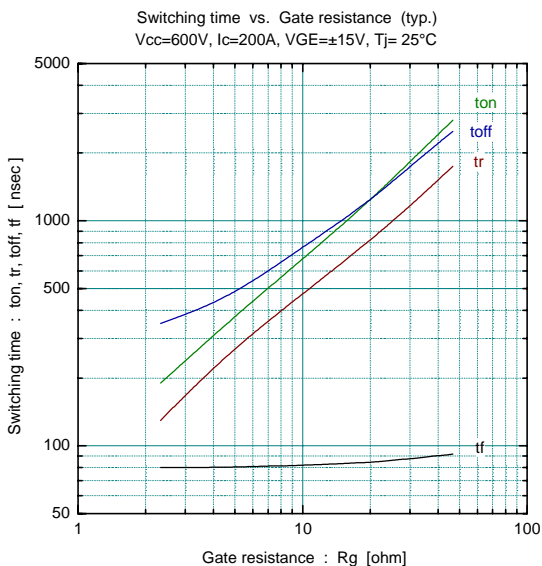
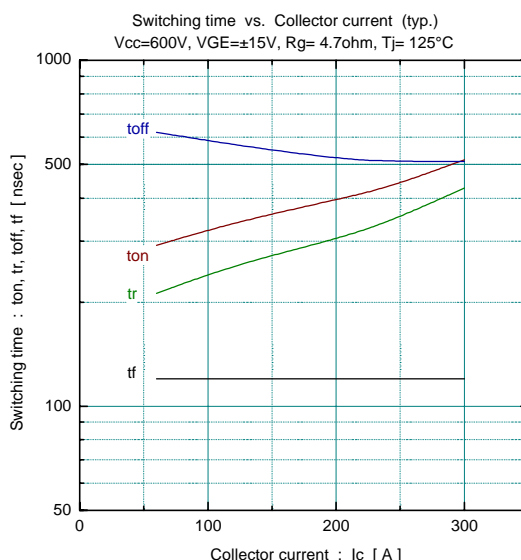
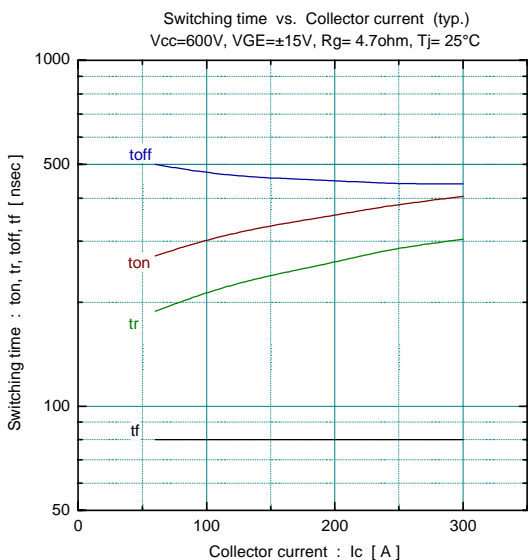

Forward current vs. Forward on voltage (typ.)

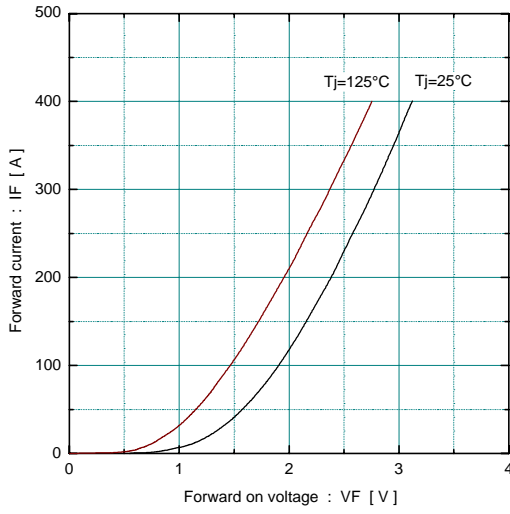

Reverse recovery characteristics (typ.)  
Vcc=600V, VGE=±15V, Rg=4.7ohm

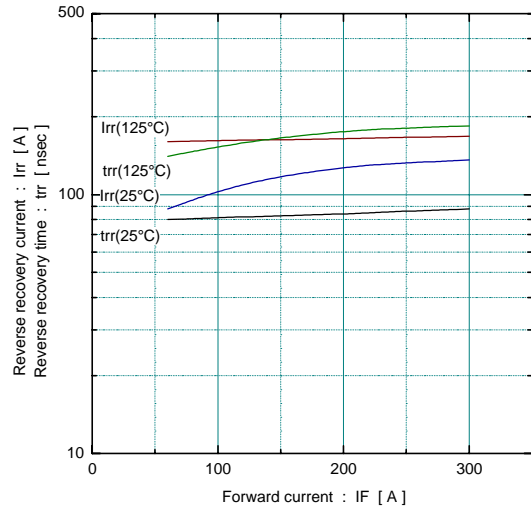

Transient thermal resistance

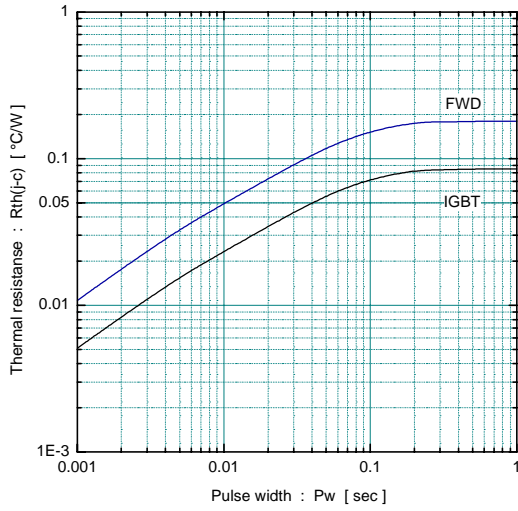

■ Outline Drawings, mm

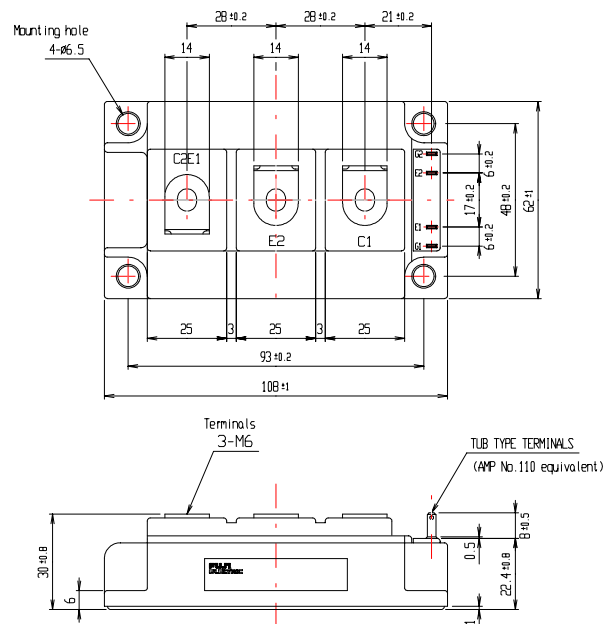

mass : 370g