

# SIEMENS

## SIMOVERT MASTERDRIVES

Betriebsanleitung  
Operating Instructions

### Bedienfeld OP1S Operator Panel OP1S

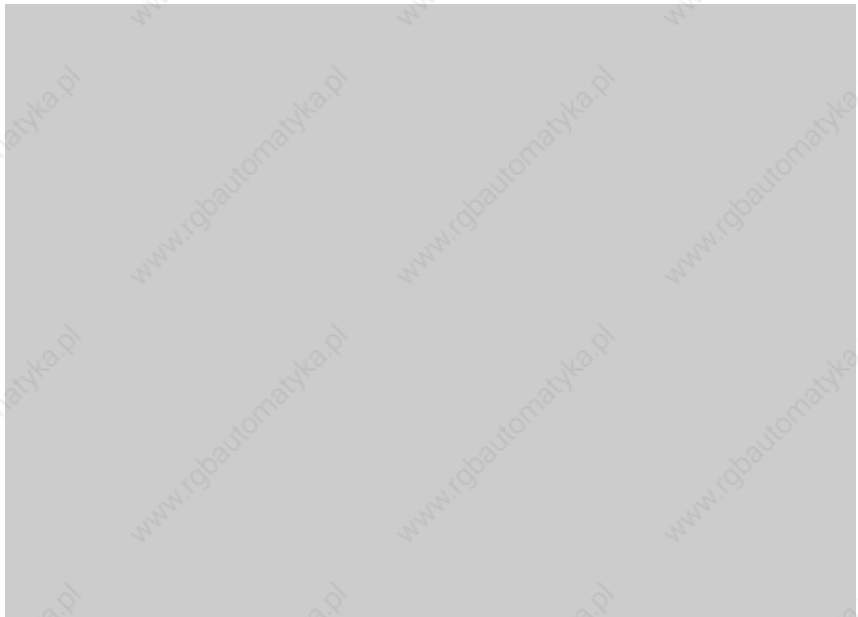

Ausgabe / Edition: AA

477 459 4070 76 J AA-74

# Contents

<b>1</b>	<b>General</b> .....	<b>1</b>
<b>2</b>	<b>Connecting, Run-up</b> .....	<b>3</b>
2.1	Connecting .....	3
2.2	Run-up.....	5
<b>3</b>	<b>Operator control</b> .....	<b>7</b>
3.1	Operator control elements .....	7
3.2	Operating display.....	8
3.3	Basic menu.....	9
3.4	Slave ID.....	10
3.5	OP: Upread.....	11
3.6	OP: Download.....	12
3.7	Delete data .....	13
3.8	Menu selection .....	14
3.8.1	Displaying and correcting parameters.....	15
3.8.2	Fault and alarm messages .....	20
3.9	Issuing commands via the OP1S .....	21
<b>4</b>	<b>Bus operation</b> .....	<b>22</b>
4.1	Configuring slaves .....	22
4.2	Change slave.....	23
<b>5</b>	<b>Technical data</b> .....	<b>24</b>

## Note

This operation manual of the OP1S is only valid for MASTER DRIVES units with the control boards CUVC and CUMC and for MASTER DRIVES Kompakt+ units.

The usage of the OP1S as spare part for the OP1 in conjunction with the control boards CU1 (FC), CU2 (VC) and CU3 (SC) is described in the operation manual of the OP1 with the order No. : 6SE7087-6CX84-2FF0.

# 1 General

The operator control panel (OP1S) is an optional input/output device which can be used for parameterizing and starting up the units. Plain-text displays greatly facilitate parameterization.

The OP1S has a non-volatile memory and can permanently store complete sets of parameters. It can therefore be used for archiving sets of parameters but, first, the parameter sets must be read out (upread) from the units. Stored parameter sets can also be transferred (downloaded) to other units.

The OP1S and the units to be operated communicate with each other via a serial interface (RS485) using the USS protocol. During communication, the OP1S assumes the function of a master whereas the connected units function as slaves.

The OP1S can be operated at baud rates of 9.6 kBd and 19.2 kBd and is capable of communicating with up to 32 slaves (addresses 0 to 31). It can therefore be used in a point-to-point link (e.g. during initial parameterization) or within a bus configuration.

The plain-text displays can be shown in one of five different languages (German, English, Spanish, French, Italian). The language is chosen by selecting the relevant parameter for the slave in question.

## Order numbers

Components	Order No.
OP1S	6SE7090-0XX84-2FK0
Connecting cable 3 m	6SX7010-0AB03
Connecting cable 5 m	6SX7010-0AB05
Adapter for installation in cabinet door, incl. 5 m cable	6SX7010-0AA00

---

## NOTE

The parameter settings for units connected to the OP1S are given in the corresponding documentation (Compendium).

---

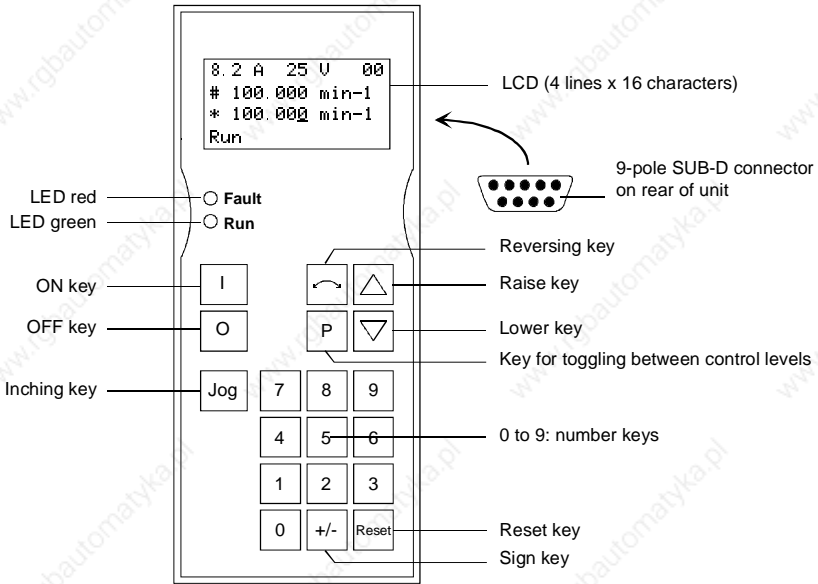
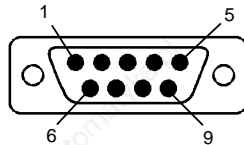

Fig. 1-1 View of the OP1S

**OP1S connection**



Pin	Designation	Meaning	Range
3	RS485 P	Data via RS485 interface	
5	M5V	Ground	
6	P5V	5 V aux. voltage supply	±5 %, 200 mA
8	RS485 N	Data via RS485 interface	
9		Reference potential	

Table 1-1 Connections of the OP1S

## 2 Connecting, Run-up

### 2.1 Connecting

The OP1S can be connected to the units in the following ways:

- ◆ Connection via 3 m or 5 m cable (e.g. as a manual input device for start-up)
- ◆ Connection via cable and adapter for installation in cabinet door
- ◆ Direct plugging into the units provided for it, e.g. MASTERDRIVE Compact units or the Compact PLUS MASTERDRIVE rectifier unit.

#### Connection via cable

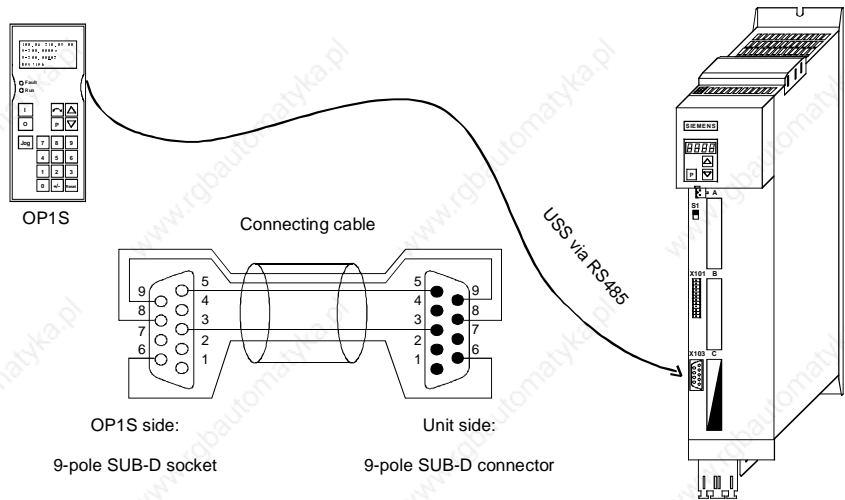

Fig. 2-1 Example: The OP1S in a point-to-point link with the Compact PLUS unit

## Plugging into the units provided

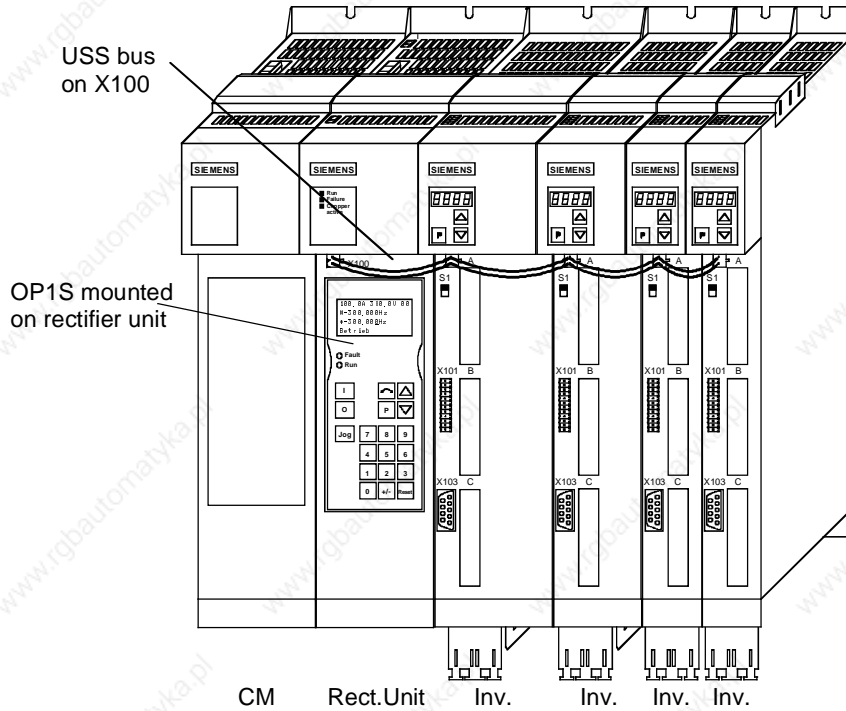

Fig. 2-2 Example: The OP1S during bus operation with Compact PLUS units

### NOTE

During bus operation, the Compact PLUS rectifier unit is only for mechanically restraining the OP1S and for connecting the bus to the inverters. It does not function as a slave.

## 2.2 Run-up

After the power supply for the unit connected to the OP1S has been turned on or after the OP1S has been plugged into a unit which is operating, there is a run-up phase.

**CAUTION**

The OP1S must not be plugged into the Sub-D socket if the SCom1 interface parallel to the socket is already being used elsewhere, e.g. bus operation with SIMATIC as the master.

**NOTE**

In the as-delivered state or after a reset of the parameters to the factory setting with the unit's own control panel, a point-to-point link can be adopted with the OP1S without any further preparatory measures.

When a bus system is started up with the OP1S, the slaves must first be configured individually. The plugs of the bus cable must be removed for this purpose (see section "Bus operation").

During the run-up phase, the text "Search slave" is shown in the first line of the display, followed by "Slave found" and the found slave number as well as the set baud rate.

```
Slave found
Address: [00]
Baud rate: [6]
```

Example of a display after the run-up phase (6 corresponds to 9.6 kBd)

After approximately 4 s, the display changes to

```
SIEMENS
MASTERDRIVES MC
6SE7014-0TP50
SW:V1.0 OP:V2T20
```

Example of what is displayed after a slave address has been found

After a further 2 s, there is a changeover to the operating display. If it is not possible to start communicating with the slave, an error message "Error: Configuration not ok" appears. About 2 s later, a request is made for new configuration.

New config?

#yes  
no

Error message displayed when  
communication not possible

If the "P" key is pressed, the connected unit is reconfigured, i.e. the interface parameters are set to the standard values.

Number of PKWs: 127

Number of PZDs: 2 or 4

Telegram failure time: 0 ms

If communication with the slave is still impossible, the reasons may be as follows:









- ◆ Defective cabling
- ◆ Bus operation with two or more slaves with the same bus address (see section "Bus operation").
- ◆ The baud rate set in the slave is neither 9.6 nor 19.2 kBd.

In the latter case, an error message appears: "Error: No Slave found". The unit's own control panel must then be used to set the baud rate to 9.6/19.2 kBd or to reset the parameters to the factory setting.



## 3 Operator control

### 3.1 Operator control elements

Key	Meaning	Function
	ON key	<ul style="list-style-type: none"> <li>For energizing the drive (enabling motor activation). This function must be enabled by means of parameterization.</li> </ul>
	OFF key	<ul style="list-style-type: none"> <li>For de-energizing the drive by means of OFF1, OFF2 or OFF3, depending on parameterization. This function must be enabled by means of parameterization.</li> </ul>
	Jog key	<ul style="list-style-type: none"> <li>For jogging with jog setpoint 1 (only effective when the unit is in the "ready to start" state). This function must be enabled by means of parameterization.</li> </ul>
	Reversing key	<ul style="list-style-type: none"> <li>For reversing the direction of rotation of the drive. This function must be enabled by means of parameterization.</li> </ul>
	Toggle key	<ul style="list-style-type: none"> <li>For selecting menu levels and switching between parameter number, parameter index and parameter value in the sequence indicated. The current level is displayed by the position of the cursor on the LCD display (the command comes into effect when the key is released).</li> <li>For concluding a numerical input</li> </ul>
	Reset key	<ul style="list-style-type: none"> <li>For leaving menu levels</li> <li>If fault display active, this is for acknowledging the fault. This function must be enabled by means of parameterization.</li> </ul>
	Raise key	<p>For increasing the displayed value</p> <ul style="list-style-type: none"> <li>Short press = single-step increase</li> <li>Long press = rapid increase</li> <li>If motor potentiometer is active, this is for raising the setpoint. This function must be enabled by means of parameterization.</li> </ul>
	Lower key	<p>For lowering the displayed value</p> <ul style="list-style-type: none"> <li>Short press = single-step decrease</li> <li>Long-press = rapid decrease</li> <li>If motor potentiometer is active, this is for lowering the setpoint. This function must be enabled by means of parameterization.</li> </ul>



Key	Meaning	Function
	Sign key	<ul style="list-style-type: none"> <li>For changing the sign so that negative values can be entered</li> </ul>
	Number keys	<ul style="list-style-type: none"> <li>Numerical input</li> </ul>

Table 3-1 Operator control elements of the OP1S

## 3.2 Operating display

After run-up of the OP1S, the following operating display appears.

0.0 A	0 V	00
#	0.00	min <sup>-1</sup>
*	0.00	min <sup>-1</sup>
Ready		

Example of an operating display in the "Ready" state

The values shown in the operating display (except for slave number, 1st line on the far right) can be specified by means of parameterization.

1st line left	in the example "Output current"
1st line right	in the example "DC link voltage"
2nd line actual value	in the example, "Actual speed" (only a visualization parameter)
3rd line setpoint	in the example "Speed setpoint"
4th line	in the example "Operating state"

In the operating display, the actual value is indicated with "#" and the setpoint with "\*".

In addition to the operating display on the display unit, the operating state is indicated by the red and green LEDs as follows:

	Flashing	Continuous
Red LED	Warning	Fault
Green LED	Ready	Operating

Table 3-2 Operating displays

### 3.3 Basic menu

When the "P" key is pressed, a changeover is made from the operating display to the basic menu.

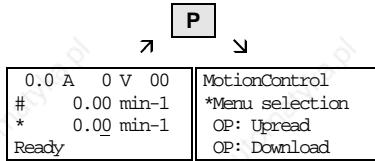

The basic menu is the same for all units. The following selections can be made:

- ◆ Menu selection
- ◆ OP: Upread
- ◆ OP: Download
- ◆ Delete data
- ◆ Change slave
- ◆ Config. slave
- ◆ Slave ID

As all the lines cannot be shown at the same time, it is possible to scroll the display as required with the "Lower" and "Raise" keys.

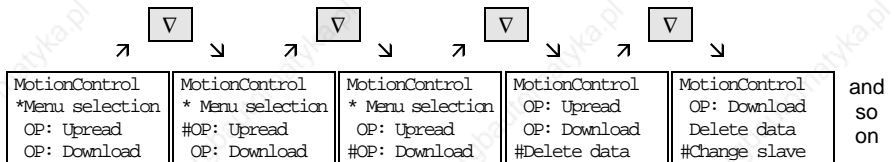

Example of switching from one line to the next

The currently active function is indicated by the "\*" symbol and the selected function by the "#" symbol. After the "P" key has been pressed, the relevant symbol jumps to the selected function. The "Reset" key is for returning to the operating display.



### 3.5 OP: Upread

With the "OP: Upread" function, the parameters of the connected slave can be upread and stored in the flash memory inside the OP1S. Parameters of a possibly inserted technology board are not taken into account (e.g. T100, T300). The SIMOVIS program is required here. Starting from the basic menu, the "OP: Upread" function is selected with "Lower" or "Raise" and started with "P". If the available memory is insufficient, the procedure is interrupted with an appropriate error message. During upread, the OP1S indicates the parameters currently being read. In addition, the slave number is shown at the top on the right-hand side.

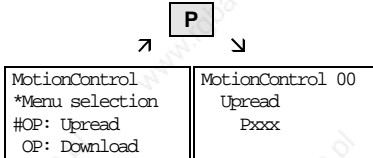

Example: Selecting and starting the "Upread" procedure

With "Reset", the procedure can be interrupted at any time. If the upread procedure has been completed in full, the user is requested to enter an ID, with a maximum of 12 characters, for the stored parameter set. This identification can, for example, consist of the date and two differentiating numbers. It is entered with the numerical keypad. With "Lower", a number which has been entered can be deleted.

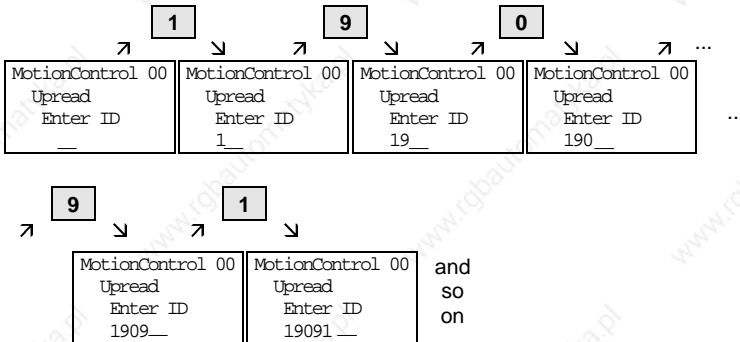

Example of an entry

When "P" is pressed, the message "Upread ok" appears and the display changes to the basic menu.

### 3.6 OP: Download

With the "OP: Download" function, a parameter set stored in the OP1S can be written into the connected slave. Parameters of a possibly inserted technology board are not taken into account (e.g. T100, T300). The SIMOVIS program is required here. Starting from the basic menu, the "OP: Download" function is selected with "Lower" or "Raise" and activated with "P".

	P
↗	↘
MotionControl *Menu selection OP: Upread #OP: Download	Download *1909199701 MASTERDRIVES MC PLUS

Example: Selecting and activating the "Download" function.

One of the parameter sets stored in the OP1S must now be selected with "Raise" or "Lower" (displayed in the second line). The selected ID is confirmed with "P". The slave ID can now be displayed with "Raise" or "Lower" (see section "Slave ID"). The "Download" procedure is then started with "P". During download, the OP1S displays the currently written parameters.

	P		P
↗	↘	↗	↘
Download *1909199701 MASTERDRIVES MC PLUS	Download 1909199701 MASTERDRIVES MC PLUS	MotionControl 00 Download Exxx	

Example: Confirming the ID and starting the "Download" procedure

With "Reset", the procedure can be stopped at any time. If downloading has been fully completed, the message "Download ok" appears and the display returns to the basic menu.

After the data set to be downloaded has been selected, if the identification of the stored data set does not agree with the identification of the connected unit, an error message appears for approximately 2 seconds. The operator is then asked if downloading is to be discontinued.

	P		P		2 s
↗	↘	↗	↘	↗	↘
Download *1909199701 MASTERDRIVES MC PLUS	Download 1909199701 MASTERDRIVES MC PLUS	Error: Different IDs	MotionControl 00 Stop download? #yes no		

- ◆ Yes: Downloading is discontinued.
- ◆ No: Downloading is carried out.

### 3.7 Delete data

With the "Delete data" function, the user can delete parameter sets stored in the OP1S, thus, for example, creating space for new sets of parameters. Starting from the basic menu, the "Delete data" function is selected with "Lower" or "Raise" and activated with "P".

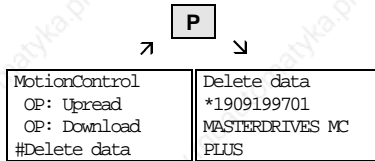

Example: Selection and activation of the "Delete data" function

One of the parameter sets stored in the OP1S must now be selected with "Lower" or "Raise" (displayed in the second line). With "P", the selected ID is confirmed. The slave ID can now be displayed with "Lower" or "Raise" (see section "Slave ID"). The "Delete data" procedure can then be started with "P". After completion, the message "Data deleted" appears and the display returns to the basic menu.

### 3.8 Menu selection

Actual parameterization and start-up of the connected slave is performed by means of the "Menu selection" function. Starting from the basic menu, the "Menu selection" function is selected with "Lower" or "Raise". By pressing "P", the unit-specific sub-menu is displayed with the following choices:

- ◆ User Param.
- ◆ Param Menu...
- ◆ FixedSet...
- ◆ Quick Param....
- ◆ Board Conf.
- ◆ Drive Set.
- ◆ Download
- ◆ UpR/fr. Access
- ◆ Power Def.

Two or more points after these items means that there is a further sub-menu level. If "Parameter menu.." is selected, access is possible to all parameters via correspondingly structured sub-menus. If "UpR/fr.access" is selected, direct access is gained to the parameter level.

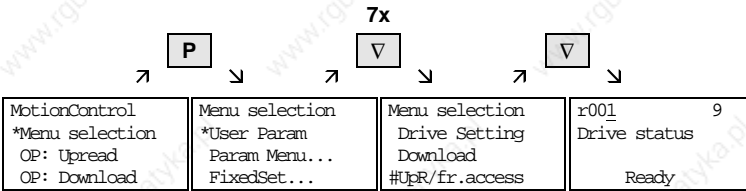

Example: Selecting the parameter level by means of UpR/fr.access

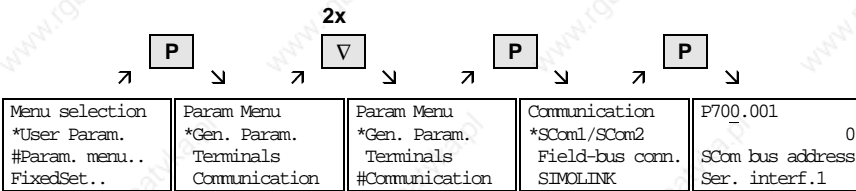

Example: Selecting a parameter by means of sub-menus



### 3.8.1 Displaying and correcting parameters

A parameter number can be selected from the parameter level directly with the numerical keys or with "Raise"/"Lower". The parameter number is shown as a three-figure quantity. In the event of four-figure parameter numbers, the first figure (1, 2 or 3) is not displayed. A distinction is made with the letters (P, H, U etc.).

↗ <b>0</b> ↘	↗ <b>4</b> ↘	↗ <b>9</b> ↘	
r001 9 Drive status Ready	r000	r004	r049.001 4 OP OperDisp 1st line, on left

Example: Direct input of the parameter number with the numerical keypad

↗ <b>Δ</b> ↘	↗ <b>Δ</b> ↘	↗ <b>Δ</b> ↘	
r001 9 Drive status Ready	r002 0 min-1 Actual speed	r004 0.0 A Output Amps	r006 0 V DC Bus Volts

Example: Correcting the parameter number by means of "Raise"

If the parameter is found not to exist when the number is entered, a message "No PNU" appears. A non-existent parameter number can be skipped by selecting "Raise" or "Lower".

How the parameters are shown on the display depends on the type of parameter. There are, for example, parameters with and without an index, with and without an index text and with and without a selection text.

P704.001 0 ms SCcm TlgOFF Ser. interf.1
--

Example: Parameter with index and index text

- 1st line: Parameter number, parameter index
- 2nd line: Parameter value with unit
- 3rd line: Parameter name
- 4th line: Index text

P701.001	6
SCom baud rate	
Ser.interf.1	
9600 baud	

Example: Parameter with index, index text and selection text

1st line: Parameter number, parameter index, parameter value

2nd line: Parameter name

3rd line: Index text

4th line: Selection text

P053	0006Hex
Parameter Access	
0000000000000110	
ComBoard: No	

Example: Parameter without index, with selection text, binary value

1st line: Parameter number, hexadecimal parameter value

2nd line: Parameter name

3rd line: Parameter value, binary

4th line: Selection text

The "P" key is used to move between the levels parameter number, parameter index and parameter value.

Parameter number → "P" → Parameter index → "P" → Parameter value

If there is no parameter index, this level is skipped. The parameter index and parameter value can be corrected directly with the numerical keys or with the "Raise"/"Lower" keys. An exception to this are parameter values shown in binary form. In this case, the individual bits are selected with "Raise"/"Lower" and corrected with the numerical keys (0 or 1).

If the index number is entered by means of the numerical keys, the value is not accepted until "P" is pressed. If the "Raise" or "Lower" keys are used to correct the number, the value comes into effect immediately. The acceptance of an entered parameter value and return to the parameter number does not take place until "P" is pressed. The level selected in each case (parameter number, parameter index, parameter value) is marked with the cursor. If an incorrect parameter value is entered, the old value can be obtained by pressing "Reset". The "Reset" key can also be used to go one level lower.

Parameter value → "Reset" → Parameter index → "Reset" → Para. No.

Parameters which can be altered are shown in upper-case letters and those which cannot be altered in lower-case letters. If a parameter can only be changed under special conditions or if an incorrect value has been entered with the numerical keys, an appropriate message follows, e.g.:

"Value not perm."	Incorrect value entered
"Value <> min/max"	Value too large or too small
"P53/P927?"	No parameter access
"Operating status?"	Value can only be changed in "Drive setting" status, for example

With "Reset", the message is deleted and the old value is re-instated.

---

NOTE	Parameter changes are always stored with power-failure protection in the EEPROM of the unit connected to the OP1S.
------	--

---

**Examples of parameter correction**

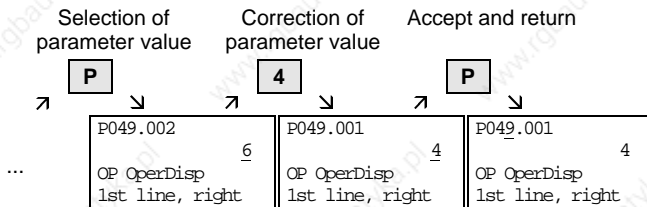
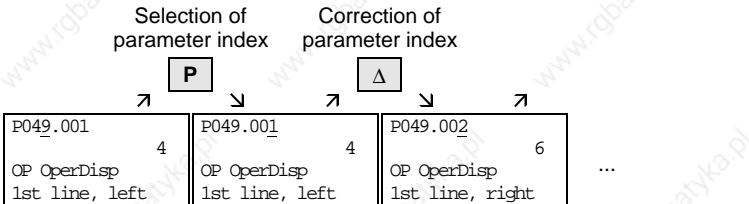
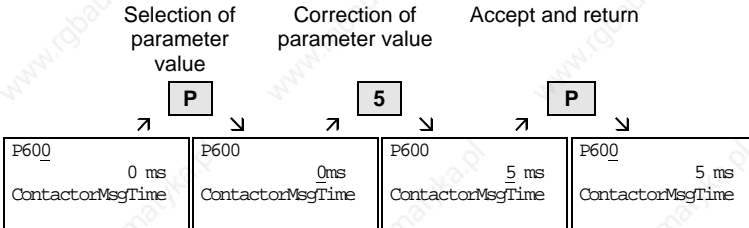
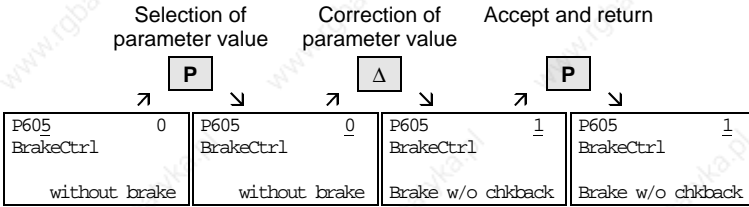

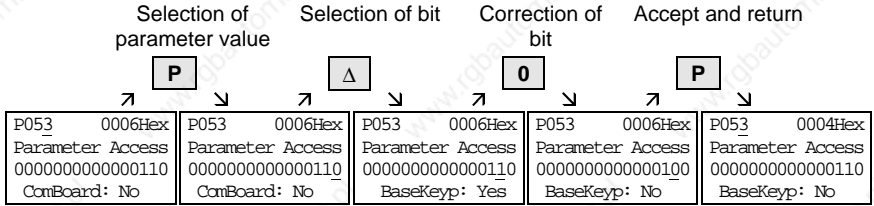

Parameters may also be displayed without a parameter number, for example during quick parameterizing or if "Fixed setting" is selected. In this case, parameterization is carried out via various sub-menus.

Example of how to proceed for a parameter reset

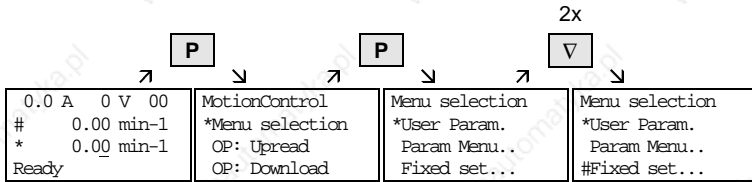

Selection of fixed setting

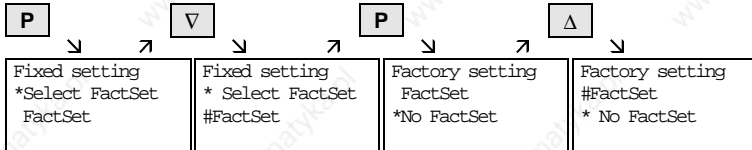

Selection of factory setting

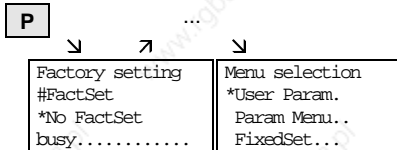

Start of factory setting

**NOTE** It is not possible to start the parameter reset in the "RUN" state.

### 3.8.2 Fault and alarm messages

A fault or alarm message is indicated by the red LED. In the event of a fault, the red LED lights up and stays on. A fault message appears in the 3rd and 4th line of the operating display.



0.0 A 0 V 00	0.0 A 0 V 00
# 0.00 min-1	# 0.00 min-1
F065: SST1 Telg	1T 3h 2"
Fault 1/1	Fault 1/1

Example of a fault display

The fault number and the respective text are shown in the 3rd line. Up to 8 fault messages can be stored but only the first fault to occur is shown on the display. Several subsequent faults are shown in the 4th line, e.g. with 1/3 (first of three). Information on all faults can be obtained from the fault memory. With "Raise"/"Lower", the associated operating hours are shown when a fault is waiting to be remedied.

After the cause of a fault has been removed, the fault is acknowledged with "Reset" inside the operating display (the "Reset" key must be appropriately parameterized. See section "Issuing commands via the OP1S"). By pressing "P" and "Lower" at the same time, it is possible to skip back directly to the operating display from the parameter level.

When there is an alarm, the red LED flashes. A warning appears in the 4th line of the operating display.

8.2 A 520 V 00
# 100.00 min-1
* 100.00 min-1
-33:overspeed











Example of an alarm display

The alarm number and the respective text is shown in the 4th line. There can be several alarms at the same time but only the first alarm to occur is shown on the display. Several alarms are shown in the 4th line before the alarm number with a "+" instead of "-". Information on all alarms can be obtained with the alarm parameters.

An alarm cannot be acknowledged. As soon as the cause no longer exists, the alarm/display disappears automatically.

### 3.9 Issuing commands via the OP1S

Control functions and setpoint specifications for the connected unit can be selected with the corresponding keys of the OP1S, for example during start-up. To do so, the sources of the control commands have to be added to the corresponding bits of word 1 of the SCom1 interface. For setpoint specification, the sources of the setpoints must be appropriately "interconnected". In addition, the setpoint to be changed is to be parameterized as a displayed value in the 3rd line of the operating display.

Key	Function
 	ON / OFF1
 	Motor potentiometer: setpoint higher, lower (only effective within the operating display)
 bis  or  	Setpoint specification by means of fixed setpoint (only effective within the operating display. If entered with numerical key, confirm with "P")
	Reversing
	Acknowledging (only effective within the operating display)
	Jogging with jog setpoint 1 (only effective in the "Ready" state)

#### NOTE

The OFF function can also be performed with OFF2 or OFF3 instead of OFF1. For this, the source of OFF2 or OFF3 must be appropriately "interconnected" in addition to setting ON/OFF1.

## 4 Bus operation

In order to start operating a bus system with the OP1S, the slaves must first be configured individually. To do this, the bus connecting cable between the slaves must be interrupted (pull out the bus-cable plug). For configuration, the OP1S is connected with each slave one after the other. A precondition for carrying out the configuration is a baud rate of 9.6 or 19.2 kBd set in the slave (see section "Run-up").

### 4.1 Configuring slaves

Starting from the basic menu, the "Config. slave" function is selected with "Lower"/"Raise" and activated with "P". The user is now requested to enter a slave address.

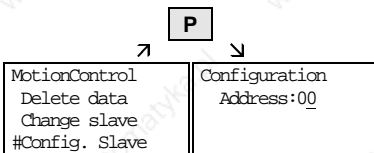

Example of activating the "Config. slave" function

After a different slave address for each slave has been entered by means of the "Raise" key or with the numerical keypad and confirmed with "P", configuration is carried out, i.e. the interface parameters are set to the standard value (see section "Run-up"). In addition, the slave address is entered and a baud rate of 9.6 kBd is set in the slave. After configuration has been completed, the message "Configuration ok" appears, followed by a return to the basic menu. If the configuration of all slaves has been successfully completed, bus operation can be started after the bus connection between the slaves has been restored.

---

**NOTE** During bus operation, each slave must have a different address. Bus operation is also possible at 19.6 kBd. The baud rate, however, must be set the same in all slaves.

---



## 4.2 Change slave

During bus operation, a specific slave can be selected via the OP1S with the "Change slave" function without any re-plugging. Starting from the basic menu, the "Change slave" function is selected with the "Lower"/"Raise" key and activated with "P". The user is then requested to enter a slave address.

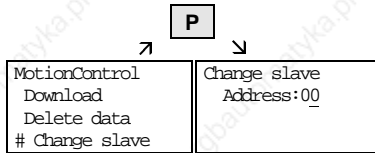

Example of activating the "Change slave" function

After the slave address has been entered with "Raise"/"Lower" and confirmed with "P", a change is made to the required slave and the display returns to the basic menu. If the slave cannot be found, an error message is output.

## 5 Technical data

Order number	6SE7090-0XX84-2FK0
Supply voltage	5 V DC $\pm$ 5%, 200 mA
Operating temperature	0 °C to +55 °C
Storage temperature	-25 °C to +70 °C
Transport temperature	-25 °C to +70 °C
Environment class	Acc. to DIN IEC 721 Part 3-3/04.90
<ul style="list-style-type: none"> <li>• Humidity</li> <li>• Pollution resistance</li> </ul>	3K3 3C3
Protection class	II acc. to DIN VDE 0160 Part 1/05.82 IEC 536/1976
Degree of protection	Acc. to DIN VDE 0470 Part 1/11.92
<ul style="list-style-type: none"> <li>• Front</li> <li>• Rear</li> </ul>	IP54    EN60529 IP21
Dimensions W x H x D	74 x 174 x 26 mm
Standards	VDE 0160/E04.91 VDE 0558 Part 1/07.87 UL, CSA
Battery life	> 5a at 20°C

Table 5-1    Technical data

Bisher sind folgende Ausgaben erschienen:  
The following versions have appeared so far:

<b>Ausgabe Version</b>	<b>interne Sachnummer Internal item number</b>
AA	477 459.4070.76 J AA-74

Ausgabe AA besteht aus folgenden Kapiteln

<b>Kapitel</b>		<b>Änderung</b>	<b>Ausgabe- datum</b>
1	Allgemeines	Erstausgabe	10.97
2	Anschließen, Hochlauf	Erstausgabe	10.97
3	Bedienen	Erstausgabe	10.97
4	Busbetrieb	Erstausgabe	10.97
5	Technische Daten	Erstausgabe	10.97

Version AA consists of the following chapters

<b>Chapter</b>		<b>Changes</b>	<b>Version date</b>
1	General	First edition	10.97
2	Connecting, Run-up	First edition	10.97
3	Operator control	First edition	10.97
4	Bus operation	First edition	10.97
5	Technical data	First edition	10.97

Automation and Drives  
Drehzahlveränderbare Antriebe  
Postfach 3269, D-91050 Erlangen

---

Siemens Aktiengesellschaft    Subject to change without notice    Printed in the federal Republic of Germany  
0698