



NUM
1020/1040/1050/1060
M and W
OPERATOR
MANUAL

0101938821/2

Despite the care taken in the preparation of this document, NUM cannot guarantee the accuracy of the information it contains and cannot be held responsible for any errors therein, nor for any damage which might result from the use or application of the document.

The physical, technical and functional characteristics of the hardware and software products and the services described in this document are subject to modification and cannot under any circumstances be regarded as contractual.

The programming examples described in this manual are intended for guidance only. They must be specially adapted before they can be used in programs with an industrial application, according to the automated system used and the safety levels required.

© Copyright NUM 1998.

All rights reserved. No part of this manual may be copied or reproduced in any form or by any means whatsoever, including photographic or magnetic processes. The transcription on an electronic machine of all or part of the contents is forbidden.

© Copyright NUM 1998 NUM 1000 range software.

This software is the property of NUM. Each memorized copy of this software sold confers upon the purchaser a non-exclusive licence strictly limited to the use of the said copy. No copy or other form of duplication of this product is authorized.



COMMISSIONING AND WARRANTY CARD

The products whose part numbers are given below are covered by the "parts" warranty provided for by the generation conditions of sale subject to return of this warranty card, duly filled in, to the NUM SA Service Centre (by mail or fax) within one week at most after commissioning in the end user's plant.

NUM S.A.
Service Clients
21, Avenue du Maréchal Foch
BP 68 - 95101 Argenteuil Cedex

Tel: 33(0)1.34.23.66.66
Telex: 609 611 F
Fax: 33(0)1.39.47.25.19

MANUFACTURER	
MACHINE	
CNC TYPE	
JOB REFERENCE	
DATE OF COMMISSIONING (see note)	
USER Name Address Phone Fax	

Fill in the table below only for NUM supplies.

Item	Part Number	Serial Number
Spindle servo-drive		
Spindle motor		
Axis servo-drive		
Axis motor		
Axis servo-drive		
Axis motor		
Axis servo-drive		
Axis motor		

NOTE: The date of commissioning corresponds to the date of installation in the user's plant, which is not necessarily the date of acceptance of the machine.



Table of Contents

1 Review			1 - 1
	1.1	System Overview	1 - 3
	1.2	Machine Overview	1 - 5
2 Product Presentation			2 - 1
	2.1	Environment	2 - 3
	2.2	Switching on/off	2 - 6
	2.3	System Identification	2 - 7
3 Operator Panel Description			3 - 1
	3.1	NUM Panel and Sub-Assemblies	3 - 3
	3.2	Interactions Between Mode Selections and Display Pages	3 - 12
	3.3	Available Controls and Indicators	3 - 13
	3.4	Special Keyboard Operations	3 - 20
	3.5	Use of a 102/105-Key Keyboard with the Compact Panel	3 - 24
4 Display System Utilization			4 - 1
	4.1	Inch/Metric Unit Conventions	4 - 3
	4.2	Display of Tool Position	4 - 3
	4.3	Display of Shifts	4 - 5
	4.4	Display of Tool Data and Tool Corrections	4 - 6
	4.5	Display of Programmes	4 - 8
	4.6	Display of a Programme in Graphic Mode	4 - 12
	4.7	Display of Active Data	4 - 33
	4.8	Display of Programme-Being Executed	4 - 35
	4.9	Display of Programme Variables and Equivalent Address Table	4 - 37
	4.10	Display of Inputs/Outputs	4 - 39
	4.11	Access to Maintenance Functions	4 - 47
5 CNC Operation			5 - 1
	5.1	Preliminary Operations	5 - 5
	5.2	Preparation for Machining	5 - 10
	5.3	Manual Data Input	5 - 24
	5.4	Automatic Programme Execution	5 - 25
	5.5	Operator Interventions	5 - 49
	5.6	CNC Information Archiving	5 - 62
	5.7	Creation of a Part Programme	5 - 66
	5.8	Inch/Metric Unit Selection	5 - 69
	5.9	Part Programme Operations in Background Mode	5 - 71

6 Operational Problems

		6 - 1
6.1	Indicator "FDHLD" Displayed	6 - 5
6.2	No Movement in Manual Mode	6 - 6
6.3	No Movement in Automatic Mode	6 - 8
6.4	No Cycle Start	6 - 11
6.5	No Block Sequencing	6 - 12
6.6	Faults Detected by the System	6 - 17
6.7	Data Modification	6 - 17
6.8	Failure on Analogue Input/Output Cards	6 - 17
6.9	Power Failures	6 - 18

7 System Faults

		7 - 1
7.1	Hardware Fault	7 - 5
7.2	Customisation Error	7 - 5
7.3	Temporary Customisation	7 - 6
7.4	Customisation Overrun	7 - 6
7.5	Sampling Period Too Small	7 - 7
7.6	Parameter Table Not Conforming to Software Version	7 - 8
7.7	A Declared Axis Missing	7 - 9
7.8	Not Enough Memory to Execute the Pocket Module	7 - 10
7.9	Wrong Number of PLC Axes	7 - 10
7.10	Incorrect Sampling Period with UC SII CPU	7 - 11
7.11	Sensor Declared Connected Several Times to the QVN Card	7 - 11
7.12	Incoherent QVN Sensor Address	7 - 12
7.13	Sensor Declared on QVN Card but Detected on an Axis Card	7 - 12
7.14	Undeclared Speed Sensor Connected to the QVN Card	7 - 13
7.15	Speed Sensor Declared Several Times	7 - 13
7.16	Speed and Position Sensor Declared on Several Axes	7 - 14
7.17	Position Sensor Not Found on Axis Card and Not Declared as QVN Sensor	7 - 14
7.18	Several Axis Drive Sensors Have the Same Address	7 - 15
7.19	List of Drives Different from the List of QVN Axes	7 - 15
7.20	QVN Axes Missing	7 - 16
7.21	Missing QVN Measured-Only Axes	7 - 16
7.22	Sampling Period Not Within the Authorised Values	7 - 17
7.23	Editing Parameter P98	7 - 17

8 Operator-Accessible Maintenance		8 - 1
8.1	Hardware Maintenance	8 - 3
8.2	Accessing the Utilities	8 - 10
8.3	Serial Line Parameters	8 - 12
8.4	Customising the Colour Palette	8 - 16
8.5	Backing up Machine Data	8 - 19
8.6	Setting the Date and Time	8 - 22
8.7	Battery Management Update	8 - 24
8.8	Protected Memory Area Management	8 - 25
8.9	Customisation of the System	8 - 50
Appendix A Function Summary Tables		A - 1
A.1	ISO Programming Syntax	A - 3
A.2	Parametric Programming Syntax	A - 19
A.3	Profile Geometry Programming (PGP) Syntax	A - 26
Appendix B List of Errors		D - 1
B.1	Miscellaneous Errors and Machine Errors	B - 3
B.2	Parametric Programming Errors	B - 4
B.3	Profile Geometry Programming (PGP) Errors	B - 5
B.4	Miscellaneous Errors	B - 6
B.5	Request for Movements Outside the Machine Travel Limits	B - 6
B.6	Structured Programming Errors	B - 7
B.7	Axis Errors	B - 7
B.8	Errors in Pocket Cycles	B - 8
B.9	Axes Not Identified on the Bus	B - 8
B.10	Dynamic Operators in C	B - 9
B.11	Spline Curve Interpolation Errors	B - 9
B.12	Errors in Numform	B - 9
B.13	Cycle Programming Errors	B - 10
Appendix C Use of Peripherals		C - 1
C.1	CNC / Peripheral Interconnection	C - 3
C.2	Connection to a Peripheral Device	C - 21
C.3	Connection to a Computer	C - 27
Appendix D Information Concerning the Exchange Area Bit		D - 1

Record of Revisions

Date	Index	Documents revisions
07-92	0	Document creation (conforming to software at index C)
11-94	1	Revised to conform to software at index G
08-98	2	Revised to conform to software at index L

NUM 1020/1040/1050/1060 Documentation Structure

User Documents

These documents are designed for use of the CNC.

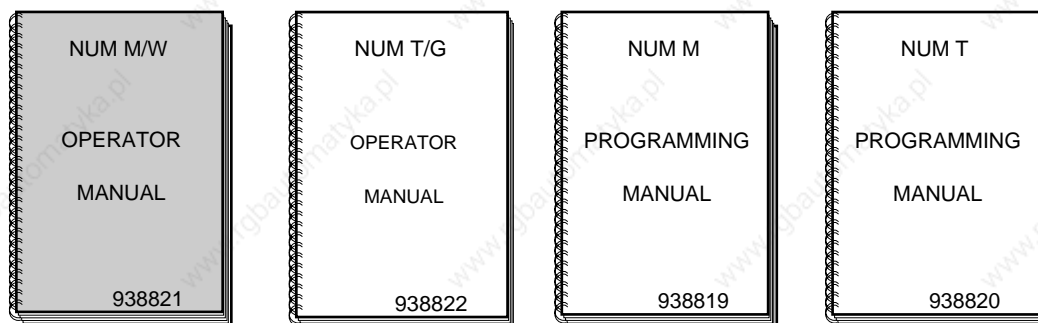

Integrator Documents

These documents are designed for setting up the CNC on a machine.

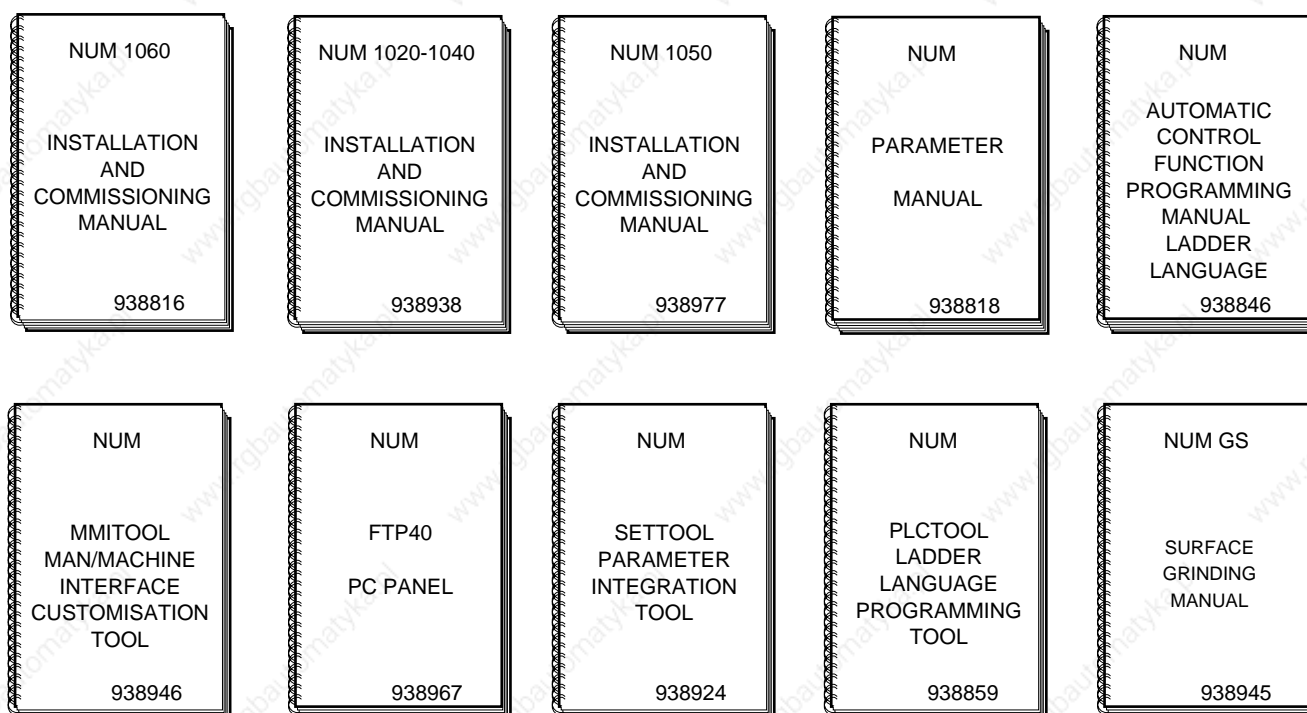

List of NUM Utilities

A series of utilities are available for products of the NUM 10xx range for integration and use of the system.

These utilities may be included in the basic version or available as options.

Depending on the function performed by each utility, its use is described in the integration manual or operator manual, as appropriate.

The table below lists the utilities and gives the references of the document describing them:

Utility	Name	Manual
UT2	axis calibration	installation and commissioning manuals
UT3	resident macros	operator manuals
UT5	parameter integration	parameter manual
UT7	programme debugging	machine processor programming manual - ladder language
UT12	option locking	operator manuals
UT20	interaxis calibration	installation and commissioning manual
UT22	parameter integration	SETTOOL manual

Operator Manual

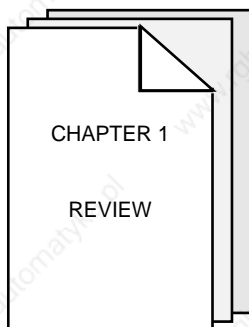

Presentation of the CNC and its role in relation to the machine tool.

Reminder of the rules and standards associated with CNC and machines.

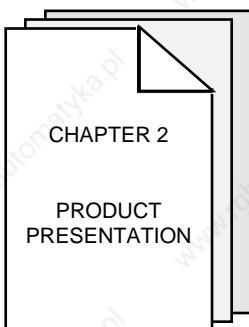

Overview of the relationship between the CNC and its environment.

Procedures for switching on and re-starting following an emergency stop.

Access to information about the system (job reference, customisation, etc.).

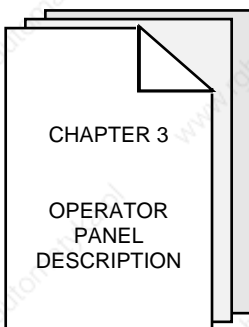

Detailed presentation of the operator panel and screen.

Use of special keyboard functions.

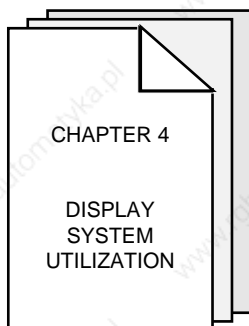

Detailed presentation of the CNC display pages.

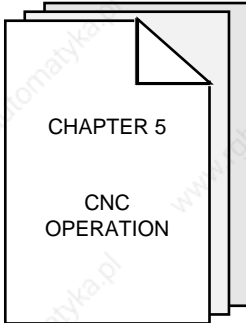

Description of machining preparation phases:

- axis jogs,
- machine-specific settings on the CNC,
- part programme processing.

Part programme automatic execution procedures.

Description of operator interventions during part machining.

Operations in background mode on part programmes.

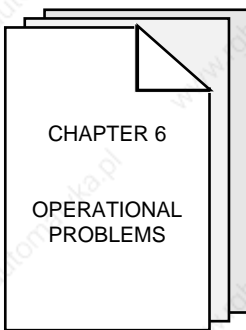

Presentation of the incidents which occur most frequently on the CNC and flowcharts indicating the most suitable action to be taken in each case.

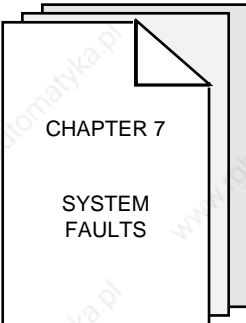

Presentation of the system faults which can occur on power up and action to be taken.

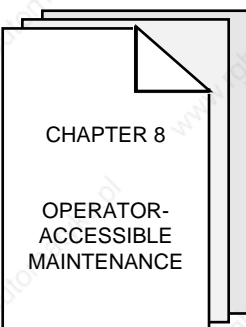

Description of simple maintenance operations.

Presentation of user-accessible system management utilities.

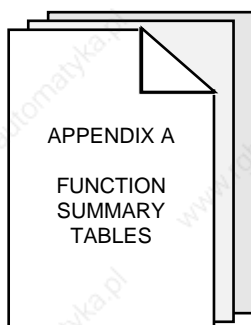

Introduction to part programming and tables summarising the programming functions (all these notions are explained in detail in the Programming Manual).

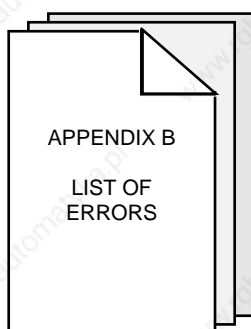

List of CNC error numbers and descriptions.

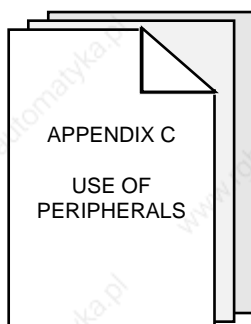

Presentation of peripheral commissioning operations prior to data exchanges.

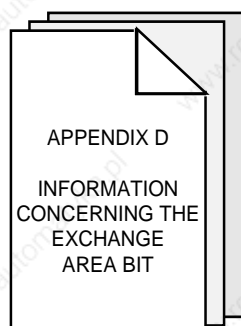

Addresses of the exchange area bits mentioned in this manual.

Using the Operator Manual

Procedures

This manual includes procedures.

The actions required are presented as follows:

Reset the system.



The keys to be pressed are indicated on the right. They can have two forms:



Square keys: correspond to keys on the operator panel.



Rectangular keys: correspond to softkeys located in the block at the bottom of the screen and activated by function keys (F2-F11) located under the screen.

Dealers

The list of NUM dealers is given at the end of the manual.

Questionnaire

To help us improve the quality of our documentation, we ask you to return the questionnaire at the end of this manual.

1 Review

1.1 System Overview		1 - 3
	1.1.1 Overview of Modes	1 - 3
	1.1.2 Defining a Programme	1 - 3
	1.1.3 Preparing a Programme	1 - 4
1.2 Machine Overview		1 - 5
	1.2.1 Review of Axis Definition and Direction	1 - 5
	1.2.2 Machine Overview	1 - 6
	1.2.3 Definition of Travels and Origins	1 - 7
	1.2.4 Definition of Shifts	1 - 9
	1.2.5 Definition of Tool Dimensions	1 - 14
	1.2.6 Definition of Tool Wear Offsets	1 - 15

This chapter does not aim to reflect the way an operator actually uses his machine. Rather, it attempts to explain certain basic notions which will be referred to in this manual.

For example, in paragraph 1.2.4 (definition of shifts), the aim is not to impose a method of measuring shifts, but simply to provide a definition of shifts and the corresponding zero points.

1.1 System Overview

1.1.1 Overview of Modes

The operator uses the numerical control (NC) in various operating modes accessible from the operator panel.

Each mode corresponds to a particular use of the numerical control (continuous machining, programme loading, tool setting, etc.).

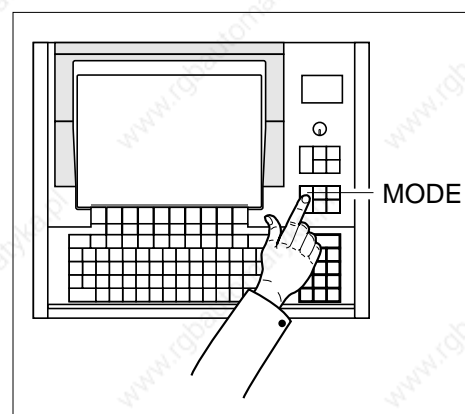

1.1.2 Defining a Programme

A programme is a sequence of instructions written in a programming language specific to the numerical control (the most widely used is ISO code: International Standards Organization).

The numerical control interprets the programme to control actions on a machine-tool.

The most widespread storage media for programmes are punched tape and diskettes.

1.1.3 Preparing a Programme

A part programme can be created by traditional programming or using a CAD/CAM system.

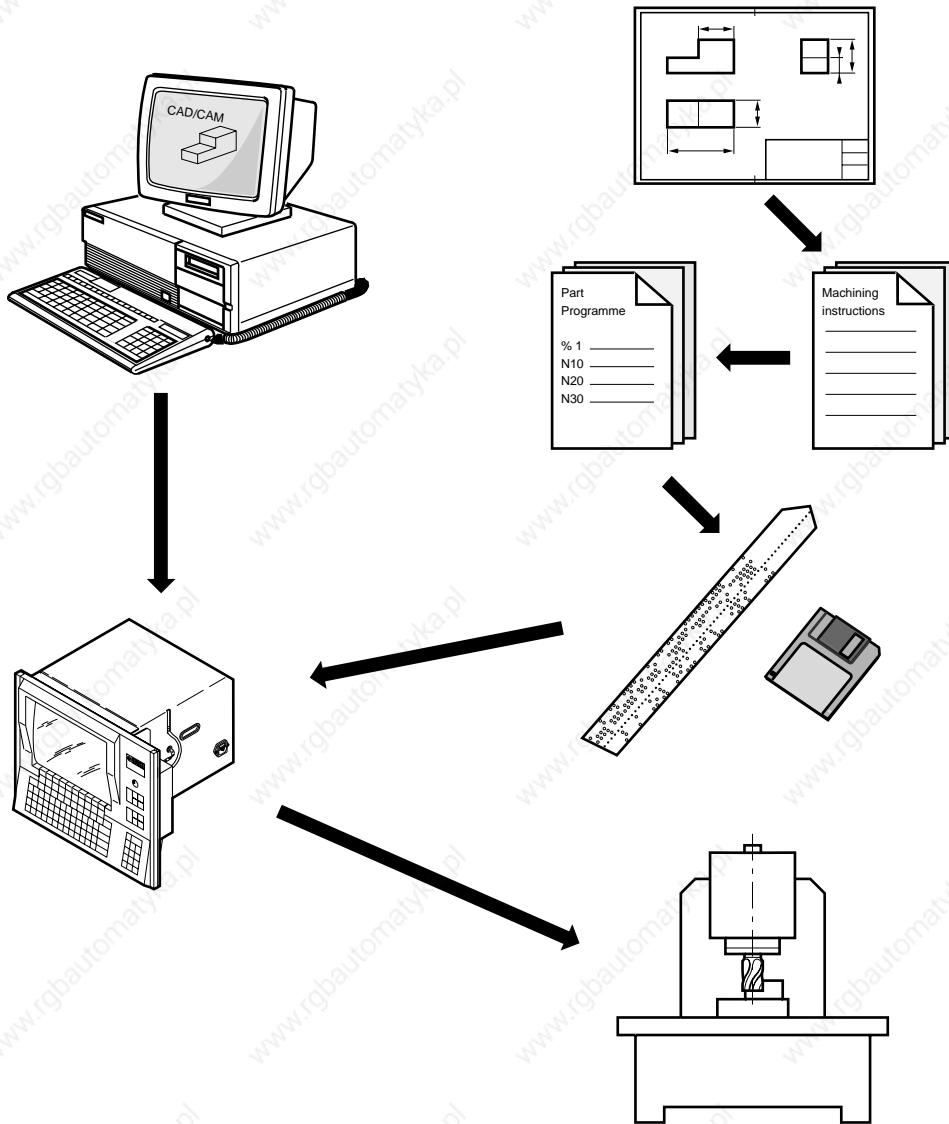

1.2 Machine Overview

1.2.1 Review of Axis Definition and Direction

A coordinate system is used to identify the positions and movements of an object with respect to an origin or zero point.

A rectangular cartesian coordinate system is a right-handed three-axis system of three linear axes, X, Y and Z, with which are associated three rotary axes, A, B and C.

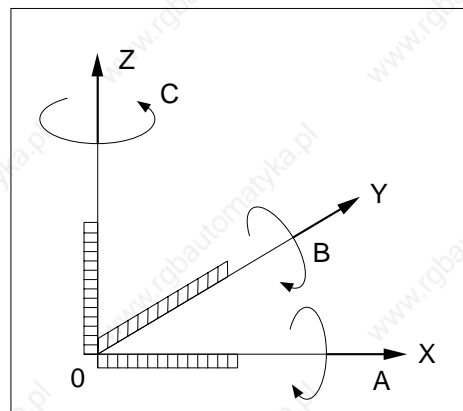

The direction of axes X, Y and Z is easily remembered by the right-hand rule.

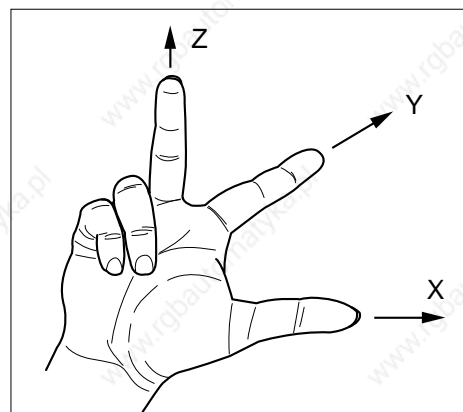

The positive direction of rotation of a rotary axis corresponds to the direction of screwing of a right-hand screw on the associated axis.

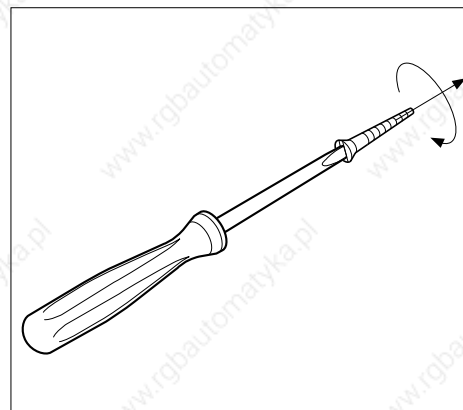

1.2.2 Machine Overview

The manufacturer defines the coordinate system associated with the machine in accordance with standard ISO 841 (or NF Z68-020).

The X, Y and Z axes, parallel to the machine slideways, form a right-handed rectangular cartesian coordinate system.

The coordinate system measures tool movements with respect to the part to be machined, assumed fixed.

REMARK *When it is the part that moves, it may be more convenient to identify its movements. In this case, axes X' , Y' and Z' , pointing in opposite directions from axes X, Y and Z, are used.*

The direction of the axis of a machine depends on the type of machine and the layout of its components.

For a milling machine:

- the Z axis is the axis of the main spindle when this axis is parallel to one of the slideways,
- positive movement along the Z axis increases the distance between the part and tool,
- the X axis is perpendicular to the Z axis and corresponds to the largest excursion,
- the Y axis is perpendicular to the X and Z axes.

Rotary axes A, B and C define rotations around axes parallel to X, Y and Z.

Secondary linear axes U, V and W may or may not be parallel to primary axes X, Y and Z.

For more details, refer to the above-mentioned standard.

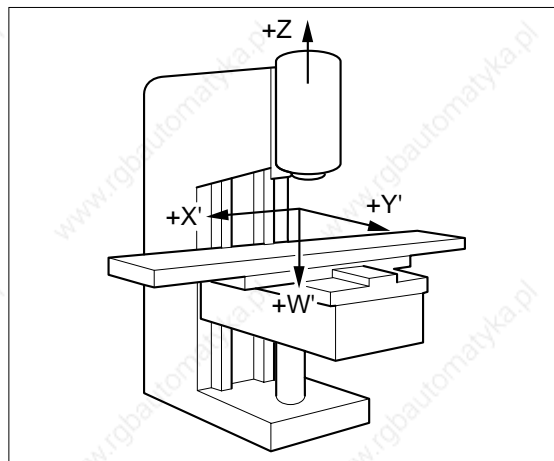

1.2.3 Definition of Travels and Origins

The NC processor computes all movements with respect to the measurement origin or zero point of the machine.

When the system is turned on, it does not know the measurement origin. The mechanical travel on each machine axis is limited by maximum and minimum limit switches.

OM :  The system establishes the measurement origin (OM) via a homing procedure (MOS).

Om :  The home switch is set in a specific physical location: the machine zero point (Om) may or may not be the same as the measurement origin (OM).

The homing procedure is completed for each of the axes when:

- the origin limit switch is actuated in the direction of movement specified by the m/c manufacturer (MOS direction),
- the encoder which measures axis movement outputs its marker pulse.

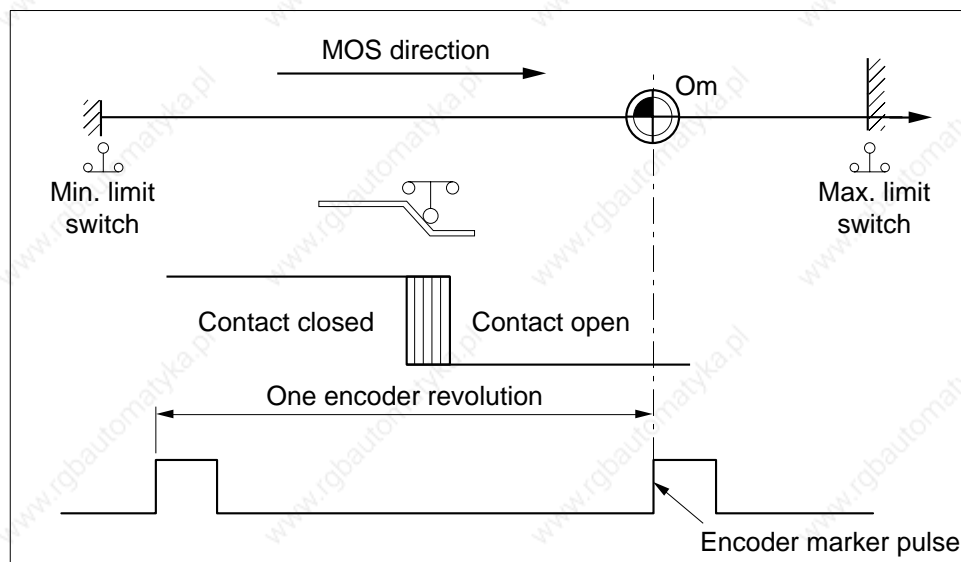

When homing (MOS) is completed, the system applies the shift defined by the manufacturer to each of the axes to establish the measurement origin (OM).

$$\text{Measurement origin shift (Om/OM)} = \text{ORPOM}$$

The useful travel on each axis is limited by software limits whose values are defined by the manufacturer.

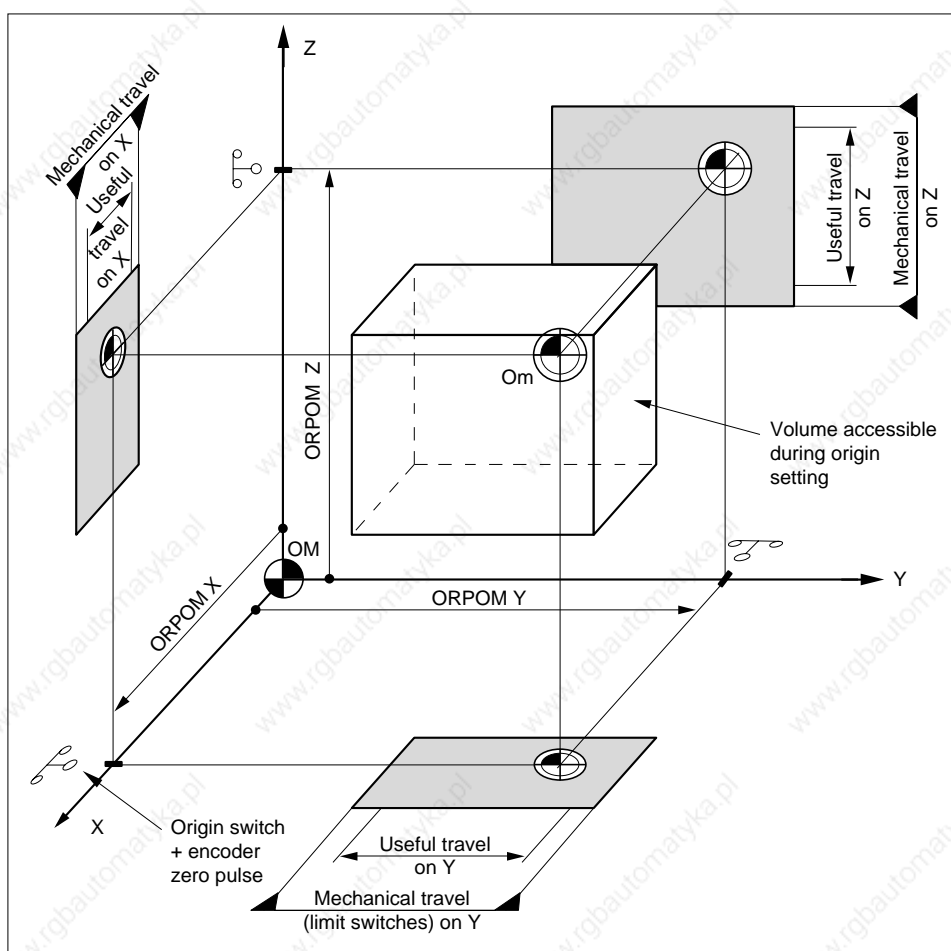

1.2.4 Definition of Shifts

To write a part programme, the programmer chooses a programme origin.

The programme origin is generally a starting point for dimensional measurements on the part drawing.

OP :  The operator sets the programme origin (OP) as shown below:

Op :  He sets (for each axis) a known, accessible point on the part, called the part origin (Op). This may be the same point as the programme origin.

Part datum shift (Op/OM) = DAT1

It is possible to set the DAT1 and DAT2 values from the part programme.

Programme datum shift (OP/Op) = DAT2

Shifts on the Z axis

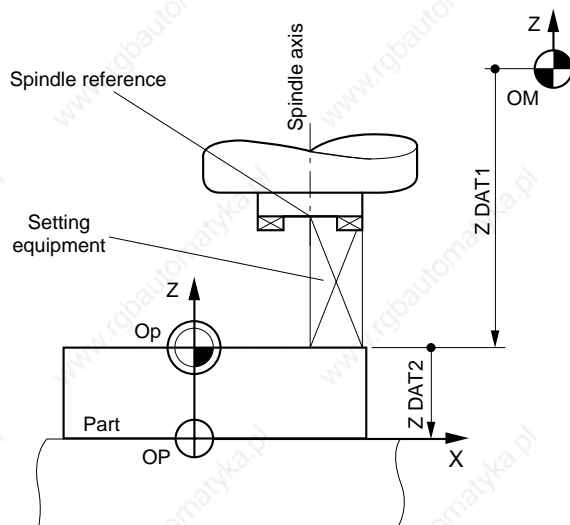

Shifts on the X axis

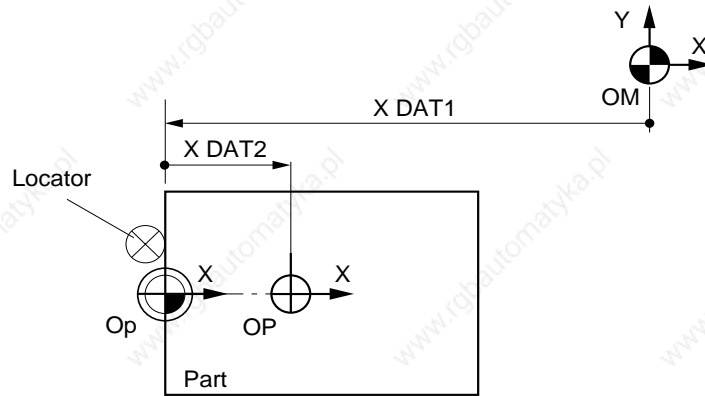

Shifts on the Y axis

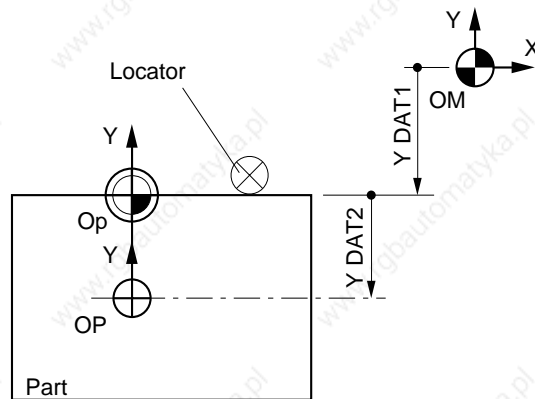

The coordinates of any point (A) defined with respect to the programme origin (OP) are converted by the CNC into coordinates with respect to the measurement origin (OM):

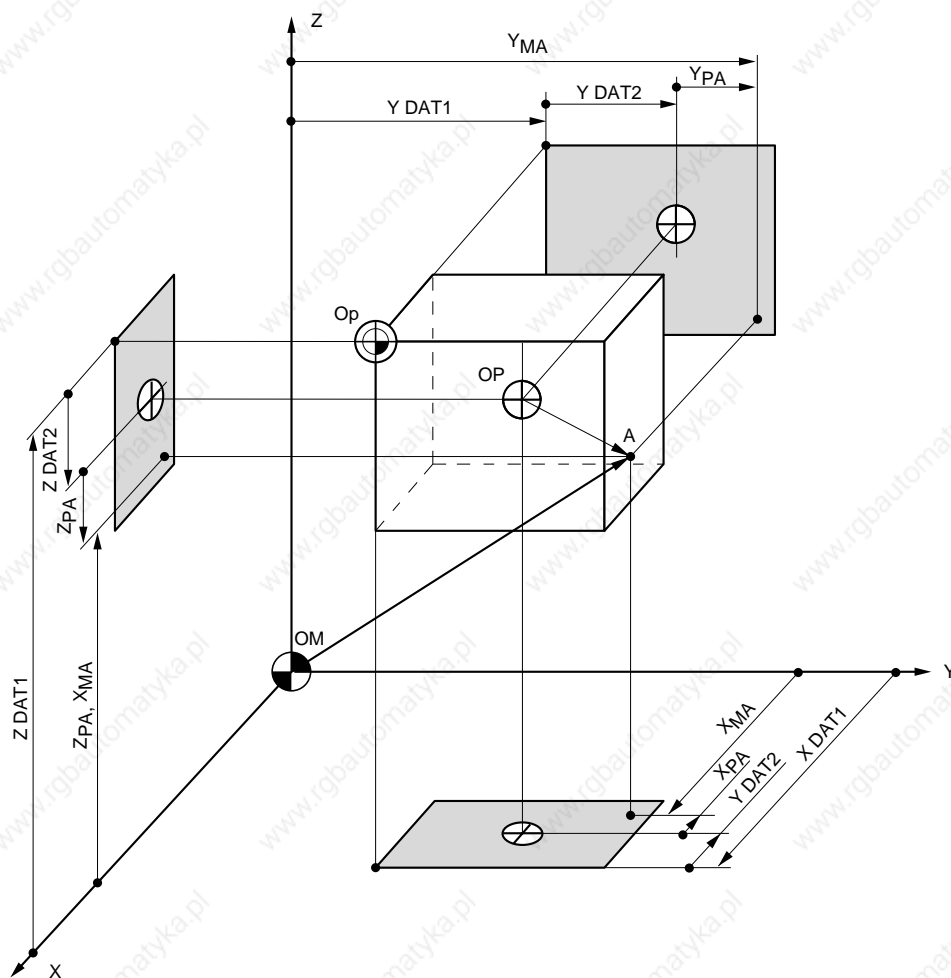

Programme dimensions (with respect to OP)	Measurement dimensions (with respect to OM)
X_{PA}	$X_{MA} = X_{PA} + X_{DAT1} + X_{DAT2}$
Y_{PA}	$Y_{MA} = Y_{PA} + Y_{DAT1} + Y_{DAT2}$
Z_{PA}	$Z_{MA} = Z_{PA} + Z_{DAT1} + Z_{DAT2}$

The dimensions are algebraic values.

Programmed shifts can be added to the measurement dimensions.

Special Case of Milling Machines Equipped with Rotary Tables

This concept of part origin only applies to the two axes affected by rotation.

The centre of rotation of the table (OC) has a particular role.

Offset of the centre of rotation (OC/OM) = DAT1
(axes affected by rotation)

Offcentring of the part (OP/OC) = DAT3
(axes affected by rotation)

REMARK For axes other than those affected by rotation, the previous definitions of DAT1 and DAT2 still apply.

Example: rotary axis B

Rotation is around an axis parallel to the Y axis. The axes affected by the rotation are Z and X.

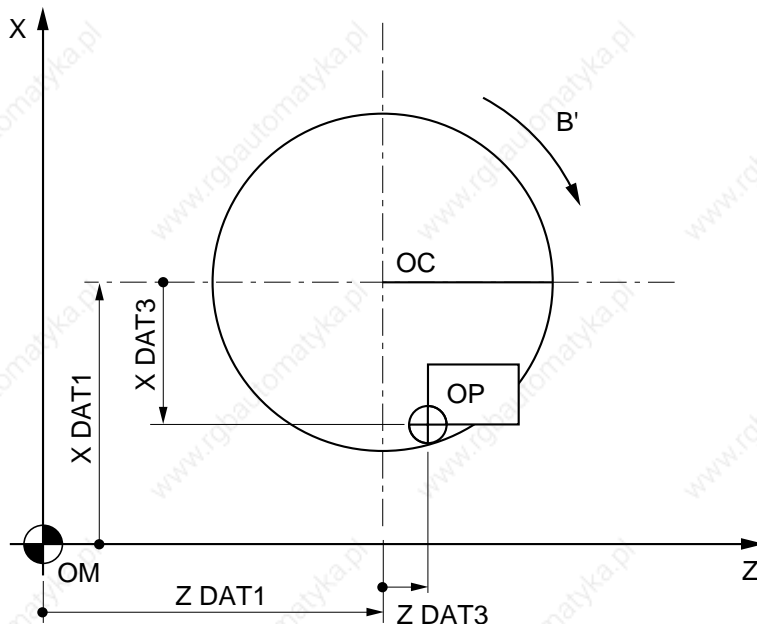

The position of any point (A) defined with respect to the programme origin (OP) is converted by the CNC into coordinates with respect to the measurement origin (OM):

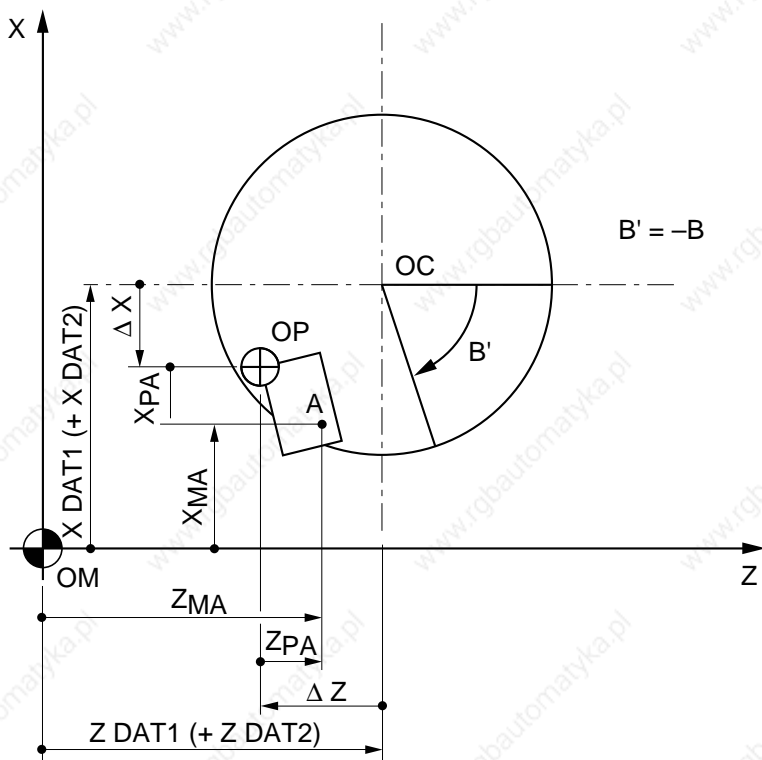

Programme coordinates (with respect to OP)	Measurement coordinates (with respect to OM)
X_{PA}	$X_{MA} = X_{PA} + X\text{ DAT1 (+ X DAT2)} + \Delta X$ with $\Delta X = X\text{ DAT3} \times \cos B - Z\text{ DAT3} \times \sin B$
Y_{PA}	$Y_{MA} = Y_{PA} + Y\text{ DAT1 + Y DAT2}$
Z_{PA}	$Z_{MA} = Z_{PA} + Z\text{ DAT1 (+ Z DAT2)} + \Delta Z$ with $\Delta Z = Z\text{ DAT3} \times \cos B + X\text{ DAT3} \times \sin B$

1.2.5 Definition of Tool Dimensions

Tool dimension = distance from tool cutting edge to spindle reference point

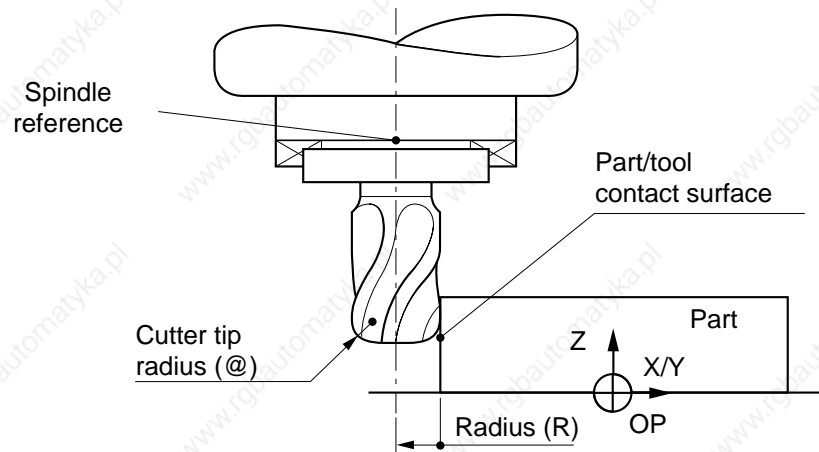
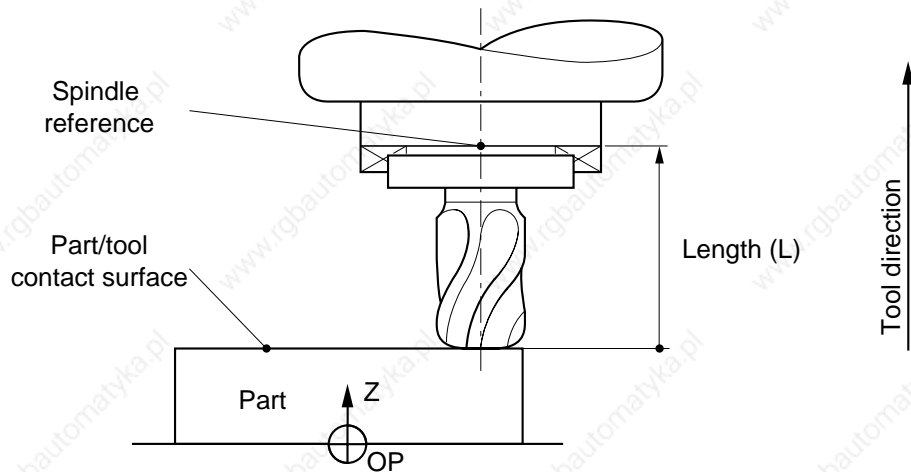

Tool radius = R
Tool length = L

Cutter tip radius = @

1.2.6 Definition of Tool Wear Offsets

At any time (even during machining), the operator can enter tool wear offsets when he observes a difference between the expected and the actual results on a part.

The offsets (positive or negative) compensate for slight dimensional variations of the tool or part (wear, expansion).

Tool radius wear offset = DR
Tool length wear offset = DL

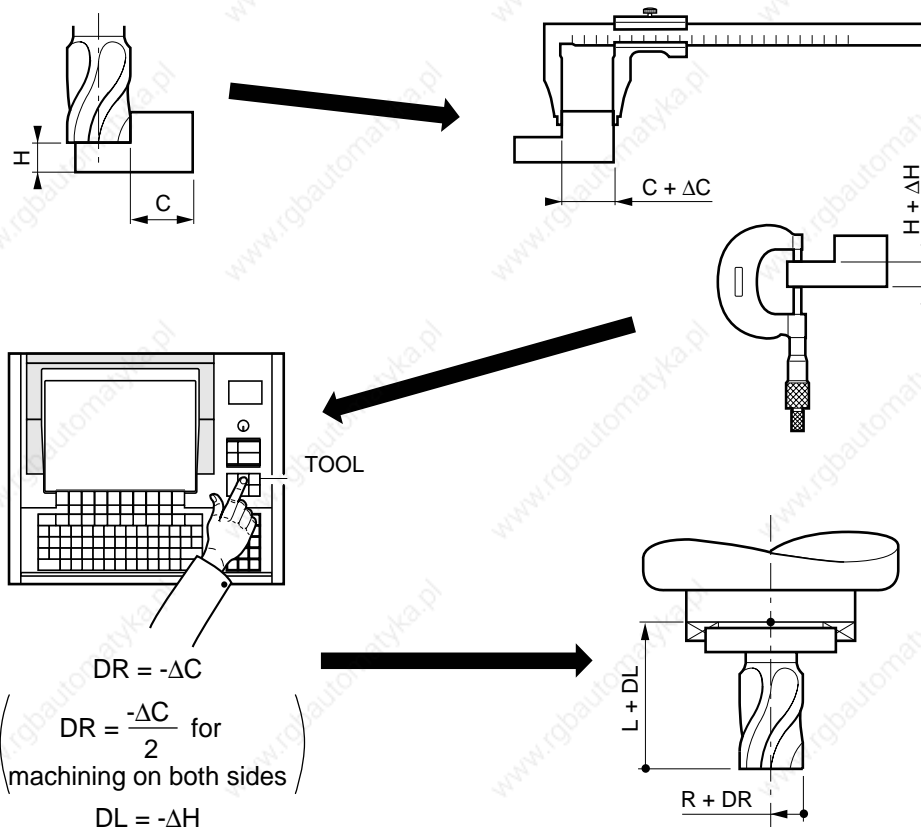

The system takes into account the corrected tool dimensions:

Corrected radius = $R + DR$
Corrected length = $L + DL$

2 Product Presentation

2.1 Environment		2 - 3
2.1.1	NUM 1060 Series I or NUM 1060 Series II	2 - 3
2.1.2	NUM 1020, 1040 and 1050	2 - 4
2.1.2.1	NUM 1020, 1040 and 1050 with CNC Panel or Compact Panel	2 - 4
2.1.2.2	NUM 1020, 1040 and 1050 with FTP40 PC Panel	2 - 5
2.2 Switching on/off		2 - 6
2.2.1	Switching on	2 - 6
2.2.2	Restart Following an Emergency Stop	2 - 6
2.3 System Identification		2 - 7
2.3.1	Access to System Customisation Attributes	2 - 7
2.3.2	System Customization Information Grid	2 - 17

2.1 Environment

2.1.1 NUM 1060 Series I or NUM 1060 Series II

The following diagram illustrates the links between the CNC, the machine and the peripherals for NUM 1060 Series I and NUM 1060 Series II systems with CNC panel or LCD panel or compact panel.

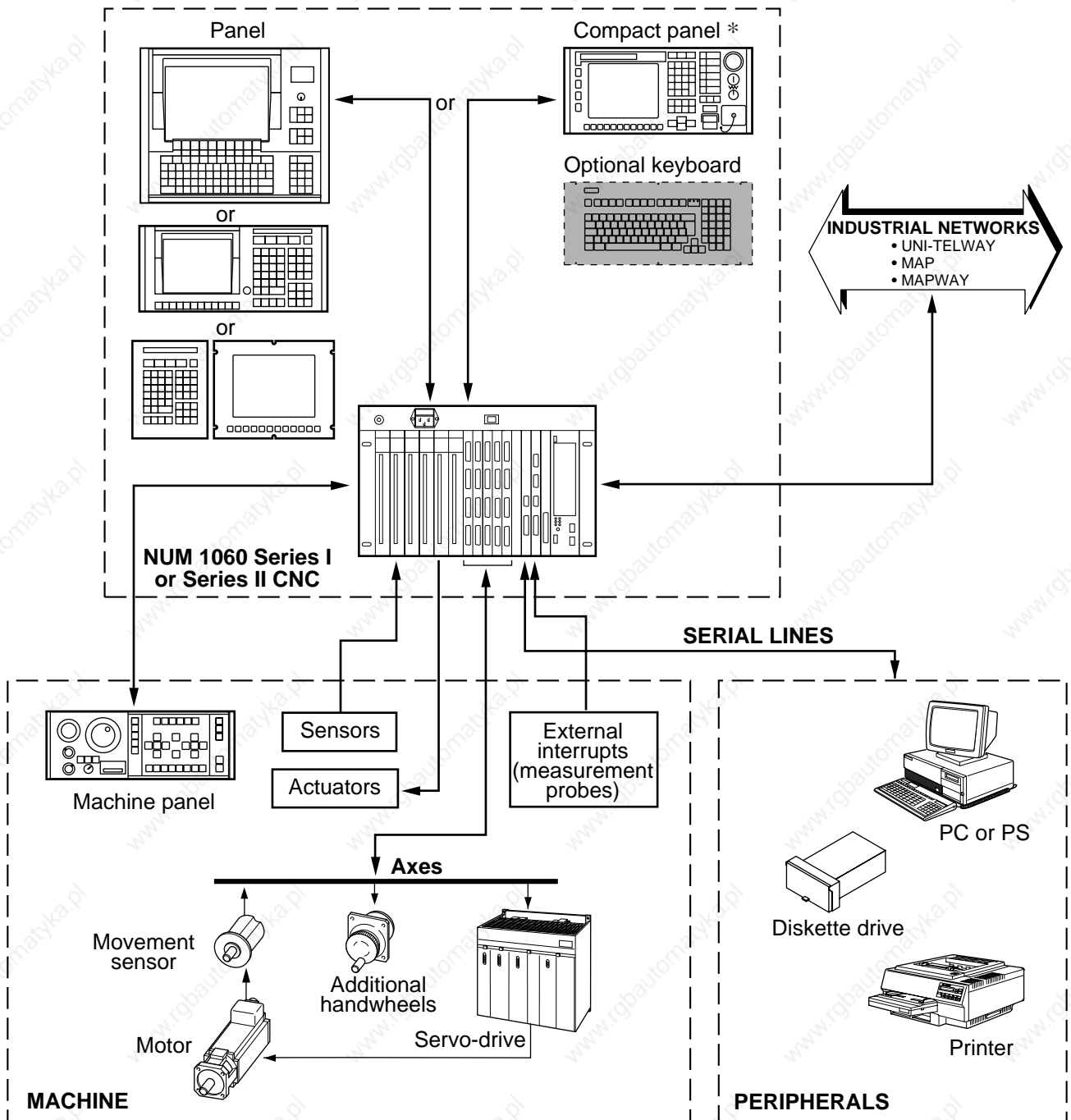

* The compact panel is incompatible with the machine panel. An optional keyboard can be connected to the compact panel.

2.1.2 NUM 1020, 1040 and 1050

2.1.2.1 NUM 1020, 1040 and 1050 with CNC Panel or Compact Panel

The following diagram illustrates the links between the CNC, the machine and the peripherals for a NUM 1020, 1040 or 1050 system with CNC panel or LCD panel or compact panel.

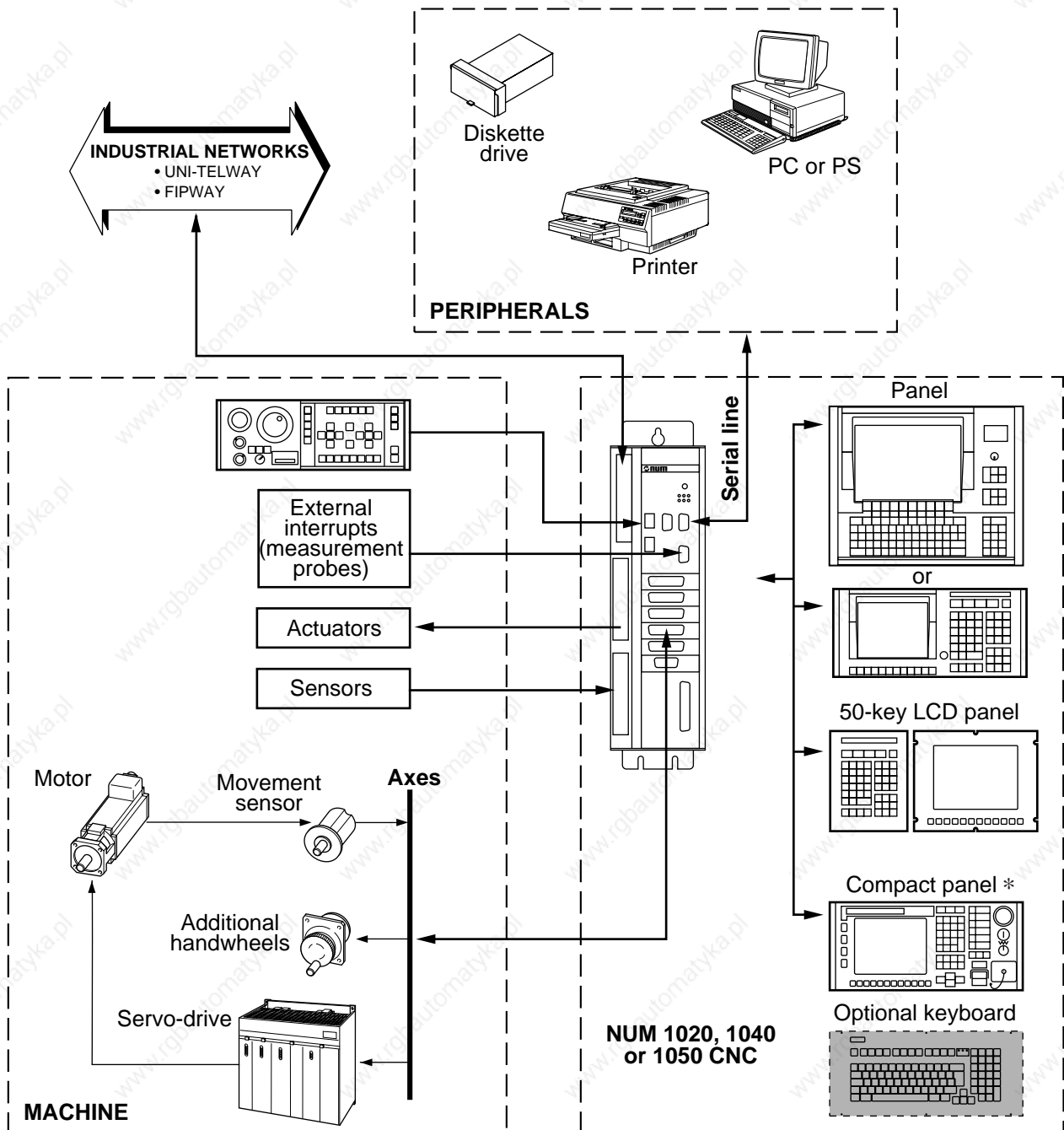

* The compact panel is incompatible with the machine panel. An optional keyboard can be connected to the compact panel.

2.1.2.2 NUM 1020, 1040 and 1050 with FTP40 PC Panel

The following diagram illustrates the links between the CNC, the machine and the peripherals for a NUM 1020, 1040 or 1050 system with FTP40 PC panel.

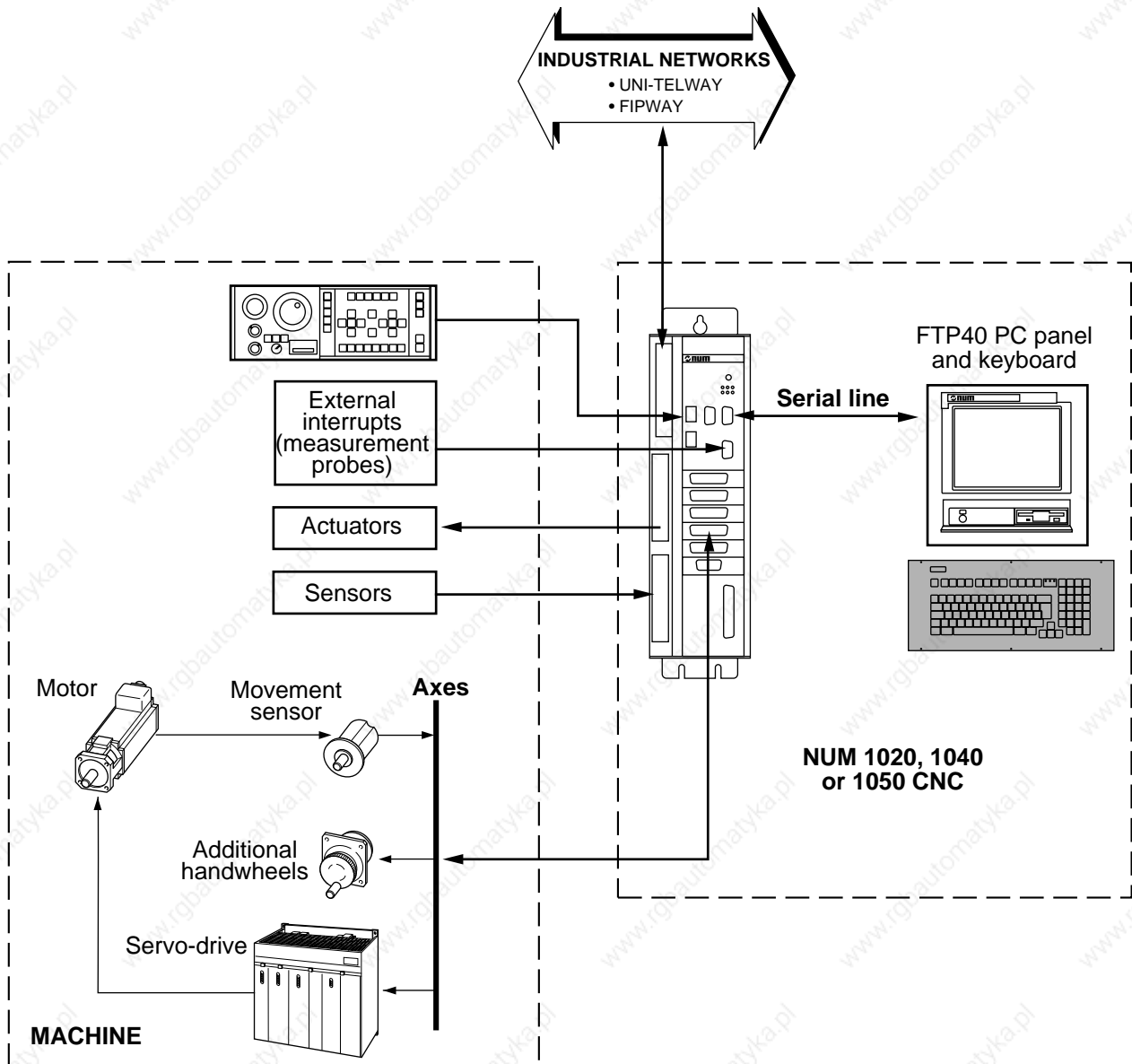

2.2 Switching on/off

2.2.1 Switching on

Switch on the machine using the procedure defined by the OEM

Example of equipment power up sequence:

- general switching on (the CNC and the peripherals),
- switching on the power systems (with conditions related to the CNC).

When the CNC is switched on, a status window displays the following type of information:

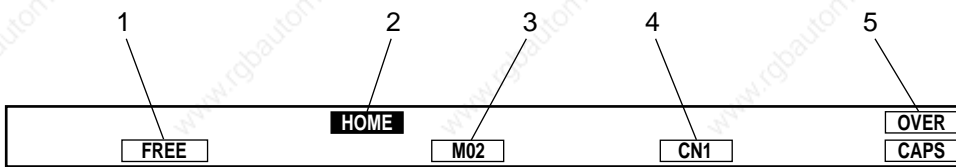

- 1 - Increment indicator: "FREE" is the default setting (another increment can be selected by the PLC)
- 2 - "HOME" indicator: the measurement origin settings still to be performed on the declared axes
- 3 - "M02" indicator: normal status of the system when not machining (the "RESET" indicator is displayed if there is no PLC programme or the PLC is faulty)
- 4 - "CN1" indicator: in single-panel configuration (single or multiple CNC), the first CNC is the default CNC
- 5 - "OVER" and "CAPS" indicators: text editor is set to overtype mode and upper case letters when the system is switched on

If one of these indicators is missing, a fault may be present on the system.

Notes

If the power to the CNC is switched off and back on, all the machining parameters (shifts, tool offsets, etc.) remain stored; only the measurement origin is lost.

Incidents

Any message displayed when the CNC is switched on (See chapter 7) is linked to a system fault.

2.2.2 Restart Following an Emergency Stop

An emergency stop automatically switches off the power to the machine actuators. The CNC remains energised and retains all the machining data including movement commands.

Reset all the current movement commands.



Restart the machine using the procedure defined by the OEM.

2.3 System Identification

2.3.1 Access to System Customisation Attributes

The user can consult the pages indicating the customisation attributes which have been set for his system.

Requirements

Basic softkeys (See 3.1.4.2).

Actions

Select the "CNC COMMUNICATION DISPLAY" menu.



Display of the "CNC COMMUNICATION DISPLAY" menu (See 4.10).

Select the first system identification page (after the menu).



Display of the "AFFAIR AND SOFTWARE VERSIONS" page, e.g.:

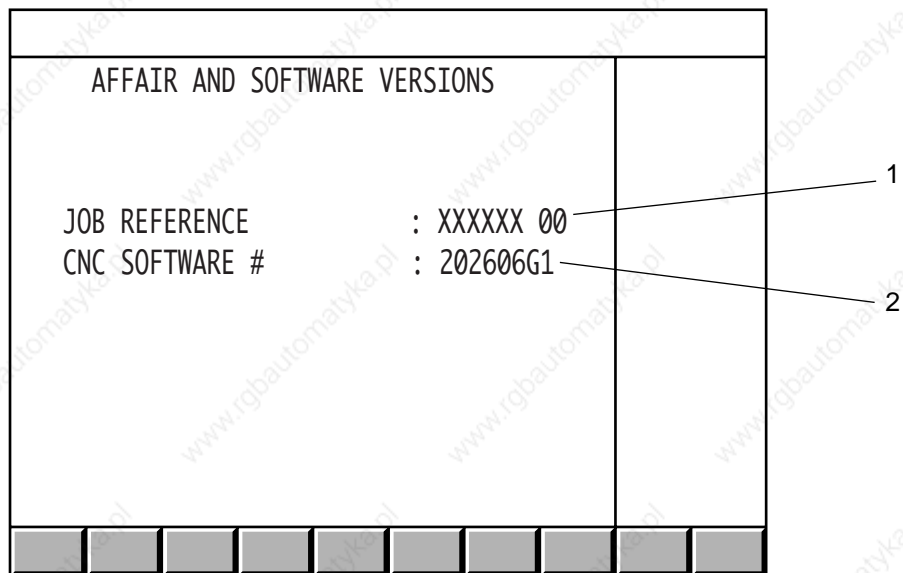

- 1 - Job reference
- 2 - Software version and index

Select the next page.



...
DAT

Display of "OPTIONS" page, e.g.:

	0	1	2	3	4	5	6	7	8	9	10	11	12	
							X					X		0
		X					X							1
O	X				X									2
P				X										3
T				X										4
I														5
L														6
O														7
N	13	14	15	16	17	18	19	20	21	22	23	24	25	8
S														9

- 1 - Tens
- 2 - Units
- 3 - "X" indicates that the corresponding function is available

The table below lists the functions available.

Number	Function
0	3D display
1	Double windowing graphics
2	Hard copy
3	Additional language for CNC software
4	Program display/edit for NUM Tplus
5	Program load/unload and graphic simulation for NUM Tplus
10	Axis calibration: access to Utility 2, axis Calibration access to Utility 20, Interaxis Calibration
11	Dynamic operators
12	Synchronised and duplicated axes
13	Multigroup function
14	Inclined axes
15	Inclined plane
16	N/M auto function
17	RTCP (Rotation around Tool Centre Point)
18	High speed machining of precision contours
19	Dynamic operators in C
20	Rigid tapping
21	Slaving of axes to spindle (G31, G33, G38)
22	Integrated spindle synchro
30	3D tool radius offset
31	Extension of number of corrections to 255
32	Tool wear offset control by the PLC
33	5-axis tool dimension
40	PROCAM interpreter
41	Accuracy setting
42	PGP (Profile geometry programming)
43	Resident macros: Access to Utility 3
44	Scaling factor
45	Programmable angular shift
46	Structured programming
47	Transfer of active parametric values into the part programme
48	Radial axis (boring function)
49	Irregular pockets and islands
50	Cartesian, polar and cylindrical conversion
51	Spline curve
52	Smooth polynomial interpolation
53	Creation of profile storage table
55	2D circular interpolation

Number	Function
60	Turning functions
61	Milling functions
62	Mixed machine functions
63	Selection of 1020 (=0) or 1040 (=1)
64	NUM 1040 GP: four axis groups (=1)
65	NUM Tplus (=1)
70	Emergency retraction
71	On-the-fly measurement acquisition
72	Backtrack along path
80	Coprocessor interchange protocol
81	UNI-TELWAY
82	Telemaintenance
83	DNC1
84	3-layer network
85	7-layer network
86	High speed console line
87	FIPWAY
90	PLC programming in C
91	Gear grinding
92	Automatic gear alignment
93	Access to utility 6 (=1)
100	Application development software tool
101	NUMAFORM
103	PROCAM TURN or MILL
104	PROCAM MULTITURN
105	PROCAM MX (mixed machine)
106	PROCAM Grinding
107	Rigid tapping (on diskette)
108	Spindle synchronisation (on diskette)
109	RTCP (Rotation around Tool Centre Point) on diskette
127	Servo-control simulation
200	Milling package for DIDACNUM turning
201	Turning package for DIDACNUM milling
202	WOODplus
203	PCToolKit
210	MMITool interpreter
211	Package of basic options for NUM subsidiaries

Select the next page.



Display of the "AXES NUMBER" page (the numbers displayed on this page are set during the customization procedure), e.g.:

AXES NUMBER	
NUMBER OF CNC OR PLC AXES : 7	1
NUMBER OF SPINDLES : 2	2
NUMBER OF INTERPOLATED AXES : 5	3
NUMBER OF PLC ONLY AXES : 2	4

- 1 - Total number of axes authorized on the system (CNC axes + PLC axes)
- 2 - Total number of spindles authorized
- 3 - Number of simultaneous interpolated axes
- 4 - Number of axes exclusively controlled by the PLC

Select the next page.



.../...
DAT

Display of the "MEMORY SIZES" page (these sizes are set during the customization procedure), e.g.:

MEMORY SIZES	
PART PROGRAMME STORAGE	: 1024
PLC PROGRAMME STORAGE	: 256
MMI PROGRAMME STORAGE	: 800

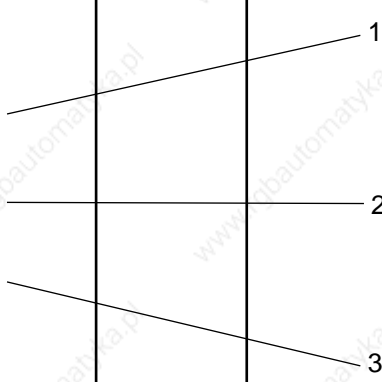

- 1 - RAM size assigned to part programmes
- 2 - RAM size assigned to the PLC
- 3 - RAM size assigned to MMITool
(man/machine interface customisation tool)

Select the next page.



Display of the "HISTORY" page, e.g.:

HISTORY	
FACTORY OUT : 26 / 2 / 92 15:20:65 CABC-EF	1
LAST MODIFIED ON : 8 / 6 / 94 10:37:23 D2R2	2

- 1 - Date, time and identification of the first person to customize the system
- 2 - Date, time and identification of the last user to customize the system using utility 12

Select the next page.



...
DAT

Display of the "SYSTEM BUS HARDWARE CONFIGURATION" page for instance:

SYSTEM BUS HARDWARE CONFIGURATION				
Address	Designation	File number	Vers.	Ident.
0	Unknown card	000 000 000	8	\$0007F8
1	4M V2 graphic processor	204 202 778	0	\$005340
2	1M PLC	204 201 935	0	\$004800
3	V2 1,7/2M memory board	204 202 301	0	\$008D80
4	4 V1 14b encoder axes	204 201 982	0	\$000E00
5				
6				
7				
8				
9				
10				
11				
12				
13				

.../...

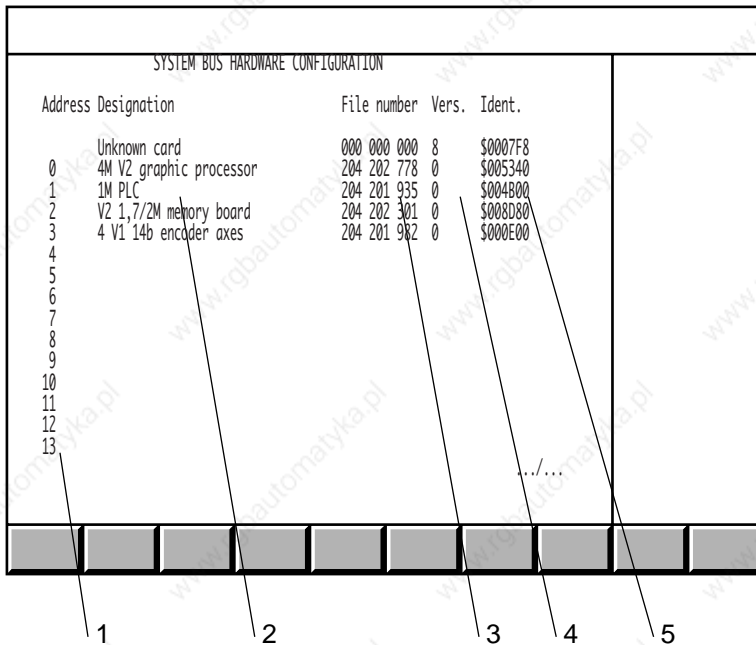

- 1 - Card address on the system bus (the addresses are numbered from 0 to 13 starting from the right end of the rack)
- 2 - Card description
- 3 - Part number of each card
- 4 - Card functionality index (decimal conversion of the last character of the identifier. For instance, if the last character is D, the functionality index is 13)
- 5 - Electronic identifier of each card (this number is used to ensure card interchangeability).

Each line of the "SYSTEM BUS HARDWARE CONFIGURATION" page gives information on a card installed on the system bus.

The first line corresponds to the system bus backplane card.

Blank lines correspond to empty card slots.

If the card identifier is unknown, the message "card unknown" is displayed in the "Description" column.

Select the next page.



.../...
DAT

Display of the "PLC BUS HARDWARE CONFIGURATION (RACK 0)" page, for instance:

PLC BUS HARDWARE CONFIGURATION (RACK 0)				
Address	Designation	File number	Vers.	Ident.
0	Main serial bus	204 201 857	0	\$000000
0	130W power supply with optic F.	204 201 950	0	\$000000
1				
2				
3				
4				
5	32 inputs board	204 201 926	0	\$000A00
6	32 relayed outputs board	204 201 746	0	\$000100
7				
8				
9				
10				
11				
12				
13				

- 1 - Address on the serial bus:
 - address 0 corresponds to the serial bus and the fibre-optic interface on the power supply card
 - addresses 1 to 4 are reserved for the machine panels
 - addresses 5 to 12 are reserved for the input/output cards
- 2 - Card description
- 3 - Part number of each card
- 4 - Card functionality index (decimal conversion of the last character of the identifier. For instance, if the last character is D, the functionality index is 13)
- 5 - Electronic identifier of each card (this number is used to ensure card interchangeability)

Each line of the "PLC BUS HARDWARE CONFIGURATION (RACK 0)" page gives information on a module installed on the serial bus.

Blank lines correspond to empty slots.

When the system includes extension racks, the sign ".../..." is displayed in the bottom right-hand corner of the page.

To display the contents of the extension racks:

Select the next page as many times as necessary.



The "PLC BUS HARDWARE CONFIGURATION (RACK X)" page is displayed.

It contains the same type of information as the "PLC BUS HARDWARE CONFIGURATION (RACK 0)" page; the input/output cards occupy slots 1 and 2 (two-card extension racks) or 1 to 12 (12-card extension racks).

Notes

If no PLC is present, the message "PLC MISSING" is displayed in the "PLC BUS HARDWARE CONFIGURATION" page.

If a CL7 controller card (link with a TSX series 7 PLC) is present, no PLC bus configuration page is displayed.

Exit from the procedure

Select a display page.

2.3.2 System Customization Information Grid

The system customization parameters can only be consulted when the system is operational.

It is recommended to write this information down for communication to the OEM or NUM customer support in case of a failure preventing consultation.

MACHINE IDENTIFICATION															
Machine No.:	Shop:														
CUSTOMISATION															
Job reference:	CNC software #:														
Options present:															
	<table border="1" style="display: inline-table; border-collapse: collapse;"> <tr> <td style="width: 20px;"></td> <td style="width: 20px;">0</td> <td style="width: 20px;">1</td> <td style="width: 20px;">2</td> <td style="width: 20px;">3</td> <td style="width: 20px;">4</td> <td style="width: 20px;">5</td> <td style="width: 20px;">6</td> <td style="width: 20px;">7</td> <td style="width: 20px;">8</td> <td style="width: 20px;">9</td> <td style="width: 20px;">10</td> <td style="width: 20px;">11</td> <td style="width: 20px;">12</td> </tr> </table>		0	1	2	3	4	5	6	7	8	9	10	11	12
	0	1	2	3	4	5	6	7	8	9	10	11	12		
0															
1															
2															
3															
4															
5															
6															
7															
8															
9															
Total number of axes:	Number of measured splindles:														
Number of interpolated axes:	Number of machine proc. axes:														
Part programme RAM size:	Machine processor RAM size:														
HISTORY															
Date factory out:	Identification:														
Date last modified on:	Identification:														

The following table can be reproduced as many times as there are "BUS XXX HARDWARE CONFIGURATION" pages.

HARDWARE CONFIGURATION OF BUS _____				
Address	Description	Part Number	Index	Identifier
0				
1				
2				
3				
4				
5				
6				
7				
8				
9				
10				
11				
12				
13				

3 Operator Panel Description

3.1 NUM Panels and Sub-Assemblies		3 - 3
3.1.1	NUM Panels	3 - 3
3.1.1.1	QWERTY Panel and CRT	3 - 3
3.1.1.2	50-Key Panels with CRT	3 - 4
3.1.1.3	50-Key Panel with LCD	3 - 4
3.1.1.4	Compact Panel	3 - 5
3.1.2	Display Screen	3 - 6
3.1.3	Status Window	3 - 7
3.1.4	Softkeys	3 - 8
3.1.4.1	Root Softkey Bar (Compact Panel)	3 - 8
3.1.4.2	Basic Softkeys	3 - 8
3.1.4.3	Mode Softkeys	3 - 8
3.1.4.4	JOG Softkeys	3 - 9
3.1.4.5	Tool Softkeys	3 - 10
3.1.4.6	Character Softkeys of the Compact Panel	3 - 10
3.1.5	Modal Data Window	3 - 11
3.2 Interactions Between Mode Selections and Display Pages		3 - 12
3.2.1	Neutral Mode	3 - 12
3.2.2	Interactions between Modes	3 - 12
3.2.3	Interactions between Modes and Display Pages	3 - 12
3.3 Available Controls and Indicators		3 - 13
3.3.1	Keyboard Keys	3 - 13
3.3.1.1	Special Features of the 50-Key Panel Keyboard	3 - 13
3.3.1.2	Special Features of the Compact Panel Keyboard	3 - 13
3.3.1.3	Special Keyboard Keys	3 - 14
3.3.1.4	Special Control keys	3 - 15
3.3.1.5	Mode Selection Keys	3 - 16
3.3.1.6	Reset Key	3 - 16
3.3.1.7	Machine Panel Function Keys on the Compact Panel	3 - 16
3.3.2	Softkeys	3 - 17
3.3.2.1	Root Softkeys (Compact Panel)	3 - 17
3.3.2.2	Basic Softkey Functions	3 - 17
3.3.2.3	Mode Softkey Functions	3 - 18
3.3.2.4	JOG Softkey Functions	3 - 19
3.3.2.5	Tool Softkey Functions	3 - 19
3.4 Special Keyboard Operations		3 - 20
3.4.1	Hardcopy	3 - 20
3.4.1.1	Hardcopy on Printer	3 - 20
3.4.1.2	Hardcopy in File	3 - 21
3.4.2	Keyboard Sound	3 - 22
3.4.3	Switching between Operator Panels	3 - 22
3.4.4	Switching between CNCs	3 - 23
3.5 Use of a 102/105-Key Keyboard with the Compact Panel		3 - 24

3.1 NUM Panel and Sub-Assemblies

3.1.1 NUM Panels

3.1.1.1 QWERTY Panel and CRT

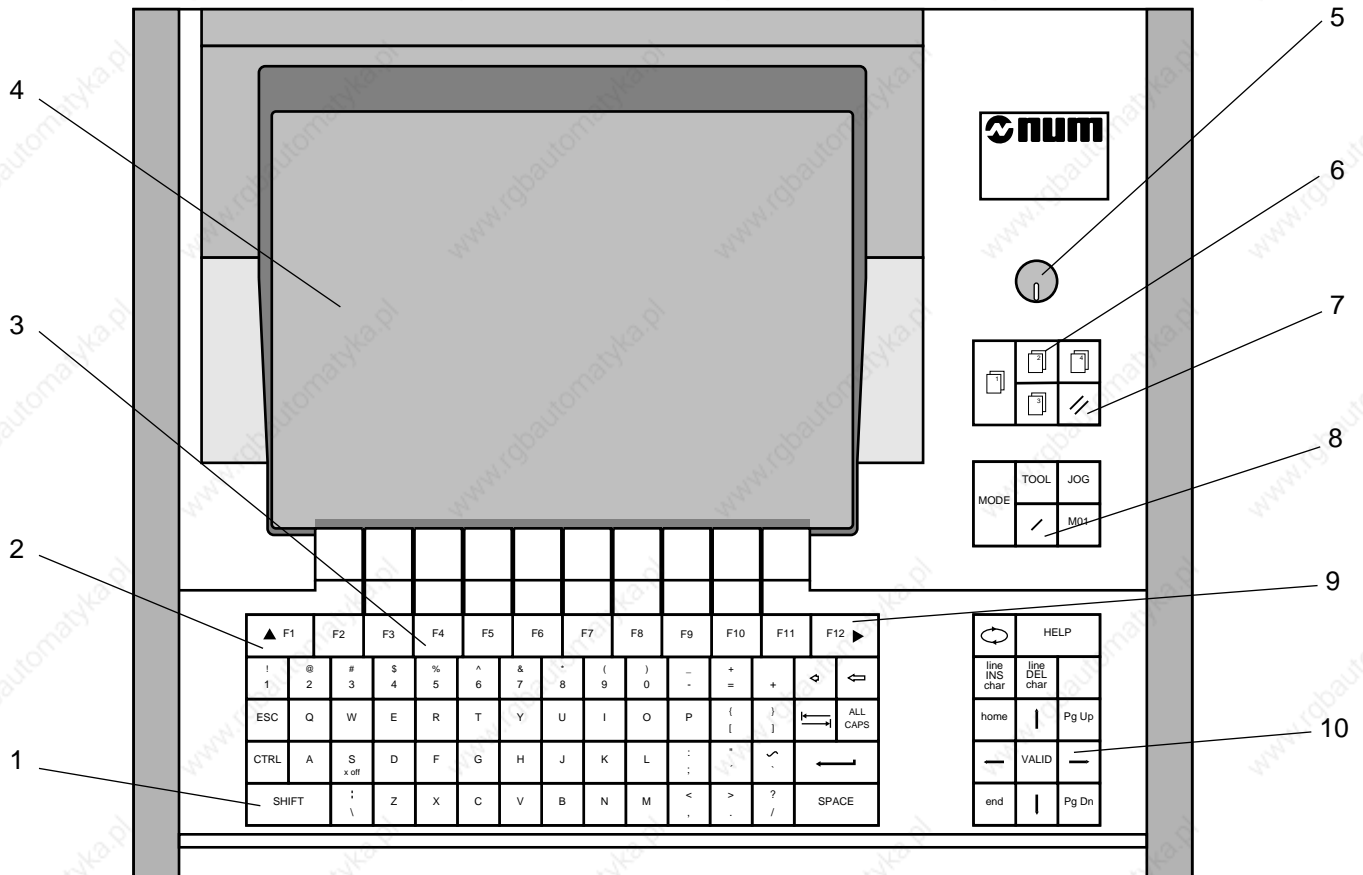

- 1 - QWERTY alphanumeric keyboard
- 2 - Key to access previous softkeys
- 3 - Function keys
- 4 - Colour CRT
- 5 - Brightness control
- 6 - Context selection keys
- 7 - Reset key
- 8 - Mode selection keys
- 9 - Key to access next "Mode" softkey
- 10 - Cursor control keys

3.1.1.2 50-Key Panels with CRT

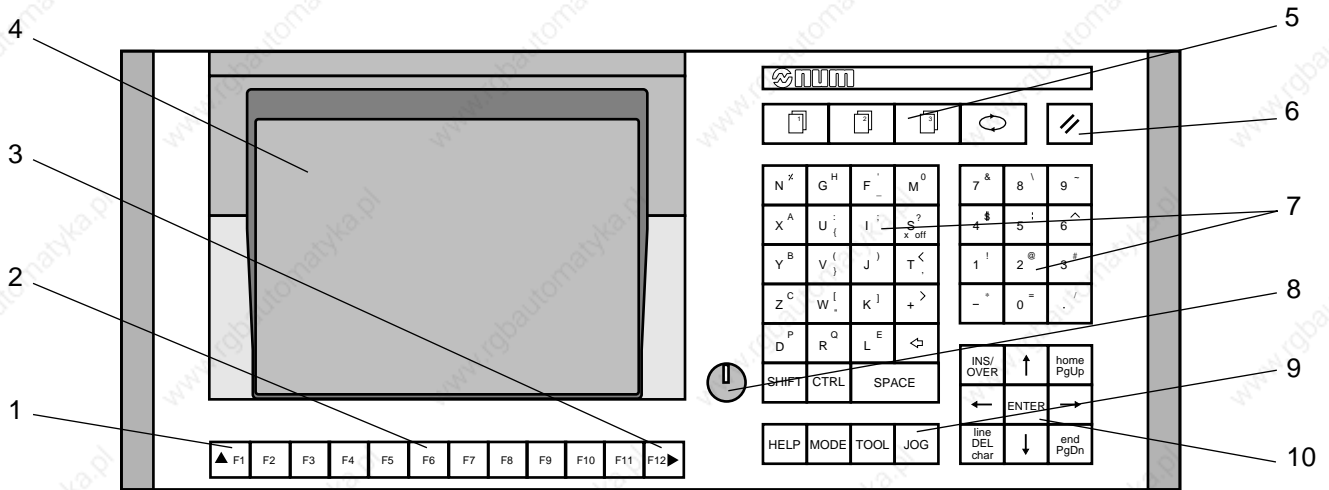

- 1 - Key to access previous softkeys
- 2 - Function keys
- 3 - Key to access next "Mode" softkeys
- 4 - 9" Monochrome or 10" colour screen
- 5 - Context selection keys
- 6 - RESET key
- 7 - Compact alphanumeric keyboard
- 8 - Brightness control
- 9 - Mode selection keys
- 10 - Cursor control keys

3.1.1.3 50-Key Panel with LCD

This assembly includes a 50-key panel and a separate LCD. It has the same functions as the 50-key panel with CRT (see 3.1.1.2).

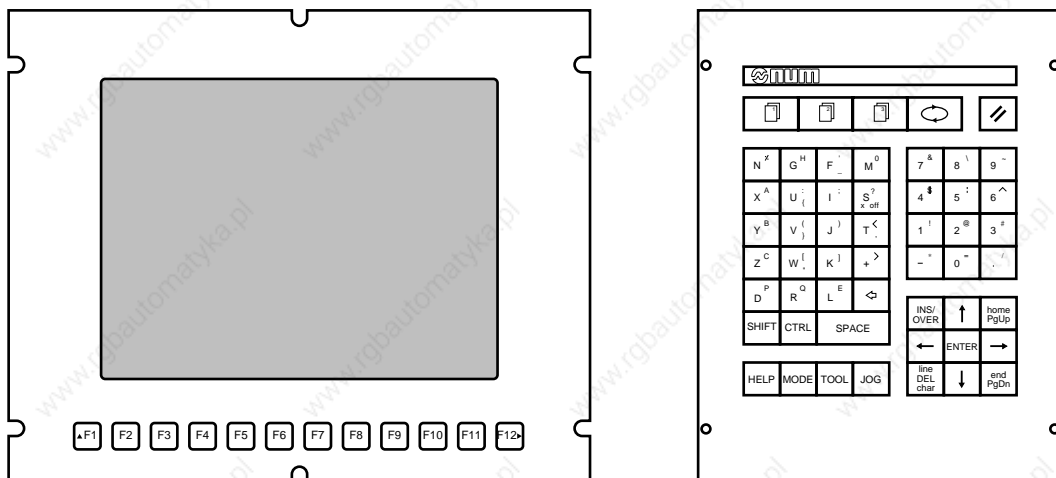

3.1.1.4 Compact Panel

The compact panel is used for production and settings. It combines the functions of a CNC panel and a machine panel. It can be used for ISO programming and maintenance by connecting a standard 102/105-key PC keyboard.

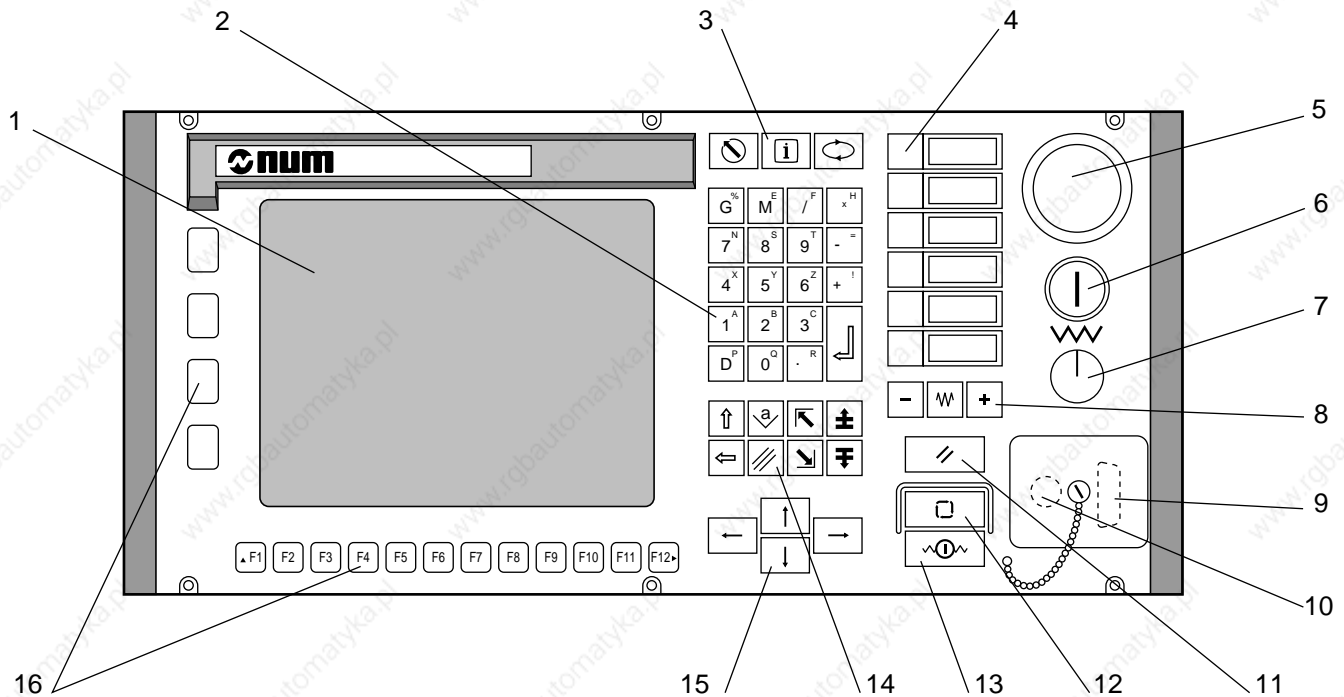

- 1 - 9" monochrome or 10" colour CRT
- 2 - Data entry keys
- 3 - Special keys
- 4 - Programmable keys (two functions per key: key alone and Shift + key) *
- 5 - Emergency stop switch
- 6 - Lighted on/off switch
- 7 - Feed rate override potentiometer
- 8 - Axis jogs *
- 9 - Serial port

- 10 - DIN connector for additional standard 102/105-key PC keyboard (this connector can be moved to the rear of the panel; see 3.5)
- 11 - Reset key
- 12 - Lighted CYCLE key *
- 13 - Lighted FEED STOP key *
- 14 - Special cursor control keys and Shift key
- 15 - Cursor control keys
- 16 - Function keys

* These machine keys remain active when the screen saver is on (the other keys merely turn the screen back on).

3.1.2 Display Screen

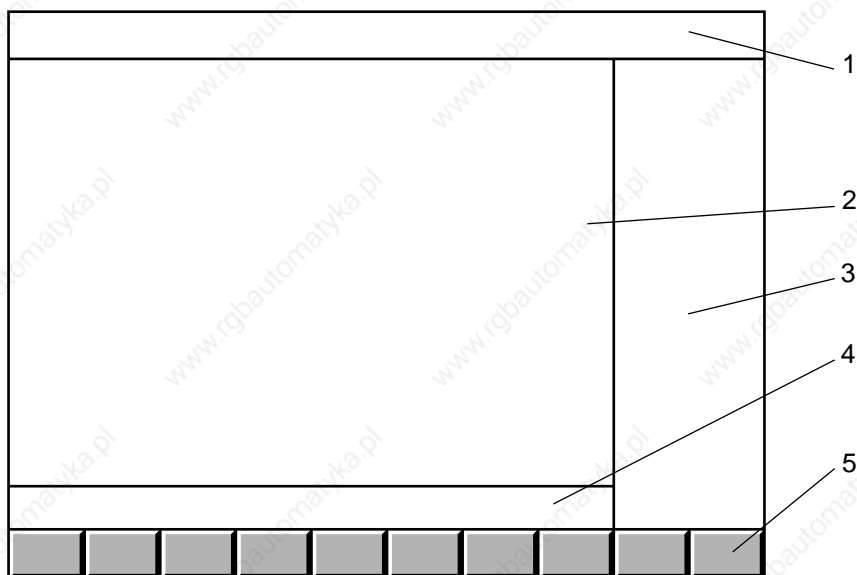

- 1 - Status window
- 2 - Main window (20 lines of small characters)
- 3 - Modal data window
- 4 - Dialogue window (3 dialogue lines)
- 5 - Softkey bar

Certain screens do not have a dialogue window. In this case, 11 lines of large characters are displayed.

3.1.3 Status Window

The status window shows the status of the CNC at any given time via indicators displayed in 17 fields.

When no indicators are required in a field, it is not displayed.

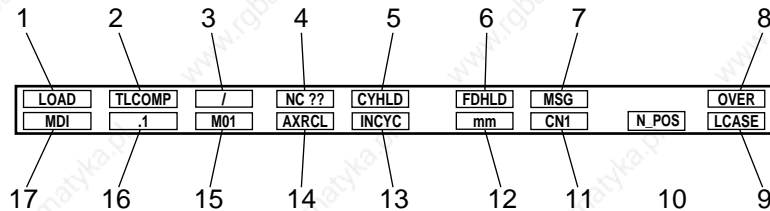

- 1 - Current mode (See list of modes: 3.3.2.2)
- 2 - Entry of tool dimensions (TLCOMP), entry of tool wear offsets (WEAR +) or cancellation of tool wear offsets (WEAR 0)
- 3 - Block skip (/) enabled
- 4 - Fault (NC ?? flashing) or MOS not performed (HOME flashing)
- 5 - Machining stop (CYHLD)
- 6 - Feed interruption (FDHLD)
- 7 - Message present (MSG)
- 8 - Overtime text mode (OVER) or insert mode (INSRT)
- 9 - Upper case letters (CAPS) or lower case letters (LCASE)
- 10 - Axis not in position (N_POS) or hardcopy in progress (HCOPY) or hardcopy fault (HCDEF)
- 11 - Panel number (KBD1 or KBD2) in multi-panel configuration, number of active CNC (between CN1 and CN4) in multi-CNC configuration or system fault (PRSOV)
- 12 - Display unit: millimetres (mm) or inches (inch)
- 13 - End of part programme (M02), programmed stop (M00), reset (momentary display of RESET) or current cycle (INCYC)
- 14 - Axis recall (AXRCL flashing) or manual override (INTER flashing)
- 15 - Optional stop (M01) enabled
- 16 - Selected JOG increment (.001 to 10000, FREE or HANDWH)
- 17 - Standby mode

Special Case of the Compact Panel

The status window displayed on a compact panel is somewhat different from the standard status window:

- It includes a field indicating the name of the axis controlled by the jogs, followed by the group number in multigroup systems
- It includes fields with indicators for the programmable function keys (lit if the function is active).



- 1 - LEDs for the shifted programmable function keys
- 2 - LEDs for the programmable function keys
- 3 - Axis name followed by group number



3.1.4 Softkeys

The softkeys of the compact panel differ from those of the other CNC panels. Since the compact panel has fewer keys, certain keys of the CNC panels are replaced by softkeys (see the sections "Special Case of the Compact Panel").

These softkeys are accessible in special softkey bars of the compact panel:

- The root softkey bar gives access to the Mode, Jog, Tool and Character softkeys
- The first Jog softkey bar is used to select the axis controlled by the jogs
- The two Mode softkey bars, the Tool softkey bar and the second Jog softkey bar (only Jog softkey bar on CNC panels) are different
- The Character softkey bars allow entry of characters not available on the compact panel keyboard.

3.1.4.1 Root Softkey Bar (Compact Panel)

The Root softkey bar on the compact panel provides the functions accessible on other CNC panels by the  ,  and  keys as well as giving access to the character keybars.

To display the Root softkeys, press the context key .



To return to the basic softkeys, press  again.

3.1.4.2 Basic Softkeys



These softkeys are displayed when none of the following softkeys have been selected:

- Mode softkeys,
- JOG softkeys,
- Tool softkeys.

To return to the basic softkeys, press the selection key of the softkey bar displayed (Mode, Jog or Tool) or, with the QWERTY keyboard, press the  key.

3.1.4.3 Mode Softkeys

Access the start of these softkeys by pressing .



Access the following functions by pressing  or .





Once a mode has been selected, the basic softkeys are redisplayed.

REMARK *The modes can be cancelled individually by PLC programming (see Automatic Control Function Programming Manuals). In this case, the corresponding softkeys are not displayed.*

Special case of the Compact Panel: Mode Softkeys

Access the first Mode softkeys by pressing the  key of the Root softkey bar.



Access the second Mode softkeys by pressing the  key (F12) or the Next key .



Return to the first Mode softkeys by pressing  (F12) or the Next key .

Return to the Root softkeys by pressing  (F1).

3.1.4.4 JOG Softkeys

Access these softkeys by pressing .



REMARK *The increments can be cancelled individually by PLC programming (see Automatic Control Function Programming Manuals). In this case, the corresponding softkeys are not displayed.*

Special Case of the Compact Panel: Jog Softkeys

Access the first Jog softkeys by pressing the  key of the Root softkey bar.



Names of the axes declared in P9

The first Jog softkeys contain the names of the first axes (maximum 6) declared in machine parameter P9. They are used to select the axis to be controlled by the jogs.

In multigroup systems, the axis name is followed by the group number declared in P9:

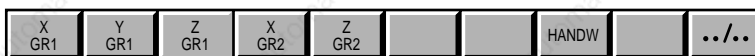

Access the second Jog softkeys by pressing  (F12) or the Next key .



Return to the first Jog softkeys by pressing  (F12) or the Next key .

Return to the Root softkeys by pressing  (F1).

3.1.4.5 Tool Softkeys

Access these softkeys by pressing .

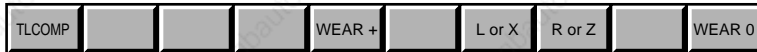

Special Case of the Compact Panel: Tool Softkeys

Access the Tool softkeys by pressing the  key of the Root softkey bar.

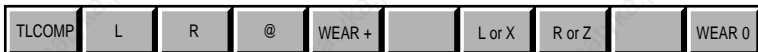

The tool softkeys contain the characters L, R and @.

Return to the Root softkeys by pressing  (F1).

3.1.4.6 Character Softkeys of the Compact Panel

Use of these softkeys on the compact panel should be exceptional. It is preferable to connect a standard PC keyboard.

Access the first Character softkeys by pressing the  key of the Root softkey bar.



Access the second softkeys by pressing  (F12).



Access the third softkeys by pressing  (F12).



The symbol $\hat{\text{I}}$ represents a caret.

Return to the first softkeys by pressing  (F12). Return to the Root softkeys by pressing  (F1).

3.1.5 Modal Data Window

The modal data window displays information concerning the programme being executed:

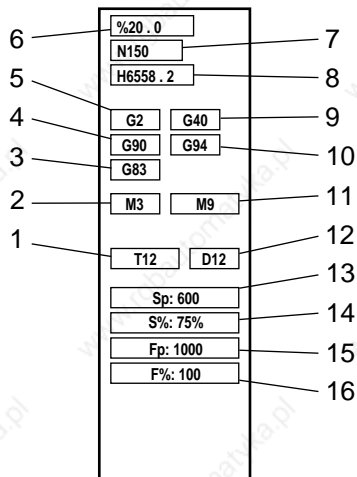

- 1 - Tool number
- 2 - Spindle rotation direction (M3 or M4), spindle off (M5) or spindle indexing (M19)
- 3 - Current cycle (G31, G45, G81 to G89)
- 4 - Programming of movements in absolute (G90) or relative (G91) dimensions
- 5 - Programmed interpolation function (G0 to G3)
- 6 - Current programme
- 7 - Current block
- 8 - Active subroutine
- 9 - Radius offset (G41 or G42) or radius offset cancel (G40)
- 10 - Feed rate in V/D (G93), in mm/min (G94) or mm/rev (G95)
- 11 - Programmed coolant (M7, M8 or M7M8) or coolant off (M9)
- 12 - Tool correction
- 13 - Programmed spindle speed
- 14 - Spindle speed override percentage set on the spindle speed potentiometer
- 15 - Programmed feed rate
- 16 - Feed rate override percentage set on the feed rate potentiometer

On certain screens, the modal data window may include different data. This is the case for simulated machining (see 4.6.2) and use of the PROFIL function (see 5.7.2).

3.2 Interactions Between Mode Selections and Display Pages

3.2.1 Neutral Mode

When the CNC is switched on, no mode is active and the "current mode" field of the status window is not displayed: the CNC is in neutral mode.

The alphanumeric keyboard is inactivated.

3.2.2 Interactions between Modes

When a mode is selected from the Mode softkeys, its name is automatically displayed in the "current mode" field of the status window (assuming that the selection is authorised by the machine processor).

Two modes cannot be active at the same time:

- when no cycle is in progress (indicator "M02" displayed in the status window), each time a mode is selected, it replaces the previous selection,
- when a cycle is in progress (indicator "INCYC" displayed in the status window), each time a new mode is selected, its name is displayed in the "standby mode" field.

When a mode is on standby, it is activated:

- at the end of a cycle for all modes except automatic mode,
- at the end of a block for automatic mode (or at the end of a cycle if the block being executed comprises a canned machining cycle such as G31 or G81).

3.2.3 Interactions between Modes and Display Pages

When a display page is selected from the basic softkeys, this page is displayed in the main window.

Changing pages returns the CNC to neutral mode in the following cases:

- if the CNC is in edit or origin shift mode (SHIFTS)
- if the CNC is in loading or unloading mode but not in progress

When the system is in edit mode and a new mode (other than homing, loading and unloading) is selected, the "current position" page is displayed.

Irrrespective of which mode is active, when the:

- edit mode is selected, the active programme is displayed,
- homing mode is selected, the SHIFTS page is displayed,
- loading mode is selected, the "FILE LOADING" menu is displayed,
- unloading mode is selected, the "FILE UNLOADING" menu is displayed unless the CNC is in graphic display mode.

3.3 Available Controls and Indicators

3.3.1 Keyboard Keys

3.3.1.1 Special Features of the 50-Key Panel Keyboard

On the alphanumeric keyboard of the 50-key panel:

- the main character on the key can be accessed directly,
- the character in the top right-hand corner of the key is accessed by pressing the shift key together with the key,
- the character in the bottom right-hand corner of the key is accessed by pressing the control key together with the key.

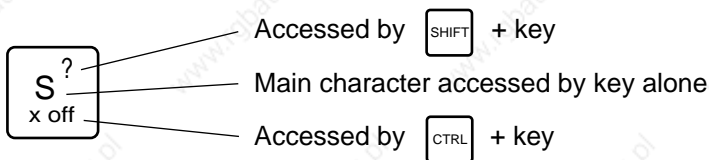

Adaptation of the Procedures

The procedures described herein are based on the use of the QWERTY panel.

When using the 50-key panels, these procedures should be adapted by using the shift or control key combinations where necessary.

Example

The following line of a procedure:

Confirm password removal.   

Adapted as follows for use on the 50-key panel:

Confirm password removal.   +  

Deleting the dialogue line

On 50-key panels, the dialogue line is deleted by the key combination  + .

3.3.1.2 Special Features of the Compact Panel Keyboard

The compact panel keys are different from those of the other CNC panels. They include keys corresponding to machine panel functions. In addition to the 12 horizontal function keys, there are four vertical function keys.

For the machine panel keys, five programmable keys are assigned to functions managed by the PLC programme (see 3.3.1.7).

Substitution of Characters Not Available on the Compact Panel

To make a positive answer to a question:

Answer Y(es).

When an action requires the use of the Xoff character,

On the 102-key keyboard, enter the key combination Ctrl + S,

3.3.1.3 Special Keyboard Keys



Escape key (QWERTY panel, not used).



Key to access previous softkeys (50-key panel).



Key to access next softkeys (only used for the Mode softkeys which are displayed in two parts).



Control key: access to special characters (Xoff) and, on 50-key panels, to the characters engraved in the bottom right-hand corner of the keys.



SHIFT key, held depressed to:

- access upper case characters and the second character on certain keys (QWERTY panel),
- access the characters in the top right-hand corner of the keys (50-key panel).



Enter key of the QWERTY panel (equivalent to the Valid key): confirms the dialogue line or selection in a menu.



Enter key of the 50-key panel: confirms the dialogue line or selection in a menu.



Upper/lower case key (QWERTY panel).



Key used to delete current line (QWERTY panel).



Key used to delete previous character.



Alt key used on the PCNC (QWERTY panel).



Tab key used on the PCNC (QWERTY panel).



Shift key: hold this key depressed to use the characters engraved in the top right-hand corner of the character keys and the second function of the programmable function keys (compact panel).



Escape key (compact panel).



Help key: press to display the remaining error messages (compact panel).



Context key, used to:

- Return to the basic softkeys (QWERTY panel)
- Toggle between contexts (50-key panel)
- Return to the Root softkeys (compact panel).



Context selection keys: gives access to the contexts defined with MMITool.



Key to access previous softkeys (compact panel).



Key to access next softkeys (compact panel).

3.3.1.4 Special Control keys



Page Down key (equivalent to the software "page down" key): used to display the next part of the page on screen (QWERTY panel).



PageDown key (equivalent to the ".../..." softkey): used to display the next part of the page (50-key panel).



Page Up key (QWERTY panel).



Page Up key (50-key panel).



Start of file key (QWERTY panel, not used).



End of file key (QWERTY panel, not used).



Cursor key used to move up one line.



Cursor key used to move down one line.



Cursor key used to move one character to the right.



Cursor key used to move one character to the left.



Validation key (QWERTY panel, equivalent to the Enter key).



Help key gives access to the other error messages.



Overtyping/insert text mode key.



Delete selected character key.



Key to delete the character selected (compact panel).



Insert/overwrite toggle key (compact panel).



Start of file key (compact panel).



End of file key (compact panel).



Page up key (compact panel).



Page down key (compact panel).

3.3.1.5 Mode Selection Keys



Mode key: used to display the "Mode" softkeys and then exit.



Tool key: used to display the "Tool" softkeys and then exit (See 5.2.2).



JOG key: used to display the "JOG" softkeys and then exit (See 5.1.1).



Block skip: enables block skips "/" (QWERTY panel, See 5.4.3.1).



Optional stop key: enables "M01" optional stops (QWERTY panel, See 5.4.3.1).

3.3.1.6 Reset Key



Reset key (See 5.5.1.8).

3.3.1.7 Machine Panel Function Keys on the Compact Panel

These five keys are specific to the compact panel. They are programmable and can be assigned to functions managed by the PLC programme.



Rapid jog key: When this key is depressed, the jog keys move the axis selected at high speed.



Negative jog key: When this key is depressed, the jog keys move the axis selected in the negative direction.



Positive jog key: When this key is depressed, the jog keys move the axis selected in the positive direction.



Cycle key: This key starts execution of the active programme or a block in MDI mode.



Feed stop key: This key suspends execution of the active programme.

3.3.2 Softkeys

The softkeys are activated using function keys F2 to F11 located below them.

3.3.2.1 Root Softkeys (Compact Panel)

Compact panel selection keys:

- | | |
|------|--|
| MODE | MODE key: gives access to the first Mode softkeys. |
| TOOL | TOOL key: gives access to the Tool softkeys. |
| JOG | JOG key: gives access to the first Jog softkeys. |

3.3.2.2 Basic Softkey Functions

Display page selection:

- | | |
|---------------|---|
| .. / .
DAT | - Page down (equivalent to the "Pg Dn" key on the keyboard).
- Shifts page (option available by pressing Shift): shift display page (See 4.3). |
| DIR. | List of stored programmes (See 4.5). |
| PROG. | Programme being executed (See 4.8). |
| INFO. | Summary of information on block (See 4.7). |
| L / @ | List of programme variables (See 4.9.1) and equivalent addresses (See 4.9.2). |
| AXIS | Current point coordinates (See 4.2). |
| TOOLS | List of tool dimensions and wear offsets (See 4.4). |
| BKGND | Graphic display (See 4.6), PROCAM (See 5.7.1) and background programme operations (See 5.9). |
| PLC
I/O | Machine and PLC data: inputs/outputs (See 4.10). |
| UTIL | Access to utilities (See 8.2.2). |

3.3.2.3 Mode Softkey Functions

Mode selection:

AUTO	Automatic mode: execution of part programme with automatic sequencing of blocks (See 5.4.3.5).
SINGLE	Single step mode: execution of part programme block by block (See 5.4.3.3).
MDI	Manual Data Input mode: manual input of a block without it being stored (See 5.3).
DRYRUN	Dry run mode: execution of part programme in dry run mode (See 5.4.3.4).
SEARCH	Sequence Number Search mode: the programme restarts at block N.. (See 5.5.1.3).
EDIT	Edit mode: modification of part programme (See 5.4.2).
TEST	Test mode: test of part programme under the operating conditions of the machine and system assembly (See 5.4.2.6).
MANUAL	Manual mode: axes moved using axis jogs or handwheels selected by the PLC (See 5.1.1.2).
HOME	Measurement origin setting mode: acquisition of measurement origins by the system (See 5.1.2).
SHIFTS	Origin shift mode: entry of origin shifts (DAT1, DAT2 and DAT3) and scaling factor (See 5.2.1).
TL SET	Automatic tool setting mode: acquisition of tool dimensions by the system (See 5.2.2).
LOAD	Load mode: loading of part programmes (See 5.4.1) or tool dimensions (See 5.2.2.3) and selection of active programme (See 5.4.1.2).
UNLOAD	Unload mode: unloading of part programmes or tool dimensions (See 5.6).

3.3.2.4 JOG Softkey Functions

Selection of jog type:

HANDW Axis jog using handwheel.

.001 **.01** **.1** **1** **10** **100** **1000** **10000**

Jog in increments of 0.001 to 10,000 μm .

FREE Continuous axis jog using push-buttons.

3.3.2.5 Tool Softkey Functions

Modification of tool dimensions and wear offsets:

TLCOMP Input of tool dimensions via the keyboard (See 5.2.2.2).

WEAR + Input of tool wear offsets (See 5.2.2.4).

L or X Wear offset on length L (milling) or on the dimension along the X axis (turning).

R or Z Wear offset on radius R (milling) or on the dimension along the Z axis (turning).

WEAR 0 Wear offset cancel (See 5.2.2.4).

Special Case of the Compact Panel: Functions of the Tool Softkeys

The Tool softkeys contain the symbols L, R and @ for entry of tool offsets.

3.4 Special Keyboard Operations

3.4.1 Hardcopy

The contents of the CNC screen can be output on a printer or in a file according to the parameter settings of the CNC.

3.4.1.1 Hardcopy on Printer

This function allows output on a printer at any time of the contents of the CNC screen.

Requirements

Connecting cable connected between the printer and a configured serial port of the CNC (see C.2.4).

On the printer side

Printer configured and ready to receive data (see printer manual).

On the CNC side

CNC on.

Machine parameter P59 (word N0) set for the type of print (see Parameter Manual): black and white print N0=1, printing with grey levels N0=2, colour print N0=3.

REMARK *It is necessary to reboot the system after modifying machine parameter P59.*

Image to be hardcopied displayed on the screen.

Actions

On the CNC side

Print screen contents.



The current screen page is stored and the hardcopy indicator is displayed in the status window (See 3.1.3).

The screen page is printed.

REMARK *This printing function does not prevent normal operation of the CNC.*

Incidents

When a printing fault occurs (printer incorrectly configured, faulty connection, etc.), the hardcopy indicator is replaced by the hardcopy fault indicator and data transmission is interrupted.

Correct the printing fault.

Display of the hardcopy indicator in place of the hardcopy fault indicator.

The page is printed.

Exit from the procedure

Cancel the hardcopy.



The hardcopy (or hardcopy fault) indicator disappears from the screen.

3.4.1.2 Hardcopy in File

This function outputs all or part of the image displayed on the screen into a bitmap file (HARDCOPY.BMP). This type of hardcopy requires availability of NUM software tools for PC.

Requirements

Connecting cable connected between the PC serial port and a serial port of the CNC.

On the PC side

Line configured (see PLCTool - Ladder Language Programming Tool manual).

PLCTool running, presence of a group designed to receive the hardcopies and a bitmap file called HARDCOPY.BMP.

On the CNC side

System on.

Machine parameter P59 set for output of the hardcopy into a file (word N0=0) (see Parameter Manual).

Machine parameter P112 set to assign the CNC serial line to the PLCTool link (see Parameter Manual).

REMARK *It is necessary to reboot the system after modifying the machine parameter settings.*

PLCTool line selected (see Machine Processor Programming in Ladder Language manual).

Image to be hardcopied displayed on the screen.













Actions

On the CNC side

Select hardcopy. 

Display of the full screen selection area and summary of the main functions at the bottom of the area: HARDCOPY.BMP: (DIM=F1, Sav=CR, Abort=ESC).

Change the selection if required (see table below).

Operations	Key
Select reduced area or full screen Reduced area = 120x80 pixels; full screen = 640x480 pixels	 End or  Home
Move the selection: left, right, up, down	 ← or  → or  ↑ or  ↓
Enlarge the selection: left, right, up, down	 SHIFT +  ← or  → or  ↑ or  ↓
Cancel hardcopy	 ESC

Save the selection. 

REMARK *The hardcopy is saved until it is retrieved via the PLCTool link.*

On the PC side

Select the HARDCOPY.BMP target file.

Select the direction of transfer by the command NC -> PC.

Display of the dialogue box Download PC -> NC-PLC.

The hardcopy is downloaded by action on the Transmit key.

If the file already contains data, a message requests confirmation of overwrite of the old data.

If overwrite is accepted, the file is downloaded. Duplicate the file created by a copy/paste operation to avoid overwriting it by the next file sent.

3.4.2 Keyboard Sound

The operator panel keyboard beeps each time a key is pressed.

This sound function can be activated or deactivated.

Actions

Activate or deactivate the keyboard sound function.



3.4.3 Switching between Operator Panels

On CNCs with two to four panels, only one panel is active at a time (at power on, it is panel 1).

A switch can be made to another panel.

To prevent a panel from being accidentally deactivated from the inactive panel, the active panel can be locked by a password.

Requirements

Active panel indicated by panel number indicator (KBD1 or KBD2) in the status window (See 3.1.3).

Actions

Locking the active panel

Lock the active panel.



Enter a password (four characters maximum).



The active panel is locked and can only be deactivated by using the password.

Switching to an inactive panel

Request switchover at the inactive panel.



Enter the password (if any).



The switchover is executed. The panel number indicator is displayed in the status window of the newly activated panel and disappears from the other. The newly activated panel «beeps».

Notes

The password can be changed each time the active panel is locked.

Switchover cannot take place if dialogue is in progress on the active panel.

Incidents

Error in password entered on the inactive panel

Repeat the switchover operations on the inactive panel.

3.4.4 Switching between CNCs

On multi-CNC (two to four) systems, it must be possible to interrogate any one of the CNCs from the single operator panel.

Requirements

Active CNC indicated by the CNC number indicator (CN1 to CN4) in the status window (See 3.1.3).

Actions

Request CNC switching.



Enter the number of the CNC to be activated.



The switchover is executed. The active CNC number indicator is displayed in the status window of the operator panel and the panel beeps.

Notes

When the system is switched on, there is no password.

Switchover cannot take place if dialogue is in progress on the active CNC.

Incidents

Incorrect CNC number (exceeding the number of CNCs)

Repeat the switchover operations.

3.5 Use of a 102/105-Key Keyboard with the Compact Panel

A standard 102/105-key PC keyboard can be connected to the front of the compact panel (see 3.1.1.4) after removing the dust cap (or to the rear if the DIN connector was moved to the rear of the panel), for instance to enter or edit part programmes.

This keyboard should also be used for accessing the utilities. Press Ctrl + S to exit from the utilities.

CAUTION

A keyboard should only be connected exceptionally to the front panel, because removal of the dust cap breaks the panel seal. Move the connector to the rear of the panel if the keyboard is to remain permanently connected.

Three types of standard 102/105-key PC keyboards can be connected

AZERTY French keyboard

Specify the use of an AZERTY keyboard on the keyboard.



The configuration with AZERTY keyboard is saved in the system memory.

QWERTY English keyboard

Specify the use of a QWERTY keyboard on the keyboard.



The configuration with QWERTY keyboard is saved in the system memory.

QWERTZ German keyboard

Specify the use of a QWERTZ keyboard on the keyboard.



The configuration with QWERTZ keyboard is saved in the system memory.

CAUTION

The PC keyboard must have the following characteristics:

- Standard keyboard with 102 or 105 keys (excluding Compaq),
- Maximum power consumption: 150 mA,
- 5-contact DIN connector.

4 Display System Utilization

4.1	Inch/Metric Unit Conventions	4 - 3
4.2	Display of Tool Position	4 - 3
4.3	Display of Shifts	4 - 5
4.4	Display of Tool Data and Tool Corrections	4 - 6
4.5	Display of Programmes	4 - 8
	4.5.1 Access to the List of Programmes	4 - 9
	4.5.2 Access to the Listing of a Programme	4 - 10
	4.5.3 Access to a Programme Listing at a Given Sequence	4 - 11
4.6	Display of a Programme in Graphic Mode	4 - 12
	4.6.1 Selection of Graphic Display Parameters and Part Contour Trace	4 - 13
	4.6.1.1 Selection of Graphic Display Parameters	4 - 13
	4.6.1.2 Part Contour Trace	4 - 15
	4.6.1.3 Scaling of Display Planes	4 - 17
	4.6.2 Machining Simulation	4 - 18
	4.6.3 3D Display	4 - 21
	4.6.4 Trace during Cutting	4 - 26
	4.6.5 Selection of Graphic Display Parameters and Part Contour Trace in Mixed Machine Mode (MX)	4 - 29
	4.6.5.1 Selection of Graphic Display Parameters	4 - 29
	4.6.5.2 Part Contour Traces	4 - 31
4.7	Display of Active Data	4 - 33
4.8	Display of Programme-Being Executed	4 - 35
4.9	Display of Programme Variables and Equivalent Address Table	4 - 37
	4.9.1 Display of Programme Variables	4 - 37
	4.9.2 Display of Equivalent Address Table	4 - 38
4.10	Display of Inputs/Outputs	4 - 39
	4.10.1 Display of Operator Messages	4 - 40
	4.10.2 Display of External Parameters	4 - 42
	4.10.3 Display of PLC Memory Data	4 - 44
	4.10.4 Display of PLC User Screen	4 - 46
	4.10.5 Display of QVN Information	4 - 46
	4.10.6 Display of Ladder Animation	4 - 46
	4.10.7 Display of Wire Tap	4 - 46
4.11	Access to Maintenance Functions	4 - 47

4.1 Inch/Metric Unit Conventions

The system can be configured to display dimensions in either millimetre or inches (See 5.8).

The following display pages are presented using metric units.

4.2 Display of Tool Position

Requirements

Basic softkeys displayed.

Actions

Display the coordinates with respect to the programme origin (OP)

Select the page displaying the current position with respect to the programme origin (OP).



Display of the coordinates of the current point with respect to the programme origin (OP) (POSN. PROG):

GR1	POSN. PROG	TO GO	ERROR
X	+ 100.	+ 0.	+ 0
Y	+ 0.	+ 0.	+ 0
Z	- 10.253	- 9.747	+ 2525
B	+ 45.	+ 0.	+ 0

- 1 - Displayed axis group (axis multigroup systems)
- 2 - Axes displayed
- 3 - Following error in micrometres or ten-thousandths of a degree
- 4 - Distance between the current position and the programmed point in mm or degrees
- 5 - Current position with respect to the programme origin in mm or degrees

The coordinates are displayed on 8 digits. The number of decimal digits depends on the internal system unit.

Display of the coordinates with respect to the measurement origin (OM)

Select the page displaying the current position with respect to the OM.



AXIS

Display of the coordinates of the current position with respect to the measurement origin (OM).

Notes

The page displaying the current position with respect to OP is automatically called at power on.

Each time the  key is pressed, the display switches between the programme origin and the measurement origin.

Pressing the  key causes display of the coordinates on the duplicated and synchronised axes with respect to OP or OM.

Error during programme execution

The error number, the number of the block with the error and possibly the error message text are displayed in the dialogue window, e.g.:

error 159 block N10

Programme shift requested on an axis for which homing is not completed.

Display of a part programme message

The first 39 characters in the message are displayed on the first line (e.g. "PART FINISHING").

4.3 Display of Shifts

Requirements

Basic softkeys displayed.

Actions

Select the SHIFT page.



Display of shifts:

	SCALE: E	1000/1000				
	DAT1	DAT2		DAT3		
X	+ 126.452+	200.	+ 100.	*	}	
Y	- 503.267+	150.	+ 100.	*		
Z	- 42.871+	0.	+ 0.			
B	+ 0.	+ 0.	+ 0.			

--	--	--	--	--	--	--	--	--	--

- 1 - Scaling factor in thousandths of the programmed dimensions
- 2 - The asterisk indicates axes affected by turntable rotation (DAT3)
- 3 - Axes displayed
- 4 - Programme origin eccentricity (e.g. milling machines fitted with turntables)
- 5 - Programme origin shift
- 6 - Part origin shift

The dimensions are displayed in mm or degrees.

Notes

This page is called automatically by the homing mode (SHIFTS).

On axis multigroup systems, the first line displays the group number (e.g. GR1) and the rest of the page is shifted down by one line.

4.4 Display of Tool Data and Tool Corrections

Requirements

Basic softkeys displayed.

Actions

Display of tool dimensions

Select the "TOOL OFFSETS" page.



TOOLS

Display of tool data:

TOOL OFFSETS						
D 1	L+	254.635	R+	8.953	@+	0.
D 2	L+	195.457	R+	4.982	@+	0.5
D 3	L+	158.756	R+	4.003	@+	0.3
D 4	L+	228.95	R+	12.025	@+	1.2
D 5	L+	0.	R+	0.	@+	0.
D 6	L+	0.	R+	0.	@+	0.
D 7	L+	0.	R+	0.	@+	0.
D 8	L+	0.	R+	0.	@+	0.
D 9	L+	0.	R+	0.	@+	0.
D 10	L+	0.	R+	0.	@+	0.
D 11	L+	0.	R+	0.	@+	0.
D 12	L+	0.	R+	0.	@+	0.
D 13	L+	0.	R+	0.	@+	0.
D 14	L+	0.	R+	0.	@+	0.
D 15	L+	0.	R+	0.	@+	0.

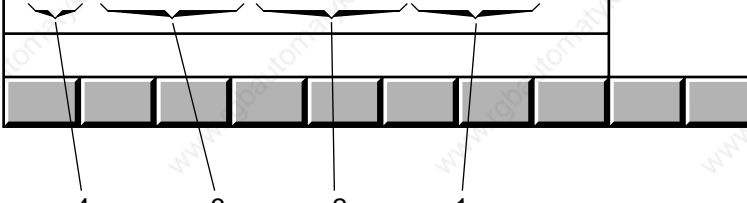

- 1 - Cutter tip radius
- 2 - Tool radius
- 3 - Tool length
- 4 - Correction number

The tool data are expressed in mm.

Display of tool wear offsets

Select the tool wear offset page.



TOOLS

Display of tool wear offset values:

TOOL WEAR OFFSETS							
D	1	DL+	4.356	DR+	0.12	H+	4
D	2	DL+	1.252	DR+	2.952	H+	1458
D	3	DL+	0.117	DR+	0.45	H-	579
D	4	DL+	0.64	DR+	0.138	H+	
D	5	DL+	0.	DR+	0.	H+	
D	6	DL+	0.	DR+	0.	H+	4508
D	7	DL+	0.	DR+	0.	H-	46270
D	8	DL+	0.	DR+	0.	H+	
D	9	DL+	0.	DR+	0.	H+	
D	10	DL+	0.	DR+	0.	H+	
D	11	DL+	0.	DR+	0.	H+	
D	12	DL+	0.	DR+	0.	H+	1567
D	13	DL+	0.	DR+	0.	H-	76365
D	14	DL+	0.	DR+	0.	H+	
D	15	DL+	0.	DR+	0.	H+	

- 1 - Radius wear offset
- 2 - Tool length wear offset
- 3 - Correction number

The corrections are expressed in mm.

The variables (H) displayed in the final column can be modified by programming. They can be used to manage tool wear for example, but can also be assigned to any variables the programmer wishes to use.

Pressing the **TOOLS** key a third time displays tool geometries not used for milling.

To display another page of tool dimensions or wear offsets

Page to be displayed	Press
Next page of tool dimensions or wear offsets	Pg Dn or ./././ DAT
Previous page of tool dimensions or wear offsets	Pg Up
Last page of tool dimensions or wear offsets	End
First page of tool dimensions or wear offsets	Home

Notes

The tool data page is automatically displayed when a tool wear offset is entered.

When the last tool correction page is displayed, pressing **./././ DAT** (or **Pg Dn**) displays the first page.

4.5.1 Access to the List of Programmes

The RAM comprises four areas (See 8.8):

- area 0 or user area,
- protected areas 1 (client), 2 (OEM) and 3 (NUM).

Requirements

Dialogue line "(&n)%% OR %..N..) █" displayed (See 4.5).

Actions

Type "%%".  

Display of start of list of programmes in RAM (area 0):

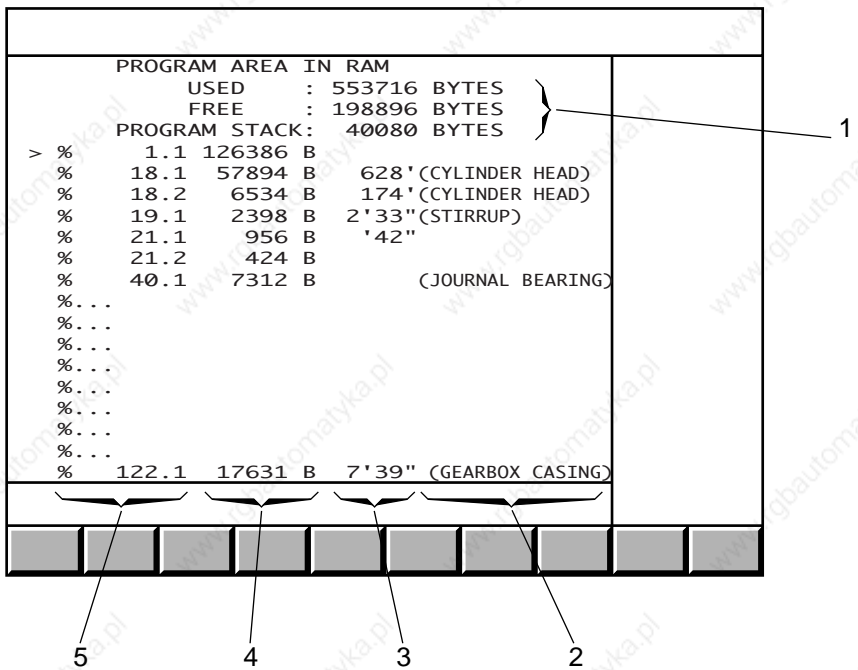



- 1 - RAM allocation
- 2 - Start of programme comment (13 characters)
- 3 - Execution time of tested programmes (excluding timeouts, maximum displayable time: 1092 min)
- 4 - Programme size in bytes
- 5 - Programme number (the figure following the dot indicates the axis group number to which the programme is assigned)

Display the next page of the list.  

Display of the rest of the list of programmes, then display of the beginning of each programme.

Access to the list of programmes in protected areas

Dialogue line "(&n)%% OR %..N..) █" displayed.

Enter "&[Area number]%%" (e.g. "&1%%" for area 1).  







Display of the start of the list of programmes in the area specified, indication of the area number (&1 for area 1, etc.) in the title bar of the page and on the information line of each programme.

4.5.2 Access to the Listing of a Programme

Requirements

A programme listing can be obtained from the dialogue line "(&n)(%% OR %..N..) █" or from the list of programmes displayed.

Actions







Dialogue line displayed (See 4.5)	List of programmes displayed (See 4.5.1)
Enter "%[Programme number]"  	Move the cursor select the programme   or  Display the programme  
Display of the beginning of the programme	Display of the beginning of the programme and the dialogue line "(&n)(%% OR %..N..) █"

Display the next page of the programme.



The dialogue line is cleared and the next page of the programme is displayed.

Access to the listing of a programme in a protected area

Dialogue line displayed (See 4.5)	List of programmes in a protected area displayed (See 4.5.1)
Enter "&[Area number]%" [Programme number]"  	Move the cursor to select the programme   or  Display the programme  
Display of the beginning of the programme. The programme number is preceded by "&n".	Display of the beginning of the programme and the dialogue line "(&n)(%% OR %..N..) █" the programme number is preceded by "&n"

REMARKS Programmes in protected areas may be locked (See 8.8.3), in which case only the programme number is displayed.

When a request is made to display a programme using the list of programmes in a protected area, the programme with the same number in the lowest area will be displayed. For example, using the list of programmes in area 3, if the cursor is placed opposite programme number &3%1.2, programme %1.2 of area 1 will be displayed if it exists in this area and not in area 0.

Incidents

If the programme cannot be found in the memory, the message "PROGRAMME DOES NOT EXIST" is displayed in the dialogue line.





Select another display page.

4.5.3 Access to a Programme Listing at a Given Sequence

Requirements

The listing of a programme from a given block number can be obtained by the dialogue line "&n)(%% OR %..N..) █" displayed or from the programme and the dialogue line displayed.

Actions

Dialogue line displayed (See 4.5)	Programme and dialogue line displayed (See 4.5.2)
Enter "%[Programme number] N [Block number]" (or "&[Area number]%[Programme number] N [Block number]")  	Enter "N [Block number]"  

Display of the programme from the specified block.

Display the next part of the programme.  

Display of the next part of the programme.

Incidents

If the sequence cannot be found, the message "BLOCK DOES NOT EXIST" is displayed in the dialogue line.

Select another display page.

4.6 Display of a Programme in Graphic Mode

Requirements

Basic softkeys displayed.

Actions

Select the "GRAPHIC - PROGRAMMING" menu.



Display of the "GRAPHIC- PROGRAMMING" menu:

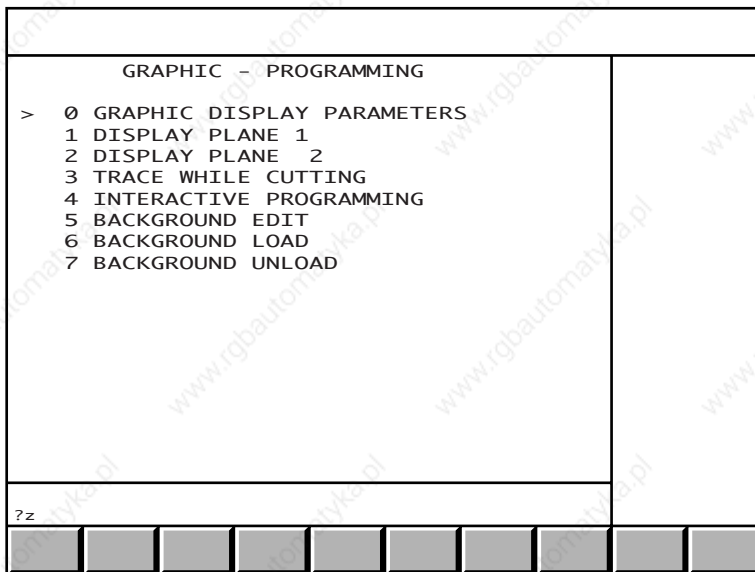

Menu items 4 to 7 can be inhibited by a PLC programme.

To select an item, move the cursor onto the item with the up and down arrow keys or enter the item number then press .

The procedure given below illustrates the functions available in graphic display mode.

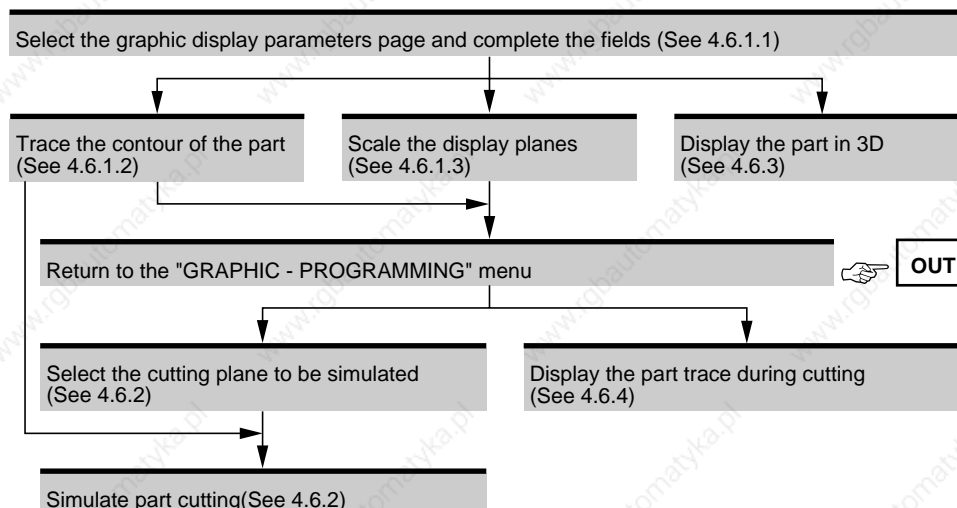

4.6.1 Selection of Graphic Display Parameters and Part Contour Trace

4.6.1.1 Selection of Graphic Display Parameters

Requirements

"GRAPHIC - PROGRAMMING" menu displayed (See 4.6).

Actions

Select "GRAPHIC DISPLAY PARAMETERS".   

Display of the graphic display parameters page:

Program	PLANE 1	X-Y
	Min.	Max.
	+0.	-+0.
	+0.	-+0.
Block	PLANE 2 from:	BELOW
	Min.	Max.
	+0.	-+0.
	+0.	-+0.
	3D MODEL	TRACE PLANE 1
	TRACE PLANE 2	SCALE 1+2
		EXIT

Use the arrow keys to move the cursor to the fields to be completed.

When the following fields are selected, the corresponding softkeys are displayed:

















- field "PLANE 1",

X-Y	Y-Z	Z-X
-----	-----	-----

- field "PLANE 2".

LEFT	RIGHT	ABOVE	BELOW
------	-------	-------	-------

Complete the fields (See table below).

Operation to be performed	Field selected (flashing)	Command
Select the programme to be displayed (mandatory)	Programme (default field)	[Programme number]  
Select the first and last blocks of the sequences to be displayed	Block field	[Block number]  
Select the 1st display plane	PLANE 1 (X-Y by default)	   or 
Select the 2nd display plane	PLANE 2 (from BELOW by default)	    or 
Enter the screen sizes for planes 1 and 2	Min. or Max. fields of axes to be shown	[Limit value on axis]   <i>Remark: the screen sizes are recalculated during part contour tracing (See 4.6.1.2) or automatic scaling of display planes (See 4.6.1.3)</i>
Delete field contents	Field to be cleared	 

4.6.1.2 Part Contour Trace

Requirements

Graphic display parameters page displayed.

Programme to be displayed selected (See 4.6.1.1).

Actions

Select the plane trace.  TRACE PLANE 1 or TRACE PLANE 2

Automatic scaling of selected plane.

Display of the tool path trace:

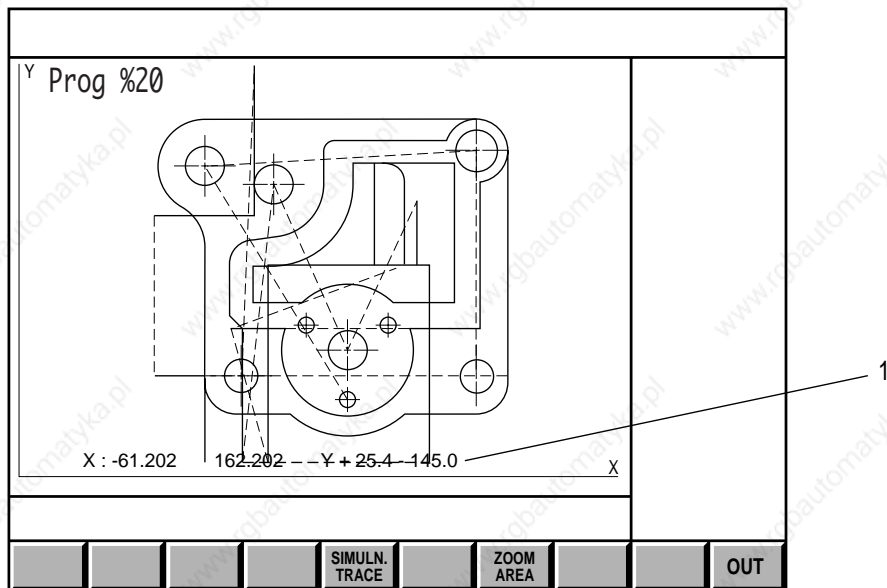

4



1 - Screen sizing

The tool path trace softkeys allow access to the machining simulation function (See 4.6.2).

The tool paths are drawn:

- as broken lines for rapid movements in function G00,
- as unbroken lines for feed movements in functions G01, G02 and G03.

The cycles are represented by the following symbols proportional to the dimensions of the tool correction used:

Drilling function G81 or G82	
Peck drilling function G83 or drilling with chip breaking function G87	
Tapping function G84	
Boring functions G85, G86, G88 or G89	

Enlargement of a trace detail

Select the ZOOM mode



Display of the tool path trace in ZOOM mode:

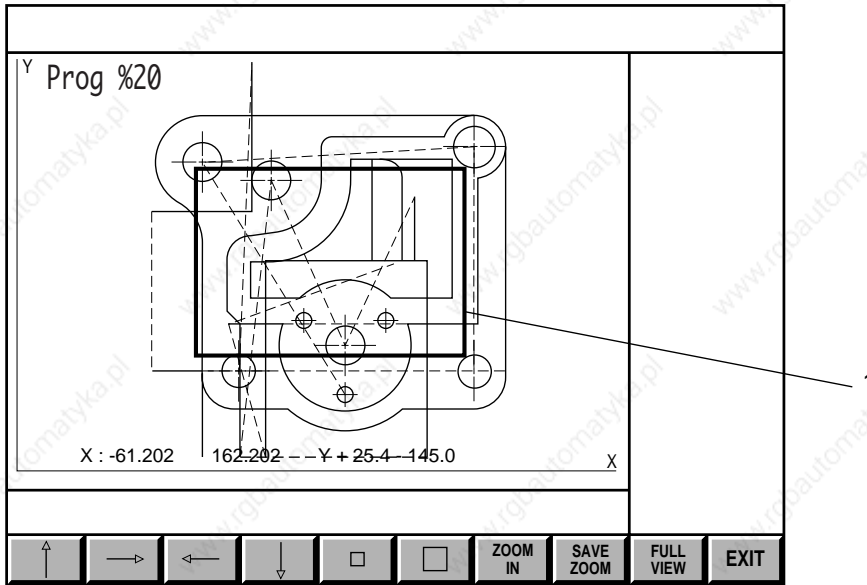

1 - ZOOM window

Change the window to the size required for the detail to be displayed.



Move the window over the area to be enlarged with the softkeys or keyboard keys.

Zoom in.



Validate the zoom.



Display of the enlarged tool path trace.

Several consecutive enlargements can be made.

Exit from the procedure

Cancellation of the current enlargement

During the enlargement procedure (before validation), it is possible to return to the initial scaling factor:

Cancel the ZOOM mode.



Return to initial tool path trace.

Return to graphic display parameters page





Return to the graphic display parameters page.



Return to the graphic display parameters page and display of minimum and maximum plane dimensions.

Incidents

A variety of incidents may occur, indicated by one of the following messages:

Message	Cause	Action
Programme number not found	The specified programme does not exist in the memory	Acknowledge the message  Any character Select another programme
Block number not found	One of the selected blocks does not exist	Acknowledge the message  Any character Select another block
Scaling not possible, one axis is not programmed	No movement on one of the plane axes	Acknowledge the message  Any character Select another plane or correct the programme (See 5.4.2.2)
error xxx block Nyyy Error text	Programming error	Exit the display  EXIT Correct the programme (See 5.4.2.2)

4

4.6.1.3 Scaling of Display Planes

Requirements

Graphic display parameters page displayed.

Programme to be displayed selected (See 4.6.1.1).

Actions



Select the scaling function for both planes of the part.  SCALE
1+2

Scaling of both planes (similar to 4.6.1.2, but no display, therefore quicker).

The minimum and maximum dimensions of the two planes are displayed in the graphic display parameters page.

Incidents

A variety of incidents may occur, indicated by one of the following messages:

Message	Cause	Action
Programme number not found	The specified programme does not exist in the memory	Acknowledge the message  Any character Select another programme
Block number not found	One of the selected blocks does not exist	Acknowledge the message  Any character Select another block

4.6.2 Machining Simulation

Machining simulation is used to visually check that the programme runs as expected (part dimensions and sequencing of operations).

Simulated machining is based on real machining performed by the CNC in automatic (See 5.4.3.5) and single step modes (See 5.4.3.3), but no real axis motion takes place.

Programmed interventions (M00, M12, data input, etc.) are not taken into account during simulation.

External parameters (E) are not modified during simulation.

Requirements

"GRAPHIC - PROGRAMMING" menu displayed (See 4.6).

Scaling of part (See 4.6.1).

Actions

Select plane 1.



or

Select plane 2.



Display of the tool path trace (same as trace obtained via the graphic display parameters page (See 4.6.1.2)).

REMARKS *If manual scaling is the only operation to have been performed (See 4.6.1.1), the scaled area is displayed without any trace.*

The next part of the procedure can also be accessed using the tool path trace function in the graphic display parameters page (See 4.6.1.2).

If required, use the ZOOM function to enlarge a path detail. (See 4.6.1.2).







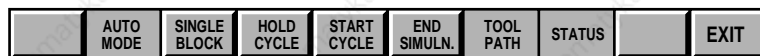

Select the simulation function.



Display of the current position coordinates in the modal data window and the simulated machining softkeys:



Perform the desired operations (See table below).

Operation to be performed	Softkey	Real machining equivalent
Select automatic mode (mode key depressed)		Automatic mode
Select single step mode (mode key depressed)		Single step mode
Execute machining simulation (programme executed up to M02 in automatic mode or one block executed in single mode)		"CYCLE" button on machine panel
Interrupt simulation (restart via "CYCLE")		"FEED STOP" button on machine panel
Stop simulation and reset		
Interrupt or restart tool path trace (trace function active when key displayed in inverse video)		
Clear or display current position coordinates (display enabled when key is depressed)		

4

Display of tool paths

Select the simulation function.



Display of the tool path trace in simulation mode:

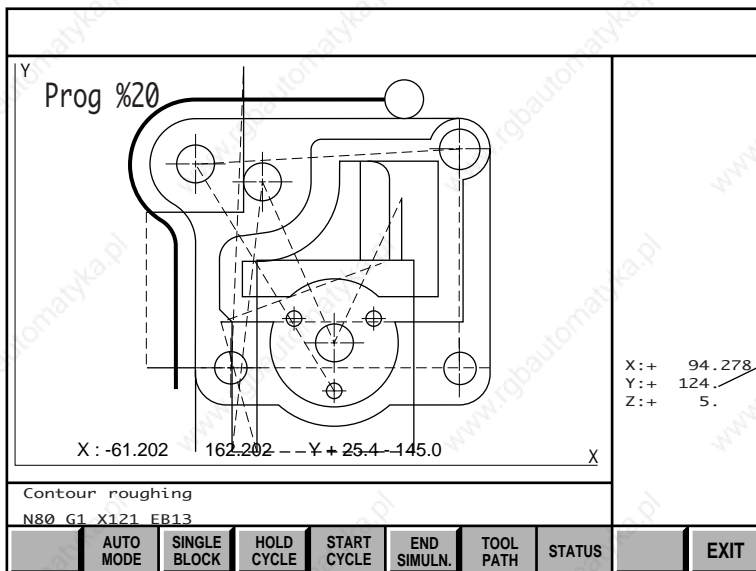

1 - Current position coordinates

Display of tool paths.

Without radius correction (G40), the tools are represented by a cross.

With radius correction (G41 or G42), the tools are represented by the following symbols appropriate to the dimensions of the tool correction used:

Cylindrical cutter	
Toroidal cutter	
Spherical cutter	

Exit from the simulation function

Cancel simulation.



EXIT

EXIT

Return to "GRAPHIC - PROGRAMMING" menu (or graphic display parameters page).

4.6.3 3D Display

The 3D display shows parts in isometric projection.

It is used to:

- visually check the shape of a part (or section of a part) from different angles using a rotation function,
- display details in cross-section.

The 3D display function can display cross-sections of a part in isometric projection.

In order to use the 3D display function, a rectangular block corresponding to the blank must first be declared in the programme (See Programming manual). Reminder: the rectangular block is declared using the following syntax: "EM+ X.. Y.. Z.. EM- X.. Y.. Z.." (the dimensions after EM+ are the maximum dimensions of the parallelepiped and the dimensions after EM- are the minimum dimensions).

Only simple-shaped cutters are used (cylindrical, toroid or spherical and drills).

Requirements

Graphic display parameters page displayed and programme selected.

Declaration of blank in the programme.

Tool data declared in the tool correction table.

Actions

Select the 3D display function. 

Display of the 3D display selection softkeys at the bottom of the screen:

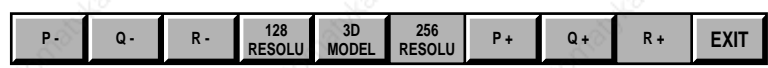

Select the desired resolution (default value: 256). 

The softkey corresponding to the desired resolution is depressed. The resolution of 256 provides higher precision during the trace functions than the resolution of 128 but requires more processing time.

Select the tool orientation (See diagram) used in the programme (default setting: R+).

The softkey corresponding to the tool orientation is depressed.

In a programme, the tool orientation is defined by the arguments of function G16 (See Programming manual).

The diagram opposite summarises the tool orientations and associated arguments of G16.

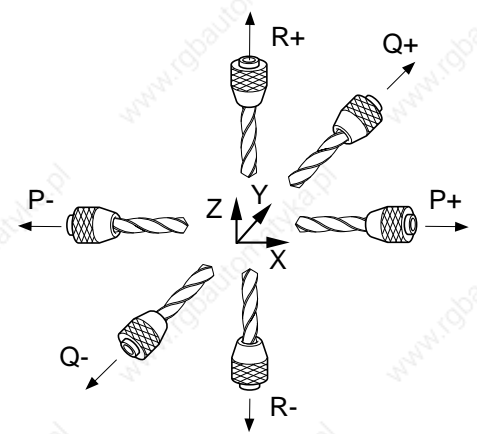

Execute the 3D function.

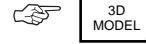

The system computes the 3D model of the part, displays the message "Calculating geometric model" and the programme blocks currently being processed.

Once calculation is complete, the page is displayed in 3D with the part represented in isometric projection:

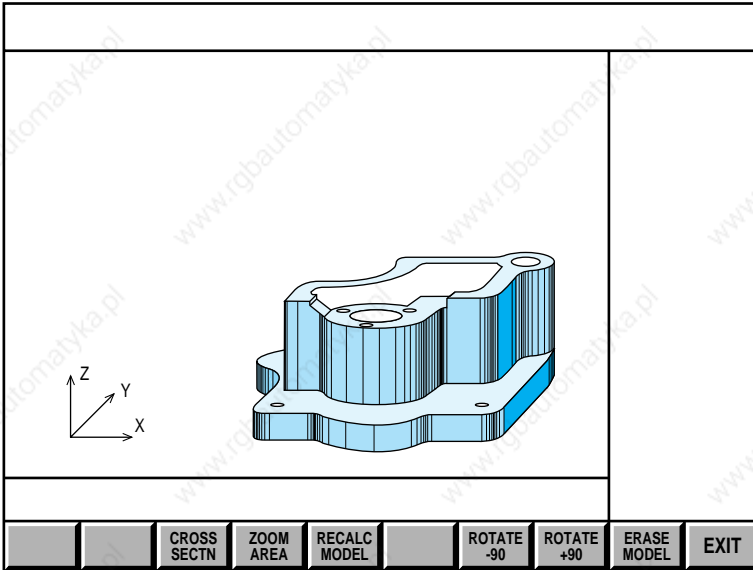

REMARK

When a 3D model of the part has already been produced in the same conditions (same resolution and tool orientation), the system does not repeat the calculation. It simply redisplayes the part stored in memory (even if the part programme has been modified).

Select the desired options (See table below).

Option	Softkey
Recalculate the 3D model of the part (when the part programme has been modified between two 3D displays of the part)	
Rotate the part about a vertical axis	OR

Display of cross-sections of the part

Select the cross-section function.

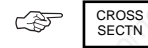

Display of the cross-section page:

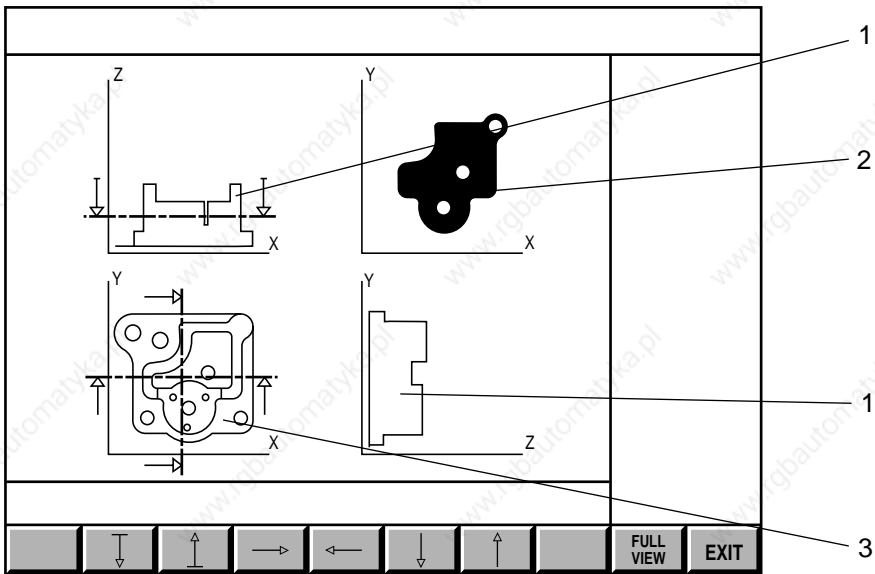

- 1 - Cross-sections
- 2 - Cross-section perpendicular to machining axis
- 3 - View of part along machining axis

Use the softkey arrows to move the cross-section planes.

Movement of cross-section planes and display of corresponding cross-sections.

Return to 3D display page.



Enlargement of a part detail

Select the ZOOM function to enlarge a detail of the part.



ZOOM
IN

3D display in ZOOM mode:

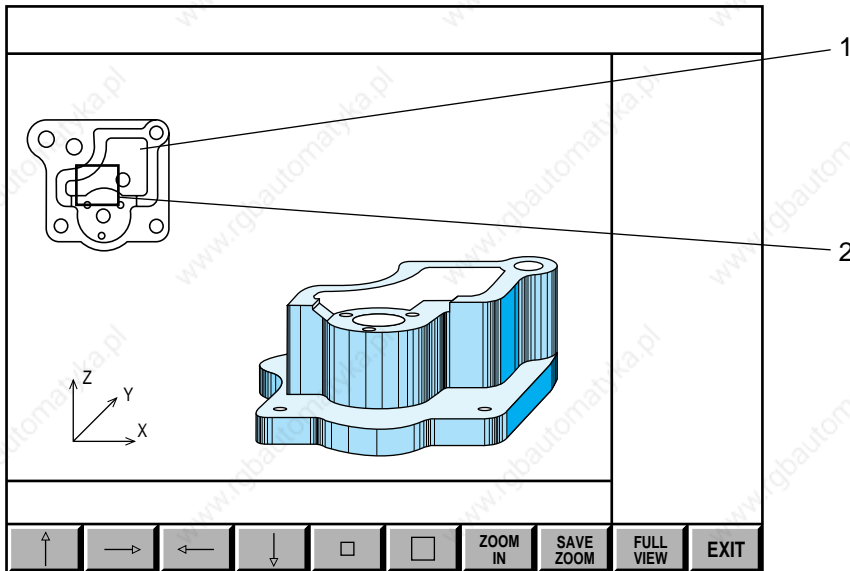

1 - View of part along machining axis

2 - ZOOM window

Change the window to the size required for the detail to be displayed.

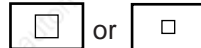

Use the softkey arrows to move the window over the area to be enlarged.

Enlarge the section.



ZOOM
IN

Display of the selected area of the part.

Select the desired option (See table below).

Operation to be performed	Softkey	Result
Confirm enlargement		Return to the 3D display page, the enlarged of the part replaced the 3D model
Cancel the ZOOM mode		Return to the 3D display page, the 3D model is still displayed

Exit from the procedure

Return to the graphic display parameters page.



EXIT

The 3D model of the part (and any area enlarged using the ZOOM function) is stored in memory.

Incidents

When the system detects a programming error, the 3D model calculation is interrupted and an error message is displayed in the dialogue window.

Acknowledge the error message.



Any character

Display of the of the part whose 3D model was calculated up to the faulty block.

Analyse the causes of the error.

Exit the display pages.



EXIT

EXIT

Correct the error (See 5.4.2.2) before returning to the 3D display.

Errors related to the 3D display function:

Incoherent blank definition

Display of "error 21" when the EM- and EM+ functions are incorrectly programmed.

Rewrite the block containing the EM- and EM+ functions (see 5.4.2.2).

Blank definition missing

This message is displayed when the blank has not been defined in the part programme.

Declare the blank (See 5.4.2.2) using the EM- and EM+ functions.

Display of tool not possible

The tool dimensions are too large to allow it to be modelled using the available RAM.

Modify the tool correction (See 5.2.2.2).

4.6.4 Trace during Cutting

A part cutting phase can be monitored in graphic mode.

The display page shows all the tool movements in real time.

The "trace while cutting" function can be called at any time during or prior to machining.

Requirements

"GRAPHIC - PROGRAMMING" menu displayed (See 4.6).

Active programme selected (See 4.6.1.1) in the graphic display parameters page (programme of one of the groups in the case of axis multigroup systems).

Part scaled (See 4.6.1).

System already machining or ready to start machining (See 5.4.3.3 to 5.4.3.5).

Actions

Select "TRACE WHILE CUTTING".



Display of the "trace while cutting" page indicating trace of plane 1.

Display of the programme path:

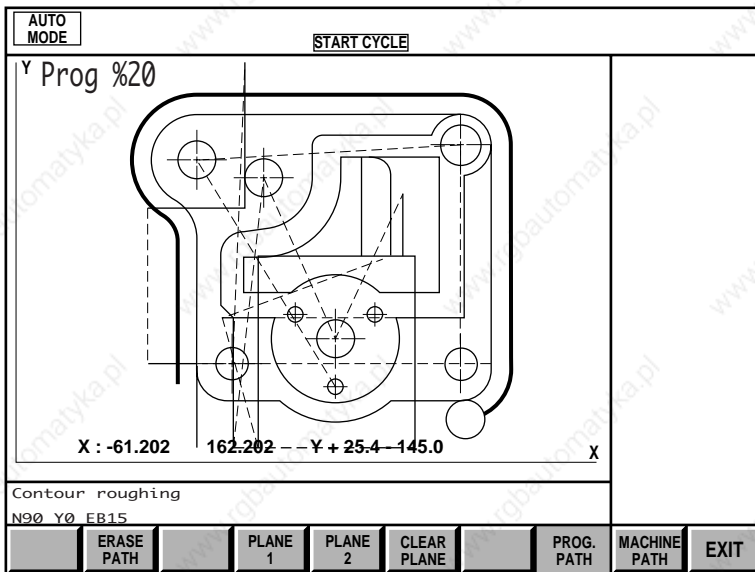

The dialogue window displays the last message and current block.

The tools are represented in the same way as in the simulation function (See 4.6.2).

Select the display plane (if required).



Erasure of tool centre path

So that subsequent movements are easier to see:

Erase the previous tool centre path



Erasure of the part plane

So that only the tool movements are displayed:

Erase the tool centre path.



Display of programme path and machine path

Two types of path can be displayed:

- programme path,
- machine path.

Select the path display type (See table below).

Type of display	Softkey
Programme path	
Machine path	

The programme path shows the change in the reference point calculated by the interpolator. This path usually corresponds to the real path (excluding the following error).

When the real path does not correspond to the programme path (because of dynamic parameters or slaved axes, etc.), the real path can be displayed using the axis measurement.

The following programme uses dynamic operators to perform a single axis transformation of 0.5 about the X axis and transforms a circular path into an ellipse:

```
%40
N10 G00 XYZ
N20 (initialisation)
E81000=E70000-E60000/2
O1=5 E95000/E81000
N30 (transformation)
O1=2 E95000/E60000/E70000/-1
N40 (programming of the circle)
G02 XYIJ50
M02
```

Display of the real path as an ellipse by selecting the machine path display:

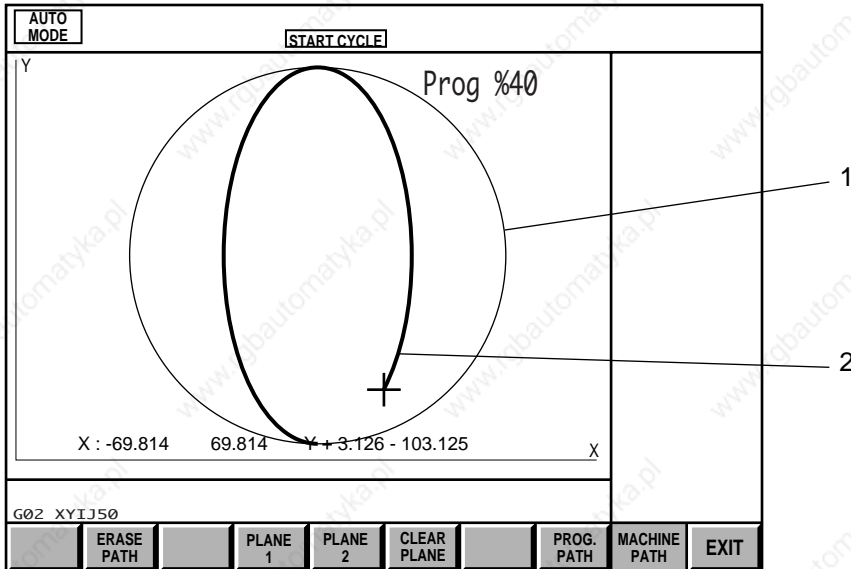

- 1 - Trace of plane 1
- 2 - Measured real path

Exit from the procedure

Return to the "GRAPHIC - PROGRAMMING" menu.



4.6.5 Selection of Graphic Display Parameters and Part Contour Trace in Mixed Machine Mode (MX)

Milling machines on which turning functions are added to the standard milling functions are called "mixed" machines. This combination involves special features as regards graphic display parameter selection and part contour trace.

This section supplements:

- Section 4.6.1 of this milling operator manual, and
- Section 4.6.1 of the turning operator manual.

See Section 4.17 of the Programming Manual for the special programming related to mixed machines.

4.6.5.1 Selection of Graphic Display Parameters

Requirements

"GRAPHIC - PROGRAMMING" menu displayed (see 4.6).

Actions

Select "GRAPHIC DISPLAY PARAMETERS"   

Display of the double window of the graphic display parameters page.

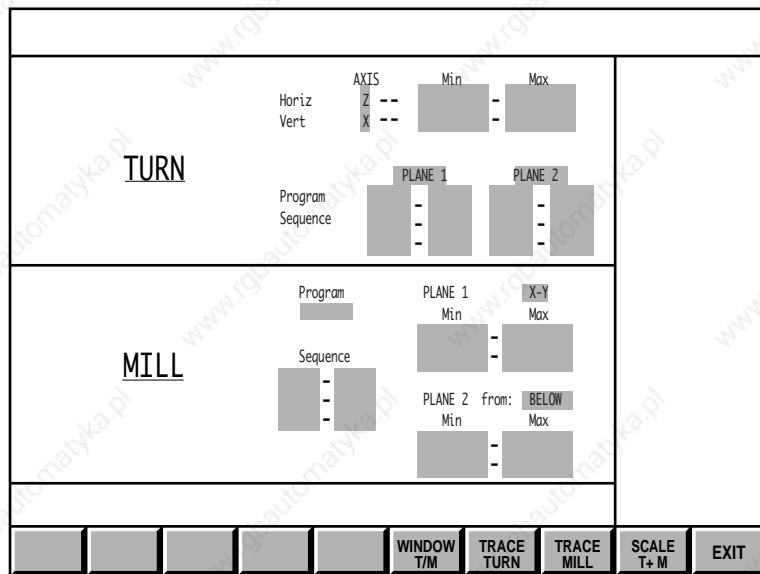

Only the size of each of the two windows, "TURN" and "MILL", specific to mixed machines, is modified, but the windows have the same organisation as the "GRAPHIC DISPLAY PARAMETERS" pages specific to lathes and milling machines.

For the double window to be displayed, function 62, Mixed machine, must be enabled (see 2.3). Otherwise, the page specific to milling machines is displayed.

The double window is incompatible with function 48, Boring function - processing of a radial axis.

Simulation by material removal is impossible on mixed machines.

Moving between "TURN" and "MILL" windows

The "TURN" window is selected when the double window is displayed and the "Program", "Plane 1" field is active (flashing).

Select the "MILL" window.



The "MILL" window is selected and the "Program" field is active.

Use the same key to return to the "TURN" window.

Moving between fields.

Use the arrow keys to move between fields.

The active field flashes.

REMARK After selection of certain fields, new softkeys are displayed (see below).

Description of the "TURN" and "MILL" softkeys

Description of the softkeys common to the "TURN" and "MILL" windows



Key used to toggle between the "TURN" and "MILL" windows



Key used to scale then trace the programmes whose numbers are specified in the "TURN" window (see 4.6.5.2).



Key used to scale then trace the plane (Plane 1) and view (Plane 2 from) specified in the "MILL" window (see 4.6.5.2)



Key used to scale all the programmes and views specified in each of the windows and define a common scale. The "TURN" and "MILL" traces are set to the same scale.



Return to the "GRAPHIC - PROGRAMMING" page.

Keys specific to the "TURN" window

Selecting the "Horiz" or "Vert" "Axis" field in the "TURN" window displays keys X, Y and Z on the left of the softkey bar. These keys are used to select the axes to be scaled (see 4.6.1.1. of the Turning Operator Manual).

Keys specific to the "MILL" window

Selecting the "Plane 1" or "Plane 2 from" field in the "MILL" window displays the following keys on the left of the softkey bar:

- "Plane 1" field: keys X-Y, Y-Z and Z-X to select the plane to be scaled
- "Plane 2 from" field: keys LEFT, RIGHT, ABOVE, BELOW to select the view of the part (see 4.6.1.1 of this manual).

4.6.5.2 Part Contour Traces

Selecting "TURN" or "MILL" part contour trace

Requirements

Double window graphic display parameters page displayed.

Programme to be displayed selected in the "TURN" and "MILL" windows (see 4.6.1.1).

Actions

Select to trace the turning or milling programme.   or 

Display of the turning or milling tool path trace page containing the following softkeys (same in both cases):



Depending on whether "TURN" or "MILL" trace was selected, this page displays:

- for "TURN": the programme selected (Plane 1 or Plane 2) and the specified segments in red in the graphic plane
- for "MILL": the programme selected and the specified segments in the plane (Plane 1) and view (Plane 2 from) in green in graphic mode.

Description of the "TURN" and "MILL" softkeys

 "TURN": Starts the trace of the selected turning programme (Plane 1 or Plane 2) and vice versa.
 "MILL": Starts the trace of the selected milling program in the plane of the secondary view.

REMARK *The message "Program number not found" is displayed on the dialogue line if the "Plane 2" field of the "TURN" window does not contain a programme number.*

 "TURN" and "MILL": Initiates juxtaposed (side by side) trace of the Z-X turning plane and the selected milling view. Overlay is not possible unless the Z-X plane is defined for milling (see Figures 1 and 2 below under "Juxtaposed or overlaid traces").

REMARK *To enable overlay, the "TURN" and "MILL" scalings must be completed.*

 "TURN" and "MILL": Zooms in on an area of the programme being traced on the screen (see 4.6.1.2).

 "TURN" and "MILL": Exits from the turn or mill trace page and returns to the graphic display parameter page.

REMARK *The trace of the plane present on exit from the page is the trace displayed during dynamic trace of tool paths during machining simulation.*

Juxtaposed or overlaid "TURN" and "MILL" traces

Juxtaposed traces

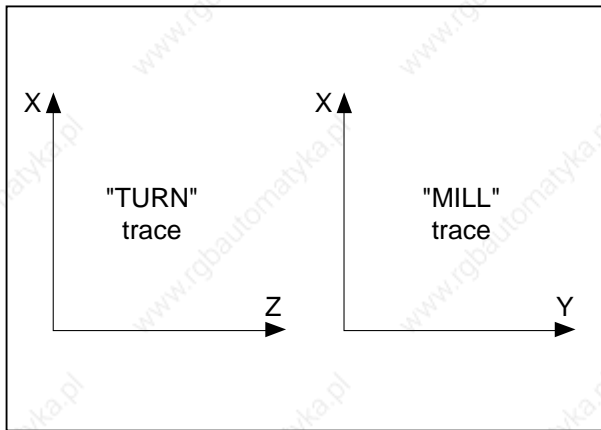

Overlaid traces

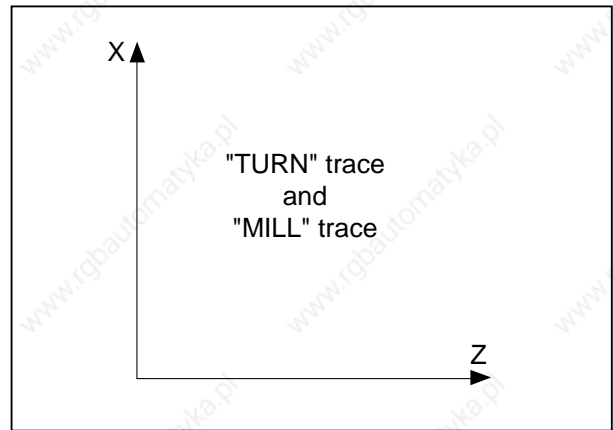

Segment detection

The "TURN" and "MILL" programme segments are detected automatically using the tool offsets (see 4.17, "Requirements for Tool Offset Enable" in the Milling Programming Manual).

Notes on "TURN" and "MILL" dynamic trace

"TURN": When the graphic "TURN" trace is displayed, action on the "TURN SEGMNT" softkey causes dynamic execution with tool movement and displays the sequences being executed. However, if graphic mode is selected for "TURN" and machining for "MILL", the tool is not displayed, but the milling sequences being executed are displayed at the bottom of the screen.

"MILL": Same as "TURN" trace except that the static "MILL" trace must be completed in this case.

4.7 Display of Active Data

Requirements

Basic softkeys displayed.

Actions

Select the information page.



INFO.

Display of information relating to the block being executed:

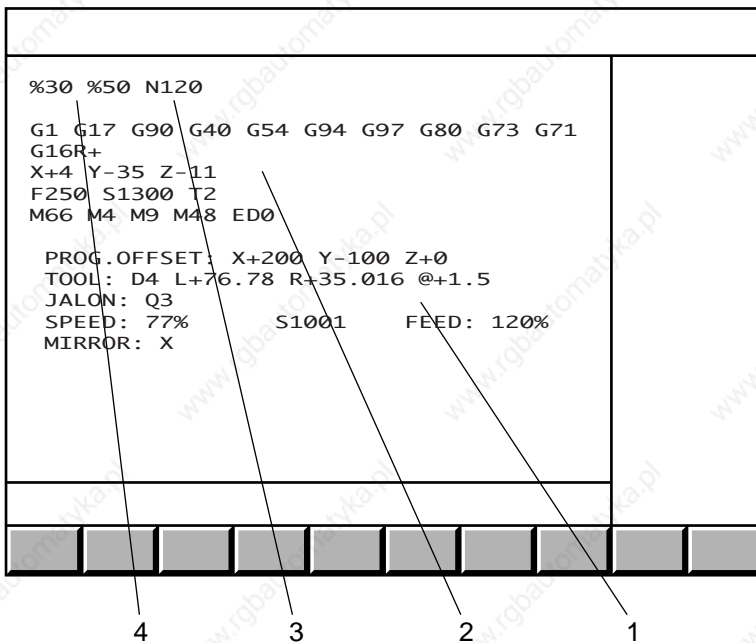

- 1 - Machining data:
 - programmed shifts
 - tool dimensions and wear offsets
 - last marker (axis multigroup systems)
 - spindle potentiometer setting
 - real spindle speed
 - feed rate potentiometer setting
 - mirror axes
- 2 - Functions programmed in current block and modal functions:
 - G functions
 - programmed dimensions
 - feed rate
 - spindle speed
 - tool on spindle
 - M functions
 - angular shift
- 3 - Current block
- 4 - Active program followed by subroutines

Notes

This page changes in automatic, single, dryrun, manual data input, search and test modes.

Error during programme execution

The error number, the block number with the error and possibly the error message text are displayed in the dialogue window, e.g.:

error 159 block N10

Programme shift requested on an axis for which homing is not completed

Display of a part programme message

The first 39 characters of the message are displayed on the first line (e.g. "PART FINISHING").

4.8 Display of Programme-Being Executed

Requirements

Basic softkeys displayed.

Actions

Select the programme page.



PROG.

Display of the programme area being executed with the current block highlighted:

AUTO MODE	START CYCLE
N40 G00 G41 X0 Y-20	
N50 Z-5 F2000	
N60 G01 Y80 EB20	
N70 G02 X0 Y118 R19	
N80 G01 X121 EB13 EF50	

Notes

Error during programme execution

Display of a page similar to the example below:

AUTO MODE	NC??										
N30 S900 M40 M03											
>N40 G00 G41 X0 Y-20	1										
>N50 Z-5 F2000											
>N60 G01 Y80 EB20											
>N70 G02 X0 Y118 R19											
>N80 G01 X121 EB13 EF50											
>N90 Y0 EB15	2										
error 159 block N40 Programme shift requested on an axis for which homming is not completed											
<table border="1"> <tr> <td></td><td></td><td></td><td></td><td></td><td></td><td></td><td></td><td></td><td></td> </tr> </table>											

- 1 - Last known block number before the error
- 2 - Last good block

The error number, the block number with the error and possibly the error message text are displayed in the dialogue window.

No block being executed

Only the line indicating the active programme is displayed.

4.9 Display of Programme Variables and Equivalent Address Table

4.9.1 Display of Programme Variables

Requirements

Basic softkeys displayed.

Actions

Select the "PROGRAMME VARIABLES" page.



L / @

Display of the start of the list of programme variables:

PROGRAMME VARIABLES	
L 0= +1856.5476	L 10= +0.
L 1= +0.	L 11= +0.
L 2= +0.	L 12= +0.
L 3= +0.	L 13= +0.
L 4= +0.74964	L 14= +0.
L 5= +0.	L 15= +0.5645237
L 6= +0.	L 16= +63867.345
L 7= +0.	L 17= +0.
L 8= +0.	L 18= +0.
L 9= +0.	L 19= +0.

Display the next page of the list of programme variables.



...
DAT

Notes

In M02 status (no programme being executed), all the programme variables are reset to 0.

4.9.2 Display of Equivalent Address Table

Requirements

"PROGRAMME VARIABLES" page displayed (see 4.9.1).

Actions

Select the "EQUIVALENT ADDRESSES".



Display of the "EQUIVALENT ADDRESSES" page:

GR1	
EQUIVALENT ADDRESSES	
@A= A	@B= B
@E= E	@F= F
@I= I	@J= J
@M= T	@N= N
@Q= Q	@R= R
@U= U	@V= V
@Y= Y	@Z= Z
@C= C	@D= D
@G= G	@H= H
@K= R	@L= S
@O= O	@P= P
@S= S	@T= T
@W= W	@X= X

Notes

In M02 status (no programme being executed), all the addresses are reset to their original values (@A=A, @B=B....).

4.10 Display of Inputs/Outputs

Certain input/output information on the machine processor can be used by the CNC and displayed on specific pages.

Requirements

Basic softkeys displayed.

Actions

Select the "CNC COMMUNICATION DISPLAY" menu.



PLC
I/O

Display of the "CNC COMMUNICATION DISPLAY":

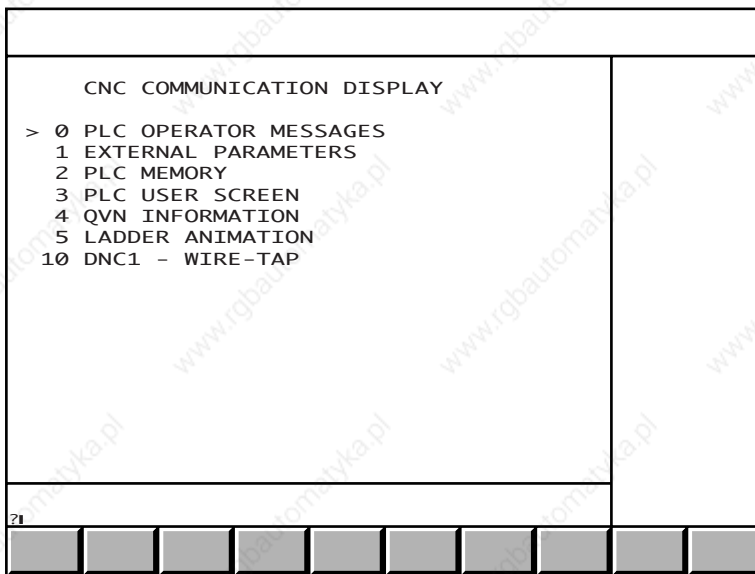

To select an item, move the cursor onto the item or enter the item number then press .

Exit from the procedure

Select a display page.

4.10.1 Display of Operator Messages

Faults affecting the vital functions of the machine, the system or the network may be indicated by messages sent to the CNC. In such cases, the "MSG" indicator is displayed in the status window (See 3.1.3).

These messages can be consulted on the "OPERATOR MESSAGES" page (up to two messages can be displayed).

Two other pages display messages. These pages are:

- the "SYSTEM MESSAGES" page for system faults,
- the "NETWORK MESSAGES" page for network faults.

Requirements

"CNC COMMUNICATION DISPLAY" menu displayed (See 4.10).

Actions

Select the "OPERATOR MESSAGES" page.



Display of the "OPERATOR MESSAGES" page, e.g.:

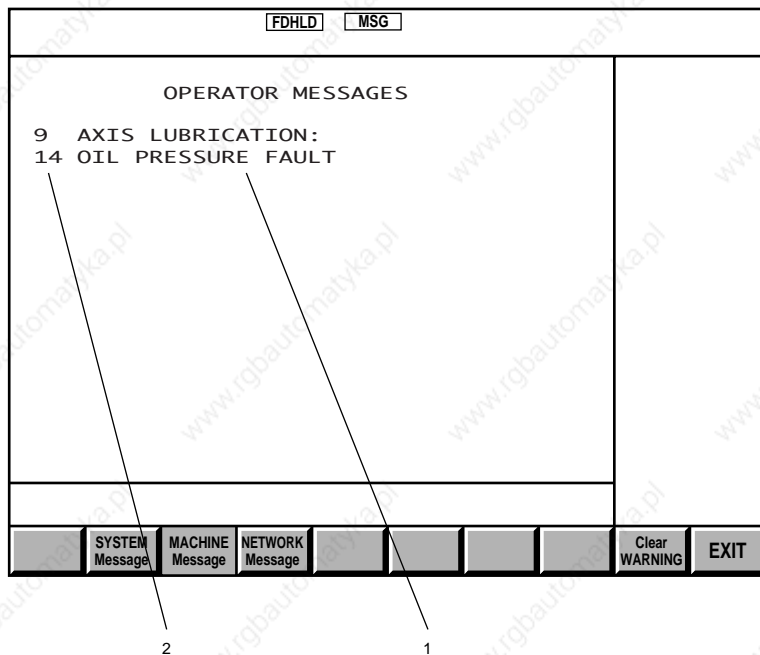

- 1 - Message
- 2 - Number of message in message table

If no faults have been detected, message 0 is displayed.

Selecting message pages

Select the message page to be displayed (See table below).

Page to be displayed	Softkey
"OPERATOR MESSAGES" page (default)	MACHINE Message
"SYSTEM MESSAGES" page	SYSTEM Message
"NETWORK MESSAGES" page: unsolicited data transmission	NETWORK Message

Acknowledging the message indicator

Acknowledge the message indicator



Exiting from the message display pages

Exit from the message display pages.



"CNC COMMUNICATION DISPLAY" menu displayed.

4.10.2 Display of External Parameters

The operator can display 15 external parameters simultaneously.

Requirements

"CNC COMMUNICATION DISPLAY" menu displayed (See 4.10).

Actions

Select "EXTERNAL PARAMETERS".

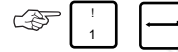

Display of the dialogue line:

PARAMETERS (E..) █

Enter the list of parameters to be displayed "Exxxx Eyyyy ..." (15 maximum).



Display of the "EXTERNAL PARAMETERS" page:

EXTERNAL PARAMETERS		
E40000	+	0
E40001	+	25
E40002	+	63
E40003	+	734
E40004	+	51
E40005	+	82
E41002	+	1
E41003	+	0
E50000	+	11
E50001	+	0
E51001	+	0
E52001	+	5000
E70000	-	220000
E71000	-	193825
>E72000	+	0

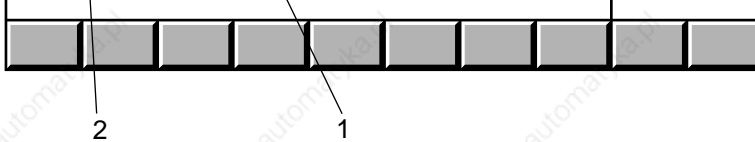

- 1 - Parameter values
- 2 - External parameters

Editing the list of parameters to be displayed

Pointing to a parameter

Move the pointer to the parameter.

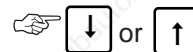

Display of the dialogue line











Display the next part of the list.  

Display of the dialogue line:

PARAMETERS (E..) █

Editing the list

Enter the command corresponding to the operation to be performed (See table below).

Operation	Conditions	Command
Add parameters to the list	Previous parameter pointed to Dialogue line	+Exxxxx Eyyyyy... (15 maximum including the parameters already displayed)  
Replace one parameter by another	Parameter pointed to Dialogue line	#Exxxxx  
Delete a parameter from the list	Parameter pointed to Dialogue line	-  
Delete the entire list	Dialogue line	-*   or   + 

Notes

When programme parameters have already been displayed at a previous stage, selecting "EXTERNAL PARAMETERS" automatically displays the previous "EXTERNAL PARAMETERS" page.

The rest of the procedure is the same.

4.10.3 Display of PLC Memory Data

The operator can simultaneously display 15 parameters accessible for read: PLC inputs and outputs, internal variables, memories, time-outs, PLC programme counters, etc.

Requirements

"CNC COMMUNICATION DISPLAY" menu displayed (See 4.10).

Actions

Select "PLC MEMORY".   

Display of the dialogue line:

ADDRESSES ■

Enter the list of variables to be displayed "%Axx.y..." (15 maximum).  

where:

- "A" is the variable type symbol: M, V, I, Q, R, W or S (see Automatic Control Function Programming Manual in Ladder Language)
- "y" is the variable size symbol: 0 to 7 for bit, B for byte, W for word (2 bytes) and L for long word (4 bytes).

Display of the "PLC MEMORY" page:

PLC MEMORY			
%W24.0	\$05	0 0 0 0 0 1 0 1	1
%W25.1	\$F1	1 1 1 1 0 0 0 1	1
%W26.2	\$43	0 1 0 0 0 0 1 1	1
%W125.B	\$25	+37	
%W126.B	\$97	-23	
%W127.W	\$F852	-30802	
>%W128.L	\$0463E247	+73654855	

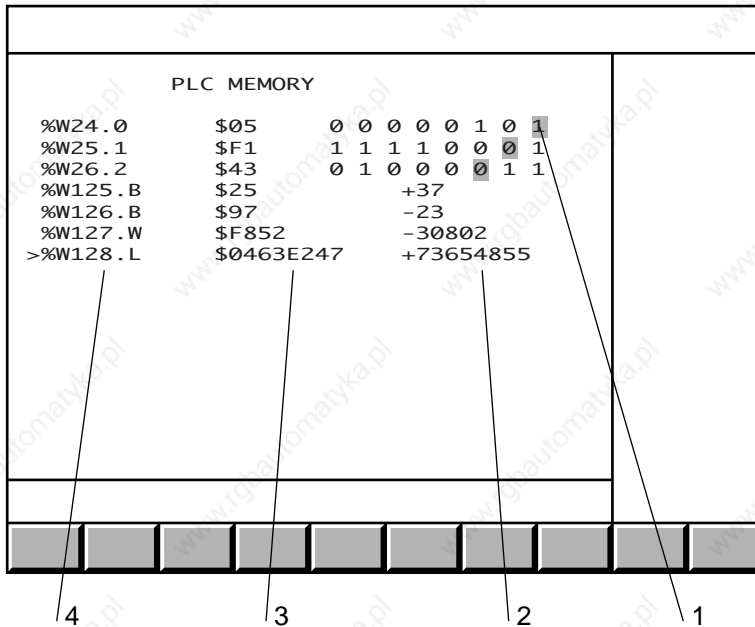

1 - Values of the bit variables highlighted in the corresponding bytes

2 - Decimal values for byte, word or long word variables

3 - Hexadecimal values for byte, word or long word variables

4 - Variables

Editing the list of variables to be displayed

Pointing to a variable

Move the pointer to the variable.   or 

Display of the dialogue line











Display the next page of variables.  

Display of the dialogue line

ADDRESSES ■

Editing the list

Enter the command corresponding to the operation to be performed (see table below).

Operation	Conditions	Command
Add variables to the list	Previous variable pointed to Dialogue line	+%Axx.y... (15 maximum including the parameters already displayed)  
Replace one variable by another	Variable pointed to Dialogue line	#%Axx.y  
Delete a variable from the list	Variable pointed to Dialogue line	-  
Delete the entire list	Dialogue line	-*   or   + 

Notes

When variables have already been displayed at a previous stage, selecting "PLC MEMORY" automatically displays the previous "PLC MEMORY" page.

The rest of the procedure is the same.

4.10.4 Display of PLC User Screen

The PLC user screen gives access to user applications managed by the PLC (refer to the documentation provided by the manufacturer of the machine).

Requirements

"CNC COMMUNICATION DISPLAY" menu displayed (See 4.10).

Actions

Select "PLC USER SCREEN".



Access to client application, e.g. a fault diagnosis aid:

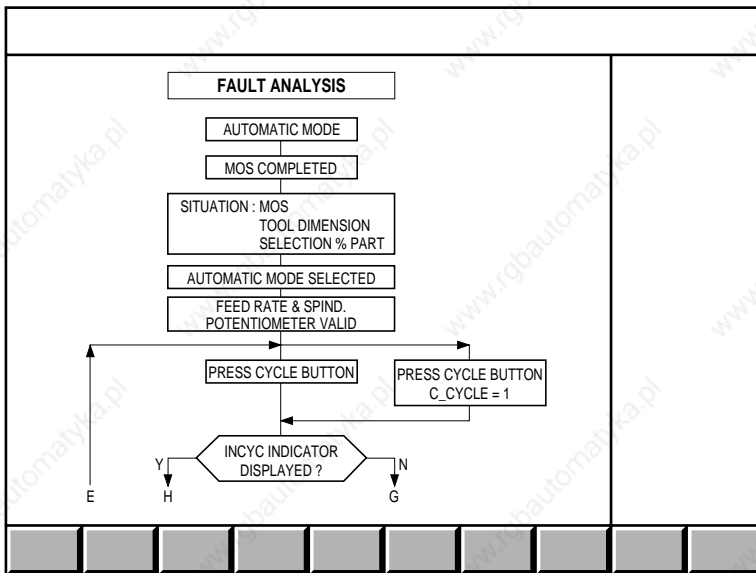

When there are no programmed applications, this page is blank.

4.10.5 Display of QVN Information

For information on the "QVN INFORMATION" menu item, refer to the DISC (Digital Integrated Servo Control) integration manual.

4.10.6 Display of Ladder Animation

For information on the "LADDER ANIMATION" menu item, refer to the Programming of the Automatic Control Function in Ladder Language manual.

4.10.7 Display of Wire Tap

For information on the "WIRE TAP" menu item, refer to the DNC1 Description of the Link Procedure manual.

4.11 Access to Maintenance Functions

The utilities present allow access to the maintenance functions of the system.

Access to the utilities is described in Section 8.2.2.

5 CNC Operation

5.1 Preliminary Operations		5 - 5
5.1.1 Operator-Controlled Jog		5 - 5
5.1.1.1 Selection of JOG Softkeys		5 - 5
5.1.1.2 Selection of Manual Mode		5 - 6
5.1.1.3 Incremental Jog		5 - 6
5.1.1.4 Continuous Jog		5 - 7
5.1.1.5 Handwheel Jog		5 - 7
5.1.2 Axis Homing		5 - 8
5.1.2.1 Homing on to a Switch		5 - 8
5.1.2.2 Origin Declaration via the Keyboard		5 - 9
5.1.2.3 Automatic Homing		5 - 9
5.2 Preparation for Machining		5 - 10
5.2.1 Part setting with Respect to the Machine		5 - 10
5.2.1.1 Selection of Origin Shift Mode (SHIFT)		5 - 11
5.2.1.2 Part Origin Shift Introduction		5 - 12
5.2.1.3 Input of Part Origin Shifts via the Keyboard		5 - 13
5.2.1.4 Input of Programme Origin Shifts		5 - 13
5.2.1.5 Input of Programme Origin Eccentricity Values		5 - 14
5.2.1.6 Input of Scaling Factor		5 - 14
5.2.1.7 Declaration of Axis Assignment		5 - 15
5.2.2 Tool Setting		5 - 16
5.2.2.1 Semi-Automatic Tool Dimension Entry		5 - 16
5.2.2.2 Tool Dimension Entry via the Keyboard		5 - 19
5.2.2.3 Loading the Tool Offsets via Peripheral or Computer		5 - 20
5.2.2.4 Tool Wear Offset Entry		5 - 21
5.3 Manual Data Input		5 - 24
5.4 Automatic Programme Execution		5 - 25
5.4.1 Loading Programmes		5 - 25
5.4.1.1 Loading Part Programmes		5 - 26
5.4.1.2 Selection of Active Programme		5 - 28
5.4.1.3 Reading a Programme in Drip Feed Mode		5 - 29
5.4.2 Creating and Debugging a Part Programme		5 - 32
5.4.2.1 Access to Edit Mode		5 - 32
5.4.2.2 Creating or Editing a Part Programme		5 - 32
5.4.2.3 Programme Deletion		5 - 39
5.4.2.4 Programme Renaming		5 - 39
5.4.2.5 Duplication of a Part Programme		5 - 40
5.4.2.6 Programme Test		5 - 40
5.4.3 Execution on the Machine		5 - 42
5.4.3.1 Optional Stop and Block Skip Enable		5 - 42
5.4.3.2 Programme Execution - General		5 - 43
5.4.3.3 Execution of a Programme Step by Step		5 - 46
5.4.3.4 High Speed Execution of a Programme		5 - 47
5.4.3.5 Execution of a Programme in Automatic Mode		5 - 48

5.5 Operator Interventions		5 - 49
5.5.1	Unplanned Interventions	5 - 49
5.5.1.1	Interruption of Machining	5 - 49
5.5.1.2	Retracting the Axes	5 - 49
5.5.1.3	Manual Axis Recall	5 - 50
5.5.1.4	Automatic Axis Recall	5 - 50
5.5.1.5	Sequence Number Search	5 - 51
5.5.1.6	Backtrack along Path	5 - 53
5.5.1.7	Return along Path	5 - 56
5.5.1.8	Cancellation of an Operation in Progress	5 - 56
5.5.1.9	Manual Data Input	5 - 57
5.5.1.10	Rotation Speed and Feed Rate Override	
	Potentiometers	5 - 57
5.5.1.11	Emergency Retraction	5 - 57
5.5.1.12	Intervention and Programme Resumption after an Error	5 - 58
5.5.1.13	Programme Resumption after a Following Error	5 - 60
5.5.2	Programmed Interventions	5 - 61
5.5.2.1	Machining Stop Function M00 (or M01 if enabled)	5 - 61
5.5.2.2	Forcing an Intervention by M12	5 - 61
5.5.2.3	Wait for Report	5 - 61
5.6 CNC Information Archiving		5 - 62
5.6.1	Unloading Programmes	5 - 63
5.6.1.1	Unloading the Active Programme	5 - 63
5.6.1.2	General Case of Part Programme Unloading	5 - 64
5.6.2	Unloading Tool Tables	5 - 65
5.7 Creation of a Part Programme		5 - 66
5.7.1	Creation of a Part Programme Using Interactive Programming (PROCAM)	5 - 66
5.7.2	Creating Contours with the PROFIL Function	5 - 67
5.7.3	Creation of a Part Programme by Tuition	5 - 68
5.8 Inch/Metric Unit Selection		5 - 69
5.8.1	Display Unit Selection	5 - 69
5.8.2	Programming Unit Selection	5 - 69
5.8.3	Consequences of Unit Selection on Values	5 - 69
5.9 Part Programme Operations in Background Mode		5 - 71
5.9.1	Programme Creation or Editing	5 - 72
5.9.2	Loading Part Programmes from a Peripheral	5 - 74
5.9.3	Unloading a Part Programme	5 - 77
5.9.3.1	Unloading the Active Programme to a Peripheral	5 - 78
5.9.3.2	Unloading Part Programmes to a Peripheral	5 - 79

5.9.4	NUM Diskette Drive	5 - 81
5.9.4.1	Description of the NUM Diskette Drive	5 - 81
5.9.4.2	Syntax Rules and Control of the Drive	5 - 81
5.9.5	Operations on the NUM Diskette Drive	5 - 82
5.9.5.1	Drive Management	5 - 82
5.9.5.2	Diskette Management	5 - 83
5.9.5.3	Directory Management	5 - 84
5.9.5.4	File Management	5 - 87
5.9.6	Loading from the NUM Diskette Drive	5 - 92
5.9.6.1	Loading Part Programmes from the Num Diskette Drive	5 - 92
5.9.6.2	Loading Tool Offsets from the NUM Diskette Drive	5 - 94
5.9.7	Unloading to NUM Diskette Drive	5 - 96
5.9.7.1	Unloading the Active Programme to the NUM Diskette Drive	5 - 96
5.9.7.2	Unloading Other Programmes to the NUM Diskette Drive	5 - 98
5.9.7.3	Saving Tool Offsets to NUM Diskette Drive	5 - 100

5.1 Preliminary Operations

When the CNC is switched on, no measurement origin is available for the axes motion calculations.

The system must be initialised (by homing the axes: see 1.2.3 and 5.1.2) before any programmed movement is performed.

This homing procedure provides the CNC with a coordinate system which it uses for programmed movements.

If this homing procedure has not been carried out, only jog operations can be performed.

5.1.1 Operator-Controlled Jog

Three types of jog operations can be performed:

- incremental jog,
- continuous jog,
- jog using handwheel.

CAUTION

When the homing procedure has not been performed, the software end of travel limits on the axes are inactive and only the mechanical end of travel limits prevent the machine from exceeding its safe travel.

During jog operations prior to the homing procedure, it is not recommended to allow an axis to reach its mechanical end of travel switches, since the axis must then be returned within the authorised range by a special procedure which temporarily overrides the normal action of the travel switch, (as opposed to the software end of travel limits which automatically allow the axis to move off in the opposite direction).

5.1.1.1 Selection of JOG Softkeys

Actions

Select the JOG softkeys.



Display of the JOG softkeys at the bottom of the screen (See 3.1.4.4):



Exit from the procedure

Return to the basic softkeys.



Return to the basic softkeys (See 3.1.4.2).

5.1.1.2 Selection of Manual Mode

Requirements

No mode being executed. If a mode is being executed, selection of manual mode is only taken into account after an interruptible block.

Actions

Select the Mode softkeys.  

Display of the Mode softkeys at the bottom of the screen (See 3.1.4.3):



Select the manual mode.  

Display of the manual mode indicator in the status window (See 3.1.3).

Notes

In manual mode, the feed rate is controlled from the machine operator panel:

- by selecting fast jog speed,
- by turning the feed rate potentiometer.

5.1.1.3 Incremental Jog

Requirements

JOG softkeys selected (See 5.1.1.1).

Actions

Select an increment (0.001 to 10000 μm).   to 

Display of increment indicator in status window (See 3.1.3).

Select the manual mode (See 5.1.1.2).

Control the jog by momentarily pressing the axis controls of the machine panel.

Jog of one increment along the axis in the demanded direction (only one jog action can be performed at a time).

Notes

Pressing the "FEED STOP" button on the machine operator panel interrupts the jog being executed. Following this interruption:

- pressing "CYCLE" restarts the jog,
- pressing  cancels the remaining jog.

5.1.1.4 Continuous Jog

Requirements

JOG softkeys selected (See 5.1.1.1).

Actions

Select the continuous jog function.



FREE

Display of the "CONT." indicator in the status window (See 3.1.3).

Select the manual mode (See 5.1.1.2).

Control the jog by continually pressing the axis controls of the machine panel.

Jog along the axis in the demanded direction while it is being pressed.

Notes

The "FEED STOP" button is ineffective during continuous jog.

5.1.1.5 Handwheel Jog

Requirements

JOG softkeys selected (See 5.1.1.1).

Actions

Select the handwheel jog function.



HANDWH

Display of the "HANDWH" indicator in the status window (See 3.1.3).

Select the manual mode (See 5.1.1.2).

Use the corresponding controls to jog the axes.

Jog along the axis linked to the handwheel:

- value proportional to the handwheel rotation,
- direction corresponding to the handwheel rotation.

5.1.2 Axis Homing

The axes must be homed before any programmed movement can be performed. This procedure is designed to provide the system with a coordinate origin (measurement origin .

REMARK *The measurement origin is a fixed point linked to the machine. However, it can be modified by a part or PLC programme. The user must bear this possibility in mind and re-execute a measurement origin setting if required.*

When the measurement origin setting needs to be performed on at least one axis, the "HOME" indicator flashes in the status window (See 3.1.3). However, further measurement origin settings can also be performed when this indicator is not displayed.

5.1.2.1 Homing on to a Switch

Requirements

No mode being executed. If a mode is being executed, this command is only taken into account after an interruptible block.

Actions

For each axis:

Manually position the tool on the correct side of the home switch (See OEM instructions).

Select the Mode softkeys.



Display of the Mode softkeys at the bottom of the screen:



Select homing mode.



Display of the home mode indicator in the status window (See 3.1.3). Home mode will permit jog operations.

Move the axis in the direction of the home switch (See OEM instructions).

Display of the "INCYC" indicator in the status window (See 3.1.3).

The indicator disappears once homing has been completed on that axis.

Notes

In homing mode, only the movement direction set by the OEM is authorized.

The feed rate can be modified from the machine panel operator:

- by selecting fast jog speed,
- by turning the feed rate potentiometer.

Incidents

If homing mode is selected when an axis is already on the switch, the error indicator (error 32) is displayed in the status window (See 3.1.3).

Acknowledge the error.	
Manually retract the axis from the switch.	
Restart the origin setting procedure.	

5.1.2.2 Origin Declaration via the Keyboard

Sometimes the home switch is not accessible (cumbersome part mounted on the table, not allowing collision-free movement).

In such cases, the measurement can be set by entering the position of a known point via the keyboard.

REMARK *This procedure can be performed either on one axis at a time or on several axes simultaneously. It can also be partial, i.e. home normally on certain axes if the corresponding switch remains accessible.*

Origin declaration via the keyboard can be inhibited by machine parameter P7 (see Parameter Manual).

Requirements

No mode being executed. If a mode is being executed, this command is only taken into account after an interruptible block.

Actions

Manually move the axes to the known point (measurement dimension is known).	
Select the Mode softkeys.	

Display of the Mode softkeys at the bottom of the screen:

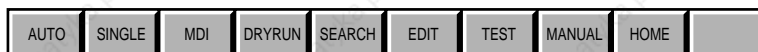

Select homing mode.	
---------------------	--

Display of the home mode indicator in the status window (See 3.1.3).

Enter the position of the point: "X.. Y.. Z.."	
--	--

5.1.2.3 Automatic Homing

Homing can be performed automatically using programmes written for this purpose (see the example of homing programme in the Programming Manual or check the machine manufacturer's documentation which may include a special programme for homing the machine).

A homing programme is executed and runs in the same way as a part programme (See 5.4).

5.2 Preparation for Machining

5.2.1 Part setting with Respect to the Machine

During machining, the CNC takes into account the position of the part with respect to the machine.

To provide the CNC with this set up information, generally requires shifts to be entered (See 1.2.4) between the measurement origin and:

- the part origin (\oplus) and the programme origin (\oplus),
- the center of rotation of the index table and the programme origin (off-centering) for milling machines fitted with index table.

Setting the part with respect to the machine allows the part programme to be used:

- on different machines,
- irrespective of the way the part is mounted on the index table.

The part origin shift can be acquired semi-automatically or entered via the keyboard.

A scaling factor may also be included in these setting if the part has to be machined using dimensions other than those which have been programmed.

The shifts entered are stored in memory when the CNC is switched off. Therefore, it is unnecessary to re- enter them each time the machine is switched on.

REMARK *The part settings with respect to the machine can be modified by a part or PLC programme. The user must bear this possibility in mind and re-execute a measurement origin setting if required.*

5.2.1.1 Selection of Origin Shift Mode (SHIFT)

Requirements

No mode being executed. If a mode is being executed, selection of this mode is only taken into account after an interruptible block.

Actions

Select the Mode softkeys. 

Display of the 2nd page of the Mode softkeys at the bottom of the screen:



Select the origin shift mode. 

Display of the shift page, plus dialogue line for part origin input and the origin shift mode indicator (SHIFTS) in the status window:

SHIFTS						
SCALE: E 1000/1000						
		DAT1	DAT2		DAT3	
X	+	126.452+	200.	+	100.	*
Y	-	503.267+	0.	+	0.	
Z	-	42.871+	150.	+	100.	*
B	+	0.	+	0.	+	0.
DAT1:						

REMARK A DAT3 datum shift was entered for the two axes marked * (See 5.2.1.5).

5.2.1.2 Part Origin Shift Introduction

By bringing the spindle into contact with the part, this procedure enables the CNC to measure the part origin shifts (DAT1) directly.

When a setting piece is inserted between the spindle and the part, this method can still be used, but the part origin shift values must be modified via the keyboard to take into account the dimensions of the setting piece.

The procedure described below is only one of the possible methods of entering the part origin shift values.

Requirements

Homing procedure performed (See 5.1.2).

No mode being executed.

Actions

For each axis:

Manually bring the spindle datum into contact with the origin surface of the reference part.

Select the origin setting mode (See 5.2.1.1).

Enter "[axis name]".



Transfer of the spindle datum measurement dimension of the corresponding axis to DAT1 which is then displayed on screen.

If using a test bar for example:

Calculate the real value of DAT1 taking into account the dimensions of the test bar (See diagram).

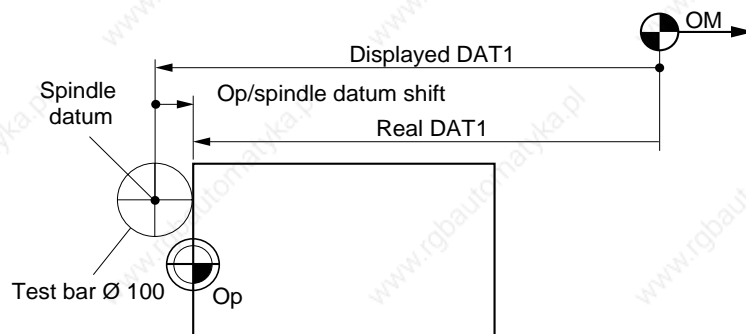

real DAT1 = displayed DAT1 + Op/spindle datum shift (algebraic value)

Enter "[axis name][real DAT1]".



The real DAT1 is displayed.

Example:

The following values:

- Y DAT1 displayed = - 307.783
- Op/spindle datum shift = + 5 (test bar dia. 10),

give:

Real Y DAT1 = - 302.783

Enter Y -302.783.



The real YDAT1: -302.783.

5.2.1.3 Input of Part Origin Shifts via the Keyboard

When the part origin shifts or center of turntable shifts (DAT1) are known, they can be directly entered into the system via the keyboard.

Requirements

No mode being executed. If a mode is being executed, selection of this mode is only taken into account after an interruptible block.

Actions

Select the origin shift mode (See 5.2.1.1).

For each axis, enter "[axis name] [value of DAT1]".



Transfer of the entered shifts to the DAT1 values which are then displayed on the screen.

5.2.1.4 Input of Programme Origin Shifts

Programme origin shifts (DAT2) are entered via the keyboard (this is not required for systems fitted with an index table).

Requirements

No mode being executed. If a mode is being executed, selection of this mode is only taken into account after an interruptible block.

Actions

Select the origin shift mode (See 5.2.1.1).

Display the dialogue line for DAT2 input.

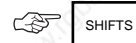

Display of dialogue line for "DAT2: ■".

For each axis, enter "[axis name] [value of DAT2]".



Transfer of the entered shifts to the DAT2 values which are then displayed on the screen.

5.2.1.5 Input of Programme Origin Eccentricity Values

Eccentricity values (DAT3 for milling machines fitted with an index table) are entered via the keyboard. Shift DAT3 must be entered for both axes concerned by index table rotation. After entry, these two axes are marked *.

Requirements

No mode being executed. If a mode is being executed, selection of this mode is only taken into account after an interruptible block.

Actions

Select the origin shift mode (See 5.2.1.1).

Display the dialogue line for DAT3 input.



Display of dialogue line for "DAT3: ■".

Enter "[axis 1] [value of DAT3] [axis 2] [value of DAT3]".



Transfer of the entered shifts to the DAT3 values which are then displayed on the screen.

5.2.1.6 Input of Scaling Factor

A scaling factor (SCALE) can be entered via the keyboard to modify the dimensions of the parts to be machined.

Requirements

No mode being executed. If a mode is being executed, selection of this mode is only taken into account after an interruptible block.

Actions

Select the origin shift mode (See 5.2.1.1).

Display the dialogue line to input the scaling factor by pressing (three times).

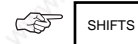

Display of "SCALE (E..) ■" in the dialogue line.

Enter "E [value of scaling factor]".



The scaling factor is expressed in thousandths of the programmed dimensions.

Entry of the scaling factor and display on screen.

5.2.1.7 Declaration of Axis Assignment

Axis assignment is used to modify the $X_m Y_m Z_m$ physical reference system of the machine with respect to the $X_p Y_p Z_p$ part programme reference system. The part programme reference system is then adapted to the workpiece orientation on the milling machine. Axis assignment can be positive or negative.

Axis assignment can be declared by keyboard entry (see below) or in a programme by external parameter E69003 (see Section 6.2 of the Programming Manual).

Requirements

No mode being executed. Otherwise, axis assignment is taken into account after an interruptible block.

Actions

Select origin shift mode (see 5.2.1.1).

Display the dialogue line (press four times).

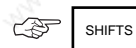

Display on the dialogue line of "ASSIGNED AXES".

Enter "ASSIGNED AXES [new assignment]" (see notes below).



The axis assignment is transferred to the SHIFTS page.

Notes

The assignments for the three axes must be declared on the same line. After each programme axis (X, Y, Z), function P, Q, R identifies the corresponding machine axis (X, Y, Z). The plus or minus sign indicates whether assignment is positive or negative.

Example:

ASSIGNED AXES: XR-YQ-ZP+

XR-: programme axis X assigned to machine axis Z with the opposite sign

YQ+: programme axis Y unchanged

ZP+: programme axis Z assigned to machine axis X with the opposite sign.

Assignment is refused if the command format is incorrect or the group to which it applies is not in reset state. If the command is accepted, the tool direction (G16 ...) takes the assignment of programme axis Z.

It should be noted that axis assignment:

- reorients the programmed dimensions, the interpolation plane (possibly with reversal of the direction of rotation of circles), the PQR material vectors, the coefficients of polynomial functions, the 2D tool offsets (possibly with reversal of G41/G42) and the tool direction (G16...)
- is applied downstream of programmed geometric transformations such as angular offset (ED..), programmed offset (G59), mirroring (G51...) and scaling factor (G74)
- is not applied to the dimensions programmed with respect to the measurement origin (G52...)
- does not affect shifts DAT1, DAT2 and DAT3.

5.2.2 Tool Setting

Tool setting enables the CNC to apply the corrections necessary during movements.

The input tool dimensions are stored in the tool dimension table before being used in a part programme.

Tool dimensions can be input or loaded via:

- the keyboard,
- a peripheral.

The tool dimension table remains stored in the memory when the CNC is switched off.

REMARK *The tool offsets can be modified by a part or PLC programme. The user must bear this possibility in mind and re-enter the tool dimensions if required.*

For each tool, three dimensions are defined (tool radius, tool length and corner radius: see 1.2.5 and 4.4) associated with corrections D..

The corrections are not automatically allocated to a specific tool. The part programme associates a correction to a tool. Several corrections can be successively associated to the same tool in a programme (during roughing and finishing phases for example).

5.2.2.1 Semi-Automatic Tool Dimension Entry

During the semi-automatic tool dimension entry procedure, the CNC measures the tool dimensions against a reference part.

These measurements are made when the tool is in contact with the reference part, defined using programme dimensions.

Requirements

Homing completed on all axes (See 5.1.2).

DAT1 and DAT2 shift values entered (See 5.2.1).

Tool and reference part in place.

No mode being executed. If a mode is being executed, selection of this mode is only taken into account after an interruptible block (mode substitution is not possible during a machining cycle).

Actions

Select one of the current position pages (See 4.2) or "TOOL OFFSETS" (See 4.4).

Select the 2nd page of the Mode softkeys.



Display of the 2nd page of the Mode softkeys:



Select the automatic tool setting mode.



Display of the automatic tool setting mode indicator in the status window (See 3.1.3).

Display in the dialogue line of the previous dimensions of the reference part:

PRESET:X+... Y+... Z+...

The automatic tool setting mode authorises axis jog (See 5.1.1) without manual mode being selected.

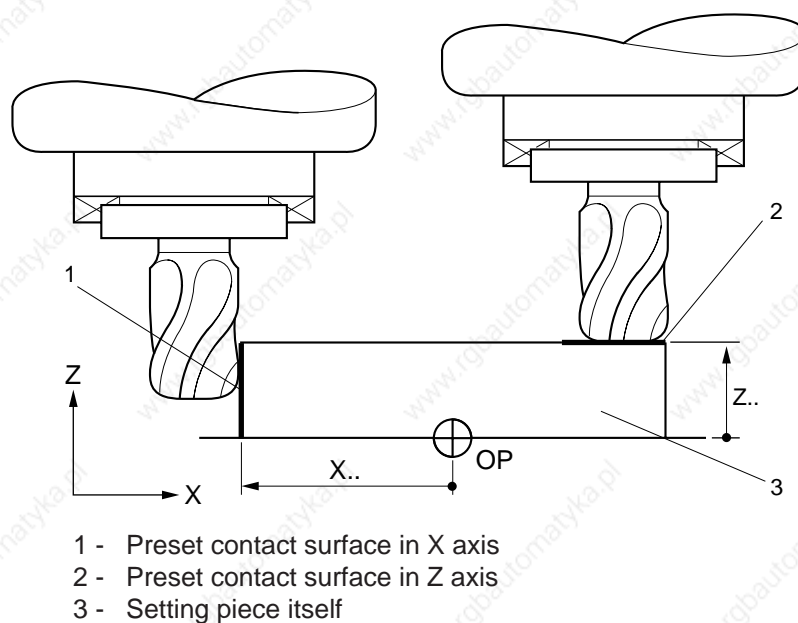

Enter the reference part dimensions: "X.. Y.. Z.." (with respect to the programme origin).



Display on the dialogue line of the new dimensions of the reference part.

REMARK Tool dimensions L and R can be measured along two axes. Therefore, it is unnecessary to enter the dimension of a contact surface along the third axis.

For each axis:

Bring the tool into contact with the reference part using the jog controls or the handwheel.

Transfer the measured dimension to the tool correction
(See syntax given below).



Dimension to be transferred	Syntax
Radius: R	D [Correction No.] [axis name] R @ [corner radius] (only enter @.. if modified)
Length: L	D [Correction No.] [axis name] \pm L @ [corner radius] (+ L if the tool is pointing in the positive direction of the axis, - L in the negative direction) (only enter @.. if modified)

Transfer of the dimension to the tool dimension table and display in the "TOOL CORRECTIONS" page.

Example

Transfer of dimensions to correction D11

Measurement of R along the Z axis

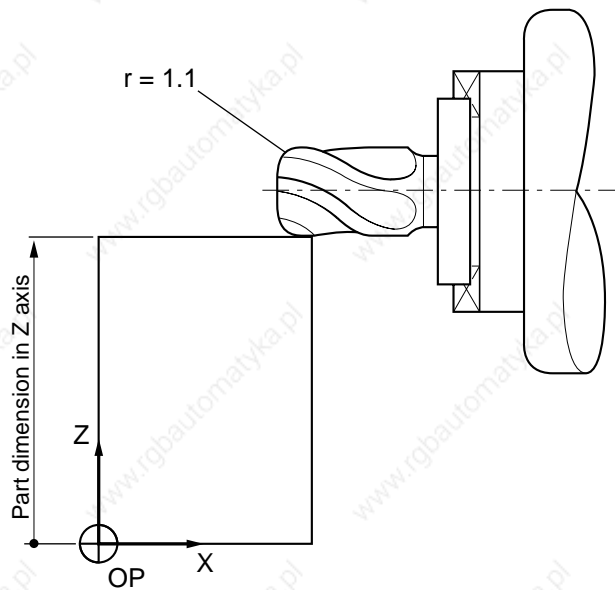

Syntax: D11 Z R @ 1.1

Measurement of L along the X axis

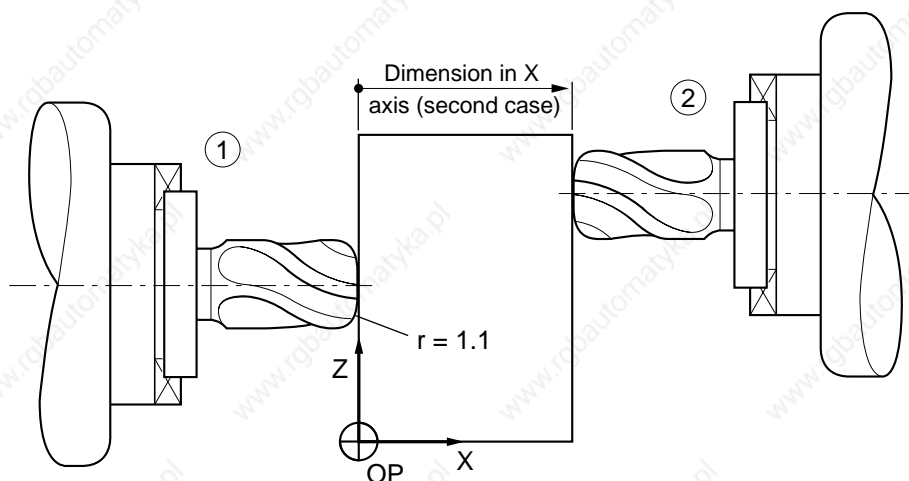

Syntax:

1 D11 X - L (tool pointing in the opposite direction to the axis)

or

2 D11 X + L (tool pointing in the direction of the axis)

@ 1.1 can be omitted since it was transferred with R

5.2.2.2 Tool Dimension Entry via the Keyboard

This procedure is used to enter known tool corrections via the keyboard.



CAUTION

Remember that any tool corrections entered in this manner during machining may directly affect the machining in progress.

Requirements

No mode being executed (except automatic, single or dry run modes).

Actions

Any page displayed, for each correction:

Select the Tool softkeys.



Display of the Tool softkeys at the bottom of the screen:

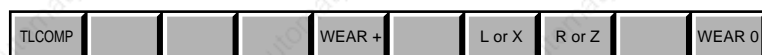

Select the tool dimension entry function.



Display of tool dimension entry function indicator in the status window (See 3.1.3).

Enter "D [Correction No.] L [tool length] R [tool radius]
@ [cutter tip radius]" (only the modifications).



Transfer of the correction to the tool dimension table and display of the "TOOL OFFSETS" page (See 4.4) with the new correction.

Exit from the procedure

Exit the tool dimension entry function.



The tool dimension entry indicator (TLCOMP) disappears.

Exit the Tool softkeys.



5.2.2.3 Loading the Tool Offsets via Peripheral or Computer

The tool offsets can be loaded from peripherals such as a tape reader, PC, diskette drive, or via a computer.

Requirements

Loading from a peripheral	Loading via computer
Link established with the peripheral (See C.2)	Link established with computer and file to be loaded selected (see C.3)
Peripheral ready to send data (see peripheral manual)	

"FILE LOADING" menu displayed on the screen and data rate set (See 5.4.1).

Actions

Select "TOOL OFFSETS".



The cursor moves to the following line:

1 TOOL OFFSETS

Start loading.



The "INCYC" indicator is displayed in the status window (see 3.1.3).

Start data transmission by the peripheral.

The tool offsets loaded appear in the dialogue window.

At the end of loading, the "INCYC" indicator disappears.

Only the tool offsets transmitted are modified.

Incidents

When the system encounters a correction which has not been written correctly:

- transmission is stopped,
- the invalid correction is displayed on the dialogue line.

There are two possible solutions:

Cancellation of the correction

Cancel the correction. 

Transmission is restarted.

Correction of the correction

Correct the offset via the keyboard. 

Transmission is restarted.

Exit from the procedure

Stop the loading procedure. 

The "INCYC" and "FILE LOADING" indicators disappear.

Transmission is stopped.

The offsets already transmitted are saved.

5.2.2.4 Tool Wear Offset Entry

The tool dimensions can be modified by applying wear offsets (See 1.2.6).

The wear offsets are stored cumulatively in the wear offset table and can be reset.

Individual entries are limited to ± 0.999 mm (± 0.3 mm when the internal unit is $0.01 \mu\text{m}$), but their cumulative total can exceed this value.

An offset entered during execution of a block N becomes active from the first linear interpolation block (G01) following block N+2:

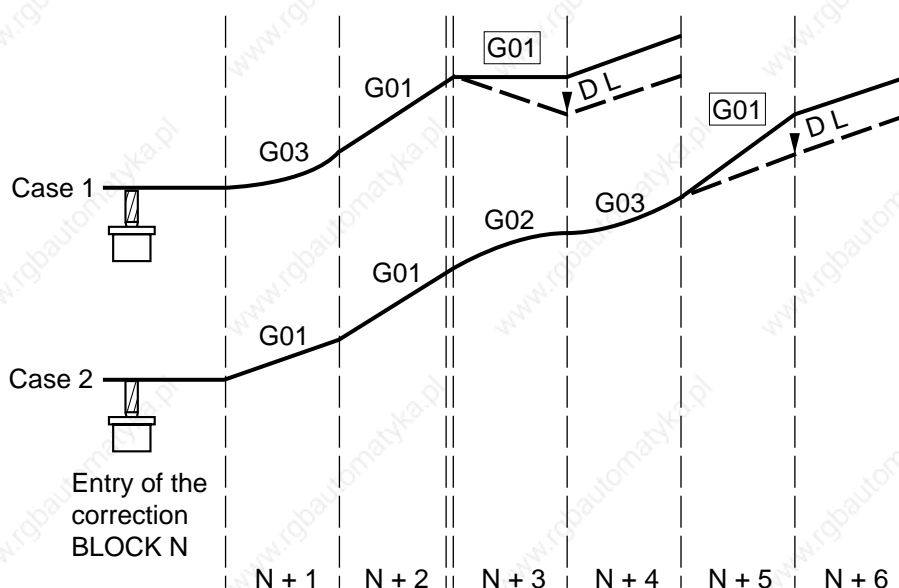

REMARK

Wear offsets between -0.1 and +0.1 mm on the machining axis (L..) are taken into account immediately when they are entered.

Wear offsets can be entered or cleared by:

- the operator (See below),
- by the PLC programme or part programme (parametric programming).

A wear offset is automatically reset when a new tool dimension is entered.

Requirements

No mode being executed (except automatic, single or dry run modes).

Basic softkeys displayed (See 3.1.4.2).

Actions

Select the "TOOL WEAR OFFSETS" page.   

Display of tool wear offsets (See 4.4)

Select the Tool softkeys.  

Display of the Tool softkeys at the bottom of the screen:

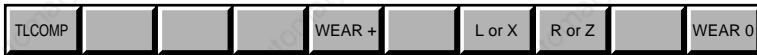

Tool wear offset entry



For each offset to be entered:

Select the wear offset entry function.  

Display of tool wear offset entry function indicator in the status window (See 3.1.3).

Display of (INCR. WEAR OFFSET) in the dialogue line.

Enter the wear offset (See syntax below).  

Dimension to be corrected	Syntax
Radius: R	[Correction No.] R [offset value] ("R" can be entered via the keyboard or the  softkey) (the offset is between ± 0.999 mm or ± 0.3 mm when the internal unit is $0.01 \mu\text{m}$)
Length: L	[Correction No.] L [offset value] ("L" can be entered via the keyboard or the  softkey) (the offset is between ± 0.999 mm or ± 0.3 mm when the internal unit is $0.01 \mu\text{m}$)

The offset is added to the value in the tool wear offset page and the new value is re-displayed in the "TOOL WEAR OFFSETS" page.

The tool wear offset indicator disappears.

Tool wear offset clear

For each offset to be cleared:

Select the wear offset clear function.



WEAR 0

Display of the tool wear offset clear indicator in the status window (See 3.1.3).

Display of (CLEAR WEAR OFFSET) in the dialogue line.

Enter "D [Correction No.] R L".



REMARK "L" and "R" can be entered via the keyboard or using the softkeys. If only one offset is to be cleared, only enter one letter (R or L) corresponding to the selected offset.

Values are cleared and re-displayed in the "TOOL WEAR OFFSETS" page.

The tool wear offset clear indicator disappears.

Exit from the procedure

Select a mode.

or

Exit the Tool softkeys.



TOOL

5.3 Manual Data Input

The manual data input mode is used to manually input an instruction and then execute it without storing it in a programme.

Requirements

Measurement origin setting completed (See 5.1.2) on the axes to be moved.

No mode being executed. If a mode is being executed, selection of the MDI mode is only taken into account after an interruptible block (mode switching is not possible during a machining cycle).

Actions

Select the Mode softkeys.



Display of the Mode softkeys at the bottom of the screen:



Select the manual data input mode.



Display of the manual data input mode indicator in the status window (See 3.1.3).

Enter the instruction via the keyboard.



Display of the instruction on the dialogue line.

Execute the instruction by pressing the "CYCLE" button on the machine panel.

Display of the "INCYC" indicator on the status window (See 3.1.3).

When the instruction has been executed, the indicator disappears.

Exit from the procedure

Press the "FEED STOP" button on the machine operator panel to interrupt the movement in progress.

Movement interruption:

- pressing "CYCLE" restarts the jog,
- pressing  cancels the remaining movement.

5.4 Automatic Programme Execution

5.4.1 Loading Programmes

Requirements

No mode being executed.

Actions

Select the 2nd page of Mode softkeys.



Display of the 2nd page of softkeys at the bottom of the screen:



Select load mode.



Display of the "FILE LOADING" menu and the load mode indicator in the status window:

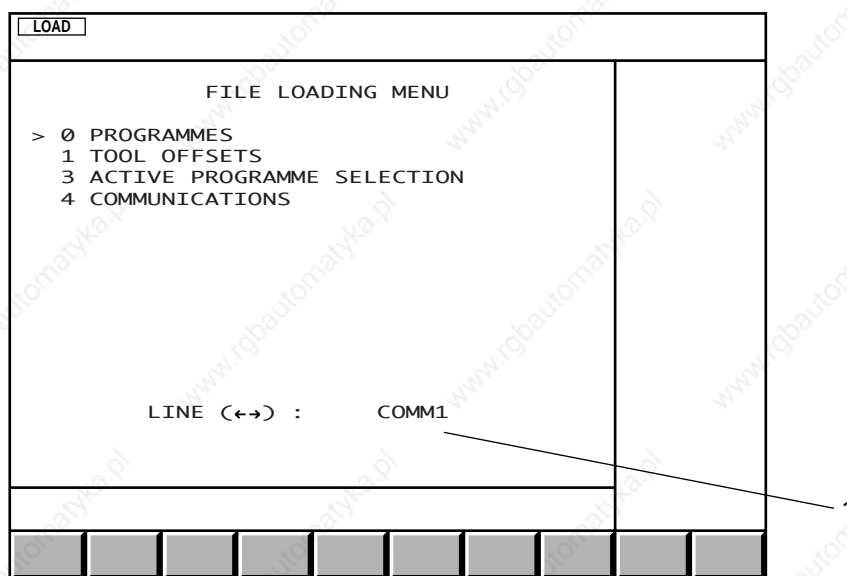

1 - Serial line selected

To select an item, move the cursor onto the item with the up and down arrow keys or enter the item number then press .

Selecting the serial line

The CNC serial line parameters must be set (see 8.3) according to the peripheral (See peripheral manual).

Set the peripheral transmission parameters.

Select the serial line set for the peripheral.



The line selected is displayed.

5.4.1.1 Loading Part Programmes

Part programmes can be loaded from peripherals such as a tape reader, PC, diskette drive or from a computer.

Requirements

Loading from a peripheral	Loading from a computer
Link established with the peripheral (See C.2)	Link established with the computer and file to be loaded selected (See C.3)
Peripheral ready to send data (See peripheral manual)	

"FILE LOADING" menu displayed on the screen and transmission line selected (See 5.4.1).

Actions

Select "PROGRAMMES".   

The cursor moves to the following line:

0 PROGRAMMES

Start loading.  

Display of the "INCYC" indicator in the status window (See 3.1.3).

Start the data transmission procedure over the link (automatic in the case of a computer).

Display of the programme being loaded.

When the loading procedure has been completed, the "INCYC" indicator disappears, the "FILE LOADING" menu is displayed and the programme is transferred to RAM.

The programme loaded becomes the active programme.

Loading several consecutive programmes not separated by Xoff characters

If several programmes not separated by Xoff characters (ASCII character code 19) are included in the loaded file:

- the programmes are loaded one after the other,
- the last programme becomes the active programme.

Loading several consecutive programmes separated by Xoff characters

If several programmes are included in the loaded file, when an Xoff character is encountered:

- reading stops,
- the "INCYC" indicator disappears.

Start loading the next programme.  

Each programme is loaded in the same way.

The last programme to be loaded becomes the active programme.

Incidents

The loaded programme has the same number as a programme already in memory

When the loading procedure has been completed, the "INCYC" is still displayed and the following message appears:
 PROG. EXISTS - OK TO OVERWRITE ? (Y/N):

Enter the letter corresponding to the desired action (Y = yes, N = no).



A positive answer causes the old programme to be overwritten and the new programme to be stored.

A negative answer cancels the loaded programme.

Loading re-starts until the Xoff character is encountered at which point the "INCYC" indicator disappears and the "FILE LOADING" menu is displayed.

The programme loaded has the same number as the programme in the protected memory.

When loading is completed, the "INCYC" indicator remains displayed and the following message appears:

"WARNING, THIS PROGRAMME EXISTS IN A PROTECTED ZONE
 CREATE THE PROGRAMME IN ZONE 0? (Y/N):"

Enter the letter corresponding to the desired action (Y for yes, N for no).



A positive answer causes the programme to be stored.

A negative answer cancels loading.

The "INCYC" indicator disappears and the "FILE LOADING" menu is redisplayed.

The RAM is full

The "INCYC" indicator disappears and the "FILE LOADING" menu is displayed.

The peripheral stops sending data.

Display of the error indicator (error 36) in the status window (See 3.1.3).

Acknowledge the error.



The error indicator disappears.

Delete unused programmes (See 5.4.2.3) and restart the loading procedure.

No programme start character (See Programming manual)

Data is sent over the link, but not acknowledged by the CNC.

Cancel the loading procedure.



The "INCYC" indicator disappears.

No programme end character (See Programming manual)

When the loading procedure has been completed, the CNC waits for the programme end character.

There are two possibilities:

Cancel the loading procedure.  

Edit the programme to be loaded and restart the loading procedure.

or

Send a programme end character (if allowed by the peripheral).

Exit from the procedure

Stop the loading procedure.  

The "INCYC" indicator disappears and the "FILE LOADING" menu is displayed.

The peripheral stops sending data.

The part of the programme which has already been read is not stored.



5.4.1.2 Selection of Active Programme

Before a programme can be executed, it must first be selected as the active programme.

Requirements

"FILE LOADING" menu displayed (See 5.4.1).

Actions

Select "ACTIVE PROGRAMME SELECTION".   

The cursor moves to the following line:

3 ACTIVE PROGRAMME SELECTION

Confirm active programme selection.  

The "INCYC" indicator is displayed in the status window (see 3.1.3) and the following message is displayed in the dialogue line:

(%..) █

Enter "% [Programme No.]".  

The programme selected is displayed and becomes the active programme.

The "INCYC" and "FILE LOADING" indicators disappear.

Incidents

If no programme exists with this number or the programme number is incorrectly written, the cursor moves to the "%" when an attempt is made to confirm this number.

Select another programme number and confirm it.















5.4.1.3 Reading a Programme in Drip Feed Mode

When a programme is too long to be stored in the CNC RAM or the user does not wish to store it (e.g. a programme from a CAD system and subject to modifications), this programme can be executed by reading it directly from a peripheral or a computer.

A programme executed in drip feed mode is subjected to certain restrictions concerning skips, subroutines and emergency retraction blocks (See Programming manual).

Requirements

Requirements met for the selected mode (See table).

Execution mode	Selected mode	See
Automatic (default selection)	  	5.4.3.5
Single	  	5.4.3.3
Dry run	  	5.4.3.4
Sequence number search	  	5.5.1.5
Test	  	5.4.2.6

Programme sent by a peripheral

Transmission from a peripheral	Transmission from a computer
Link established with the peripheral (See C.2)	Link established with the computer and file to be loaded selected (See C.3)
Peripheral ready to send data (See peripheral manual)	

"FILE LOADING" menu displayed on the screen and transmission line selected (See 5.4.1).

Actions

Select "ACTIVE PROGRAMME SELECTION"   



The cursor moves to the following line:

3 ACTIVE PROGRAMME SELECTION

Confirm active programme selection.  

The "INCYC" indicator is displayed in the status window (See 3.1.3) and the following message appears on the dialogue line:

(%..) █

Select the programme source (See Syntax below).  

Programme source	Syntax
Peripheral	PPR %[Group No.] *
Computer	PPL %[Group No.] *

* The term %[Group No.] is only required for systems with axis multigroups. It is used to assign the programme to one of the axis groups (e.g. PPR %1.1 assigns the programme to the first axis group).

Display of the information page, "PPR" (or "PPL") (on the first line) and the automatic mode indicator (in the status window):

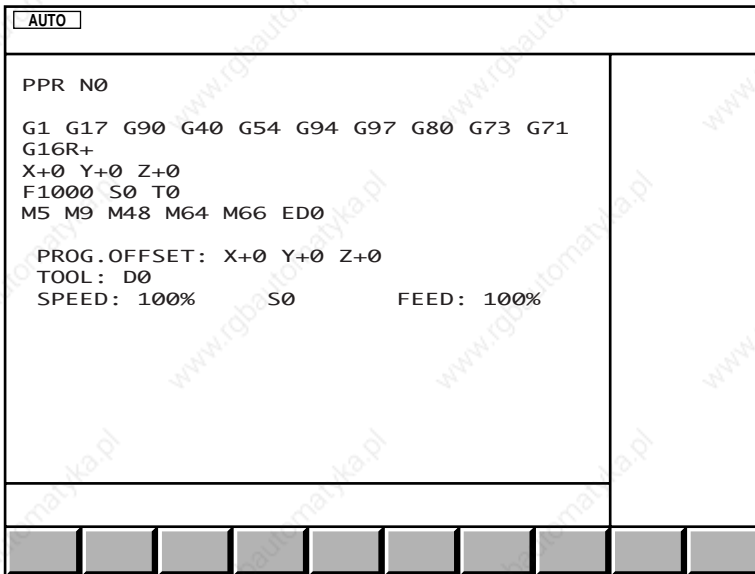

The system allocates a 32 KB buffer in the programme memory.

REMARK *If between 1 and 32 kbytes of memory are available, all of this area is reserved by the system and the drip feed mode can be executed without any difficulty.*

Select the desired execution mode (See table at the start of the section).

Display of the indicator of the selected mode in the status window (See 3.1.3).

Start the programme read and execution by pressing the "CYCLE" button on the machine panel.

Execution of the programme in the selected mode (See references given in the table).

Incidents

When less than 1 kbyte of programme memory is available, the system displays the error indicator (error 36) in the status window (See 3.1.3).

Acknowledge the error.



The fault indicator disappears.

Delete unused programmes (See 5.4.2.3) and restart the procedure.

Exit from the procedure

Select the load mode (See 5.4.1).

Select "SELECT ACTIVE PROGRAM".

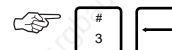

The cursor moves to the following line:

```
3 SELECT ACTIVE PROGRAM
```

Press the "CYCLE" button on the machine panel.

The "INCYC" indicator is displayed in the status window (see 3.1.3) and the following message appears on the dialogue line:

(%..) █

Enter "-PPR (or -PPL)".



The "INCYC" indicator disappears and the information page is displayed.

The buffer area in the programme memory is cleared.

5.4.2 Creating and Debugging a Part Programme

5.4.2.1 Access to Edit Mode

The edit mode is used to create or modify a programme as well as to delete or rename it.

All modifications are stored as soon as they are entered.

Requirements

No mode being executed. If a mode is being executed, selection of the edit mode is only taken into account after an interruptible block.

Actions

Select the Mode softkeys.



Display of the Mode softkeys at the bottom of the screen:



Select the edit mode.



Display of the edit mode indicator in the status window (See 3.1.3).

Display of the start of the active programme or display of the message "ENTER PROGRAM NUMBER" if there is no active programme.

5.4.2.2 Creating or Editing a Part Programme

The edit mode is used like a text editor to modify programme blocks.

Since the edit mode only checks word formats and not block syntax or compatibility, all modified programmes must be tested (See 5.4.2.6).

A part programme should only be modified by someone who has a sufficient grasp of part programming.















Requirements

System in edit mode (See 5.4.2.1).























Actions

Enter the command corresponding to the operation to be performed (See tables below).





















Selecting blocks

Operation to be performed	Block selected	Command
Select the programme to be modified (first block selected)	Any	%[Programme No.]  
Go to a block	Any	%[Programme No.] N [Block No.] (%No. unnecessary if it is the programme displayed)  
Go to an unnumbered block (block Na + b lines)	Any	%[Programme No.] Na + b  
Go to a block	Any	Successively hit until reaching the block   or 
Go to a block containing a character string	Block located further down the programme	; [character string to be found]  
Go to the next block containing the same character string	Block selected during previous op.	;  
Move down the pointer	Any	Successively hit  

Editing blocks

Operation to be performed	Block selected	Command
Delete a block	Block to be deleted	-  
Insert a block	Previous block	+ [block to be inserted]  
Transfer a block to the dialogue line (for editing)	Block to be transferred	#  
Replace one block by another	Block to be replaced	# [new block]  
Replace one character string by another	Block containing the string to be replaced	# ; [string to be replaced] ; [new string]  
Add a character string at the end of a block	Block to be modified	# ; ; [string to be added]  
Recall the last block displayed in the dialogue line (#...)	Block to be replaced	*  
Replace a block by the block in the dialogue line (#...)	Block to be replaced	 
Insert block Na + b lines to block Nc + d lines of a programme	Block preceding the blocks to be inserted	I %[programme number] Na + b Nc + d (%No. unnecessary if it is the programme displayed)  
Insert a whole programme (except the programme number)	Block preceding the blocks to be inserted	I %[numéro de programme]  
Delete blocks down to block Na + b lines	First block to be deleted	DEL Na + b  

Editing blocks in the dialogue line

Operation to be performed	Position of cursor	Command
Move the cursor by one character	Any	  or 
Move the cursor to the end of the dialogue line	Any	  + 
Move the cursor to the start of the dialogue line	Any	  + 
Overtyping text	First character to be overwritten	Select the overtype mode Indicateur "OVER" dans la fenêtre status (See 3.1.3). Enter the new characters.  
Insert characters	Character after the insertion	Select the insert mode "INS" indicator in the status window (See 3.1.3). Enter the new characters.  
Delete a character	Character to be deleted	 
Delete a character	Character after character to be deleted	 
Delete the dialogue line	Any	  (or  + )

Notes

Creation of a programme

Enter "%[Programme number] (Optional comment)"  

When there is no programme corresponding to the number entered:

No programme with that number exists in the protected area	A programme with the same number exists in the protected area
Display of the message: CREATE NEW PROGRAMME? (Y/N):█	Display of the message: WARNING: this programme exists in a protected zone. Create the programme in zone 0? (Y/N):█

Confirm creation of the programme.   

Display of the line:

> %[Programme No.] (Comment)

Create the programme blocks using the edit mode functions.

Incidents

String not found in selected block

When replacing one string by another, if the string to be replaced is not found in the selected block, the cursor moves to the #.

Rewrite the string correctly and restart the operation.

Insufficient memory during insertion

If there is insufficient memory during a block insertion operation, the message is displayed:

"MODIFICATION NOT POSSIBLE"

Delete unused programmes (See 5.4.2.3) and restart the operation.

Word format error

If the word format is incorrect when the selected block is being replaced by the block in the dialogue line (See Programming Manual), the cursor moves to the address of the incorrect word.

Rewrite the word correctly and replace the selected block.

Examples

The following examples illustrate the various functions available for modifying a programme.

Selection of a block in a programme and replacement of a character string

System in edit mode and programme to be modified not displayed.

Original blocks	Modified blocks
%202 (PART NUMBER 486494)	%202 (PART NUMBER 487219)

Enter "%202 N0+1".



Display of programme %202 and selection of block N0 (first block) + one line.

Enter "#;6494;7219".



Replacement of string "6494" by string "7219".



Selection of a block, insertion of a string at the end of a block and insertion of a new block

System in edit mode and programme to be modified not displayed.



Original blocks	Modified blocks
N20 T01 D01 M06 N30 S700 M03	N20 T01 D01 M06 (CUTTER DIA=10) N30 S700 M03 N40 G00 Z-3

Enter "N20".  

Selection of block N20.

Enter "#; (CUTTER DIA=10)".  

Addition of comment "(CUTTER DIA=10)" at the end of block N20.

Select the next block (N30).  



Enter "+N40 G00 Z-3".  

Addition of block "N40 G00 Z-3" after block N30.



Modification of a block after transfer to dialogue line

System in edit mode, block to be modified (old block N40) selected and indicator  (overtyping mode) displayed in the status window.



Original block	Modified block
N40 G00 G41 X8 Y-10	N50 G41 X18 Y-10



Enter "#".  

Transfer of old block N40 to the dialogue line.

Move the cursor 2 characters to the right.   

Overtyping the "4" with a "5".   5



Move the cursor 3 characters to the right (press 3 times).  



Delete string "G00 " (press 4 times).  

Move the cursor 5 characters to the right (press 5 times).  

Select the text insertion mode.  

Display of the  indicator (text insertion) in the status window.

Insert a "1".  

Confirm the block.  

Replacement of the old block N40 by "N50 G41 X18 Y-10".

Deletion of a block

System in edit mode and block preceding the block to be deleted (new block N50) selected.

Original blocks	Modified blocks
N50 G41 X18 Y-10 N50 Z-3	N50 G41 X18 Y-10

Select the next block (N50).  

Delete the old block N50.   

Deletion of the block and selection of next block.

Replacement of one block by another

System in edit mode and block to be replaced (block N60) selected.

Original block	New block
N60 G01 Y50 F100 M08	N60 G01 Y0

Enter "#N60 G01 Y0".  

Replacement of block N60 by "N60 G01 Y0".

Deletion of a string in a block

System in edit mode and block to be modified (block N80) selected.

Original block	Modified block
N80 G01 G40 Y70	N80 G01 Y70

Enter "#;G40 ;".  

Replacement of string "G40" of block N80 by an empty string.

Insertion of a part of a programme

System in edit mode and block preceding the blocks to be inserted (block N120) selected.

Blocks to be inserted	Modified part of programme
%204 ... N220... \$ CUTTING OF GROOVE WITH RADIUS N230 G00 Y20 N240 G01 X50 N250 G03 X40 Y10 R10 N260 G01 Y-10 ...	N120 X70 \$ CUTTING OF GROOVE WITH RADIUS N230 G00 Y20 N240 G01 X50 N250 G03 X40 Y10 R10 N260 G01 Y-10 ...



Enter "I %204 N220+1 N260".  

Insertion of that part of programme %204 between blocks N220 + 1 and N260 after block N120, selection of block "CUTTING OF GROOVE WITH RADIUS".



Application of the same modification on several blocks

System in edit mode and first block to be modified (block N230) selected.



Original blocks	Modified blocks
N230 G00 Y20	N130 G00 Y20
N240 G01 X50	N140 G01 X50
N250 G03 X40 Y10 R10	N150 G03 X40 Y10 R10

Enter "#;N2;N1".  

Replacement of string "N2" by string "N1", the block number becomes N130.

Enter ";N2".  



Selection of next block containing string "N2" (N240).

Enter "*".  

Recall of last block displayed in the dialogue line "#;N2;N1".

Confirm the dialogue line.  



Replacement of string "N2" by string "N1", the block number becomes N140.

Enter ";".  

Selection of next block containing the last string searched for: "N2" (N250).

Enter "*".  

Recall of last block displayed in the dialogue line "#;N2;N1".



Confirm the dialogue line.  

Replacement of string "N2" by string "N1", the block number becomes N150.

Insertion of a string at the end of a block

System in edit mode and block to be modified (block N190) selected.

Original block	Modified block
N190 G01 X40	N190 G01 X40 F0.1

Enter "#;;F0.1".  

Addition of the string "F0.1" at the end of block N190.

5.4.2.3 Programme Deletion

Requirements

System in edit mode (See 5.4.2.1).

Actions

If the programme to be deleted is not the active programme (selected when the edit mode was entered):

Enter "% [Programme No.]".



Display of the start of the selected programme with the pointer positioned on the first block (programme number).

Enter "- % [Programme No.]" (same number)



Display of the message:

PROGRAM DELETED

Incidents

When the pointer is not positioned on the first block or the specified programme number is not the same as that displayed, the message:

MODIFICATION NOT POSSIBLE

Restart the procedure.

5.4.2.4 Programme Renaming

Requirements

System in edit mode (See 5.4.2.1).

Actions

If the programme to be renamed is not the active programme:

Enter "% [Programme No.]".



Display of the start of the selected programme with the pointer positioned on the first block (programme number).

Enter "# % [old No.] % [new No.] (Optional comment)".



The programme is displayed with its new number, possibly followed by a comment.

The programme is no longer the active programme.

Incidents

Incorrect programme number

When the old programme number is not the same as the one displayed or a programme with the new number already exists, the message:



MODIFICATION NOT POSSIBLE

Restart the procedure.

The pointer was not positioned on the first block

When the pointer is not positioned on the first block, the block which is selected is replaced by "% [old No.] % [new No.]", altering the programme.

To restore the old block:

Enter "# [old block]".		
Restart the procedure.		

5.4.2.5 Duplication of a Part Programme

Requirements

System in edit mode (See 5.4.2.1).

Actions

Enter "% [No. of programme to be created]".		
---	---	---

Display of the message:

CREATE NEW PROGRAM ? (Y/N): █

Confirm creation of the programme			
-----------------------------------	---	---	---

Display of the line:

>% [Programme No.]

Enter "I % [No. of programme to be duplicated]".		
--	---	---

Duplication of the programme.

5.4.2.6 Programme Test

The test mode is used to check a part programme in the operating conditions of the machine and system.

The system analyses and executes the programme without moving the axes, which is far quicker than real machining.

The test checks:

- the syntax,
- the compatibility of the programmed instructions with the machine data accessible to the CNC (e.g. movements within limit travels including application of tool corrections, axes to be moved declared in the system, etc.).

Functions M00 et M01 are not taken into account during the test.

Requirements

Origin shifts entered (See 5.2.1).

No mode being executed. If a mode is being executed, selection of the test mode is only taken into account after an interruptible block.

Part programme to be tested selected as active programme (See 5.4.1.2).

Actions

Select the Mode softkeys.



MODE

Display of the Mode softkeys at the bottom of the screen:



Select the test mode.



TEST

Display of the test mode indicator in the status window (See 3.1.3).

To monitor execution of the programme:

Select either the programme page (See 4.8) or the information page (See 4.7).

Display of the selected page.

Start the test.



Display of the "INCYC" indicator in the status window (See 3.1.3).

Programme tested.

When the test has been completed, the "INCYC" indicator disappears.

Incidents

When the system detectors an error, the error indicator is displayed in the status window (See 3.1.3).

The error number, the number of the block with the error and the error message are displayed in the dialogue window of the information, programme and current position pages, e.g.:

```
error 77      Block N0
Tool type not compatible with the operation
```

Consult the list of errors (See appendix B) and determine the cause.

Correct the programming error (See 5.4.2.2).

The error indicator disappears.

Restart the test procedure.

REMARK *If the error is due to the limits having being exceeded, the error must be acknowledged by pressing .*

5.4.3 Execution on the Machine

5.4.3.1 Optional Stop and Block Skip Enable

A part programme may contain functions which, when enabled, modify its execution (functions for debugging for example). These include:

- optional stops (M01),
- block skips (/ at start of block).

When optional stops are enabled by the operator, all "M01" functions encountered in the programme are treated as "M00" functions (See Programming manual). Otherwise, the "M01" functions are ignored.

When block skips are enabled by the operator, all blocks preceded by "/" are ignored. Otherwise, the blocks are executed normally.

Optional stop enable

The optional stop indicator (M01) in the status window (See 3.1.3) indicates that the optional stop function is enabled.

Actions

Enable or disable the optional stop function.



The optional stop indicator disappears or is displayed accordingly.

REMARK The  key does not exist on the 9" and 10" operator panels. Optional stops are enabled on the machine panel.

Block skip enable

The block skip indicator (/) in the status window (See 3.1.3) indicates that the block skip function is enabled.

Requirements

No mode being executed.

Actions

Enable or disable the block skip function.



The block skip indicator disappears or is displayed accordingly.

REMARK The  key does not exist on the 9" and 10" operator panels. Block skips are enabled on the machine panel.

5.4.3.2 Programme Execution - General

A part programme can be executed in three modes:

- single step (See 5.4.3.3),
- dry run (See 5.4.3.4),
- automatic (See 5.4.3.5).

This section describes the functions common to all three modes.

Display of programme execution

During programme execution, all the display pages are accessible.

Four display pages can be used to monitor programme execution:

- the programme page (See 4.8) displays the block being executed and the adjacent blocks,
- the information page (See 4.7) displays the data (block number, active functions, end point coordinates, etc.) of the block being executed,
- the current position page (See 4.2) displays the coordinates of the current position,
- the trace while cutting page (See 4.6.4) provides a graphic display of programme execution.

Select one of the display pages.

Display of the selected page.

Axis multigroup programme execution

An axis multigroup programme must include at least one executable block (G04 or M function if no movement is desired) on each of the axis groups (%xxx.1, %xxx.2, etc.) to be able to synchronise all the axis groups. If there is not at least one executable block per axis group, the system remains on wait and the "INCYC" indicator remains displayed in the status window.

Temporary stops during programme execution

These temporary stops are described below:

- the spindle continues to rotate (except for M00 or M01),
- programme execution can be restarted (in the mode active before the stop or in another mode) from where it was interrupted.

Feed interruption

Turn down the feed rate potentiometer on the machine panel to zero.

The "INCYC" indicator remains displayed in the status window.

Feed stop performed, current mode not cancelled.

Perform the desired operations or checks.

Restart movement by turning the feed rate potentiometer back up.

Mode change

The most frequent cases when the operator wishes to change the current mode are to:

- modify programme blocks (See 5.4.2.2),
- execute instructions outside the programme in manual data input mode (See 5.3).

Select another mode.

At the end of an interruptible block, the system cancels the current execution mode.

The "INCYC" indicator disappears from the status window, the newly selected mode replaces the previous mode (at the end of a machining cycle, when manual data input, edit, tool setting or search modes are requested).

Perform the desired operations.

Return to the initial mode.

Resume execution by pressing the "CYCLE" pushbutton on the machine panel.

Feed stop using the "FEED STOP" button

Movements can be interrupted immediately using the "FEED STOP" button on the machine operator panel (See 5.5.1.1).

Programmed stop

Reading function M00 (or M01 if enabled) interrupts programme execution and requires operator intervention (See 5.5.2.1).

Forcing of recall mode

The recall mode is forced when function M12 is read during programme execution and requires operator intervention (See 5.5.2.2).

End of programme execution

End of programme

Reading function M02 corresponds to the end of the programme.

The end of part programme indicator (M02) is displayed in the status window (See 3.1.3) and the "INCYC" indicator disappears.

Spindle rotation stops.

Press the "CYCLE" pushbutton on the machine panel to restart programme execution from the beginning.

Reset

A reset clears all the data currently being processed (See 5.5.1.8).

Incidents

When the system detects an error, the error indicator is displayed in the status window (See 3.1.3).

The error number, the block number with the error and the error message are displayed in the dialogue window of the information, programme and current position pages, e.g.:

error 77 Block N0
Tool type not compatible with the operation

Display the rest of the error message (for messages with more than one line).



The texts of the error messages are given in appendix B.

Determine the cause and correct the error.

The error indicator disappears.

Restart programme execution.

5.4.3.3 Execution of a Programme Step by Step

A programme can be executed step by step (blocks or parts of blocks) in single step mode to check that the machining procedure is being performed correctly.

Requirements

Measurement origin setting performed on the axes included in the programme.

No mode being executed. If a mode is being executed, selection of the single step mode is only taken into account after an interruptible block.

Programme selected as active programme (See 5.4.1.2).

Actions

Select the Mode softkeys.  

Display of the Mode softkeys at the bottom of the screen:



Select the single mode.  

Display of the single mode indicator in the status window (See 3.1.3).

Select a programme execution display page (See 5.4.3.2).

Start programme execution by pressing the "CYCLE" button on the machine panel.

Display of the "INCYC" indicator in the status window (See 3.1.3).

Execution of the block or part of block.

REMARK *If function M997 is programmed, the system operates as though it were in automatic mode and sequences blocks until it encounters an M998, M999 or M02 function.*

At the end of the block, the "INCYC" indicator disappears.

Start execution of the next block by pressing the "CYCLE" pushbutton.

5.4.3.4 High Speed Execution of a Programme

A programme can be executed at high speed (maximum speed authorised by the system) in order to check movements, tool changes, etc.

High speed execution can be performed with the part in place, in which case a programme origin shift (modification of DAT2, see 5.2.1.4) is required to complete the paths outside the part.

Requirements

Measurement origin setting performed on the axes included in the programme.

No mode being executed. If a mode is being executed, selection of the dry run mode is only taken into account after an interruptible block.

Programme selected as active programme (See 5.4.1.2).

Actions

Increase the value of the programme origin shift (DAT2), if required.

Select the Mode softkeys.



Display of the Mode softkeys at the bottom of the screen:



Select the dry run mode.

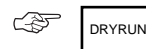

Display of the dry run indicator in the status window (See 3.1.3).

Select a programme execution display page (See 5.4.3.2).

Start the programme execution by pressing the "CYCLE" button on the machine panel.

Display of the "INCYC" indicator in the status window (See 3.1.3).

Execution of the programme at high speed.

At the end of the programme, the "INCYC" indicator disappears.

Return to the old value of the programme origin shift (DAT2).

5.4.3.5 Execution of a Programme in Automatic Mode

Parts are machined in automatic mode:

- programmed speeds are applied,
- programme executed in automatic mode from the beginning (%...) up to function M02.

Requirements

Measurement origin setting performed on the axes included in the programme.

No mode being executed. If a mode is being executed, selection of the automatic mode is only taken into account after an interruptible block.

Programme selected as active programme (See 5.4.1.2).

Actions

Select the Mode softkeys.  

Display of the Mode softkeys at the bottom of the screen:

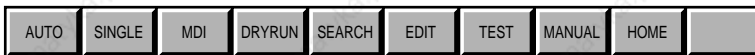

Select the mode continu.  

Display of the automatic mode indicator in the status window (See 3.1.3).

Select a programme execution display page (See 5.4.3.2).

Start the programme execution by pressing the "CYCLE" button on the machine panel.

Display of the "INCYC" indicator in the status window (See 3.1.3).

Execution of the machining procedure.

At the end of the programme, the "INCYC" indicator disappears.

5.5 Operator Interventions

During execution of a programme, two types of interventions may be required of the operator:

- unplanned intervention when a machining incident has occurred, or
- programmed intervention when a manual operation is required for the programme to continue.

5.5.1 Unplanned Interventions

Unplanned interventions are initiated by the operator. Certain of these interventions for which the procedures are described herein require declaring functions as present in the system and a machine panel with pushbuttons to activate them. By convention, the pushbuttons are considered as existing on the machine panel, but their actual locations (and names) on the machine are left up to the machine manufacturer (see manufacturers data).

5.5.1.1 Interruption of Machining

When machining is interrupted, all the movements on all the axes are stopped.

Actions

Press the "FEED STOP" button on the machine panel.

Display of the "CYHLD" indicator in the status window (See 3.1.3). The "INCYC" indicator remains displayed.

Machining is interrupted immediately, but the spindle continues to rotate.

The axes can be retracted (see 5.5.1.2).

5.5.1.2 Retracting the Axes

Axis retraction is related to interruption of machining (see 5.5.1.1). The toolhead is retracted manually by moving the axes with the jogs or handwheels. The axes must be stopped when the jog mode (FREE or HANDWH) is selected.

Requirements

Machining interrupted (CYHLD indicator lit).

Actions

Press the "AXRCL" button on the machine panel.

"INTER" indicator flashing in the status window (see 3.1.3). The axis jogs or the handwheels on the machine panel are enabled.

Retract the axes with the jogs or handwheels.

In the current position pages, the "TO GO" column displays the distance from the stop point.

Perform the operations required.

There are two ways of returning the axes to their starting position:

- Manually (see 5.5.1.3)
- Automatically (see 5.5.1.4).

Restart machining by pressing the "CYCLE" pushbutton on the machine panel.

The programme continues.

5.5.1.3 Manual Axis Recall

The axis recall function supplements interruption of machining (see 5.5.1.1). It is used to return the toolhead to its position prior to retraction (see 5.5.1.2) using the axis jogs or handwheels. The axes must be stopped when the jog mode (FREE or HANDWH) is selected.

Requirements

Machining interrupted on the system, axes moved ("INTER" indicator flashing).

Actions

Press the "AXRCL" button on the machine panel.

"AXRCL" indicator flashing in the status window (See 3.1.3).

The only movements authorised are those which return the axes to their starting position.

Bring the axes back to their initial position using the axis jogs or handwheels.

The axes move back to the position they occupied when machining was interrupted.

In the current position pages, the distance to the stop point decreases and finally reaches zero in the "TO GO" column.

Exit from the procedure

Once the axis recall function has been selected, it is possible to return to jog operations:

Press the "AXRCL" button on the machine panel again.

"INTER" indicator flashing in the status window.

The axes can be moved in both directions.

5.5.1.4 Automatic Axis Recall

Automatic axis recall is related to interruption of machining (see 5.5.1.1). When machining is interrupted, this function allows the axes to be returned automatically to their starting position along the same path as was used to retract them (see 5.5.1.2) by the jogs, since the path was stored (see figure under Notes).

REMARK *Automatic axis recall can be combined with Backtrack along path (see 5.5.1.6) and Return along path (see 5.5.1.7).*

Requirements

Machining interrupted, axes retracted ("INTER" indicator flashing).

Actions

Press the "Automatic Axis Recall" button on the machine panel (hold depressed).

The axes are automatically returned to the position they occupied when machining was interrupted (see Speed of movement and approach distance under Notes).

In the current position pages, the "TO GO" column shows the distance from the stop point decreasing until it reaches zero.

Notes on Automatic Axis Recall

Axis recall after retraction by handwheels

Caution: After retraction of the axes by the handwheels, automatic axis recall is enabled, but in this case, the axes may be recalled in any order. It is therefore not recommended to use this mode if the number of points stored in word N2 of machine parameter P114 is different from zero (see Parameter Manual). If the number of points is equal to zero, the axes are recalled by linear interpolation.

Number of retraction points stored

The number of retraction points that can be stored (maximum 10) is declared in word N2 of machine parameter P114 (see Parameter Manual).

REMARK *When the number of retraction steps exceeds the number of points that can be stored, the axes are recalled by linear interpolation up to the last point stored then paraxially on each axis up to the starting point.*

Speed of movement and approach distance d

Automatic axis recall takes place at the specified jog rate. However, approach of the recall point at the work rate can be specified at an approach distance d declared in word N3 of machine parameter P114 (see Parameter Manual). When the axes reach the point at distance d from the point where work is to be resumed, the feed rate applied is that programmed in the current block.

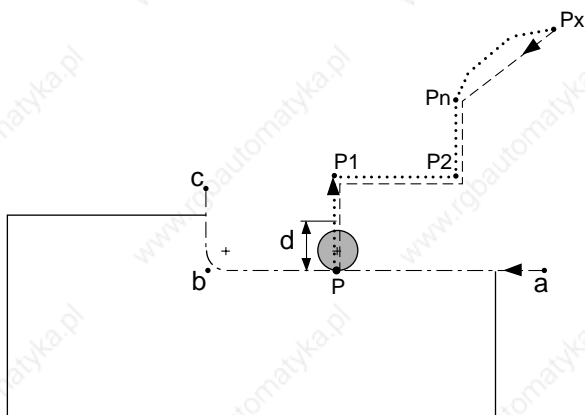

a, b, c: Programmed tool path
 P: Tool stop point (machining interrupted)
 P1 to Pn...: Retraction path (maximum 10 points)
 Pn to Px: Retraction path not stored
 Pn: Last point stored

Automatic axis recall

Px to Pn ...: Recall linear up to last stored point Pn
 Pn to P: Return to restart point P (see d)
 d: Approach distance

5.5.1.5 Sequence Number Search

The sequence number search mode is used to start execution of a programme from a given block.

This mode can be used to restart machining which has been interrupted for emergency retraction once the incident has been sorted out.

Requirements

Measurement origin setting performed on all the axes.

No mode being executed. If a mode is being executed, selection of the sequence number search mode is only taken into account after an interruptible block (interruption is not possible during a machining cycle).

Programme selected as active programme (See 5.4.1.2).

No intervention in progress.

Actions

Select the Mode softkeys.



Display of the Mode softkeys at the bottom of the screen:



Select the search mode.

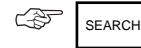

The search mode indicator is displayed in the status window (See 3.1.3).

Enter the coordinates of the sequence to be searched for (See syntax)



Syntax (repeat as many times as there are axis groups)

N[block No.].[group No.] H[S/R No.]:[No. of times]

N[block No.] number of the block to be selected (belonging to the main program or the specified subroutine), this term is mandatory

.[group No.] axis group number: this term must be specified for each of the axis groups when using axis multigroups

H[S/R No.] subroutine number; this term is not used unless the block searched for belongs to a subroutine

:[No. of times] number of times the block number is to be read before stopping the search

Start the search by pressing the "CYCLE" button on the machine panel.

Display of the "INCYC" indicator in the status window (See 3.1.3).

Analysis of blocks from the start of the programme:

- values stored,
- coded M functions (list supplied by the OEM) sent to the PLC,
- decoded M functions (See A.1.2) and T functions (tools) sent to the PLC if allowed by the configuration (function of parameter P7 defined by the OEM).

Stop on the block preceding the block to be found.

The "INCYC" indicator disappears.

Press the "CYCLE" button on the machine panel.

Display of the "INCYC" indicator in the status window (See 3.1.3).

Execution by the system of the auxiliary functions (decoded M functions, S and T functions) stored during the search.

The "INCYC" indicator disappears.

Display of the "CYHLD" and "AXRCL" indicators in the status window (See 3.1.3) if the axes are not in position.

Move the axes into position (See 5.5.1.3).

Press the "FEED STOP" button on the machine panel.

The "CYHLD" indicator is cleared from the status window.

Select: automatic, single, dry run or test and continue programme execution.

Incidents

When the block number to be found does not exist, the system displays the error indicator in the status window (See 3.1.3) and the message:

error 35 block N..
Searched for sequence number not found

Acknowledge the error.



Restart the search using a valid number.

Notes

Searches for unnumbered blocks cannot be performed. In such cases, search for the preceding numbered block.

Exit from the procedure

To interrupt a search:

Cancel the search.



First, the "RESET" indicator, then the end of part programme indicator (M02) are temporarily displayed in the status window (See 3.1.3) and the "INCYC" "CYHLD" and "AXRCL" indicators disappear (if displayed).

5.5.1.6 Backtrack along Path

After an interruption in machining (5.5.1.1), the Backtrack along path function is used to repeat the programmed tool path blocks in the reverse direction. When the backtrack point is reached, the user can return to the initial position by the Return along path function (see 5.5.1.7).

Requirements

Machining interrupted (see 5.5.1.1).

Actions

If necessary, set a tool/workpiece datum shift (see Tool/workpiece datum shift under Notes).

Press the "Backtrack along path" button on the machine panel (hold depressed).

Backtrack takes place in the mode selected (see Movement mode under Notes).

In the current position page, the "TO GO" column is displayed for the axes selected.

Release the "Backtrack along path" button when the backtrack point is reached.

Backtrack is immediately stopped.

Perform the actions which made backtrack necessary.

The system allows a return to a selected position on the tool path to be made by the Return along path function (see 5.5.1.10) or programming to be resumed by cancelling the machining interruption (see Programme resumption under Notes).

Exit from the procedure

If no tool/workpiece datum shift was programmed or this shift has been cancelled (see Tool/workpiece datum shift under Notes), machining can be resumed at any time.

Release the "Backtrack" pushbutton.

The current backtrack is immediately stopped.

Press the "CYCLE" pushbutton to resume machining.

The "INCYC" indicator comes on in the status window (see 3.1.3) and programme execution is resumed (see Movement mode under Notes for the speed of movement). During resumption, a new machining interruption can be requested by pressing "FEED STOP".

Notes on Backtrack along Path and Return along Path

Backtrack (and return) along path are possible in automatic (AUTO), single step (SINGLE) or dryrun (DRYRUN) mode:

- In automatic mode, the blocks are sequenced automatically as long as the operator holds the "Backtrack" or "Return" button depressed, at the rate declared in the block being executed.
- In single step mode, movement is continuous until the beginning of the current block (movement is stopped if the operator releases the "Backtrack" or "Return" button). To backtrack (or return) to the beginning of the next block, it is necessary to press "Backtrack" or "Return" again. Movement is at the speed declared in the current block.
- Execution in dryrun mode is the same as in automatic mode except that movement is at the traverse rate.

REMARKS *A change of mode (automatic, single step or dryrun) is always possible at the end of a block.
In single step mode, pressing "Backtrack" or "Return" at the end of a block forces a cycle start.
When resuming the block interrupted by "FEED STOP", the initial mode is restored.*

Tool/workpiece datum shift

A datum shift of the tool with respect to the workpiece can be applied to backtrack or return at any time (with machining interrupted and "CYHLD" indicator lit).

To shift the toolhead (for further information, see Sec. 5.5.1.2, Retracting the Axes), press the "AXRCL" button on the machine panel (the "AXRCL" indicator is lit in the status window) and retract the toolhead using the axis jogs.

This procedure is also use to change or cancel the datum shift.

REMARK A datum shift cannot be applied, edited or cancelled unless the "Backtrack" or "Return" button is released.

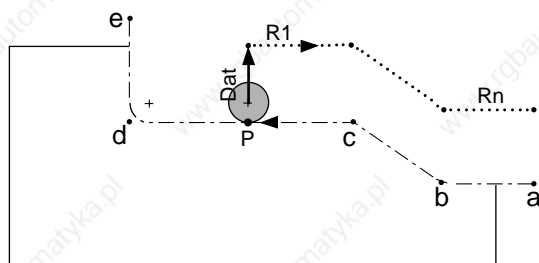

a , b, c, d, e: Programmed tool path
 P: Tool stop point (machining interrupted)
 Dat: Tool/workpiece datum shift (optional)
 R1 to Rn...: Backtrack along path

Resumption of programme execution

If no tool/workpiece datum shift is applied (or if the shift has been cancelled), machining can be resumed upstream ("Backtrack" and "Return" buttons released), i.e. the machining interruption can be cancelled (the "CYHLD" indicator in the status window goes out) and programme execution can be resumed in the current mode by pressing "CYCLE" (during resumption, a new machining interruption can be requested by pressing "FEED STOP").

Number of blocks stored during backtrack along path

The number of blocks (maximum 100) on which backtrack can be executed is declared in word N1 of machine parameter P114 (see Parameter Manual).

Restrictions on use of backtrack along path

It should be noted that:

- Only the functions related to axis movements are stored (G0, G1, G2, etc.) for backtrack, but not the other functions (M, T, S, etc.).
- The user cannot (even if the storage capacity allows) backtrack along the path beyond the point where the tool in use was called.
- The rigid tapping, rigid tap removal, inclined plane, RTCP and block skip functions cancel the remainder of the blocks stored and therefore stop execution of backtrack along path (the same is true for smooth polynomial interpolation).
- Sequenced thread cutting (G38) is performed as a linear interpolation (G1) during backtrack and return along path or programme resumption (see above).

Tool offsets

Dynamic tool offsets can be applied at any time to the current tool offset of the axis group, provided they are less than 0.1 mm. This offset is applied immediately in the block being executed and over the complete stored backtrack path.

Backtrack/return with multiple axis groups

With multigroups, backtrack and return are possible only for the first axis group.

5.5.1.7 Return along Path

The return along path function is indissociable from the backtrack along path function (see 5.5.1.6). After a backtrack along path, the return along path returns the toolhead to the position it occupied when machining was interrupted.

Requirements

Machining interrupted (see 5.5.1.1), backtrack along path completed ("Backtrack" button released).

Actions

Cancel (immediately or later) the tool/workpiece datum shift (see Tool/workpiece datum shift under Notes).

Press the "Return" button on the machine panel.

The return along path takes place in the movement mode selected (see Movement mode under Notes).

In the current position page, the "TO GO" column displays the distance from the end point.

Release the "Return" button when the selected return position is reached.

Resume machining by pressing the "CYCLE" pushbutton on the machine panel.

The programme continues.

Exit from the procedure

If no tool/workpiece datum shift was programmed or this shift has been cancelled (see Tool/workpiece datum shift under Notes), machining can be resumed at any time.

Release the "Return" pushbutton.

The return movement is stopped immediately.

Press the "CYCLE" pushbutton to cancel the machining interruption.

The "INCYC" indicator comes on in the status window (see 3.1.3) and programme execution is resumed (see Movement mode under Notes for the speed of movement). During resumption, a new machining interruption can be requested by pressing "FEED STOP".

Notes on Return along Path

The notes for return along path are the same as for backtrack along path (see 5.5.1.6).

5.5.1.8 Cancellation of an Operation in Progress

The operation in progress can only be cancelled if no movements are being performed, i.e. in one of the following cases:

- "INCYC" indicator not displayed in automatic, single, dry run or test modes,
- "CYHLD" indicator displayed in the status window,
- feed rate potentiometer set to zero and active (the potentiometer is not active in certain machining phases such as thread cutting),
- load mode in progress,
- unload mode in progress,
- search mode in progress,
- test mode in progress.

Stop the current processing.



First, the "RESET" indicator, then the end of part programme indicator (M02) are temporarily displayed in the status window (See 3.1.3) and the "INCYC" "CYHLD" and "AXRCL" indicators disappear (if displayed).

Spindle rotation stops.

5.5.1.9 Manual Data Input

Programme execution can be interrupted if a complementary instruction needs to be run:

Select the manual data input mode and execute the instructions (See 5.3).

Restart programme execution in one of the following modes: automatic, single, dry run or test.

5.5.1.10 Rotation Speed and Feed Rate Override Potentiometers

The operator can override the preset spindle rotation speed and feed rate:

- rotation speed from 50 to 100 %,
- feed rate from 0 to 120 %.

Override is effective in all modes concerning movement: manual, measurement origin setting, automatic, single, dry run and manual data input.

Actions

Adjust the spindle or feed rate potentiometer on the machine operator panel.

Display of the potentiometer values in the information page (See 4.7).

Notes

Programmed value exceeds limit values

During system integration, the OEM sets limit values in accordance with the mechanical characteristics of the machine.

If the programmed values exceed the limits:

real value = limit value x potentiometer coefficient (for values exceeding 100 % for the feed rate potentiometer, real value = limit value).

Potentiometers disabled

Function M49 renders the potentiometers inactive, the real values are therefore 100% of the programmed values.

5.5.1.11 Emergency Retraction

The emergency retraction function allows movement to be interrupted so that the tool can be retracted from the part following an incident (e.g. broken tool).

The emergency retraction function executes a pre-planned retraction procedure provided in the programme being executed (See Programming manual).

Actions

Press the "E/DISG" button on the machine panel.

Immediate interruption of machining and retraction in accordance with the procedure defined in the part programme.

The "CYHLD" indicator is displayed in the status window (See 3.1.3), the "INCYC" indicator remains displayed.

The axis recall indicator flashes in the status window (See 3.1.3).

In the current position pages, the "TO GO" column displays the distance from the stop point.

Perform the operations required.

Return the axes to their interrupted position (See 5.5.1.2).

Restart the machining procedure by pressing the "CYCLE" button.

The programme continues.

5.5.1.12 Intervention and Programme Resumption after an Error

During execution of a programme on the machine (see 5.4.3), the operator may decide to intervene if an error is detected by the system with display of a listed error message (see Appendix B for the list of error messages).

Before intervening, the operator should check the type of error message, which may be:

- an error message related to programming
- a machine error message (see 5.5.1.13 for the special case of programme resumption after a following error).

Case of programming error and programme resumption

Requirements

Programme interrupted in single step, automatic or dryrun mode. The fault indicator is displayed in the status window (see 3.1.3) and an error message is displayed in the dialogue window of the information, programme and current position pages, e.g.:

error 872 Block N120

No dimensions in blank definition

Actions

For messages with more than one line, display the complete message by pressing:



Analyse the message and the cause of the error.

Select Edit mode (see 5.5.2.1).

The error message is cleared and the start of the programme is displayed. The fault indicator is cleared.

REMARK *In certain cases, it is necessary to acknowledge the error message by pressing:*



Correct the programming error (see 5.4.2.2).

REMARK *For security, it is recommended to test the programme (see 5.4.2.6) before resuming machining.*

When editing is finished, machining can be resumed:

- au début du programme (Voir 5.4.3) ou à un bloc déterminé dans le programme (Voir 5.5.1.5),
- dans les modes, séquentiel (SEQ), continu (CONT), ou rapide (RAP) (Voir 5.4.3.2).

Case of machine error and programme resumption

Requirements

Programme interrupted in single step, automatic or dryrun mode. The fault indicator is displayed in the status window (see 3.1.3) and an error message is displayed in the dialogue window of the information, programme and current position pages, e.g.:

error 32 Block N150
HOME error/Slide already on origin switch

Actions

For messages with more than one line, display the complete message.
by pressing:



Analyse the message and the cause of the error.

REMARK *Such errors generally require the intervention of maintenance personnel.*

Reset the machine.



The RESET indicator and end of part programme indicator M02 are displayed momentarily and the fault indicator is cleared from the status window (see 3.1.3). The error message is cleared and the "INCYC", "CYHLD" and "AXRCL" indicators disappear from the status window (if they were present).

Correct the error if the cause was clearly identified.

After correcting the error, machining can be resumed:

- at the beginning of the programme (see 5.4.3) or at the specified block (see 5.5.1.5)
- in single step (SINGLE), automatic (AUTO) or dryrun (DRYRUN) mode (see 5.4.3.2).

If the fault persists, call the maintenance department of the company or Num customer support.

5.5.1.13 Programme Resumption after a Following Error

When the system detects a following error during axis movement, it generates one of error messages 40 to 71 and interrupts execution of the programme.

The Programme resumption after an error function allows the following error detected to be cancelled and the programme to be resumed. However, this function is only available for certain types of automatic controls.

Requirements

Programme interrupted, fault indicator displayed in the status window (see 3.1.3). An error message is displayed in the dialogue window of the information, programme and current position pages, e.g.:

error 42 Block N90
Following error too large on axis 2

Actions

Press the "Resume on error" button of the machine panel.

If the current mode is automatic (AUTO), single step (SINGLE), manual data input (MDI) or dryrun (DRYRUN), the system automatically goes into manual axis recall mode ("AXRCL" indicator flashing). If this is not the case, see Restrictions below.

Return (if necessary) the CNC and PLC axes along the programmed path using the jogs.

Place the axes in the position they occupied when the programme was interrupted by the error.

In the current position page, the "TO GO" column displays the distance from the end point.

Press the "CYCLE" button to cancel the programme interruption.

The "INCYC" indicator is displayed in the status window (see 3.1.3) and programme execution is resumed.

Restrictions

If the system is not in automatic (AUTO), single step (SINGLE), manual data input (MDI) or dryrun (DRYRUN) mode, axis recall is impossible. In this case, the only way to resume the cycle is by a reset.



CAUTION

The following error cannot be cancelled with certain applications which calculate references using dynamic offsets.

5.5.2 Programmed Interventions

Programmed interventions are planned within a programme to require operator intervention.

5.5.2.1 Machining Stop Function M00 (or M01 if enabled)

After programme execution has been stopped by function M00 (or M01 if enabled), the operator must perform the planned operation and then restart programme execution.

Actions

Display of the "M00" indicator in place of the "INCYC" indicator in the status window (See 3.1.3).

Spindle rotation stops.

The operator must perform the required operation (a message may be displayed).

Perform the operation.

Restart programme execution by pressing the "CYCLE" button.

The programme continues.

5.5.2.2 Forcing an Intervention by M12

After programme execution has been stopped by function M00 (or M01 if enabled), the operator must perform the planned operation and then restart programme execution.

Actions

Movement stops at the end of the block.

The "CYHLD" indicator is displayed in the status window (See 3.1.3), the "INCYC" indicator remains displayed.

The axis jog controls on the machine panel are active, the spindle continues to rotate.

The operator must perform the required operation.

Perform the operation (including any jog operations).

Restart programme execution by pressing the "CYCLE" button.

The programme continues.

5.5.2.3 Wait for Report

During certain operations requiring manual intervention (e.g. manual tool changes programmed by M06), the operator must report the completion of the operation.

Actions

Perform the required operations.

Press the button provided by the OEM to send the report.

The programme continues.

5.6 CNC Information Archiving

Requirements

System switched on.

No mode being executed.

Actions

Select the 2nd page of Mode softkeys.



Display of the 2nd page of Mode softkeys at the bottom of the screen:



Select the unload mode.



Display of the "FILE UNLOADING MENU" and the unload mode indicator in the status window:

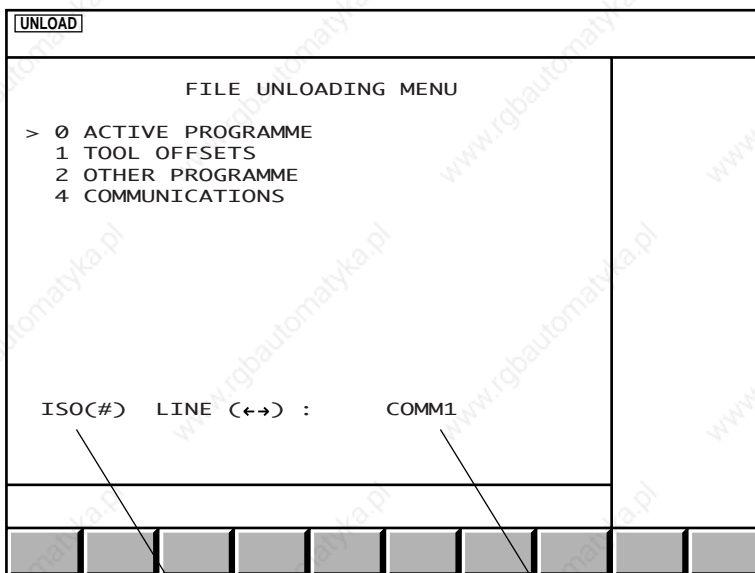

1 - Serial line selected

2 - Character code

To select an item, move the cursor onto the item with the up and down arrow keys or enter the item number then press .

Selecting the serial line

The CNC serial line parameters must be set (See 8.3) according to the peripheral (See peripheral manual).

Set the peripheral transmission parameters.

Select the serial line set for the peripheral.

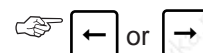

The line selected is displayed.

Code selection

The operator selects the character code (ISO or EIA) used to save programmes and tool dimensions.

Switch between codes.



Display of the selected code at the bottom of the screen.

REMARK Only the ISO code can be used to print a programme or tool offsets.

5.6.1 Unloading Programmes

Unloading part programmes consists of transferring the characters comprising the programme to a computer or peripheral to:

- Backup the programme on a storage medium,
- Print the programme listing.

Systems with axis multigroups

In systems with axis multigroups, a programme must be defined by a prefix (% [Programme No.]) followed by a dot and then a suffix corresponding to the number of the axis group to which the programme is assigned.

Unloading a programme defined only by its prefix (e.g. %28) causes all the associated programmes for each axis group (%28.1, %28.2, %28.3, etc.) to be unloaded one after the other (without Xoff characters in between).

5.6.1.1 Unloading the Active Programme

Requirements

Unloading from a peripheral	Unloading from a computer
Link established with the peripheral (See C.2)	Link established with the computer and file name selected (See C.3)
Peripheral ready to receive data (See peripheral manual)	

"FILE UNLOADING" menu displayed on the screen and transmission line and character code selected (See 5.6).

Actions

Select "ACTIVE PROGRAMME".

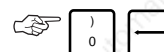

The cursor moves to the following line:

0 ACTIVE PROGRAMME

Start unloading.



Display of the "INCYC" indicator in the status window (See 3.1.3).

The programme is unloaded to the peripheral for backup or printout.

Display of the programme being unloaded.

When the unloading procedure has been completed, the "INCYC" indicator disappears and the "FILE UNLOADING" menu is displayed.

REMARK When several programmes with different suffixes (%X.0, %X.1, %X.2, ...) correspond to the number of the active programme, these programmes are archived one after the other (without Xoff characters between).

Aborting of the procedure

Stop the unloading procedure.



The unload mode and "INCYC" indicators disappear and the current position page is displayed (See 4.2).

5.6.1.2 General Case of Part Programme Unloading

Requirements

Unloading from a peripheral	Unloading from a computer
Link established with the peripheral (See C.2)	Link established with the computer and file name selected (See C.3)
Peripheral ready to receive data (See peripheral manual)	

"FILE UNLOADING" menu displayed on the screen and transmission line and character code selected (See 5.6).

Actions

Select "OTHER PROGRAMME".

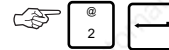

The cursor moves to the following line:

2 OTHER PROGRAMME

Start unloading.



Display of the "INCYC" indicator in the status window (See 3.1.3).

Display on the dialogue line:

(% OR %* OR %..) █

Select the programme(s) to be unloaded (See syntax below).



Programmes to be unloaded	Syntax
All programmes	%%
Active programme	%*
Programme %X.Y	%X.Y
All programmes with prefix %X (%X.1, %X.2...)	%X

The programme(s) is (are) unloaded to the peripheral for backup or printing.

Display of the programmes being unloaded.

When the unloading procedure has been completed, the "INCYC" indicator disappears and the "FILE UNLOADING" menu is displayed.

REMARK *When several programmes are unloaded in the same operation, they are archived one after the other (without Xoff characters between).*

Incidents

When the programme selected does not exist, the cursor moves to the "%".

Enter the name of another programme in the dialogue line and restart the procedure.

Exit from the procedure

Stop the unloading procedure.



The unload mode and "INCYC" indicators disappear and the current position page is displayed (See 4.2).

5.6.2 Unloading Tool Tables

Tool tables are unloaded by transferring the values comprising the table to a computer or peripheral in order to:

- save them on a storage medium.
- print them out.

Requirements

Unloading from a peripheral	Unloading from a computer
Link established with the peripheral (See C.2)	Link established with the computer and file name selected (See C.3)
Peripheral ready to receive data (See peripheral manual)	

"FILE UNLOADING" menu displayed on the screen and transmission line and character code selected (See 5.6).

Actions

Select "TOOL OFFSETS".

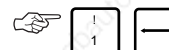

The cursor moves to the following line:

1 TOOL OFFSETS

Start unloading.



Display of the "INCYC" indicator in the status window (See 3.1.3).

The tool offsets are unloaded to the peripheral for backup or printing.

When the unloading procedure has been completed, the "INCYC" indicator disappears.

Exit from the procedure

Stop the unloading procedure.



The "INCYC" indicator disappears.

5.7 Creation of a Part Programme

5.7.1 Creation of a Part Programme Using Interactive Programming (PROCAM)

The PROCAM software enables programmes to be produced by users who are unfamiliar with ISO programming techniques.

The user is guided through a series of menus and can graphically display part or all of his programme at any time.

The following section describes how to access PROCAM: this function is explained in detail in the PROCAM MILL interactive programming manual.

Requirements

"GRAPHIC PROGRAMMING" menu displayed (See 4.6).

Actions

Select "INTERACTIVE PROGRAMMING".

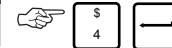

Display of the "INTERACTIVE PROGRAMMING" page:

INTERACTIVE PROGRAMMING		VERSION 6.0
PROGRAM TO CREATE OR MODIFY	NUMBER	<<<<<<
PAGE TO MODIFY OR LOCATE	NUMBER	█
AUTO FEED INCREMENT		10
WORKING PLANE FOR GRAPHIC DISPLAY		Z - X
VIEW	DISPLAY A PROGRAM IN MEMORY	
EDIT	PROGRAM MODIFICATION - INSERTION - DELETION	
NEW	PROGRAM CREATION	
../..	ACCESS TO TOOL AND MATERIAL FILES	
=		
VIEW	EDIT	NEW
../..		
		OUT

Refer to the Interactive Programming Manual.

Exit from the procedure

Exit PROCAM.



Return to the "GRAPHIC PROGRAMMING" menu.

5.7.2 Creating Contours with the PROFIL Function

The PROFIL function allows you to create contours within a part programme using a sequence of geometric elements.

The contours created are stored at the end of the part programme and are executed by calls to subroutines.

The PROFIL function is accessed from the programme editor in background mode (See 5.9.1).

Options are available by softkeys F1 to F12, and the contour is displayed graphically while being drawn.

This section describes access to the PROFIL function. This function is described in detail in the PROFIL function operator manual.

Requirements

Part programme displayed by the programme editor in background mode (See 5.9.1).

Actions

Call the PROFIL function.

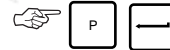

The PROFIL start page is displayed, for instance:

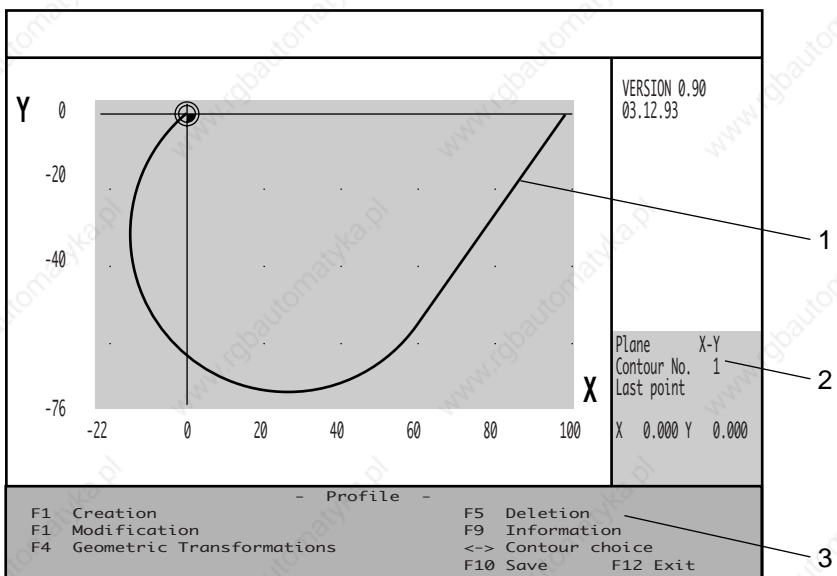

- 1 - Contours already defined in the programme
- 2 - Data on the contour selected (red)
- 3 - Operations accessed by keys F1 to F12

Refer to the PROFIL operator manual.

5.7.3 Creation of a Part Programme by Tuition

The edit mode can be used to:

- access axis jog controls to change the current position,
- enter the values of the current position coordinates into the modified programme.

This function allows all or part of a programme to be written by teaching specific positions.

The coordinates of the current position are indicated by "I".

Requirements











Measurement origin setting performed (See 5.1.2).

System in edit mode (See 5.4.2.1) and programme to be edited displayed (if the programme is to be written from scratch, create an empty programme including only the programme number, See 5.4.2.2).

Actions

Move to the position desired using the axis controls (See 5.1.1).

Enter the command corresponding to the operation to be performed (See table).

Operation to be performed	Block selected	Command
Insert a block containing all the coordinates of the current position	Previous block	+ [start of block to be inserted] !  
Insert a block containing the coordinates of certain axes	Previous block	+ [start of block] ![axis addresses] example: "N210 G00 !X" inserts block "N210 G00 Xxxx"  
Replace the coordinates of the axes contained in a block by the coordinates of the current position	Block to be modified	# !  
Replace the coordinates of certain axes contained in a block by the coordinates of the current position	Block to be modified	# ![axis addresses] example: "# !Z" only modifies the coordinates of the Z axis if it is present in the block  
Add the coordinates of axes not present in the block (without modifying the axes already present)	Block transferred to dialogue line cursor at end of block	![axis addresses] example: "!C" adds the coordinates of the C axis at the end of the block  

Refer to Section 5.4.2.2 for use of the edit mode (in particular for the pointing and block transfer functions).

5.8 Inch/Metric Unit Selection

The internal system unit defined by word N2 of machine parameter P4 (See Parameter Manual) is a multiple or submultiple of the micrometre.

Values contained in display pages and movement programming functions can be expressed in either millimetres or inches.

5.8.1 Display Unit Selection

The display unit used depends on the state of bit C_UNIT (See Automatic Control Function Programming Manual and Appendix D) of the PLC memory:

- when C_UNIT = 0, the unit used is the millimetre,
- when C_UNIT = 1, the unit used is the inch.

5.8.2 Programming Unit Selection

The unit to be used in programmed coordinates is defined by two G functions which are mutually exclusive:

- with G70, the unit used is the inch,
- with G71, the unit used is the millimetre.

One of these functions is automatically initialised upon power up or when the status returns to M02 (depends on bit 3 of word 0 of machine parameter P7, see Parameter Manual), but the other function can be selected during programming.

5.8.3 Consequences of Unit Selection on Values

The formats indicated in the table give the following information:

- a + sign at the beginning denotes an algebraic value (+/-),
- a 0 indicates that leading zeros can be omitted (e.g. 5 = 005),
- the first digit different from 0 gives the number of digits before the decimal point,
- the last digit gives the number of decimal digits.

The formats specified are valid when the internal system unit is the micrometre.

When the internal unit is different, the decimal point is shifted right by the number of powers of 10 between the internal unit and the micrometre (left if negative). For instance, if the internal unit is 10^{-1} micrometre, format 053 becomes 044 (decimal point shifted one step left).

Value	Unit	Format	Remarks
Shifts (DAT1, DAT2, DAT3) displayed in the shift page (See 4.3) or entered via the keyboard	mm if C_UNIT = 0 inches if C_UNIT = 1	+053 +044	
Tools offsets (X, Z and R) displayed on the tool offset page (See 4.4) or entered from the keyboard (See 5.2.2.2)	mm if C_UNIT = 0 inches if C_UNIT = 1	+043 +034	
Dimensions of the preset displayed and entered via the keyboard in tool setting mode (See 5.2.2.1)	mm if C_UNIT = 0 inches if C_UNIT = 1	+043 +034	
Tool wear offsets (DX and DZ) displayed in wear offsets pages (See 4.4) or entered via the keyboard (See 5.2.2.4)	mm if C_UNIT = 0 inches if C_UNIT = 1	+013 +014	maximum: 0.999 maximum: 0.0393 values in inches rounded off to the nearest value of the internal unit

Value	Unit	Format	Remarks
In the current position page (See 4.2): - coordinates of current position or distance left to travel - following error	mm if C_UNIT = 0 inches if C_UNIT = 1 micrometre	+053 +044	
In tuition mode (See 5.7.3), the coordinates copied in to the programme are the coordinates of the current position	mm if C_UNIT = 0 inches if C_UNIT = 1	+053 +044	make sure that the production unit (See G70 / G71) is the same as the input unit
In edit mode (See 5.4.2) or manual data input mode (See 5.3), entry of coordinates X, Z...	Production function in G70 or G71	+053 +044	si C_UNIT = 0 si C_UNIT = 1
Loading tool tables by peripheral or computer (See 5.2.2.3)	mm if C_UNIT = 0 inches if C_UNIT = 1		
Increment in manual mode (See 5.1.1.3)	µm if C_UNIT = 0 10 ⁻⁴ inches if C_UNIT = 1		conversion remainders are accumulated
Execution of coordinates programmed or input in MDI mode: X, Y, Z, U, V, W, I, J, K, P, Q, R and ER	mm in G71 inches in G70	+053 +044	
Feed rate F in G94	mm / min in G71 inches / min in G70		
Feed rate F in G95	mm / rev in G71 inches / rev in G70		
In information page (See 4.7): modal dimensions (X, Z...) and dimensions of current tool (X, Z and R)	mm in G71 inches in G70		
Coordinates in a programme listing displayed in the directory page (See 4.5) or the programme page (See 4.8), unloaded to a peripheral (See 5.6.1) or loaded from a peripheral (See 5.4.1.1)	The programme listing is not modified by the units selected (only the interpretation of coordinates by the system during machining is affected)		
Programme variables (L, see 4.9) and external parameters (E, see 4.10.2)	No modification (these variables are stored as dimensionless numbers and are not assigned a unit until used)		

 **CAUTION**

When tool tables are loaded from a peripheral or a host computer, the value of bit C_UNIT must be the same as when they were unloaded. Otherwise, the loaded values will be changed.

When creating or editing a programme via the keyboard, a coordinate whose format is compatible with C_UNIT may be refused during execution if its format is incompatible with G70 or G71 (e.g. C_UNIT = 1 can authorise write of X4.9998 which is refused if execution takes place in G71).

5.9 Part Programme Operations in Background Mode

The operations for processing programmes (loading, unloading, editing) use specific CNC modes.

Since these modes are mutually exclusive, operations on programmes prevent the use of another mode and particularly machining modes.

To avoid this problem and the consequent loss of time, the CNC includes functions which enable operations on programmes to be performed in background mode while automatic, single, dry run or manual modes are being executed.

Requirements

Basic softkeys displayed.

Actions

Select the "GRAPHIC PROGRAMMING" menu.



Display of the "GRAPHIC PROGRAMMING" menu:

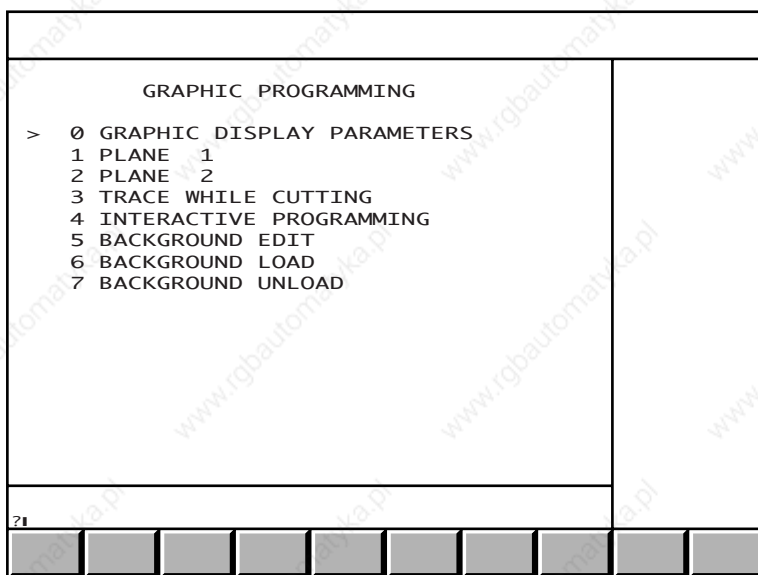

To select an item, move the cursor onto the item with the up and down arrow keys or enter the item number then press .

If the system was in edit, load or unload mode, the mode is no longer selected.

Items 5, 6 and 7 are not displayed if the associated modes: background edit, background load and background unload respectively, are inhibited.

5.9.1 Programme Creation or Editing

Requirements

"GRAPHIC PROGRAMMING" menu displayed (See 5.9).

One of the Auto, Single, Dryrun or Manual modes selected or no mode selected.

Actions

Select "BACKGROUND EDIT".



Display of the message:

ENTER PROGRAM NUMBER

Enter "% [Programme No.]" (to be created or edited).



Programme editing

Display of the programme listing where the block pointer is displayed as "=".

Make the changes in edit mode (See 5.4.2.2).

Programme creation

Display of the message:

No programme with that number exists in the protected area	A programme with the same number exists in the protected area
Display of the message: CREATE NEW PROGRAMME? (Y/N):█	Display of the message: WARNING: this programme exists in a protected zone. Create the programme in zone 0?(Y/N):█

Confirm creation of the programme.



Display of the line:

=%[Programme No.]

Create the programme blocks using the edit mode functions (See 5.4.2.2).

Notes

Programme duplication

When a programme is being executed, any programmes created or modified in background are duplicated programmes: the duplication of the active programme allows modification while the active programme is being executed.

The duplicated programmes are displayed in the directory page (See 4.5.1) and indicated by "%- [Programme No.]" which differentiates them from normal/programmes which can be executed (% [Programme No.]).

When current programme execution has been completed (status: M02), the duplicated programmes are enabled and can then be executed.

Note concerning edit mode

Calling the edit mode when a programme is being executed interrupts execution at the end of the block (See 5.4.3.2).

If there are any duplicated programmes (See above), they are not accessible and any attempt to call them results in the following message being displayed:

ACCESS TO PROGRAM DENIED: AWAIT RESET

For these programmes to be called in edit mode, they must first have been enabled by the end of execution of the active programme (M02).

IncidentsThere is insufficient memory to store a duplicated program

Display of the message:

PROGRAM MEMORY FULL

Loading is in progress

Display of the message:

REFUSAL: Program zone access conflict

Acknowledge the message.



Wait for the end of the loading procedure and then restart the procedure.

The "BACKGROUND EDIT" function cannot be accessed

The interactive programming function cannot be accessed in background mode except in the authorised modes (See requirements).

Display of the message:

REFUSAL: Disallowed in this mode

Exit by selecting a display page.

Exit from the procedure

Exit the background edit function by selecting a display page.

All modifications are stored and will be enabled when the active programme has been executed.

5.9.2 Loading Part Programmes from a Peripheral

Part programmes can be loaded from peripherals such as tape reader, PC, diskette drive.

For loading from a NUM diskette drive, see 5.9.6.

Requirements

Link established with the peripheral (See C.2).

Peripheral ready to send data (See peripheral manual).

"GRAPHIC PROGRAMMING" menu displayed (See 5.9).

One of the Auto, Single, Dryrun or Manual modes selected or no mode selected.

Actions

Select "BACKGROUND LOAD".

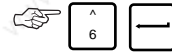

Display of the shortened version of the "FILE LOADING" menu:

FILE LOADING MENU	
> 0 PROGRAMMES 1 TOOLS OFFSETS 4 DIALOGUE SERVICE DISKETTE	
LINE (↔) :	COMM1
?	
<div style="display: flex; justify-content: space-around;"> <div style="width: 100px; height: 15px; background-color: #ccc;"></div> <div style="width: 100px; height: 15px; background-color: #ccc;"></div> <div style="width: 100px; height: 15px; background-color: #ccc;"></div> <div style="width: 100px; height: 15px; background-color: #ccc;"></div> <div style="width: 100px; height: 15px; background-color: #ccc;"></div> <div style="width: 100px; height: 15px; background-color: #ccc;"></div> <div style="width: 100px; height: 15px; background-color: #ccc;"></div> <div style="width: 100px; height: 15px; background-color: #ccc;"></div> <div style="width: 100px; height: 15px; background-color: #ccc;"></div> <div style="width: 100px; height: 15px; background-color: #ccc;"></div> </div>	

Items 1 and 4 of the menu are not displayed unless the line selected is configured for the Kermit protocol (See C.2.3).

To select an item, move the cursor onto the item with the up and down arrow keys or enter the item number then press .

Selecting the serial line

The CNC serial line parameters must be set (See 8.3) according to the peripheral (See peripheral manual).

Set the transmission data rate of the peripheral.

Select the serial line set for the peripheral.

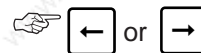

Display of the line selected.

Start loading.



Display of the message:

Request access to serial link

Exit with message: "<<--"

Start the data transmission procedure over the link.

Display of the message:

Loading in progress

Display of the message:

Loading completed

Exit with message: "<<--"

The programmed is stored.

Acknowledge the message displayed.



Loading of several consecutive programmes not separated by Xoff characters

If several programmes not separated by Xoff characters (ASCII character code 19) are included in the loaded file, the programmes are loaded one after the other.

Loading of several consecutive programmes separated by Xoff characters

If several programmes are included in the loaded file, reading stops when an Xoff character is encountered.

Start the procedure to load the next programme.



Each programme is loaded in the same way.

Incidents

The loaded programme has the same number as a programme already in memory

Display of the message:

Existing program

Exit with message: "<<--"

Acknowledge the message.



Display of the message:

PROG. EXISTS - OK TO OVERWRITE ? (Y,N) :█

Enter the letter corresponding to the desired action (Y for yes, N for no).



A positive answer causes the old programme to be overwritten and the new programme to be stored.

A negative answer cancels the data loaded.

Unloading in progress

If you select "PROGRAMMES", the following message is displayed:

REFUSAL: Other function in progress

Wait for the end of the unloading procedure and then restart the procedure.

The "BACKGROUND LOAD" function cannot be accessed

Programmes cannot be loaded in background mode except in the authorised modes (See requirements).

Display of the message:

REFUSAL: Disallowed in this mode

Exit by selecting a display page.

Exit from the procedure

Exit without interrupting the loading procedure

Select a display page.

Loading continues in background while other CNC functions are being used.

Stop loading

Invoke the message prompt.



Display of the message:

Abort: "9 ENTER" end of process

Exit the loading procedure.



Return to the shortened version of the "FILE LOADING" menu.

Loading is interrupted, only programmes which have been completely loaded are stored.

5.9.3 Unloading a Part Programme

Unloading part programmes consists of transferring the characters comprising the programme to a peripheral such as a tape reader, PC, diskette drive or printer in order to:

- Backup the programmes on a storage medium,
- Print the programme listing.

For unloading to NUM diskette drive, see 5.9.7.

Requirements

Link established with the peripheral (See C.2).

Peripheral ready to receive data (See peripheral manual).

"GRAPHIC PROGRAMMING" menu displayed (See 5.9).

One of the Auto, Single, Dryrun or Manual modes selected or no mode selected.

Actions

Select "BACKGROUND UNLOAD".

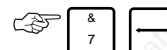

Display of the shortened version of the "FILE UNLOADING" menu:

FILE UNLOADING MENU		
>	0 ACTIVE PROGRAMME	
	1 TOOL OFFSETS	
	2 OTHER PROGRAMME	
	4 DIALOGUE SERVICE DISKETTE	
ISO(##) LINE (←→) : COMM1		
?		

Items 1 and 4 of the menu are not displayed unless the line selected is configured for the Kermit protocol (See C.2.3).

To select an item, move the cursor onto the item with the up and down arrow keys or enter the item number then press .

Selecting the serial line

The CNC serial line parameters must be set (See 8.3) according to the peripheral (See peripheral manual).

Set the reception data rate of the peripheral.

Select the serial line set for the peripheral.

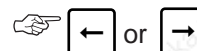

Display of the line selected.

Code selection

The operator selects the character code (ISO or EIA) used to save programmes and tool dimensions.

Switch between codes.



Display of the selected code at the bottom of the screen.

REMARK *When the programme or tool dimensions are to be printed, only the ISO code can be used.*

Incidents

Loading in progress

If you select "PROGRAMMES", the following message is displayed:

REFUSAL: Other function in progress

Wait for the end of loading and repeat the procedure.

The "BACKGROUND UNLOAD" function cannot be accessed

Programmes cannot be unloaded in background mode except in the authorised modes (See requirements).

Display of the message:

REFUSAL: Disallowed in this mode

Exit by selecting a display page.

5.9.3.1 Unloading the Active Programme to a Peripheral

Select "ACTIVE PROGRAMME".

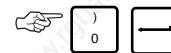

Display of the message:

Unloading in progress

Exit with message: "<<--"

The programme is unloaded to the peripheral for backup or printing.

When the unloading procedure has been completed, the following message is displayed:

Unloading completed

Exit with message: "<<--"

The programmed has been archived.

Acknowledge the message displayed.



REMARK *When several programmes with different suffixes (%X.0, %X.1, %X.2, ...) correspond to the number of the active programme, these programmes are archived one after the other (without Xoff characters between).*

Exit from the procedure

Exit without interrupting the unloading procedure

Select a display page.

Unloading continues in background while other CNC functions are being used.

Stop unloading

Invoke the message prompt.



Display of the message:

Abort: "9 ENTER" end of process

Exit the unloading procedure.

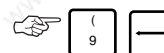

Return to the shortened version of the "FILE UNLOADING" menu.

Unloading is interrupted.

5.9.3.2 Unloading Part Programmes to a Peripheral

Select "OTHER PROGRAMME".

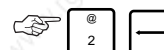

Display of dialogue line:

(%% OR %* OR %..) █

Select the programmes to be unloaded(See syntax below).



Programmes to be unloaded	Syntax
All programmes	%%
Active programme	%*
Programme %X.Y	%X.Y
All programmes with prefix %X (%X.1, %X.2...)	%X

Display of the message:

Unloading in progress

Exit with message: "<<--"

The programme is unloaded to the peripheral for backup or printing.

When the unloading procedure has been completed, the following message is displayed:

Unloading completed

The programmes are backed up.

REMARK *When several programmes are unloaded in the same operation, they are archived one after the other (without Xoff characters between).*

Incidents

The selected programme does not exist

Display of the message:

PROGRAM DOES NOT EXIST

Acknowledge the message.

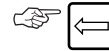

Restart the procedure with a programme which exists.

Exit from the procedure

Exit without interrupting the unloading procedure

Select a display page.

Unloading continues in background while other CNC functions are being used.

Stop unloading

Invoke the message prompt.



Display of the message:

Abort: "9 ENTER" end of process

Exit the unloading procedure.



Return to the shortened version of the "FILE UNLOADING" menu.

Unloading is interrupted.

5.9.4 NUM Diskette Drive

5.9.4.1 Description of the NUM Diskette Drive

The NUM diskette drive is used for part programme and tool offset file save and restore operations.

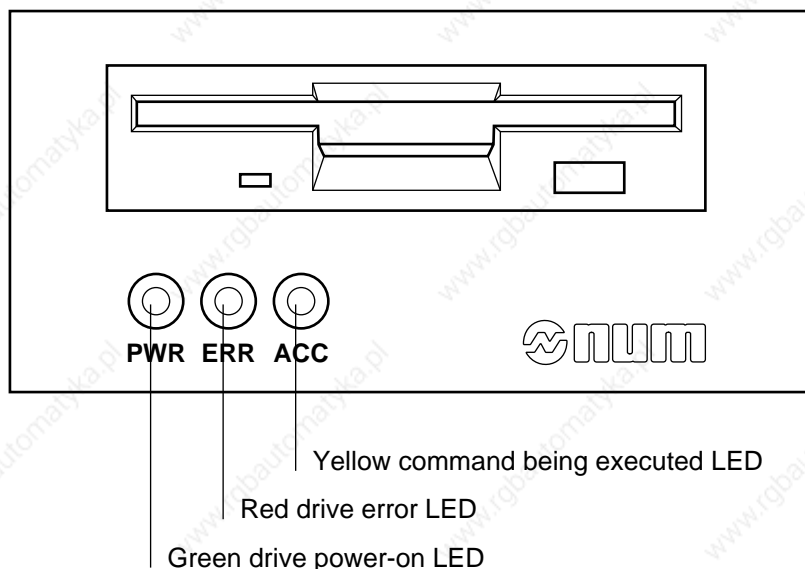

The drive includes an on/off switch at the rear.

5.9.4.2 Syntax Rules and Control of the Drive

The drive is controlled from the CNC by a language similar to MS-DOS. The drive/CNC interface is a serial link. The drive saves the data (part programmes, tool offsets) on a diskette in files that can be organised in directories and subdirectories.

The drive is controlled by commands whose syntax is detailed in Sections 5.9.5 to 5.9.7. Brackets in the command syntax enclose optional arguments.

The filename format is [filename].[ext] ([filename]: maximum 8 characters and [ext]: maximum 3 characters).

Directory names have a maximum of 8 characters and no extension.

Characters allowed in filenames:

- letters A to Z (not case sensitive)
- numbers 0 to 9
- special characters `_`, `-`, `$`, `~`, `!`, `#`, `{`, `}`, `%`, `@`.

Commands can be entered using the softkeys (in some cases also using the keyboard) or entirely from the keyboard.

The last command entered is displayed at the top of the screen. During execution, commands (except diskette format) can be aborted by the **ABORT** key.

REMARK A reset (key ) or the end of a programme may cause interference on the serial line and interrupt transmission (the red LED on the drive comes on and an error message may be displayed). In this case, repeat the command.

5.9.5 Operations on the NUM Diskette Drive

Requirements

Link established with the diskette drive and presence of a serial line configured for the Kermit protocol (See C.2.3).

"Kermit" serial line selected.

The reduced "FILE LOADING" (See 5.9.2) or "FILE UNLOADING" (See 5.9.3) menu is displayed.

Actions

Select "DIALOGUE SERVICE DISKETTE".   

The "SERVICE DISKETTE: DIALOGUE" page is displayed with the following softkeys:



Press the  key for help on the softkeys displayed:

KERMIT Commands

<FILE> : File management : <DIR>, , <RENAME>, <COPY>
 <DIR> : Directory management : <CD. .>, <CD>, <CD\>, <MKDIR>, <TREE>
 <DISK> : Diskette management : <SPACE>, <FORMAT>, <CHKDSK>
 <READER> : Drive controller management : <VER>

Pressing one of the keys displays a new softkey bar (See 5.9.4.1 to 5.9.4.4). The following line is displayed in the dialogue window:

Service_Diskette >|

The commands described below are used to dialogue with the drive.

End of the Procedure

Exit from the "SERVICE DISKETTE: DIALOGUE" page.  

5.9.5.1 Drive Management

Select drive management.  

The following softkeys are displayed:



Press the  key for help on the softkeys displayed:

Help on READER commands

<VER> : Display the drive software version
 <ABORT> : Abort the current command.

Displaying the Drive Software Version

Press.  

Information is displayed on the version in the following format:

NUM-FDD MS-DOS Kermit: Vers. 07.06.1994

Exit from the Procedure

Exit from the page.

**5.9.5.2 Diskette Management**

Select diskette management.



The following softkeys are displayed:

Press the key for help on the softkeys displayed:

Help on DISK commands

- <SPACE> : Display the space available on the diskette
- <FORMAT> : Format the diskette for use with MS-DOS
- <CHKDSK> : Check the diskette and corrects any errors found
- <ABORT> : Abort the current command.

Formatting a Diskette

This operation requires presence of a diskette in the drive. The diskette must either be unformatted or contain data to be deleted.

It is necessary to initialise diskettes in MS-DOS format before being able to save data on them. The diskette type (720 or 1440 KB) is automatically detected.

Command formatting of the diskette.



The following message is displayed in the dialogue window:

Format erases ALL data.
Confirm format Y/N ?

Confirm formatting.



Data are displayed while the diskette is being formatted:

formatting disk 720 KB
25%

At the end of formatting, the following data are displayed:

730112 byte(s) total disk space
730112 byte(s) available on disk

1024 byte(s) per cluster
713 cluster on disk available

REMARK *Formatting of a diskette is the only command that cannot be stopped by the* *key.*

Checking the Free Space on a Diskette

This operation requires the presence of a formatted diskette in the drive. It returns the space available on the diskette.

Check the free space on the diskette.



SPACE

The free space is displayed:

1456640 bytes available on drive A:

Checking a Diskette

This operation requires the presence of a formatted diskette in the drive. It returns the state of the diskette.

Check the diskette.



CHKDSK

Data on the state of the diskette are displayed:

```
CHKDSK
1457664 byte(s) total disk space
  130 byte(s) in 2 user files
1456640 byte(s) available on disk
```

```
  512 byte(s) per cluster
  2847 cluster on disk
  2845 cluster available on disk
```

Exit from the Procedure

Exit from the page.



OUT

Exiting from the page cancels current operations (except formatting).

5.9.5.3 Directory Management

Select directory management.



REPRT

The following softkeys are displayed:



Press the  key for help on the softkeys displayed:

DIRECTORY Management Commands

```
<CD..> : access the parent directory
<CD>   : CD [pathname]: e.g. CD dir1\dir11
        directory to be accessed
<CD\>  : access the root directory
<MKDIR>: MKDIR pathname: e.g. MKDIR dir1
        creates a directory structure on several levels
<RMDIR>: RMDIR pathname: e.g. RMDIR dir1
        deletes (remakes) an empty directory (the directory must not contain
        any files or subdirectories)
<TREE> : displays the directory tree structure.
```

Making a Directory

This operation requires the presence of a formatted diskette in the drive. It creates a subdirectory under the current directory.

Select the make directory command.



MKDIR

Display in the dialogue window of:

Service_Diskette >MKDIR █

Fill in the command (See syntax).



Syntax

MKDIR [name]

[name] name of the subdirectory to be created

After execution of the command, display of:

MKDIR

Remaking (Deleting) a Directory

This operation requires the presence of a formatted diskette in the drive. It deletes a subdirectory of the current directory. Deletion is impossible unless the directory does not contain any subdirectories or files.

Select directory deletion.



RMDIR

Display in the dialogue window:

Service_Diskette >RMDIR █

Fill in the command (See syntax).



Syntax

RMDIR [name]

[name] name of the subdirectory to be deleted

After execution of the command, display of:

RMDIR

Return to the Parent Directory

This operation requires the presence of a formatted diskette in the drive. It moves up one level in the directory tree structure. The parent directory becomes current directory.

Return to the parent directory.



CD..

Display of:

directory of A:\[pathname of new current directory]

Return to the Root Directory of the Diskette

This operation requires the presence of a formatted diskette in the drive. It causes a return to the root directory which becomes the current directory.

Return to the root directory. 

Display of:

directory of A:

Change Directory

This operation requires the presence of a formatted diskette in the drive. The directory whose pathname is specified becomes the current directory.

Change directory. 

Display in the dialogue window of:

Service_Diskette >CD █

Fill in the command (See syntax). 

Syntax

CD [pathname]

[pathname] names of the subdirectories (separated by "\") leading to the desired subdirectory

e.g.: [subdirectory 1]\...\[new current subdirectory]

REMARK *If there is no subdirectory corresponding to the pathname entered, a search is made for a subdirectory under the root with the same pathname.*

Display of:

directory of A:\[pathname of new current directory]

Display of the Directory Tree Structure

This operation requires the presence of a formatted diskette in the drive. It displays the tree structure of the diskette directories.

Select display of the directory tree structure. 

The directory tree structure is displayed, e.g.:

```
TREE
listing of directories
A:.
├── DIR1
│   ├── DIR11
│   └── DIR12
└── DIR2
    ├── DIR21
    └── DIR22
```

Exit from the Procedure

Exit from the page.



OUT

Exiting from the page cancels the current operations.

5.9.5.4 File Management

Select file management.



FILES

Display of the softkeys:



Press the key for help on the softkeys displayed:

FILE Management Commands

<DIR> : DIR [pathname][filename]: e.g. dir \dir1 cut*.pie
lists the files and subdirectories in the directory

 : DEL [pathname] filename: e.g. del \dir1\dir11*.dim
deletes the files specified

<RENAME> : RENAME [pathname] filename1 filename2: e.g. rename *.pie *.dim
renames one or more files

<COPY> : COPY source [+source] [+...] target
e.g. copy part1.pie+part2.pie part3.pie
copies one or more files to the target location specified

<ABORT> : abort the current command.

REMARK *The syntax using a pathname must always include a space and the character "\" before the pathname and a space before the filename.*

Display Directory Contents

This operation requires the presence of a formatted diskette in the drive. It displays the list of files and subdirectories contained in a directory (all or as selected by name or extension).

Select directory content display.



DIR

Display in the dialogue window of:

Service_Diskette >DIR *.*|

Specify a filename if desired (See syntax).



Syntax

DIR ([pathname]) [filename].[ext]

[pathname] names of the subdirectories (separated by "\") leading to the desired subdirectory (optional)

[filename] names of the files to be listed. All or part of the name can be replaced by "*" (See use of character "*")

[ext] extensions of the files to be listed. All or part of the extension can be replaced by "*" (See use of character "*")

Use of the wildcard character "*"

In the filename:

- DIR *.*[ext]* lists all the files with extension *[ext]*
- DIR *[xx]**.*[ext]* lists all the files whose name begins with the string *[xx]* (minimum one character) whose extension is *[ext]*.

In the extension:

- DIR *[filename]** displays the list of all the files whose filename is *[filename]*
- DIR *[filename]*.*[yy]** displays the list of files whose extension begins with the string *[yy]* (minimum one character) and whose name is *[filename]*.

The character "*" can be used in both the filename and the extension.

REMARK *The system displays "*.*" as default (to display all the files and subdirectories in the current directory).*

Display of the list of files corresponding to the specified filename and extension in the specified directory, e.g.:

```
DIR
volume in drive A has no label
Directory of A:\DIR1

.           <DIR>   08-02-94   08:55
..          <DIR>   08-02-94   08:55
TOOL       001     150 08-03-94   09:15
PROGS      001    1240 08-03-94   09:43
DIR11      <DIR>   08-03-94   15:10
DIR12      <DIR>   08-03-94   15:12
6 file(s)      1390 byte
                1441520 bytes free
```

Deleting Files

This operation requires the presence of a formatted diskette in the drive. It deletes the files contained in a directory (all the files or as selected by filename and extension).

Select file deletion. 

Display in the dialogue window of:

Service_Diskette >DEL █

Fill in the command (See syntax). 

Syntax

DEL ([pathname] [filename].[ext])

- [pathname]** names of the subdirectories (separated by "\") leading to the desired subdirectory (optional)
- [filename]** names of the files to be deleted. All or part of the name can be replaced by "*" (See use of character "*")
- [ext]** extensions of the files to be deleted. All or part of the extension can be replaced by "*" (See use of character "*")

Use of the wildcard character "*"

In the filename:

- DEL *.*[ext] deletes all the files with extension [ext]
- DEL [xx]*.[ext] deletes all the files whose name begins with the string [xx] (minimum one character) and whose extension is [ext].

In the extension:

- DEL [filename].* deletes all the files whose name is [filename]
- DEL [filename].[yy]* deletes all the files whose name is [filename] and whose extension begins with the string [yy] (minimum one character).

The wildcard character "*" can be used in both the filename and the extension.

If deletion of all the files in the directory is requested (DEL *.*), the following message is displayed in the dialogue window:

Confirm deletion of the file(s): Y/N ?

Confirm deletion.



Display of the file deletion report, e.g.:

```
delete file(s)
TOOLS.001
PROGS.001
```

Renaming Files

This operation requires the presence of a formatted diskette in the drive. It renames the files contained in a directory (all or as selected by filename and extension).

CAUTION

If a file already on the disk has the same name as the new name, it is overwritten without asking for confirmation.

Select file rename.



Display in the dialogue window of:

Service_Diskette >RENAME

Fill in the command (See syntax).



Syntax

RENAME ([pathname] [filename1].[ext1] [filename2].[ext2])

[pathname] names of the subdirectories (separated by "\") leading to the desired subdirectory (optional)

[filename1] names of the files to be renamed. All or part of the name can be replaced by "*" (See use of character "*")

[ext1] extensions of the files to be renamed. All or part of the extension can be replaced by "*" (See use of character "*")

[filename2] new filename

[ext2] new extension

Use of the wildcard character "*"

In the filename:

- RENAME *. [ext1] *. [ext2] renames the extension of all the files from [ext1] to [ext2]
- RENAME [xx]*. [ext1] *. [ext2] renames the extension of all the files whose filename begins with [xx] (minimum one character) from [ext1] to [ext2].

In the extension:

- RENAME [filename1].* [filename2].* renames all the files from [filename1] to [filename2]
- RENAME [filename1].[yy]* [filename2].* renames all the files whose extension begins with the string [yy] (minimum one character) from [filename1] to [filename2].

The character "*" cannot be used in both the name and the extension.

Display of the file rename report, e.g.:

```
rename file(s) :  
TOOLS.001  
PROGS.001
```

Copying Files

This operation requires the presence of a formatted diskette in the drive. It copies files contained in a directory (all or as selected by filename or extension).

CAUTION

If a file already on the diskette has the same name as the target filename, it is overwritten without asking for confirmation.

Select file copy.



Display in the dialogue window of:

Service_Diskette >COPY █

Fill in the command (See syntax)



Syntax

COPY ([pathname]) [filename1].[ext1] ([pathname]) [filename2].[ext2]

[pathname1]	names of the subdirectories (separated by "\") leading to the desired source subdirectory (optional)
[filename1]	names of the files to be copied. All or part of the name can be replaced by "*" (See use of character "*")
[ext1]	extensions of the files to be copied. All or part of the extension can be replaced by "*" (See use of character "*")
[pathname2]	names of the subdirectories (separated by "\") leading to the desired target subdirectory (optional)
[filename2]	new filename
[ext2]	new extension

Use of the wildcard character "*"

In the filename:

- COPY *.*[ext1] *.*[ext2] copies all the files with [ext1] to [ext2]
- COPY [xx]*.[ext1] *.*[ext2] copies all the files whose name begins with [xx] (minimum one character) from [ext1] to [ext2].

In the extension:

- COPY [filename1].* [filename2].* copies the files with [filename1] to [filename2]
- COPY [filename1].[yy]* [filename2].* copies all the files with [filename1] and whose extension begins with the string [yy] (minimum one character) to [filename2].

The character "*" cannot be used in both the name and the extension.

Concatenation

Several files can be concatenated when copying. The syntax is as follows:

COPY [filename1].[ext1]+[filename2].[ext2]+...+[filenamen].[extn][filename].[ext].

Concatenation can only be in the current directory and the character "*" cannot be used.

Display of the file copy report, e.g.:

```
start of copy
TOOLS.001
PROGS.001
```

2 file(s) copied

Exit from the Procedure

Exit from the page.



Exiting from the page cancels current operations.

5.9.6 Loading from the NUM Diskette Drive

The commands described below are used for dialogue with the drive.

Requirements

Link established with the diskette drive and presence of a serial line configured for the Kermit protocol (see C.2.3).
Drive on.

"Kermit" serial line selected.

The reduced "FILE LOADING" menu (See 5.9.2) is displayed.

General Remarks

Data format

The data (part programmes and tool offsets) backed up on the NUM diskette drive have a special format which differs from that of the other backup modes (load/unload modes, APA10, etc.). This means that the data backed up in the other modes cannot be loaded from the NUM diskette drive.

The part programmes loaded must begin with the character "%" and end with ASCII code "10" ("0A" hexadecimal).

Interrupted transmission

CAUTION

If transmission is accidentally interrupted, not all the data are loaded. Check that transmission was completed normally (no error message displayed and red LED on drive not lit) to be sure the programmes saved will run correctly on the machine.

5.9.6.1 Loading Part Programmes from the Num Diskette Drive

Actions

Select "PROGRAMMES".



The "SERVICE DISKETTE: LOAD PROGRAMME" page is displayed with the softkeys:



The following dialogue line is displayed:

Transfer>|

Press the  key for help on the softkeys displayed:

KERMIT transfer commands

<TRANSF> [filename]: source filename (on diskette) to be transferred
 e.g.: name10.pie
 <DIR> : DIR [pathname][filename]: e.g. dir \dir1 cut*.pie
 displays a list of files and subdirectories in the directory
 <CD..> : access the parent directory
 <CD> : CD pathname]: e.g. CD dir1\dir11
 directory to be accessed
 <CD\> : access the root directory
 <ABORT> : abort the current command.

Commands Already Described

Commands CD.., CD and CD\ are described in 5.9.5.3 and command "DIR" is described in 5.9.5.4.

Loading Part Programmes

This operation requires the presence of a formatted diskette in the drive. It is used to load into the CNC programmes saved in a file on the diskette.

REMARK *A programme with the same number as the active programme cannot be loaded when the system is executing a cycle.*

Select the directory containing the file to be loaded (See 5.9.5.3).

Select programme load.



TRANSF.

Display in the dialogue window of:

Transfer>Filename: █

Enter the name of the file to be loaded (See syntax).



Syntax

[filename].[ext]

[filename] name of the file containing the programme(s) to be loaded

[ext] extension of the file containing the programme(s) to be loaded

Display of the message:

loading part programme:
 [filename].[ext]
 in progress ...

When loading is complete, the dialogue line is cleared.

The programme is stored.

If several programmes are included in the file loaded, they are loaded one after the other.

Incidents

A programme in the memory has the same number as the programme to be loaded

Display in the dialogue window of the message:

part programme exists. Press any key...

Acknowledge the message. 

The programme is not loaded.

The part programme memory is full.

The following message is displayed in the dialogue window:

Programme zone full. Press any key...

Acknowledge the message. 

The programme is not loaded.

End of the Procedure

Exit from the page. 

Exiting from the page does not interrupt loading in progress.

5.9.6.2 Loading Tool Offsets from the NUM Diskette Drive

CAUTION

Do not load new tool offsets when machining is in progress. The new offsets are taken into account immediately and could cause collision between the tool and the part.

Actions

Select "TOOL OFFSETS". 

The "SERVICE DISKETTE: CORRECTORS" page is displayed with the softkeys:



and the dialogue line:

Transfer >|

Press the key for help on the softkeys displayed, which are the same as for programme load (See 5.9.6.1).

Commands Already Described

Commands CD., CD and CD \ are described in 5.9.5.3 and command "DIR" is described in 5.9.5.4.

Loading Tool Offsets

This operation requires the presence of a formatted diskette in the drive. It loads the tool offsets saved in a diskette file onto the CNC.

Select the directory containing the file to be loaded (See 5.9.5.3).

Select tool offset load.



TRANSF.

Display in the dialogue window of:

Transfer >Filename: █

Enter the name of the file to be loaded (See syntax).



Syntax

[filename].[ext]

[filename] name of the file containing the tool offsets to be loaded

[ext] extension of the file containing the tool offsets to be loaded.

Display of the message:

loading tool offsets:
[filename].[ext]
in progress...

When loading is complete, the dialogue line is cleared.

The tool offsets are stored.

End of the Procedure

Exit from the page.



OUT

Exiting from the page does not interrupt loading in progress.

5.9.7 Unloading to NUM Diskette Drive

The commands described below are used for dialogue with the drive.

Requirements

Link established with the diskette drive and presence of a serial line configured for the Kermit protocol (see C.2.3).
Drive on.

"Kermit" serial line selected.

The reduced "FILE UNLOADING" menu (See 5.9.3) is displayed.

General Remarks

Data format

The data (part programmes and tool offsets) backed up by the NUM diskette drive have a special format which differs from that of the other backup modes (load/unload modes, APA10, etc.). This means that the data backed up on the NUM diskette drive cannot be loaded in the other modes.

Transmission interrupted

If transmission is accidentally interrupted, the backup file is not created. Check that transmission was completed normally by checking for presence of the backup file by the "DIR" command.

File already exists

CAUTION

If a file with the same name as the file to be unloaded already exists on the diskette, it is overwritten without asking for confirmation.

5.9.7.1 Unloading the Active Programme to the NUM Diskette Drive

Actions

Select "ACTIVE PROGRAMME".



The "SERVICE DISKETTE: UNLOAD PROGRAMME" page is displayed with the softkeys:



The following dialogue line is displayed:

Transfer >|

Press the  key for help on the softkeys displayed:

KERMIT transfer commands

<TRANSF> [filename]: target filename (on diskette) to be transferred
 e.g.: name10.pie

<DIR> : DIR [pathname][file]: e.g. dir \dir1 cut*.pie
 displays a list of files and subdirectories in the directory

<CD..> : access the parent directory

<CD> : [CD pathname]: directory to be accessed

<CD\> : access the root directory

<ABORT> : abort the current command.

Commands Already Described

Commands CD.., CD and CD\ are described in 5.9.5.3 and command "DIR" is described in 5.9.5.4.

Unloading the Active Programme

This operation requires the presence of a formatted diskette in the drive. It is used to save the current programme in a file on the diskette.

Select the target directory for the file to be unloaded (See 5.9.5.3).

Select active programme unload.



TRANSF.

Display in the dialogue window of:

Transfer >Filename: █

Enter the name of the file to be unloaded (See syntax).



Syntax

[filename].[ext]

[filename] target filename for the active programme

[ext] target extension for the active programme.

Display of the message:

unloading part programme:
 [filename].[ext]
 in progress...

When unloading is complete, the dialogue line is cleared. The programme is saved.

Incidents

There is a syntax error in the filename.

Display in the dialogue window of one of the following messages:

Incorrect file name. Press any key...
 Incorrect file extension. Press any key ...

Acknowledge the message.



Key

No programme is unloaded.

There is no active programme.

Display in the dialogue window of the message:

No current programme. Press any key

Acknowledge the message. 

No programme is unloaded.

End of the Procedure

Exit from the page 

Exiting from the page does not interrupt unloading in progress.

5.9.7.2 Unloading Other Programmes to the NUM Diskette Drive

Actions

Select "OTHER PROGRAMME". 

The "SERVICE DISKETTE: UNLOAD PROGRAMME" page is displayed with the softkeys:



and the dialogue line:

Transfer >|

Press the key for help on the softkeys displayed, which are the same as for active programme unload (See 5.9.7.1) except:

<TRANSF> : [Programme-filename]:(CNC source), (target) programme to be unloaded
e.g.: %10.1 p101.pie - %% tou.pie - %10.* gr10.pie

Commands Already Described

Commands CD.., CD and CD\ are described in 5.9.5.3 and command "DIR" is described in 5.9.5.4.

Unloading Programmes

This operation requires the presence of a formatted diskette in the drive. It is used to save one or more programmes in a file on the diskette.

Select the target directory for the file to be unloaded (See 5.9.5.3).

Select programme unload. 

Display in the dialogue window of:

Transfer >Filename: |

Enter the name of the file to be loaded (See syntax). 

Syntax

[programme] [filename].[ext]

[programme] is the name of the part programme(s):

- %[programme No.].[group No.] specifies a single programme
- %[programme No.]* specifies all the programmes with the same number for the different axis groups
- %% specifies all the programmes in the memory

[[filename] target filename for the programme(s) to be saved

[ext] target extension for the programme(s) to be saved.

Display of the message:

unloading part programme:
[filename].[ext]
in progress...

When unloading is complete, the dialogue line is cleared.

The programme is stored.

Incidents

There is a syntax error in the file name or programme name

Display in the dialogue window of one of the following messages:

Incorrect programme start. Press any key ..
Incorrect group number. Press any key ..
Incorrect file name. Press any key ..
Incorrect file extension. Press any key ..

Acknowledge the message.



No programme is unloaded.

The programme does not exist.

Display in the dialogue window of the message:

Part programme does not exist. Press any key

Acknowledge the message.



No programme is unloaded.

End of the Procedure

Exit from the page.



Exiting from the page does not interrupt loading in progress.

5.9.7.3 Saving Tool Offsets to NUM Diskette Drive

Actions

Select "TOOL OFFSETS".



The "SERVICE DISKETTE: UNLOAD CORRECTORS" page is displayed with the softkeys:



and the dialogue line.

Transfer >|

Press the key for help on the softkeys displayed, which are the same as for active programme unload (See 5.9.7.1).

Commands Already Described

Commands CD., CD and CD \ are described in 5.9.5.3 and command "DIR" is described in 5.9.5.4.

Unloading Tool Offsets

This operation requires the presence of a formatted diskette in the drive. It is used to save tool offsets in a file on the diskette.

Select the target directory for the file to be unloaded (See 5.9.5.3).

Select tool offset unload.



Display in the dialogue window of:

Transfer >Filename: |

Enter the name of the file to be saved (See syntax).



Syntax

[filename].[ext]

[filename] tool offset target filename

[ext] tool offset target file extension

Display of the message:

unloading tool offsets:
[filename].[ext]
in progress...

When unloading is complete, the dialogue line is cleared.

The tool offsets are saved

Incidents

There is a syntax error in the filename.

Display in the dialogue window of one of the following messages:

Incorrect file name. Press any key...

Incorrect file extension. Press any key ...

Acknowledge the message.



Key

No tool offset file is unloaded.

End of the Procedure

Exit from the page



OUT

Exiting from the page does not interrupt loading in progress.

6 Operational Problems

6.1	Indicator "FDHLD" Displayed	6 - 5
6.2	No Movement in Manual Mode	6 - 6
6.3	No Movement in Automatic Mode	6 - 8
6.4	No Cycle Start	6 - 11
6.5	No Block Sequencing	6 - 12
	6.5.1 No Block Sequencing, "INCYC" Indicator Displayed	6 - 12
	6.5.2 No Block Sequencing, "INCYC" Indicator Absent	6 - 15
6.6	Faults Detected by the System	6 - 17
6.7	Data Modification	6 - 17
6.8	Failure on Analogue Input/Output Cards	6 - 17
6.9	Power Failures	6 - 18

When a failure occurs, the operator can identify the symptoms of this failure by referring to the trouble-shooting flow charts below.

The purpose of the flow charts is to find a solution to the failure.

Three types of graphic symbols are used:

Choice: The operator must answer the question asked by yes or no; the answer to the question decides of the next step.

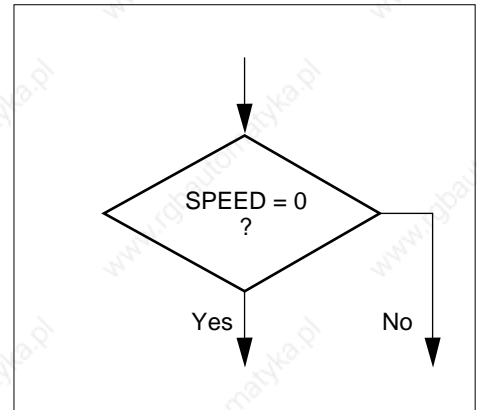

Action: The operator must perform an action before going to the next step.

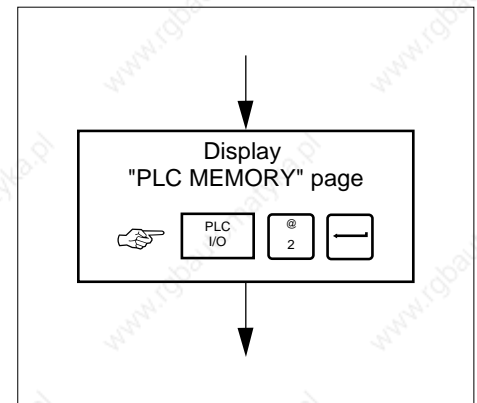

Solution: Tells the operator how to remedy the failure.

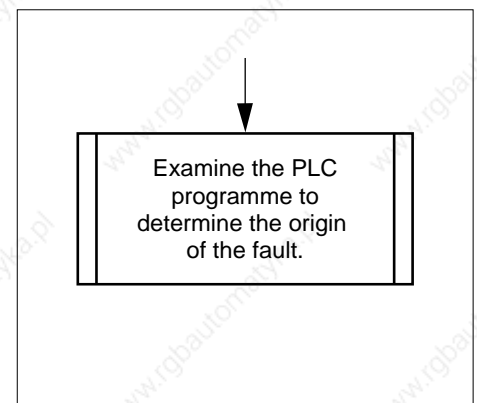

Some choices depend on data bits (for example: general feed authorisation) to be viewed on the "PLC MEMORY" page; each data bit represented by its mnemonic (for example: FEED).

A mnemonic corresponds to a bit designated by a variable that depends on the PLC programming language used (in Ladder language, AUTAV corresponds to bit %W4.0. See Appendix D for the corresponding mnemonics). This address is entered to view the bit value on the "PLC MEMORY" page (in Ladder language, view of the byte containing the bit: %W4.0 is bit 1 of byte %W4.B).

6.1 Indicator "FDHLD" Displayed

Failure symptoms

Any CNC condition.

Indicator "FDHLD" displayed.

Trouble-shooting

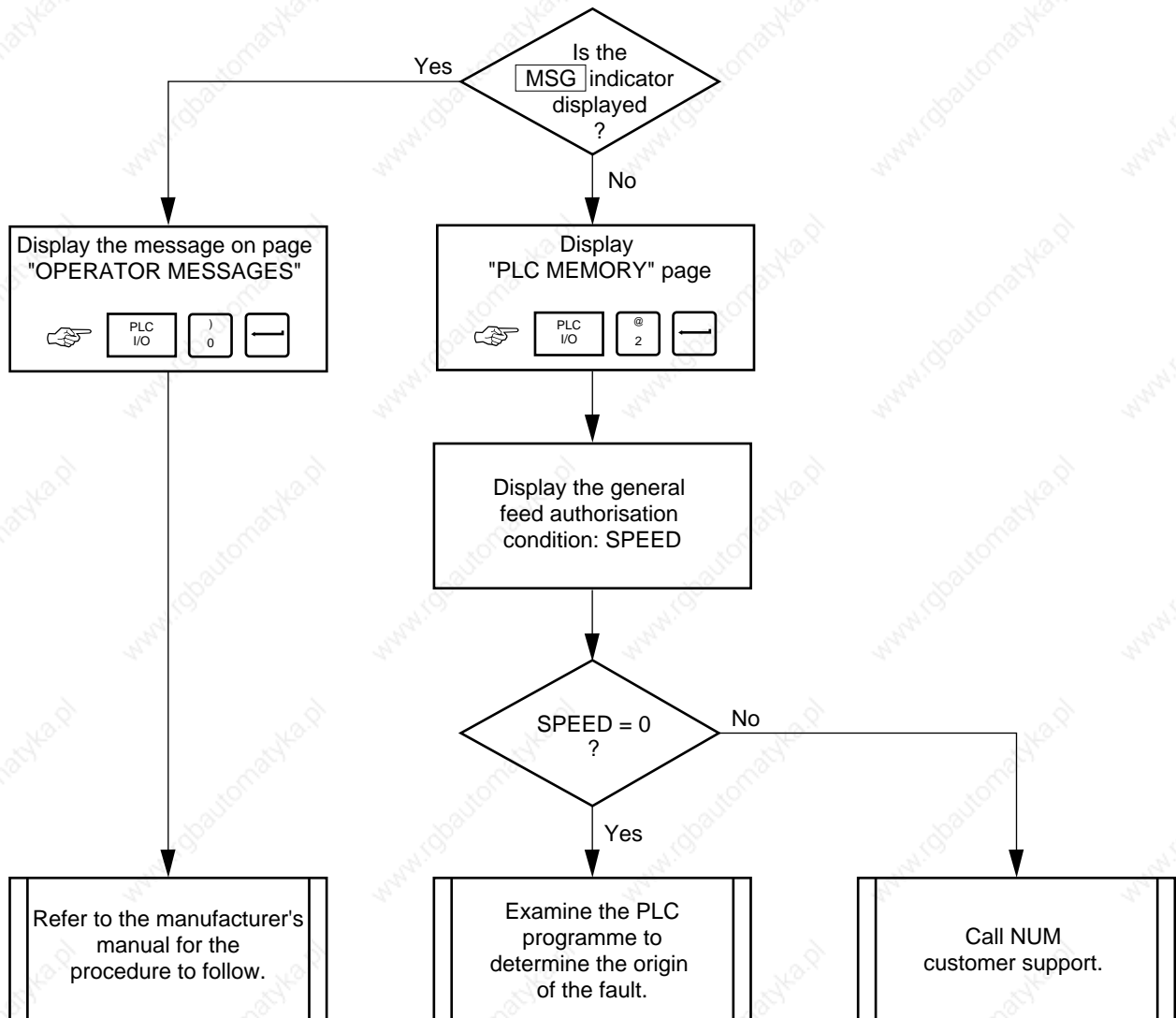

6.2 No Movement in Manual Mode

Failure symptoms

The manual controls do not generate any movement.

Trouble-shooting

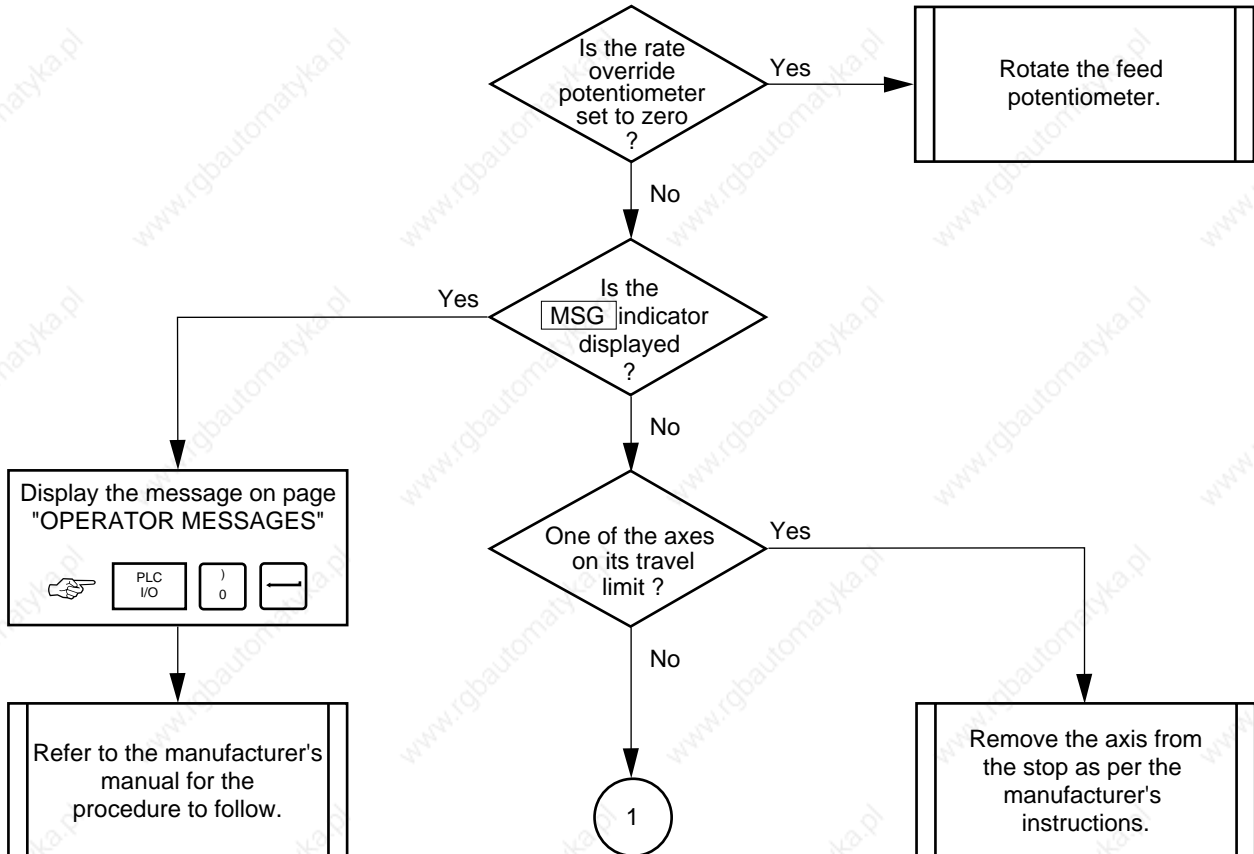

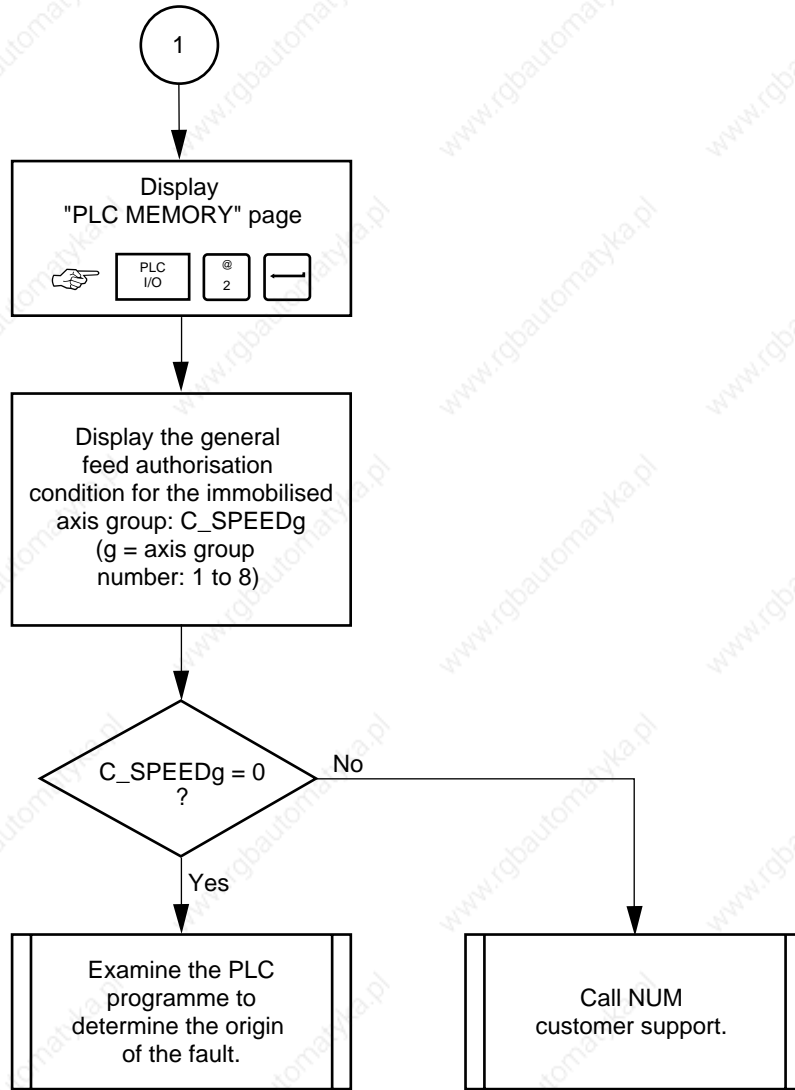

6.3 No Movement in Automatic Mode

Failure symptoms

Any machining mode selected.

No movement generated.

Trouble-shooting

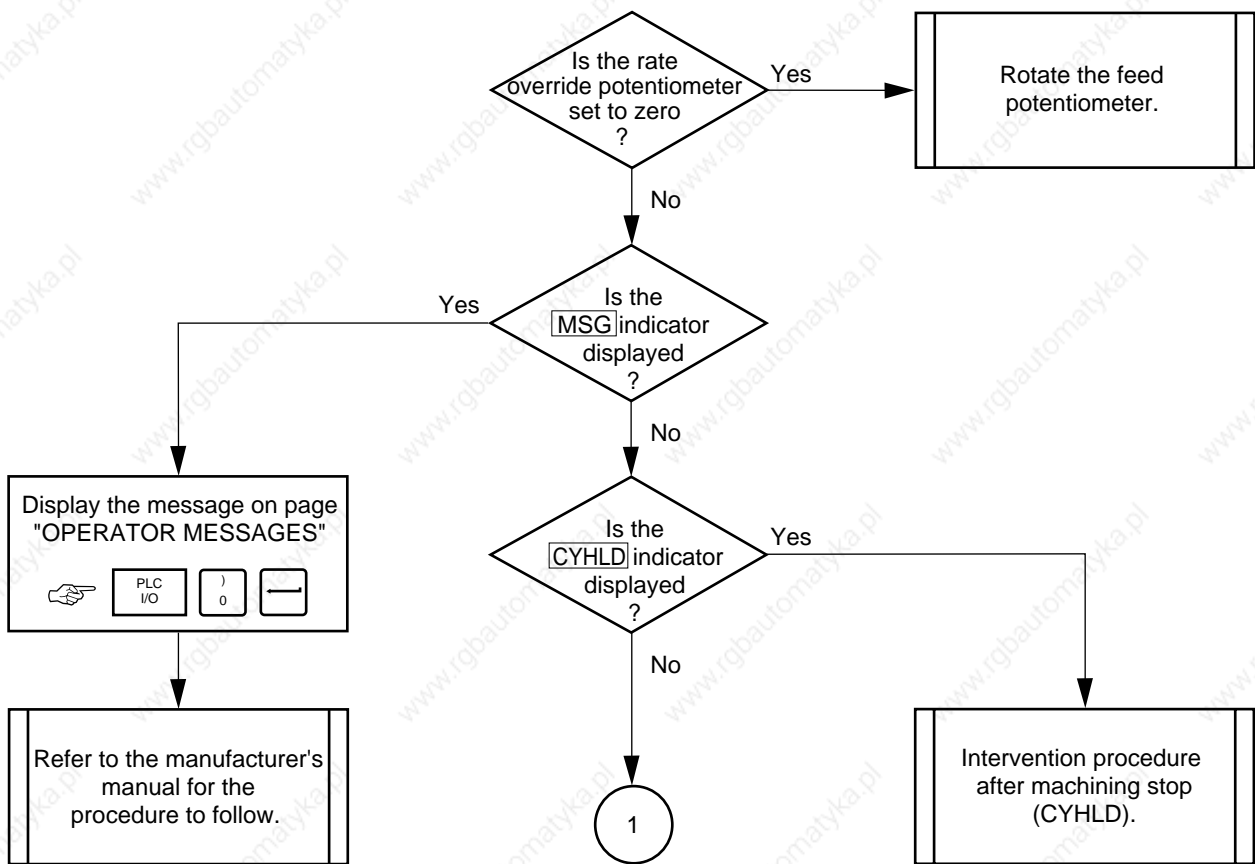

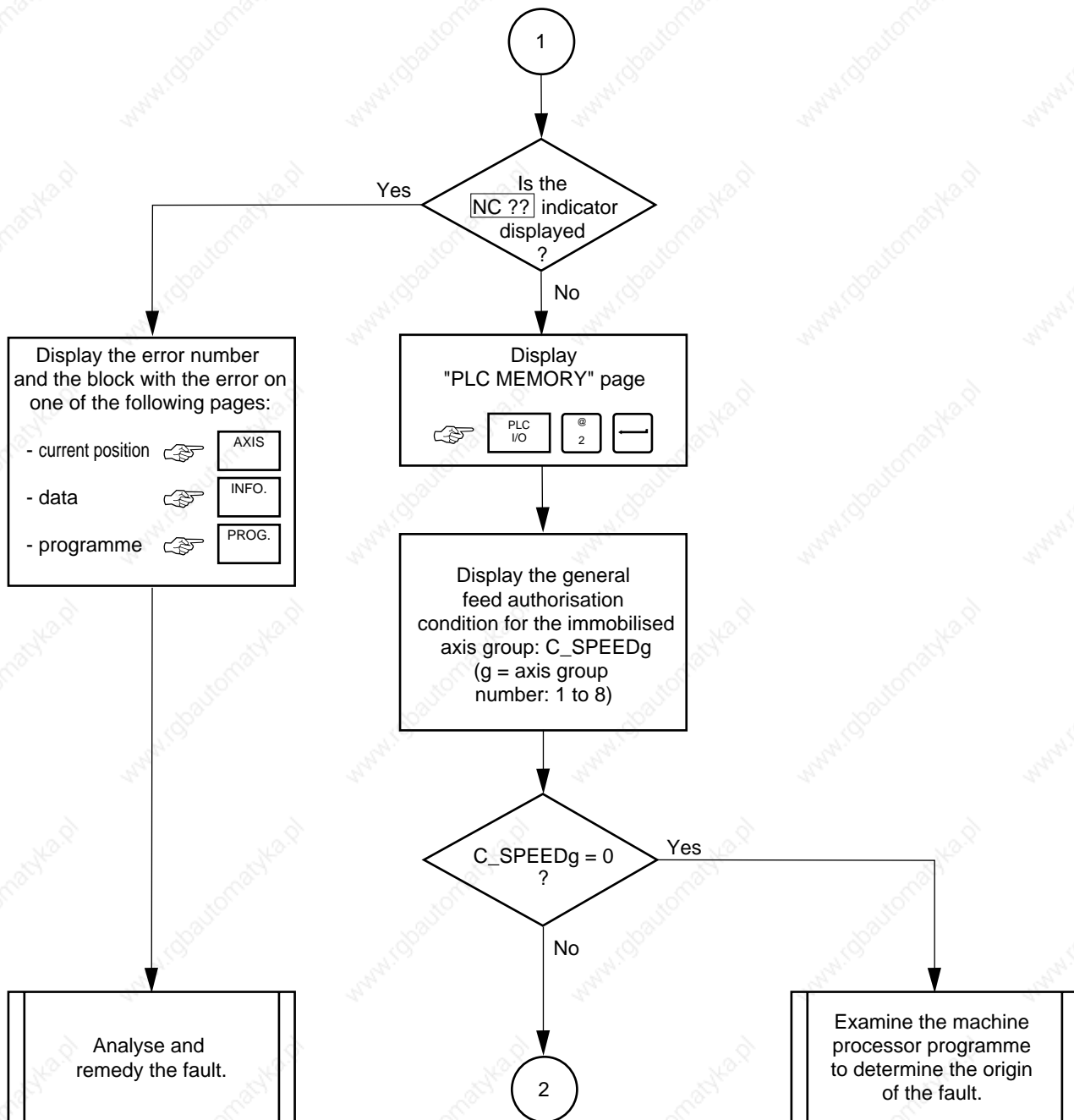

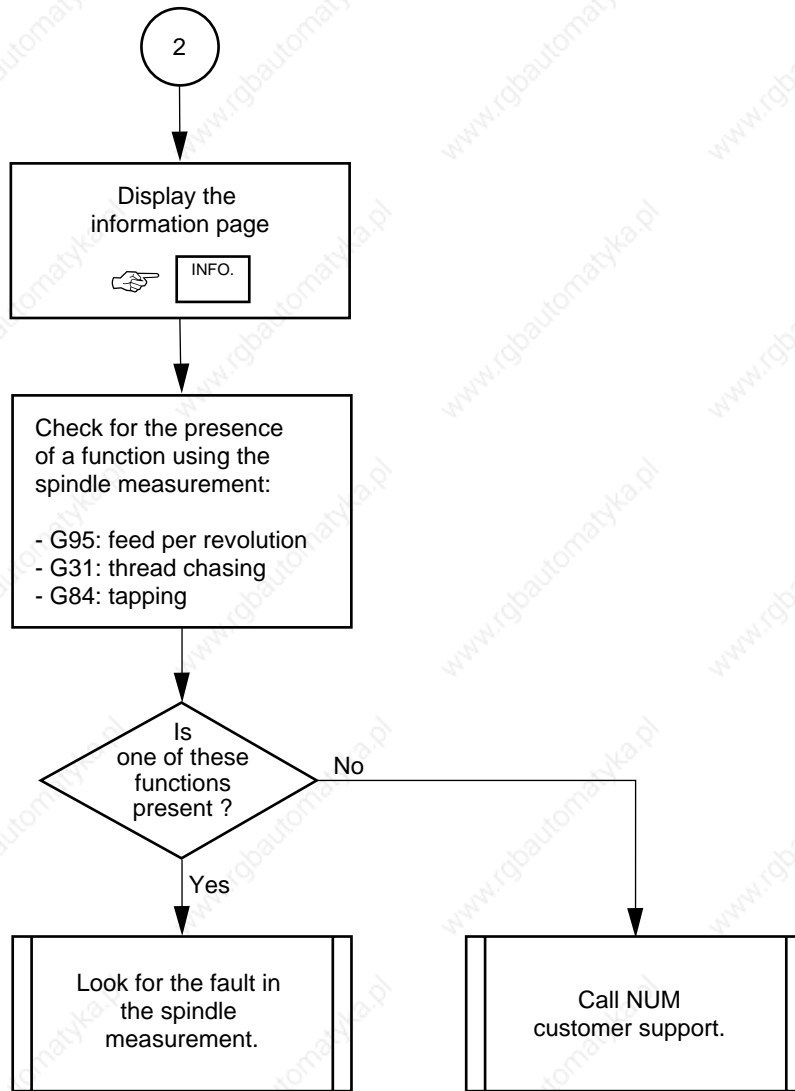

6.4 No Cycle Start

Failure symptoms

Any machining mode selected.

The cycle is not started ("INCYC" indicator absent from the status window) by pressing the "CYCLE" button on the machine panel.

Trouble-shooting

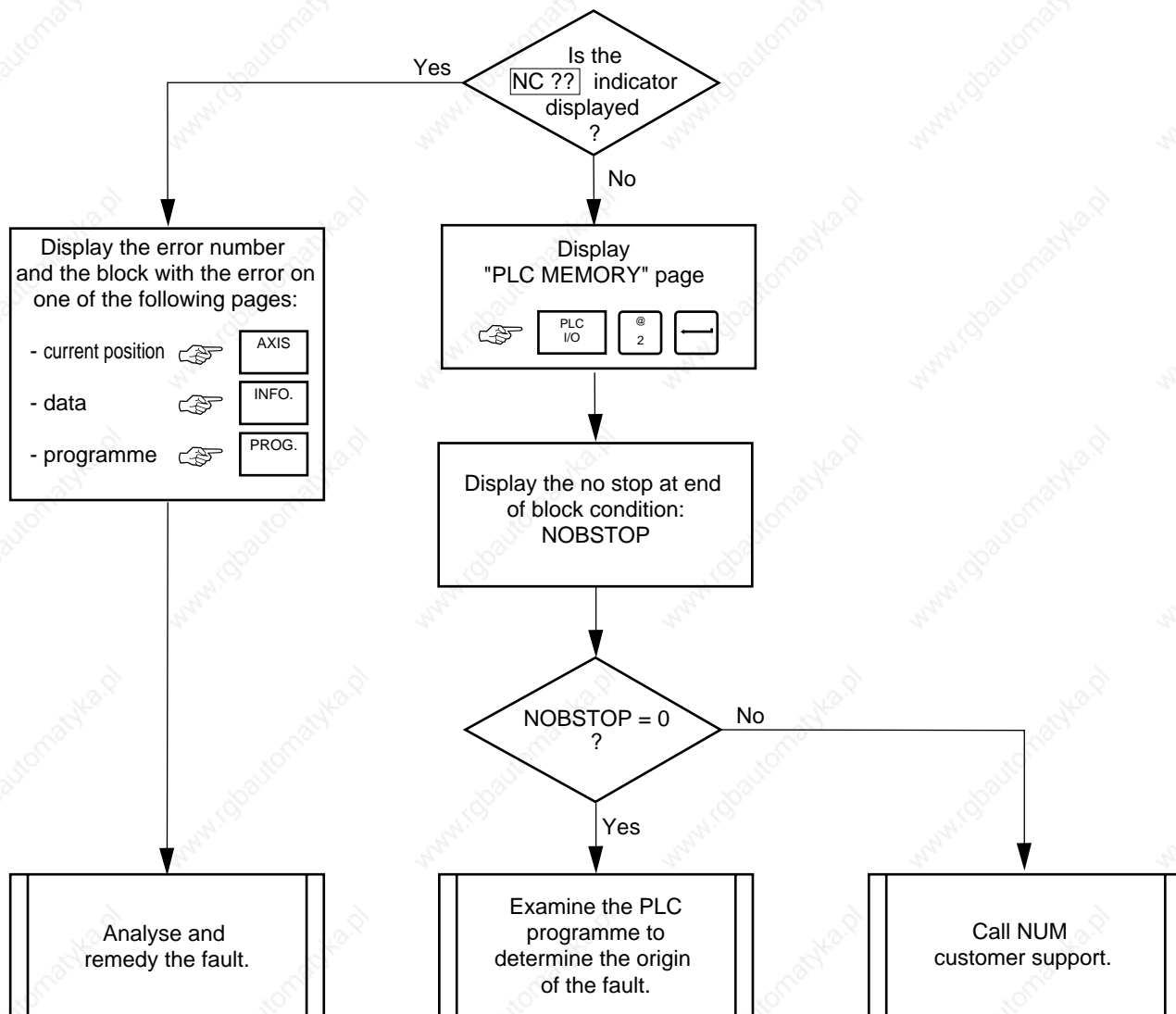

6.5 No Block Sequencing

6.5.1 No Block Sequencing, "INCYC" Indicator Displayed

Failure symptoms

Automatic or dry run mode selected.

The movements stop at the end of the block.

The "INCYC" indicator is displayed in the status window.

Trouble-shooting

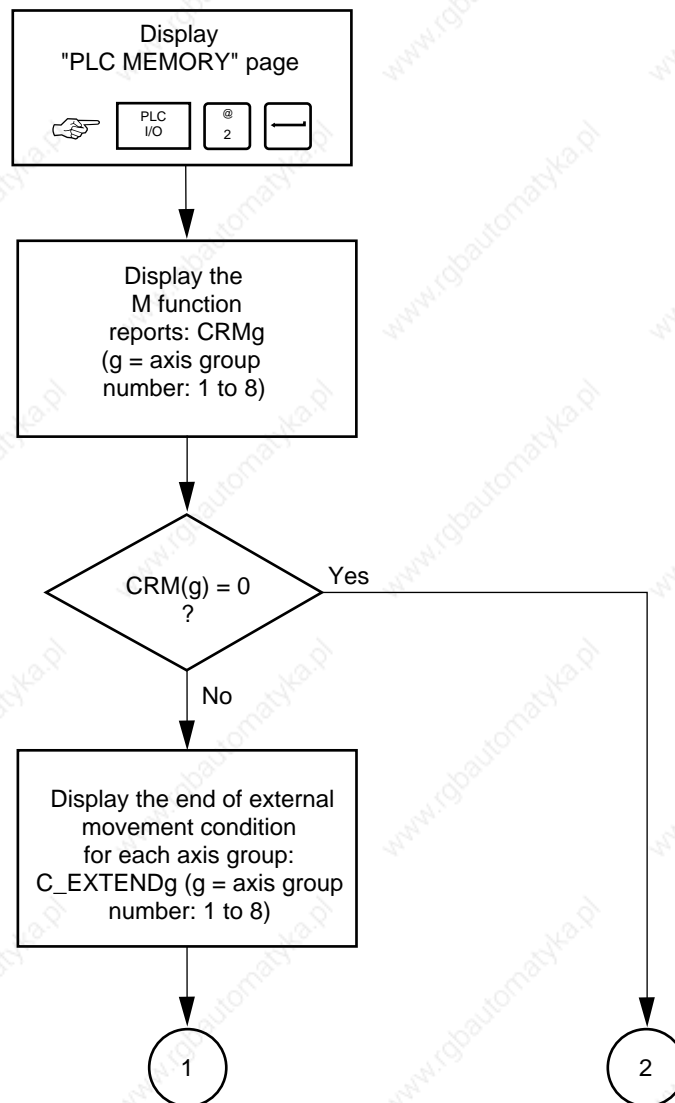

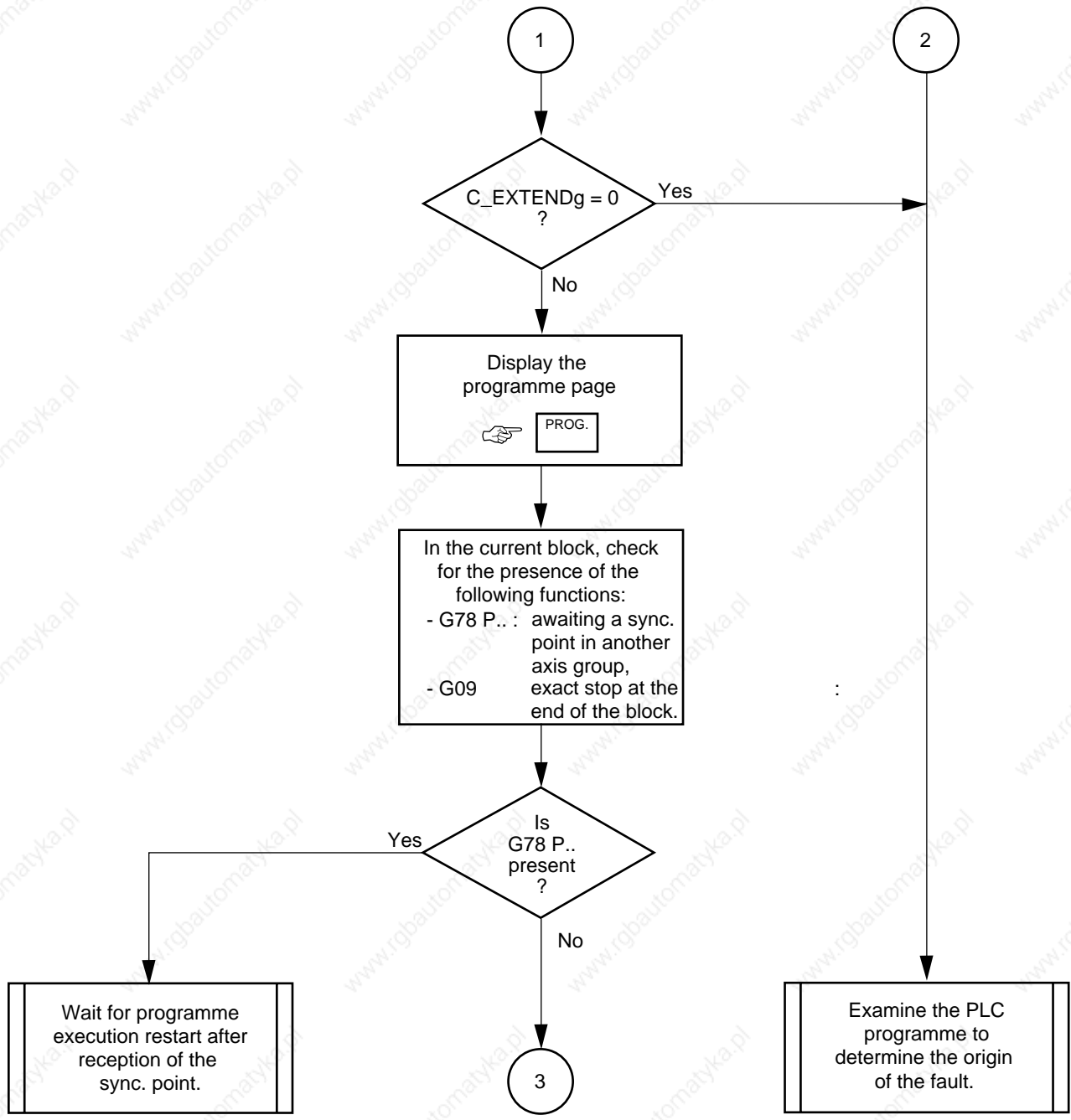

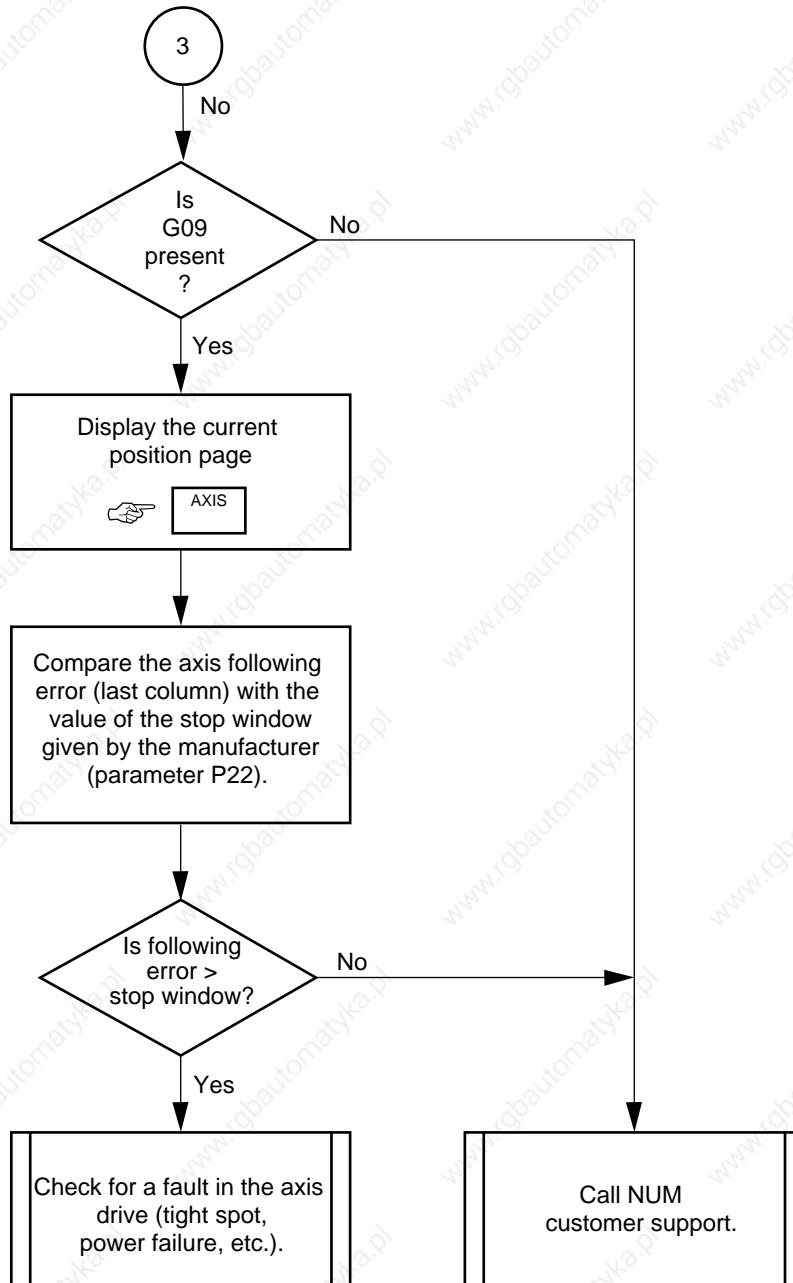

6.5.2 No Block Sequencing, "INCYC" Indicator Absent

Failure symptoms

Automatic or dry run mode selected.

The movements stop at the end of the block.

The "INCYC" indicator is absent from the status window.

Trouble-shooting

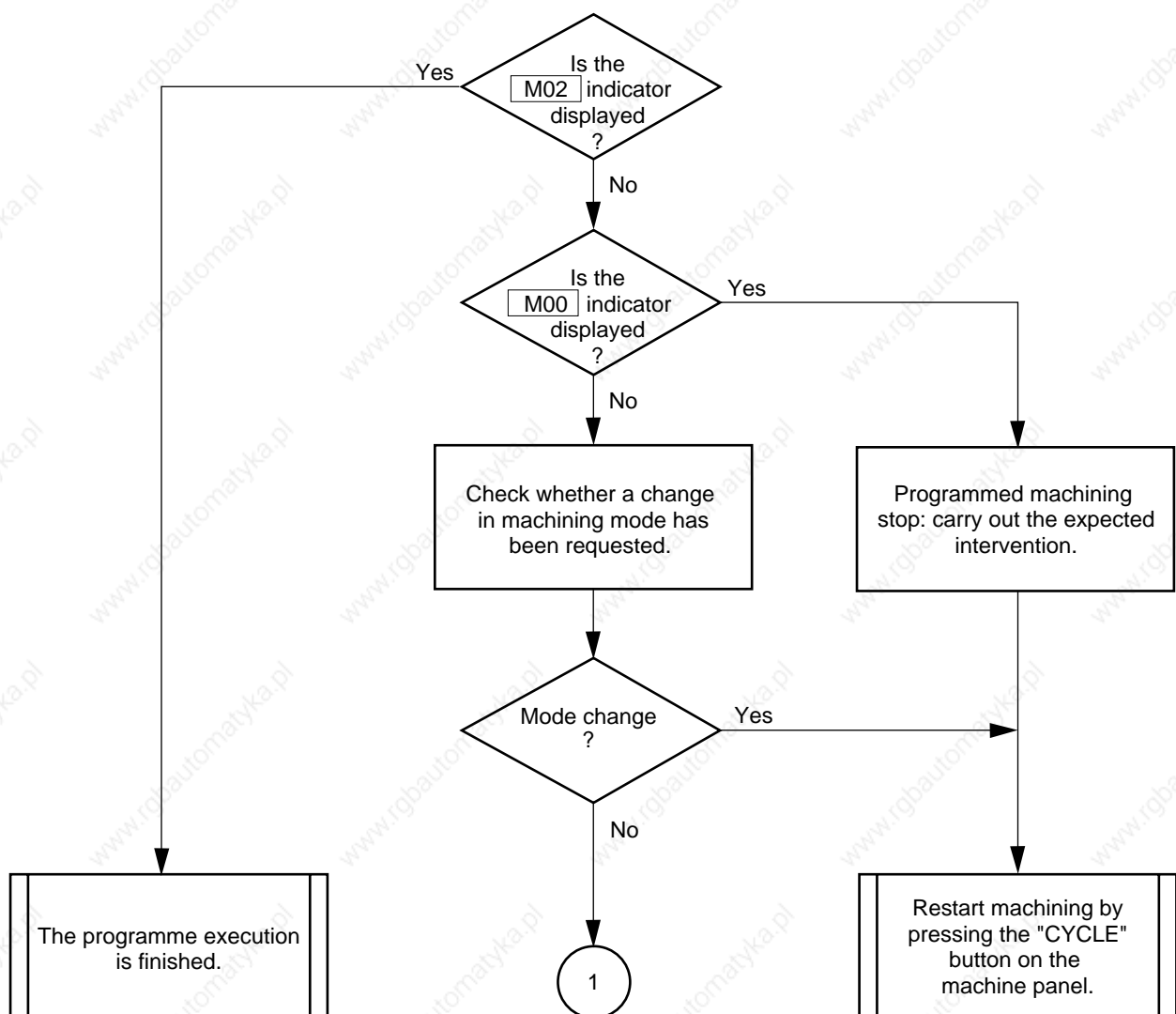

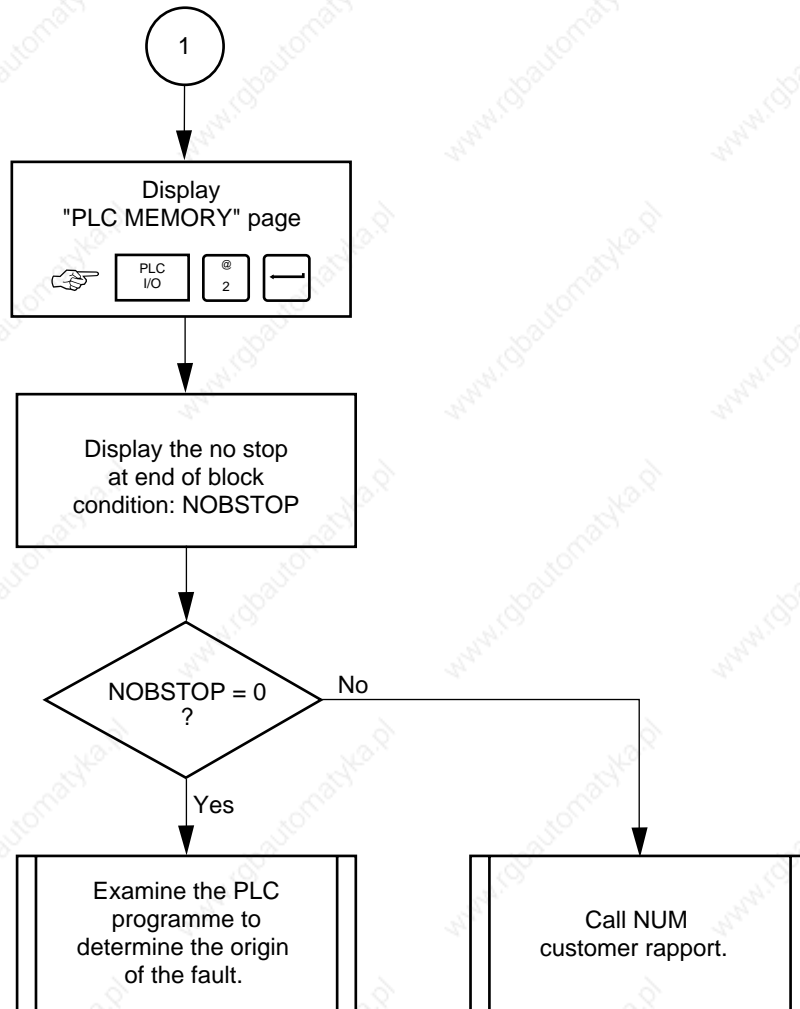

6.6 Faults Detected by the System

When a fault is detected by the system, the fault indicator (NC??) is displayed in the status window and a message, for instance:

error 159 block N10
Programme Shift Requested on an Axis which is not Homed

This message may be displayed in the dialogue window of pages:

- current position (See 4.2),
- data (See 4.7),
- programme (See 4.8).

The "HELP" key on the keyboard is used to display the rest of the message (also see the list of errors in Appendix B).

6.7 Data Modification

Certain data used for machining set up (offsets for the part, tool dimensions, etc.) may be modified by a part programme or manually by the operator.

When such a modification has taken place, the paths of subsequent part programmes can be left offset and are therefore wrong.

Readjust the settings before carrying out a new part programme.

6.8 Failure on Analogue Input/Output Cards

When a failure is detected on an input/output card, check the fuses before sending the card back for repair.

CAUTION

Always replace blown fuses (see 8.1.3) by very fast-acting (FF) fuses. Two spare fuses are provided on each card.

6.9 Power Failures

If a power failure occurs, the machine may stop during machining and possibly damage the part.

The following procedure is used to restart an interrupted machining operation without having to go through all the steps preceding the failure.

Requirements

End of power failure.

Salvageable part.

Actions

Reset the system.

The system resets.

Remove the tool from the part manually (See 5.1.1).

Perform a homing procedure (See 5.1.2).

If required, readjust the part fixture.

If required, replace the tool and readjust the settings (See 5.2.2).

Display the part programme (See 4.5.2) to determine the sequence where it was interrupted.

Search for the appropriate sequence number (See 5.5.1.5).

Bring the axes back into position (See 5.5.1.3).

Select the machining mode required.

Press the "CYCLE" button on the machine panel.

Restart the programme execution where it stopped.

7 System Faults

7.1	Hardware Fault	7 - 5
7.2	Customisation Error	7 - 5
7.3	Temporary Customisation	7 - 6
7.4	Customisation Overrun	7 - 6
7.5	Sampling Period Too Small	7 - 7
7.6	Parameter Table Not Conforming to Software Version	7 - 8
7.7	A Declared Axis Missing	7 - 9
7.8	Not Enough Memory to Execute the Pocket Module	7 - 10
7.9	Wrong Number of PLC Axes	7 - 10
7.10	Incorrect Sampling Period with UC SII CPU	7 - 11
7.11	Sensor Declared Connected Several Times to the QVN Card	7 - 11
7.12	Incoherent QVN Sensor Address	7 - 12
7.13	Sensor Declared on QVN Card but Detected on an Axis Card	7 - 12
7.14	Undeclared Speed Sensor Connected to the QVN Card	7 - 13
7.15	Speed Sensor Declared Several Times	7 - 13
7.16	Speed and Position Sensor Declared on Several Axes	7 - 14
7.17	Position Sensor Not Found on Axis Card and Not Declared as QVN Sensor	7 - 14
7.18	Several Axis Drive Sensors Have the Same Address	7 - 15
7.19	List of Drives Different from the List of QVN Axes	7 - 15
7.20	QVN Axes Missing	7 - 16
7.21	Missing QVN Measured-Only Axes	7 - 16
7.22	Sampling Period Not Within the Authorised Values	7 - 17
7.23	Editing Parameter P98	7 - 17

Faults detected during system initialisation cause the display of a message.

The table below refers to the procedure to remedy the fault depending on the message displayed:

REMARK *Some procedures include operations on machine parameters; these may be performed by the operator if he is qualified. Otherwise, they must be performed by the OEM.*

Message	See
PARAMETER TABLE CHECKSUM ERROR CONTINUE (Y/N)?	7.1
OPTIONS NOT VALID CONTINUE (Y/N)?	7.2
ALL S/W OPTIONS VALID THIS SYSTEM IS NOT IN WARRANTY CONTINUE? (Y/N)	7.3
TOO MANY AXES OR SPINDLES CONTINUE (Y/N)?	7.4
SAMPLING PERIOD TOO SMALL ! IT MUST BE, AT LEAST, EQUAL TO xxxx MICROSECONDS FOR THE NUMBER OF AXIS/SPINDLES SPECIFIED IN MACHINE SETUP DATA DO YOU WANT TO CONTINUE ? (Y/N)	7.5
PARAMETER TABLE INDEX ERROR RE-INIT TABLE ?(Y):	7.6
MISSING AXIS DO YOU WANT TO CONTINUE ? (Y/N) CONTINUE (Y/N)?	7.7
NOT ENOUGH ROOM FOR LOADING ...POCKETING ALGORITHM CONTINUE (Y/N)?	7.8
WRONG NUMBER OF PLC AXES CONTINUE (Y/N)?	7.9
WARNING: SAMPLING PERIOD IS NOT A MULTIPLE OF 2 ms CONTINUE (Y/N)?	7.10
ERROR: SENSOR DECLARED CONNECTED SEVERAL TIMES TO THE QVN CARD CONTINUE (Y/N)?	7.11
ERROR: QUESTIONABLE SENSOR NUMBER CONTINUE (Y/N)?	7.12
ERROR: SENSOR DECLARED ON QVN CARD BUT DETECTED ON AN AXIS CARD CONTINUE (Y/N)?	7.13
ERROR: UNDECLARED SPEED SENSOR CONNECTED TO THE QVN CARD CONTINUE (Y/N)?	7.14

Message	See
ERROR: SPEED SENSOR DECLARED SEVERAL TIMES CONTINUE (Y/N)?	7.15
ERROR: SPEED POSITION SENSOR DECLARED ON SEVERAL AXES CONTINUE (Y/N)?	7.16
ERROR: POSITION SENSOR NOT FOUND ON AXIS CARD AND NOT DECLARED AS CONNECTED TO QVN CARD CONTINUE (Y/N)?	7.17
ERROR: SEVERAL AXIS DRIVE SENSORS POSSESS THE SAME ADDRESS CONTINUE (Y/N)?	7.18
ERROR: MISMATCH BETWEEN THE DRIVES PRESENT AND THE QVN AXES DECLARED CONTINUE (Y/N)?	7.19
ERROR: MISSING QVN DECLARED AXES CONTINUE (Y/N)?	7.20
ERROR: MISSING QVN DECLARED MEASURING ONLY AXES CONTINUE (Y/N)?	7.21
SAMPLING PERIOD MUST BE A MULTIPLE OF 1 ms AND EQUAL AT LEAST TO 3 ms FOR AXIS QVN DO YOU WANT TO CONTINUE (Y/N)? CONTINUE (Y/N)?	7.22
P98 HAS CHANGED! DO YOU WANT TO DESTROY YOUR PLC ASSEMBLER PROGRAM (Y/N)?	7.23

7.1 Hardware Fault

Message displayed at initialisation

PARAMETER TABLE
CHECKSUM ERROR
CONTINUE (Y/N)?

Comment

It is probably a hardware fault (faulty card, etc.).

Actions

Contact the NUM Service Engineer.

7.2 Customisation Error

Message displayed at initialization

OPTIONS NOT VALID
CONTINUE (Y/N)?

Comment

This message should never be displayed: it would indicate an illegal attempt to modify the list of software options!!!

Actions

Acknowledge the message.



The system is available, but the machining modes are inhibited.

The system error indicator «PRSER» is displayed in the status window (See 3.1.3).

Contact NUM.

7.3 Temporary Customisation

Message displayed at initialisation

ALL S/W OPTIONS VALID
THIS SYSTEM IS NOT IN WARRANTY
CONTINUE? (Y/N)

Comment

This message should never be displayed on the end user's equipment: it would indicate the system has not been customised.

The system may possibly be used, but without any contractual warranty.

Actions

Acknowledge the message.



The system is available

The system error indicator «PRSMX» is displayed in the status window (See 3.1.3).

Contact the machine manufacturer to customise the equipment.

7.4 Customisation Overrun

Message displayed at initialisation

TOO MANY AXES OR SPINDLES OR TOO FEW PLC AXES
CONTINUE (Y/N)?

Comment

The number of spindles or axes given by the machine parameters exceeds the maximum set during customisation or disagrees with the expected number of PLC only axes.

Actions

Acknowledge the message.



The system is available, but the machining modes are inhibited.

The system error indicator «PRSOV» is displayed in the status window (See 3.1.3).

Modify the parameters related to axes and spindles (See Parameter manual).

Reset the system to take the new value into account.

7.5 Sampling Period Too Small

Message displayed at initialisation

SAMPLING PERIOD TOO SMALL !
IT MUST BE, AT LEAST, EQUAL TO
XXXX MICROSECONDS
FOR THE NUMBER OF AXIS/SPINDLES
SPECIFIED IN MACHINE SETUP DATA
DO YOU WANT TO CONTINUE ? (Y/N)

Comment

The sampling period set by parameter P50 (See Parameter manual) is too short to deal with the number of axes and spindles to be measured.

Actions

Check the minimum sampling period (T) recommended by the message.

Acknowledge the message.



The system is available, but the axes and spindles are ignored.

The system fault indicator «CLKOV» is displayed in the status window (See 3.1.3).

Enter the sampling period value (T) in parameter P50 (See Parameter manual).

Reset the system to take the new value into account.

If the problem persists:

Progressively increase the value of parameter P50 until operation is correct.

REMARK *Setting a P50 parameter value higher than necessary reduces the system performance; it is therefore advised not to increase this value too much.*

7.6 Parameter Table Not Conforming to Software Version

Message displayed at initialization

PARAMETER TABLE INDEX ERROR
RE-INIT TABLE ?(Y):

Comment

This is not a system fault but a warning before reset of the machine parameter table during CNC software updating.

Switching to a new software version is achieved by replacing:

- the memory board,
- or
- part of the memory board (daughterboard).

The existing parameter table may no longer conform to the new software version (the differences concern only a limited number of parameters).

During the first reset following software updating, the system detects a different version of the parameter table and requests re-initialisation of this table.

Actions

Acknowledge the message.



The following message is displayed:

EEPROM SAVING DONE ?
(Y):

There are two possibilities:

The parameter table has been saved

Acknowledge the message.



The system is available, but all the machine parameters have taken on their default values.

Reload the parameter table (See table below).

Parameter saving	Actions
Paper printout	Manually enter the new parameters (See Parameter manual)
Magnetic storage	Reload the parameters (See Parameter manual)

Manually enter values for the parameters of the new version
(See Parameter manual).

Reset the system to take the parameters into account.

 **WARNING**

It is advisable to save the parameter table or make a paper printout each time the table is modified (See Parameter Manual)

The parameter table has not been saved

The message must not be acknowledged:

Cut off the power supply to the system.

Return to the previous system status (reinstall the old memory board).

Restart the system.

Save the parameters (See Parameter manual).

Cut off the power supply to the system.

Re-install the new software version.

Restart the system and continue the procedure.

7.7 A Declared Axis Missing

Message displayed at initialisation

MISSING AXIS

DO YOU WANT TO CONTINUE ? (Y/N)

CONTINUE (Y/N)?

Comment

One of the axes declared in parameter P2 (See Parameter Manual) is missing.

Actions

Acknowledge the message.



The system is available, but power cannot be applied to the machine.

Enter the P2 parameter value corresponding to the axes present (See Parameter manual).

If required, modify the other axis-related parameters in compliance with parameter P2.

Reset the system to take the new parameters into account.

7.8 Not Enough Memory to Execute the Pocket Module

Message displayed at initialisation

NOT ENOUGH ROOM FOR LOADING
...POCKET ALGORITHM
CONTINUE (Y/N)?

Comment

There is not enough RAM to execute the pocket module even though it is present in the configuration.

Actions

Acknowledge the message.



The system is available, but the pocket module cannot be executed.

Add RAM to be able to execute the pocket module.

Contact NUM customer support.

7.9 Wrong Number of PLC Axes

Message displayed at initialisation

WRONG NUMBER OF PLC AXES
CONTINUE (Y/N)?

Comment

Fewer PLC axes were declared by machine parameters than the number set by customisation.

Actions

Acknowledge the message.



The system is available, but the machining modes are inhibited.

The "PRSOV" system fault indicator is displayed in the status window (See 3.1.3).

Edit the parameters relative to PLC axes (See Parameter Manual).

Reset the system to take the new parameters into account.

7.10 Incorrect Sampling Period with UC SII CPU

Message displayed at initialisation

WARNING: SAMPLING PERIOD
IS NOT A MULTIPLE OF 2 ms
CONTINUE (Y/N)?

Comment

The sampling period set by parameter P50 (See Parameter Manual) is not suitable for operation with a UC SII CPU (the value must be a multiple of 2 ms).

Actions

Acknowledge the message.



The system is available. The sampling period is rounded down to the next lower multiple of 2 ms, but parameter P50 is not modified.

Enter a correct sampling period in parameter P50 (See Parameter Manual).

Reset the system to take the new parameter into account.

This action can be carried out later if the system operates correctly with the rounded-down value of the sampling period.

7.11 Sensor Declared Connected Several Times to the QVN Card

Message displayed at initialisation

ERROR: SENSOR DECLARED CONNECTED SEVERAL
TIMES TO THE QVN CARD
CONTINUE (Y/N)?

Comment

A QVN sensor is declared connected several times in parameter P70 (See Parameter Manual).

Actions

Acknowledge the message.



The system is available, but the machining modes are inhibited and power cannot be applied to the system.

The "PRSOV" system fault indicator is displayed in the status window (See 3.1.3).

Enter correct sensor addresses in parameter P70 (See Parameter Manual).

Reset the system to take the new parameter into account.

7.12 Incoherent QVN Sensor Address

Message displayed at initialisation

ERROR: QUESTIONABLE SENSOR NUMBER
CONTINUE (Y/N)?

Comment

A position or speed sensor address is outside the value authorised for parameters P70 and P71 (See Parameter Manual).

Actions

Acknowledge the message.



The system is available, but the machining modes are inhibited and power cannot be applied to the system.

The "PRSOV" system fault indicator is displayed in the status window (See 3.1.3).

Correct the faulty address in parameter P70 or P71 (See Parameter Manual).

Reset the system to take the new parameter into account.

7.13 Sensor Declared on QVN Card but Detected on an Axis Card

Message displayed at initialisation

ERROR: SENSOR DECLARED ON QVN CARD BUT
DETECTED ON AN AXIS CARD
CONTINUE (Y/N)?

Comment

A sensor is declared as connected in parameter P70 (See Parameter Manual) but is detected on an axis card.

Actions

Acknowledge the message.



The system is available, but the machining modes are inhibited and power cannot be applied to the system.

The "PRSOV" system fault indicator is displayed in the status window (See 3.1.3).

Cancel the sensor declaration in parameter P70 (See Parameter Manual).

Reset the system to take the new parameter into account.

7.14 Undeclared Speed Sensor Connected to the QVN Card

Message displayed at initialisation

ERROR: UNDECLARED SPEED SENSOR CONNECTED
TO THE QVN CARD
CONTINUE (Y/N)?

Comment

A speed sensor address is declared in parameter P71 but the sensor is not declared as connected in parameter P70 (See Parameter Manual).

Actions

Acknowledge the message.



The system is available, but the machining modes are inhibited and power cannot be applied to the system.

The "PRSOV" system fault indicator is displayed in the status window (See 3.1.3).

Declare the sensor as connected in parameter P70 (See Parameter Manual).

Reset the system to take the new parameter into account.

7.15 Speed Sensor Declared Several Times

Message displayed at initialisation

ERROR: SPEED SENSOR DECLARED
SEVERAL TIMES
CONTINUE (Y/N)?

Comment

A speed sensor is declared several times in parameter P71 (See Parameter Manual).

Actions

Acknowledge the message.



The system is available, but the machining modes are inhibited and power cannot be applied to the system.

The "PRSOV" system fault indicator is displayed in the status window (See 3.1.3).

Enter correct sensor addresses in parameter P71 (See Parameter Manual).

Reset the system to take the new parameter into account.

7.16 Speed and Position Sensor Declared on Several Axes

Message displayed at initialisation

ERROR: SPEED AND POSITION SENSOR
DECLARED ON SEVERAL AXES
CONTINUE (Y/N)?

Comment

A sensor is declared as position sensor and speed sensor on at least two different axes in parameter P71 (See Parameter Manual).

Actions

Acknowledge the message.



The system is available, but the machining modes are inhibited and power cannot be applied to the system.

The "PRSOV" system fault indicator is displayed in the status window (See 3.1.3).

Enter correct sensor addresses in parameter P71 (See Parameter Manual).

Reset the system to take the new parameter into account.

7.17 Position Sensor Not Found on Axis Card and Not Declared as QVN Sensor

Message displayed at initialisation

ERROR: POSITION SENSOR NOT FOUND ON
AXIS CARD AND NOT DECLARED AS CONNECTED
TO QVN CARD
CONTINUE (Y/N)?

Comment

The system detects a sensor at initialisation, but the sensor is not connected to an axis card and is not declared in parameter P70 (See Parameter Manual).

This means that the sensor is connected to a QVN card but is not declared as such.

Actions

Acknowledge the message.



The system is available, but the machining modes are inhibited and power cannot be applied to the system.

The "PRSOV" system fault indicator is displayed in the status window (See 3.1.3).

Declare the sensor in parameter P70 (See Parameter Manual).

Reset the system to take the new parameter into account.

7.18 Several Axis Drive Sensors Have the Same Address

Message displayed at initialisation

ERROR: SEVERAL AXIS DRIVES SENSORS
POSSESS THE SAME ADDRESS
CONTINUE (Y/N)?

Comment

The same address is set for several axis sensors.

REMARK *If several sensors with the same address are connected to the same QVN fibre-optic bus, the error is not detected.*

Actions

Acknowledge the message.



The system is available, but the machining modes are inhibited and power cannot be applied to the system.

The "PRSOV" system fault indicator is displayed in the status window (See 3.1.3).

Set different addresses for each of the sensors.

Reset the system to take the new parameter into account.

7.19 List of Drives Different from the List of QVN Axes

Message displayed at initialisation

ERROR: MISMATCH BETWEEN THE DRIVES
PRESENT AND THE QVN AXES DECLARED
CONTINUE (Y/N)?

Comment

The list of drive addresses set does not match the list of speed sensor addresses declared in parameter P71 (See Parameter Manual).

Actions

Acknowledge the message.



The system is available, but the machining modes are inhibited and power cannot be applied to the system.

The "PRSOV" system fault indicator is displayed in the status window (See 3.1.3).

Change the drive address codes.

or

Set correct speed sensor addresses in parameter P71 (See Parameter Manual).

Reset the system to take the new parameter into account.

7.20 QVN Axes Missing

Message displayed at initialisation

ERROR: MISSING QVN DECLARED AXES
CONTINUE (Y/N)?

Comment

Speed sensor addresses declared in parameter P71 are not included in the list of servo-controlled axes declared in parameter P3 (See Parameter Manual).

Actions

Acknowledge the message.



The system is available, but the machining modes are inhibited and power cannot be applied to the system.

The "PRSOV" system fault indicator is displayed in the status window (See 3.1.3).

Enter the missing axis addresses in parameter P3 (See Parameter Manual).

Reset the system to take the new parameter into account.

7.21 Missing QVN Measured-Only Axes

Message displayed at initialisation

ERROR: MISSING QVN DECLARED MEASURING
ONLY AXES
CONTINUE (Y/N)?

Comment

The addresses of axes declared as measured only by QVN (sensor declared in P70 but not in P71) are not included in the list of measured-only axes (declared in P2 but not in P3, see Parameter Manual).

Actions

Acknowledge the message.



The system is available, but the machining modes are inhibited and power cannot be applied to the system.

The "PRSOV" system fault indicator is displayed in the status window (See 3.1.3).

Enter the missing axis addresses in parameter P2 (See Parameter Manual).

Reset the system to take the new parameter into account.

7.22 Sampling Period Not Within the Authorised Values

Message displayed at initialisation

SAMPLING PERIOD MUST BE A
MULTIPLE OF 1 ms AND EQUAL AT
LEAST TO 3 ms FOR AXIS QVN
DO YOU WANT TO CONTINUE (Y/N)?

Comment

The sampling period set in parameter P50 (See Parameter Manual) is not suitable for operation with DISC (the value must be a multiple of 1 ms and greater than or equal to 3 ms).

Actions

Acknowledge the message.



The system is available, but the machining modes are inhibited and power cannot be applied to the system.

The "PRSOV" system fault indicator is displayed in the status window (See 3.1.3).

Enter a correct sampling period in parameter P50 (See Parameter Manual).

Reset the system to take the new parameter into account.

7.23 Editing Parameter P98

Message displayed at initialisation

P98 HAS CHANGED! DO YOU WANT TO DESTROY
YOUR PLC ASSEMBLER PROGRAMME (Y/N)?

Comment

This is not a system fault, but a warning which may be generated when updating the CNC software.

Upgrading to a new software version is carried out by replacing:

- the memory card,
- or
- part of the memory card (daughterboard).

After the update, parameter P98 is set to 1, which corresponds to machine processor programming in Ladder language.

If the PLC programme is written in assembler, the system proposes deletion of the assembler programme at the first initialisation after update of the software.

Actions

Two cases can occur:

The assembler programme must be deleted

Accept deletion.



Y

The system is available but without a PLC programme.

Load a programme in Ladder language (See Automatic Control Function Programming Manual).

The assembler programme must be saved

Refuse deletion of the assembler programme.



N

The system is available for modification of parameter P98. The PLC fault light flashes.

Reset parameter P98 (See Parameter Manual).

Reset the system to take the parameter into account.

The system restarts with the PLC programme in assembler.

8 Operator-Accessible Maintenance

8.1 Hardware Maintenance		8 - 3
8.1.1	Maintenance on the UC SII Central Processing Unit	8 - 3
8.1.1.1	Replacing the Battery	8 - 4
8.1.1.2	Adding an SRAM Memory Module	8 - 5
8.1.2	Maintenance on the PC Module	8 - 6
8.1.2.1	Replacing the Battery	8 - 6
8.1.2.2	Adding a DRAM Memory Module	8 - 7
8.1.3	Replacing the Fuses	8 - 8
8.1.3.1	Replacing the Rack Fuses	8 - 8
8.1.3.2	Replacing the Fuse of the 10" Colour Screen	8 - 8
8.1.3.3	Replacing the Fuse of the Compact Panel with 10" Colour CRT	8 - 8
8.1.3.4	Replacing the Fuse of the 50-Key LCD Panel	8 - 9
8.1.3.5	Replacing the Machine Panel Fuse	8 - 9
8.2 Accessing the Utilities		8 - 10
8.2.1	Access to the CNC Utilities	8 - 10
8.2.2	Accessing the Utility Programmes	8 - 11
8.3 Serial Line Parameters		8 - 12
8.4 Customising the Colour Palette		8 - 16
8.4.1	Changing the Colour Palette	8 - 18
8.4.2	Selecting a Palette	8 - 18
8.5 Backing up Machine Data		8 - 19
8.5.1	Saving the Machine Data	8 - 19
8.5.2	Restoring Machine Data	8 - 20
8.5.3	Check of Machine Data Backup	8 - 21
8.6 Setting the Date and Time		8 - 22
8.7 Battery Management Update		8 - 24
8.8 Protected Memory Area Management		8 - 25
8.8.1	Change of Password	8 - 26
8.8.1.1	Selection of a New Password	8 - 27
8.8.1.2	Modification to an Existing Password	8 - 28
8.8.1.3	Removal of Password	8 - 29
8.8.1.4	Removal of Password with Loss of Protected Area	8 - 30
8.8.2	Copying Programmes from Area 0 to a Protected Zone	8 - 32
8.8.3	Locking Programmes in a Protected Area	8 - 35
8.8.4	Copying Programmes from a Protected Area	8 - 37
8.8.5	Deleting Programmes in a Protected Area	8 - 39
8.8.6	General Information on Backing Up Programmes in Protected Zones	8 - 41

8.8.7	Unloading Programmes from a Protected Zone and Checking Them	8 - 42
8.8.7.1	Unloading Protected Programmes for Copy on Other Systems	8 - 43
8.8.7.2	Global Unloading of Protected Programmes (Backup Copy)	8 - 44
8.8.7.3	Verification of Backed Up Programmes	8 - 46
8.8.8	Loading Programmes in Protected Area	8 - 47

8.9 Customisation of the System

8.9.1	Checking the Job Reference	8 - 52
8.9.2	Modification of the Number of Axes and Spindles	8 - 53
8.9.3	Modification of the Memory Sizes	8 - 54
8.9.4	Modification of the Options Grid	8 - 55
8.9.5	Entering the Date and Identifier	8 - 57
8.9.6	Locking of the Customisation	8 - 58
8.9.7	Printout of Customisation	8 - 60

Two types of maintenance operations are accessible to the operator:

- hardware maintenance by replacement of one component (fuses and batteries) or the addition of memory modules (See 8.1),
- customisation by means of the utilities (See 8.2 et seq.).

8.1 Hardware Maintenance

8.1.1 Maintenance on the UC SII Central Processing Unit

Maintenance on the UC SII central processing unit is limited to the following cases:

- replacement of the battery after 60 months of use,
- extension of the memory by adding an SRAM memory module.

The locations concerned by this work are shown in the diagram below.

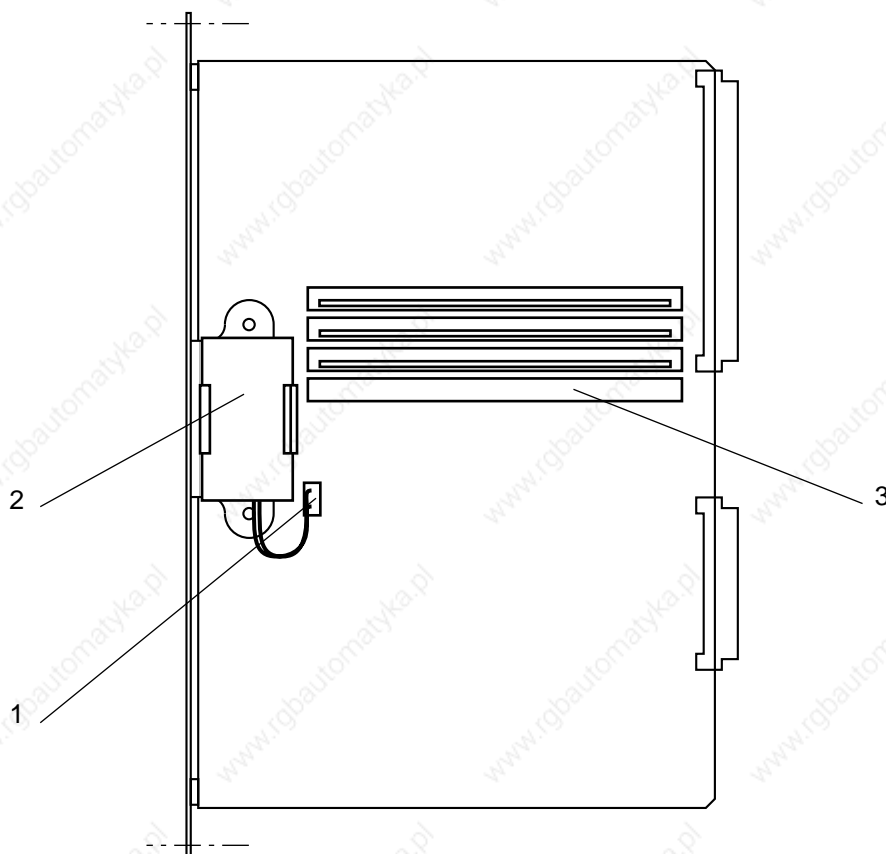

- 1 - Battery connector
- 2 - Battery (P/N 81069)
- 3 - Location for SRAM memory module

8.1.1.1 Replacing the Battery

Disconnect the old battery.

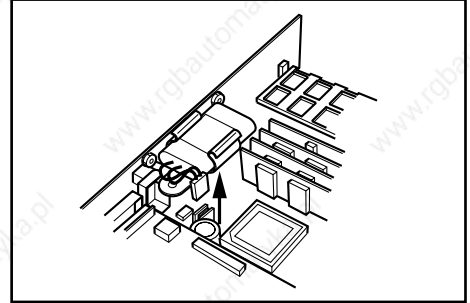

Remove the old battery from its housing.

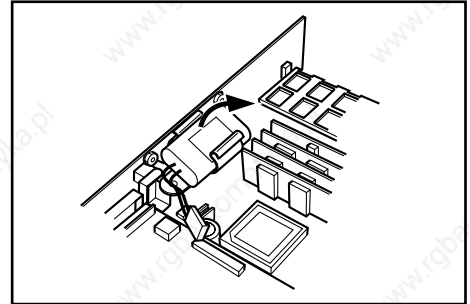

Snap the new battery into place.

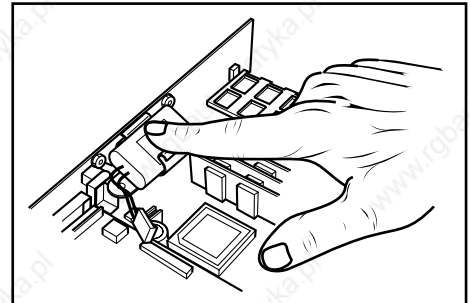

Connect the battery, checking for correct polarity of the connector.

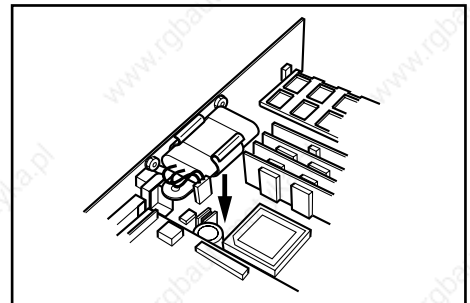

 **CAUTION**

The battery must be replaced within 15 minutes at most so as not to lose the data present in the RAM. A capacitor takes over for the battery to supply the SRAM memory modules during replacement.

8.1.1.2 Adding an SRAM Memory Module

Tilt the module into the connector with the fool-proofing notch on the left (1).

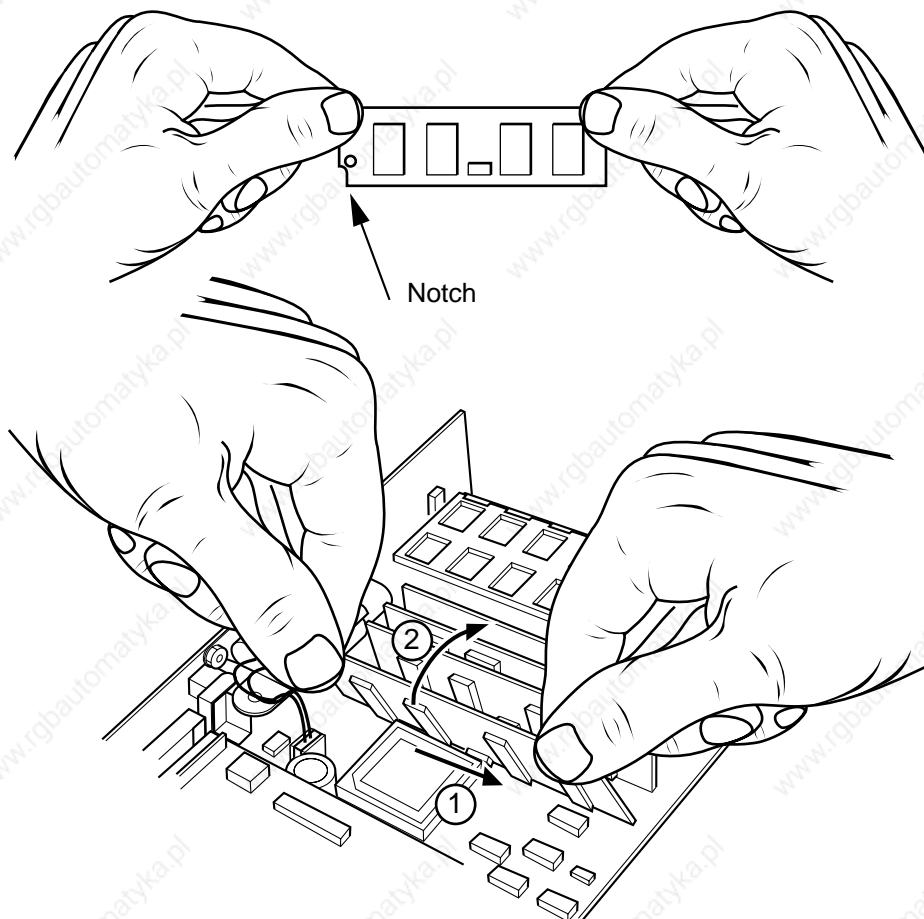

Push the module down into a horizontal position until it snaps into place (2).

8.1.2 Maintenance on the PC Module

Maintenance on the PC module is limited to the following cases:

- replacement of the battery after 60 months of use,
- extension of the memory by adding an DRAM memory module.

The locations concerned by this work are shown in the diagram below.

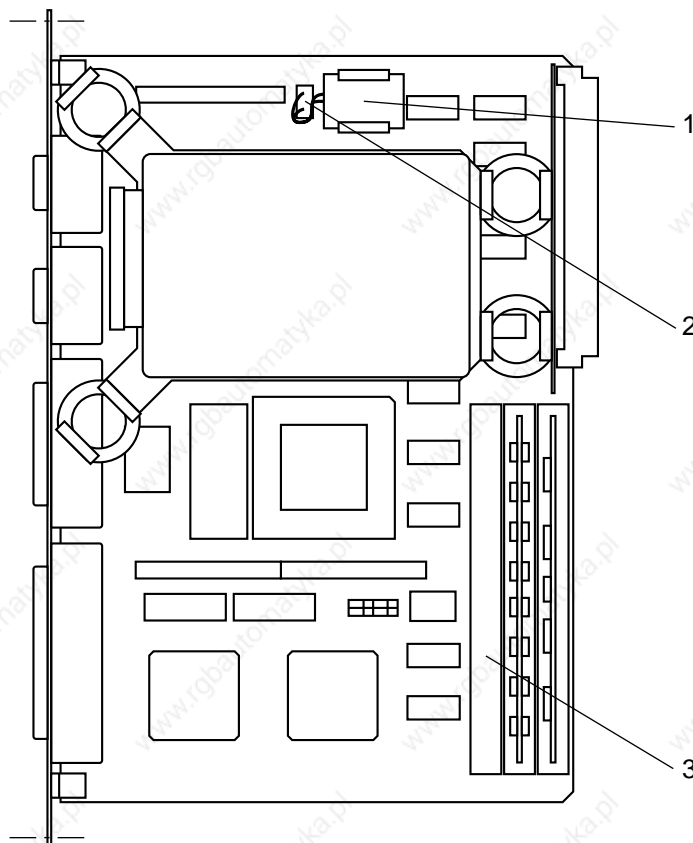

- 1 - Battery
- 2 - Battery connector
- 3 - Location for DRAM memory module

8.1.2.1 Replacing the Battery

Refer to the diagram showing the location of work on the PC module.

Disconnect (1) the old battery (2) and remove it from its housing.

Insert the new battery (2) into the housing and connect (1) it checking for correct polarity of the connector.

 **CAUTION**

The battery must be replaced within 15 minutes at most so as not to lose the backed up data present the PC (RAM CMOS). A capacitor takes over for the battery to supply the DRAM memory modules during replacement.

8.1.2.2 Adding a DRAM Memory Module

Tilt the module into the connector with the fool-proofing notch on the left (1).

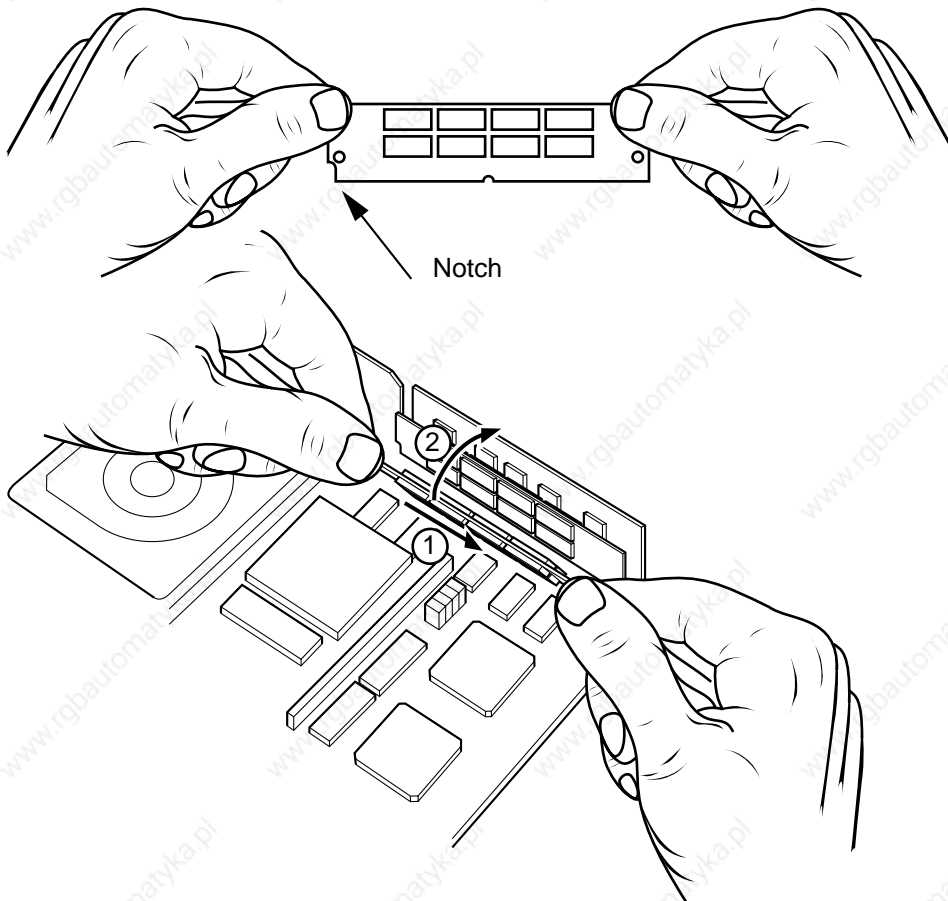

Push the module down into a horizontal position until it snaps into place (2).

8.1.3 Replacing the Fuses

Fuses accessible to the operator:

Location	Characteristics
12" and 19" racks and 2 cards	Two 2.5 A, 250 V, 5 x 20 fast-acting glass-encapsulated fuses
32-24 I/O, 64-48 I/O, 32I/24O and analogue input/output cards	10 A, 5 x 20 very fast-acting (FF) glass-encapsulated fuses The cards are provided with spare fuses

 **Use only very fast-acting (FF) fuses**

Compact panel with 10" colour CRT	2 A, 250 V, 5 x 20 fast-acting glass encapsulated fuse
50-key panel with 10" colour CRT	2 A, 250 V, 5 x 20 fast-acting glass encapsulated fuse
LCD of 50-key panel	2.5 A, 250 V, 5 x 20 glass encapsulated fuse
Machine panel	500 mA, 250 V, 5 x 20 fast-acting glass encapsulated fuse

8.1.3.1 Replacing the Rack Fuses

Remove the fuse-holder cover from the connector with a screwdriver.

Replace the blown fuse.

Install the fuse-holder cover.

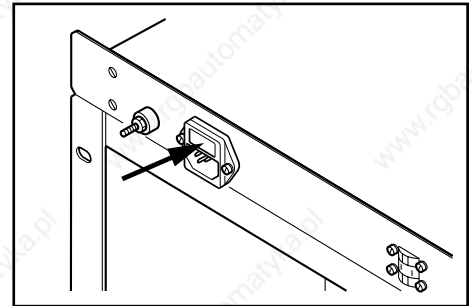

8.1.3.2 Replacing the Fuse of the 10" Colour Screen

Unlock the fuse-holder cover.

Replace the blown fuse.

Install the fuse-holder cover.

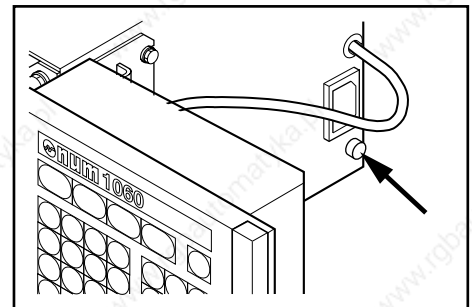

8.1.3.3 Replacing the Fuse of the Compact Panel with 10" Colour CRT

Unscrew the fuse-holder cover (quarter-turn).

Replace the blown fuse.

Install and screw on the fuse-holder cover.

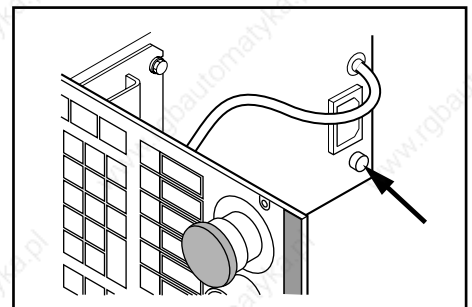

8.1.3.4 Replacing the Fuse of the 50-Key LCD Panel

Unscrew the fuse-holder cover.

Replace the blown fuse.

Install and screw on the fuse-holder cover.

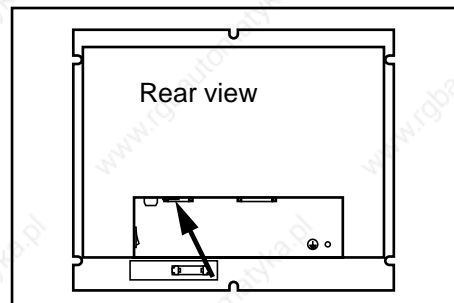

8.1.3.5 Replacing the Machine Panel Fuse

Replace the blown fuse.

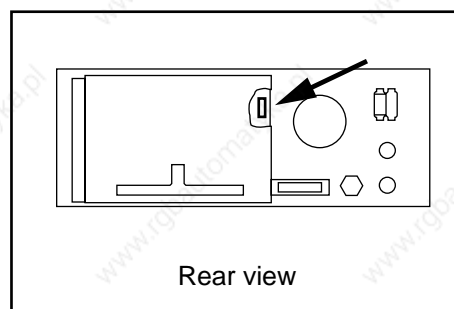

8.2 Accessing the Utilities

The utilities are divided into two categories:

- CNC utilities,
- utility programmes (access locked by PLC programme).

8.2.1 Access to the CNC Utilities

The CNC utilities include:

- utility 1: serial line parameters,
- utility 2: colour palette changes,
- utility 3: machine backup,
- utility 4: set date and time,
- utility 5: battery management

Requirements

Basic softkeys displayed.

Actions

Select the utility menu.



The "CN UTILITY" menu is displayed:

CN UTILITY	
<p>> 0 ACCESS TO UTILITY PROGRAMMES 1 SERIAL LINE PARAMETERS 2 COLOR PALETTE CHANGES 3 MACHINE BACKUP 4 SET DATE AND TIME 5 BATTERY MANAGEMENT</p>	
LINE (↔) : COMM1	
<div style="display: flex; justify-content: space-between; border-top: 1px solid black;"> z1 </div>	

To select an item, move the pointer onto the item using the up and down arrow keys or enter the item number then press .

Exit from the procedure

Select a display page.

8.2.2 Accessing the Utility Programmes

The utility programmes include:

- utility 2: Axis calibration (See Installation and Commissioning Manual),
- utility 3: Resident macros (management of protected memory areas),
- utility 5: Machine setup data (See Parameter Manual),
- utility 6: PLC assembler programming (see Assembler Programming Manual),
- utility 7: PLC Ladder programming (see Ladder Programming Manual),
- utility 12: S/W option setup,
- utility 20: Interaxis calibration (See Installation and Commissioning Manual),
- utility 22: Axis parameter integration (See SETTOOL Parameter Integration Tool Manual).

Requirements

"CN UTILITY" menu displayed (See 8.2.1).

Actions

Select "ACCESS TO UTILITY PROGRAMMES".



The "UTILITIES PRESENT" menu is displayed.

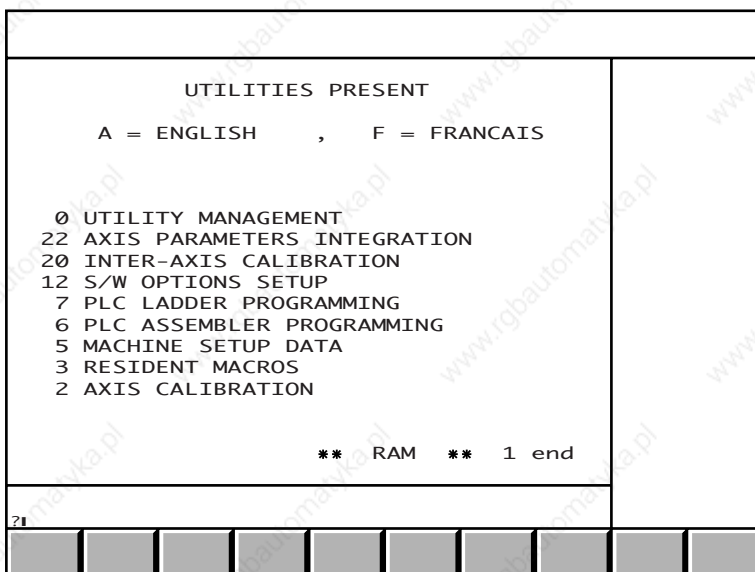

To select an item, move the cursor onto it with the up and down arrow keys or enter the item number, then press .

Select the utility language (A or F).



The text is displayed in French or English.

Select the next pages of the menu by pressing several times.



The rest of the "UTILITIES PRESENT" menu is displayed and you can toggle between the utilities in RAM and REPRM.

Exit from the procedure.

Select a display page.

8.3 Serial Line Parameters

The system gives the possibility of setting 12 serial line configurations.

These preset configurations can then be selected according to the type of communication required (load, unload, hard copy, etc.).

Requirements

"CN UTILITY" menu displayed (See 8.2.1).

Actions

Select "SERIAL LINE PARAMETERS".   

The "SERIAL LINE PARAMETERS" menu is displayed.

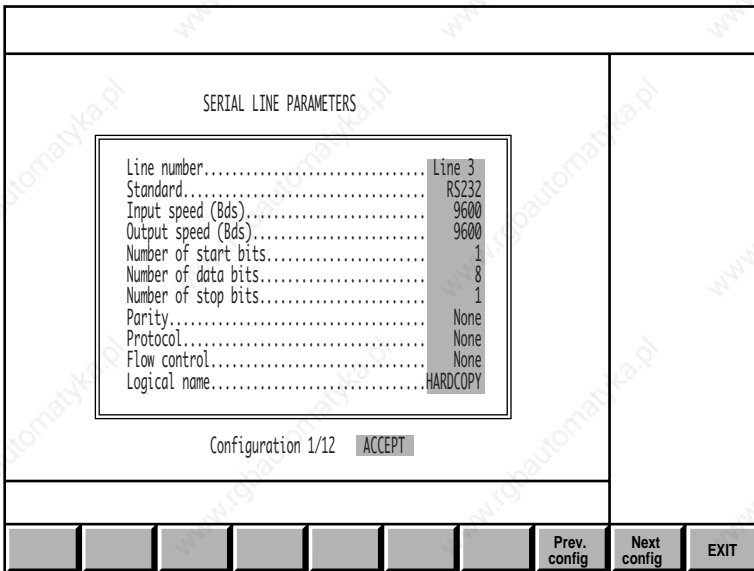

Select one of the line configurations

Select the configuration page to be modified.   OR 

The configuration number "X" is displayed: Configuration X/12.

To change the configuration

Select one of the fields to be modified (See list below).   OR 

The softkey bar displays the keys available for that field.

Select the new field value in the softkey bar.

Repeat the procedure for all the fields to be modified.

Fields of the "SERIAL LINE PARAMETERS" menu

"Line number" field

The line number is one of the available communication lines. It is accessed by the following keys (see below Assignment of Serial Line Numbers):



"Standard" field

The communication standard is selected by the following keys:



"Input speed" and "Output speed" fields

The input and output data rates are selected by the following keys:



"Number of start bits" field

The number of start bits is selected by the following keys:



"Number of data bits" field

The number of data bits is selected by the following keys:



"Number of stop bits" field

The number of stop bits is selected by the following keys:



"Parity" field

The parity type is selected by the following keys:



"Protocol" field

The protocol type is selected by the following keys:

None	DNC1	Kermit
------	------	--------

"Flow control" field

The flow control type is selected by the following keys:

None	RTS/ CTS	Xon/ Xoff
------	-------------	--------------

"Logical name" field

The logical name of the line is selected by the following keys:

HARD COPY	MESS \$5	MESS \$6		Other name
--------------	-------------	-------------	--	---------------

You can select the name of your choice:

To enter a name.		Other name
Enter the line name.		—

"Configuration" field

The following keys are used to accept or reject the configuration:

Accept	Reject
--------	--------

Exit from the Procedure

Exit from the utility.		EXIT
------------------------	---	------

Return to the "CN UTILITIES" menu.

Assignment of Serial Line Numbers

Information on numbers assigned to serial lines according to type of system.

NUM 1060 Series II with one processor

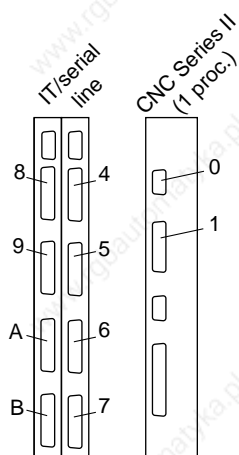

NUM 1060 Series II with two processors

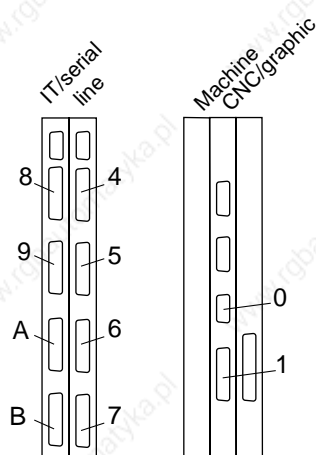

NUM 1060 Series I with V1 CNC

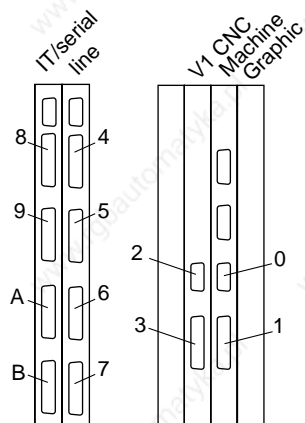

NUM 1060 Series I with V2 CNC

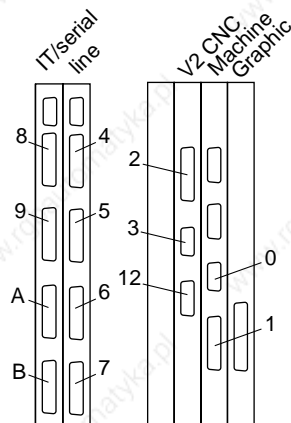

NUM 1020/1040/1050

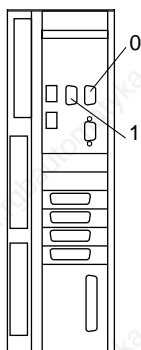

8.4 Customising the Colour Palette

The NUM 1060 CNC screens are displayed using a colour palette including:

- 14 basic colours (numbered 0 to 13),
- 2 flashing colours (14/14bis and 15/15bis).

The main uses of the colours are listed in the table below:

Colour No.	Use	Display pages or areas concerned
0	Window background	Main, dialogue windows, 3D part Information, current position window (cutting simulation)
	Edge	3D part
1	Window background	Warning box (power failure...)
	Fault message	Diagnostic messages
	Error number	Error box
	Trace	Plane 1
	Part view	3D zoom
	Below section	3D sections
2	Trace before validation	2D zoom
	Tool	2D simulation
	Side face	3D graphics
	Front section	3D sections
3	Warning message	Diagnostic messages
4	Characters received	DNC1 input/output display
	Trace	Plane 2
	Zoom window	3D zoom
	Left section	3D sections
5	Softkey text	JOG keys
	Field text	Status window
7	Field text	Status window fault field
	Softkey text	Basic softkeys
	Contour	Softkeys
8	Field background	Graphic parameters, material removal, 3D
	Key reflection	Softkeys
	Standard text	Most menus and pages
	Text	Warning box (power failure...)
	Softkey text	Mode softkeys
	Characters sent	DNC1 input/output display
	Zoom window	2D zoom
	Trace	2D simulation
	Front face	3D graphics
	Front view of axes	3D sections
9	Window background	Status window
	Softkey text	Tool softkeys
10	Top face	3D graphics

Colour No.	Use	Display pages or areas concerned
11	Field border	Information box
	Background	Softkeys
	Memory allocation	List of programmes
	H variables	Wear offsets
	Second selection line	Several menus
12	Window background	Information, warning boxes (power failure...)
	Key shading	Softkeys
13	Selected title and line	Most menus
	Tool offset numbers	Tool corrections
	Current block	Edit mode
	Variables	Programme and PLC parameters
14/14 bis	Current field	Several parameter pages
15/15 bis	Fault field	Status window

The colour palette can be customised.

Requirements

"CN UTILITY" menu displayed (See 8.2.1).

Actions

Select "COLOUR PALETTE CHANGES".   

"COLOUR SELECTION" page displayed:

COLOUR SELECTION

01234567



89101112131415

Red

Green

Blue

Red -Red +Green -Green +Blue -Blue +Custom. PaletteSaveNum PaletteEXIT

The numbers in the fields represent the colours displayed. These numbers do not appear on the screen.

The triangle selects one of the colours made of the three basic colours (red, green and blue) in the percentages indicated below on the screen.

Exit from the Procedure

Exit from the utility.



Return to the "CN UTILITY" menu.

8.4.1 Changing the Colour Palette

Select one of the colours to be changed.



Colours 0 and 15bis can be selected directly by pressing  and  respectively.

Use the Red/Green/Blue, +/- softkeys to change the colour.

The colours can be changed more rapidly by pressing the  key at the same time as the +/- keys

Save the new customised palette.

Lancer l'enregistrement de la nouvelle palette personnalisée.



Display of the message:

WARNING: ALL OLD PALETTES WILL BE LOST
OK? (YES/NO)

Confirm or refuse the palette.

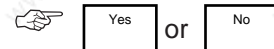

A positive answer replaces the old customised palette by the one just created. The standard NUM palette is always available.

8.4.2 Selecting a Palette

Select the colour palette to be used.



These keys toggle between the NUM palette and the customised palette.

8.5 Backing up Machine Data

This operation is used to back up and restore all the machine data including:

- the software options,
- the machine parameters,
- axis calibration,
- interaxis calibration,
- resident macros in areas 1, 2 and 3.

It is recommended to back up the machine data after each system modification (in particular the machine parameters) in order to be able to restore the configuration in case of a problem or work on the machine with a loss of data.

Requirements

Link established with the peripheral (See C.2). This link has the following characteristics:

- CTS/RTS,
- binary data transfer.

"CN UTILITY" menu displayed (See 8.2.1).

Actions

Select the serial line set for the peripheral.



Select "MACHINE BACKUP".



Display of the "MACHINE BACKUP" menu:

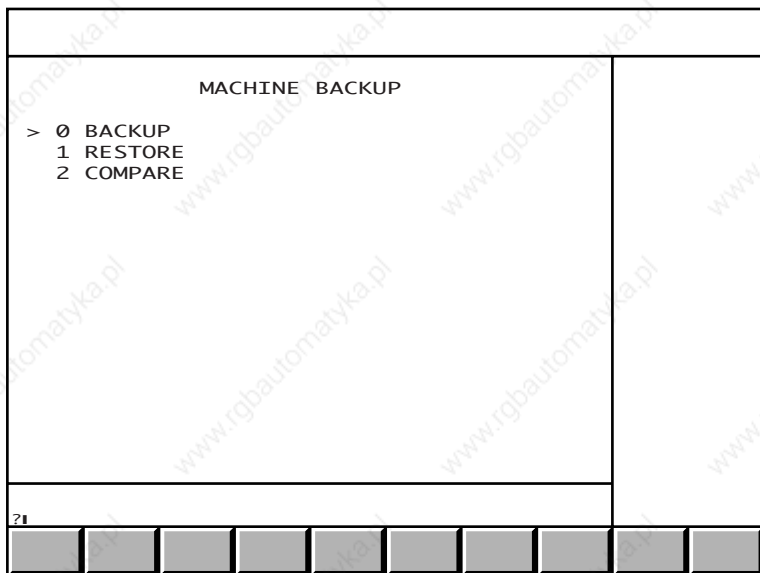

To select an item, move the cursor onto the item with the up and down arrow keys or enter the item number then press .

8.5.1 Saving the Machine Data

Requirements

Peripheral ready to receive binary data (See peripheral manual and 8.5).

"MACHINE BACKUP" menu displayed (See 8.5).

Actions

Select "BACKUP".

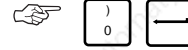

The "CNC DATA BACKUP" page is displayed with the message:

STORAGE UNIT READY?
OK? (YES/NO)

Start data reception by the peripheral.

Confirm data backup.



Display of the message:

RUNNING

When backup is completed, display of the message:

UNLOAD COMPLETED

Check data backup (See 8.5.3).

Exit from the Procedure

Stop backup.



Display of the message:

OPERATION ABORTED

8.5.2 Restoring Machine Data

Requirements

Peripheral ready to send the backed-up data (See peripheral manual and 8.5).

"MACHINE BACKUP" menu displayed (See 8.5).

Actions

Select "RESTORE".



Display of the "CNC DATA RESTORE" page and the message:

STORAGE UNIT READY?
OK? (YES/NO)

Confirm data restore.



Initiate data transfer by the peripheral.

Display of the message:

RUNNING

At the end of restore, display of the message:

LOAD COMPLETED

Exit from the utility by selecting a display page.

Display of the message:

WARNING! LOADING REQUIRES A STOP
OK? (YES/NO)

Incidents

The data transmitted are not coherent

Display of the message:

LOAD ERROR

Repeat the data restore procedure.

8.5.3 Check of Machine Data Backup

Requirements

Peripheral ready to send the backed-up data (See peripheral manual and 8.5).

"MACHINE BACKUP" menu displayed (See 8.5).

Actions

Select "COMPARE".

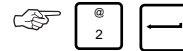

Display of the "CNC DATA COMPARE" page and the message:

STORAGE UNIT READY?
OK? (YES/NO)

Confirm data comparison.



Initiate data transfer by the peripheral.

Display of the message:

RUNNING

When comparison is completed, display of the message:

VERIFY COMPLETED

Exit from the utility by selecting a display page.

Incidents

The backed-up data are not coherent

Display of the message:

VERIFY ERROR

Repeat data backup (See 8.5.1).

8.6 Setting the Date and Time

The system date and time setting page is used to set:

- the time,
- the date,
- the day in the week.

Requirements

"CN UTILITY" menu displayed (See 8.2.1).

Actions

Select "SET DATE AND TIME".



Display of the "SET SYSTEM DATE AND TIME" page:

SET SYSTEM DATE AND TIME	
DATE : FRI 04-MAR-94	
TIME : 10:30:32	
(# or LF to modify)	

Select the time.



Display of the dialogue line:

TIME (HH mm ss) ?10 30 34█

The numbers after "?" are the current system time.

Enter the exact time (format: HH mm ss) or simply press.



The new time is set with display of the dialogue line:

DATE (YY MM DD) ?94 03 04█

The numbers after "?" are the current system date.

Set the exact date (format: YY MM DD) or simply press:



The new date is set and the dialogue line is displayed:

DAY (SUN: 0, ..., SAT: 6) ?5

The number after "?" is the number of the current system day in the week.

Enter the number of the day in the week (0 to 6) or simply press.



The new day is set and the dialogue line is cleared.

REMARK Pressing  instead of "#" after each operation inhibits display of the current system values.

8.7 Battery Management Update

The "BATTERY MANAGEMENT" page allows you to:

- see when the batteries were installed
- update the battery replacement date (See 8.1.1.1).

Whenever the system is turned on, the battery replacement date is checked. If the date has elapsed, the system generates the message "REPLACE SYSTEM BATTERIES".

REMARK *Battery management is meaningless if the system time-date is not set.*

Requirements

"CN UTILITY" menu displayed (see 8.2.1).

Actions

Select "BATTERY MANAGEMENT". 

Display of the "BATTERY MANAGEMENT" page:

BATTERY MANAGEMENT	
BATTERIES INSTALLED ON	28 AUG 98
REPLACE BATTERIES ON	15 AUG 02
<div style="display: flex; justify-content: space-between;"> Set EXIT </div>	

Select "Set" to update the battery replacement date. 

Display of the message:

Has the system date/time been set?
OK? (Yes/No)

If the system date and time are correct, confirm (or refuse) the battery replacement date. If the system time needs to be set, refer to Section 8.6 (see "Exit from the Procedure" below).

Confirm or refuse the battery replacement setting.  or

If you answer Yes, the "BATTERY MANAGEMENT" page is displayed. The dates of battery installation and replacement are modified (date of entry + 60 months, day rounded off to nearest fortnight). If you answer No, the dates are unchanged.

Exit from the Procedure

Exit from the utility.



EXIT

Display of the "CN UTILITY " menu.

8.8 Protected Memory Area Management

The purpose of protected memory areas is to prohibit access to some programmes (fixed subroutines) which may be subject to copyright, and to guarantee correct operation of the machine (the programmes in protected areas may not be modified).

To achieve this, the RAM memory is divided into four areas:

- area 0: free access user area,
- area 1: customer area,
- area 2: OEM area,
- area 3: NUM area.

Areas 1 to 3 are called protected and their access may require entry of a password: for example, the customer cannot access the OEM area if the OEM has introduced a password.

Programmes with the same numbers can exist in several memory areas. In this case, the programme in the area with the lowest number is executed (for instance, if subroutine %8567 is called and this subroutine exists in areas 1 and 3, the subroutine in area 1 is executed).

The size of the protected memory areas is specified by machine parameter P95 (See Parameter Manual).

Protected area programmes are divided into two categories:

- free access programmes,
- locked programmes.

A programme lock prohibits:

- its display on the list page (See 4.5.2),
- its display on the programme page (See 4.8),
- its copying to area 0 (See 8.8.4).

A programme can be locked when copying it to a protected area or later.

Some actions modify or delete all the programmes in one of the protected areas. This modification is followed by a machine power cutoff since deleting or modifying programmes may have consequences on the machining operations in progress.

The operating procedures for protected memory area management below concern area 1 (customer), but the procedure is identical for all other areas.

Requirements

"UTILITIES PRESENT" menu displayed (See 8.2.2).

Actions

Select "RESIDENT MACROS".



3



Display of the "RESIDENT MACROS" menu.

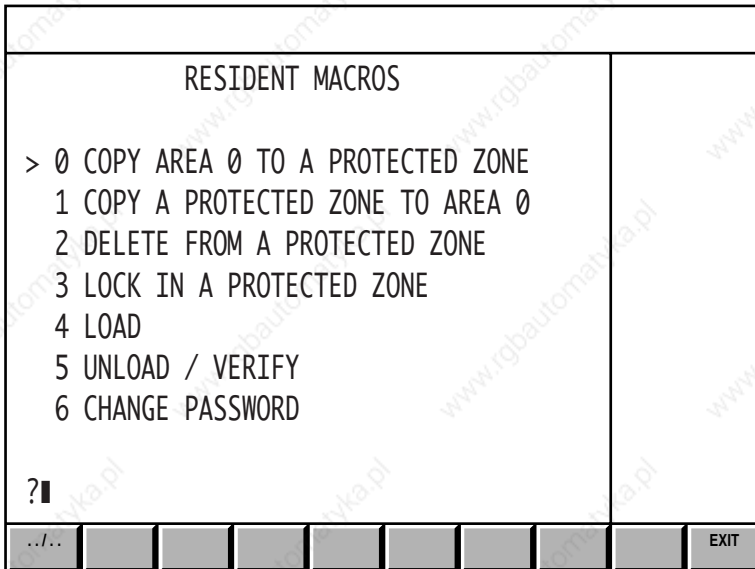

Incidents

A transfer (loading or unloading) is in progress

Display of the message:

ACCESS NOT ALLOWED: LOADING IN PROGRESS

The "RESIDENT MACROS" menu is not displayed.

Exit from the procedure

Exit from the utility.



Return to the "UTILITIES PRESENT" menu.

8.8.1 Change of Password

Requirements

"RESIDENT MACROS" menu displayed (See 8.7).

Actions

Select "CHANGE PASSWORD".

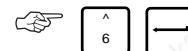

Display of the "CHANGE PASSWORD" menu.

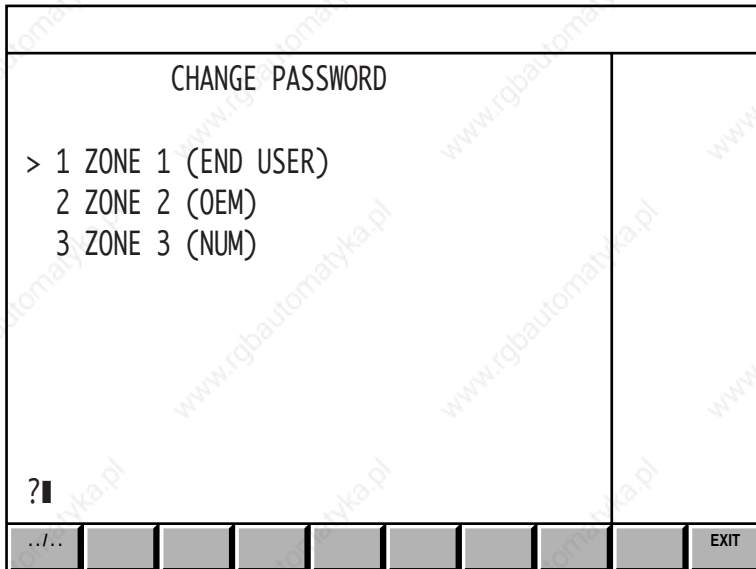

Exit from the procedure

Return to the "RESIDENT MACROS" menu".



8.8.1.1 Selection of a New Password

Requirements

"CHANGE PASSWORD" menu displayed (See 8.8.1).

Actions

Select "ZONE 1 (END USER)".



Display of the "ZONE 1 (END USER)" page and the message:

MODIFICATION:
ENTER A NEW PASSWORD

Enter a new password (16 characters maximum).



The characters making up the password are not displayed.

Display of the message:

VERIFICATION:
RE-ENTER THE PASSWORD







Re-enter the password for verification.  

Display of the message:

VALIDATE NEW PASSWORD:

and the dialogue line:

? (Y,N) █

Validating the password	Password not modified
Validate the password   	Refuse modification   
Display of the message: PROTECTED ZONE UNCHANGED NEW PASSWORD IS VALID	Display of the message: MODIFICATION ABORTED: PASSWORD NOT MODIFIED PROTECTED AREA UNCHANGED

Return to the "RESIDENT MACROS" menu.  



Incidents

Password entered for verification different from previous password

Display of the message:

VERIFICATION ERROR:

PASSWORD NOT MODIFIED
PROTECTED AREA UNCHANGED

Return to the "RESIDENT MACROS" menu.  

8.8.1.2 Modification to an Existing Password

Requirements

"CHANGE PASSWORD" menu displayed (See 8.8.1).

The area is already protected by a password.

Actions

Select "ZONE 1 (END USER)".   

Display of the "ZONE 1 (END USER)" page and the message:

ENTER YOUR PASSWORD

Enter the old password.  

The characters making up the password are not displayed.

Display of the message:

MODIFICATION:
ENTER A NEW PASSWORD

The rest of the procedure is identical to Section 8.7.1.1.

Incidents

The password entered is not recognised

Display of the message:

INCORRECT PASSWORD

The "RESIDENT MACROS" page is displayed after a few seconds.

8.8.1.3 Removal of Password

Requirements

"CHANGE PASSWORD" menu displayed (See 8.8.1).

Select "ZONE 1 (END USER)".

Actions

Select "ZONE 1 (END USER)".

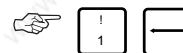

Display of the "ZONE 1 (END USER)" page and the message:

ENTER YOUR PASSWORD

Enter the old password.



Display of the message:

MODIFICATION:
ENTER A NEW PASSWORD

Do not enter a new password.





Display of the message:

REMOVE PASSWORD

and the dialogue line:

? (Y,N) █

Deleting the password	Password not deleted
Delete the password 	Refuse deletion 
Display of the message: PROTECTED ZONE UNCHANGED PASSWORD REMOVED	Display of the message: MODIFICATION ABORTED: PASSWORD NOT MODIFIED PROTECTED AREA UNCHANGED

Return to the "RESIDENT MACROS" menu.



8.8.1.4 Removal of Password with Loss of Protected Area

If the password has been forgotten, which prohibits the use of the protected area, the system offers the possibility to remove the existing password.

This removal is followed by the deletion of the protected area contents to prohibit access to locked programmes.

Only unlocked programmes in the protected area may be saved before removing the password by copying them to area 0 (See 8.8.4).

Requirements

"CHANGE PASSWORD" menu displayed (See 8.8.1).

The area is already protected by a password.

Programmes to be saved (excluding locked programmes) copied to area 0.

Actions

Select "ZONE 1 (END USER)".



Display of the "ZONE 1 (END USER)" page and the message:

ENTER YOUR PASSWORD

Do not enter your password.



Display of the message:













OLD PASSWORD NOT GIVEN

WARNING: COMPLETE ZONE WILL BE CLEARED
AND SHUT DOWN THE POWER

ENTER NEW PASSWORD

CAUTION

Completing the procedure to the end causes the irretrievable loss of all programmes in the protected area.

Deleting the zone and entering a new password	Deleting the zone and password
Enter a password (maximum 16 characters).  	Do not enter a password  
Display of the message: VERIFICATION: RE-ENTER THE PASSWORD	
Re-enter the password for verification.  	
Display of the message: PROTECTED ZONE WILL BE CLEARED VALIDATE NEW PASSWORD: and the dialogue line: ? (Y,N) █	Display of the message: PROTECTED ZONE WILL BE CLEARED REMOVE PASSWORD: and the dialogue line: ? (Y,N) █
Confirm deletion of the protected zone and validate the password,   	Confirm deletion of the protected zone,   
The machine power is turned off with display of the message: PROTECTED ZONE CLEARED NEW PASSWORD IS VALID	The machine power is turned off with display of the message: PROTECTED ZONE CLEARED PASSWORD REMOVED

Return to the "RESIDENT MACROS" menu.



Exit from the procedure

In answer to one of the questions:

VALIDATE NEW PASSWORD:

or

REMOVE PASSWORD:

? (Y,N) █

Answer no.



Display of the message:

MODIFICATION ABORTED:

PASSWORD NOT MODIFIED
PROTECTED AREA UNCHANGED

Return to the "RESIDENT MACROS" menu.



8.8.2 Copying Programmes from Area 0 to a Protected Zone

Requirements

"RESIDENT MACROS" menu displayed (See 8.8).

Actions

Select "COPY AREA 0 TO A PROTECTED ZONE."

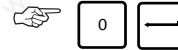

Display of the "COPY AREA 0 TO A PROTECTED ZONE" menu:

COPY AREA 0 TO A PROTECTED ZONE									
> 1 COPY TO ZONE 1									
2 COPY TO ZONE 2									
3 COPY TO ZONE 3									
?									
...									EXIT

Select "COPY TO ZONE 1".



Display of the "ZONE 1 (END USER)" page.

If there is a password, display of the message:

ENTER YOUR PASSWORD

Enter your password.



Display of the dialogue line:

(%% / %..-->&1) %|

There are two possibilities:

Copying programmes individually

Enter "[Programme No.]" (for example "1.2).





Display of the message:

LOCK (CANNOT BE REMOVED) ?

and of the dialogue line:

(&1% / &1%..)(:)(V) &1%1.2

Lock of programme	Copy only
Type ":V" after the programme number	
Validate  <input type="button" value="—"/>	Validate  <input type="button" value="—"/>
Display of the message: END OF COPY / LOCK	Display of the message: END OF COPY

Repeat the copy procedure for the following programmes.

Copying all programmes in area 0

Type "%".





Display of the message:

TOTAL DUPLICATION;
CURRENT DATA WILL BE DESTROYED
WARNING: SHUT DOWN THE POWER

and of the dialogue line:

? (Y,N)

Copying all the programmes	Zone not cleared
Shut down the machine	
Confirm copy of all programmes  <input type="button" value="Y"/> <input type="button" value="—"/>	Refuse clear  <input type="button" value="N"/> <input type="button" value="—"/>
Display of the message: LOCK (CANNOT BE REMOVED)? and the dialogue line: (&1% / &1%..)(:)(V) &1%	Display of the dialogue line: (&1% / &1%..)(:)(V) &1%
The programmes are locked or not as in the case of a single programme.	

Incidents

Error in password

Display of the message:

INCORRECT PASSWORD

The "RESIDENT MACROS" menu is redisplayed after a few seconds.

If there is not enough memory in the protected zone for copying the programme(s)

Display of the message:

MEMORY ZONE FULL

If required, repeat the operation with a smaller programme.

REMARK *The memory space can be increased by machine parameter P95 (See Parameter Manual) before repeating the copy procedure.*

A programme with the same number already exists in the protected area

Display of the message:

PROGRAMME ALREADY EXISTS

Continue if necessary with other programmes.

or

Delete the existing programme (See 8.8.5) before repeating the copy procedure.

The programme specified does not exist in area 0

Display of the message:

PROGRAMME DOES NOT EXIST

Continue if necessary with other programmes.

Exit from the procedure

Return to the "RESIDENT MACROS" menu.



EXIT



8.8.3 Locking Programmes in a Protected Area

Requirements

"RESIDENT MACROS" menu displayed (See 8.8).

Certain programmes in the protected zone are not locked.

Actions

Select "LOCK IN PROTECTED ZONE".   

Display of the "LOCK IN PROTECTED ZONE" menu.

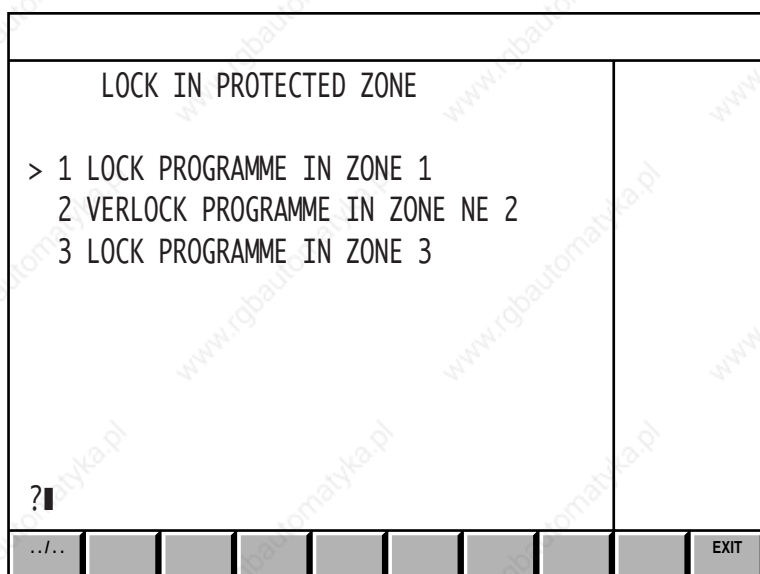

Select "LOCK PROGRAMME IN ZONE 1".   

Display of the "ZONE 1 (END USER)" page.

If there is a password, display of the message:

ENTER YOUR PASSWORD







Enter the password.  

Display of the message:

WARNING LOCKED CANNOT BE REMOVED

and of the dialogue line:

(&1% / &1%..)(:)(V) &1%

Locking programmes individually	Locking the complete area
Enter "[Programme No.]:V" (e.g. "1.2:V").  	Enter "%:V"  
	Display of the message: LOCK COMPLETE AREA? and the dialogue line: ? (Y,N) █
	Confirm locking of the complete area.   
Display of the message: PROGRAMME LOCKED You can repeat the locking procedure for other programmes on the dialogue line.	Display of the message: ZONE LOCKED

Incidents

Error in password

Display of the message:

INCORRECT PASSWORD

The "RESIDENT MACROS" menu is redisplayed after a few seconds.

The ":V" string was omitted after the programme number

Display of the message:

:V NEEDED

Enter ":V".  

Proceed with the operations.

The programme specified does not exist in protected area

Display of the message:

PROGRAM DOES NOT EXIST

If required continue the operations with other programmes.

Exit from the procedure

Return to the "RESIDENT MACROS" menu.  

8.8.4 Copying Programmes from a Protected Area

Copying a programme to area 0 enables various operations impossible from protected areas:

- editing and modifying the programme,
- printing the listing of the programme...

Programmes can only be copied individually. Global copy is impossible.

Locked programmes cannot be copied in zone 0.

Requirements

"RESIDENT MACROS" menu displayed (See 8.8).

Programmes already present in the protected area.

Actions

Select "COPY A PROTECTED ZONE TO AREA 0". 

Display of the "COPY A PROTECTED ZONE TO AREA 0" menu.

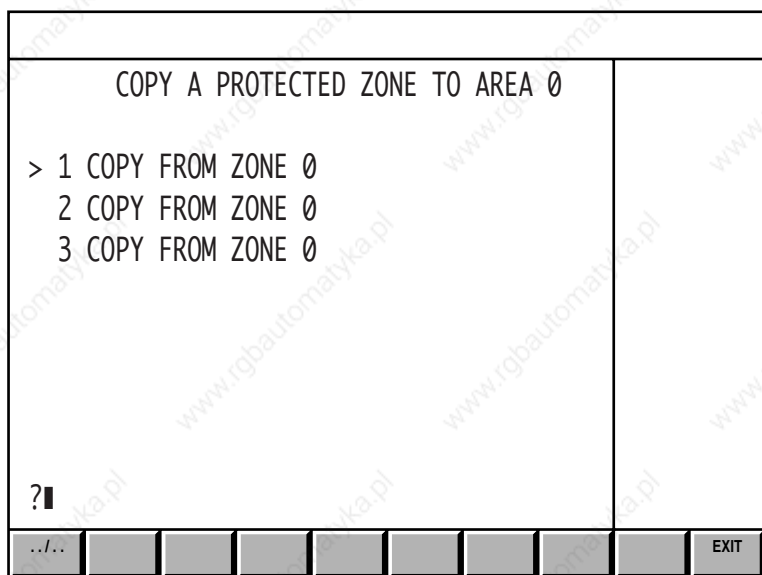

Select "COPY FROM ZONE 1". 

Display of the "ZONE 1 (END USER)" page.

If there is a password, display of the message:

ENTER YOUR PASSWORD

Enter the password. 

Display of the dialogue line:

(&1%. .-->%. .) &1%

Enter "[programme No.]" (for example "1.2"). 

Display of the message:

END OF COPY

You can repeat the copy procedure for other programmes.

Incidents

Error in password

Display of the message:

INCORRECT PASSWORD

The "RESIDENT MACROS" menu is redisplayed after a few seconds.

Insufficient memory space in area 0 for copy of the programme

Display of the message:

MEMORY ZONE FULL

If required, repeat the operation with a smaller programme.

The programme to be copied is locked

Display of the message:

PROTECTED PROGRAMME

It is impossible to copy this programme to area 0

If required continue the operations with other programmes.

A programme with the same number already exists in area 0

Display of the message:

PROGRAMME ALREADY EXISTS

If required continue the operations with other programmes.

or

Delete the existing programme (See 5.4.2.3) and repeat the copy procedure.

The programme specified does not exist in the protected area

Display of the message:

PROGRAMME DOES NOT EXIST

If required continue the operations with other programmes.

Exit from the procedure

Return to the "RESIDENT MACROS" menu.



EXIT

8.8.5 Deleting Programmes in a Protected Area

Requirements

"RESIDENT MACROS" menu displayed (See 8.8).

Programmes present in the protected area.

Actions

Select "DELETE FROM PROTECTED ZONE".



Display of the message:

WARNING! SHUT DOWN THE POWER
READY?

and the dialogue line:

? (Y,N) █

Shut down the machine.

Confirm shutdown.



Display of the "DELETE FROM PROTECTED ZONE" menu :

DELETE FROM PROTECTED ZONE									
> 1 DELETE PROGRAMME FROM ZONE 1 2 DELETE PROGRAMME FROM ZONE 2 3 DELETE PROGRAMME FROM ZONE 3									
? █									
...									EXIT

Select "DELETE PROGRAMME FROM ZONE 1".



Display of the "ZONE 1 (END USER)" page.

If there is a password, display of the message:







ENTER YOUR PASSWORD

Enter your password.



Display of the dialogue line:

(-&1% / -&1%..) -&1%■

Deleting programmes individually	Deleting the complete area
Enter "[Programme No.]" (e.g. "1.2").  	Enter "%"  
	Display of the message: CLEAR COMPLETE AREA? and the dialogue line: ? (Y,N) ■
	Confirm deletion of the complete area.   
Display of the message: PROGRAMME DELETED You can repeat the delete operation on the dialogue line for other programmes.	Display of the message: ZONE DELETED

Incidents

Error in password

Display of the message:

INCORRECT PASSWORD

The "RESIDENT MACROS" menu is redisplayed after a few seconds.

The programme specified does not exist in area 1

Display of the message:

PROGRAM DOES NOT EXIST

If required continue the operations with other programmes.

Exit from the procedure



Return to the "RESIDENT MACROS" menu.  

The machine should not be shutdown because of the operations in progress

When the question is displayed:

WARNING! SHUT DOWN THE POWER
READY?

? (Y,N) ■

Choose not to stop the machine.   

The "RESIDENT MACROS" menu is redisplayed.

Abort deletion of all the programmes in the protected area

In answer to the question:

CANCEL ALL AREA?
? (Y,N) █

Select not to cancel all the protected area.



Display of the message:

NOT DELETED

and the dialogue line:

(-&1% / -&1%.) -&1% █

If required continue the operations with other programmes.

8.8.6 General Information on Backing Up Programmes in Protected Zones

When the system is supplied, protected areas 2 (OEM) and 3 (NUM) may contain applications specifically related to the machine.

It is very important to back up this data in case all or part of the RAM memory should be erased by accident.

If this has not yet been done by the OEM, the user is advised to make a backup copy of the contents of these protected areas by unloading to a memory backup peripheral (See 8.8.7).

If the user develops his own applications and stores them in protected area 1, he is advised to make a backup copy of the contents of this area at regular intervals.

Should problems occur, the user is thus able to reinstall these applications on his system by loading them from the backup peripheral (See 8.8.8).

8.8.7 Unloading Programmes from a Protected Zone and Checking Them

The purpose of unloading is to save the programmes on a storage medium:

- individually or globally to reload them in other systems (this operation requires entry of the password for the zone)
- globally used as a backup copy of all the protected area on a single system (the backup is carried out without entering the password but requires entry of the system job reference).

Unloading also allows a check of the conformity of the programmes on backup with those in the protected area.

Unloading is performed in encrypted binary form, making it impossible to read backed-up programmes.

Requirements

"RESIDENT MACROS" menu displayed (See 8.8).

Actions

Select "UNLOAD/VERIFY".   

Display of the "UNLOAD FROM PROTECTED AREA" menu.

UNLOAD FROM PROTECTED AREA									
> 1 ZONE 1 (END USER) 2 ZONE 2 (OEM) 3 ZONE 3 (NUM)									
?									
...									EXIT

Select "ZONE 1 (END USER)".   

Display of the "ZONE 1 (END USER)" page and the dialogue line:

(&1% / %* / %..) [> &1%

Exit from the procedure

Return to the "RESIDENT MACROS" menu".  

8.8.7.1 Unloading Protected Programmes for Copy on Other Systems

Requirements

CNC connected to the peripheral (See C.2).

Peripheral ready to receive binary data (See peripheral manual).

CNC transmission baud rate (See 8.3) conforming to the peripheral reception baud rate.

Unloading dialogue line displayed (See 8.8.7).

Programmes present in the protected area.

Actions

Saving programmes individually	Backing up the complete zone
Enter "[Programme No.]" (e.g. "1.2").	Enter "%*"

If there is a password, display of the message:

ENTER YOUR PASSWORD

Enter the password.



Display of the message:

UNLOAD

and of the dialogue line:

? (Y,N) █

Initiate the reception of data by the peripheral.

Confirm unloading of the programme.



Display of the message:

UNLOADING IN PROGRESS

Then, at the end of unloading, of the message:

BACKUP COMPLETED

Display of the "VERIFY PROTECTED AREA" page and the message:

VERIFY

and of the dialogue line:

? (Y,N) █

Verifying the programme unloaded	No verification of the programme
Verify the programme (See 8.8.7.3)	Refuse the verify operation



Continue the procedure with other programmes if necessary.

Incidents

Error in password

Display of the message:

INCORRECT PASSWORD

The "RESIDENT MACROS" menu displayed after a few seconds.

The programme specified does not exist in the protected area

Display of the message:

PROGRAMME DOES NOT EXIST

If required continue the operations with other programmes.

Verifying a programme without unloading it

The programme to be verified must already be present on the storage medium.

In answer to the question:

UNLOAD
? (Y,N) █

Select not to unload the programme.

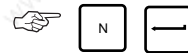

Display of the "VERIFY PROTECTED ZONE" page and the message:

VERIFY

and the dialogue line

? (Y,N) █

Verify the programme (See 8.8.7.3).

8.8.7.2 Global Unloading of Protected Programmes (Backup Copy)

Requirements

CNC connected to the peripheral (See C.2).

Peripheral ready to receive binary data (See peripheral manual).

CNC transmission baud rate (See 8.3) conforming to the peripheral reception baud rate.

Unloading dialogue line displayed (See 8.7.7).

Programmes present in the protected area.

Actions

Enter "%".



Display of the message:

UNLOAD

and of the dialogue line:

? (Y,N) █

Initiate the reception of data by the peripheral.

Confirm unloading of the programmes.



Display of message:

UNLOADING IN PROGRESS

Then, at the end of unloading, of the message:

BACKUP COMPLETED

Display of the "VERIFY PROTECTED ZONE" page and the message:

VERIFY

and the dialogue line:

? (Y,N) █

Verification of the unloaded programmes	No programme verification
Verify the backup (See 8.8.7.3)	Refuse the verification



Incidents

No programmes in the protected area

Display of the message:

PROGRAMME DOES NOT EXIST

Return to the "RESIDENT MACROS" menu.



Verifying a backup without unloading

An earlier backup must already be present on the storage medium.

In answer to the question:

UNLOAD

? (Y,N) █

Select not to unload the programme.



Display of the message:

VERIFY

and of the dialogue line

? (Y,N) █

Verify the backup (See 8.8.7.3).

8.8.7.3 Verification of Backed Up Programmes

Verification of a backed up programme may be performed immediately after unloading or at any time to verify the conformity of the backup programmes with those in the protected area.

Requirements

CNC connected to the peripheral (See C.2).

Peripheral ready to transmit binary data (See peripheral manual).

CNC reception baud rate (See 8.3) conforming to the peripheral reception baud rate.

Programmes present in the protected area.

The "VERIFY PROTECTED ZONE" page is displayed with the question "VERIFY? (Y,N)" after acceptance or refusal of unloading (See 8.8.7.1 and 8.8.7.2).

Actions

Confirm verification. 

Start data transmission via the peripheral.

Display of three lines identifying the type of backup verified, e.g.:

Single programme (COPY)	All programmes (COPY)	All programmes (backup)
VERSION: 00 IDENTIFICATOR: INC1 PROG. No .: %1.2	VERSION: 00 IDENTIFICATOR: GL01 AFFAIRE No.: *	VERSION: 00 IDENTIFICATOR: ZON1 AFFAIRE No.: XXXXXX00

and of the message:

VERIFICATION IN PROGRESS

At the end of the verification, display of message:

BACKUP OK!

Return to the "RESIDENT MACROS" menu. 

Incidents

The backed up data differ from those in the protected area

Display of the message:

INCORRECT BACKUP

Return to the "RESIDENT MACROS" menu. 

The peripheral started transmitting data too soon

The CNC must be ready to receive data before the peripheral start transmitting or the CNC does not recognise the beginning of the file and displays the message:

WRONG SEGMENT REFERENCE
WRONG SEGMENT IDENTIFIER

Repeat the verification procedure.

Exit from the procedure

In answer to the question:

VERIFY
? (Y,N) █

Select not to verify the programmes.



Return to the "RESIDENT MACROS" menu.



8.8.8 Loading Programmes in Protected Area

The purpose of loading is to install backup programmes in the protected area:

- individually or globally in the case of programmes from other systems (job reference not indicated),
- globally from the backup copy of the protected area performed on the same system (job number verification).

When the programmes have been loaded, they retain their original characteristics:

- same protected area,
- locked programmes remain locked,
- the area password is not affected by loading.

Requirements

CNC connected to the peripheral (See C.2).

Peripheral ready to transmit binary data (See peripheral manual).

CNC reception baud rate (See 8.3) conforming to the peripheral transmission baud rate.

"RESIDENT MACROS" menu displayed (See 8.8).

Actions

Select "LOAD".

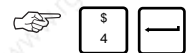

Display of the "LOAD IN PROTECTED AREA" page:

LOAD IN PROTECTED AREA									
LOAD CURRENT DATA WILL BE DESTROYED WARNING! SHUT DOWN THE POWER. READY?									
? (Y,N) █									
...									EXIT

Confirm loading.



Initiate the transmission of data by the peripheral.

The name of the memory zone for the data loaded is displayed in the title bar (e.g. "ZONE 1 (END USER)").

If only one programme is loaded, the programme number is displayed, e.g.:

PROGRAMME No. : %1.2

Display of the message:

WRITING IN PROGRESS

At the end of transmission, display of the message:

BACKUP LOADED

Return to the "RESIDENT MACROS" menu.



Incidents

Not enough memory in the protected area to copy the programme(s)

Display of the message:

MEMORY ZONE FULL

If required, repeat the operation with a smaller programme.

REMARK *The memory size can be increased by machine parameter P95 (See Parameter Manual) before resuming copy.*

A programme with the same number already exists in the protected area.

Display of the message:

PROGRAM ALREADY EXISTS

If required continue the operations with other programmes.

or

Delete the existing programme (See 8.8.5) before proceeding with the copy of the programme.

Checksum error at the end of loading

Display of the message:

INCORRECT BACKUP

There are two possibilities:

- if it is a restitution of all the programmes in an area, all the area is deleted,
- if it is an isolated programme being loaded, the programme is retained, but the data it contains may be wrong.

Return to the "RESIDENT MACROS" menu.



EXIT

Attempt to load a backup copy onto another system

Display of the message:

WRONG SEGMENT REFERENCE

Loading is impossible on this system.

Return to the "RESIDENT MACROS" menu.



EXIT

Exit from the procedure

Return to the "RESIDENT MACROS" menu.



EXIT

8.9 Customisation of the System

The CNC as supplied was customised according to the initial option choices made by the customer.

This customisation has been carried out by NUM or by the OEM.

During the machine lifetime, it may happen that the customer requires extra functions corresponding to a different customisation.

These functions may be supplied by NUM as a grid comprising various data to be entered into the system.

Example of customisation grid

```
JOB REFERENCE      : XXXXXX 00
EEPROM SOFTWARE #  : SIMU EEP
CNC SOFTWARE #     : 202606C1
USER PLC SOFTWARE # :
PARAMETERS TABLE  : F8
```

OPTIONS PRESENT:

```
COMM.  DEV.
61250  11
61371  13
61501  42
61511  47
        60
        110
```

```
NUMBER OF CNC OR PLC AXES : 7
NUMBER OF SPINDLES        : 2
NUMBER OF INTERPOLATED AXES : 5
NUMBER OF PLC ONLY AXES   : 1
```

```
PART PROGRAM STORAGE : 768
PLC PROGRAM STORAGE  : 256
```

GRID:

```
140000 210008 0 20000
0 0 0 0
```

KEY:

```
138467C5
```

```
DATE: 18 5 92
TIME: 9 15 0
```

```
IDENTIFICATION: CABE-EF
```

RESUME:

```
XXXXXX 00 / 140000 210008 0 20000 0 0 0 0
7 2 5 2 / 128 64 / CABE-EF / 138467C5
```

Requirements

"UTILITIES PRESENT" menu displayed (See 8.2.2).

Customisation grid available.

Actions

Select "OPTIONS LOCKING".



Display of the "OPTIONS LOCKING" menu:

OPTIONS LOCKING	
> 0 JOB REFERENCE	
1 AXES NUMBER	
2 MEMORY SIZE	
3 OPTIONS LIST	
4 DATE	
5 LOCKING	
6 EDITION	
?	
...	EXIT

The mandatory customisation steps are:

- checking the job reference (See 8.9.1),
- modifying the options list: mandatory key (See 8.9.4),
- entering the date and an identifier (See 8.9.5),
- locking the customisation (See 8.9.6).

The following steps are carried out only if one of the items below is modified in the new customisation (it is however advised to check the content of the pages):

- modification of the number of axes and spindles (See 8.9.2),
- modification of the memory size (See 8.9.3).

Printout of the customisation (See 8.9.7) gives a record of the customisation carried out.

Exit from the Utility

You can exit from the utility:



- After a consultation without making any changes, in which case it is unnecessary to reset the system (See below)
- After modifying the configuration (the new configuration must be locked: see 8.9.6), in which case it is necessary to reset the system to take the changes into account.

Exit from the utility.



Display of the "UTILISATION IMMEDIATE DES MODIF." page and the message:

WARNING! SHUT DOWN THE POWER
OK? (Y/N):

Modifications applied immediately	Delayed application
Shut down the power	
Confirm immediate use  <input type="checkbox"/> Y <input type="checkbox"/> —	Delay application of the modifications  <input type="checkbox"/> N <input type="checkbox"/> —
The system is reset.	Return to the "UTILITIES PRESENT" menu. The modifications are not applied until the system is reset.

8.9.1 Checking the Job Reference

Requirements

"S/W OPTIONS SETUP" menu displayed (See 8.9).

Actions

Select "AFFAIRE No." (job reference).

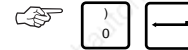

Display of the "JOB REFERENCE AND IDENTIFIERS" page.

JOB REFERENCE AND IDENTIFIERS	
JOB REFERENCE	: XXXXXX 00
EEPROM SOFTWARE	: SIMU EEP
CNC SOFTWARE	: 202606C1
USER PLC SOFTWARE	: XXXX
PARAMETERS TABLE	: F8
OK (Y/N) ?	
...	EXIT

The job reference corresponds to that mentioned on the customisation grid:

Validate the page.



Return to the "S/W OPTIONS SETUP" menu.

Incidents

The job reference does not correspond

Do not validate the page.

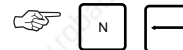

Display of message:

THE AFFAIRE No. DOES NOT CORRESPOND
WITH THE LOCKING CODE

QUIT THE UTILITY: CTRL X-OFF

Return to the "UTILITIES PRESENT" menu.



8.9.2 Modification of the Number of Axes and Spindles

The modification consists in entering the new values for the number of axes and spindles taken from the customisation grid.

Requirements

"S/W OPTIONS SETUP" menu displayed (See 8.9).

Actions

Select "NUMBER OF AXES".

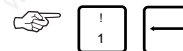

The "AXES NUMBER" page is displayed:

AXES NUMBER	
NUMBER OF CNC OR PLC AXES	: 7
NUMBER OF SPINDLES	: 2
NUMBER OF INTERPOLATED AXES	: 5
NUMBER OF PLC ONLY AXES	: 2
(A,B,IS,XA) ? █	
...	EXIT

Enter the values to be modified (See syntax below).



Value to be modified	Syntax
Number of CNC or PLC axes	A [value]
Number of spindles	B [value]
Number of interpolated axes	IS [value]
Number of PLC axes	XA [value]

Display of the new values in the page.

Return to the "S/W OPTIONS SETUP" menu.



Example : changing the number of PLC axes to 1

Enter "XA 1".



Display of the line:

NUMBER OF PLC ONLY AXES: 1

REMARK *It is possible to enter several modification instructions on the same line leaving a space between them.*

8.9.3 Modification of the Memory Sizes

This modification consists in entering the memory sizes mentioned on the customisation grid.

Requirements

"S/W OPTIONS SETUP" menu displayed (See 8.9).

Actions

Select "MEMORY SIZE".



Display of the "MEMORY SIZES" page.

MEMORY SIZES	
PART PROGRAM STORAGE	: 768
PLC PROGRAM STORAGE	: 128
(PP,PLC) ? █	
...	EXIT

Enter the values to be modified (See syntax below).



Value to be modified	Syntax
First of the eight numbers	GR [value]
Numbers 2 to 8	G[rank] [value]
Option key (mandatory)	C [value]

Display of the new values in the page.

Return to the "S/W OPTIONS SETUP" menu.



Example : change the second number to 21008 and enter the option key

Enter "G2 21008 C 138467C5".



Display of the new lines :

```

GRID :
140000 21008 0 20000
0 0 0 0
KEY :
138467C5
    
```

REMARK

In the example, the modification instructions are all on the same line, separated by spaces.

8.9.5 Entering the Date and Identifier

Entering of the date and the identifier is compulsory, but the user has complete freedom for the values entered (within the limits of the date and time formats).

Requirements

"S/W OPTIONS SETUP" menu displayed (See 8.9)

Actions

Select "DATE".   



Display of the page for entering the date and the identifier:

PLEASE GIVE DATE AND TIME ALONG WITH YOUR IDENTIFICATION	
DATE : 8 4 92	
TIME : 10 37 23	
IDENTIFICATION : D2R2	
(D,H,S,I) ? █	
...	EXIT

Enter the values to be modified (See syntax below).  

Value to be modified	Syntax
Date (mandatory)	D [DD] [MM] [YY]
Time	H [HH] [mm] [ss]
User identification (mandatory)	I [identification]

Display of the new values in the page.

Return to the "S/W OPTIONS SETUP" menu".  

Example

Enter "D 21 5 92 H 16 12 25 I C6-3PO".  

Display of the new lines:

DATE : 21 5 92
TIME : 16 12 25
IDENTIFICATION : C6-3PO

REMARK *In the example above, the modification instructions are all on the same line, separated by spaces.*

8.9.6 Locking of the Customisation

Locking the customisation is the final step which enables the system to check consistency of the values entered, the option key and the identification of the person who made up the customisation grid.

Requirements

"S/W OPTIONS SETUP" menu displayed (See 8.9)

All the new data have been entered.

Actions

Select "LOCKING".

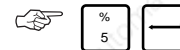

Display of the page for customisation locking:

PLEASE GIVE NUM IDENTIFICATION FOR YOUR KEY									
IDENTIFICATION : ABCD-EF									
?									
...									EXIT

Enter "[NUM identification]" (for example "CABE-EF").



Display of the page:

VALIDATION

and of the dialogue line:

READY ?|

Validate the customization.



Display of the message:

... PLEASE WAIT ...

then of the message:

AFFAIRE ALREADY CUSTOMISED!!

and of the dialogue line:

NEXT S/W OPTIONS SETUP? (Y/N)|

Confirm the customization.



Display of the message:

LOCKED SYSTEM

Return to the "S/W OPTIONS SETUP" menu".



Incidents

The user identification has not been entered

Display of the page for entering the date and the identifier (See 8.9.5).

Repeat the procedure for entering the date, the time and the identifier.

One customisation item does not agree

Display of message:

AT LEAST ONE ENTRY WAS WRONG

ENTER THE DATA AGAIN

Return to the "S/W OPTIONS SETUP" menu".



Repeat the data entry procedure (See 8.9.2 to 8.9.6).

8.9.7 Printout of Customisation

Select "PRINT OUT" to print the customisation.

Requirements

"S/W OPTIONS SETUP" menu displayed (See 8.9)

Customisation locked (See 8.9.6).

CNC connected to the printer (See C.2.4).

Printer ready to receive data (See printer manual).

CNC transmission baud rate (See 8.3) conforming to the printer reception baud rate.

Actions

Select "PRINT OUT".

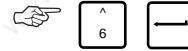

Display of the message:

DATA PRINT OUT

and of the dialogue line:

READY ?■

Confirm printout.



Data printout.

Return to the "S/W OPTIONS SETUP" menu.



Incidents

Customisation is not locked

Display of the message:

VALIDATE MODIFICATION BEFORE PRINTINGz

Return to the "S/W OPTIONS SETUP" menu.



Lock the customisation (See 8.9.6).

Appendix A Function Summary Tables

A.1 ISO Programming Syntax		A - 3
	A.1.1 G Function Summary Table	A - 3
	A.1.2 M Function Summary Table	A - 14
	A.1.3 Additional Function Summary Table	A - 18
A.2 Parametric Programming Syntax		A - 19
	A.2.1 Programme L Variables	A - 20
	A.2.2 External Parameters E	A - 21
	A.2.2.1 Parameters in the PLC Memory	A - 21
	A.2.2.2 Parameters in the NC Memory	A - 21
A.3 Profile Geometry Programming (PGP) Syntax		A - 26

A.1 ISO Programming Syntax

A programme written in ISO language is composed of blocks with the following format:



- 5 4 3 2 1
- 1 - Auxiliary functions
 - 2 - Miscellaneous functions
 - 3 - Dimension words
 - 4 - Preparatory functions
 - 5 - Block number

The tables below summarise the functions used in ISO programming.

A.1.1 G Function Summary Table

The functions initialised at power on are identified by "*"

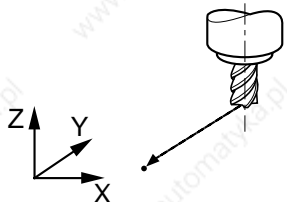
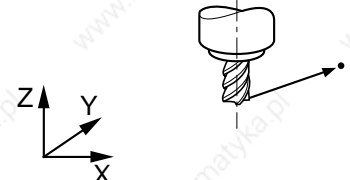
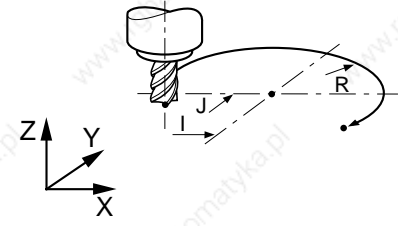
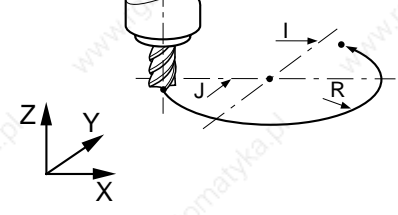
<p>G00: Linear interpolation at high speed</p> <p>Syntax: N.. [G90/G91] G00 [R±] X.. Y.. Z..</p> <p>Cancellation: G01/G02/G03</p>	
<p>G01*: Linear interpolation at programmed feed rate</p> <p>Syntax: N.. [G90/G91] G01 [R±] X.. Y.. Z.. [F..]</p> <p>Cancellation: G00/G02/G03</p>	
<p>G02: Clockwise circular interpolation at programmed feed rate</p> <p>Syntax (XY plane): N.. [G17] [G90/G91] G02 X.. Y.. I.. J.. or R.. [F..]</p> <p>Cancellation: G00/G01/G03</p>	
<p>G03: Counterclockwise circular interpolation at programmed feed rate</p> <p>Syntax (XY plane): N.. [G17] [G90/G91] G03 X.. Y.. I.. J.. or R.. [F..]</p> <p>Cancellation: G00/G01/G02</p>	

A

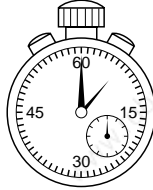
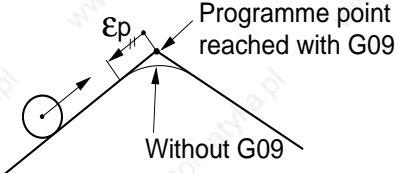
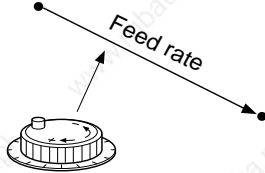
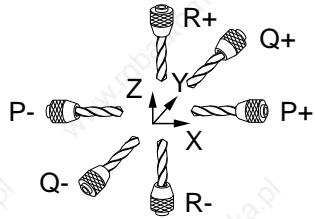
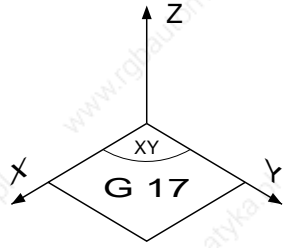
<p>G04: Programmable dwell</p> <p>Syntax: N.. G04 F..</p> <p>Cancellation: end of block</p>	
<p>G06: Spline curve execution order</p> <p>Syntax: N.. G06 NC..</p> <p>Cancellation: end of block</p>	
<p>G09: Accurate stop at end of block before sequencing to next block</p> <p>Syntax: N.. G09 [G00/G01/G02/G03] X.. Y.. Z.. [F..]</p> <p>Cancellation: end of block</p>	
<p>G10: Interruptible block</p> <p>Syntax: N.. [G40] [G04] [G00/G01/G02/G03] X.. Y.. Z.. G10 [:n] [+X.. or F..] [@n < > Value] N.. [+ Number] [EF..]</p> <p>Cancellation: end of block</p>	
<p>G12: Rapid feed by handwheel</p> <p>Syntax: N.. [G01/G02/G03] G12 X.. Y.. Z.. [F..] [\$0...]</p> <p>Cancellation: end of block</p>	
<p>G16*: Definition of the tool axis orientation with addresses P, Q, R</p> <p>Syntax: N.. G16 P±/Q±/R±</p> <p>Cancellation: G16 P±/Q±/R±</p>	
<p>G17*: XY plane selection</p> <p>Syntax: N.. G17</p> <p>Cancellation: G18/G19</p>	

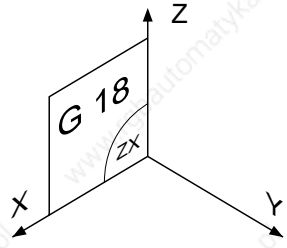
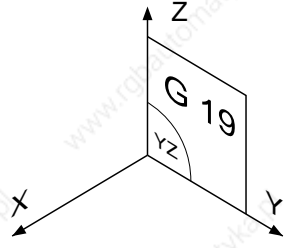
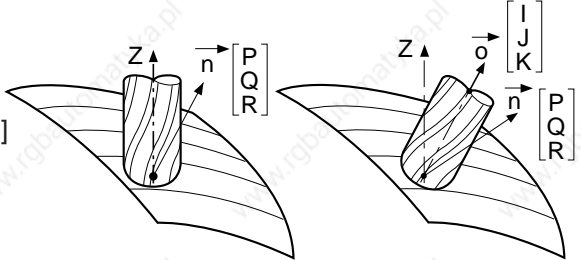
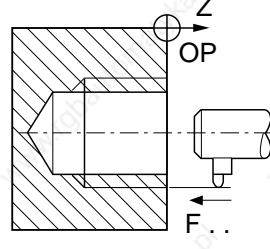
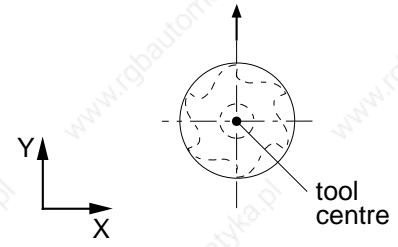
<p>G18: ZX plane selection</p> <p>Syntax: N.. G18</p> <p>Cancellation: G17/G19</p>	
<p>G19: YZ plane selection</p> <p>Syntax: N.. G19</p> <p>Cancellation: G17/G18</p>	
<p>G23: Circular interpolation defined by three points</p> <p>Syntax (XY plane): N.. [G17] [G90/G91] G23 X.. Y.. I.. J.. [F..]</p> <p>Cancellation: end of block</p>	
<p>G29: 3D tool correction with toroidal or spherical tool</p> <p>Syntax: N.. [D..] [G01] G29 X.. Y.. Z.. P.. Q.. R.. [I.. J.. K..] [A.. /B.. /C..]</p> <p>Cancellation: G40/G41/G42</p>	
<p>G31: Thread chasing cycle</p> <p>Syntax: N.. [G17] [M03/M04] [S..] G31 [X.. Y..] Z.. [ER..] [EH..] K.. P.. [F..] [EF..] [EC..]</p> <p>Cancellation: G80-G89</p>	
<p>G40*: Tool compensation cancel</p> <p>Syntax: N.. [G00/G01] G40 X.. Y.. Z..</p> <p>Cancellation: G29/G41/G42</p>	

A

G41: Cutter compensation to the Left

Syntax (XY plane): N.. [G17] [D..] [G00/G01/G02/G03] **G41** X.. Y..

Cancellation: G29/G40/G42

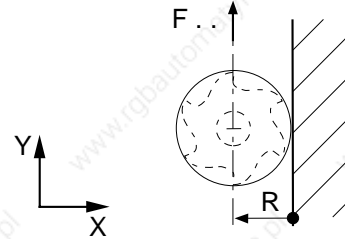

G42: Cutter compensation to the Right

Syntax (XY plane): N.. [G17] [D..] [G00/G01/G02/G03] **G42** X.. Y..

Cancellation: G29/G40/G41

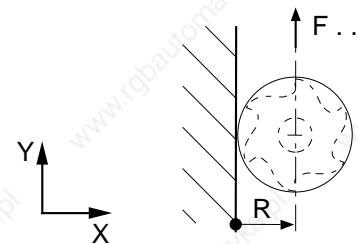

G43: 3D tool correction with cylindrical tool

Syntax:

N.. [D..] [G01] **G43** X.. Y.. Z.. P.. Q.. R.. [I.. J.. K..] [A.. /B.. /C..]

Cancellation: G40/G41/G42

G45: Simple pocket cycle

Syntax:

N.. **G45** X.. Y.. Z.. [ER..] EX.. EY.. [EB..] P.. Q.. [I..] [J..]
[EG2/EG3] EP.. EQ.. EI.. EJ..

Cancellation: end of block

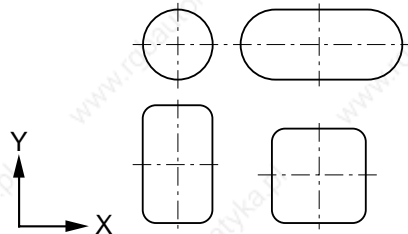

G46 NU..: Pocket and facing cycle with any contours

The syntax specific to each cycle is described below (syntax defined in the XY plane)

Cancellation G46: end of block

G46 NU0: Geometric definition header block

N.. **G46 NU0** NP.. ED.. Q.. [J..] [NR±] [R03/R04] [LX.. LY..] [EX.. EY..]

G46 NU1: Pocket introduction block

N.. **G46 NU1** [LX.. LY..]

N.. Pocket contour definition

G46 NU2: Island introduction block

N.. **G46 NU2** [LX.. LY..]

N.. Island contour definition

<p>G46 NU3: Facing introduction block</p> <p>N.. G46 NU3 N.. Facing contour definition</p>
<p>G46 NU4: Cavity introduction block</p> <p>N.. G46 NU4 N.. Cavity contour definition</p>
<p>G46 NU5 and G46 NU6: Facing and wall introduction blocks</p> <p>N.. G46 NU5 N.. Facing contour definition</p> <p>N.. G46 NU6 N.. Wall contour definition</p>
<p>G46 NU9: Geometric definition end block</p> <p>N.. G46 NU9</p>
<p>G46 NU10: Initial drilling orders</p> <p>N.. G46 NU10 NP.. G81 Z.. [ER..] [F..]</p> <p>N.. G46 NU10 NP.. G83 Z.. P.. [Q..] [ER..] [EF..] [F..]</p> <p>N.. G46 NU10 NP.. G87 Z.. P.. [Q..] [ER..] [EF..] [F..]</p>
<p>G46 NU15: Roughing order</p> <p>N.. G46 NU15 NP.. Z.. P.. [ER..] [EH..] [EP..] [EQ..]</p>
<p>G46 NU20: Finishing and semi-finishing orders</p> <p>N.. G46 NU20 NP.. Z.. P.. [ER..] [EH..] [EI..] [EJ..] [J..]</p>
<p>G48: Spline curve definition</p> <p>Syntax: N.. G48 NC.. H../N.. N..</p> <p>Cancellation: end of block</p>
<p>G49: Spline curve deletion</p> <p>Syntax: N.. G49 NC..</p> <p>Cancellation: end of block</p>
<p>G51: Mirror function</p> <p>Syntax: N.. G51 X- Y- Z-</p> <p>Cancellation of G51 X- Y- Z- by G51 X+ Y+ Z+</p>

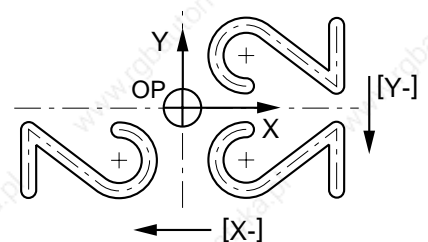

A

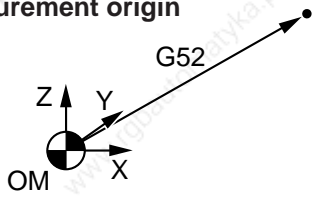
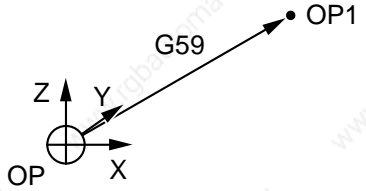
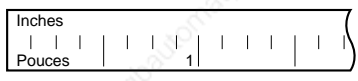
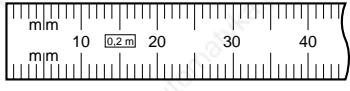
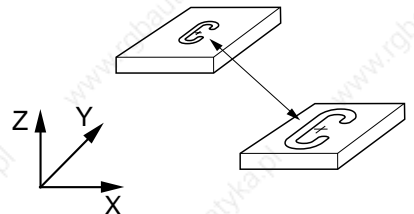
<p>G52: Programming in absolute dimensions with reference to the measurement origin</p> <p>Syntax: N.. [G40] [G90] [G00/G01] G52 X.. Y.. Z.. A.. B.. C.. [F..]</p> <p>Cancellation: end of block</p>	
<p>G53: Cancellation of shifts DAT1 and DAT2</p> <p>Syntax: N.. G53</p> <p>Cancellation: G54</p>	
<p>G54*: Enabling of shifts DAT1 and DAT2</p> <p>Syntax: N.. G54</p> <p>Cancellation: G53</p>	
<p>G59: Programme origin shift</p> <p>Syntax: N.. [G90/G91] G59 X.. Y.. Z.. U.. V.. W.. A.. B.. C.. [I.. J.. K.. ED..]</p> <p>Cancellation: cancellation by G59 different X.. Y.. Z..</p>	
<p>G70: Inch data input</p> <p>Syntax: N.. G70</p> <p>Cancellation: G71</p>	
<p>G71: Metric data input</p> <p>Syntax: N.. G71</p> <p>Cancellation: G70</p>	
<p>G73*: Scaling factor cancel</p> <p>Syntax: N.. [G40] G73</p> <p>Cancellation: G74</p>	
<p>G74: Scaling factor enable</p> <p>Syntax: N.. [G40] G74</p> <p>Cancellation: G73</p>	

<p>G75: Emergency retraction subroutine declaration</p> <p>Syntax: N.. G75 N..</p> <p>Cancellation: cancellation by G75 N0 or G75 different N..</p>
<p>G76: Transfer of the current values of "L" and "E" parameters into the part programme</p> <p>Syntax: N.. G76 [H..] [N.. N..]</p> <p>Cancellation: end of block</p>
<p>G76 +/-: Programme or ISO block creation/deletion</p> <p>Syntax: See special syntax below.</p> <p>Cancellation: end of block</p>
<p>G76+: Programme creation</p> <p>Syntax: N.. G76+ H..</p>
<p>G76-: Programme deletion</p> <p>Syntax: N.. G76- [H..][N.. N..]</p>
<p>G76+: ISO block creation</p> <p>Syntax: N.. G76+ [H..] N.. [+ number] ISO block</p>
<p>G76-: ISO block deletion</p> <p>Syntax: N.. G76- [H..] N.. [+ number]</p>
<p>G77: Unconditional branch to a subroutine or sequence of blocks with return</p> <p>Syntax: N.. G77 [H..] [N.. N..] [S..]</p> <p>Cancellation: end of block</p> <div style="text-align: right;"> </div>
<p>G77-i: Call of subroutine return block</p> <p>Syntax: N.. G77 -i</p> <p>Cancellation: end of block</p>
<p>G78: Axis group synchronisation</p> <p>Syntax: N.. G78 Q../Pj.i</p> <p>Cancellation: cancellation by G78 Q0 or G78 different Q..</p>

A

G79: Conditional or unconditional jump to a sequence without return

Syntax: N.. **G79** [L../E.. > = < Number] N..

Cancellation: end of block

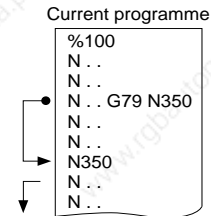

G79+/-: Temporary suspension of next block preparation in a sequence with movement

Syntax (XY plane): N.. [G00/G01/G02/G03] X.. Y.. Z.. **G79 +/-** X.. / F..

Cancellation: end of block

G80*: Machining cycle cancel

Syntax: N.. **G80**

Cancellation: G31/G81-G89

G81: Centre drilling cycle

Syntax (XY plane): N.. [G17] **G81** [X.. Y..] Z.. [ER..] [EH..] [F..]

Cancellation: G31/G80/G82-G89

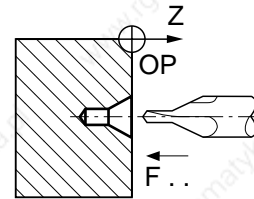

G82: Counterboring cycle

Syntax (XY plane): N.. [G17] **G82** [X.. Y..] Z.. [ER..] [EH..] EF.. [F..]

Cancellation: G31/G80/G81/G83-G89

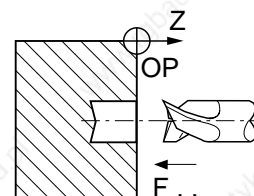

G83: Peck drilling cycle

Syntax (XY plane):
N.. [G17] **G83** [X.. Y..] Z.. [ER..] [EH..] [Q..] [P..]/[ES..] [EP..] [F..] [EF..]

Cancellation: G31/G80-G82, G84-G89

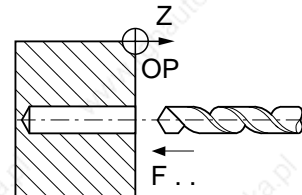

G84: Tapping cycle

Syntax (XY plane): N.. [G17] **G84** [X.. Y..] Z.. [ER..] [EH..] EF.. [F..]

Cancellation: G31/G80-G83, G85-G89

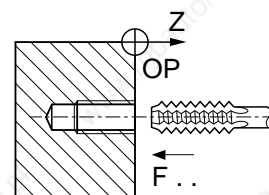

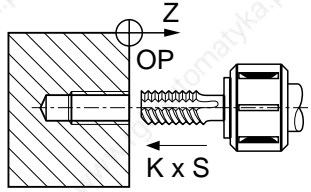
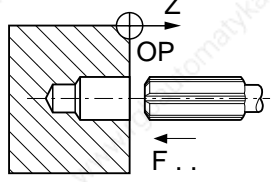
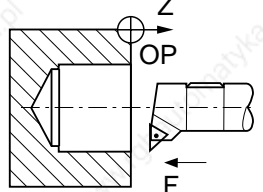
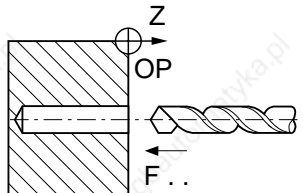
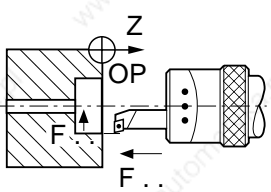
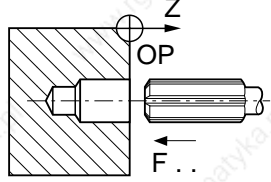
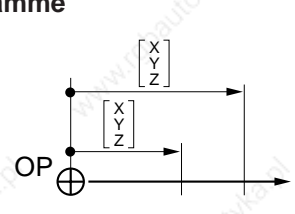
<p>G84: Rigid tapping cycle</p> <p>Syntax (XY plane): N.. [G17] [M03/M04] [M40-M45] G84 [X.. Y..] Z.. [ER..] [EH..] K.. [EK..]</p> <p>Cancellation: G31/G80-G83, G85-G89</p>	
<p>G85: Boring cycle</p> <p>Syntax (XY plane): N.. [G17] G85 [X.. Y..] Z.. [ER..] [EH..] [F..] [EF..]</p> <p>Cancellation: G31/G80/G81-G84, G86-G89</p>	
<p>G86: Boring cycle with indexed spindle dwell in hole bottom</p> <p>Syntax (XY plane): N.. [G17] G86 [X.. Y..] Z.. [ER..] [EH..] [EC..] [EA..] [EP..] [F..]</p> <p>Cancellation: G31/G80-G85, G87-G89</p>	
<p>G87: Drilling cycle with chip breaking</p> <p>Syntax (XY plane): N.. [G17] G87 [X.. Y..] Z.. [ER..] [EH..] [Q..][P..][ES..] [EP..] EF.. [F..]</p> <p>Cancellation: G31/G80-G86, G88/G89</p>	
<p>G88: Boring and facing cycle</p> <p>Syntax (XY plane): N.. [G17] G88 [X.. Y..] Z.. [ER..] [EH..] [F..]</p> <p>Cancellation: G31/G80-G87/G89</p>	
<p>G89: Boring cycle with dwell in the bottom of the hole</p> <p>Syntax (XY plane): N.. [G17] G89 [X.. Y..] Z.. [ER..] [EH..] [EF..] [F..]</p> <p>Cancellation: G31/G80-G88</p>	
<p>G90*: Programming in absolute dimensions with respect to the programme origin</p> <p>Syntax: N.. G90 X.. Y.. Z.. A.. B.. C..</p> <p>Cancellation: G91</p>	

A

G91: Programming in incremental dimensions with respect to the start of the block

Syntax: N.. G91 X.. Y.. Z.. A.. B.. C..

Cancellation: G90

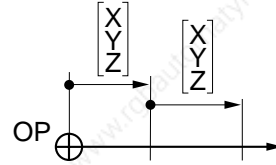

G92 X.. Y.. Z..: Programme origin preset

Syntax: N.. G92 X.. Y.. Z..

Cancellation: end of block

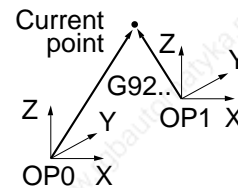

G92 R..: Programming of the tangential feed rate

Syntax: N.. G92 R..

Cancellation: by G92 R0 or G92 different R..

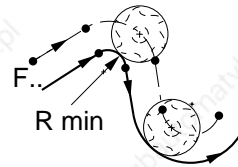

G93: Feed rate expressed as inverse time (V/D)

Syntax: N.. G93 F.. G01 X.. Y.. Z.. A.. B.. C..

Cancellation: G94/G95

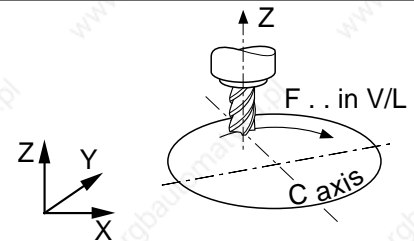

G94*: Feed rate expressed in millimetres, inches or degrees per minute

Syntax: N.. G94 F.. G01/G02/G03 X.. Y.. Z.. A.. B.. C..

Cancellation: G93/G95

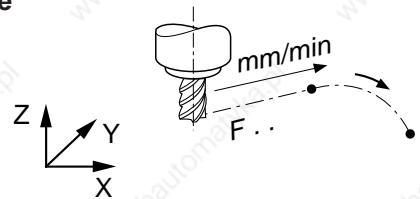

G95: Feed rate expressed in millimetres or inches per revolution

Syntax: N.. G95 F.. G01/G02/G03 X.. Y.. Z..

Cancellation: G93/G94

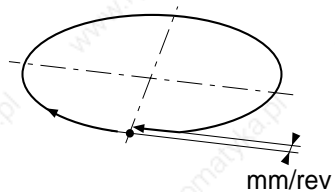

G97*: Spindle speed expressed in revolutions per minute

Syntax: N.. G97 S.. [M03/M04]

Cancellation: G96 (combined machine)

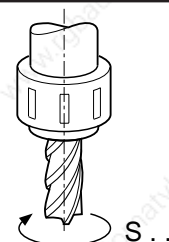

<p>G104: 3D curve smoothing</p> <p>General syntax: N.. X.. Y.. Z.. (first point on the curve) N.. [G01] G104 X.. Y.. Z.. [F..] [intermediate points on the curve] N.. G80 X.. Y.. Z.. (last point on the curve)</p> <p>Cancellation: G80</p>
<p>G997: Enabling and execution of all the functions stored in state G999</p> <p>Syntax: N.. G997</p> <p>Cancellation: G998/G999</p>
<p>G998: Enabling of block execution and part of the functions processed in state G999</p> <p>Syntax: N.. G998</p> <p>Cancellation: G997/G999</p>
<p>G999: Suspension of execution and forced block concatenation</p> <p>Syntax: N.. G999</p> <p>Cancellation: G997/G998</p>

A.1.2 M Function Summary Table

The functions initialised at power on are identified by "*"

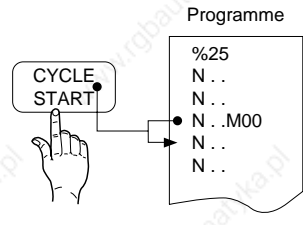
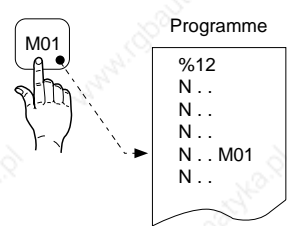
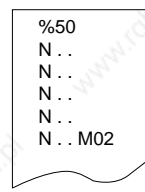
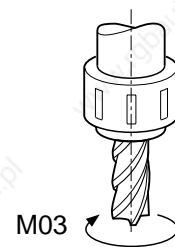
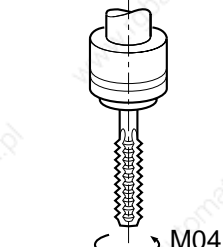
<p>M00: Programme stop</p> <p>Syntax: N.. [G40] M00 [\$0 ...]</p> <p>Cancellation: action on the machine panel "CYCLE" button</p>	
<p>M01: Optional stop</p> <p>Syntax: N.. [G40] M01 [\$0 ...]</p> <p>Cancellation: action on the machine panel "CYCLE" button</p>	
<p>M02: End of programme</p> <p>Syntax: N.. M02</p>	
<p>M03: Clockwise spindle rotation</p> <p>Syntax: N.. M03</p> <p>Cancellation: M04/M05/M00/M19</p>	
<p>M04: Counterclockwise spindle rotation</p> <p>Syntax: N.. M04</p> <p>Cancellation: M03/M05/M00/M19</p>	
<p>M05*: Spindle stop</p> <p>Syntax: N.. M05</p> <p>Cancellation: M03/M04</p>	

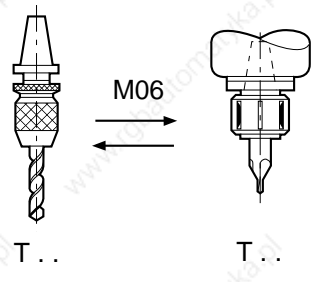
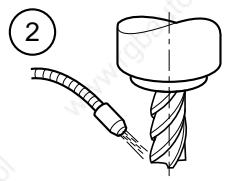
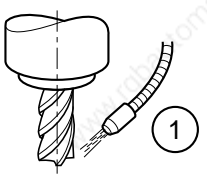
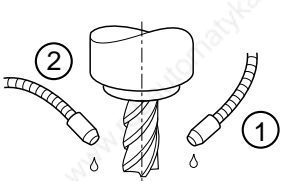
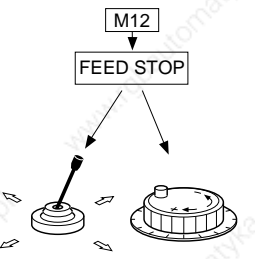
<p>M06: Tool change</p> <p>Syntax: N.. T.. [D..] M06 [\$0.. / (...)]</p> <p>Cancellation: M function report (CRM)</p>	 <p>The diagram shows two tool holders, both labeled 'T..'. A double-headed arrow between them is labeled 'M06', indicating the tool change function.</p>
<p>M07: Coolant 2 on</p> <p>Syntax: N.. M07</p> <p>Cancellation: M09</p>	 <p>The diagram shows a drill bit with a coolant nozzle (labeled '2') spraying coolant onto the cutting edge.</p>
<p>M08: Coolant 1 on</p> <p>Syntax: N.. M08</p> <p>Cancellation: M09</p>	 <p>The diagram shows a drill bit with a coolant nozzle (labeled '1') spraying coolant onto the cutting edge.</p>
<p>M09*: Coolant off</p> <p>Syntax: N.. M09</p> <p>Cancellation: M07/M08</p>	 <p>The diagram shows a drill bit with two coolant nozzles (labeled '1' and '2') spraying coolant onto the cutting edge.</p>
<p>M10: Clamp</p> <p>Syntax: N.. [G00/G01/ G02/ G03] M10 X.. Y.. Z.. A.. B.. C..</p> <p>Cancellation: M11</p>	
<p>M11: Unclamp</p> <p>Syntax: N.. M11</p> <p>Cancellation: M10</p>	
<p>M12: Programmed feed stop</p> <p>Syntax: N.. M12 [\$0...]</p> <p>Cancellation: action on the machine panel "CYCLE" button</p>	 <p>The diagram shows a box labeled 'M12' with an arrow pointing to a box labeled 'FEED STOP'. Below this, two arrows point to illustrations of a drill bit cutting into a workpiece, representing the feed stop action.</p>

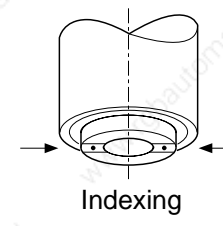
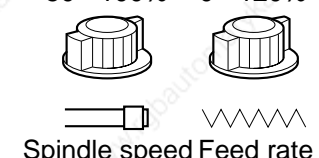
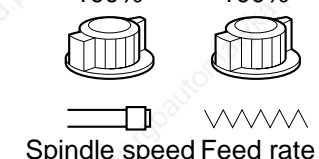
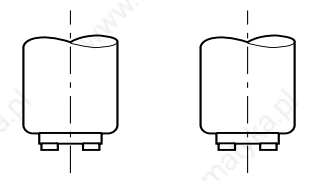
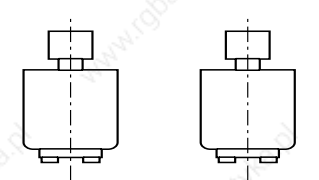
<p>M19: Spindle index</p> <p>Syntax: N.. [G97 S..] [M40-M45] [M03/M04] C±.. M19</p> <p>Cancellation: M03/M04/M05</p>	
<p>M40-M45: Spindle speed ranges</p> <p>Syntax: N.. [G97 S..] [M03/M04] M40-M45</p> <p>Cancellation: Cancellation mutuelle</p>	
<p>M48*: Enable overrides</p> <p>Syntax: N.. M48</p> <p>Cancellation: M49</p>	<p>50 - 100% 0 - 120%</p>  <p>Spindle speed Feed rate</p>
<p>M49: Disable overrides</p> <p>Syntax: N.. M49</p> <p>Cancellation: M48</p>	<p>100% 100%</p>  <p>Spindle speed Feed rate</p>
<p>M61: Release of current spindle from axis group</p> <p>Syntax: N.. M61</p> <p>Cancellation: M62 to M65</p>	
<p>M64*, M65, M62, M63: Control of spindles 1 to 4</p> <p>Syntax: N.. [G97 S..] M62/M63/M64/M65 [M40-M45] M03/M04</p> <p>Cancellation: cancel one another</p>	
<p>M66*, M67, M68, M69: Measurement of spindles 1 to 4</p> <p>Syntax: N.. M66/M67/M68/M69</p> <p>Cancellation: cancel one another</p>	

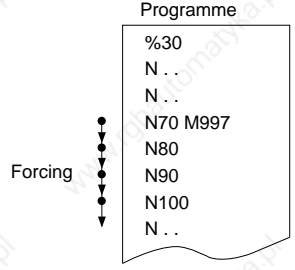
<p>M997: Forced block sequencing</p> <p>Syntax: N.. M997</p> <p>Cancellation: M998/M999/M02</p>	
<p>M998*: Re-enabling of EDIT and MDI modes and subroutine calls by the PLC</p> <p>Syntax: N.. M998</p> <p>Cancellation: M997/M999</p>	
<p>M999: Programmed cancellation of EDIT and MDI modes and subroutine calls by the PLC</p> <p>Syntax: N.. M999</p> <p>Cancellation: M997/M998/M02</p>	

A.1.3 Additional Function Summary Table

<p>ED: Programmed angular shift</p> <p>Syntax: N.. ED..</p> <p>Cancellation: ED0 or different ED...</p>
<p>EG: Programmed acceleration modulation</p> <p>Syntax: N.. EG..</p> <p>Cancellation: Different EG....</p>
<p>EM+/-: Outside dimensions of the part in 3D graphic display</p> <p>Syntax: N.. EM+ X.. Y.. Z.. EM- X.. Y.. Z..</p>
<p>F: Feed rate, dwell, number of thread starts</p> <p>Syntax: N.. G93 F.. (feed rate in V/L). N.. G94 F.. (feed rate in mm/min degrees/min or inch/min) N.. G95 F.. (feed rate in mm/rev or inch/rev) N.. G04 F.. (dwell in seconds) N.. G31 F.. (number of thread starts)</p> <p>Cancellation: different F.. in G93, G94 and G95; end of block in G04 and G31</p>
<p>S: Spindle RPM, number of subroutine repeats</p> <p>Syntax: N.. G97 S.. (spindle speed in RPM, see Sec. 4.3.2) N.. G77 [H..] [N.. N..] S.. (subroutine call and repeats)</p> <p>Cancellation: S0 or different S..</p>
<p>T: Tool number</p> <p>Syntax: N.. T.. M06 (tool change)</p> <p>Cancellation: T0 or different T..</p>
<p>D: Correction number</p> <p>Syntax: N.. D.. (call of correction)</p> <p>Cancellation: D0 or different D..</p>

A.2 Parametric Programming Syntax

Parametric programming uses L and E programme variables to:

- store the results of numerical calculations,
- perform conditional branches,
- replace a numerical value.

Storing the result of a calculation into a variable

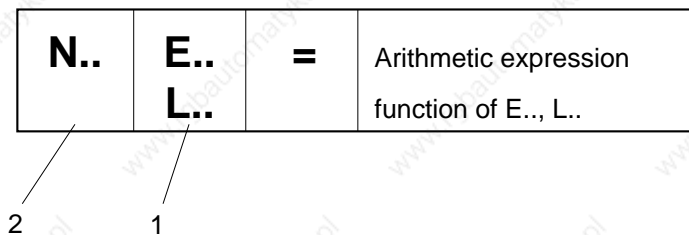

- 1 - Variable where the calculation result is stored
- 2 - Block number

Conditional branch

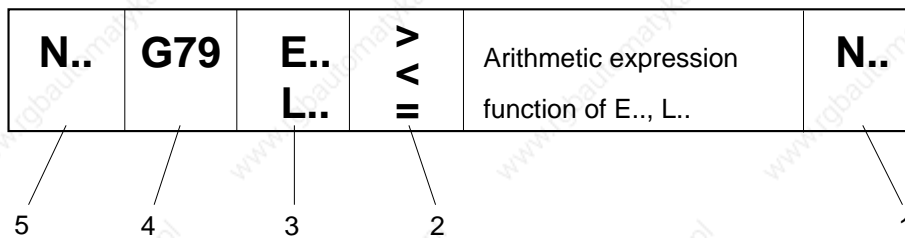

- 1 - Branch destination block number if comparison is true
- 2 - Comparison symbol
- 3 - Variable compared to result of arithmetic expression
- 4 - Branch function
- 5 - Block number

Replacement of a numerical value by a variable

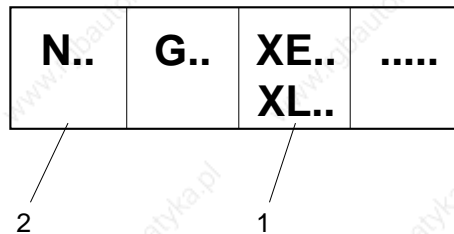

- 1 - Dimension word where the numerical value is replaced by a variable
- 2 - Block number

Les tableaux ci-après fournissent un récapitulatif des variables L et des paramètres E.

A.2.1 Programme L Variables

The programme variables are reset when the system is switched on or when the machine returns to M02 state.

The values of the programme variables can be defined with up to eight digits plus sign and decimal point.

L0 to L19	No restrictions in programming
L100 to L199 L900 to L959	Loading these variables suspends preparation of the block to which they belong until the end of execution of the previous block. Therefore, they cannot be used in a sequence where the next blocks have to be known (e.g. in profile geometry programming)

A.2.2 External Parameters E

Parameters E are accessible for read only or for read/write by the part programme.

A.2.2.1 Parameters in the PLC Memory

Parameters	Description	Value or units	Access by the part programme
E10000 to E10031	1-bit words	0 or 1	Read/write
E20000 to E20031	1-bit words	0 or 1	Read only
E20100 to E20103	State of machine inputs on machine processor interrupt (IT)	0 or 1	Read only
E20104 to E20107	State of machine inputs on interrupt (IT) from a first IT/serial line card	0 or 1	Read only
E20108 to E20111	State of machine inputs on interrupt (IT) from a second IT/serial line card	0 or 1	Read only
E30000 to E30127	Long words (4 bytes)	- 99999999 à 99999999	Read/write
E40000 to E40127	Long words (4 bytes)	- 99999999 to 99999999	Read only
E42000 to E42127	Bytes	0 or 1	Read only

A.2.2.2 Parameters in the NC Memory

Parameters	Description	Value or units	Access by the part programme
E11000	Angular shift (ED) enabled	0 or 1	Read/write (+ graphic)
E11001	Programme origin shift (G59) enabled	0 or 1	Read/write (+ graphic)
E11003	Mirror function (G51) enabled	0 or 1	Read/write (+ graphic)
E11005	Programming by diameter enabled	0 or 1	Read/write (+ graphic)
E11006	Tool centre programming	0 or 1	Read/write (+ graphic)
E11007	Spindle potentiometer enabled	0 or 1	Read/write (+ graphic)
E11008	Execution of a complete circle	0 or 1	Read/write (+ graphic)
E11009	Execution or not of a complete revolution on a modulo axis	0 or 1	Read/write (+ graphic)
E11012	Cancellation of following error	0 or 1	Read/write
E11013	Gradual acceleration	0 or 1	Read/write
E11014	Addressing of the deceleration function on several blocks	0 or 1	Read/write
E11015	Angle crossing management enabled	0 or 1	Read/write (+ graphic)
E11016	Front or rear turret (turning)	0 or 1	Read/write

A

Parameters	Description	Value or units	Access by the part programme
E11017	Inclined plane function enabled	0 or 1	Read only
E11018	RTCP function enabled	0 or 1	Read only
E21000 to E21255	Presence of functions 0 to 255	0 or 1	Read only
E31000	Line type for G0 in graphic display	0 to 4	Read/write (+ graphic))
E31001	Line type for G01, G02 and G03 in graphic display	0 to 4	Read/write (+ graphic)
E32000	Minimum execution time of an interpolation block	ms	Read/write
E32001	Overspeed coefficient on path in G12	1 / 1024	Read/write
E32002	Servo-control error tolerated on a circle	µm	Read/write
E32003	Angle crossing speed analysis angle	1/10000 degree	Read/write
E32004	Chordal error	µm	Read/write
E32005	Number of terms of the total speed anticipation filter	1 to 14	Read/write
E33xyz	PLC output addressing	x = 0 to 6 y = 0 to 9 z = 0 to 9	Read/write
E34xxy	8I/8O analogue card analogue output addressing	xx = 0 to 13 y = 0 to 7	Write only
E41000	Current mode number	0 to 15	Read only
E41001	Current axis group number	0 to number of groups	Read only
E41002	Number of groups in the machine	1 to 8	Read only
E41003	State of graphic machining simulation	0 to 2	Read only
E41004	Job number image	0 to 99999999	Read only
E41005	Sampling period	ms	Read only
E41006	Axis group position loop time constant	ms	Read only
E41102	Number of CNC axis groups	0 to 7	Read only
E43xyz	PLC input terminal addressing	x = 0 to 6 y = 0 to 9 z = 0 to 9	Read/write
E44xxy	8I/8O analogue card analogue input addressing	xx = 0 to 13 y = 0 to 9	Read only
E49001 to E49128	Operation number read (dynamic operators)	1 to 128	Read only
E50000	Current tool offset number	0 to 255	Read only
E50001 to E50255	Tool length	internal unit	Read/write
E51000	Current tool orientation	0 to 2 or 100 to 102	Read only
E51001 to E51255	Cutter tip radius	internal unit	Read/write
E52001 to E52255	Tool radius	internal unit	Read/write
E53001 to E53255	Tool length wear offset	internal unit	Read/write
E54001 to E54255	Tool radius wear offset	internal unit	Read/write
E55001 to E55255	Tool tip orientation (turning)	0 to 8	Read/write

Parameters	Description	Value or units	Access by the part programme
E56001 to E56255	Available parameters (H of the wear offset table)	- 99999999 to 99999999	Read/write
E57001 to E57255	Tool type	0 to 2	Read/write
E6x000 x = axis number (0-8)	DAT1	internal unit	Read/write (+ graphic)
E6x001 x = axis number (0-8)	DAT2	internal unit	Read/write (+ graphic)
E6x002 x = axis number (0-8)	Minimum dynamic travel	internal unit	Read/write (+ graphic)
E6x003 x = axis number (0-8)	Maximum dynamic travel	internal unit	Read/write (+ graphic)
E6x004 x = axis number (0-5)	DAT3 (limited to linear axes)	internal unit	Read/write (+ graphic)
E6x005 x = axis number (0-8)	Shift programmed by G59	internal unit	Read/write (+ graphic)
E69000	Scaling factor	1/1000	Read/write (+ graphic)
E69001	Axis inclination on grinding machine (turning)	1/10000 degree	Read/write (+ graphic)
E69002	Wheel inclined on grinding machine (turning)	1/10000 degree	Read/write (+ graphic)
E69003	Axis assignment	XYZ axis assignment	Read/write (+ graphic)
E7x000 x = axis number (0-8)	Position reference	internal unit or 1/10000 degree	Read only
E7x001 x = axis number (0-8)	Reference on on-the-fly dimension measurement	internal unit or 1/10000 degree	Read/write
E7x002 x = axis number (0-8)	Minimum static travel	internal unit or 1/10000 degree	Read only
E7x003 x = axis number (0-8)	Maximum static travel	internal unit or 1/10000 degree	Read only
E7x004 x = axis number (0-8)	Direction of movement	internal unit or 1/10000 degree	Read only
E7x005 x = axis number (0-8)	Axis address assignment	-1 to 31	Read/write
E7x006 x = axis number (0-8)	Carried axis	0 or 1	Read/write (+ graphic)
E7x007 x = axis number (0-8)	Axes programmed by diameter	0 or 1	Read only
E7x100 x = axis number (0-8)	Interpolator position reference	internal unit	Read only
E7x101 x = axis number (0-8)	Interpolation speed limiting	0 to 100	Read/write

A

Parameters	Description	Value or units	Access by the part programme
E79000	Position reference of the measured spindle in the group	0 à 3599999 1/10000 degree	Read only
E79001	Group spindle setting	1 / 2 ¹⁵ of the maximum speed	Read only
E79002	Feed rate potentiometer value	1 / 128	Read only
E79003	Distance remaining to be travelled	internal unit	Read/write
E79004	Current speed in path	internal unit	Read only
E79005	Minimum group feed rate potentiometer value	% 0 to 255	Read/write
E79006	Minimum group feed rate potentiometer value	% 0 to 255	Read/write
E79007	Minimum group feed rate potentiometer value	% 0 to 255	Read/write
E79008	Minimum group feed rate potentiometer value	% 0 to 255	Read/write
E80000 to E80050	Local data	- 99999999 to 99999999	Read/write
E81000 to E81999	Master axis reference positions	internal unit	Read/write
E82000 to E82999	Slave axis corrections	internal unit	Read/write
E90000 to E90031	Axis measurement	internal unit	Read/write
E901000 to E90103	Spindle x position reference	0 to 3599999 1/10000 degree	Read only
E90110 to E90113	Spindle modulo	depending on spindle sensor	Read only
E90200 to E90203	Spindle speed setting	1 / 2 ¹⁵ of the maximum speed	Read only
E90300 to E90303	Maximum spindle indexing speed	rev/min	Read/write
E90310 to E90313	Spindle indexing in-position window	internal unit	Read/write
E90320 to E90323	Spindle indexing gain	(rev/min)/rev	Read/write
E90330 to E90333	Spindle indexing acceleration	rev/s ²	Read/write
E90340 to E90343	Threshold at which spindle is considered stopped	rpm	Read/write
E90350 to E90353	Tolerance interval coefficient	1/256	Read/write
E91000 to E91031	Servo-controlled axis (or spindle)	0 or 1	Read/write
E91100 to E91131	Homing completed or not on the axis (or spindle)	0 or 1	Read/write
E91200 to E91231	AUTO N/M axes (milling)	0 or 1	Read/write
E91300 to E91331	Enable status of clampable axes	0 or 1	Read/write
E92000 to E92031	Enable status of axis origin switches	0 or 1	Read/write
E93000 to E93031	Axis origin switch status	0 or 1	Read only
E93100 to E93131	Measured axis	0 or 1	Read only
E93200 to E93231	Axis declared rotary modulo 360 degrees	0 or 1	Read only

Parameters	Description	Value or units	Access by the part programme
E93300 to E93331	Axis homing direction	0 or 1	Read only
E93400 to E93431	Homing status of the axis without switch wiring	0 or 1	Read only
E93500 to E93531	Axis or spindle in position	0 or 1	Read only
E93600 to E93631	Type of measurement encoder	0 or 4	Read only
E94000 to E94031	Assignment of a master axis (or spindle) to a slave axis (or spindle)	-1 to 31	Read/write
E94100 to E94131	Association of a slave axis (or spindle) with a master axis (or spindle)	-1 to 31	Read/write
E94200 to E94231	Axis/spindle switching	-1 to 31	Read/write
E95000 to E95031	Axis reference offset	internal unit	Read only
E95100 to E95131	Axis origin switch position with respect to the machine zero point	internal unit	Read only
E95200 to E95231	Axis (or spindle) measurement correction	internal unit	Read only
E96000 to E96031	Duplicated axis in automatic mode	0 or 1	Read/write
E96100 to E96131	Duplicated axis in manual mode (JOG)	0 or 1	Read/write
E96200 to E96231	Synchronised axis	0 or 1	Read/write
E96300 to E96331	Axis driven in symmetry	0 or 1	Read/write
E97000 to E97031	Maximum axis speed	mm/min or degree / min	Read only
E97100 to E97131	Axis acceleration at work rate	mm/s ² or deg/s ²	Read only
E97200 to E97231	Axis acceleration at high speed	mm / s ² or deg / s ²	Read only
E97300 to E97331	Maximum angle crossing speed	mm / min	Read/write
E98000 to E98031	Axis servo-control coefficient	1/1000 mm or degree	Read/write
E98100 to E98131	Axis acceleration anticipation time constant	µs	Read/write
E98200 to E98231	Amplitude of antistick pulse	µm	Read/write
E98300 to E98331	Time constant for cancellation of antistick pulse	1/100 ms	Read/write

A

A.3 Profile Geometry Programming (PGP) Syntax

Profile geometry programming is used to programme profiles using simple geometric elements such as line segments and arcs without defining any connecting points between them.

Profile geometry programming

- uses ISO programming instructions plus its own special instructions,
- is only used in programming with absolute dimensions (G90),
- is used in one of the three planes defined by functions G17, G18 and G19 (the axes outside this plane can be programmed in ISO).

A profile definition sequence written in PGP:

- is comprised of blocks whose end points are calculated by the system in accordance with the elements in the previous blocks (two blocks maximum),
- ends by a block whose end point is completely defined.

The following table summarises the instructions used by profile geometry programming for sequences in the XY plane (G17).

To programme sequences in:

- the YZ plane (G18), replace X, Y, I and J by Y, Z, J and K,
- the ZX plane (G19), replace X, Y, I and J by Z, X, K and I.

The following symbols are used in the drawings in the table:

- point completely defined,
- point calculated by the system,
- point defined or calculated.

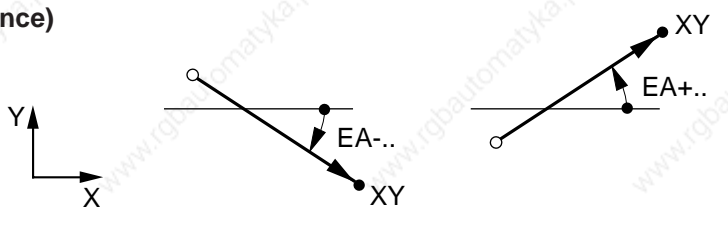
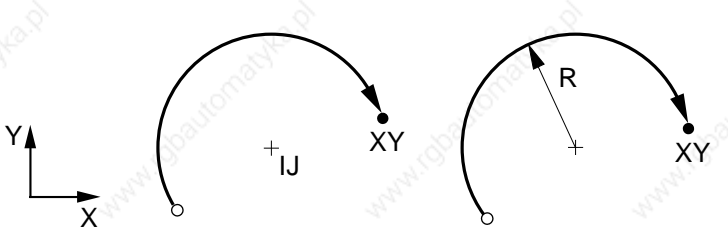
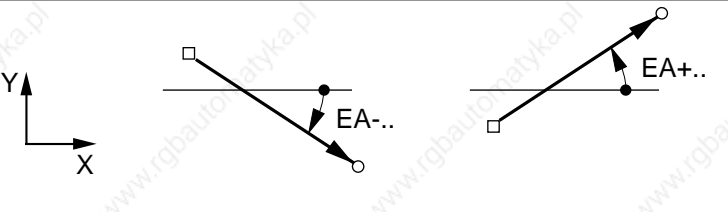
<p>End point of a line segment (end of PGP sequence)</p> <p>Syntax: N.. [G00/G01] EA.. X.. Y..</p>	
<p>End point of an arc (end of PGP sequence)</p> <p>Syntax: N.. [G02/G03] X.. Y.. (I.. J.. or R..)</p>	
<p>Line segment defined by an angle</p> <p>Syntax: N.. [G00/G01] EA..</p>	

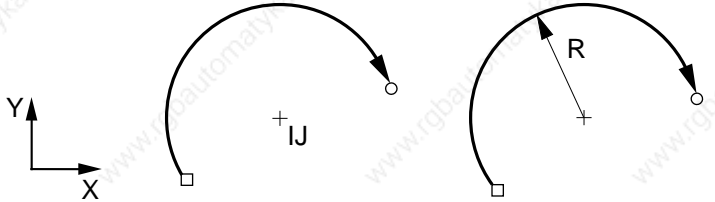
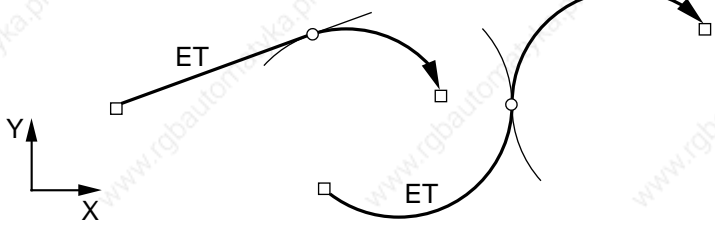
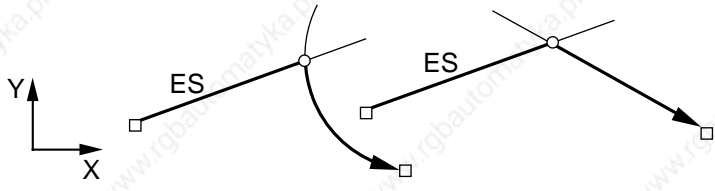
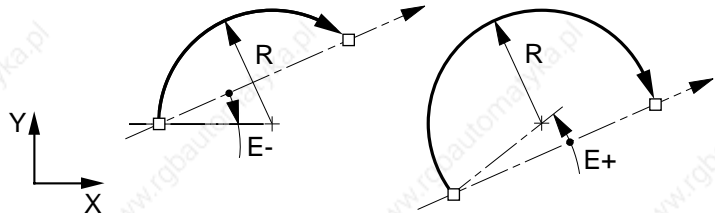
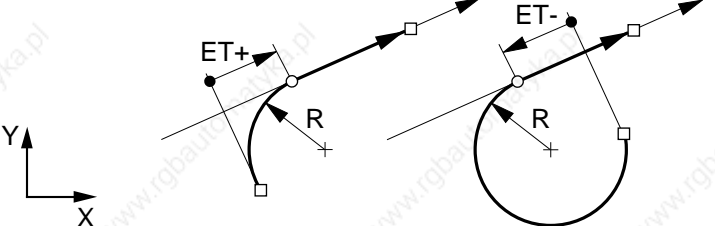
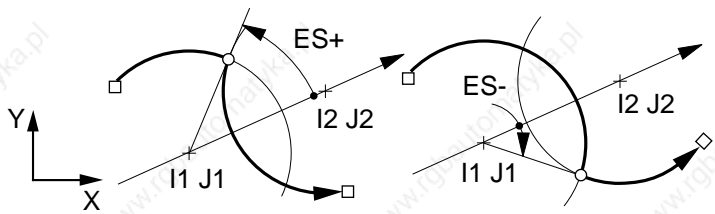
<p>Arc</p> <p>Syntax: N.. [G02/G03] (I.. J.. or R)</p>	
<p>Tangent elements</p> <p>Syntax: N.. (definition of first element) ET</p>	
<p>Secant elements</p> <p>Syntax: N.. (definition of first element) ES</p>	
<p>Removal of ambiguity by discriminant</p> <p>Syntax: N.. (definition of the element) E+/-</p>	
<p>Removal of ambiguity for tangent elements</p> <p>Syntax: N.. (definition of first element) ET+/-</p>	
<p>Removal of ambiguity for secant elements</p> <p>Syntax: N.. (definition of first element) ES+/-</p>	

A

Fillet between two intersecting elements

Syntax: N.. (definition of first intersecting element) **EB+..**

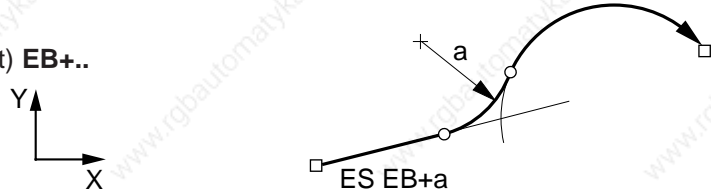

Chamfer between two intersecting lines

Syntax: N.. (definition of first intersecting line) **EB-..**

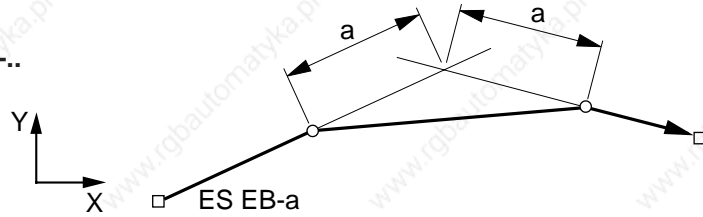

Appendix B List of Errors

B.1	Miscellaneous Errors and Machine Errors	B - 3
B.2	Parametric Programming Errors	B - 4
B.3	Profile Geometry Programming (PGP) Errors	B - 5
	B.3.1 The end point is not determined or cannot be computed from the elements in the blocks	B - 5
	B.3.2 The point of tangency or intersection cannot be computed from the data in two blocks	B - 5
	B.3.3 The points of tangency or intersection cannot be computed from the data in three blocks	B - 5
	B.3.4 Fillet or chamfer definition errors	B - 5
	B.3.5 Miscellaneous errors in PGP	B - 6
B.4	Miscellaneous Errors	B - 6
B.5	Request for Movements Outside the Machine Travel Limits	B - 6
B.6	Structured Programming Errors	B - 7
B.7	Axis Errors	B - 7
B.8	Errors in Pocket Cycles	B - 8
B.9	Axes Not Identified on the Bus	B - 8
B.10	Dynamic Operators in C	B - 9
B.11	Spline Curve Interpolation Errors	B - 9
B.12	Errors in Numform	B - 9
B.13	Cycle Programming Errors	B - 10

B.1 Miscellaneous Errors and Machine Errors

Error No.	Meaning of the error
1	Unknown character / Axis not recognised by the system Too many digits after a function Presence of a sign after a function which does not allow signs Truncated block signalled by ? via CLOSE in drip feed mode
2	Unknown G function or a mandatory argument missing after the G
3	Attribute of a G code wrongly positioned
4	Option not enabled or option parameter conflict: Structured programming, RTCP, synchronised axes, etc.
5	Geometric option programming not enabled
6	Polynomial interpolation option missing coefficient table full
7	Error in programming movements parallel to inclined axes (grinder): - Programming is not in plane G20 - Interpolation is not in G00 or G01 - X is not programmed after G05 - X and Z are not programmed after G07
8	Tool correction number too high
9	A sequence of too many non-working blocks - Endless Loop
10	In PLC terminal access: Bus exchange error
11	In PLC terminal access: Bus initialisation error or exchange inhibited
12	In PLC terminal access: Rack parameter error
13	In PLC terminal access: No such card
14	Inclined plane option missing PLC boundary access: channel missing
15	Invalid line configuration
16	Error in RTCP activation
17	End of block in a comment - close bracket missing
18 *	Servo error: P50 too small
20	No M02 at the end of the programme Blocks not made executable in a cycle called by a G function
21	Blank definition incoherent in 3D mode
24	Error in inclined plane declaration - Function reactivated when already active - Function argument declaration incomplete - Pivot point axis does not exist or is not servo-controlled - Incoherent value in one of the matrix terms
25	Subroutine or sequence number does not exist
26	Too many subroutine nesting levels
27	Radius offset: In G52 machine origin programming / With taper threads
28	Syntax error in CCSPD or index table radius definition G96 must be followed by S / G97 must be followed by S / initial radius cannot be determined X or U not programmed in this block or a previous block
29	No range programmed for CCSPD / No range compatible with S in G97: No range search option: S not included between min. and max. values of the range programmed With range search option: S does not belong to any range
30	Line error detected

* Machine error. Caution: For this type of error, a CNC reset causes a general reset (CNC reset + PLC reset)

Error No.	Meaning of the error
31 *	PPR or PPL mode impossible with the line protocol selected
32 *	Homing error / Axis already on limit switch
33 *	All slides on wait for synchronisation
34	Minimum radius reached in G21 interpolation
35 *	Sequence number not found in SEARCH
36 *	Part programme memory full
37	Max. feed rate exceeded for thread cutting (COMAND)
38	Spindle already controlled by another axis group
39 *	Axis synchronisation error (with axis synchronisation option)
40-49 *	Excessive following error on axis 0 to 9
50-59 *	Excessive following error on axis 10 to 19
60-69 *	Excessive following error on axis 20 to 29
70 and 71 *	Excessive following error on axis 30 and 31
72	Incremental programming after an incomplete block (PGP)
75	Switch from state G20 to G21 or G22: last block in G20 incomplete as it is programmed in PGP or radius correction or with $X \leq 0$ first block in G21 without X and Y or G22 without Y and Z Switch from state G21 or G22 to G20: last block in G21 or G22 incomplete or first block in G20 in mode G41 or G42: In G21 or G22, initial radius negative or zero
76	In G21, programming of a fixed turning and milling cycle
77	Tool type incompatible with the machining phase (milling or turning)
78	Syntax error in programming slide synchronisation G78 P: Maximum 4 digits, must be less than the number of slides G78 Q: Maximum 4 digits No M00, M01 or M02 with G78 P..

* Machine error. Caution: For this type of error, a CNC reset causes a general reset (CNC reset + PLC reset).

B.2 Parametric Programming Errors

Error No.	Meaning of the error
91	Parameter No. not recognised
92	Negative parameter assigned to a function which does not take a sign Parameter value higher than the maximum value of the function to which it is assigned
93	Error in parameter declaration or test expression: L function not followed by symbols =, <, >, &, ! Association with a prohibited function by a linking character -, +, *, /.
94	Operation prohibited in a parametric expression: Square root of a negative number / Division by 0
95	Attempt to write in an external input parameter or a read-only parameter
96	The block preceding the external parameter declaration is incomplete Programming of L100 ... in a contour definition in G64
97	Parameter update impossible in G76: No symbol = after the parameter number Less than 10 characters allocated for entry of the value
98	Write by an axis group of a dynamic operation already used by another group
99	Error related to the N/M AUTO function - More than 5 N/M AUTO axes defined - Non-servo-controlled axis defined as N/M AUTO - Definition of an N/M AUTO axis of another group

B.3 Profile Geometry Programming (PGP) Errors

B.3.1 The end point is not determined or cannot be computed from the elements in the blocks

Error No.	Meaning of the error
101	PGP: Insufficient data for programming a circle Circle programmed on two parallel axes (with R / see Error 107)
102	Line programmed by an angle and one coordinate with no way of calculating the other coordinate
106	In G02, G03, programming of the third axis without helical option
107	PGP: Circle programmed by its radius and end point, with the end point separated from the start point by more than $2 * \text{radius}$ Circle programmed by X, Z, I K with a start radius different from the end point (20 microns) / Helical: dimension of 3rd axis missing Circle programmed on two parallel axes (with I, J, K / see Error 101)

B.3.2 The point of tangency or intersection cannot be computed from the data in two blocks

Error No.	Meaning of the error
110	PGP: Syntax error in the first of two blocks of a PGP entity
111	PGP: Syntax error in the second block of a PGP entity
112	PGP: Line/line intersection in which: First block starting point = second block end point, or First line angle = second line angle
113	PGP: The values programmed in the two blocks do not allow determination of an intersection or tangency point
114	PGP: Intersection or tangency point not determined by ET+, ET-, ES+ or ES-

B.3.3 The points of tangency or intersection cannot be computed from the data in three blocks

Error No.	Meaning of the error
121	PGP: Syntax error in the last of the three blocks of a PGP entity
122	PGP: The first two blocks are non-intersecting lines
123	PGP: The data programmed in the three blocks do not allow determination of the tangent point
124	PGP: Tangent point of the second and third blocks not specified by ET+ or ET-

B.3.4 Fillet or chamfer definition errors

Error No.	Meaning of the error
130	Zero displacement in one of the two blocks connected by a fillet or a chamfer
131	Fillet or chamfer programmed in a block including M0, M1 or M2 Programming insufficient in a sequence of blocks, not allowing determination of the end point
135	A chamfer can only connect two straight lines

B.3.5 Miscellaneous errors in PGP

Error No.	Meaning of the error
136	More than two blocks without movement between two geometric elements whose intersection or tangency point is to be calculated
137	Change of interpolation plane with an invalid block

B.4 Miscellaneous Errors

Error No.	Meaning of the error
138	Change of interpolation plane when not in G40 (FCU)
139	Two carried parallel axes programmed in the same block outside G52 and outside G00
140	Radius correction programming error: Too many extraneous blocks between two consecutive paths The following functions cannot be programmed when radius offset is active: M00, M01, M02, access to external parameters, writing of parameters E8xxxx or L > 100
141	Carried parallel axes: Programming of a circle whose start point was programmed with one axis and whose end point was programmed with the associated parallel axis
143	Scale factor cancelled or enabled with radius offset
144	Movement of a quantified axis different from the increment
145	G29: $ABS VAL (P * P + Q * Q + R * R - 1000 \text{ mm}) > 1 \text{ mm}$ (normal vector not a unit vector)
146	Offset in space / G29 - At least one of dimensions P, Q or R missing - At least one of dimensions X/U, Y/V or Z/W missing
148	Number of axes programmed exceeds the maximum authorised number
149	Tool radius too large with respect to programmed path

B.5 Request for Movements Outside the Machine Travel Limits

Error No.	Meaning of the error
150	Travel overrun on the X axis
151	Travel overrun on the Y axis
152	Travel overrun on the Z axis
153	Travel overrun on the U axis
154	Travel overrun on the V axis
155	Travel overrun on the W axis
156	Travel overrun on the A axis
157	Travel overrun on the B axis
158	Travel overrun on the C axis
159	Request for programmed movement on an UN-HOMED axis

B.6 Structured Programming Errors

Error No.	Meaning of the error
190	Too many branch or loop nesting levels (maximum 15)
191	Non-compliance with the syntax in structured programming structured programming prohibited in MDI mode the index of a FOR loop must be: an L variable, a symbolic variable or a parameter E80000, E81000 or E82000 non-compliance with the syntax of PUSH and PULL instructions DO missing after WHILE programming of IF, THEN, ELSE in MDI mode
192	Keyword not recognised or prohibited in the context
193	Structure error
195	Programme stack saturated / Too many constants defined for the space allocated
196	Error in array index declaration
197	Use of a symbol not declared as VAR
198	Syntax error in variable symbol declaration
199	Incorrect variable declaration syntax

B.7 Axis Errors

Error No.	Meaning of the error
210 to 219 *	Poor signal or pulse generator complementarity error on axis 0 to 9
220 to 229 *	Poor signal or pulse generator complementarity error on axis 10 to 19
230 to 239 *	Poor signal or pulse generator complementarity error on axis 20 to 29
240 and 241 *	Poor signal or pulse generator complementarity error on axis 30 and 31
245 *	Fault on digital servo-control

* Machine error. Caution: For this type of error, a CNC reset causes a general reset (CNC reset + PLC reset)

B.8 Errors in Pocket Cycles

Error No.	Meaning of the error
260	Working memory busy
261	Programme number too high
262	NU number not among those authorised
263	Execution impossible - Test or Graphic mode mandatory after first load or after editing
264	No dimension programmed in the contouring plane or dimension outside the plane
265	First positioning block missing; contour definition must begin with G0 or G1
266	Not enough memory
267	Character not allowed in pocket syntax
268	Pocket programming block incomplete or containing illegal data
269	Contour block incomplete / Positioning block missing before pocket definition
270	Pocket definition partly or completely missing
271	Tool orientation not perpendicular to the contouring plane
272	Real tool not compatible with pocket technological data
273	Change of contouring plane between pocket definition and machining
274	Two nested pocket definitions
275	NU0 programmed with G59
276	Zero pocket depth
277	Pocket definition start point or end point coordinates incomplete
278	The spindle rotation direction is incompatible with the one required in the pocket definition
279	G function not allowed in a pocket programming block
280	First contour block incomplete
281	Discontinuity in one of the contours described
282	Pocket definition parameter error(s)
283	The external contour must be unique and must exist
284	Error in contour definition
285	Too many contours
286	Pass setting excessive with respect to the tool diameter
287	Pass setting insufficient with respect to the dimensions
288	Finishing infeed in an acute angle or an unroughed area: change the infeed point
289	Tool diameter excessive
290	Internal error
291	Finishing infeed outside the contour
292	Double positioning at the start of the contour
293	Roughing end point present during facing

B.9 Axes Not Identified on the Bus

Error No.	Meaning of the error
300 to 309 *	Axis 0 to 9 declared in P2 but not detected on the bus
310 to 319 *	Axis 10 to 19 declared in P2 but not detected on the bus
320 to 329 *	Axis 20 to 29 declared in P2 but not detected on the bus
330 and 331 *	Axis 30 and 31 declared in P2 but not detected on the bus

* Machine error. Caution: For this type of error, a CNC reset causes a general reset (CNC reset + PLC reset)

B.10 Dynamic Operators in C

Error No.	Meaning of the error
400	Loading dyn. ops in C: The size of user code is too big
401	Loading dyn. ops in C: Format error
402	Loading dyn. ops in C: Checksum error
403	The system has insufficient memory for dyn. ops in C
404	Loading dyn. ops in C: Open error
405	Loading dyn. ops in C: Read error
406	Loading dyn. ops in C: Close error
407	Loading dyn. ops in C: The directory is empty
410	Dyn. ops in C: Number of parameters passed doesn't tally
411	Dyn. ops in C: USER ERROR from INIT: negative return
413	Unrecognised dyn. ops in C
414	Dyn. ops in C without MAIN
420	Dyn. ops in C: USER ERROR from the QUIT function
421	Dyn. ops in C: USER ERROR from the QUIT function: negative return
423	Dyn. ops in C: Range of function in C not from [0..100]

B.11 Spline Curve Interpolation Errors

Error No.	Meaning of the error
600	Curve number zero
601	N.. N.. must be programmed
602	No axes programmed in the first block of the contour
603	Curve slope undefined
604	Less than three blocks in the profile
605	Curve number unknown

B.12 Errors in Numaform

Error No.	Meaning of the error
700	Options missing
701	S.. missing at beginning of curve
702	Number of S.. different in T1 & T2
703	Minimum 2 occurrences of S in T1
704	Undefined section (in T3)
705	Plane switching outside S mark
706	Spindle stopped
707	Invalid E= function
708	E=1 or E=2: Section positioning error
709	T1 & T2 can't have any points in common
710	P, Q must be positive
711	S different in T1 & T2
712	Undetermined tool position
713	Error: S=0 or T>3
730	F= less than or equal to zero
731	Intersection of concentric circles
732	Intersection of parallel lines
733	Limit cannot be a horizontal plane
740	F = error

B.13 Cycle Programming Errors

Error No.	Meaning of the error
830	Positioning not completed
831	Spindle stopped
832	End point, P and K must be programmed
833	Retraction clearance too small
834	EB value: $-90 < EB < +90$
835	The values of P, Q, R and K are absolute values
836	The interpolation plane must be G81 or G20
837	Bad value of F or S
862	P or R and end point to be programmed
863	End point incoherent with EA
864	Milling tool prohibited in G66
871	Finished profile limits not defined
872	No dimensions in blank definition
873	P or R not programmed
874	Blank inconsistent with finished profile
875	No intersection of EA with the profile
876	Relief angle EB incorrectly defined
880	Cycle axis unknown
881	Parameter value not compatible
882	Hole bottom dimension not programmed
883	Pitch (I J K) or clearance (P) not programmed
884	More than 9 thread starts
885	Pocket incompatible with the plane selected
886	Tool incompatible with the radius programmed
887	Cut > tool diameter
888	Dwell prohibited in this cycle
889	Syntax error
890	Tool orientation incompatible
891	Return plane = bottom of hole
892	Axial feed missing
893	Lateral feed missing
894	ER prohibited in G20
895	G21, G22 prohibited in cycle
896	Dimension incompatible with tool radius
897	Length of oblong pocket < diameter
898	Tool corrector missing
899	Spindle not assigned to this group or spindle or group incompatible

Appendix C Use of Peripherals

C.1 CNC / Peripheral Interconnection

C.1.1	Interconnection Diagrams	C - 3
C.1.1.1	Interconnection Principles	C - 3
C.1.1.2	Connection of a Peripheral to an RS 232 Serial Line	C - 4
C.1.1.3	Connection of a Peripheral to a TTL Line	C - 4
C.1.1.4	Connection of a Peripheral to an RS 422, RS 485 or RS 422 Synchronous and High Speed Line	C - 5
C.1.1.5	Connection of NUM Diskette Drive to an RS 232 Line	C - 5
C.1.1.6	Connection of NUM Diskette Drive with Remote RS 232 Line	C - 6
C.1.1.7	Connection of NUM Diskette Drive to an RS 422 Line	C - 6
C.1.1.8	Connection of NUM Diskette Drive with Remote RS 422 Line	C - 7
C.1.2	Cables	C - 8
C.1.2.1	RS 232/Peripheral Device Serial Connecting Cable	C - 8
C.1.2.2	TTL/Adapter Output Cables	C - 9
C.1.2.3	RS 232/Adapter Serial Connecting Cable	C - 10
C.1.2.4	RS 232/NUM Drive Serial Link Cable	C - 11
C.1.2.5	NUM Drive Power Cable	C - 12
C.1.2.6	Remote RS 232 Line Cable on Machine Panel or Compact Panel	C - 13
C.1.2.7	NUM Drive RS 422 Serial Link Cable	C - 15
C.1.2.8	Remote RS 422 Line Cable on Machine Panel or Compact Panel	C - 16
C.1.2.9	RS 422 Serial Link and High Speed Line Cable	C - 18

C.2 Connection to a Peripheral Device

C.2.1	PC Microcomputer or Compatible	C - 21
C.2.1.1	Numerical Control / Microcomputer Link	C - 21
C.2.1.2	Setting up the Link	C - 22
C.2.2	Tape Reader/Punch	C - 22
C.2.2.1	Numerical Control / Peripheral Device Connection	C - 22
C.2.2.2	Numerical Control / Peripheral Device Connection	C - 23
C.2.2.3	Setting up the Link	C - 24
C.2.3	NUM Diskette Drive	C - 25
C.2.4	Printer	C - 25
C.2.4.1	Printers Recommended by NUM	C - 25
C.2.4.2	Numerical Control / Printer Connection	C - 26
C.2.4.3	Setting up the Link for Printing	C - 26
C.2.4.4	Setting up the Link for Hard Copy	C - 26

C.3 Connection to a Computer

C.3.1	Setting up the Link	C - 27
C.3.2	Communications with the Computer	C - 27

C.1 CNC / Peripheral Interconnection

The numerical control can exchange data (loading or unloading) with:

- a peripheral device,
- a host computer (DNC).

The connections on the CNC side use one of the CNC serial lines.

The peripheral devices used to exchange data are:

- microcomputer fitted with a NUM compatible software capable of exchanging data (APA 10, NUM training package, communication software),
- tape reader / punch,
- NUM diskette drive,
- printer.

C.1.1 Interconnection Diagrams

C.1.1.1 Interconnection Principles

When installing the connecting cables, separate the serial link cables from power cables and the cables of interference circuits:

- by physical segregation (minimum 30 cm recommended),
- by routing the cables in trays with separate, segregated cable raceways,
- by crossing them at 90 degrees.

Connection of shielding to a connector plug cover

Earth the cable shieldings over 360 degrees, fold the shieldings onto the cables over a length of 1 cm and clamp them in the cover clamp.

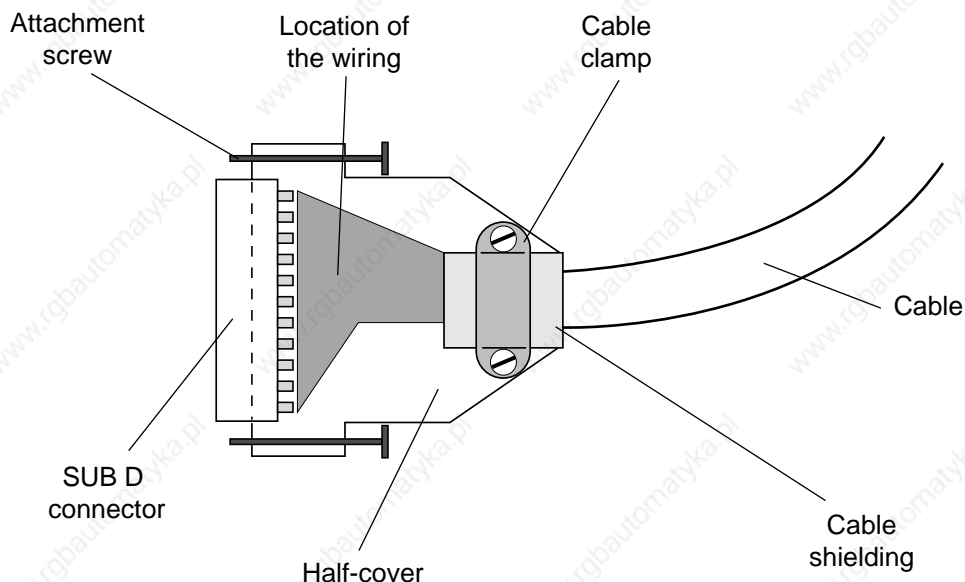

C.1.1.2 Connection of a Peripheral to an RS 232 Serial Line

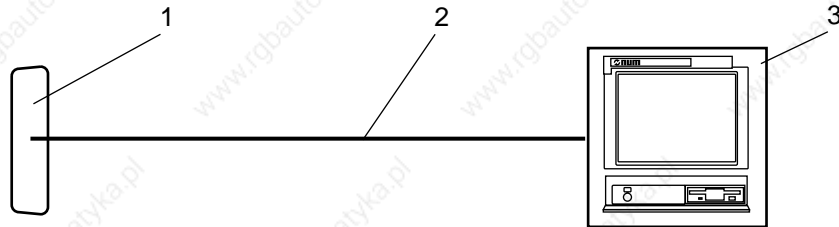

- 1 - RS 232 line:
- 25 contacts on machine or CNC processors or UC SII CPU
 - 15 contacts on IT/serial line card
 - 9 contacts on V2 machine processor, V2 CNC and UC SII, 1020, 1040 and 1050 CNCs
- 2 - Peripheral RS 232 serial link cable (See C.1.2.1)
- 3 - Peripheral or NUM PC panel (example)

REMARK Configure the serial lines using the serial line parameters utility (See 8.3).

C.1.1.3 Connection of a Peripheral to a TTL Line

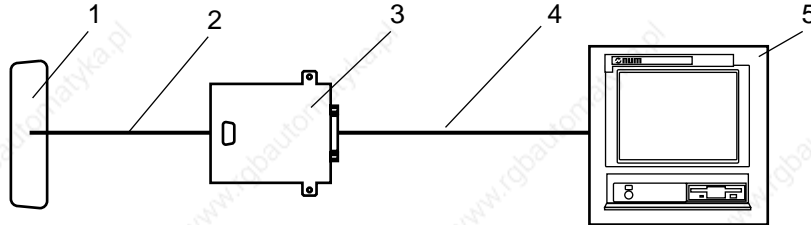

- 1 - TTL line
- 2 - TTL output/adaptor connecting cable (See C.1.2.2)
- 3 - RS 232 adapter (P/N 205201338)
- 4 - Adapter RS 232 serial connecting cable (See C.1.2.3)
- 5 - Peripheral or NUM PC panel (example).

REMARK Configure the serial lines using the serial line parameters utility (See 8.3).

C.1.1.4 Connection of a Peripheral to an RS 422, RS 485 or RS 422 Synchronous and High Speed Line

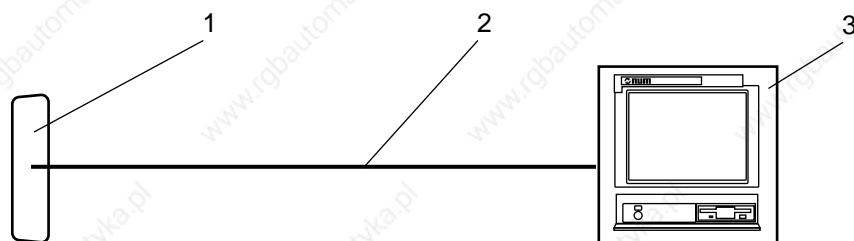

- 1 - Serial line:
 - . 15 contacts on IT/serial line card configured for RS2 422 or RS 485 and high speed line of the CNC V2 processor
 - . 9 contacts on V2 machine processor, V2 CNC and UC SII, 1020, 1040 and 1050 (serial) CNCs.
- 2 - Serial interface cable:
 - . RS 422 and high speed on V2 CNC processor (See C.1.2.9)
 - . RS 485 on V2 machine processor and V2 CNC processor (See C.1.2.9)
 - . RS 422 synchronous on 1060 CNC (See C.1.2.9)
- 3 - Peripheral or NUM PC panel (example).

REMARK Configure the serial lines using the serial line parameters utility (See 8.3).

C.1.1.5 Connection of NUM Diskette Drive to an RS 232 Line

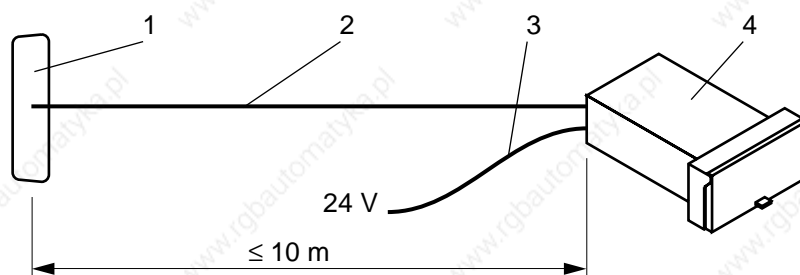

- 1 - RS 232 line:
 - 25 contacts on machine and CNC processors, TTL/RS 232 adapter or UC SII CPU or remote on machine panel
 - 9 contacts on UC SII CPU, V2 machine processor, V2 CNC processor, 1020, 1040, 1050 or remote on compact panel
- 2 - RS 232 serial link cable (See C.1.2.4) or cable supplied (P/N 206203324)
- 3 - Drive power cable (See C.1.2.5)
- 4 - NUM diskette drive

REMARK Configure the serial lines using the serial line parameters utility (See 8.3). Set the lines for RS 422 standard.

CAUTION

The NUM diskette drive can only be used on the 25-contact line of the UC SII CPU when the UC SII CPU has a card with an index number equal to 204202896/H or above.

C.1.1.6 Connection of NUM Diskette Drive with Remote RS 232 Line

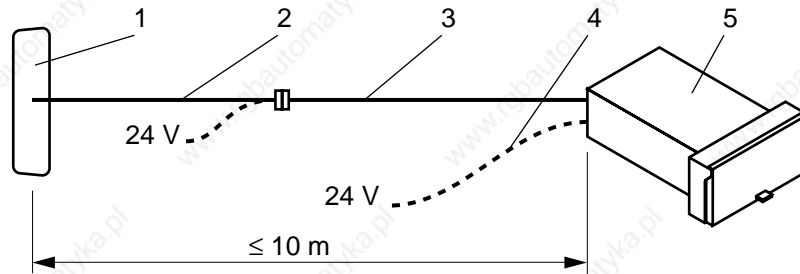

- 1 - RS 232 line:
 - 25 contacts on machine and CNC processors, TTL/RS 232 adapter or UC SII CPU
 - 9 contacts on UC SII CPU
- 2 - RS 232 line cable on V2 machine processor, V2 CNC and 1020, 1040 or 1050 with or without power supply:
 - Remote on machine panel (See C.1.2.6)
 - Remote on compact panel (See C.1.2.6).
- 3 - RS 232 serial link cable (See C.1.2.4) or cable supplied (P/N 206203324)
- 4 - Drive power cable (only when cable 2 does not provide the power supply: See C.1.2.5)
- 5 - NUM diskette drive

REMARK Configure the serial lines using the serial line parameters utility (See 8.3). Set the lines for RS 422 standard.

CAUTION

The NUM diskette drive can only be used on the 25-contact line of the UC SII CPU when the UC SII CPU has a card with an index number equal to 204202896/H or above.

C.1.1.7 Connection of NUM Diskette Drive to an RS 422 Line

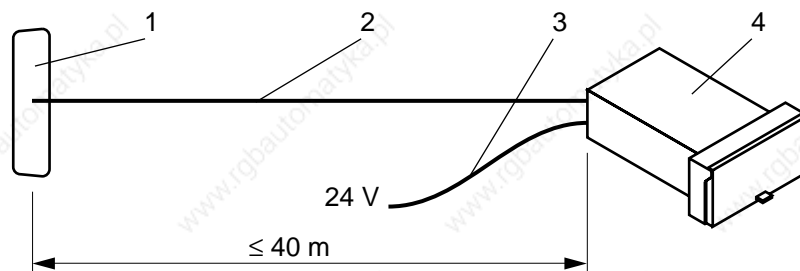

- 1 - Multistandard line configured for RS 422
 - 15 contacts on IT/serial line card
 - 9 contacts on V2 machine processor, V2 CNC and UC SII, 1020, 1040 and 1050 (serial) CPUs
- 2 - RS 422 serial link cable (See C.1.2.7)
- 3 - Drive power cable (See C.1.2.5)
- 4 - NUM diskette drive

REMARK Configure the serial lines using the serial line parameters utility (See 8.3).

C.1.1.8 Connection of NUM Diskette Drive with Remote RS 422 Line

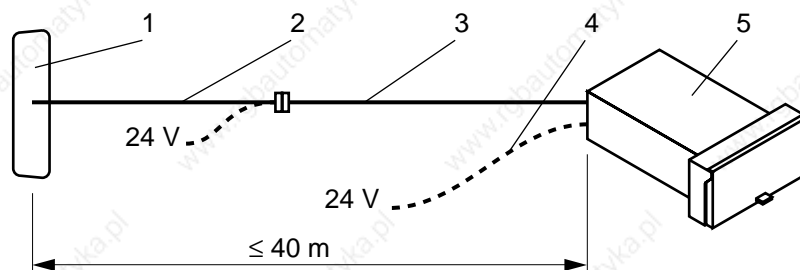

- 1 - Multistandard line configured for RS 422
 - 15 contacts on IT/serial line card
 - 9 contacts on V2 machine processor, V2 CNC and UC SII, 1020, 1040 and 1050 (serial) CPUs.
- 2 - RS 422 line cable with or without power supply:
 - Remote on machine panel (See C.1.2.8)
 - Remote on compact panel (See C.1.2.8)
- 3 - RS 422 serial link cable (See C.1.2.7) or cable supplied (P/N 206203324)
- 4 - Drive power cable (only when cable 2 does not provide the power supply: See C.1.2.5)
- 5 - NUM diskette drive

REMARK *Configure the serial lines using the serial line parameters utility (See 8.3).*

C.1.2 Cables

⚠ CAUTION

For correct interference suppression, the cable shieldings must be earthed in accordance with the instructions of Sec. C.1.1.1.

C.1.2.1 RS 232/Peripheral Device Serial Connecting Cable

The connecting cable must be adapted to the peripheral device by not wiring the signals that are not going to be used and by using an appropriate Sub.D connector (See peripheral manual).

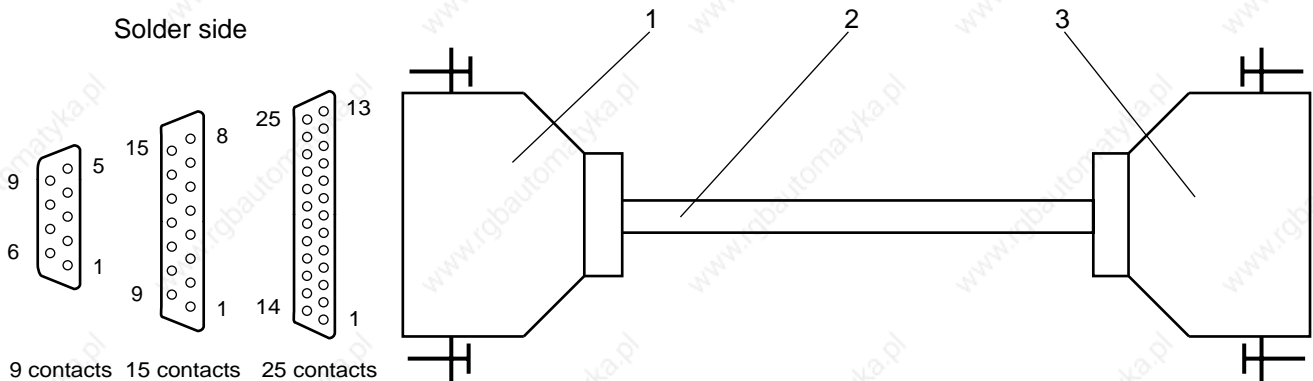

- 1 - 9-, 15- or 32-contact male Sub.D connector on NUM side
- 2 - Shielded cable depending on the peripheral (2 twisted pairs and 4 conductors for complete connection, 0.2 mm² minimum cross sectional area)
- 3 - Plug depending on the peripheral

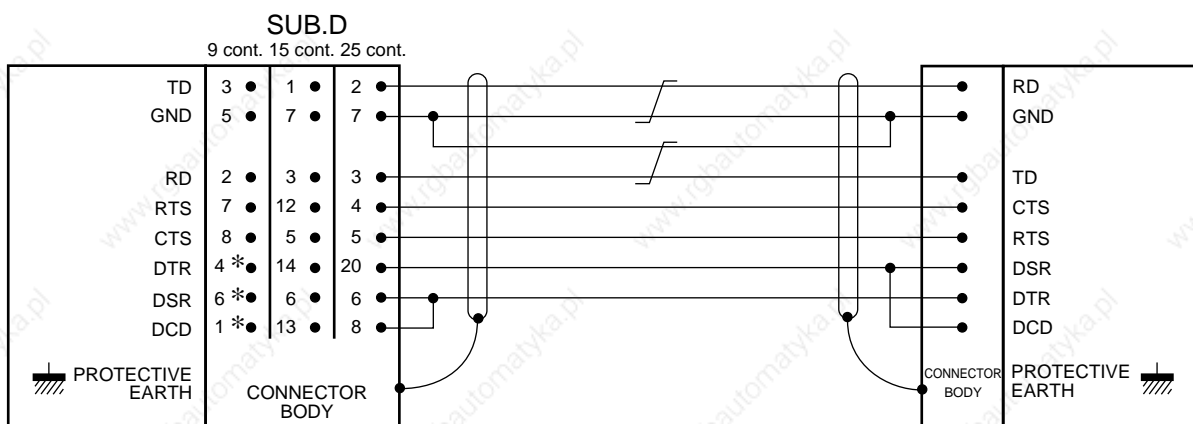

* Contacts 1, 4 and 6 must not be connected on the 9-contact connector of the V2 machine processor and V2 CNC.

Without control signals, interconnect:

- CTS and RTS
 - DSR, DCD and DTR
- on the NUM side.

With only RTS and CTS control signals, interconnect DRS, DCD and DTR on the NUM side.

C.1.2.2 TTL/Adapter Output Cables

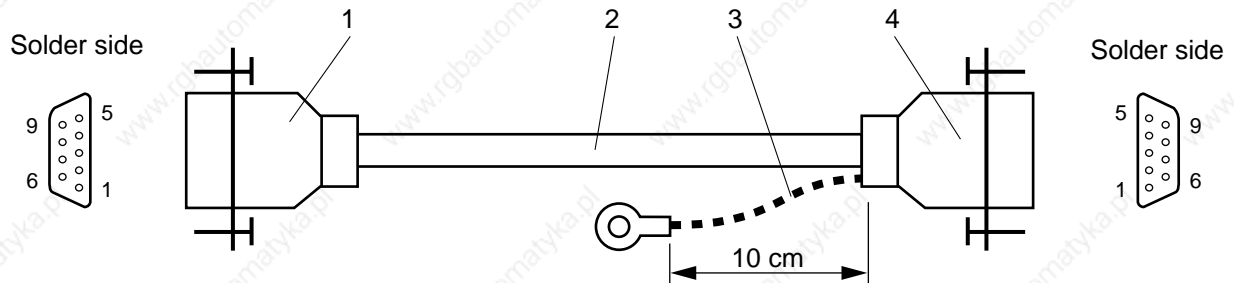

- 1 - 9-contact male Sub.D connector on the NUM side
- 2 - Shielded 6-wire cable (6x0.22 mm²), maximum length 1 m
- 3 - Wire and spade terminal for M3 screw (only for adapters at index A or B)
- 4 - 9-contact female Sub.D connector

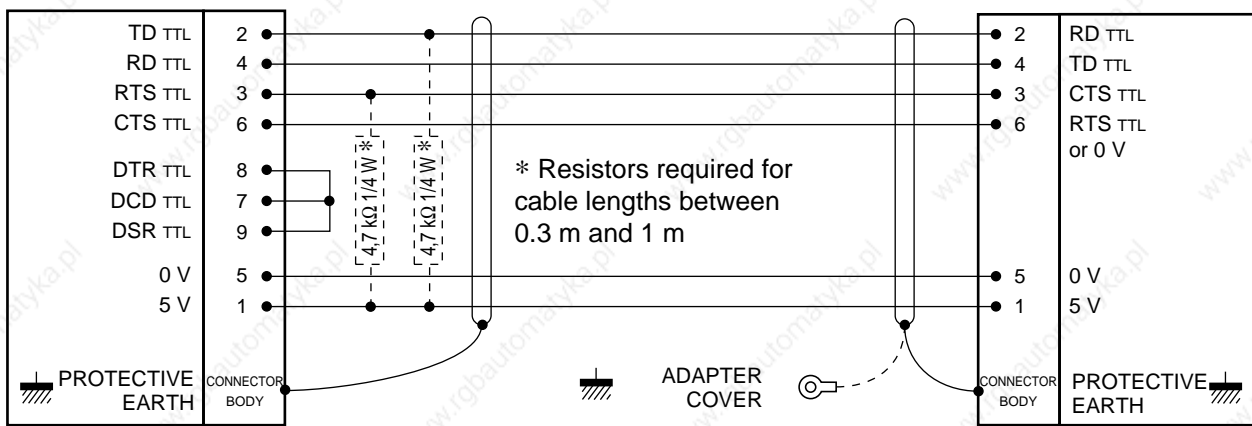

C.1.2.3 RS 232/Adapter Serial Connecting Cable

The connecting cable must be adapted to the peripheral device but not wiring by signals that are not going to be used and by using an appropriate Sub.D connector (See peripheral manual).

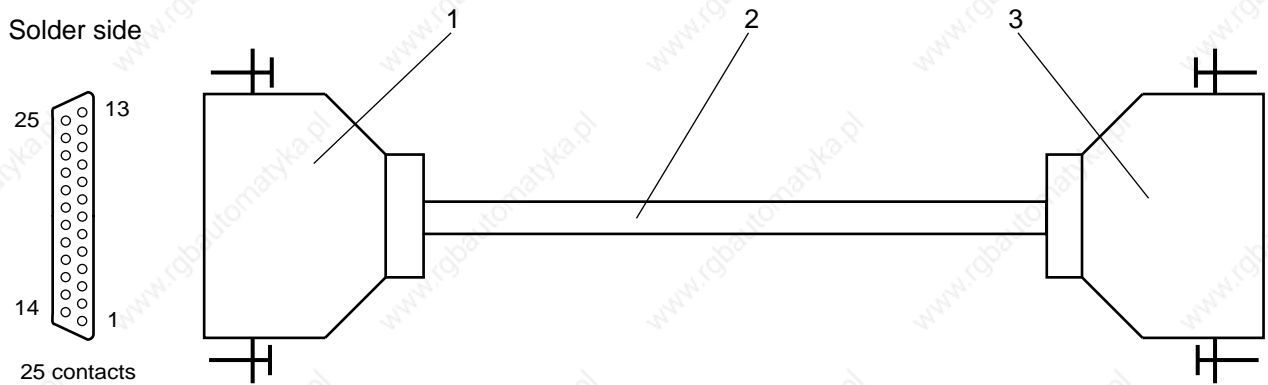

- 1 - 25-contact male Sub.D connector on NUM side
- 2 - Shielded cable depending on the peripheral (2 twisted pairs and 3 conductors for complete connection, 0.2 mm² minimum cross sectional area)
- 3 - Plug depending on the peripheral

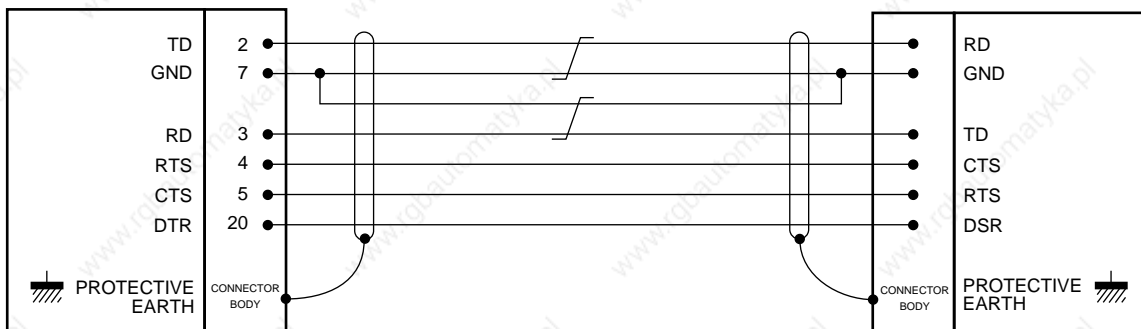

C.1.2.5 NUM Drive Power Cable

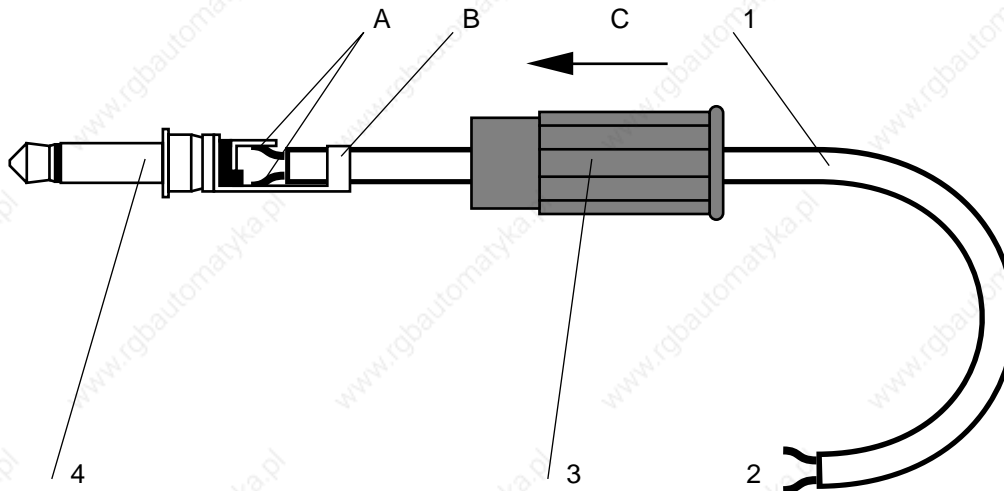

- 1 - 2-wire cable
- 2 - 24 VDC power supply (range 19.2 VDC-30 VDC), polarity unimportant
- 3 - Jack insulator
- 4 - Jack

Solder one wire to each of the conductors of the jack (A).

Fold the tabs onto the cable (B).

Push the insulator home against the collar of the connector (C).

REMARK *The drive is not supplied by the jack when the remote serial line provides the power supply.*

Remote RS 232 Line Cable on Compact Panel

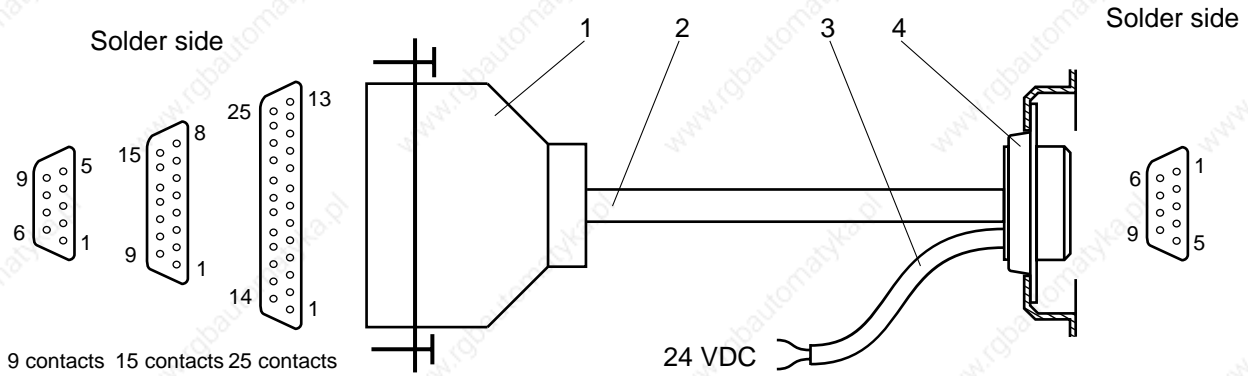

- 1 - 9-, 15- or 25-contact male Sub.D connector on NUM side
- 2 - Shielded cable with 2 twisted pairs and 5 isolated conductors (0.14 mm² minimum cross sectional area)
- 3 - 2-wire cable (optional, used for supply of the NUM drive)
- 4 - Remote 25-contact female Sub.D connector on the compact panel

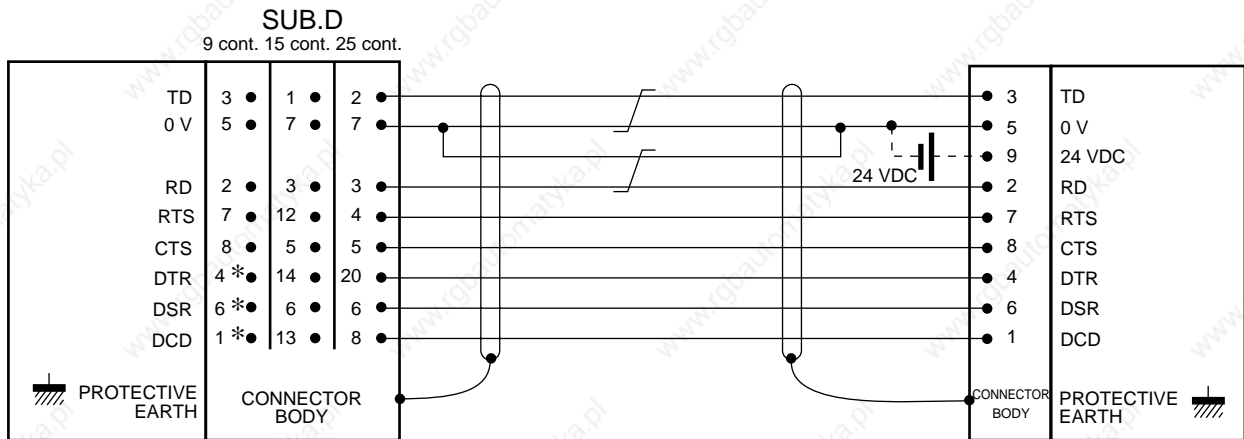

* Contacts 1, 4 and 6 must not be connected on the 9-contact connector of the V2 machine processor.

REMARK When contact 24 of the remote line is connected to a power supply, the drive must not be supplied via the jack.

C.1.2.7 NUM Drive RS 422 Serial Link Cable

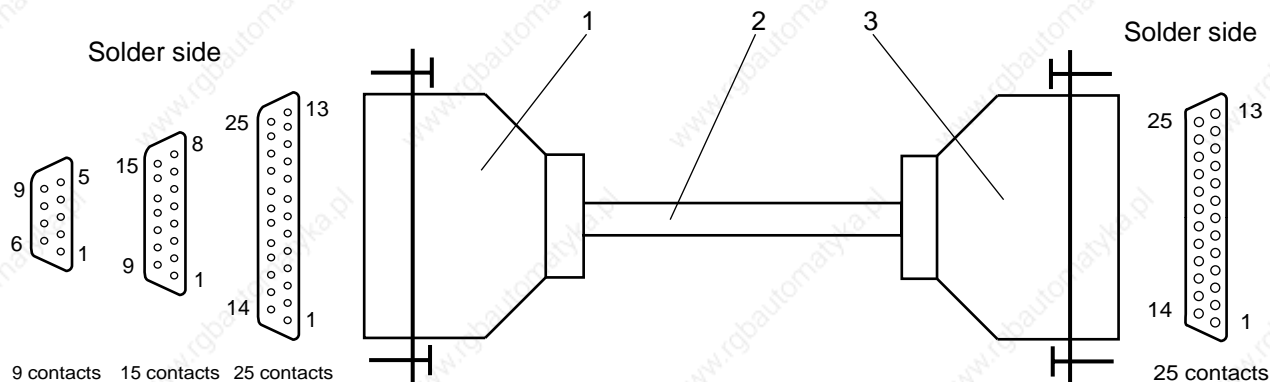

- 1 - 9-, 15- or 25-contact male Sub.D connector on NUM side
- 2 - Shielded cable with 3 twisted pairs (0.14 mm² minimum cross sectional area)
- 3 - 25-contact female Sub.D connector on the NUM drive side

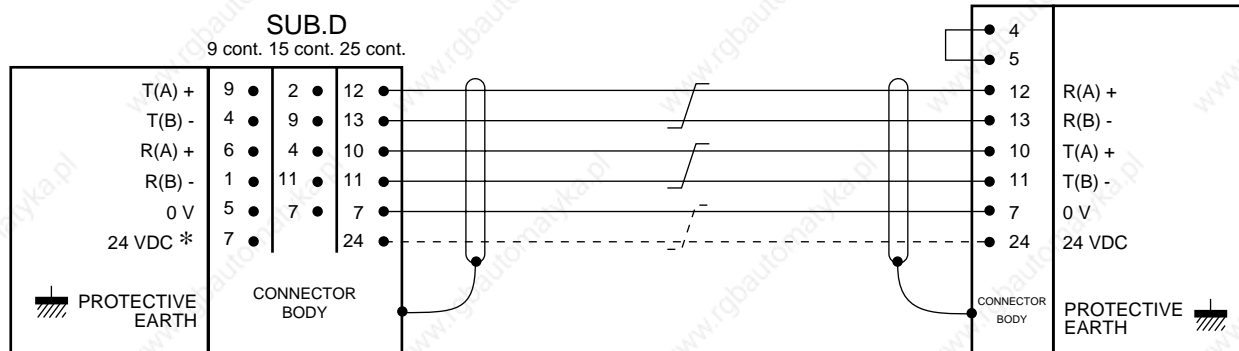

* Connection by shielded pair used only when the remote connector provides the 24 VDC power supply for the NUM diskette drive.

C.1.2.8 Remote RS 422 Line Cable on Machine Panel or Compact Panel

Remote RS 422 Line Cable on Machine Panel

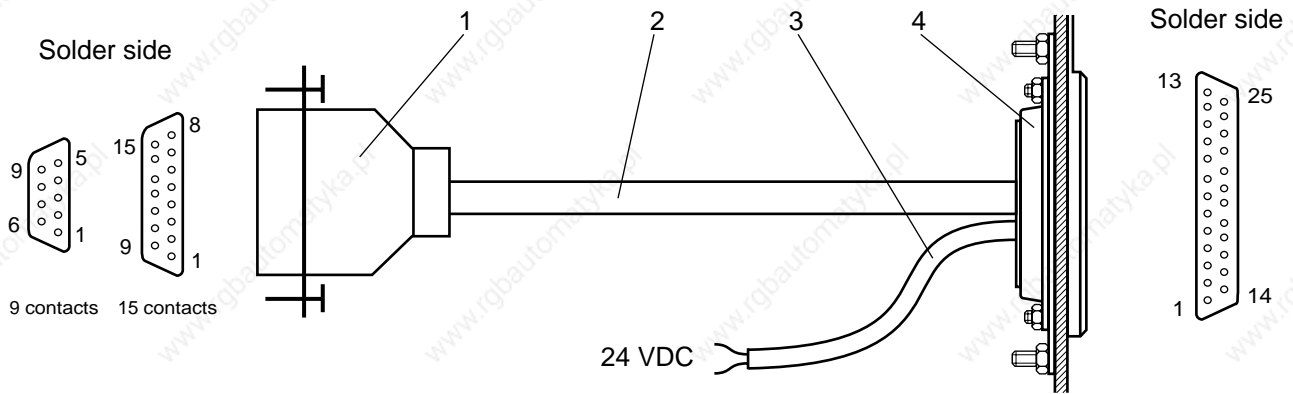

- 1 - 9- or 15-contact male Sub.D connector on NUM side
- 2 - Shielded cable with 2 twisted pairs and 1 isolated conductor (0.14 mm² minimum cross sectional area)
- 3 - 2-wire cable (optional, used for supply of the NUM drive)
- 4 - Remote 25-contact female Sub.D connector on the machine panel

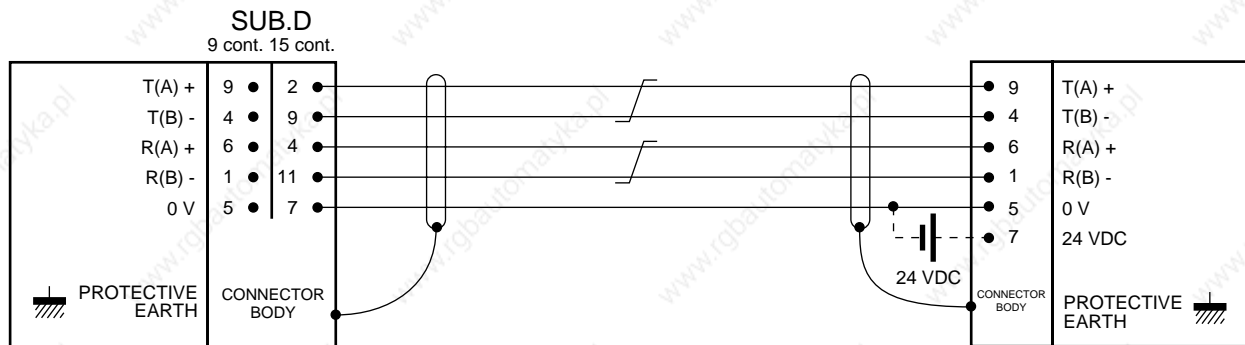

REMARK When contact 24 of the remote line is connected to a power supply, the drive must not be supplied by the jack connector.

Remote RS 422 Line Cable on Compact Panel

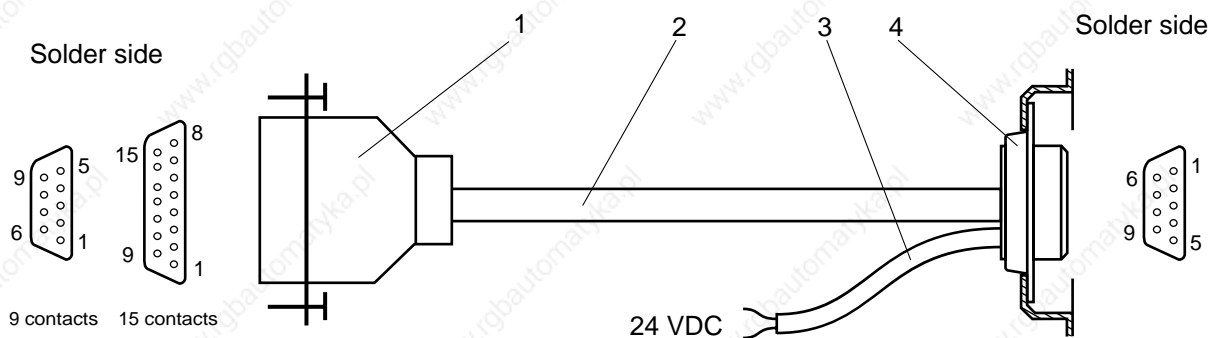

- 1 - 9- or 15-contact male Sub.D connector on NUM side
- 2 - Shielded cable with 2 twisted pairs and 1 isolated conductor (0.14 mm² minimum cross sectional area)
- 3 - 2-wire cable (optional, used for supply of the NUM drive)
- 4 - Remote 25-contact female Sub.D connector on the compact panel

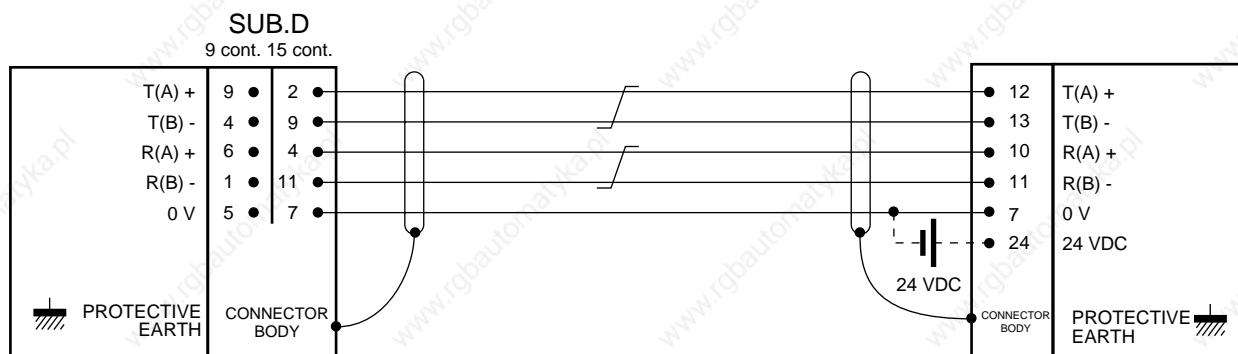

REMARK When contact 24 of the remote line is connected to a power supply, the drive must not be supplied via the jack.

C

C.1.2.9 RS 422 Serial Link and High Speed Line Cable

RS 422 Serial Link and High Speed Line Cable on V2 CNC Processor

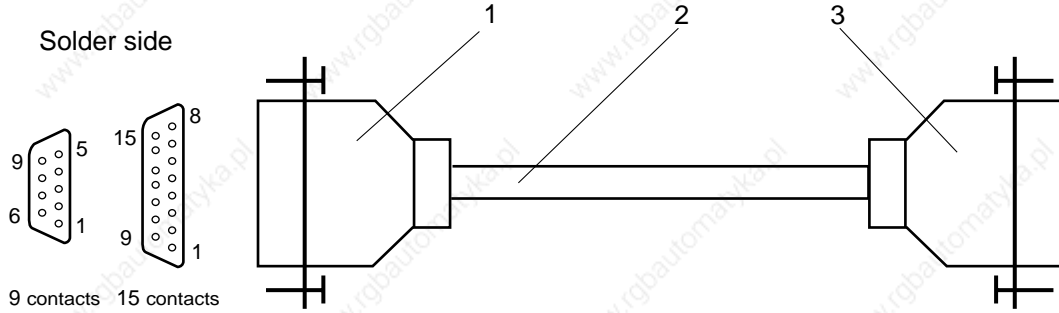

- 1 - 9- or 15-contact male Sub.D connector on NUM side
- 2 - Shielded cable with 2 twisted pairs and 1 isolated conductor
- 3 - Sub.D connector according to application

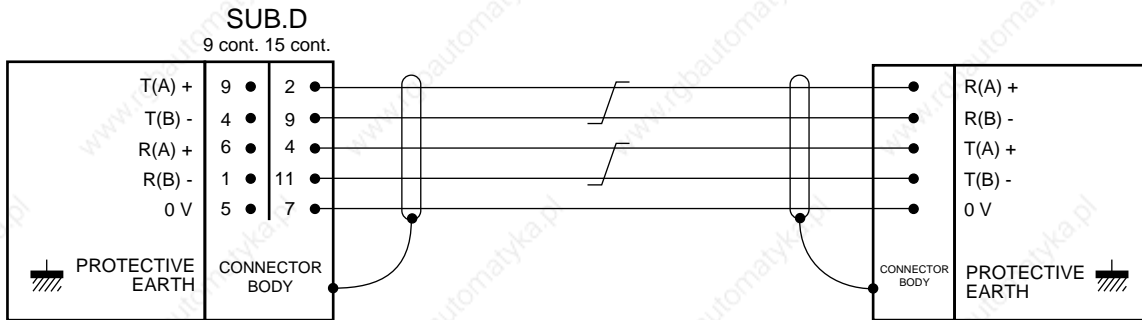

RS 485 Serial Link and High Speed Line Cable on V2 Machine Processor and V2 CNC

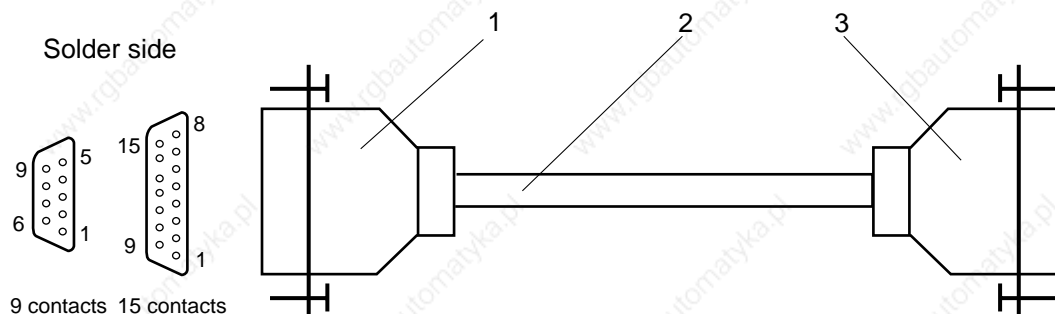

- 1 - 9- or 15-contact male Sub.D connector on NUM side
- 2 - Shielded cable with 2 twisted pairs and 1 isolated conductor
- 3 - Sub.D connector according to application

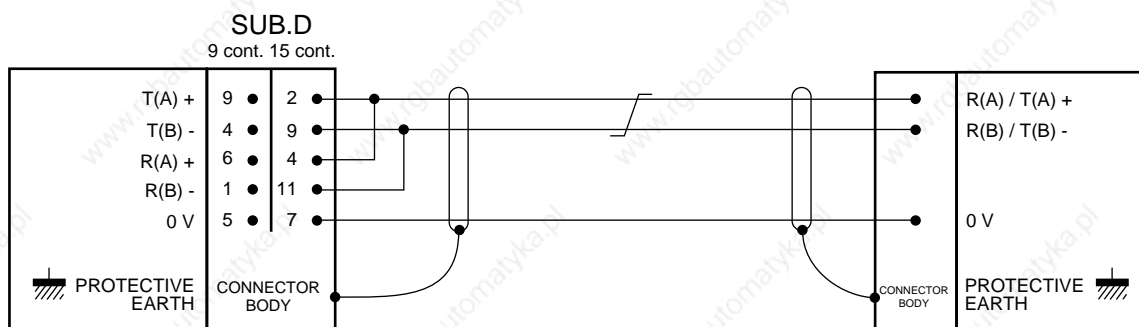

RS 422 Synchronous Serial Link on 1050 CPU

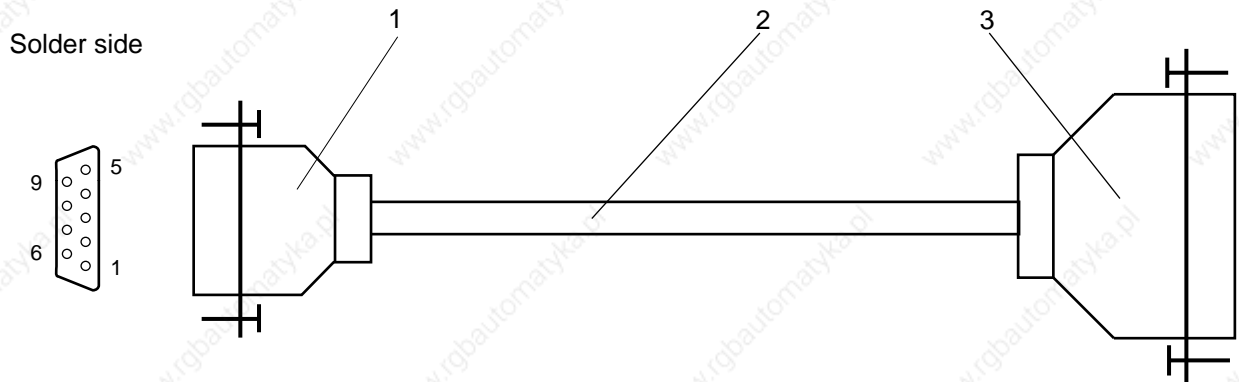

- 1 - 9-contact male Sub.D connector on CPU side
- 2 - Shielded cable with 4 twisted pairs and 1 isolated conductor (0.22 mm² minimum cross sectional area, characteristic impedance of a twisted pair approximately 120 ohms)
- 3 - Connector according to peripheral (metal or metal-plated cover)

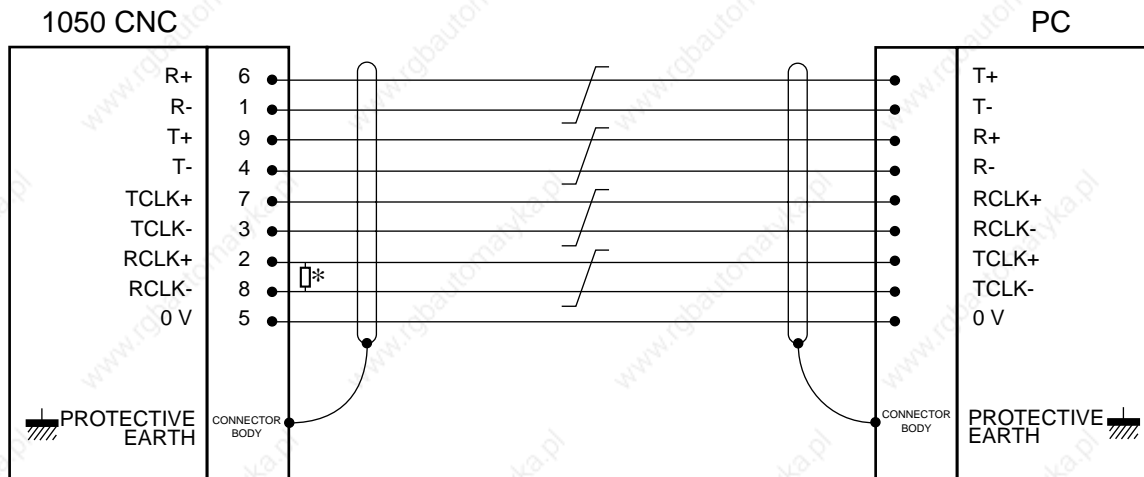

* 120-ohm, 1/4 W resistor to be soldered in the connector.

C.2 Connection to a Peripheral Device

! CAUTION

Configure the serial line for the peripheral (See 8.3).

REMARK See C1.2 for the connections on the NUM CNC side.

C.2.1 PC Microcomputer or Compatible

Use a serial link cable in accordance with the instructions below.

C.2.1.1 Numerical Control / Microcomputer Link

MICROCOMPUTER
9- or 25-contact female
Sub.D connector

NUM CN
9-, 15- or 25-contact male
Sub.D connector

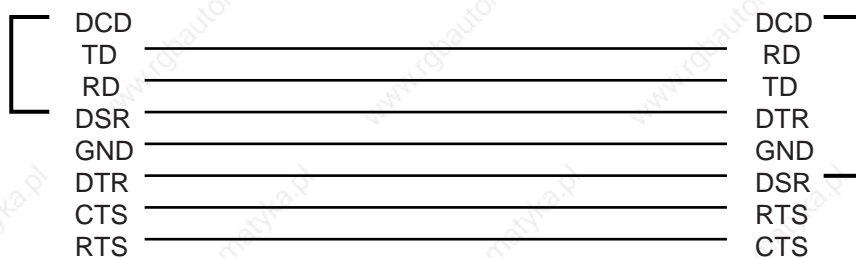

Signal	Contact on 9-contact Sub.D (PC side)	Contact on 25-contact Sub.D (PC side)
DCD	1	8
RD	2	3
TD	3	2
DTR	4	20
GND	5	7
DSR	6	6
RTS	7	4
CTS	8	5

C

C.2.1.2 Setting up the Link

Connect the microcomputer serial port to a serial line of the CNC.

Set the serial line parameters (See table below).

	Start bits	Data bits	Stop bits	Parity
CNC side (See 8.3)	1	8	1	none
PC side	1	7	1	even

Start transferring files on the microcomputer
(The procedure varies with the software used).

Use of APA 10

Procedure described in the manual "APA 10 - PLC PROGRAMMING AID SOFTWARE FOR IBM PC/PS AND COMPATIBLE".

Use of NUM TRAINING PACKAGE

Procedure described in the manual "NUM TRAINING PACKAGE - OPERATOR MANUAL".

Use of communication software

This procedure is described in the documentation for the software used.

For the NUM PLCTool software, See PLCTool Ladder Language Programming Tool manual.

C.2.2 Tape Reader/Punch

Use a serial link connecting cable in accordance with the instructions of Sections C.1.3 and C.1.4, and with the peripheral device documentation.

C.2.2.1 Numerical Control / Peripheral Device Connection

Tape Readers

Type of reader	Recommended data rate
GNT 27	9600 bauds
GNT 28	
ZIP 30 TERMINAL	300 bauds

Tape Punches

Type of puncher	Recommended data rate
GNT 3601	600 bauds
FACIT	600 bauds

C.2.2.2 Numerical Control / Peripheral Device Connection

Connection to GNT tape reader

TAPE READER
25-contact male Sub.D
connector

NUM CNC
9-, 15- or 25-contact male Sub.D
connector

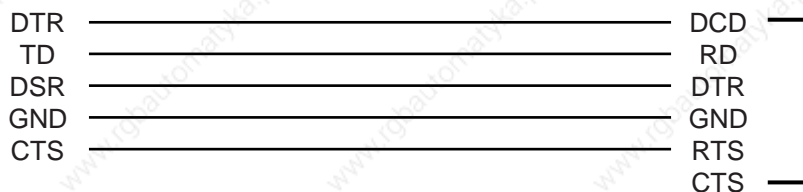

Signal	25-contact Sub.D (GNT side)
TD	2
DTR	20
GND	7
DSR	6
CTS	5

Connection to ZIP 30 terminal

TERMINAL
25-contact male Sub.D
connector

NUM CNC
9-, 15- or 25-contact male Sub.D
connector



Signal	25-contact Sub.D (ZIP 30 side)
TD	2
RD	3
DTR	20
GND	7
CTS	5
DCD	8

C

Connection to GNT punch

PUNCH
25-contact male Sub.D
connector

NUM CNC
9-, 15- or 25-contact male Sub.D
connector

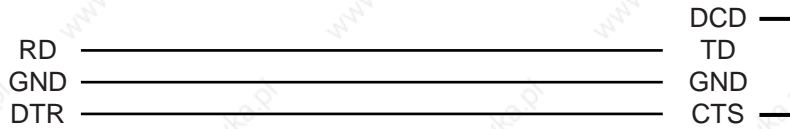

Signal	25-contact Sub.D (GNT side)
RD	3
DTR	20
GND	7

Connection to FACIT punch

PUNCH
25-contact male Sub.D
connector

NUM CNC
9-, 15- or 25-contact male Sub.D
connector



Signal	25-contact Sub.D (FACIT side)
RD	14
GND	25

C.2.2.3 Setting up the Link

Connect the tape reader/punch to a serial line of the CNC.

Start the transfer on the tape reader/punch
(See peripheral device documentation).

C.2.3 NUM Diskette Drive

A serial link cable is included in the supply of the NUM diskette drive. A customised cable can also be used (See C.1).

Connect the NUM diskette drive to a serial line of the CNC and a power supply (See C.1.1).

Set the serial line parameters for the diskette drive (See 8.3):

Item	Recommended value	Other possible values
Line number	Select the line number	
Standard	RS422	
Input speed	19200	9600
Output speed	19200	9600
Number of start bits	1	
Number of data bits	8	
Number of stop bits	1	
Parity	None	
Protocol	Kermit	
Flow control	None	
Logical name	Give a name to the line (e.g. Disk)	

Confirm the Kermit link.

C.2.4 Printer



CAUTION

On the printer, select the EPSON emulation.

Use a serial link connecting cable in accordance with the instructions of sections C.1.3 and C.1.4, and with the printer documentation.

C.2.4.1 Printers Recommended by NUM

Type of printer	Remarks
EPSON LX80	
EPSON RX80	
EPSON EX800	
BROTHER M1818	Colour printer (80 columns)
BROTHER M1819	Colour printer (132 columns with CK100 Kit)
BROTHER M2518	Colour printer with serial link interface option
BROTHER HL-8E	

C.2.4.2 Numerical Control / Printer Connection

PRINTER
Sub.D connector
25 male contacts
or DIN 6 male contacts

NUM CNC
Sub.D connector
25 male contacts

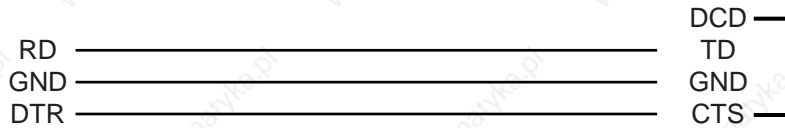

Signal	DIN 6-contact plug (EPSON EX800)	25-contact Sub.D
RD	3	3
GND	5	7
DTR	2	20

C.2.4.3 Setting up the Link for Printing

Actions

- Connect the printer to a serial line of the CNC.
- Configure the printer: RS 232 serial link, 9600 bauds, 7 data bits and 1 parity bit.
- Carry out the printing procedure (See printer documentation).

C.2.4.4 Setting up the Link for Hard Copy

Actions

- Connect the printer to a serial line of the CNC.
- Configure the printer: RS 232 serial link, 9600 bauds, 8 data bits and no parity bit.
- Carry out the printing procedure (See printer documentation).

C.3 Connection to a Computer

Two types of connections are possible:

- to a host computer,
- to a microcomputer PC or compatible.

Use a serial link connecting cable in accordance with the instructions of Section C.1 and with the computer documentation.

CAUTION

Configure the serial line for the peripheral (See 8.3).

C.3.1 Setting up the Link

Connect the computer to a serial line of the CNC.

Set the serial line parameters:

	Start bits	Data bits	Stop bits	Parity
CNC side (See 8.3)	1	8	1	none
PC side	1	7	1	even

Carry out the connecting procedure on the computer side.

REMARKS *The connecting procedure on the computer side depends on the communication protocol used between the numerical control and the computer.*

Machine parameters P37, P38 and P39 must be adapted to the computer (See parameter manual).

C.3.2 Communications with the Computer

Loading or unloading data from a computer requires a dialogue between the numerical control and the computer.

The procedure below describes the guidelines for the dialogue, but the operational details depend on the communication protocol set up (See computer manual and DNC1 manual for use of the NUMDNC application).

Requirements

Connection procedure carried out on computer side (See C.3.1).

"FILE LOADING" menu (See 5.4.1) or "FILE UNLOADING" menu (See 5.6) displayed.

Actions

Select the DNC line.



Select "COMMUNICATIONS".

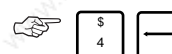

The cursor goes to the line:

4 COMMUNICATIONS

Set up the link with the computer.



Display of the «INCYC» indicator in the status window (See 3.1.3).

Display of the message:

LOGIN WITH HOST COMPUTER
(BREAK=SHIFT-P , EXIT=XOFF)

Establish the communication.



From then on, the numerical control guides the computer.

Depending on the communication protocol:

- request for password,
- display of a menu....

Carry out the actions specified by the protocol.

The serial link authorises the following operations:

- consultation of the list of files contained in a directory on one of the computer disk drives,
- selection of a file containing the programme(s) or the tool dimensions to be loaded (computer to CNC),
- selection of a name for a file in which the data is to be downloaded (CNC to computer),
- interruption of the serial link and release of the computer.

Carry out the required operations (depending on the protocol).

After selection of a file to be loaded or unloaded:

Interrupt the communication with the computer.



The "INCYC" indicator disappears and the "FILE LOADING" or "FILE UNLOADING" menu is displayed.

Exit from the Procedure

After completing all the loading/unloading operations from the computer, it is necessary to close down the line.

"FILE LOADING" or "FILE UNLOADING" menu displayed:

Select "COMMUNICATIONS".

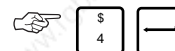

Set up the link with the computer.



Select the end of the procedure.

The connection is cleared.

Interrupt dialogue with the computer.



Return to the "FILE LOADING" or "FILE UNLOADING" menu.

Appendix D Information Concerning the Exchange Area Bit

The table below gives the Ladder addresses of the bits in the exchange area corresponding to the mnemonics of the data mentioned in the manual.

Mnemonic	Identification	Address of the bit
AUTAV	General feed authorisation	%W4.0 (bit of value 1 of byte %W4.B)
CRM1	M function report - group 1	%W100.5 (bit of value 32 of byte %W100.B)
CRM2	M function report - group 2	%W200.5 (bit of value 32 of byte %W200.B)
CRM3	M function report - group 3	%W300.5 (bit of value 32 of byte %W300.B)
CRM4	M function report - group 4	%W400.5 (bit of value 32 of byte %W400.B)
CRM5	M function report - group 5	%W500.5 (bit of value 32 of byte %W500.B)
CRM6	M function report - group 6	%W600.5 (bit of value 32 of byte %W600.B)
CRM7	M function report - group 7	%W700.5 (bit of value 32 of byte %W700.B)
CRM8	M function report - group 8	%W800.5 (bit of value 32 of byte %W800.B)
C_AUTAV1	Feed authorisation - group 1	%W100.0 (bit of value 1 of byte %W100.B)
C_AUTAV2	Feed authorisation - group 2	%W200.0 (bit of value 1 of byte %W200.B)
C_AUTAV3	Feed authorisation - group 3	%W300.0 (bit of value 1 of byte %W300.B)
C_AUTAV4	Feed authorisation - group 4	%W400.0 (bit of value 1 of byte %W400.B)
C_AUTAV5	Feed authorisation - group 5	%W500.0 (bit of value 1 of byte %W500.B)
C_AUTAV6	Feed authorisation - group 6	%W600.0 (bit of value 1 of byte %W600.B)
C_AUTAV7	Feed authorisation - group 7	%W700.0 (bit of value 1 of byte %W700.B)
C_AUTAV8	Feed authorisation - group 8	%W800.0 (bit of value 1 of byte %W800.B)
C_FMEXT1	End of external movement - group 1	%W100.1 (bit of value 2 of byte %W100.B)
C_FMEXT2	End of external movement - group 2	%W200.1 (bit of value 2 of byte %W200.B)
C_FMEXT3	End of external movement - group 3	%W300.1 (bit of value 2 of byte %W300.B)
C_FMEXT4	End of external movement - group 4	%W400.1 (bit of value 2 of byte %W400.B)
C_FMEXT5	End of external movement - group 5	%W500.1 (bit of value 2 of byte %W500.B)
C_FMEXT6	End of external movement - group 6	%W600.1 (bit of value 2 of byte %W600.B)
C_FMEXT7	End of external movement - group 7	%W700.1 (bit of value 2 of byte %W700.B)
C_FMEXT8	End of external movement - group 8	%W800.1 (bit of value 2 of byte %W800.B)
C_UNIT	Units of displayed dimensions (mm or inches)	%W4.5 (bit of value 32 of byte %W4.B)
NARFIB	No stop at end of block	%W4.3 (bit of value 8 of byte %W4.B)

