



DIAX03 DDS02.2/03.2 Drive Controller - Basic Unit

Project Planning Manual

DOK-DIAX03-DDS02.2/3.2-PRJ1-EN-P



Title	DIAX03 DDS02.2/03.2 Drive Controller - Basic Unit
Type of documentation	Project Planning Manual
Document code	DOK-DIAX03-DDS02.2/3.2-PRJ1-EN-E1,44 • 04.97
Internal file reference	<ul style="list-style-type: none"> • Mappe 11a • DDS_2-PJ.pdf • 209-0075-4310-00
Reference	This electronic document based on the hardcopy document with document desig.: DOK-DIAX03-DDS02.2/3.2-PRJ1-EN-P

Editing sequence

Document designations of previous editions	Status	Comments
DOK-DIAX03-DDS02.2/3.2-PRJ1-EN-P	Jan. 97	1st release DDS02.2/03.2
DOK-DIAX03-DDS02.2/3.2-PRJ1-EN-E1,44	Apr. 97	First E-Doc.

Copyright

© INDRAMAT GmbH, 1997

Copying this document, and giving it to others and the use or communication of the contents thereof without express authority, are forbidden. Offenders are liable for the payment of damages. All rights are reserved in the event of the grant of a patent or the registration of a utility model or design (DIN 34-1).

The electronic documentation (E-doc) may be copied as often as needed if such are to be used by the consumer for the purpose intended.

Published by

INDRAMAT GmbH • Bgm.-Dr.-Nebel-Str. 2 • D-97816 Lohr a. Main
Telefon 09352/40-0 • Tx 689421 • Fax 09352/40-4885
Abt. ENA (JH)

Service-Hotline: Tel. **0172 - 660 040 6** or **0171 - 333 882 6**

Validity

All rights are reserved with respect to the content of this documentation and the availability of the product.

Contents

1	Introducing the system	1-1
1.1	Individual components of the digital AC servo drives.....	1-2
1.2	Supply units for DDS02.2/03.2 drive controllers.....	1-2
2	Safety guidelines for electrical drives	2-1
2.1	General information.....	2-1
2.2	Guidelines for protection against contact with electrical parts	2-2
2.3	Guidelines on "protective low voltages"	2-3
2.4	Guidelines for protection against dangerous movements.....	2-3
2.5	Guidelines for protection when handling and installing	2-5
3	DDS02.2/03.2 Drive Controllers	3-1
3.1	Configured drive controllers	3-1
3.2	Drive controller - basic unit.....	3-4
	Cooling methods.....	3-4
3.3	Software module	3-7
	Firmware.....	3-7
3.4	Firmware configuration.....	3-9
3.5	Plugin modules.....	3-10
3.6	Configuration Rating Plates.....	3-12
3.7	Summary of components inserted in a configuration	3-13
4	Technical Data	4-1
4.1	Power section.....	4-1
4.2	Current consumption of the signal processing devices.....	4-2
4.3	Ambient and environmental conditions	4-4
4.4	Drive controller energy loss.....	4-5
	Energy loss in a DDS02.2-W.....	4-5
	Energy loss in a DDS02.2-A.....	4-6
	Energy loss in a DDS02.2-F.....	4-7
	Energy loss in a DDS03.2-W.....	4-8
4.5	Weight.....	4-8
5	Planning the construction of the control cabinet	5-1
5.1	Mounting the DDS02.2-W... drive controller.....	5-4
5.2	Mounting the DDS02.2-A... drive controller	5-5
5.3	Mounting the DDS02.2-F... drive controller	5-10
5.4	Mounting a DDS03.2-W...- drive controller	5-12
5.5	Interference suppression and EMC.....	5-13

5.6 Using heat-exchanger units in control cabinets	5-13
6 Electrical connections of the drive controller	6-1
6.1 General notes.....	6-1
6.2 Connecting the basic unit.....	6-2
① Chassis earth connections to the supply unit	6-4
②③④ Connecting the motor power cable to the drive controller.....	6-4
④ Connector X6: Holding brake, Motor temperature monitor.....	6-7
⑤ DC bus voltage connection.....	6-7
⑥ Connector X1: Bus connection	6-8
⑦ Connector X3.....	6-9
⑧ Connector X2: RS232-interface.....	6-11
⑨ Connector X4: Motor feedback.....	6-12
⑩ Connector X13, X14a, X14b: Heatsink blower only with DDS02.2-A.....	6-14
Terminal diagram overview	6-15
6.3 Connecting the plugin modules	6-16
7 Accessories	7-1
7.1 Electrical accessories kit E..-DDS 2.....	7-2
7.2 Electrical accessories kit E..-DDS 3.....	7-4
7.3 Connector kit for various configurations.....	7-6
7.4 Service cable IKS0391	7-7
7.5 Selecting the fiber optic cable connections (LWL)	7-7
7.6 Mechanical accessories for DDS02.2-A***-*	7-8
7.7 Mechanical accessories for DDS02.2-F***-* drive controllers (Liquid cooling)	7-9
8 Powering up the power sections using charging resistors	8-1
9 Condition at delivery	9-1
10 Identifying the merchandise	10-1
11 Storage and Transport	11-1
12 Index	12-1

1 Introducing the system

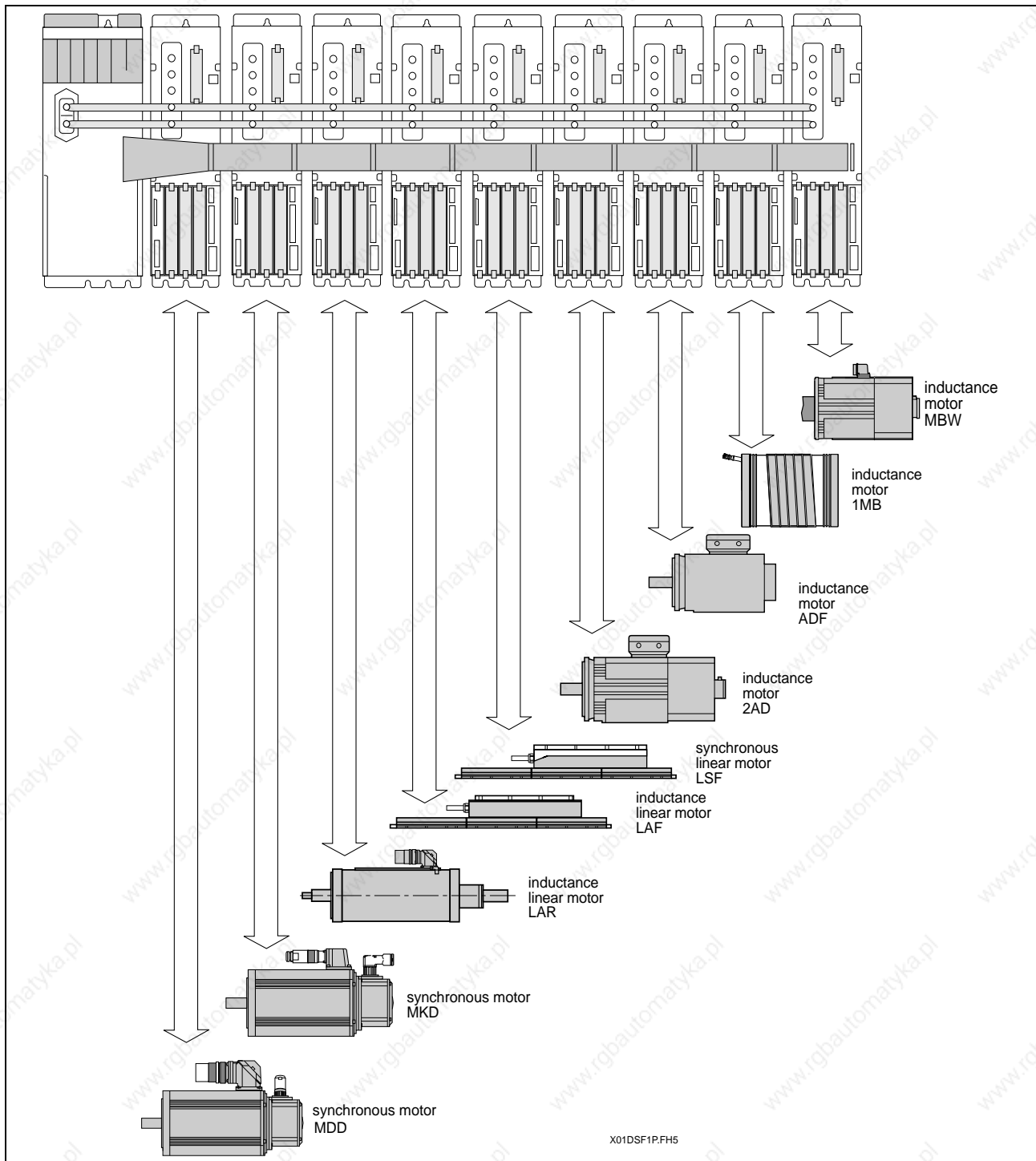

Fig. 1-1: digital drive system with DDS

The modular concept makes it possible to flexibly combine AC servo and main drives to create one compact drive package which uses one supply unit.

In conjunction with the AC motors MDD, MKD, LAR, LAF, LSF, 2AD, ADF, 1MB and MBW, the DDS drive controller is a rapid response drive. These drives are particularly well suited for use in textile, printing and packaging machines as well as robotics and handling machines.

1.1 Individual components of the digital AC servo drives

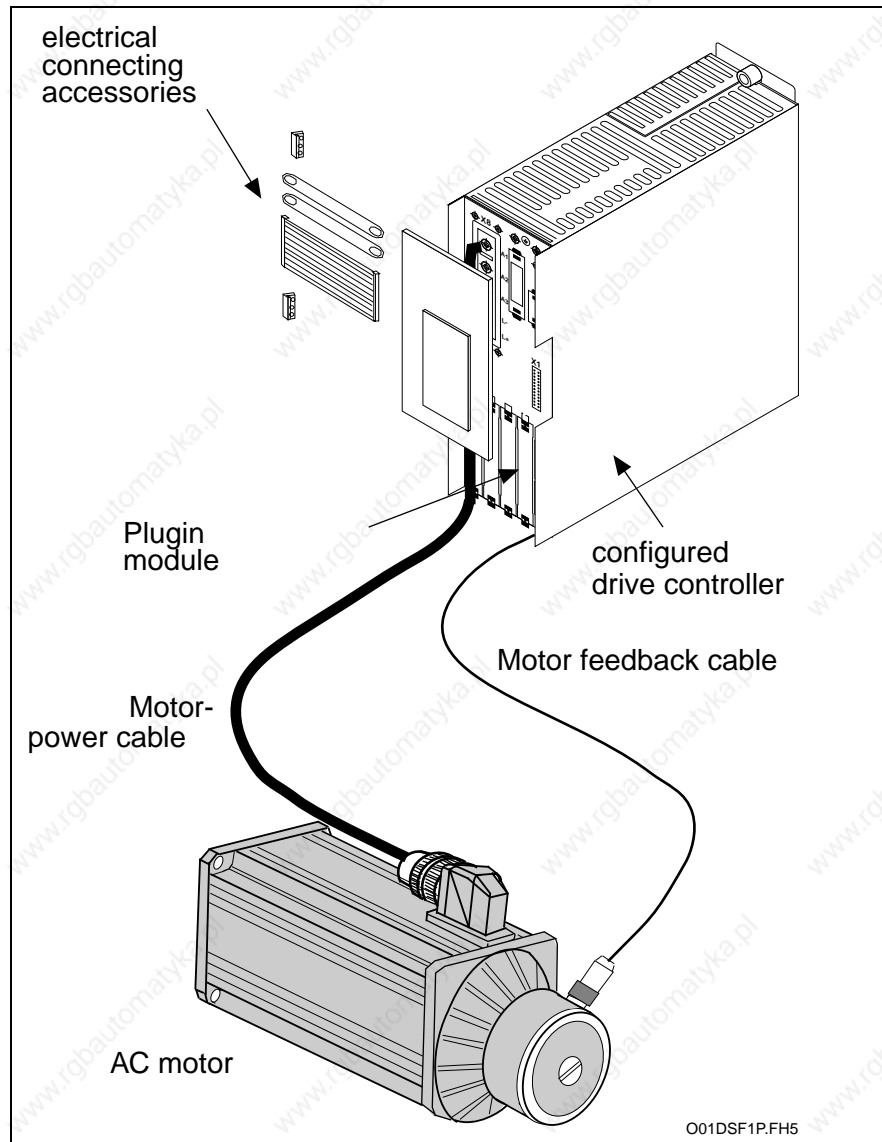

Fig. 1-2: Individual components of a digital AC drive

1.2 Supply units for DDS02.2/03.2 drive controllers

DDS drive controllers can be connected to all INDRAMAT supply units with a regulated DC 24V voltage.

Note: Do not operate the DDS with a TVM 1.2 supply unit. The DC 24 volts of the TVM 1.2 are not regulated.

If TVM 2.1, TVM 2.4 or KDV 1.3 supply units are used with a DDS drive controller, then note the information in Section 8 when powering up the power section via charging resistors. The application description for each individual supply unit must also be noted.

2 Safety guidelines for electrical drives

Prior to using the units, please note the following guidelines on personnel safety.

2.1 General information

- The safety instructions in these user guidelines must be observed at all times. Improper use of this equipment and disregarding the warnings given here can lead to property damage, cause bodily injury or, in extreme cases, lead to death.

INDRAMAT is not liable for damages resulting from non-compliance with the warning given herein.

- Documentation in the local language must be obtained prior to commissioning, if the language of the documentation at hand is not understood.
- Proper transport, correct storage, assembly and installation as well as careful operation are the prerequisites for optimal and safe operation of this equipment.
- Qualified personnel:

Only correspondingly qualified personnel may work on this equipment or within its vicinity. Personnel are qualified if they have sufficient knowledge of assembly, installation and operation of the product as well as of all warnings and safety measures in these operating instructions.

Furthermore, they should be trained, instructed or qualified to switch electrical circuits and equipment on and off, to earth and label them according to safety regulations. Personnel should have adequate safety equipment and be trained in first aid.

- Only use spare parts approved by the manufacturer.
- The safety instructions and regulations for the application must be observed.
- The equipment is designed for installation in machines which are intended for commercial use.
- Startup is only permitted once it is certain that the machine in which the products are installed complies with EC directive 89/392/EWG (machine directives).
- Operation is only permitted if the national EMC directives for the specific application permit it. Within the EU, EMC directive 89/336/EWG applies.

Guidelines for EMC compliant installation are outlined in the document "EMC for AC drives and controls".

Maintaining the national standards is the responsibility of the manufacturer of the machine or plant.

- Technical data, connection and installation conditions are outlined in the respective product documentation and must be maintained.

2.2 Guidelines for protection against contact with electrical parts

If live parts with voltages exceeding 50 volts are in any way exposed and could lead to possible contact, then this could lead to bodily injury. To operate electrical equipment it is necessary to apply certain parts of it with such dangerous voltages.



DANGER

High electrical voltage!

Danger to life and risk of injury!

- ⇒ Observe the general construction and safety guidelines for work on electrical power installations.
- ⇒ After installation, check that the earth wire is permanently connected to all electrical units as specified in the connection diagram.
- ⇒ Operation, even for brief measuring and test purposes, is only permitted when the earth wire is permanently connected to all electrical components.
- ⇒ Disconnect the equipment from the mains or the voltage source before working on electrical parts with voltage levels exceeding 50 volts. Secure the equipment against being switched back on.
- ⇒ Wait five minutes after powering down before starting work on the equipment. This is due to the capacitors fitted in the equipment.
- ⇒ Do not touch the electrical connecting points of a component while power is on.
- ⇒ Cover live parts properly before switching the equipment on so that no contact is possible.
- ⇒ Provide protection against indirect contact (as per DIN EN 50178/ed.11.94, sect. 5.3.2.3).



WARNING

High discharge current!

Danger to life and risk of serious injury!

- ⇒ All units and the motor are to be connected to the earth wire at the earthable point or they must be earthed first before switching on.
- ⇒ The discharge current exceeds 3.5 mA. A permanent connection to the supply system is thus required for all units (per DIN EN 50178/edition 11.94, sect. 5.3.2.3).
- ⇒ Always connect earth wire before starting up even when just testing. High voltages could otherwise be applied to the housing.

2.3 Guidelines on "protective low voltages"

The connections on the drive components and interfaces for the signal voltages range from five to 30 volts. These electrical circuits belong to the safely isolated electrical circuits (protective low voltages).



WARNING

High electrical voltage from incorrect connections!

Danger to life and limb or serious bodily injury!

⇒ Only those units, electrical components or cables which have, as per the standards, sufficient and safe isolation of connected electrical circuits may be attached to the signal voltages (per DIN EN 50178/edition 11.94, sect. 5.3.2.3).

2.4 Guidelines for protection against dangerous movements

Dangerous movements can occur for various reasons:

- as a result of an incorrect velocity command
- a software error
- physical component problems
- faulty wiring or cabling
- an error in the value or signal encoder and
- incorrect use of components

These errors can occur just after the equipment is turned on or after an indefinite period of time.



Dangerous movements!

Danger to life and risk of injury or of property damage!

- ⇒ The drive component monitoring devices make malfunctions in the connected drives almost impossible. In view of operator safety, however, this cannot be solely relied upon. An incorrect movement, the size of which depends on the kind of malfunction and operating status, must in any case be anticipated before the built-in monitoring devices are activated. Operator safety must thus be ensured with the use of monitoring devices or measures taken which are superordinate on the plant side. These are provided, according to the specific conditions of the plant, after a danger and error analysis by the plant constructor has been completed. The safety requirements which apply to the plant are included here.
- ⇒ Keep clear of the machine in that area in which movements could occur. Possible measures to take to prevent access are:
 - protective fences
 - protective railings
 - covers
 - light barriers
- ⇒ Fences and coverings should have sufficient strength to withstand the maximum possible momentum.
- ⇒ E-stop switches must be mounted in the immediate vicinity of an operator for easy reach. Check to make sure it is functional before starting up.
- ⇒ Isolate the drive power connection via an emergency stop circuit or use a starting lockout to protect against unintentional startups.
- ⇒ Make sure that the drives are standing still before accessing or entering the danger zone.
- ⇒ De-energize electrical equipment using the master switch and secure against switching on again for:
 - maintenance and repair work
 - cleaning work
 - or prior to long breaks in operation
- ⇒ Avoid operating high-frequency, remote-control and radio equipment near the electronics and supply lines. If use of such a unit cannot be avoided, check the system and plant for possible malfunctions at all positions of general use before starting up. If necessary, carry out a special EMC test on the plant.

2.5 Guidelines for protection when handling and installing



CAUTION

Risk of injury during handling!

Bodily injury caused by crushing, shearing, cutting and thrusting movements is possible!

- ⇒ Observe the general construction and safety regulations for handling and installation.
- ⇒ Use suitable installation and transport equipment in a proper fashion. If necessary, use special tools.
- ⇒ Take suitable precautions to prevent pinching and crushing.
- ⇒ If necessary, wear suitable protective clothing such as protective eyewear, shoes or gloves.
- ⇒ Do not stand under suspended loads.
- ⇒ Wipe up liquids spilled onto the floor to prevent slipping.

3 DDS02.2/03.2 Drive Controllers

3.1 Configured drive controllers

The drive controllers are modular in design. The basic unit is adapted to different functions with the use of various modules. The drive controllers are delivered by INDRAMAT already configured in terms of the desired function.

A configured drive controller is made up of both hardware and firmware. The firmware fixes the functions of the drive controller.

A configured drive controller is made up of:

- a drive controller - basic unit
- plugin modules
- software modules
- firmware (in software and plugin modules)

**Configured drive controller
DDS02.2-****-****-**-FW**

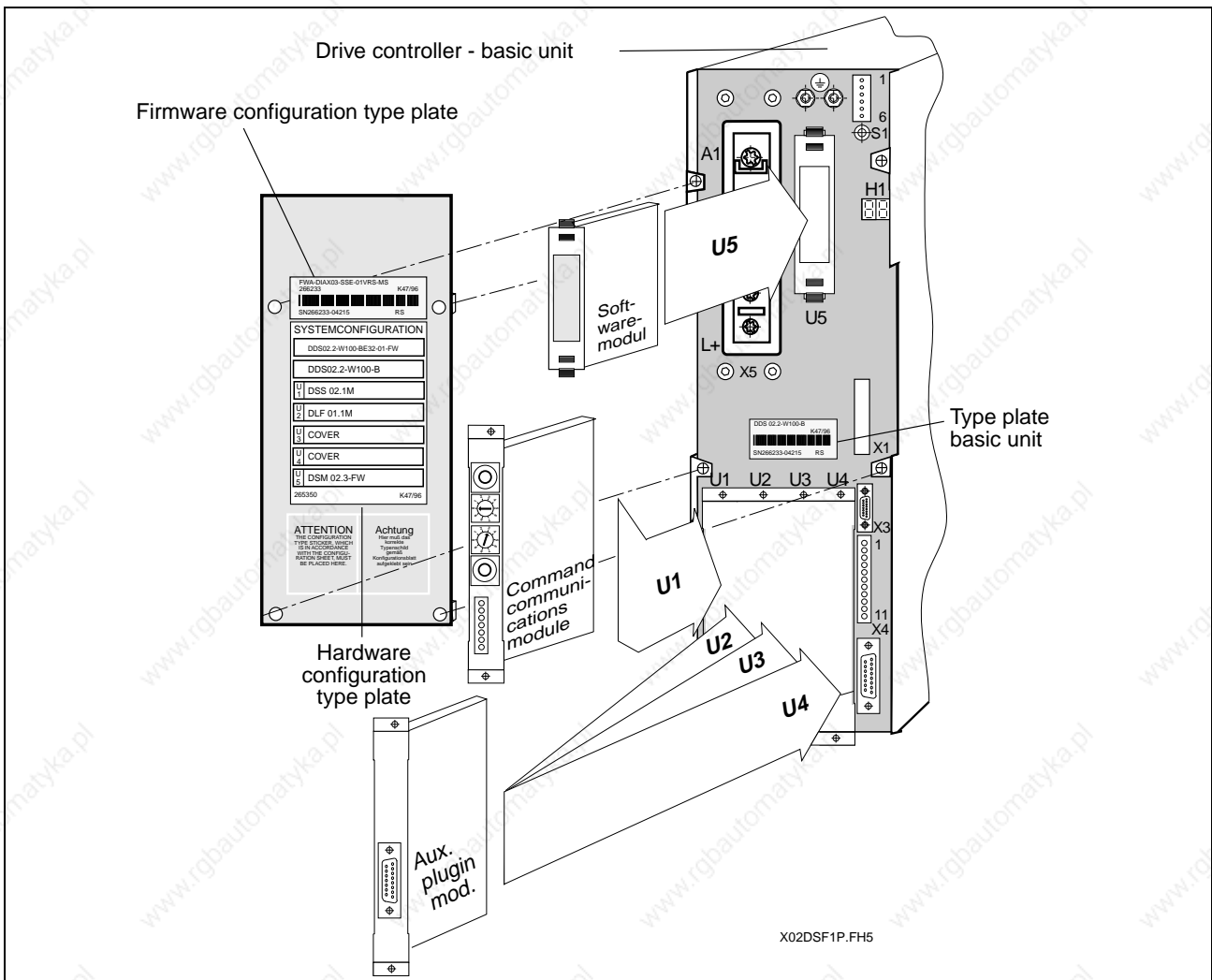

Fig. 3-1: Components of the configured DDS02.2-*** drive controller

**Configured drive controller
DDS03.2-****-****-**-FW**

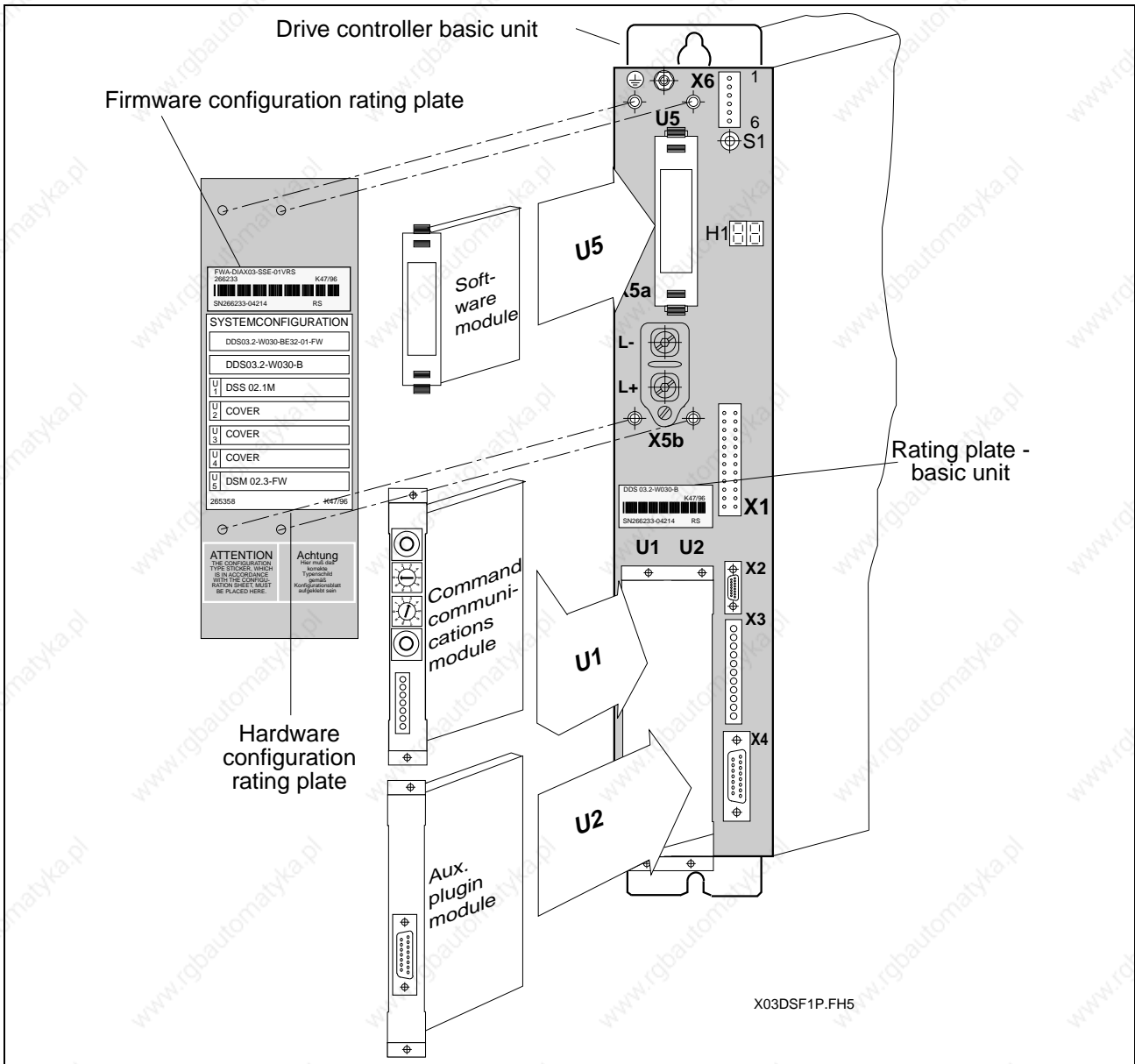

Fig. 3-2: Components of a configured DDS03.2-***

Type codes

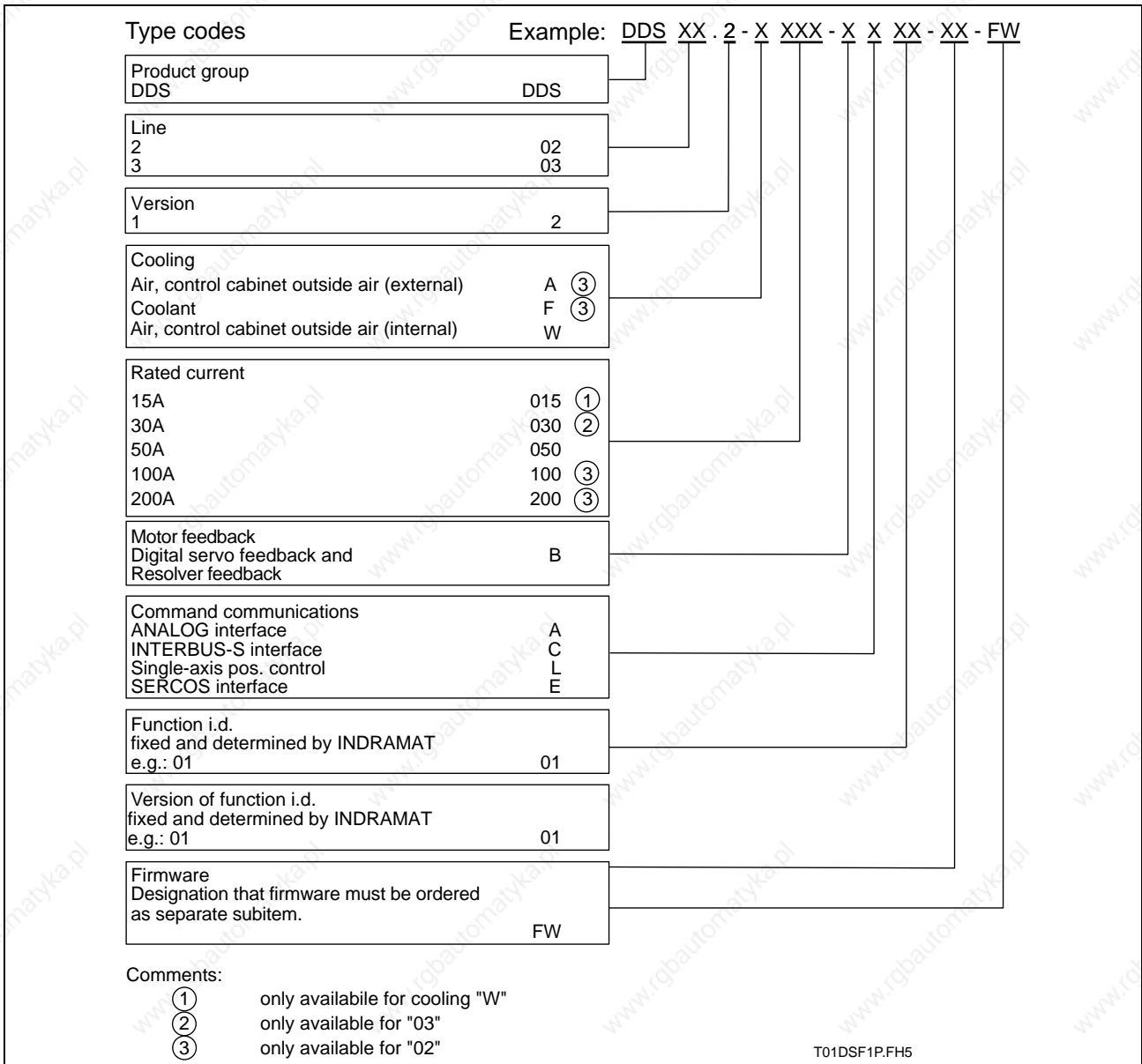

Fig. 3-3: Type codes of a configured DDS drive controller

3.2 Drive controller - basic unit

The slots of the basic unit are empty.

Cooling methods

INDRAMAT offers various cooling methods for the DDS02.2 drive controllers (see Fig. 3-4).

Cooling methods:

- heat technology (airflow inside the control cabinet)
- cold technology (airflow outside the control cabinet)
- liquid cooling (coolant)

Heat technology

Units implementing heat technology dissipate heat within the control cabinet.

Consequently:

- large control cabinet
- and/or air conditioning may be needed.

This requires the least amount of mounting and installation effort, however.

Cold technology, cooling with coolants

The units with cold technology and which use coolants have the advantage that a large part of their heat is dissipated outside the control cabinet. As a result, they can be mounted in small cabinets or housing.

Units cooled with coolants also offer the advantage of regaining lost energy.

Cooling methods

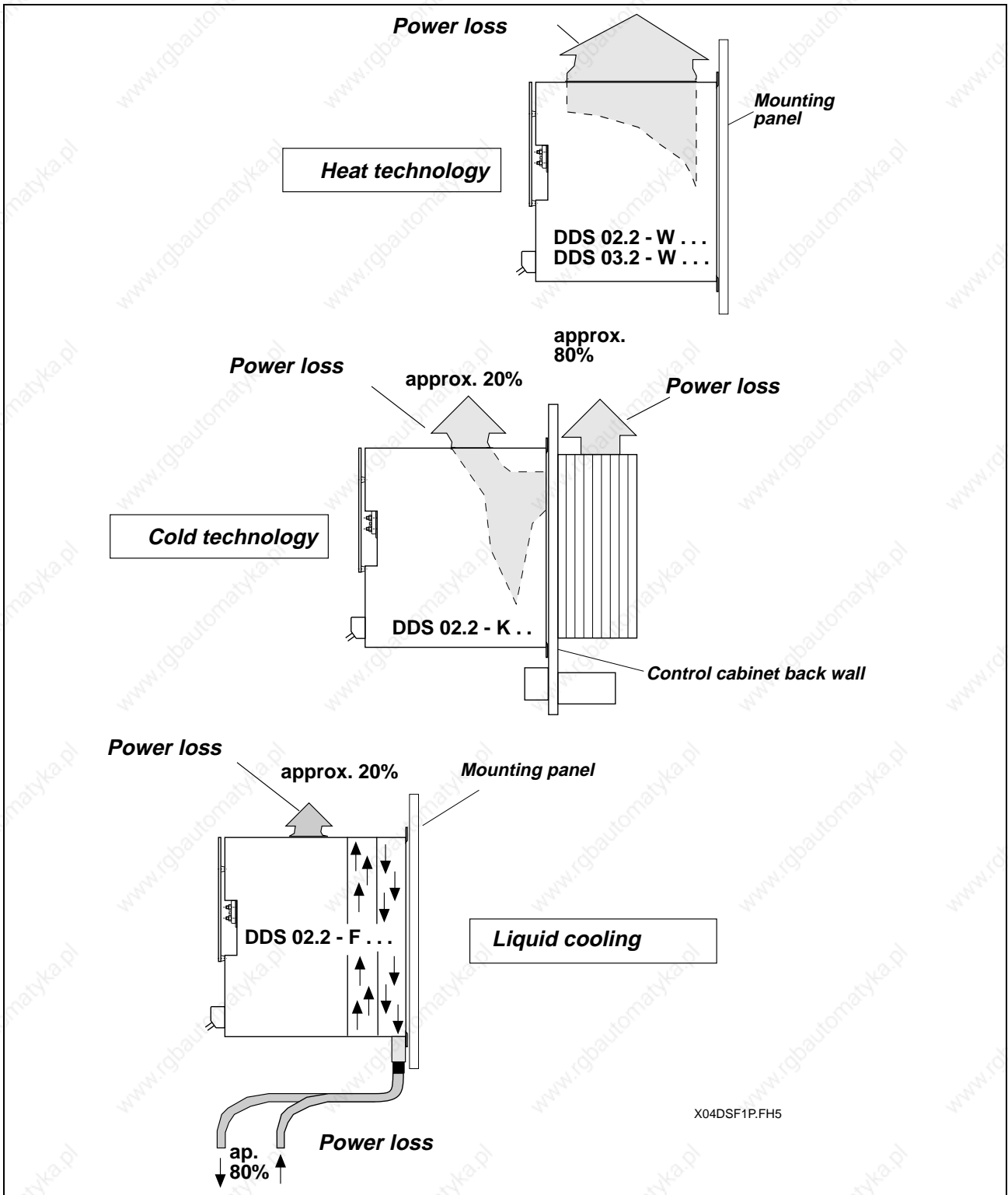

Fig. 3-4: Cooling methods in DDS02.2 drive controllers

Type codes

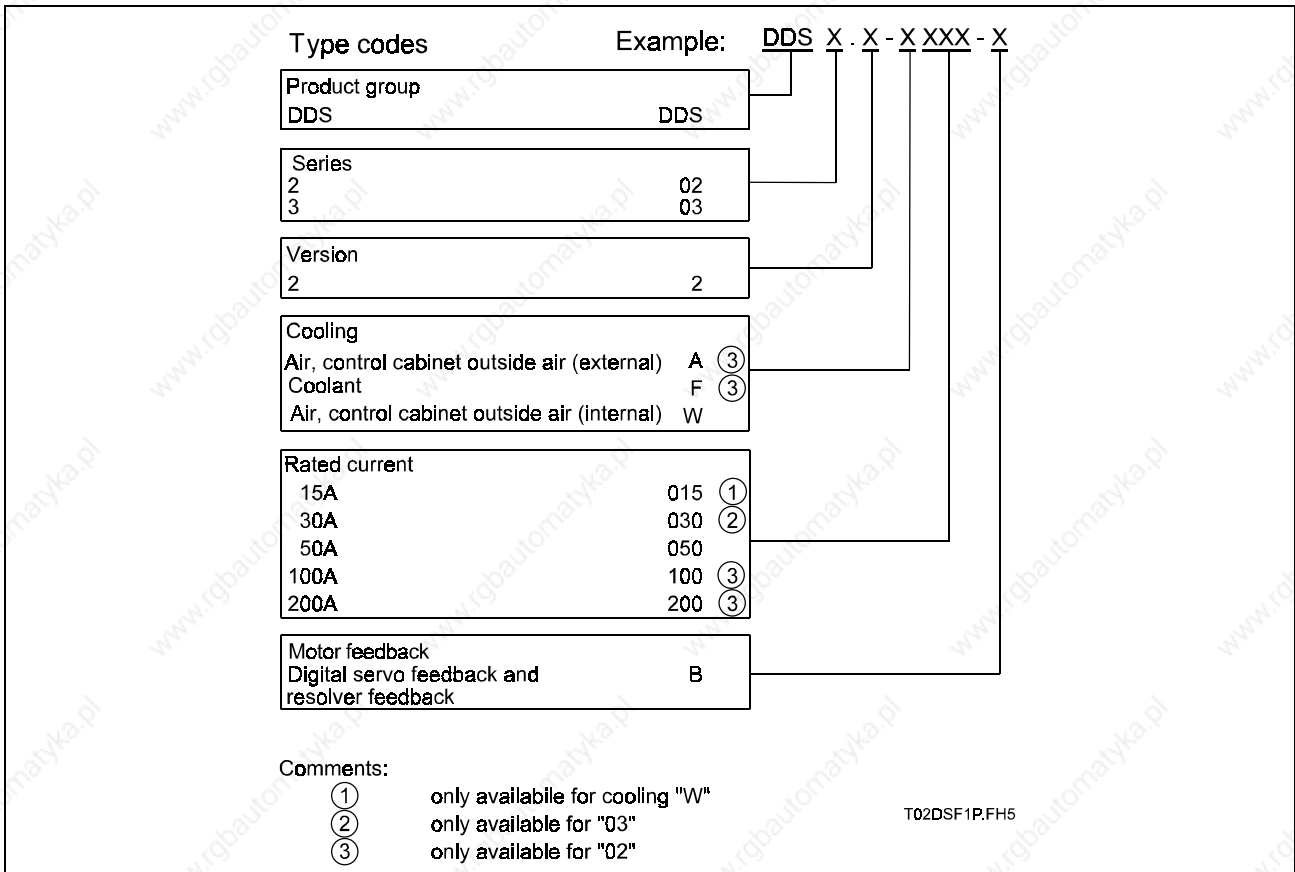

Fig. 3-5: Type codes of the basic DDS unit

3.3 Software module

Different functions require different software modules. The software module contains both firmware and drive parameters. The software module needed depends on the selected hardware configuration and the functions of the drive.

The software module guarantees that if the unit needs to be replaced, the already entered parameters can be carried over to the new unit.

Type codes

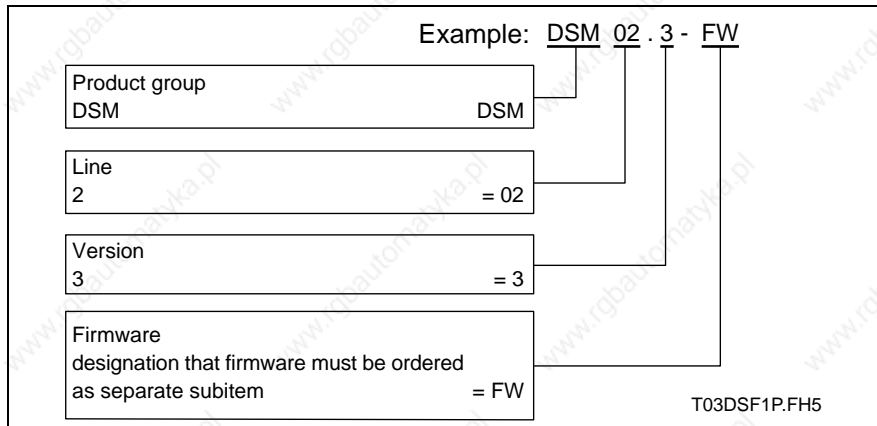

Fig. 3-6: Type codes of the software module

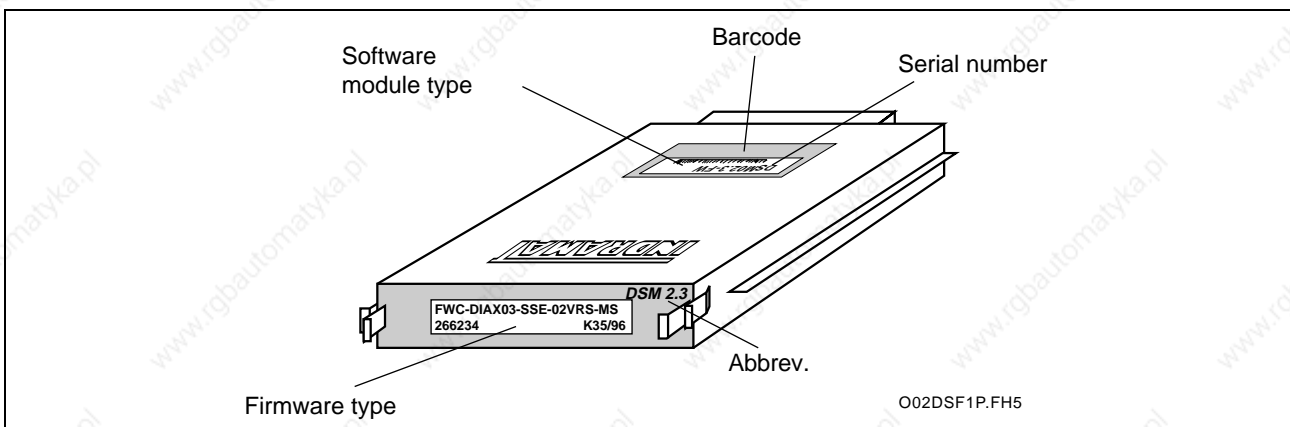

Fig. 3-7: Rating plates on the software module

Firmware

The functional features of the drive controllers are fixed by the firmware.

The firmware must be ordered as a separate item. This means that it is always possible to re-order the same firmware version.

The firmware is continuously being updated to function more accurately without, however, changing the functions. This designation is indicated in the type codes as the firmware release status.

If new functions are added, then the index number of the firmware version is increased (see Fig. 3-8).

Type codes

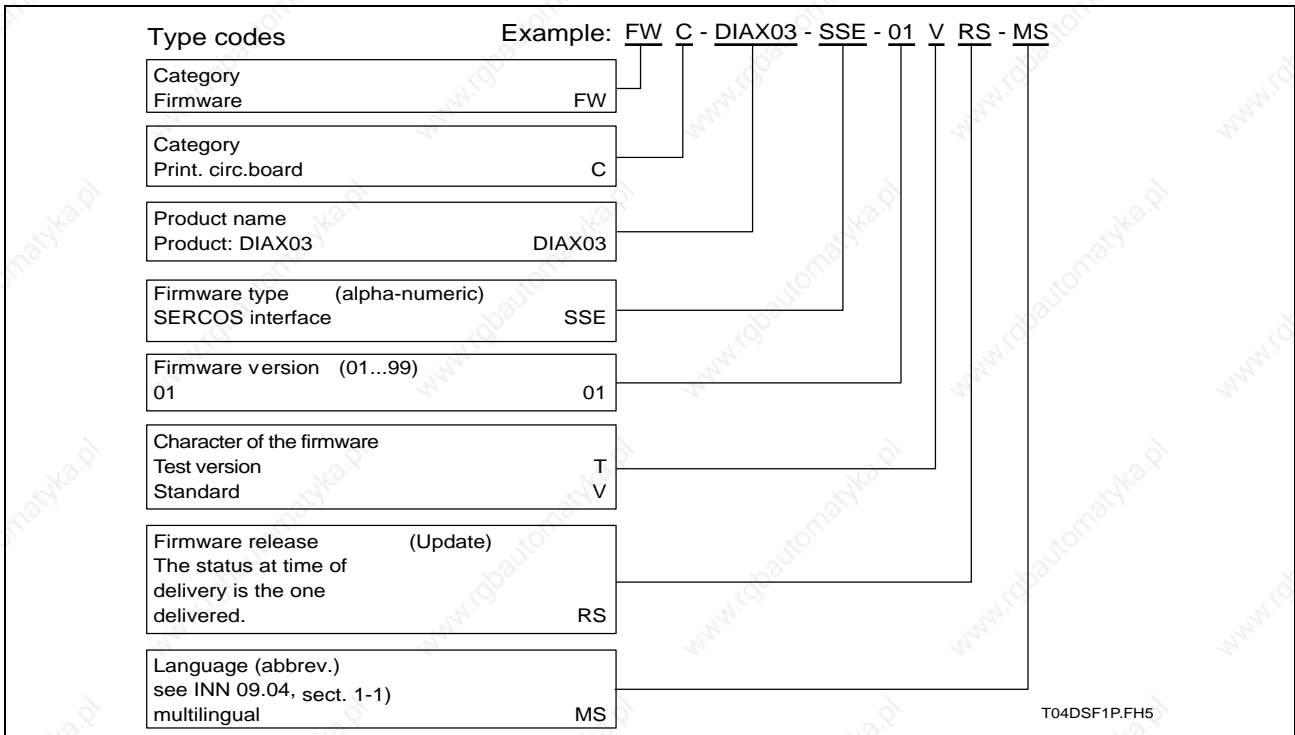

Fig. 3-8: Firmware type codes

3.4 Firmware configuration

The firmware configuration identifies which firmware is used in a configured drive controller.

This means that the firmware configuration is used to determine which firmware the software module has, and, if applicable, which firmware is in a plugin module. The rating plate of the firmware configuration is on the face plate.

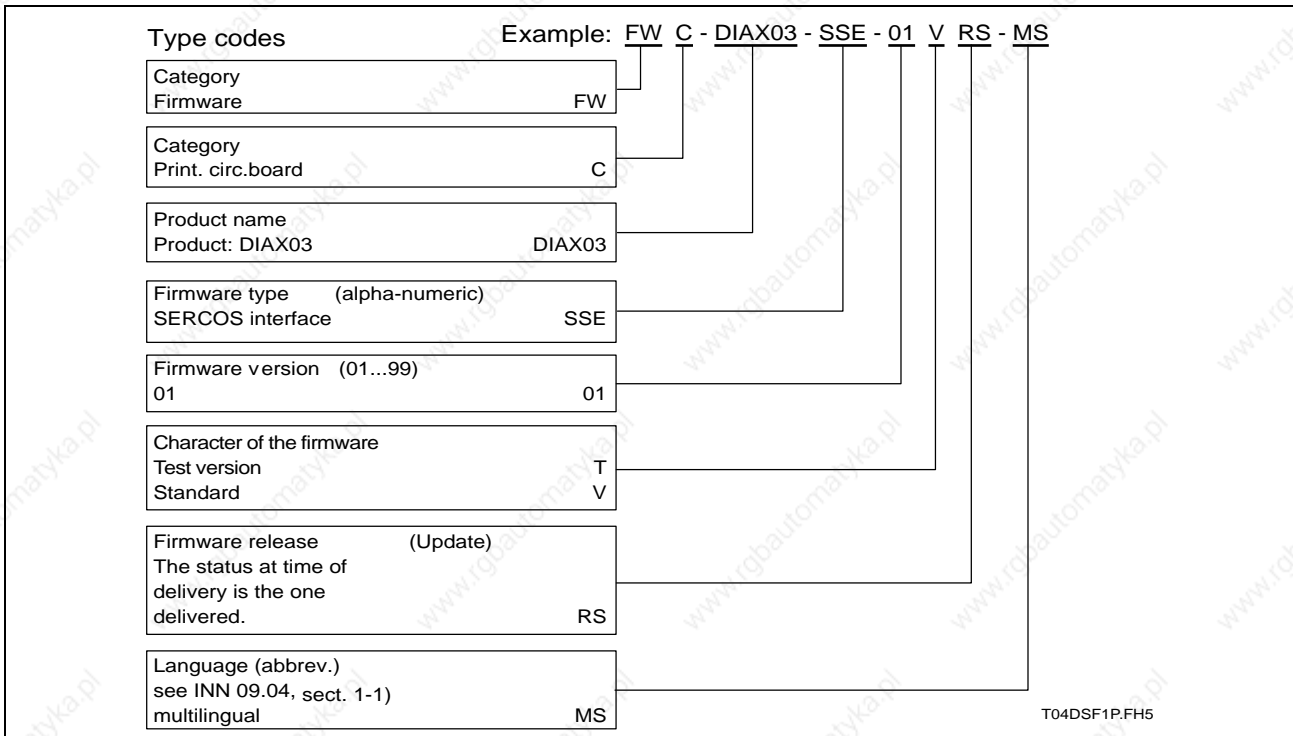

Fig. 3-9: Type codes of the firmware configuration

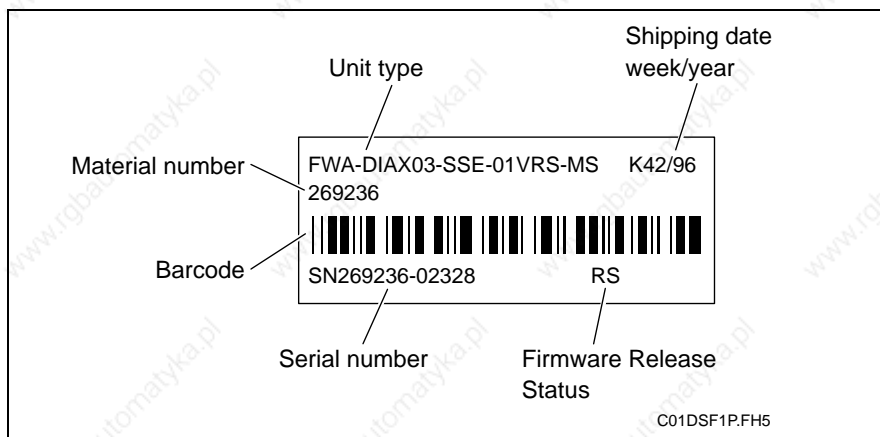

Fig. 3-10: Type plates for the firmware configuration

3.5 Plugin modules

Only a few of the plugin modules are introduced below. The precise functions offered by a specific firmware version are outlined in the respective function description.

SERCOS interface

Type: DSS02.1M

The "SERCOS interface DSS" plugin module makes it possible to operate a digital drive with SERCOS compatible controls via a fiber optic cable. It also offers inputs for evaluating reference switches, travel range limit switches and sensor inputs.

Command card

Type: CLC-...

The CLC-... command card supports the central control of the drive units for the implementation of an "electronic shaft".

Absolute encoder emulator

Type: DSA01.1M

The "absolute encoder emulator" generates absolute actual position values as per SSI standards (synchronous serial interface).

Analog signal interface

Type: DRF01.1M

Plugin module DRF01.1M can function in terms of either:

- an actual position detection via a resolver
- or
- measuring voltages via two differential inputs

Encoder interface for encoders with EnDat interface or synchronous serial interface (SSI)

The encoder interface DAG01.2M evaluates:

- lengths and angle measuring systems with the EnDat bidirectional interface
- and angle measuring systems as per SSI standards

ARCNET coupler card

Type: DAK01.1M

The DAK01.1 is a stackable plugin module of the CLC-D02... command card and represents an interface to an ARCNET bus system.

Input/output interface

Type: DEA04.2M, DEA05.2M, DEA06.2M

These plugin modules have 15 inputs and 16 outputs each via which the drive can exchange binary signals with a PLC. They are differentiated in terms of the address set.

Incremental position interface

Type: DEF01.1M

The "incremental position interface" plugin module supports the transmission of squarewave signals for evaluating an external measuring system directly mounted to the moving machine component in the drive controller.

High-resolution positioning interface

Type: DLF01.1M

The "high-resolution position interface" plugin module supports the transmission of sinusoidal signals for evaluating an external measuring system directly mounted to the moving machine component in the drive controller.

Gearwheel encoder interface

Type: DZF02.1M

The "gearwheel encoder interface" plugin module supports the evaluation of the high-resolution main spindle position encoder.

Gearwheel encoder interface

Type: DZF03.1M

This "gearwheel encoder interface" plugin module supports the evaluation of a gearwheel encoder (e.g., Lenord & Bauer Geber GEL244).

Note: The technical data and the terminal diagrams of the plugin modules can be found in the document "DIAX03 Plugin modules for digital intelligent drive controllers".

3.6 Configuration Rating Plates

The type codes for

- the configured drive controller,
- the basic unit,
- the software module inserted in slot U5
- and the plugin modules inserted in slots U1 to U4

can be found on the rating plate.

These type codes can be used to determine which components are in which slots.

In the event of any problems, these type codes on the rating plate can be used to quickly order the correct replacement parts.

Note: The configuration plate supplies information about which modules are in the drive controller. Please check, before starting up, that all modules are correctly in place.

Note: When mounting the drive controller, the face plate is removed from the controller along with the rating plate. Please make sure that the face plate is remounted to the drive controller from which it was removed.

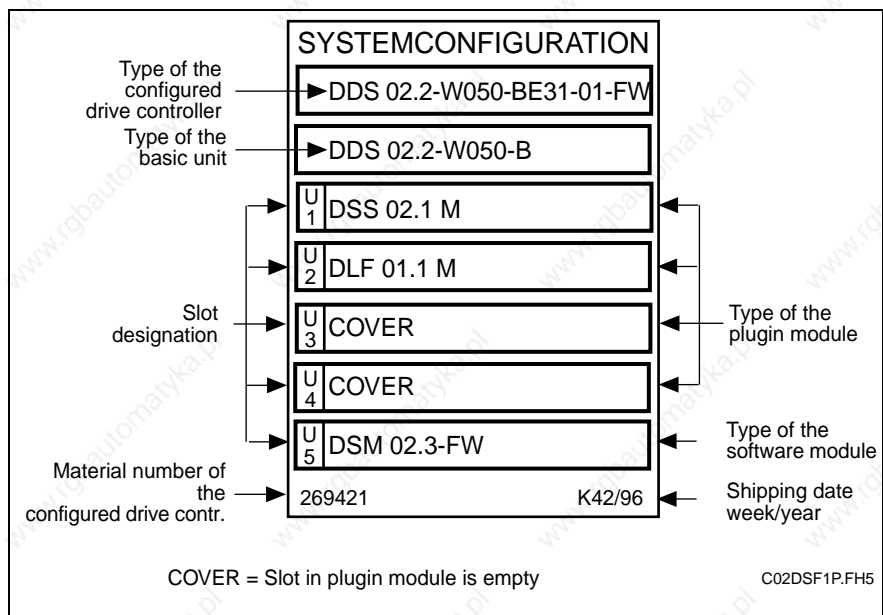

Fig. 3-11: An example of a configuration rating plate

3.7 Summary of components inserted in a configuration

Use this summary to identify which plugin module ought to be in a specific drive controller configuration.

Compare the configuration in the summary with the type of the configured drive controller.

If the suffix of the type designation agrees with a configuration in the summary, then the summary should list what is fitted into slots one through four of the basic unit.

This summary is not a selection list for available configurations.

Configuration	Slot U1	Slot U2	Slot U3	Slot U4	Slot U5
BE01-01-FW	DSS02.1M	DZF02.1M	DFF01.1M	CLC-D02.1M-FW	DSM02.3-FW
BE01-02-FW	DSS02.1M	DZF02.1M	DFF01.1M	CLC-D02.3M-FW	DSM02.3-FW
BE02-01-FW	DSS02.1M	DZF02.1M	DFF01.1M	DAG01.1M	DSM02.3-FW
BE02-02-FW	DSS02.1M	DZF02.1M	DFF01.1M	DAG01.2M	DSM02.3-FW
BE03-01-FW	DSS02.1M	DZF02.1M	DAG01.1M	DEA04.2M	DSM02.3-FW
BE03-02-FW	DSS02.1M	DZF02.1M	DAG01.2M	DEA04.2M	DSM02.3-FW
BE04-01-FW	DSS02.1M	DZF02.1M	DAG01.1M	COVER	DSM02.3-FW
BE04-02-FW	DSS02.1M	DZF02.1M	DAG01.2M	COVER	DSM02.3-FW
BE05-01-FW	DSS02.1M	DRF01.1M	CLC-D02.1M-FW	DAK01.1M	DSM02.3-FW
BE05-02-FW	DSS02.1M	DRF01.1M	CLC-D02.3M-FW	DAK01.1M	DSM02.3-FW
BE05-03-FW	DSS02.1M	DRF01.1M	CLC-D02.3M-FW	DAQ02.1M	DSM02.3-FW
BE06-01-FW	DSS02.1M	DRF01.1M	DEA04.2M	COVER	DSM02.3-FW
BE07-01-FW	DSS02.1M	DLF01.1M	CLC-D02.1M-FW	DAK01.1M	DSM02.3-FW
BE07-02-FW	DSS02.1M	DLF01.1M	CLC-D02.3M-FW	DAK01.1M	DSM02.3-FW
BE07-03-FW	DSS02.1M	DLF01.1M	CLC-D02.3M-FW	DAQ02.1M	DSM02.3-FW
BE08-01-FW	DSS02.1M	DLF01.1M	DFF01.1M	COVER	DSM02.3-FW
BE09-01-FW	DSS02.1M	DFF01.1M	COVER	COVER	DSM02.3-FW
BE10-01-FW	DSS02.1M	DEA04.2M	DSA01.1M	COVER	DSM02.3-FW
BE11-01-FW	DSS02.1M	DFF01.1M	DEA04.2M	CLC-D02.1M-FW	DSM02.3-FW
BE11-02-FW	DSS02.1M	DFF01.1M	DEA04.2M	CLC-D02.3M-FW	DSM02.3-FW
BE12-01-FW	DSS02.1M	COVER	COVER	COVER	DSM02.3-FW
BE13-01-FW	DSS02.1M	DEA04.2M	DFF01.1M	DRF01.1M	DSM02.3-FW
BE14-01-FW	DSS02.1M	DEA04.2M	DRF01.1M	CLC-D02.1M-FW	DSM02.3-FW
BE14-02-FW	DSS02.1M	DEA04.2M	DRF01.1M	CLC-D02.3M-FW	DSM02.3-FW
BE15-01-FW	DSS02.1M	DFF01.1M	DRF01.1M	COVER	DSM02.3-FW
BE16-01-FW	DSS02.1M	DFF01.1M	CLC-D02.1M-FW	COVER	DSM02.3-FW
BE16-02-FW	DSS02.1M	DFF01.1M	CLC-D02.3M-FW	COVER	DSM02.3-FW
BE17-01-FW	DSS02.1M	DFF01.1M	CLC-D02.1M-FW	DAK01.1M	DSM02.3-FW
BE17-02-FW	DSS02.1M	DFF01.1M	CLC-D02.3M-FW	DAQ02.1M	DSM02.3-FW
BE18-01-FW	DSS02.1M	DRF01.1M	CLC-D02.1M-FW	COVER	DSM02.3-FW
BE18-02-FW	DSS02.1M	DRF01.1M	CLC-D02.3M-FW	COVER	DSM02.3-FW
BE20-01-FW	DSS02.1M	DLF01.1M	DFF01.1M	CLC-D02.1M-FW	DSM02.3-FW
BE20-02-FW	DSS02.1M	DLF01.1M	DFF01.1M	CLC-D02.3M-FW	DSM02.3-FW
BE21-01-FW	DSS02.1M	DLF01.1M	CLC-D02.1M-FW	COVER	DSM02.3-FW
BE21-02-FW	DSS02.1M	DLF01.1M	CLC-D02.3M-FW	COVER	DSM02.3-FW

Configuration	Slot U1	Slot U2	Slot U3	Slot U4	Slot U5
BE22-01-FW	DSS02.1M	DZF02.1M	DEA04.2M	DFF01.1M	DSM02.3-FW
BE23-01-FW	DSS02.1M	DEA04.2M	COVER	COVER	DSM02.3-FW
BE24-01-FW	DSS02.1M	COVER	DEA04.2M	CLC-D02.1M-FW	DSM02.3-FW
BE24-02-FW	DSS02.1M	COVER	DEA04.2M	CLC-D02.3M-FW	DSM02.3-FW
BE25-01-FW	DSS02.1M	DEA04.2M	DFF01.1M	DSA01.1M	DSM02.3-FW
BE27-01-FW	DSS02.1M	DZF02.1M	DFF01.1M	COVER	DSM02.3-FW
BE28-01-FW	DSS02.1M	DLF01.1M	DFF01.1M	DEA04.2M	DSM02.3-FW
BE29-01-FW	DSS02.1M	DZF02.1M	CLC-D02.1M-FW	COVER	DSM02.3-FW
BE29-02-FW	DSS02.1M	DZF02.1M	CLC-D02.3M-FW	COVER	DSM02.3-FW
BE30-01-FW	DSS02.1M	DFF01.1M	DEA04.2M	COVER	DSM02.3-FW
BE31-01-FW	DSS02.1M	DRF01.1M	COVER	COVER	DSM02.3-FW
BE32-01-FW	DSS02.1M	DLF01.1M	COVER	COVER	DSM02.3-FW
BE33-01-FW	DSS02.1M	DLF01.1M	DEA04.2M	COVER	DSM02.3-FW
BE34-01-FW	DSS02.1M	DLF01.1M	DEA04.2M	CLC-D02.1M-FW	DSM02.3-FW
BE34-02-FW	DSS02.1M	DLF01.1M	DEA04.2M	CLC-D02.3M-FW	DSM02.3-FW
BE35-01-FW	DSS02.1M	DZF02.1M	CLC-D02.1M-FW	DAK01.1M	DSM02.3-FW
BE35-02-FW	DSS02.1M	DZF02.1M	CLC-D02.3M-FW	DAQ02.1M	DSM02.3-FW
BE37-01-FW	DSS02.1M	DZF02.1M	COVER	COVER	DSM02.3-FW
BE38-01-FW	DSS02.1M	DZF02.1M	DEA04.2M	COVER	DSM02.3-FW
BE39-01-FW	DSS02.1M	DZF02.1M	DEA04.2M	CLC-D02.1M-FW	DSM02.3-FW
BE39-02-FW	DSS02.1M	DZF02.1M	DEA04.2M	CLC-D02.3M-FW	DSM02.3-FW
BE40-01-FW	DSS02.1M	DEA04.2M	DRF01.1M	DSA01.1M	DSM02.3-FW
BE41-01-FW	DSS02.1M	CLC-D02.1M-FW	COVER	COVER	DSM02.3-FW
BE41-02-FW	DSS02.1M	CLC-D02.3M-FW	COVER	COVER	DSM02.3-FW
BE42-01-FW	DSS02.1M	CLC-D02.1M-FW	DAK01.1M	COVER	DSM02.3-FW
BE42-02-FW	DSS02.1M	CLC-D02.3M-FW	DAK01.1M	COVER	DSM02.3-FW
BE42-03-FW	DSS02.1M	COVER	CLC-D02.3M-FW	DAQ02.1M	DSM02.3-FW
BE43-01-FW	DSS02.1M	DEA04.2M	CLC-D02.1M-FW	DAK01.1M	DSM02.3-FW
BE43-02-FW	DSS02.1M	DEA04.2M	CLC-D02.3M-FW	DAQ02.1M	DSM02.3-FW
BE44-01-FW	DSS02.1M	DFF01.1M	DRF01.1M	CLC-D02.1M-FW	DSM02.3-FW
BE44-02-FW	DSS02.1M	DFF01.1M	DRF01.1M	CLC-D02.3M-FW	DSM02.3-FW
BE45-01-FW	DSS02.1M	DAG01.2M	COVER	COVER	DSM02.3-FW
BE46-01-FW	DSS02.1M	DEA04.2M	CLC-D02.1M-FW	DSA01.1M	DSM02.3-FW
BE46-02-FW	DSS02.1M	DEA04.2M	CLC-D02.3M-FW	DSA01.1M	DSM02.3-FW
BE47-01-FW	DSS02.1M	DFF01.1M	DSA01.1M	COVER	DSM02.3-FW
BE48-01-FW	DSS02.1M	DFF01.1M	DRF01.1M	DSA01.1M	DSM02.3-FW
BE49-01-FW	DSS02.1M	DFF01.1M	CLC-D02.1M-FW	DSA01.1M	DSM02.3-FW
BE49-02-FW	DSS02.1M	DFF01.1M	CLC-D02.3M-FW	DSA01.1M	DSM02.3-FW
BE50-01-FW	DSS02.1M	DRF01.1M	DSA01.1M	COVER	DSM02.3-FW
BE51-01-FW	DSS02.1M	DRF01.1M	CLC-D02.1M-FW	DSA01.1M	DSM02.3-FW
BE51-02-FW	DSS02.1M	DRF01.1M	CLC-D02.3M-FW	DSA01.1M	DSM02.3-FW
BE51-03-FW	DSS02.1M	DRF01.1M	CLC-D02.1M-FW	DSA01.1M	DSM02.3-FW
BE52-01-FW	DSS02.1M	CLC-D02.1M-FW	DSA01.1M	COVER	DSM02.3-FW
BE52-02-FW	DSS02.1M	CLC-D02.3M-FW	DSA01.1M	COVER	DSM02.3-FW
BE53-01-FW	DSS02.1M	CLC-D02.1M-FW	DAK01.1M	DSA01.1M	DSM02.3-FW
BE53-02-FW	DSS02.1M	DSA01.1M	CLC-D02.3M-FW	DAQ02.1M	DSM02.3-FW
BE54-01-FW	DSS02.1M	DSA01.1M	COVER	COVER	DSM02.3-FW
BE55-01-FW	DSS02.1M	DLF01.1M	DEA04.2M	DSA01.1M	DSM02.3-FW

Configuration	Slot U1	Slot U2	Slot U3	Slot U4	Slot U5
BE57-01-FW	DSS02.1M	DLF01.1M	DFF01.1M	DSA01.1M	DSM02.3-FW
BE61-01-FW	DSS02.1M	DLF01.1M	CLC-D02.1M-FW	DSA01.1M	DSM02.3-FW
BE61-02-FW	DSS02.1M	DLF01.1M	CLC-D02.3M-FW	DSA01.1M	DSM02.3-FW
BE62-01-FW	DSS02.1M	DLF01.1M	DSA01.1M	COVER	DSM02.3-FW
BE63-01-FW	DSS02.1M	DZF02.1M	DEA04.2M	DSA01.1M	DSM02.3-FW
BE65-01-FW	DSS02.1M	DZF02.1M	DFF01.1M	DSA01.1M	DSM02.3-FW
BE69-01-FW	DSS02.1M	DZF02.1M	CLC-D02.1M-FW	DSA01.1M	DSM02.3-FW
BE69-02-FW	DSS02.1M	DZF02.1M	CLC-D02.3M-FW	DSA01.1M	DSM02.3-FW
BE70-01-FW	DSS02.1M	DZF02.1M	DSA01.1M	COVER	DSM02.3-FW
BE71-01-FW	DSS02.1M	DZF02.1M	DAG01.1M	CLC-D02.1M-FW	DSM02.3-FW
BE71-02-FW	DSS02.1M	DZF02.1M	DAG01.2M	CLC-D02.1M-FW	DSM02.3-FW
BE71-03-FW	DSS02.1M	DZF02.1M	DAG01.2M	CLC-D02.3M-FW	DSM02.3-FW
BE72-01-FW	DSS02.1M	DZF02.1M	DAG01.1M	DSA01.1M	DSM02.3-FW
BE72-02-FW	DSS02.1M	DZF02.1M	DAG01.2M	DSA01.1M	DSM02.3-FW
BE74-01-FW	DSS02.1M	DAG01.1M	DEA04.2M	COVER	DSM02.3-FW
BE74-02-FW	DSS02.1M	DAG01.2M	DEA04.2M	COVER	DSM02.3-FW
BE75-01-FW	DSS02.1M	DAG01.2M	DEA04.2M	CLC-D02.1M-FW	DSM02.3-FW
BE75-02-FW	DSS02.1M	DAG01.2M	DEA04.2M	CLC-D02.3M-FW	DSM02.3-FW
BE76-01-FW	DSS02.1M	DEF01.1M	COVER	COVER	DSM02.3-FW
BE77-00-FW	DSS02.1M	DEF01.1M	DEA04.2M	CLC-D02.3M-FW	DSM02.3-FW
BE78-00-FW	DSS02.1M	DEF01.1M	DEA04.2M	COVER	DSM02.3-FW
BE79-01-FW	DSS02.1M	DZF03.1M	COVER	COVER	DSM02.3-FW
BE80-01-FW	DSS02.1M	DZF03.1M	DEA04.2M	COVER	DSM02.3-FW
BE81-00-FW	DSS02.1M	DEF01.1M	CLC-D02.3M-FW	COVER	DSM02.3-FW
BE95-01-FW	DSS02.1M	CLC-D02.1M-FW	DEA04.2M	DEA05.2M	DSM02.3-FW
BE95-02-FW	DSS02.1M	CLC-D02.3M-FW	DEA04.2M	DEA05.2M	DSM02.3-FW

Fig. 3-12: Summary of components of the basic units inserted into different configurations

4 Technical Data

4.1 Power section

DC bus voltage

Designation	Value	Unit
DC bus voltage	300 +/- 15%	V

Fig. 4-1: DC bus voltage

Allocation of peak and continuous currents

In the second column, the possible continuous current is listed for the maximum peak current, while the possible peak current is given for the maximum continuous current in the third column of the following list.

Drive controller	Max. peak current / continuous current	Peak current / max. continuous current
DDS02.2-W015-...	15A / 15A	15A / 15A
DDS03.2-W015-...	15A / 15A	15A / 15A
DDS03.2-W030-...	30A / 12A	20A / 20A
DDS03.2-W050-...	50A / 20A	50A / 20A
DDS02.2-W050-...	50A / 50A	50A / 50A
DDS02.2-A050-...	50A / 50A	50A / 50 A
DDS02.2-F050-...	50A / 50A	50A / 50A
DDS02.2-W100-...	100A / 60A	70A / 70A
DDS02.2-A100-...	100A / 100A	100A / 100A
DDS02.2-F100-...	100A / 100A	100A / 100A
DDS02.2-W200-...	200A / 65A	90A / 90A
DDS02.2-A200-...	200A / 85A	160A / 105A
DDS02.2-F200-...	200A / 105A	200A / 105A

Fig. 4-2: Allocation of peak and continuous currents

4.2 Current consumption of the signal processing devices

Current consumption of the signal processing

The supply unit makes available DC +24V - and DC +/- 15V for all connected drive controllers. The sum of the current consumed by all drive controllers may not be permitted to exceed the current output of the supply unit.

It generally applies to the current consumption of the drive controllers that for DC +/-15V, 200 mA each and for DC +24V, 1100 mA.

The current consumption for a drive unit can be determined as follows for detailed calculations:

- Current consumption of the basic unit
- + Current consumption of the plugin modules inserted in basic unit
- + Current consumption of the motor feedback (only applies if connected at X4 of the basic unit)
- = Current consumption of a drive unit

Current consumption of the basic unit

Drive controller types	Current consumption DC +15V in mA	Current consumption DC -15V in mA	Current consumption DC +24V in mA
DDS02.2-...	150	150	500
DDS03.2-...	150	150	500

Fig. 4-3: Current consumption of the basic unit

Current consumption of the motor feedback

Use the type code of the motor to locate the designation of the motor feedback.

Motor feedback	Current consumption DC +15V in mA	Current consumption DC -15V in mA	Current consumption DC +24V in mA
G	25	5	0
K	25	5	0
L	0	0	40
M	0	0	60
S	0	0	40
T	20	0	0
6	0	0	40
7	0	0	60

L, S, 6 = digital servo feedback (DSF)
M, T, 7 = digital servo feedback with multiturn absolute encoder (DSF + MTG)
G = resolver feedback (RSF)
K = resolver feedback with multiturn absolute encoder (RSF + MTG)

Fig. 4-4: Current consumption of the motor feedback

Note: If the designation of the motor feedback is not listed in Fig. 4-4 then the current consumption of the feedback is not relevant to the calculations.

**Current consumption of the
plugin modules**

Plugin module types	Current consumption DC +15V in mA	Current consumption DC -15V in mA	Current consumption DC +24V in mA
CLC-D02.1M-FW	0	0	200
CLC-D02.3M-FW	0	0	200
DAK01.1M	0	0	70
DEA04.1M	0	0	40
DEA04.2M	0	0	40
DEA05.1M	0	0	40
DEA05.2M	0	0	40
DEA06.1M	0	0	40
DEA08.1M	0	0	50
DEA09.1M	0	0	50
DEA10.1M	0	0	50
DEA28.1M	0	0	50
DEA29.1M	0	0	50
DEA30.1M	0	0	50
DEF01.1M	0	0	150
DFF01.1M	45	45	45
DLF01.1M	40	40	130
DRF01.1M	50	50	15
DSA01.1M	30	30	70
DSS02.1M	0	0	110
DZF02.1M	30	40	150
DZF03.1M	30	40	150

Fig. 4-5: Current consumption of the plugin modules

4.3 Ambient and environmental conditions

Designation	Value	Unit
Permissible ambient temperature with rated data	+0...+45	°C
Maximum permissible ambient temperature with derated data	+55	°C
Storage and transport temperatures	-30...+85	°C
Maximum installation elevation with rated data	1000	m
Maximum permissible relative humidity	95	%
Maximum permissible absolute humidity	25	g/m ³
Protection category	IP20, nach EN 60529 = DIN VDE 0470-1-1992 (IEC 529-1989)	

Fig. 4-6: Ambient and environmental conditions

Deviating ambient conditions

Selection data are listed for each motor/controller combination.

These data apply within the indicated ambient temperature and installation elevations .

If conditions differ, then the continuous torque at standstill M_{dN} and the short-term torque M_{KB} drop as illustrated. If both occur simultaneously, then both load factors must be multiplied.

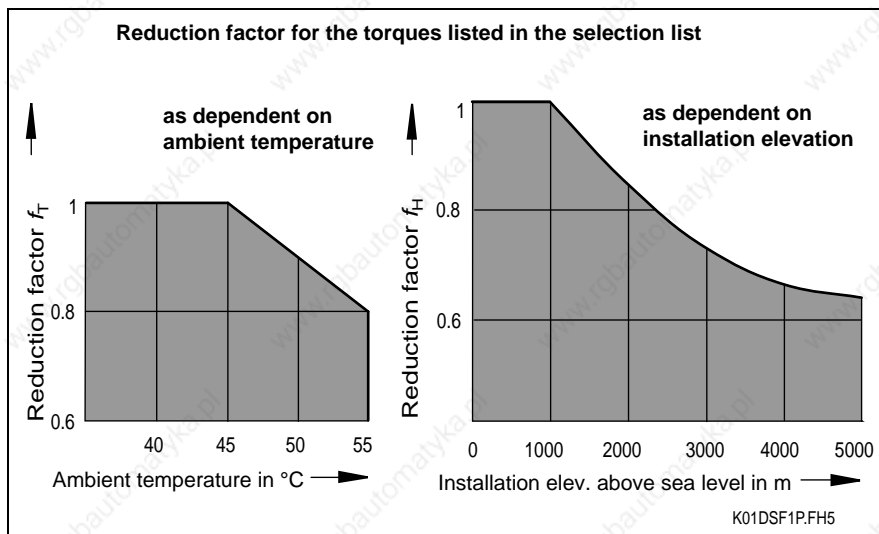

Fig. 4-7: Load capacity as dependent on ambient temperature and installation elevation

4.4 Drive controller energy loss

Determining energy loss in the controller by adding the maximum energy loss to the controller type does not account for the actual continuous load to the controller.

Over an average period of time, the maximum amount of the continuous current at standstill I_{dN} of the motor flows through the controller (see motor documentation).

The actually resulting energy loss depends on the continuous current at standstill I_{dN} of the connected motor. The continuous current I_{dN} at standstill is listed in the motor documentation.

Example: determining energy loss

Controller:	DDS 2.1 - W050 - ...
Motor:	MDD 093A-N-020-...
Standstill current I_{dN} of the motor:	9.5 A
Energy loss as determined in Fig. 4-8:	approx. 80 W

Energy loss in a DDS02.2-W...

Energy loss in the control cabinet

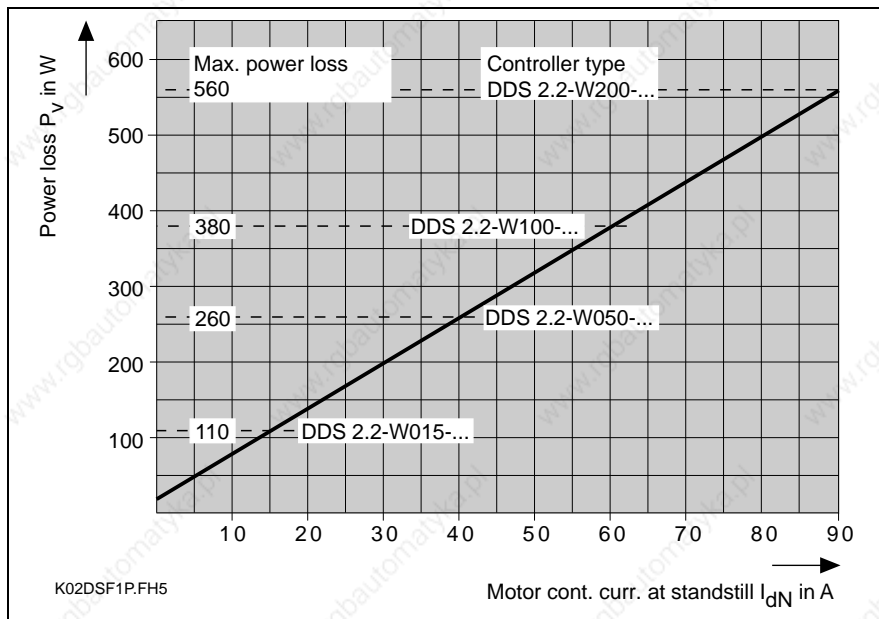

Fig. 4-8: Determining energy loss in the control cabinet

Energy loss in a DDS02.2-F...

Energy loss in the control cabinet

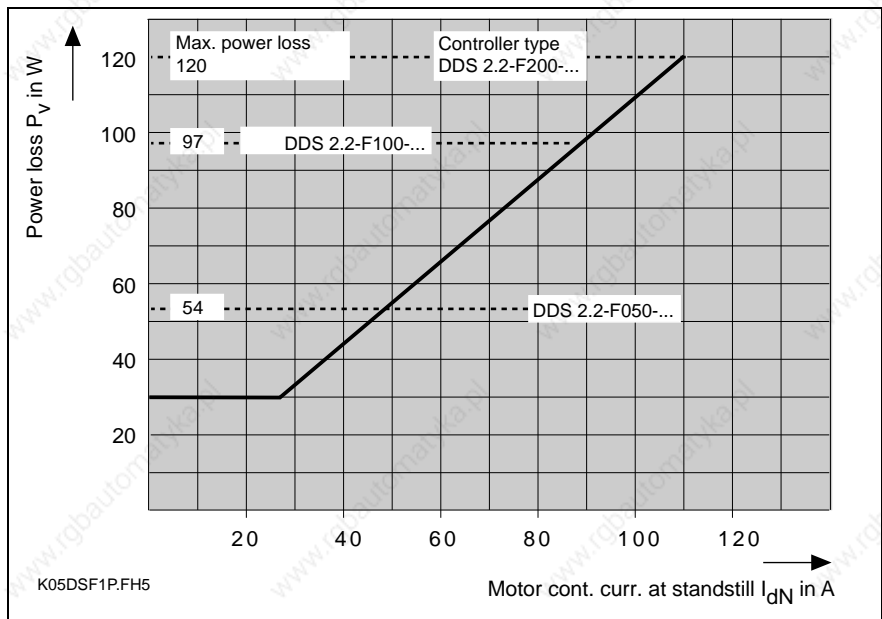

Fig. 4-11: Determining energy loss in the control cabinet

Energy loss via the coolant

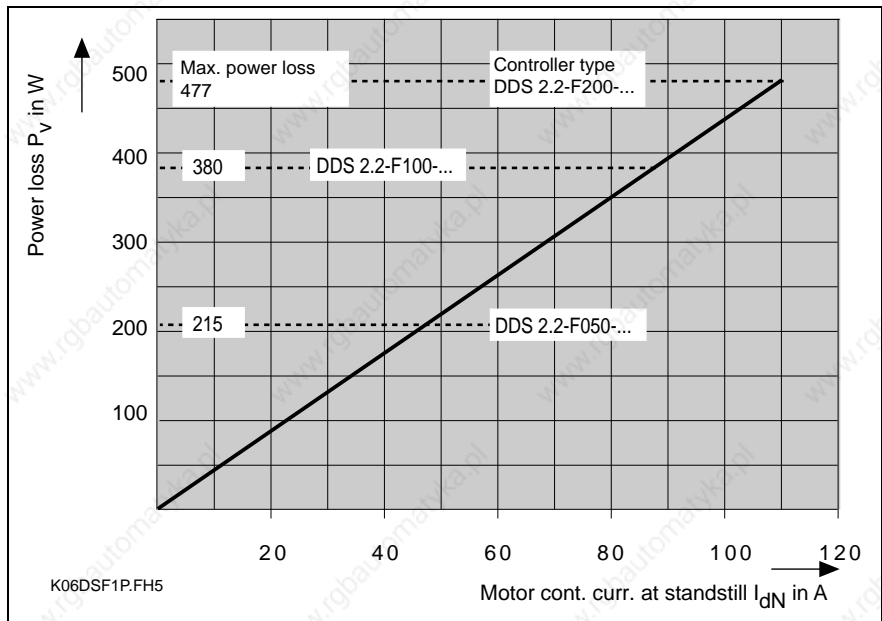

Fig. 4-12: Determining energy loss via the coolant

Energy loss in a DDS03.2-W...

Energy loss in the control cabinet

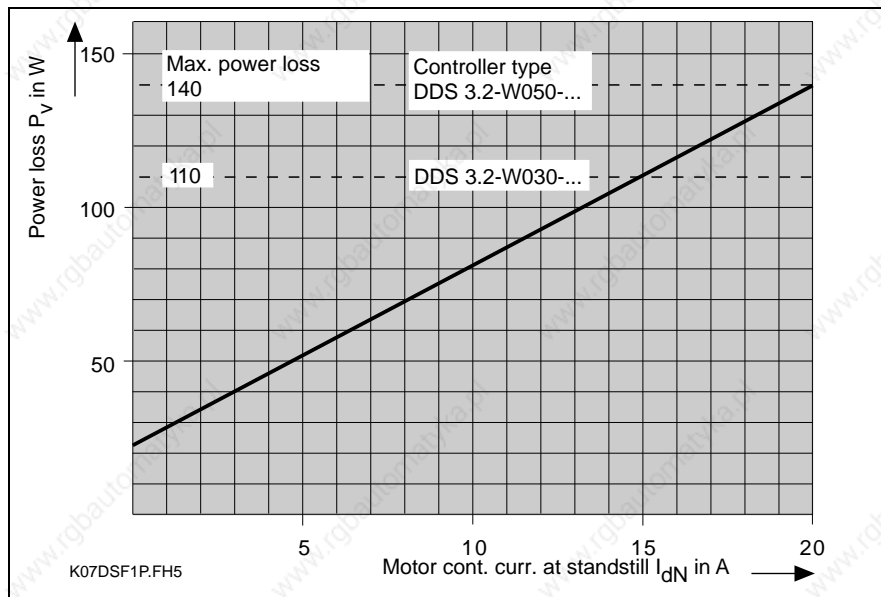

Fig. 4-13: Determining energy loss in the control cabinet

4.5 Weight

Drive controller types	Weight in kg
DDS02.2-W...-. (heat technology)	approx. 7.5
DDS02.2-A...-. (cold technology)	approx. 11
DDS02.2-F...-. (liquid cooling)	approx. 11
DDS03.2-W...-. (heat technology)	approx. 5.5

Fig. 4-14: Weight of the drive controller

5 Planning the construction of the control cabinet

Mounting conditions

The drive controller and its supply unit are designed for mounting into a control cabinet or closed housing and meet the demands of protection category IP 10, per DIN 40 050.

The unit is protected against penetration by a solid extrinsic object with a diameter exceeding 50 mm.

The unit is not protected against

- penetration by water
- intentional accessing by a hand, for example, but it will keep larger body surfaces out.

Arranging the controllers

Position that drive which has a high output and excessive current levels as close to the supply unit as possible.

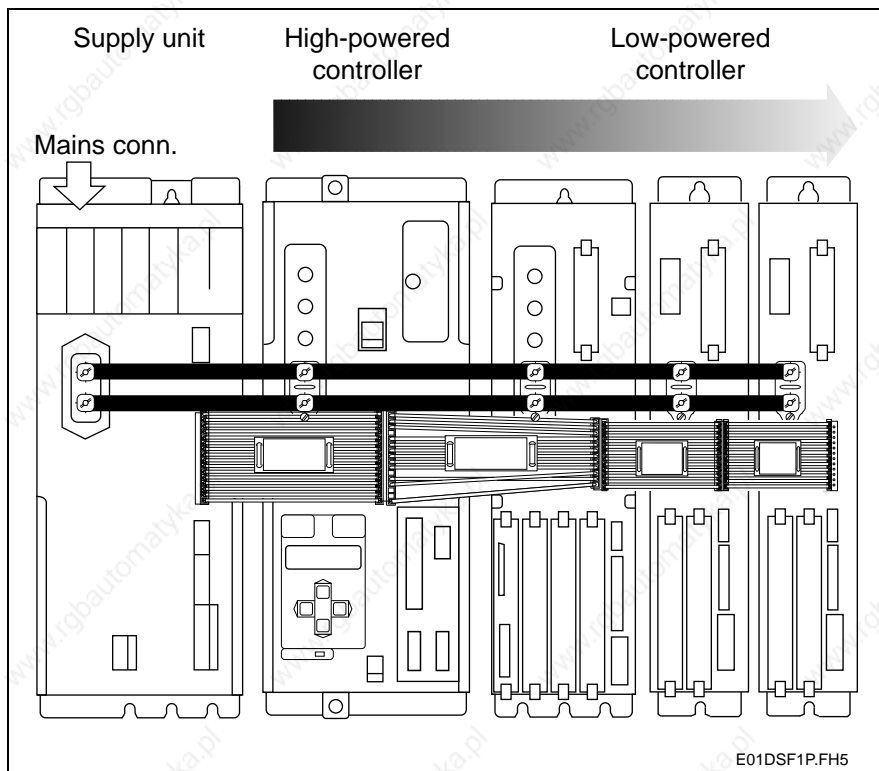

Fig. 5-1: Recommended arrangement of the units inside the control cabinet

Clearance dimensions DDS02.2

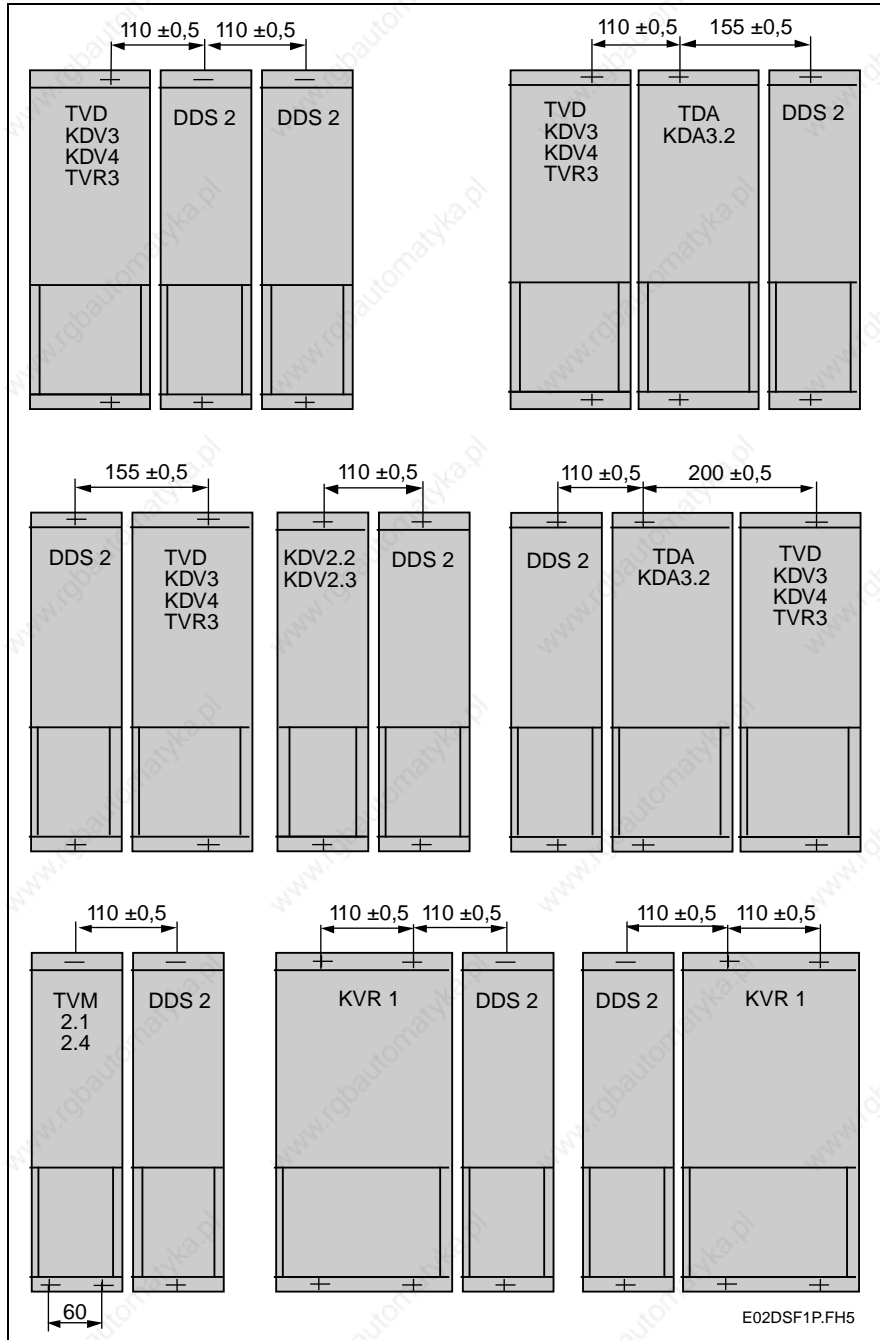

Fig. 5-2: Clearance dimensions in a DDS02.2 control cabinet

**Clearance dimensions for
DDS03.2**

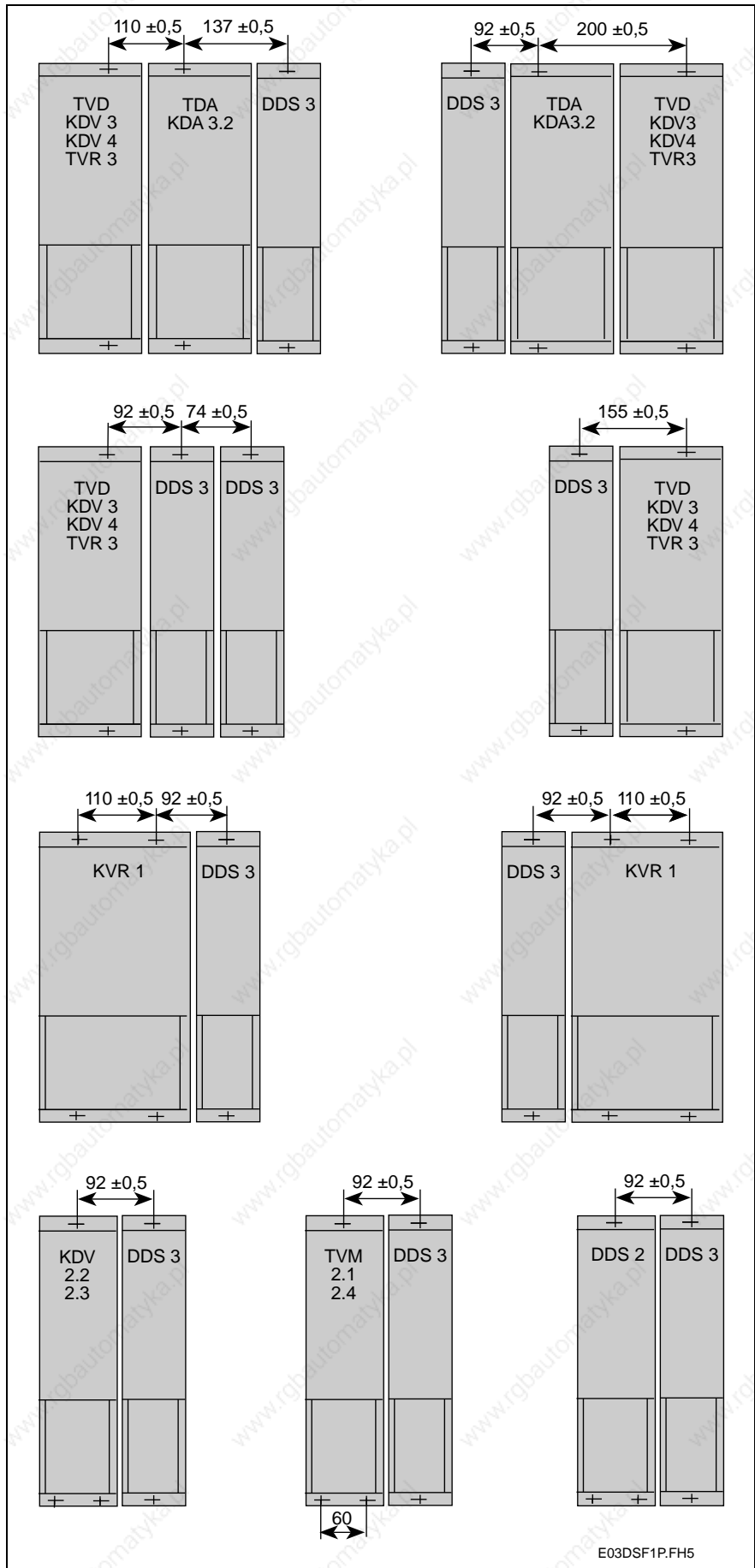

Fig. 5-3: Clearance dimensions in a DDS03.2 control cabinet

5.1 Mounting the DDS02.2-W... drive controller

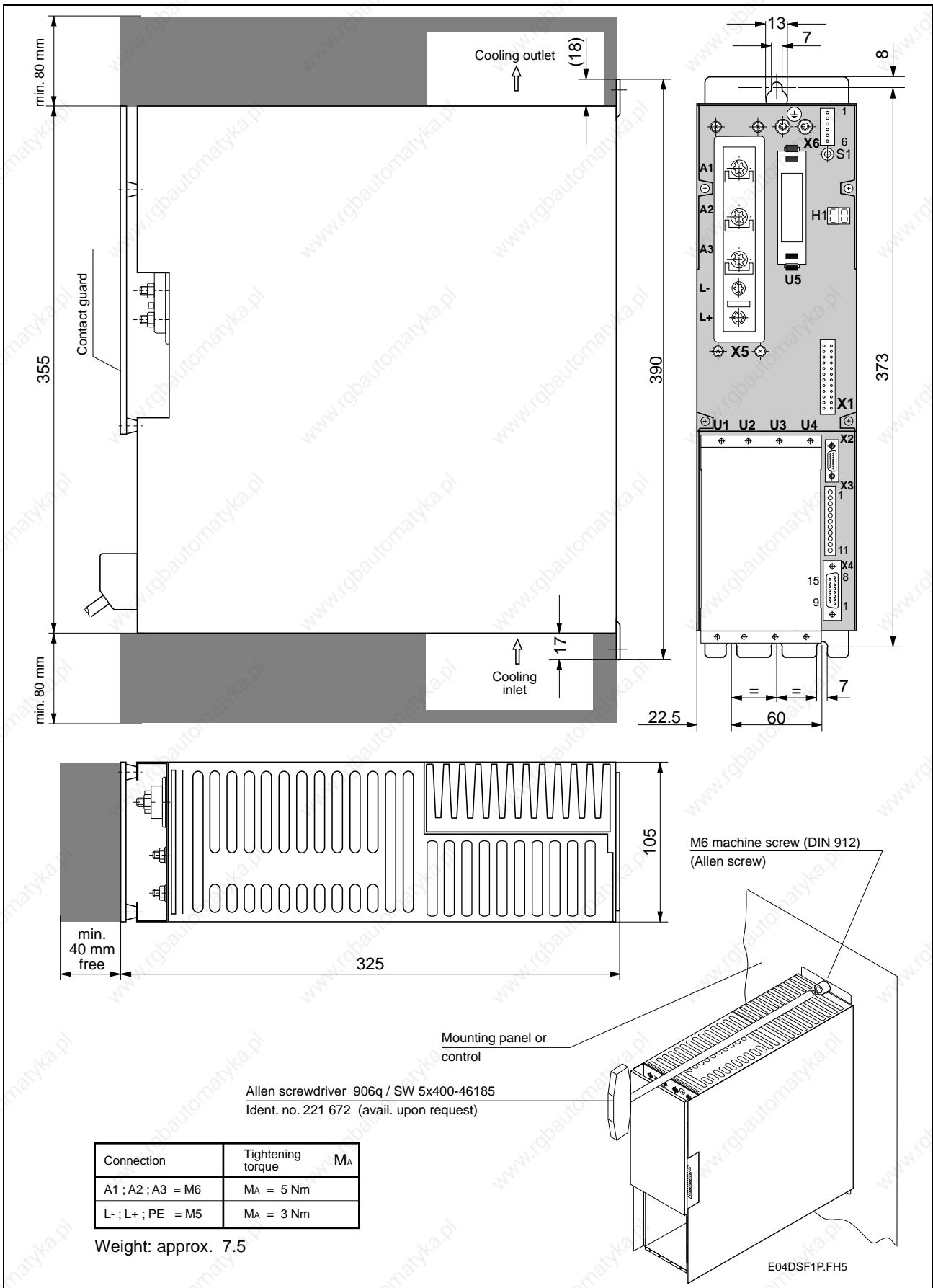

Fig. 5-4: Dimensional sheet - DDS02.2-W... drive controller

5.2 Mounting the DDS02.2-A... drive controller

Drive controller mounted in control cabinet

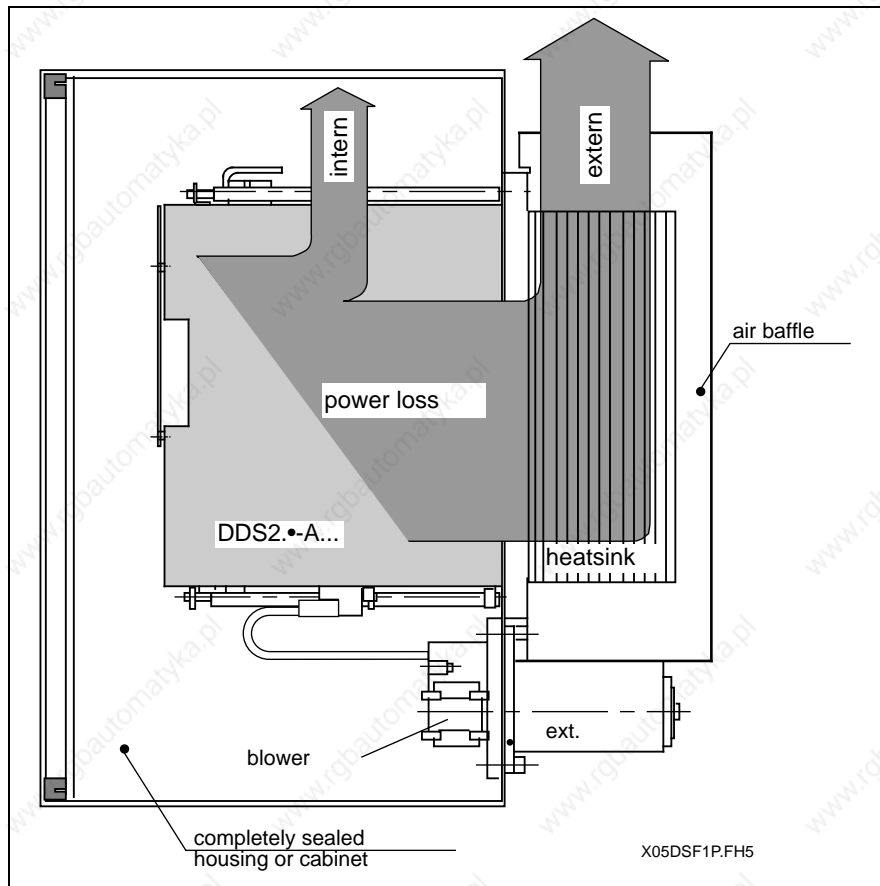

Fig. 5-5: DDS02.2-A... mounted in control cabinet

Power loss

The DDS02.2-A... drive controller has the advantage that most of the energy dissipated by the unit is directly conducted outside and thus not accumulated within the control cabinet. These units can therefore be mounted into small control cabinets or housing without requiring extensive heat conductance or heat exchanging units.

Blower

The electrical part of the blower is protected within the control cabinet (see Fig. 5-5). The heatsink of the power section and the blower impeller are outside the control cabinet or housing.

Mounting panel

Using a mounting panel, the units are mounted into the therefore provided space on the backwall of the cabinet in such a way that the heatsink with its casing stick out of the cabinet. The opening within the cabinet is sealed with a seal ring at the mounting flange of the unit after mounting (see Fig. 5-7). Mounting and exchange of the drive controller and external blower can be performed on the inside of the control cabinet.

Dimensional sheet

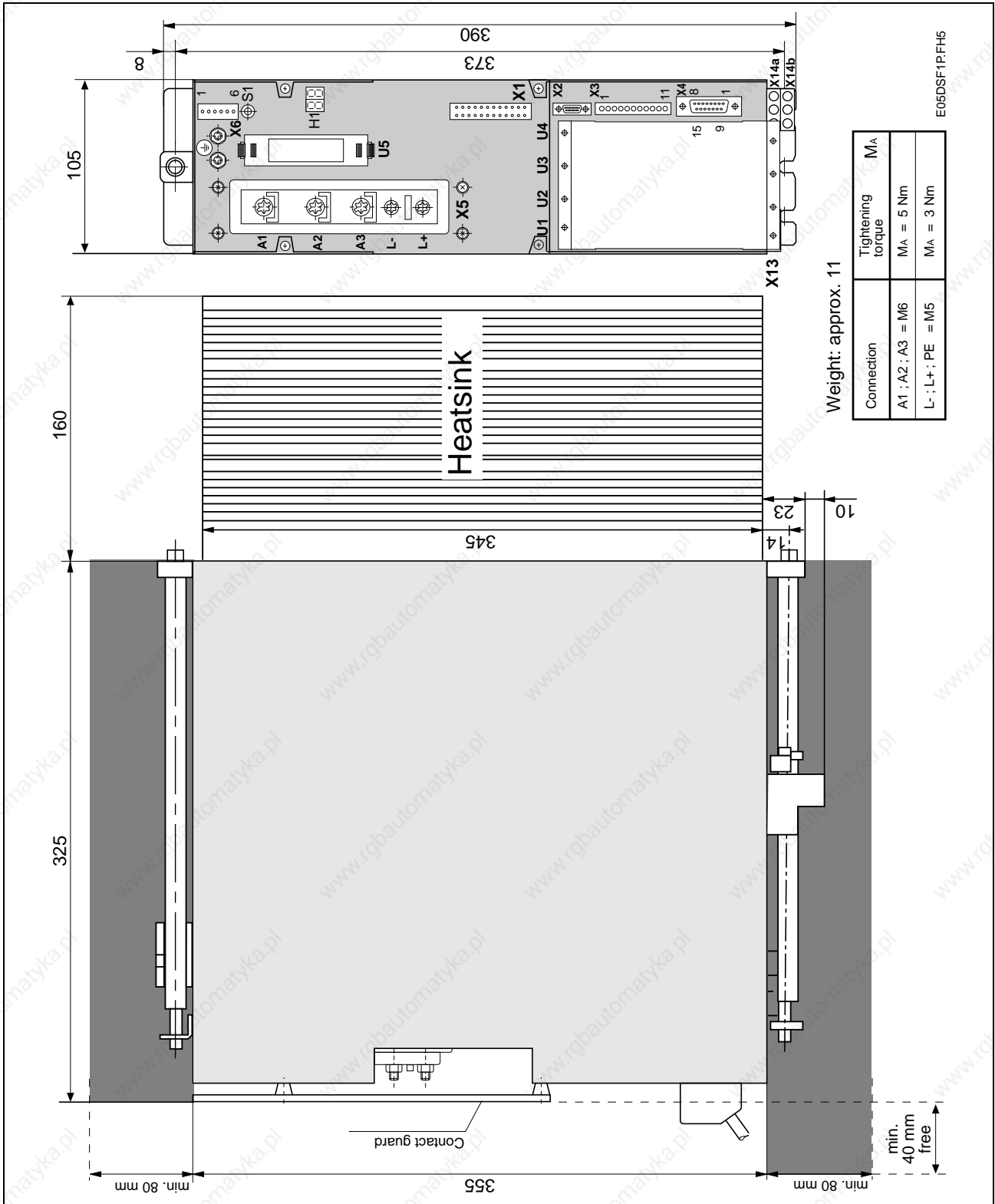

Fig. 5-6: Dimensional sheet DDS02.2-A...

Mounting plan - DDS02.2-A...

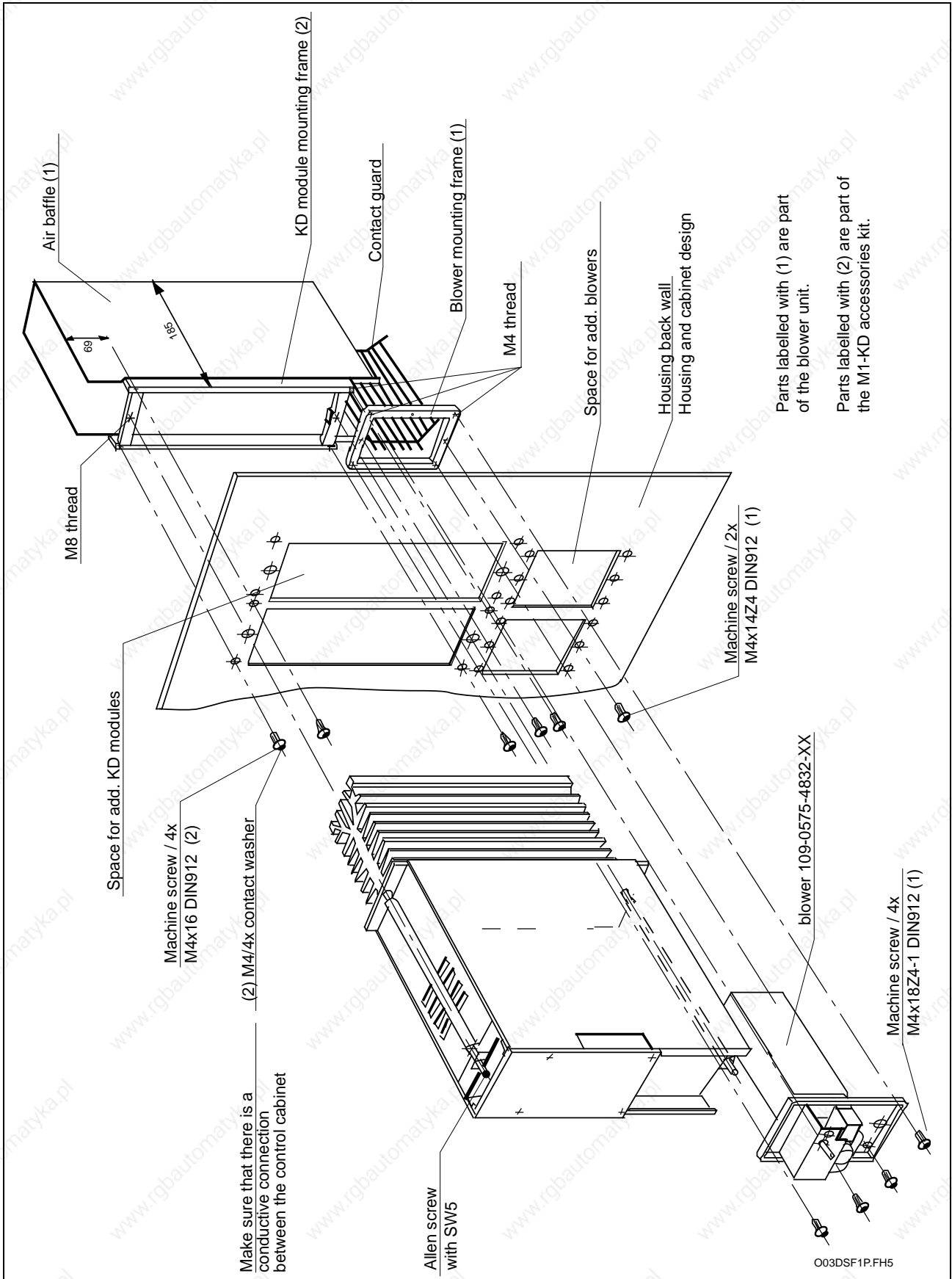

Fig. 5-7: Mounting a DDS02.2-A... drive controller

Installation dimensions -
DDS02.2-A...

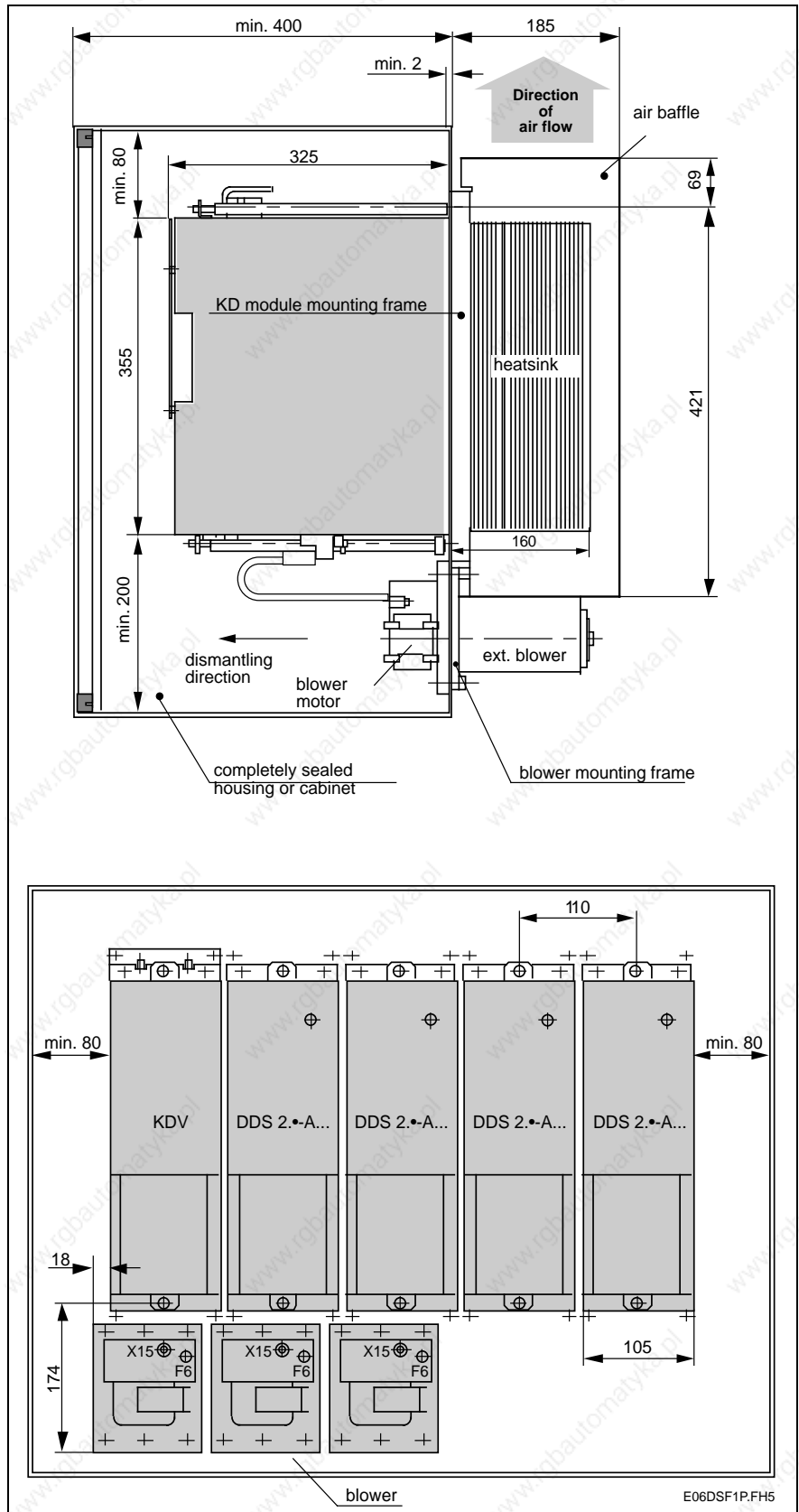

Fig. 5-8: Installation dimensions

Space and clearance dimensions - DDS02.2-A...

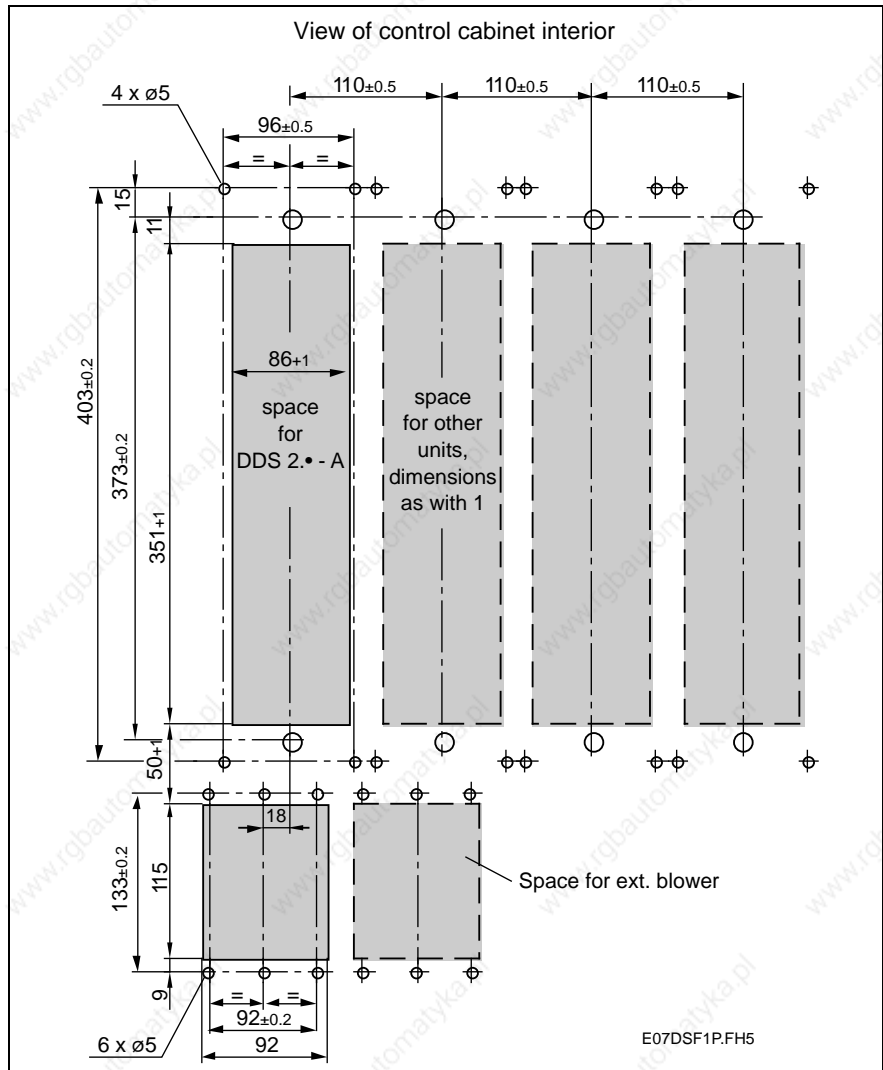

Fig. 5-9: Space and clearance dimensions - DDS02.2-A...

5.3 Mounting the DDS02.2-F... drive controller

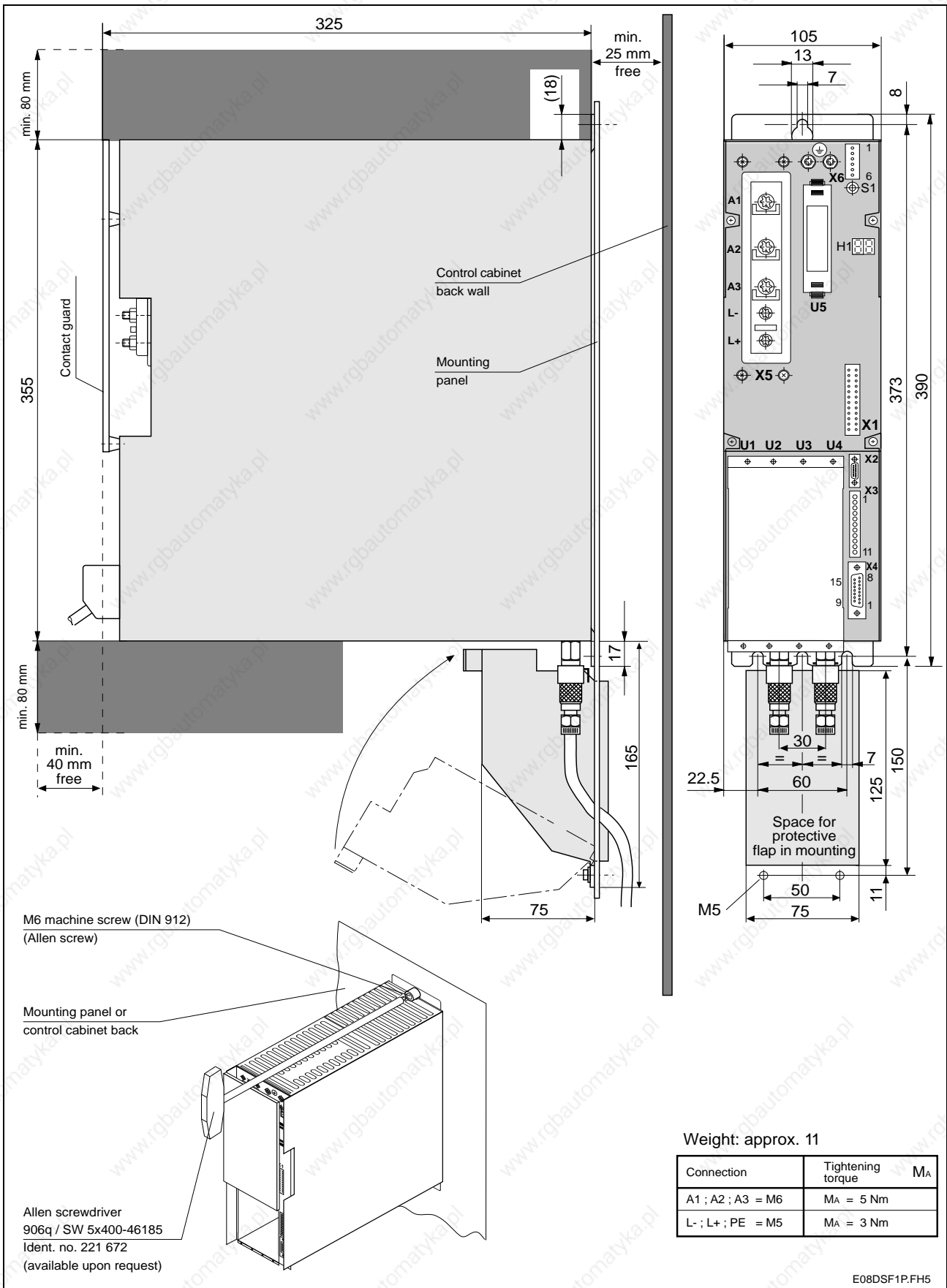

Fig. 5-10: Dimensional sheet - DDS02.2-F... drive controller

**Dimensional sheet
Accessory kit SH-FL**

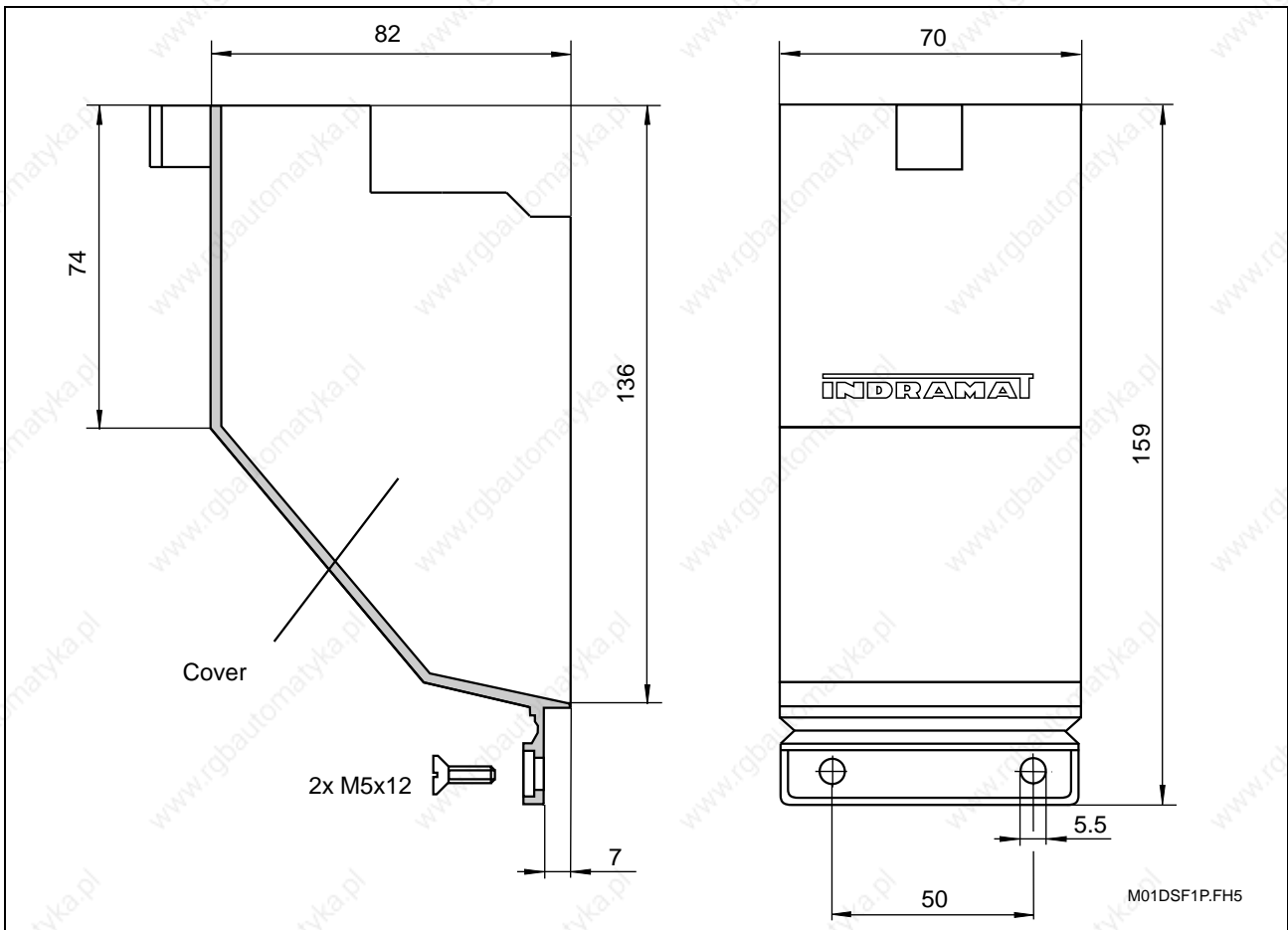

Fig. 5-11: Dimensional sheet of accessory kit SH-FL

**Dimensional sheet
Accessory kit M2-F**

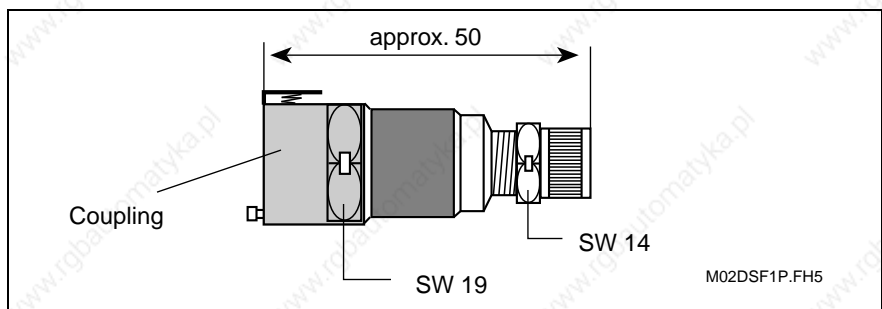

Fig. 5-12: Dimensional sheet accessory kit M2-F

Note: Please note that mounting and installation guidelines outlined in document on "Liquid cooling Indramat drive components", (doc. no: 209-0042-4131-00).

5.4 Mounting a DDS03.2-W...- drive controller

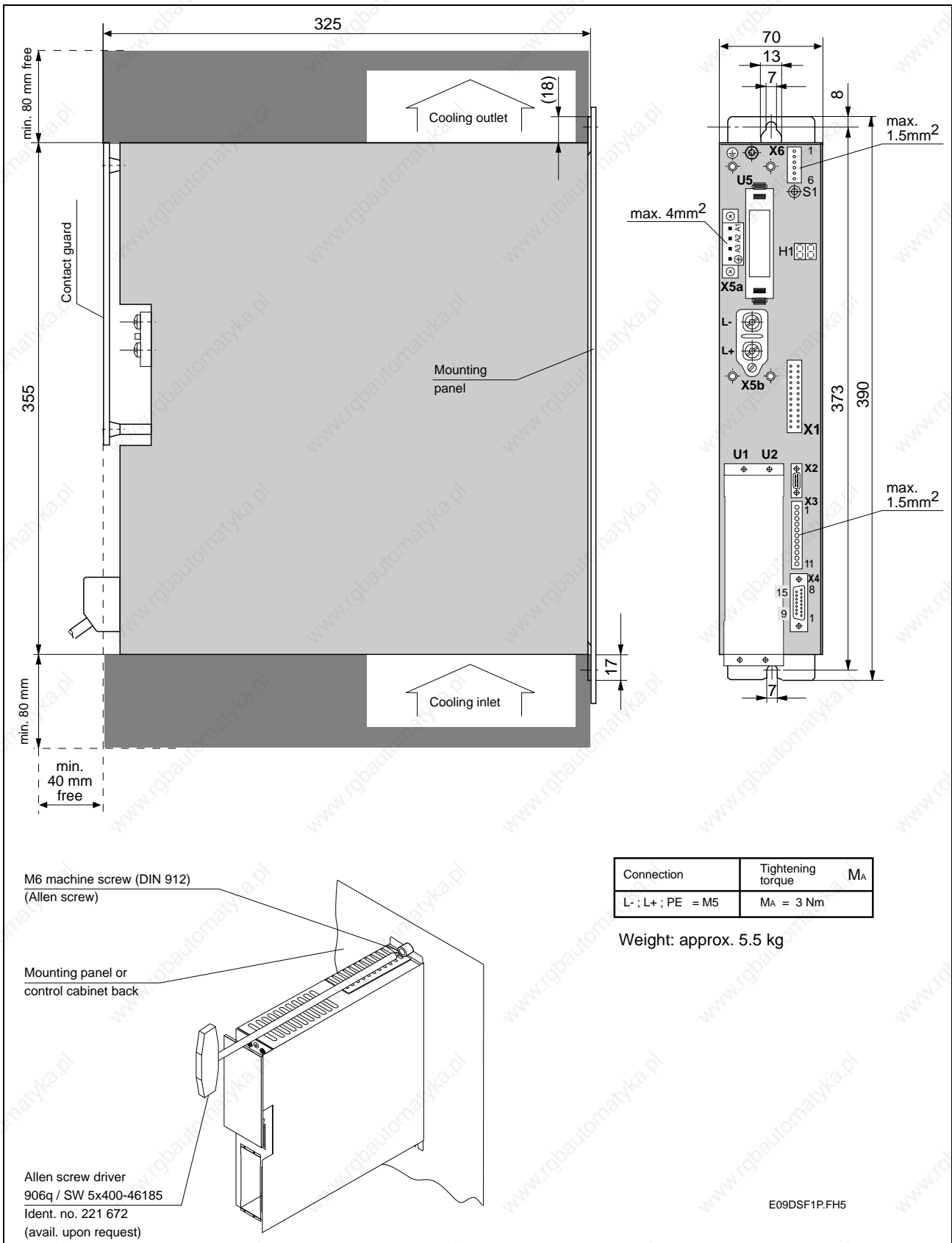

Fig. 5-13: Dimensional sheet - DDS03.2-W...-

5.5 Interference suppression and EMC

The mounting and installation guidelines in the Project Planning Manual on "EMC in drive and control systems" must be noted to maintain the legal EMC requirements.

5.6 Using heat-exchanger units in control cabinets

If heat-exchanger units are not installed and operated properly, then the drive components inside the control cabinet could be damaged by moisture and condensation!

DANGER from condensation

Humid air penetrates the control cabinet and, when it cools, condenses on the drive components installed.

DANGER from condense water

If the heat-exchanger unit is not located properly in the control cabinet, then the water, constantly condensing on it, can drip into the installed components or be sprayed onto them by the cold air current.

Avoiding condensation

Proper use of heat-exchanger units:

- Only use heat-exchanger units in well-sealed control cabinets so that moisture cannot be brought in by any humid air from outside!
- If the control cabinets are operated with opened doors, for startup, servicing and so on, then make sure, once the doors are closed, that the drive components are not at any time cooler than the air in the control cabinet. Condensation could otherwise occur. For this reason, the heat-exchanging unit must continue to operate even when the plant is switched off so that the temperature of the control cabinet air and the drive components installed remains at the same level.
- Set heat-exchanger units with permanent temperature adjustment to 40 °C no lower!
- Position heat-exchanger units with temperature correction so that the inside temperature of the control cabinet is not lower than the outside air temperature. Set limit to 40 °C!

Avoiding dripping and spraying water

Always situate heat-exchanging units so that any condensation cannot drip into the installed drive components. Heat-exchangers on the control cabinet roof require a special design!

Design the control cabinet in such a way that the unit blower cannot spray condensation deposits onto the drive components after periods during which the unit was not running!

Summary

- Make sure that no condensation drips from the heat-exchanger unit into the installed drive components!
- Make sure that the temperature is correctly set on the heat-exchanger unit!

Heat-exchanger unit on the roof of the control cabinet

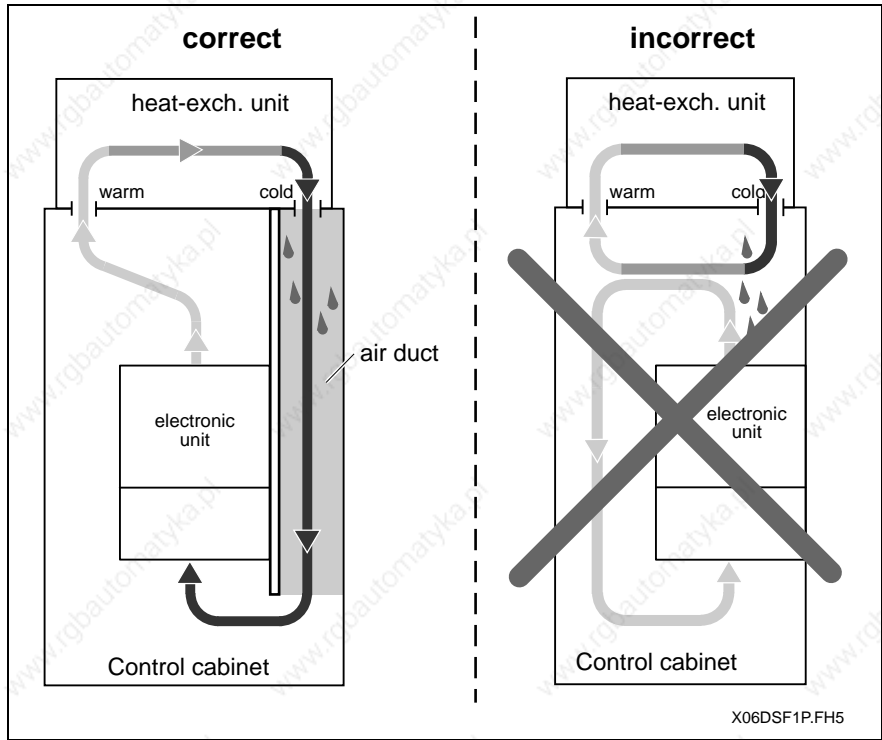

Fig. 5-14: Arranging the heat-exchanger unit on the roof of the control cabinet

Heat-exchanger unit on the front of the control cabinet

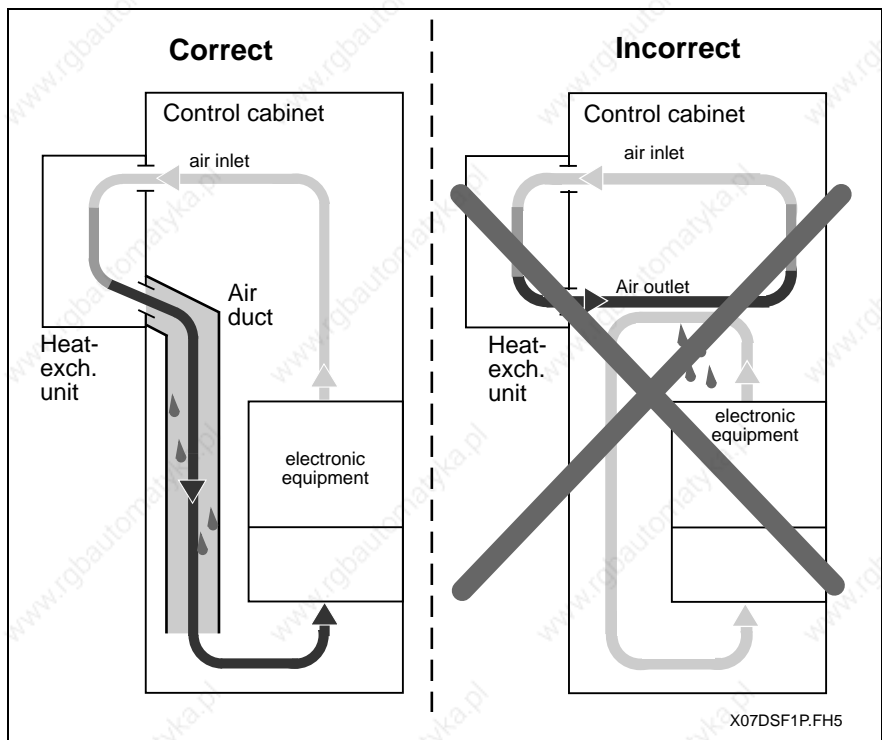

Fig. 5-15: Arranging the heat-exchanger unit on the front of the control cabinet

6 Electrical connections of the drive controller

6.1 General notes

- The signal lines must be routed separately of the supply lines due to interference.
- All signal lines should use plugin clamps or D subminiature plugin connectors to facilitate any unit replacement that might be needed.
- Analog signals must be routed via shielded leads and their shields mounted only to the drive controller.
- Mains, DC bus and motor leads may not be permitted to come into contact with or be connected to the DC $\pm 15V$ and DC $+24V$ low voltages.
- If a high or interference voltage test of the electrical equipment of the machine is to be conducted, then all connections must be clamped off or removed entirely to avoid damage to the electronic components (permissible as per VDE 0113). The INDRAMAT drive components are tested in accordance with the VDE 0160 high-voltage test regulations.
- Electrostatic loads endanger electronic components. Body parts that come into contact with these components or printed circuits, must first be discharged by grounding. This means that the human body must be discharged by touching a grounded object, soldering iron and parts and tools must be placed on a conductive surface.
- Endangered components such as plugin modules must be stored or transported in special packaging.
- Maintaining limit values for the transmission of interference (noise reduction) at the points of connection of the machine or plant, particularly when operating in residential or light industrial areas, requires a shielded routing of the motor power cable or the use of a shielded motor power cable. Proper installation of an interference filter, as recommended by Indramat, into the mains supply conductors of the machine or plant is also advisable. The limit values as per class B (noise reduction grade N) as per EN 55011/3.91 and table I per EN 55014/1987 at the machine must be maintained. Further information can be found in the project planning manual "EMC in drive and control systems" (Doc. no.: 209-0049-4305-..).

6.2 Connecting the basic unit

Basic unit DDS02.2-...

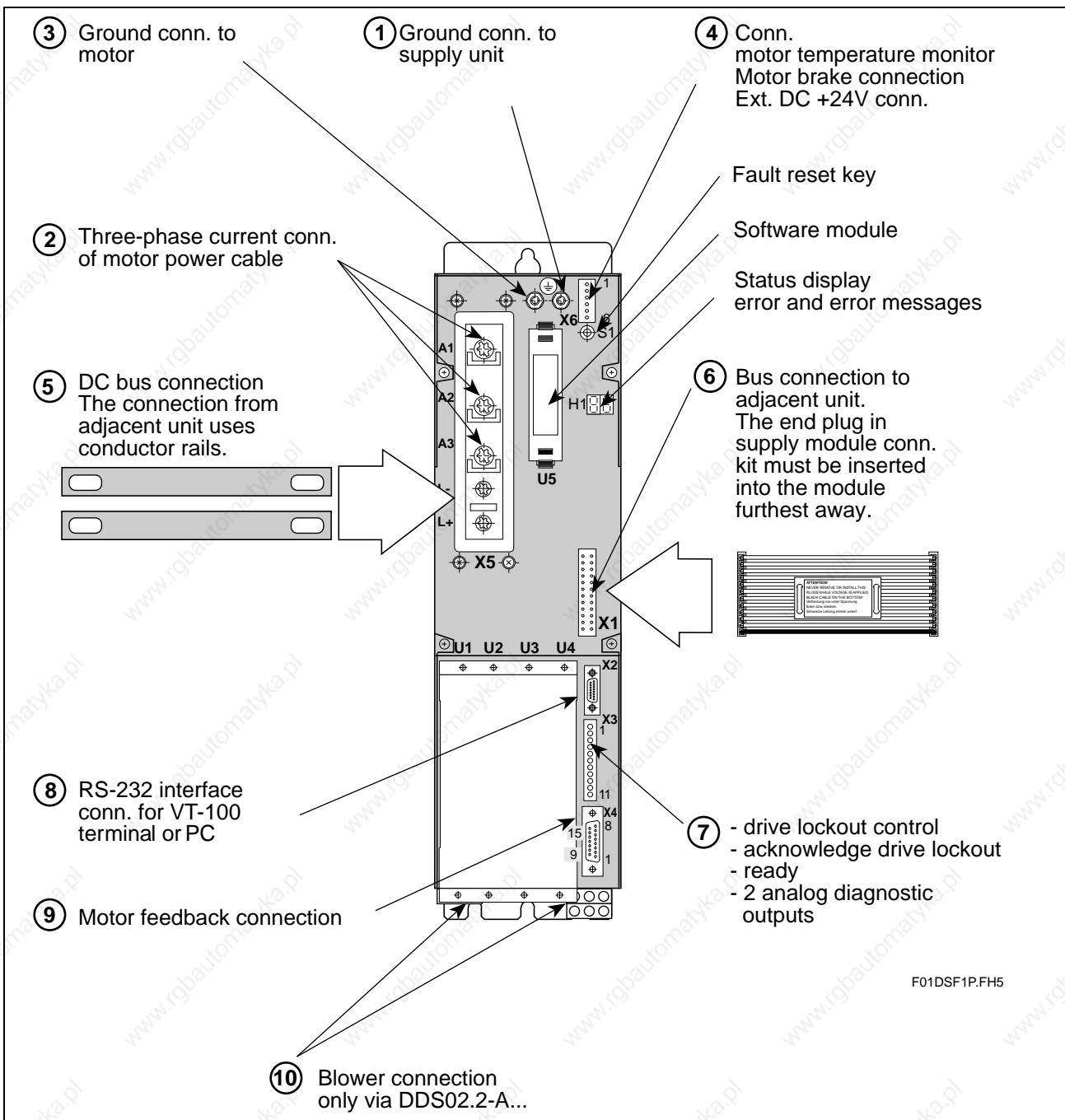

F01DSF1P.FH5

Fig. 6-1: Front with connections of basic unit DDS02.2-... identified

For details on points ①...⑩ see the following pages.

Basic unit DDS03.2-...

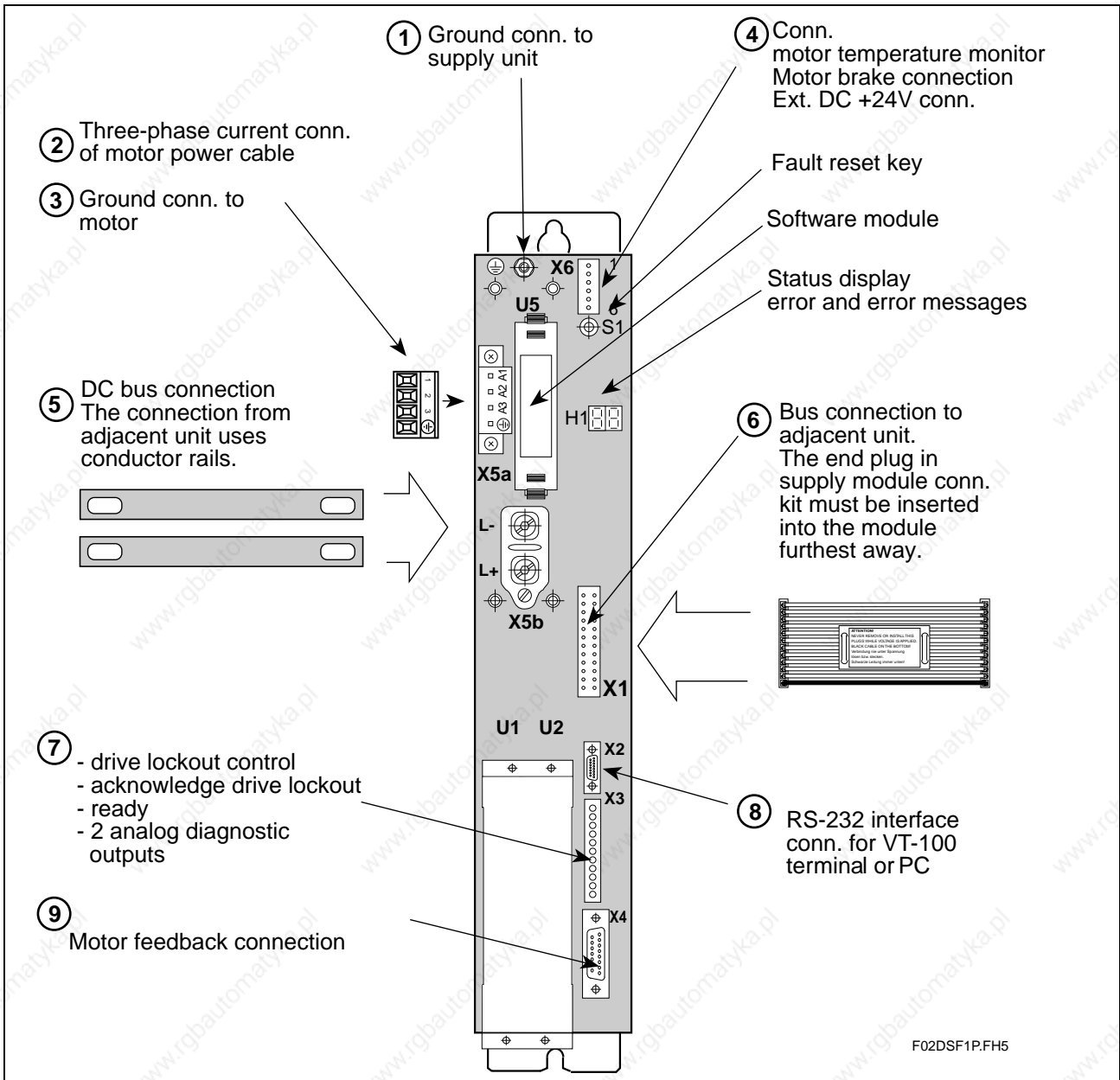

Fig. 6-2: Front with connections on basic unit DDS03.2-... identified

For details on points ①...⑩ see the following pages.

① Chassis earth connections to the supply unit

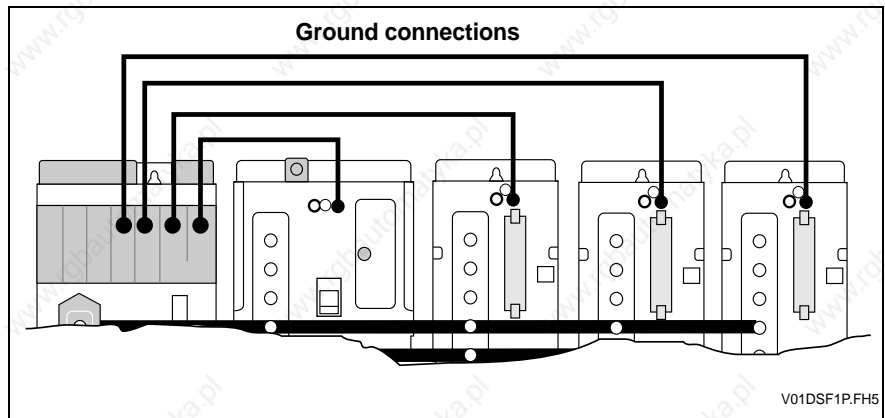

Fig. 6-3: Chassis earth connection to the supply module

Core cross section

The cross section of the chassis earth connection :

- must be as big as the cross section of the mains supply line
- not smaller than 10 mm²

Earth loops should be avoided, if possible, as intermeshing causes interference and can make fault clearance more difficult.

②③④ Connecting the motor power cable to the drive controller

Motor power cable

Use Indramat motor power cables for the lines between the drive controller and the AC motors.

The INDRAMAT motor power cable contains:

- three lines for the motor power connection
- one line for the protective conductor connection
- a separately shielded pair of cables for motor temperature monitoring
- a separately shielded pair of lines for the motor brake
- a total shield for power cables IKG. Applies if being operated within residential or light industrial areas to maintain the limit values for the emission of interference (noise reduction). Otherwise, a totally shielded routing of the power supply may be necessary.

The motor power cable is a ready-made cable and available from Indramat. A cable can also be made out of four individual leads (three phases, one protective conductor), with a separately conducted, shielded thermal resistance and brake connection cable. For further information on technical data, connections and cross sections, please check the motor description and the cable catalog.

Maximum cable length

The maximum cable length equals 75 meters if INDRAMAT cables are used.

**Motor power connection -
DDS02**

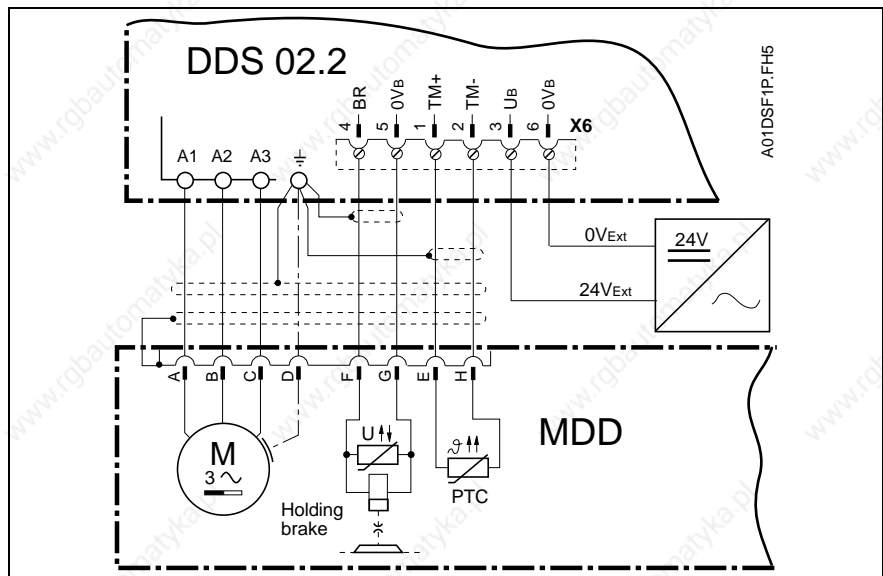

Fig. 6-4: Motor power connection, holding brake connection and motor temperature monitor with DDS02.2

**Power cable connection -
DDS02**

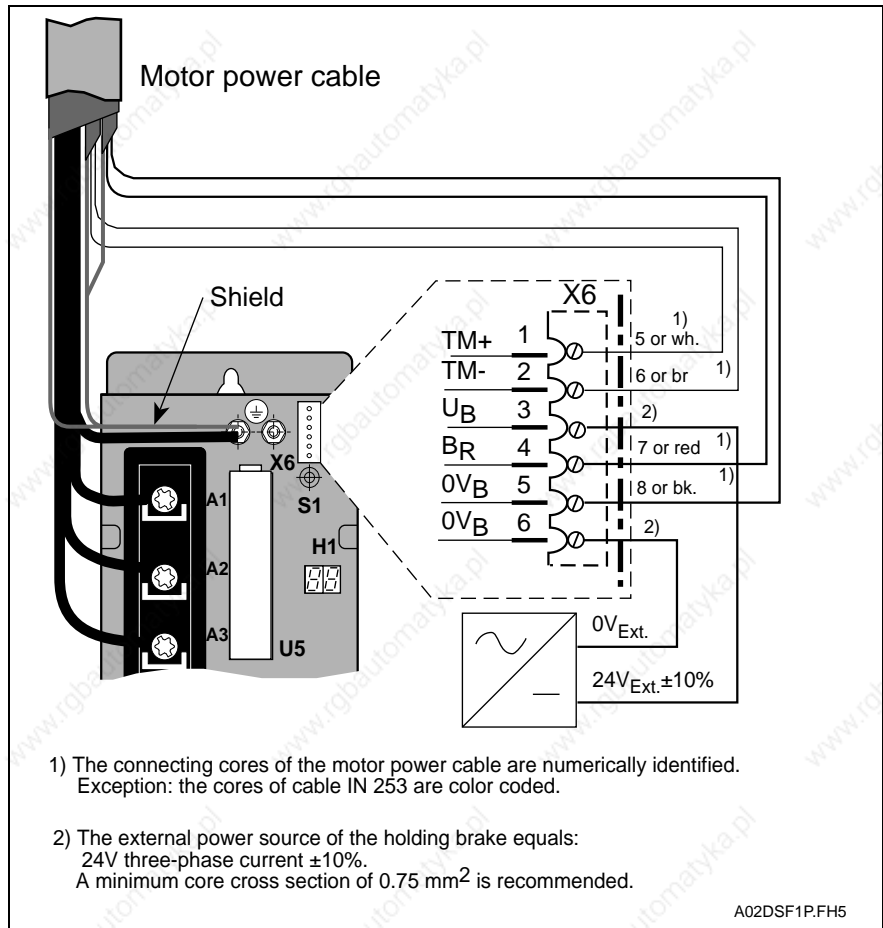

Fig. 6-5: Motor power cable connection - DDS02

Motor power connection - DDS03

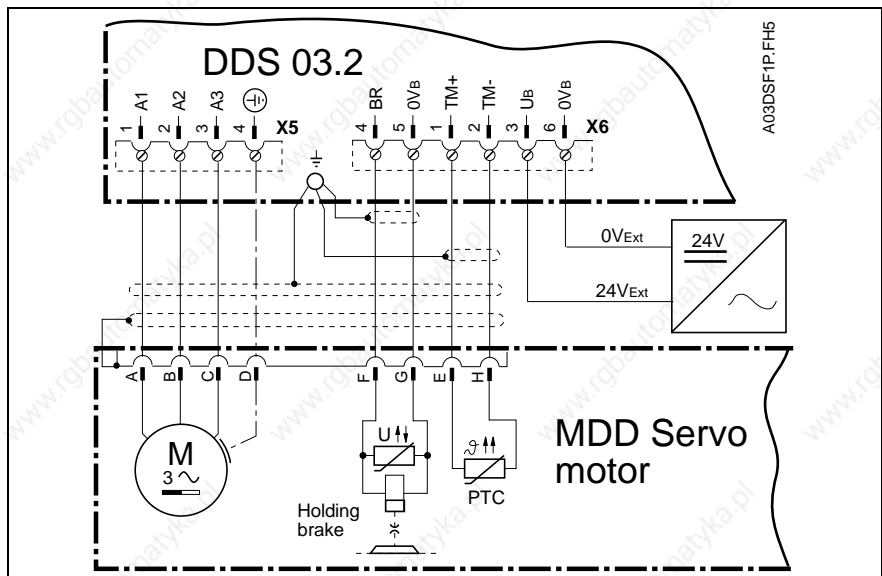

Fig. 6-6: Motor power connection, holding brake connection and motor temperature monitor - DDS03.2

Power cable connection - DDS03

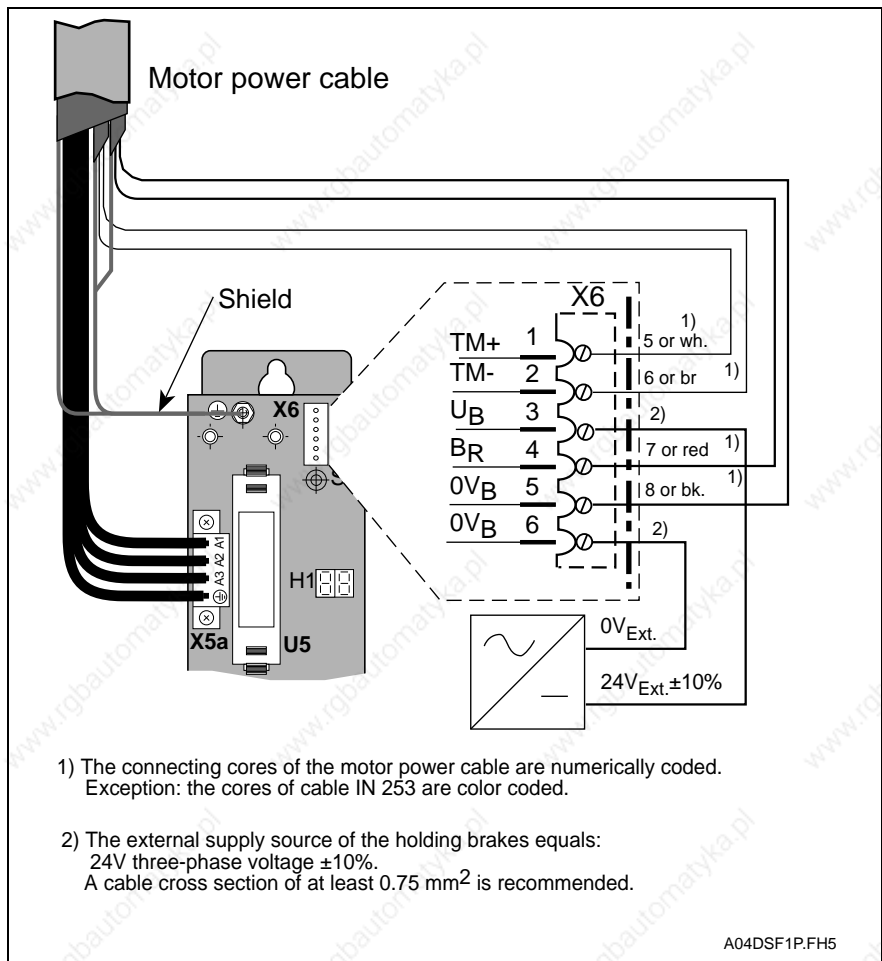

Fig. 6-7: Motor power cable connection - DDS03

Motor power cable connection

In terms of the motor, the connection takes the form of either a connector or a terminal box.

The DDS drive controller connections are outlined in the motor documentation as well as the circuitry with the precise clamp designations.

④ Connector X6: Holding brake, Motor temperature monitor

It is only necessary to connect DC 24V if a motor holding brake is used.

The current consumption of the holding brake is listed in the motor documentation.

The holding brake of MDD/MKD motors is not a service brake. It wears down after approximately 20,000 motor revolutions against the closed brake disc.

Note: To release the holding brake it is necessary to apply DC +24V +/- 10 % directly to the motor. The voltage to release the motor brake is applied at X6/3 and X6/6. It must be certain that the brake will effectively release even if longer motor power cables are used (the voltage drop resulting from longer motor power cables can be compensated with higher voltages (up to DC +28V) at X6/3 and X6/6).

Controlling the motor holding brake

The drive controller controls the motor holding brake.

Motor temperature monitor

A thermistor is connected at X6/1 and X6/2 (PTC or NTC, depending on motor type) (see Fig. 6-6).

⑤ DC bus voltage connection

Adjacent drive controllers are normally connected via the DC bus rails which are in accessories kit E .. - DDS 2. If DC bus rails are not needed for a specific connection, then it can be established via stranded leads that are as short as possible (maximum length is one meter). The cross section of the lead depends on the supply unit or the DC bus continuous output.

DC bus rails must be used with the DDS02.2-.200-... .

Supply units	DC bus continous output in kW	Line cross section in mm ²
TVM 1.2-...	7.5	4
TVM 2.2-.../ TVM 2.4-...	7.5	4
KDV 1.3-...	30	25
KDV 2.2-.../ KDV 2.3-...	30	25
KDV 3.1-...	30	25
KDV 4.1-...	30	25
TVD 1.2-08-3	7.5	4
TVD 1.2-15-3	15	10

Fig. 6-8: DC bus connections - required cross sections

⑥ Connector X1: Bus connection

The control electronics of the drive controllers are supplied via connector X1. The connection starts at the supply unit and runs to the drive controllers with the help of the bus cable. The bus cable is in kit E . . -DDS 2. Insert the cable with the black core at the bottom, into connector X1. Insert the end connector supplied in the kit (e.g.,: E3-TVD) of the supply unit into the last unit (the unit physically furthest away from the supply unit). In some cases, it is possible to use a special bus cable with a maximum length of one meter.

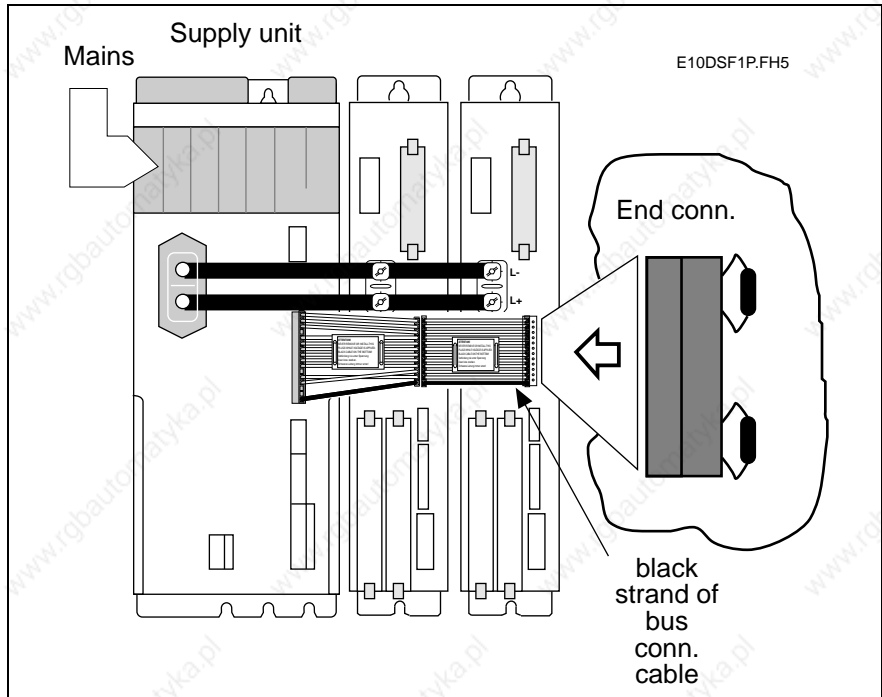

Fig. 6-9: Connecting the units via flat-ribbon cables and DC bus rails

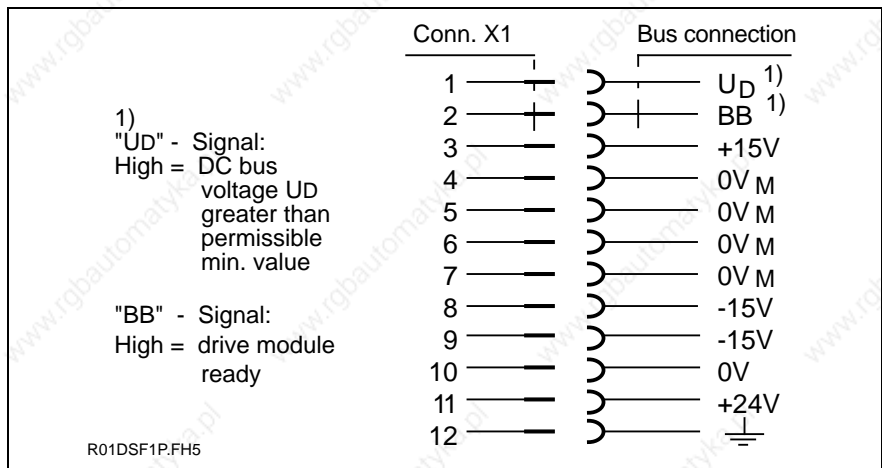

Fig. 6-10: Connector assignment X1

⑦ Connector X3

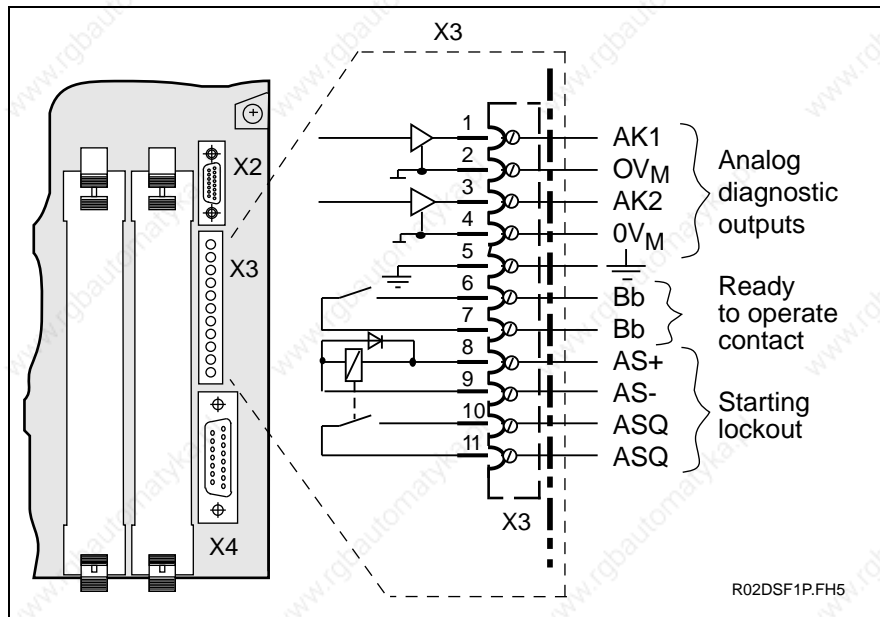

Fig. 6-11: Connector assignment X3

Analog diagnostic outputs AK1, AK2

The analog diagnostic outputs are analog outputs via which drive-internal variables are generated for test purposes, e.g., when commissioning. For further details on analog diagnostics outputs, please see the application description.

Current load capacity: 4 mA

Output voltage: DC 10 V

Ready to operate contact Bb

If ready to operate contact „Bb“ closes, then the drive controller is ready to receive power. It closes if the control voltage is on and all monitoring functions are signalling a ready state.

Contact „Bb“ can be evaluated in the control, for example, so that the control immediately recognizes which drive controller in the drive package had a power failure.

Switching capacity: DC 24 V, 1 A (short-term and continuous)

Note: The direct connection of a contactor coil to the Bb contact is not permitted as the contact could be overloaded by excessive short-term currents after frequent switching sequences thus causing it to break down.

The use of varistors as protective circuits is not acceptable as these require ever-higher levels of current over the course of their service life. This could cause early failures of the components and ultimately the unit as well.

**Starting lockout
AS+, AS-, ASQ, ASQ**

The starting lockout represents a safety device to prevent unintentional startups of the connected motors in the event of a fault. It makes sure that the separately working areas of a machine or plant are securely switched off.

Note: The starting lockout is not intended to bring to a standstill axes that are moving.

For further information on this subject, see the documentation "Starting lockout functions in DDS drive controllers" (Doc. no.: 209-0069-4313-XX).

AS+,AS-: control input for relay coils
voltage: DC 20 30 V
power: 1.5 W

ASQ, ASQ: potential free response contact which acknowledges the activation of a starting lockout to an external control.
Switching power: DC24V, 1A (short-term and continuous)

To activate the starting lockout, apply a voltage of DC +20 to 30V between input terminals AS+ and AS-. The switching of the startup relay in the drive controller is confirmed by closing the potential-free response contact (output ASQ - ASQ) at the external control.

⑧ Connector X2: RS232-interface

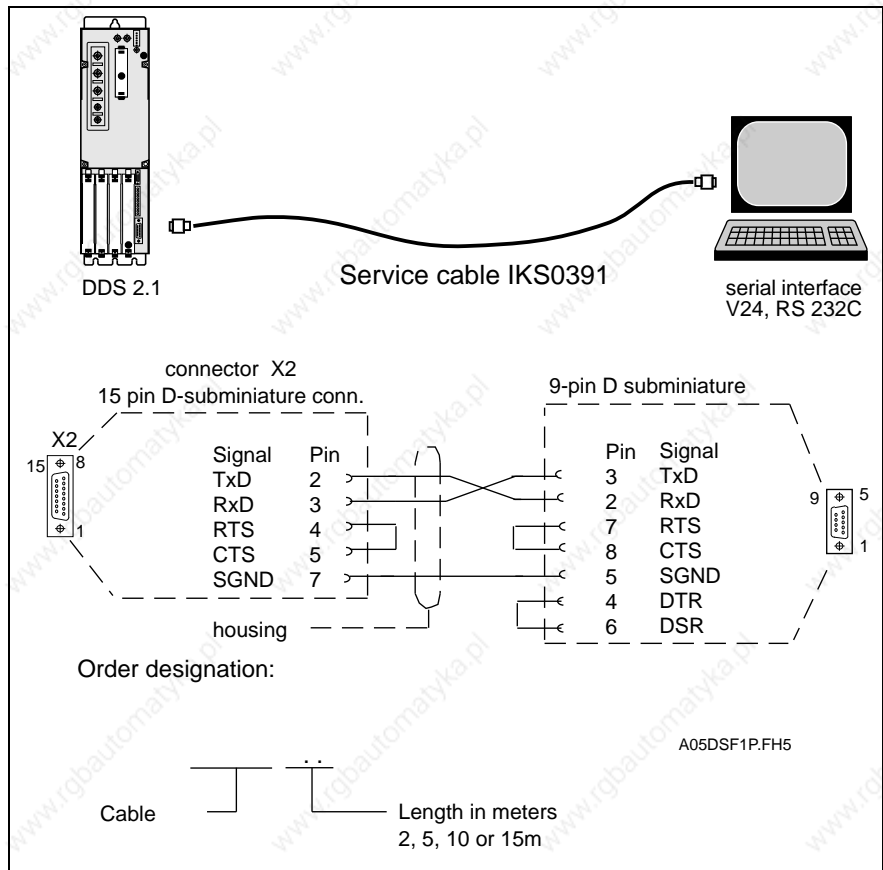

Fig. 6-12: Service cable

Service cable IKS0391 is needed to commission drive controllers with analog interface as this interface is used for parametrization during start-up with the use of a terminal or terminal program.

⑨ Connector X4: Motor feedback

The motor feedback is connected at X4.

The use of Indramat cables is recommended for the connections between drive controller and the servo motor feedback.

Feedback of MDD and MKD motors

MDD and MKD motors are equipped with their own measuring system which is connected to X4 of the basic unit.

Feedback of 2AD, ADF, 1MB and MBW motors

The motors 2AD, ADF, 1MB and MBW can be equipped with their own measuring system connected at X4 or a system connected at the respective interface plugin module. For further information, please see the motor documentation.

Feedback of LAR, LAF and LSF motors

The linear motors LAR, LAF and LSF do not have a feedback of their own. These motors are operated with an external system. These systems are not connected at the X4 feedback connection of the basic unit but rather at the plugin module needed for the system. For further information, see the motor documentation.

Maximum cable lengths

If Indramat feedback cables are used, then the maximum length equals 75 meters if the connection is made at X4 of the basic unit.

If a measuring system is connected at a plugin module, however, then the lengths relevant to the plugin modules must be complied with.

For further information on INDRAMAT feedback cables, please see the relevant motor documentation.

Feedback connection X4 in DDSxx.2-xxxx-B for digital servo feedback

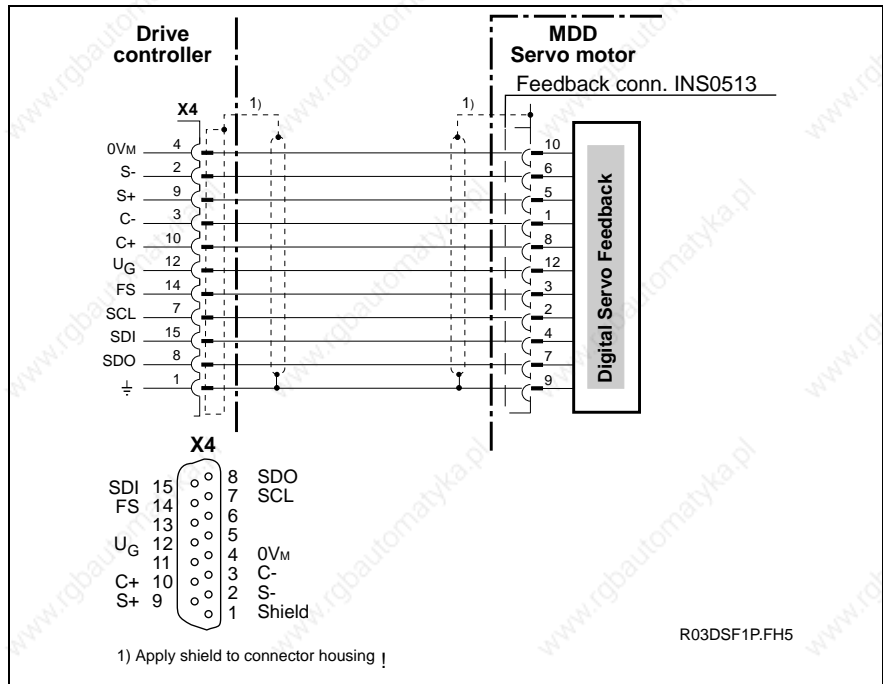

Fig. 6-13: Connector assignment of the X4 in a DDSxx.2-xxxx-B

Feedback connection X4 in DDSxx.2-xxxx-B for resolver feedback

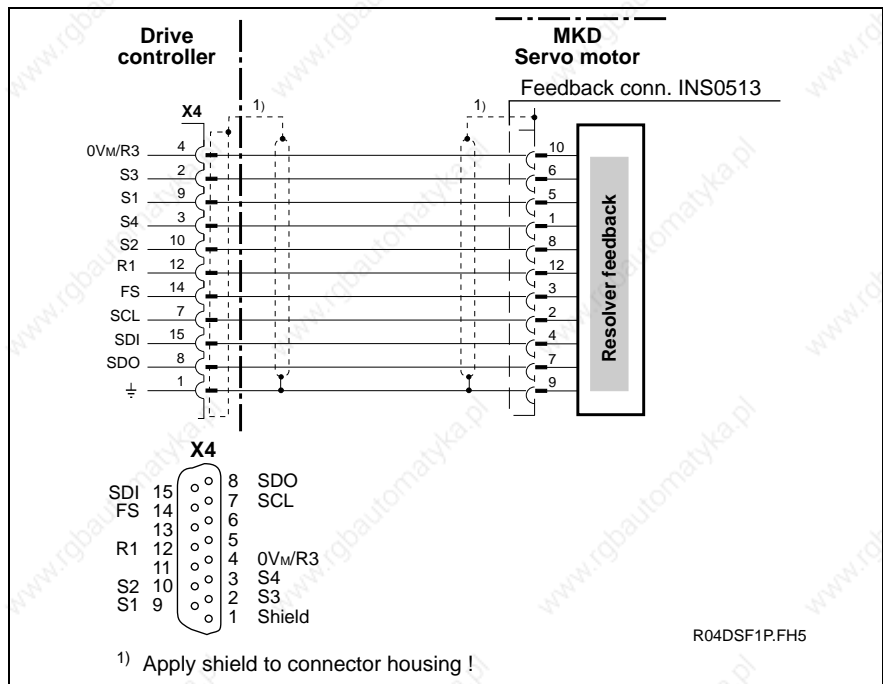

Fig. 6-14: Connector assignment of the X4 in a DDSxx.2-xxxx-B

⑩ Connector X13, X14a, X14b: Heatsink blower only with DDS02.2-A...

Connectors X13, X14a, X14b can only be found in the DDS 2.● - A... drive controllers (see dimensional sheet illustration).

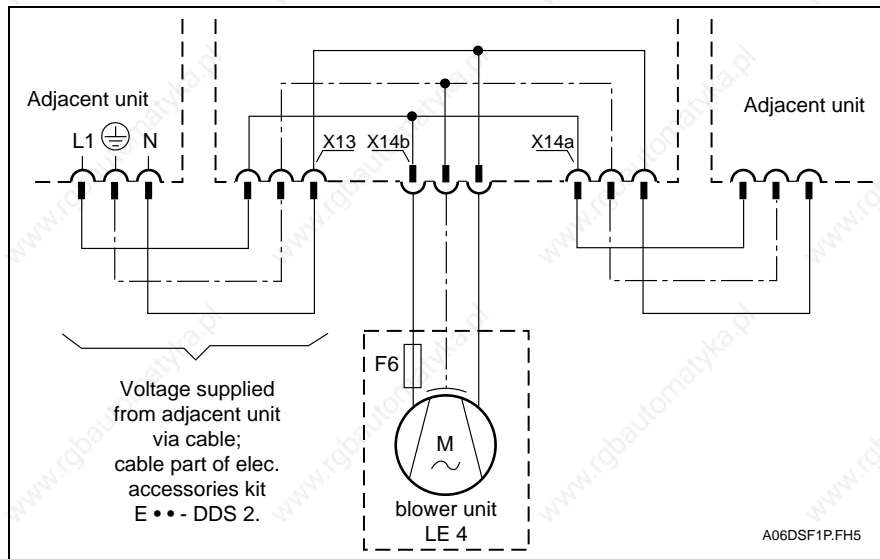

Fig. 6-15: Blower connection on the DDS02.2-A...

The DDS 2.●-A... should preferably be connected to an adjacent unit with a 230V or 115V blower connection. If this is not possible, then a connector is required (part no. 219 118). This connector will be delivered as of calendar week 10/95 along with the LE4 blower unit.

Blower Unit

Type	Supply voltage in V	Frequency in Hz	Maximum power consumption in VA	Fuse F6
LE4 220	AC 230 (+6/-10%)	50...60	70	0.630A/250E
LE4 115	AC 115 (±10%)	50...60	70	1.250A/250E

Fig. 6-16: Technical data for the LE4 blower unit

Terminal diagram overview

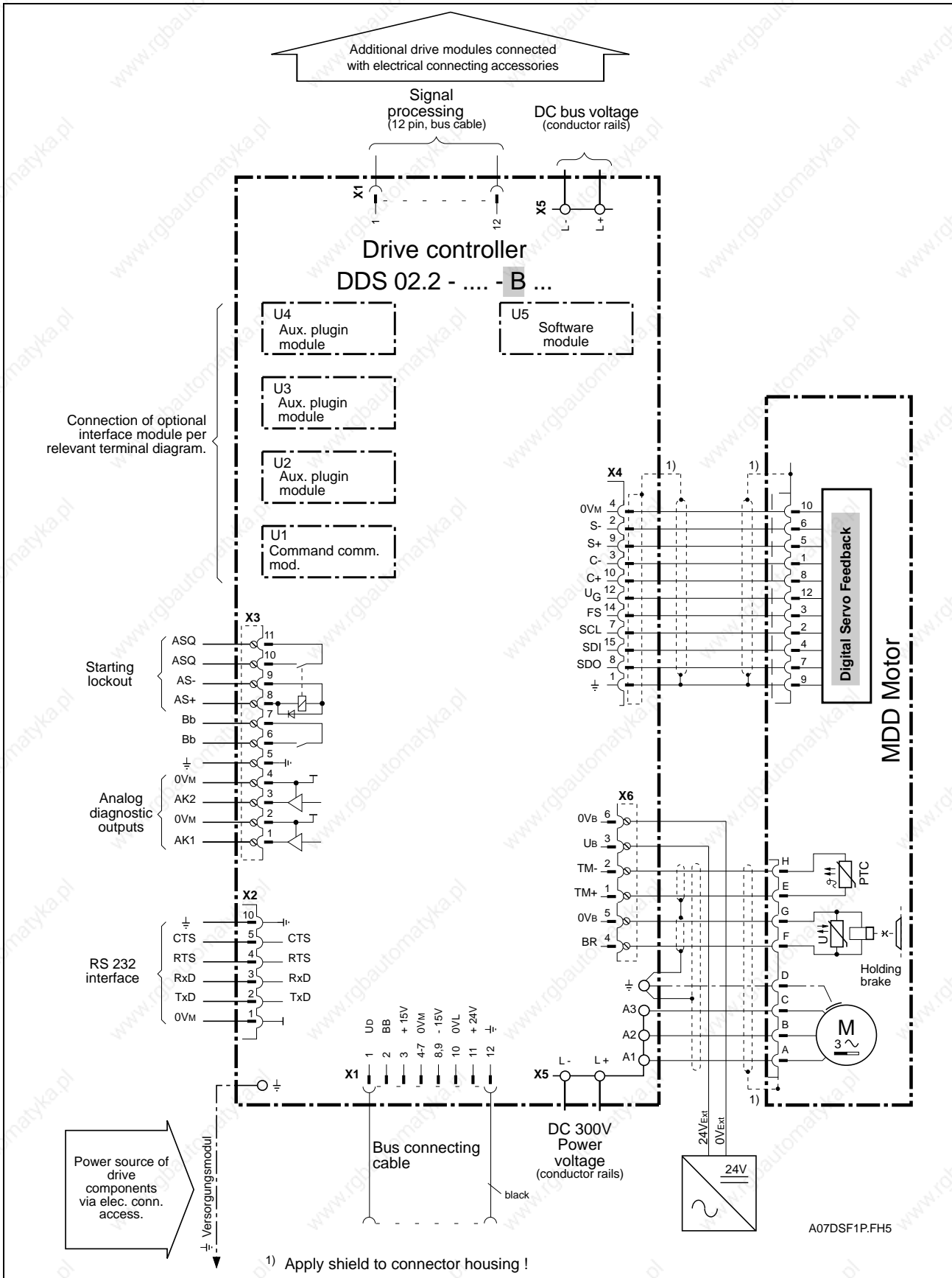

Fig. 6-17: Terminal diagram overview for the DDS02.2-... basic unit with MDD motor

The complete terminal diagram overview of the DDS02.2-...-D drive controllers shows a MDD motor with digital servo feedback (DSF) connected (see Fig. 6-17). This diagram serves as an example for this motor/controller combination.

The complete terminal diagram overview must, of course, be altered with different motor/controller combinations. The drive configuration description will outline which measuring system should be connected to which basic unit or plugin module.

Nr.	Motor	Controller	Difference to terminal diagram overview (see Fig. 6-17)
1	MDD with DSF and connector	DDS02.2-...-B	No difference
2	MDD with DSF and connector	DDS03.2-...-B	Slots U3 and U4 not extant
3	MDD with RSF and connector	DDS02.2-...-B	Clamp designations for X4 see Fig. 6-14
4	MDD with RSF and connector	DDS03.2-...-B	Slots U3 and U4 not extant Clamp designations for X4 see Fig. 6-14
5	MKD with RSF and Terminal box	DDS02.2-...-B	Clamp designations for X4 see Fig. 6-14 The connections to motor feedback and motor power connection can be found in the motor documentation
6	MKD with RSF and Terminal box	DDS03.2-...-B	Clamp designations for X4 see Fig. 6-14 Slots U3 and U4 not extant The connections to motor feedback and motor power connection can be found in the motor documentation
7	LAF	DDS02.2-...-B	X4 is free; Measuring system is connected to plugin module. Connection to the measuring system of motor and motor power connection can be found in the motor documentation
8	LAR with connector	DDS02.2-...-B	X4 is free; Measuring system is connected to plugin module. Connection to the measuring system of motor and motor power connection can be found in the motor documentation
9	LSF	DDS02.2-...-B	X4 is free; Measuring system is connected to plugin module. Connection to the measuring system of motor and motor power connection can be found in the motor documentation
10	2AD	DDS02.2-...-B	Connection to the measuring system of motor and motor power connection can be found in the motor documentation
11	ADF	DDS02.2-...-B	Connection to the measuring system of motor and motor power connection can be found in the motor documentation
12	1MB	DDS02.2-...-B	Connection to the measuring system of motor and motor power connection can be found in the motor documentation
13	MBW	DDS02.2-...-B	Connection to the measuring system of motor and motor power connection can be found in the motor documentation
DSF = digital servo feedback		RSF = resolver feedback	

Fig. 6-18: Differences to the complete terminal diagram overview

6.3 Connecting the plugin modules

Both the terminal diagrams and the technical data on the plugin modules are outlined in the document „DIAX03 Plugin module for digital intelligent drive controllers“.

7 Accessories

Connection accessories E..-DDS..

The electrical connecting accessories kit E..-DDS.. simplifies the task of connecting a drive package made up of various units with various allocations.

To be able to select this E..-DDS.. kit, it is necessary to know the exact allocation of the units within the control cabinet.

The DDS02 drive controller generally needs an E..-DDS 2 kit.

The DDS03 generally needs the E..-DDS 3 kit.

Connector kit S..-DDS 2

Connector kit S..-DDS 2 is also needed. It depends on the unit configuration. Connector kit S..-DDS 2 can be selected for the respective configuration as per Fig. 8.3.

Connector kit S..-DDS 2 is identical for both the DDS02 and the DDS03.

7.1 Electrical accessories kit E..-DDS 2

The following illustration is intended to assist in determining which E..-DDS 2 kit is needed to connect adjacent units.

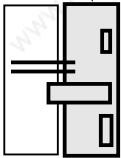
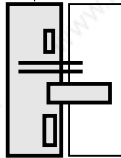
Electrical connecting accessories for drive controller types DDS 2.● - W																																																																																														
for connecting following units	orientation to the right	orientation to the left																																																																																												
	DDS 2.● - W DDS 2.● - F 	DDS 2.● - W DDS 2.● - F 																																																																																												
Type codes	Type codes	Type codes																																																																																												
KDV 1 KDV 2 KDV 3 KDV 4 KVR 1 TVD TVM TVR 2 TVR 3 DDS 2.● - W DDS 2.● - F DDS 2.● - A DDS 3 KDA KDF KDS TDA TDM 1 TFM TDM 3/4 TDM 6/7	<table border="0"> <tr> <td>E9-DDS 2</td> <td>E11-DDS 2</td> </tr> <tr> <td>E9-DDS 2</td> <td>E11-DDS 2</td> </tr> <tr> <td>E1-DDS 2</td> <td>E13-DDS 2</td> </tr> <tr> <td>E1-DDS 2</td> <td>E13-DDS 2</td> </tr> <tr> <td>E6-DDS 2</td> <td>E15-DDS 2</td> </tr> <tr> <td>E1-DDS 2</td> <td>E1-DDS 2</td> </tr> <tr> <td>E3-DDS 2</td> <td>E17-DDS 2</td> </tr> <tr> <td>E6-DDS 2</td> <td>E6-DDS 2</td> </tr> <tr> <td>E1-DDS 2</td> <td>E1-DDS 2</td> </tr> <tr><td colspan="2"> </td></tr> <tr> <td>E3-DDS 2</td> <td>E3-DDS 2</td> </tr> <tr> <td>E3-DDS 2</td> <td>E3-DDS 2</td> </tr> <tr> <td>E3-DDS 2</td> <td>E17-DDS 2</td> </tr> <tr> <td>E8-DDS 2</td> <td>E8-DDS 2</td> </tr> <tr> <td>E4-DDS 2</td> <td>E18-DDS 2</td> </tr> <tr> <td>E9-DDS 2</td> <td>E11-DDS 2</td> </tr> <tr> <td>E9-DDS 2</td> <td>E11-DDS 2</td> </tr> <tr> <td>E4-DDS 2</td> <td>E4-DDS 2</td> </tr> <tr> <td>E3-DDS 2</td> <td>E3-DDS 2</td> </tr> <tr> <td>E3-DDS 2</td> <td>E3-DDS 2</td> </tr> <tr> <td>E3-DDS 2</td> <td>E3-DDS 2</td> </tr> <tr> <td>E8-DDS 2</td> <td>E8-DDS 2</td> </tr> <tr> <td>E8-DDS 2</td> <td>E8-DDS 2</td> </tr> </table>	E9-DDS 2	E11-DDS 2	E9-DDS 2	E11-DDS 2	E1-DDS 2	E13-DDS 2	E1-DDS 2	E13-DDS 2	E6-DDS 2	E15-DDS 2	E1-DDS 2	E1-DDS 2	E3-DDS 2	E17-DDS 2	E6-DDS 2	E6-DDS 2	E1-DDS 2	E1-DDS 2			E3-DDS 2	E3-DDS 2	E3-DDS 2	E3-DDS 2	E3-DDS 2	E17-DDS 2	E8-DDS 2	E8-DDS 2	E4-DDS 2	E18-DDS 2	E9-DDS 2	E11-DDS 2	E9-DDS 2	E11-DDS 2	E4-DDS 2	E4-DDS 2	E3-DDS 2	E3-DDS 2	E3-DDS 2	E3-DDS 2	E3-DDS 2	E3-DDS 2	E8-DDS 2	E8-DDS 2	E8-DDS 2	E8-DDS 2	<table border="0"> <tr> <td>E5-DDS 2</td> <td>E12-DDS 2</td> </tr> <tr> <td>E5-DDS 2</td> <td>E12-DDS 2</td> </tr> <tr> <td>E2-DDS 2</td> <td>E14-DDS 2</td> </tr> <tr> <td>E2-DDS 2</td> <td>E14-DDS 2</td> </tr> <tr> <td>E7-DDS 2</td> <td>E16-DDS 2</td> </tr> <tr> <td>E2-DDS 2</td> <td>E2-DDS 2</td> </tr> <tr> <td>E3-DDS 2</td> <td>E17-DDS 2</td> </tr> <tr> <td>E7-DDS 2</td> <td>E7-DDS 2</td> </tr> <tr> <td>E2-DDS 2</td> <td>E2-DDS 2</td> </tr> <tr><td colspan="2"> </td></tr> <tr> <td>E3-DDS 2</td> <td>E3-DDS 2</td> </tr> <tr> <td>E3-DDS 2</td> <td>E3-DDS 2</td> </tr> <tr> <td>E3-DDS 2</td> <td>E17-DDS 2</td> </tr> <tr> <td>E10-DDS 2</td> <td>E10-DDS 2</td> </tr> <tr> <td>E5-DDS 2</td> <td>E12-DDS 2</td> </tr> <tr> <td>E5-DDS 2</td> <td>E12-DDS 2</td> </tr> <tr> <td>E5-DDS 2</td> <td>E12-DDS 2</td> </tr> <tr> <td>E5-DDS 2</td> <td>E5-DDS 2</td> </tr> <tr> <td>E3-DDS 2</td> <td>E3-DDS 2</td> </tr> <tr> <td>E3-DDS 2</td> <td>E3-DDS 2</td> </tr> <tr> <td>E3-DDS 2</td> <td>E3-DDS 2</td> </tr> <tr> <td>E10-DDS 2</td> <td>E10-DDS 2</td> </tr> <tr> <td>E10-DDS 2</td> <td>E10-DDS 2</td> </tr> </table>	E5-DDS 2	E12-DDS 2	E5-DDS 2	E12-DDS 2	E2-DDS 2	E14-DDS 2	E2-DDS 2	E14-DDS 2	E7-DDS 2	E16-DDS 2	E2-DDS 2	E2-DDS 2	E3-DDS 2	E17-DDS 2	E7-DDS 2	E7-DDS 2	E2-DDS 2	E2-DDS 2			E3-DDS 2	E3-DDS 2	E3-DDS 2	E3-DDS 2	E3-DDS 2	E17-DDS 2	E10-DDS 2	E10-DDS 2	E5-DDS 2	E12-DDS 2	E5-DDS 2	E12-DDS 2	E5-DDS 2	E12-DDS 2	E5-DDS 2	E5-DDS 2	E3-DDS 2	E3-DDS 2	E3-DDS 2	E3-DDS 2	E3-DDS 2	E3-DDS 2	E10-DDS 2	E10-DDS 2	E10-DDS 2	E10-DDS 2
E9-DDS 2	E11-DDS 2																																																																																													
E9-DDS 2	E11-DDS 2																																																																																													
E1-DDS 2	E13-DDS 2																																																																																													
E1-DDS 2	E13-DDS 2																																																																																													
E6-DDS 2	E15-DDS 2																																																																																													
E1-DDS 2	E1-DDS 2																																																																																													
E3-DDS 2	E17-DDS 2																																																																																													
E6-DDS 2	E6-DDS 2																																																																																													
E1-DDS 2	E1-DDS 2																																																																																													
E3-DDS 2	E3-DDS 2																																																																																													
E3-DDS 2	E3-DDS 2																																																																																													
E3-DDS 2	E17-DDS 2																																																																																													
E8-DDS 2	E8-DDS 2																																																																																													
E4-DDS 2	E18-DDS 2																																																																																													
E9-DDS 2	E11-DDS 2																																																																																													
E9-DDS 2	E11-DDS 2																																																																																													
E4-DDS 2	E4-DDS 2																																																																																													
E3-DDS 2	E3-DDS 2																																																																																													
E3-DDS 2	E3-DDS 2																																																																																													
E3-DDS 2	E3-DDS 2																																																																																													
E8-DDS 2	E8-DDS 2																																																																																													
E8-DDS 2	E8-DDS 2																																																																																													
E5-DDS 2	E12-DDS 2																																																																																													
E5-DDS 2	E12-DDS 2																																																																																													
E2-DDS 2	E14-DDS 2																																																																																													
E2-DDS 2	E14-DDS 2																																																																																													
E7-DDS 2	E16-DDS 2																																																																																													
E2-DDS 2	E2-DDS 2																																																																																													
E3-DDS 2	E17-DDS 2																																																																																													
E7-DDS 2	E7-DDS 2																																																																																													
E2-DDS 2	E2-DDS 2																																																																																													
E3-DDS 2	E3-DDS 2																																																																																													
E3-DDS 2	E3-DDS 2																																																																																													
E3-DDS 2	E17-DDS 2																																																																																													
E10-DDS 2	E10-DDS 2																																																																																													
E5-DDS 2	E12-DDS 2																																																																																													
E5-DDS 2	E12-DDS 2																																																																																													
E5-DDS 2	E12-DDS 2																																																																																													
E5-DDS 2	E5-DDS 2																																																																																													
E3-DDS 2	E3-DDS 2																																																																																													
E3-DDS 2	E3-DDS 2																																																																																													
E3-DDS 2	E3-DDS 2																																																																																													
E10-DDS 2	E10-DDS 2																																																																																													
E10-DDS 2	E10-DDS 2																																																																																													

The DDS 2.● - A should preferably be connected to an adjacent unit with 220 V or 115 V blower connection. If this is not possible, then the connector 219 118 is needed for the blower connection of the DDS 2.● - A. As of 10/95, this connector will be delivered with the blower unit LE 4.

Y01DSF1P.FH5

Fig. 7-1: An overview of the electrical connection accessories E..-DDS 2

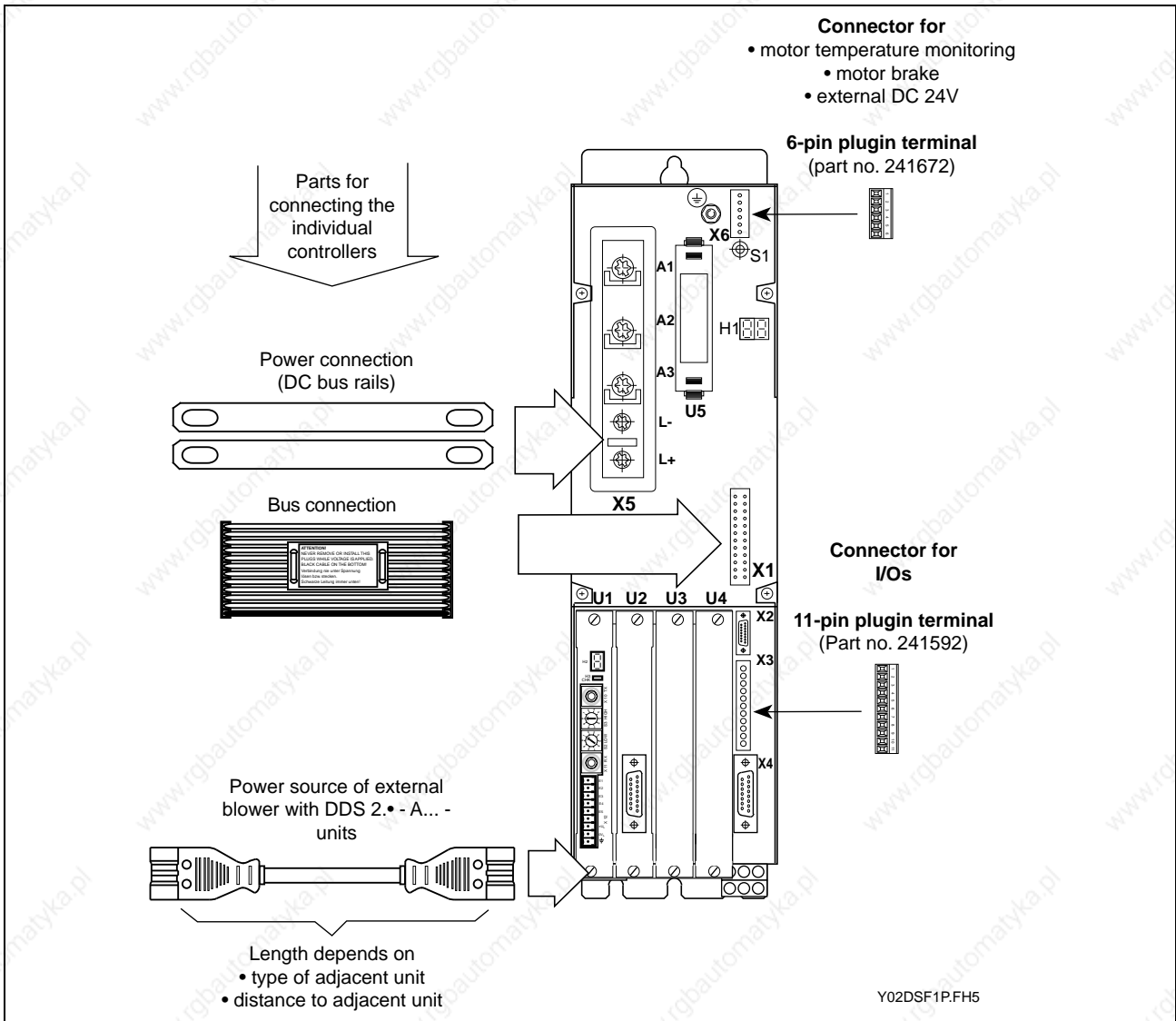
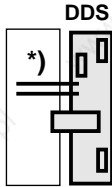
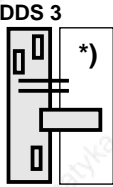

Fig. 7-2: Components of the electrical kit E...-DDS 2

7.2 Electrical accessories kit E..-DDS 3

The following illustration is intended to assist in determining which E..-DDS 3 kit is needed to connect adjacent units.

*)The unit to which the DDS 3 drive controller is to be connected.	The electrical connecting accessories required for the connection	
	orientation to the <u>right</u>	orientation to the <u>left</u>
		
Type codes	Type codes	Type codes
KDV 1 KDV 2 KDV 3 KDV 4 KVR 1 TVD TVM TVR 3 TVR 2 DDS 2 DDS 3 KDA KDF KDS TDA TDM 1 TFM TDM 3/4 TDM 6/7	E10-DDS 3 E10-DDS 3 E1-DDS 3 E1-DDS 3 E7-DDS 3 E1-DDS 3 E3-DDS 3 E1-DDS 3 E7-DDS 3 E3-DDS 3 E9-DDS 3 E5-DDS 3 E10-DDS 3 E10-DDS 3 E5-DDS 3 E3-DDS 3 E3-DDS 3 E9-DDS 3 E9-DDS 3	E6-DDS 3 E6-DDS 3 E2-DDS 3 E2-DDS 3 E8-DDS 3 E2-DDS 3 E4-DDS 3 E2-DDS 3 E8-DDS 3 E4-DDS 3 E9-DDS 3 E6-DDS 3 E6-DDS 3 E6-DDS 3 E6-DDS 3 E4-DDS 3 E4-DDS 3 E9-DDS 3 E9-DDS 3

Y03DSF1P.FH5

Fig. 7-3: A general overview of the electrical kit E..-DDS 3

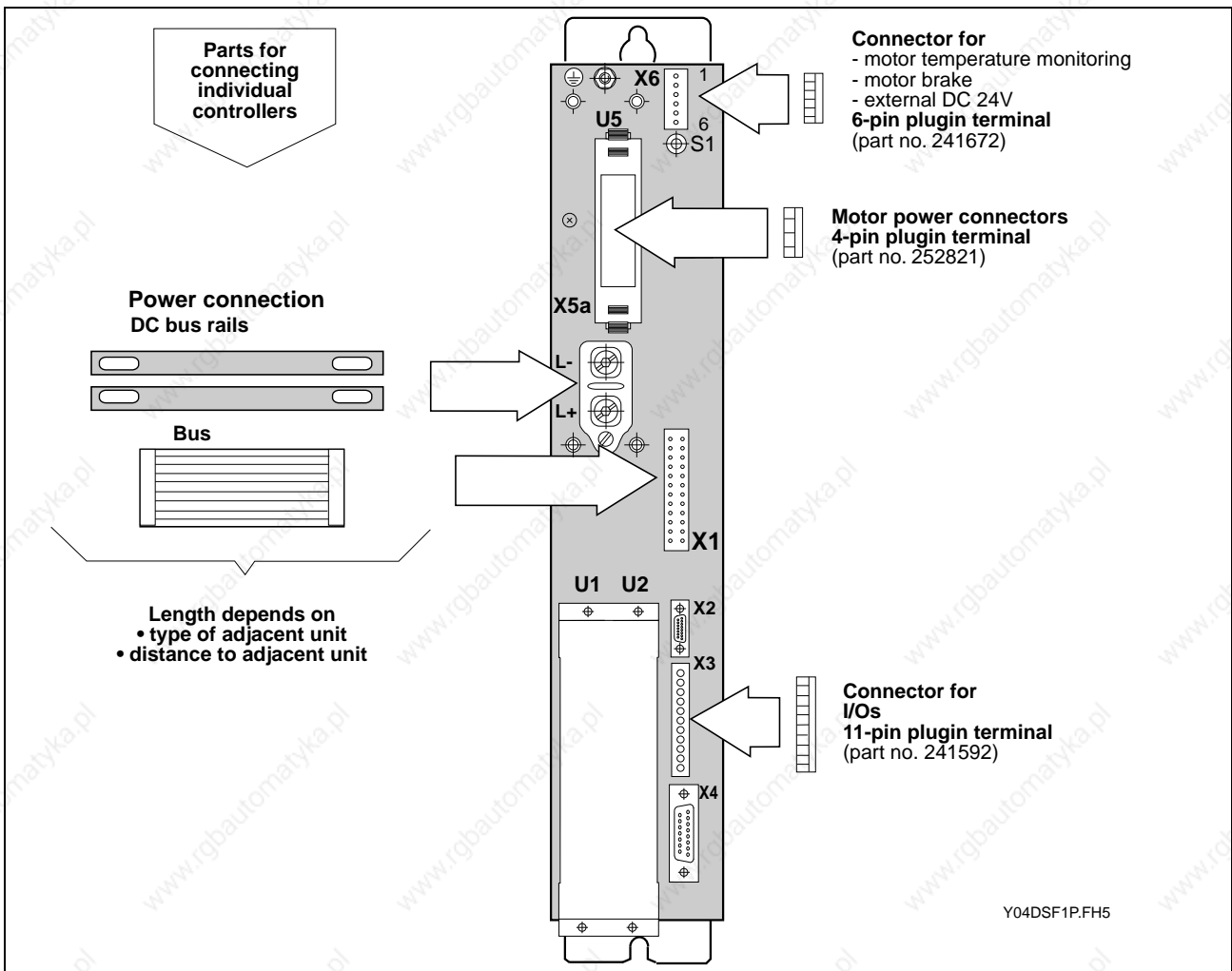

Fig. 7-4: Components of the kit E..-DDS 3

7.3 Connector kit for various configurations

There exists a connector kit S . . - DDS 2 for every unit configuration. The connector for the plugin modules inserted into the configured drive controllers and the motor feedback connector (X4) are in this kit.

Configuration	Connector kit	Configuration	Connector kit	Configuration	Connector kit
BE01-01-FW	S69-DDS 2	BE24-01-FW	S63-DDS 2	BE51-01-FW	S61-DDS 2
BE01-02-FW	S69-DDS 2	BE24-02-FW	S63-DDS 2	BE51-02-FW	S61-DDS 2
BE02-01-FW	S54-DDS 2	BE25-01-FW	S43-DDS 2	BE51-03-FW	S61-DDS 2
BE02-02-FW	S54-DDS 2	BE27-01-FW	S51-DDS 2	BE52-01-FW	S64-DDS 2
BE03-01-FW	S55-DDS 2	BE28-01-FW	S20-DDS 2	BE52-02-FW	S64-DDS 2
BE03-02-FW	S55-DDS 2	BE29-01-FW	S64-DDS 2	BE53-01-FW	S64-DDS 2
BE04-01-FW	S56-DDS 2	BE29-02-FW	S64-DDS 2	BE53-02-FW	S64-DDS 2
BE04-02-FW	S56-DDS 2	BE30-01-FW	S48-DDS 2	BE54-01-FW	S65-DDS 2
BE05-01-FW	S57-DDS 2	BE31-01-FW	S 3-DDS 2	BE55-01-FW	S48-DDS 2
BE05-02-FW	S57-DDS 2	BE32-01-FW	S 3-DDS 2	BE57-01-FW	S68-DDS 2
BE05-03-FW	S57-DDS 2	BE33-01-FW	S29-DDS 2	BE61-01-FW	S61-DDS 2
BE06-01-FW	S29-DDS 2	BE34-01-FW	S60-DDS 2	BE61-02-FW	S61-DDS 2
BE07-01-FW	S57-DDS 2	BE34-02-FW	S60-DDS 2	BE62-01-FW	S21-DDS 2
BE07-02-FW	S57-DDS 2	BE35-01-FW	S64-DDS 2	BE63-01-FW	S70-DDS 2
BE07-03-FW	S57-DDS 2	BE35-02-FW	S64-DDS 2	BE65-01-FW	S71-DDS 2
BE08-01-FW	S22-DDS 2	BE37-01-FW	S65-DDS 2	BE69-01-FW	S72-DDS 2
BE09-01-FW	S21-DDS 2	BE38-01-FW	S58-DDS 2	BE69-02-FW	S72-DDS 2
BE10-01-FW	S58-DDS 2	BE39-01-FW	S50-DDS 2	BE70-01-FW	S73-DDS 2
BE11-01-FW	S59-DDS 2	BE39-02-FW	S50-DDS 2	BE71-01-FW	S74-DDS 2
BE11-02-FW	S59-DDS 2	BE40-01-FW	S48-DDS 2	BE71-02-FW	S74-DDS 2
BE12-01-FW	S 2-DDS 2	BE41-01-FW	S66-DDS 2	BE71-03-FW	S74-DDS 2
BE13-01-FW	S20-DDS 2	BE41-02-FW	S66-DDS 2	BE72-01-FW	S75-DDS 2
BE14-01-FW	S60-DDS 2	BE42-01-FW	S66-DDS 2	BE72-02-FW	S75-DDS 2
BE14-02-FW	S60-DDS 2	BE42-02-FW	S66-DDS 2	BE74-01-FW	S52-DDS 2
BE15-01-FW	S22-DDS 2	BE42-03-FW	S66-DDS 2	BE74-02-FW	S52-DDS 2
BE16-01-FW	S61-DDS 2	BE43-01-FW	S63-DDS 2	BE75-01-FW	S83-DDS 2
BE16-02-FW	S61-DDS 2	BE43-02-FW	S63-DDS 2	BE75-02-FW	S83-DDS 2
BE17-01-FW	S61-DDS 2	BE44-01-FW	S62-DDS 2	BE76-01-FW	S 3-DDS 2
BE17-02-FW	S61-DDS 2	BE44-02-FW	S62-DDS 2	BE77-00-FW	S60-DDS 2
BE18-01-FW	S57-DDS 2	BE45-01-FW	S67-DDS 2	BE78-00-FW	S29-DDS 2
BE18-02-FW	S57-DDS 2	BE46-01-FW	S50-DDS 2	BE79-01-FW	S65-DDS 2
BE20-01-FW	S62-DDS 2	BE46-02-FW	S50-DDS 2	BE80-01-FW	S58-DDS 2
BE20-02-FW	S62-DDS 2	BE47-01-FW	S51-DDS 2	BE81-00-FW	S57-DDS 2
BE21-01-FW	S57-DDS 2	BE48-01-FW	S68-DDS 2	BE95-01-FW	S53-DDS 2
BE21-02-FW	S57-DDS 2	BE49-01-FW	S69-DDS 2	BE95-02-FW	S53-DDS 2
BE22-01-FW	S43-DDS 2	BE49-02-FW	S69-DDS 2		
BE23-01-FW	S30-DDS 2	BE50-01-FW	S21-DDS 2		

If drive controllers equipped with SERCOS interface are used, then it is necessary to additionally order fiber optic cable connections (cable and connector or ready-made cables).

Fig. 7-5: Determining the connector kit for a unit configuration

7.4 Service cable IKS0391

Service cable IKS0391 is needed to startup drives with ANALOG interface (see Fig. 6-12) as parametrization is conducted during startup via this interface using a terminal or terminal program.

7.5 Selecting the fiber optic cable connections (LWL)

The SERCOS interface implements a fiber optic cable (LWL) to communicate between drive and control.

For further information on the topic "Fiber optic cable" please see the application description "Handling fiber optic cables" (doc. no. 209-0090-4101-xx).

In this document, the following points are discussed:

- general information about such cables
- basic planning guidelines for optical transmission systems
- routing guidelines for fiber optic cables
- attenuation measurements for ready-made fiber optic cables
- available LWL-FSMA plugin connectors and LWL cables
- how to make FSMA connectors
- tools for making LWL cables

Use the following illustration to determine the order data of the fiber optic cables for the entire system.

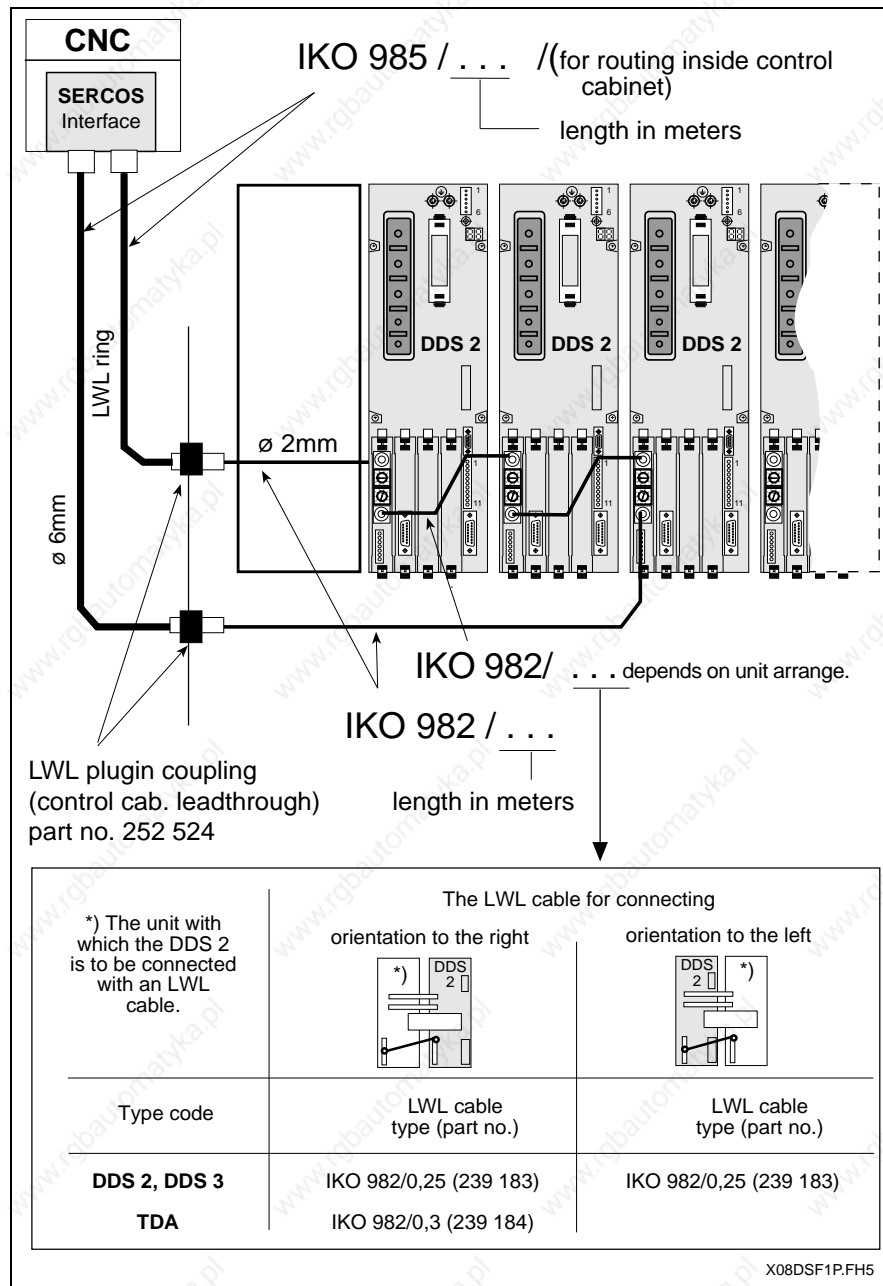

Fig. 7-6: Select the ready-made LWL cable for a SERCOS ring

7.6 Mechanical accessories for DDS02.2-A***-*

Blower unit LE4 220, LE4 115

The blower unit LE4 contains those parts designated with a (1) in Fig. 5-7.

- LE4 220 for a mains voltage of AC 220V, 50...60 Hz
- LE4 115 for a mains voltage of AC 115V, 50...60 Hz

Mechanical accessories kit M1-KD

The M1-KD accessories those parts designated with a (2) in Fig. 5-7.

7.7 Mechanical accessories for DDS02.2-F***-* drive controllers (Liquid cooling)

Accessory kit
SH - FL

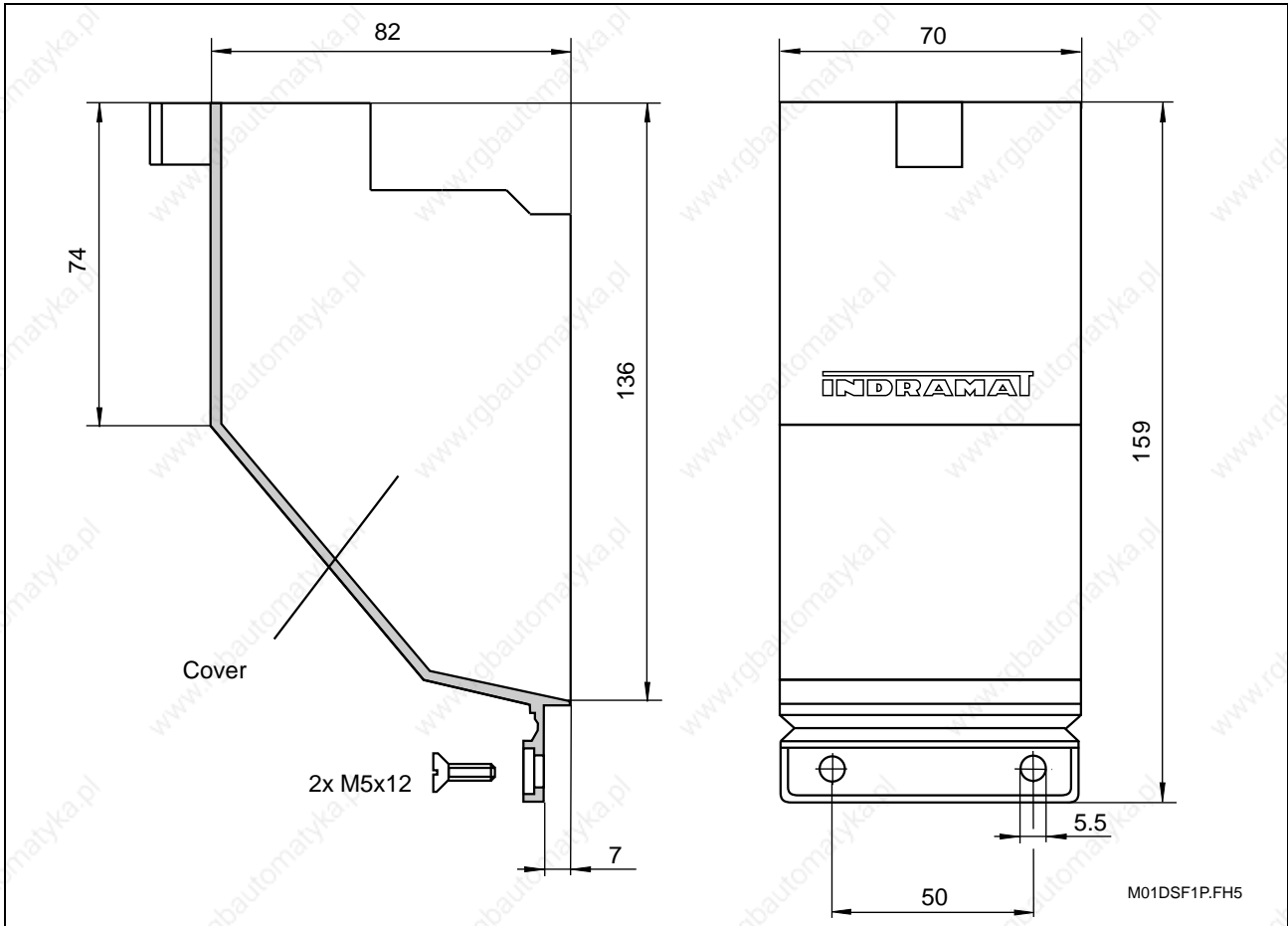

Fig. 7-7: Dimensional sheet for accessory kit SH - FL

Accessory kit
M2-F

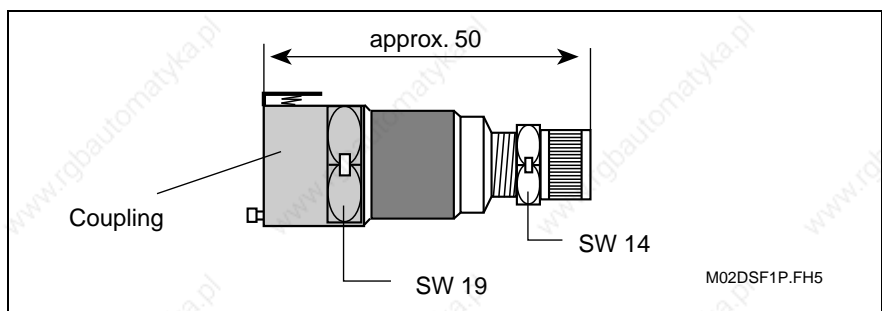

Fig. 7-8: Dimensional sheet for accessory kit M2-F

Kit M2-F contains two coupling units for the liquid cooling option of a drive controller.

8 Powering up the power sections using charging resistors

Powering up the power section via charging resistors „RL “ is an option which must be selected with:

Power supply units TVM 2.1 / 2.4 - under the following conditions:

- power transformer > 10 KVA
- power transformer > 2.5 KVA and auxiliary capacitance
- no power transformer because of 220 V three-phase mains

Power supply unit KDV 1.3 - under the following conditions:

- power transformer > 50 KVA
- power transformer > 35 KVA and auxiliary capacitance
- no power transformer because of 220 V three-phase mains

Note: The Bb contact of the DDS2 drive controller closes if all monitoring functions signal a ready state. Unlike the analog drive controllers TDM and KDS, the Bb contact can no longer be used to bridge the charging resistors.

Compare ready to operate

Bb contact is closed with TDM and KDS drive controllers, if:	Bb contact is closed with DDS drive controllers, if:
<p>drive controller is ready to output power</p> <p>(Bb can be used as signal to bridge the charging resistors)</p> <p>Contact „Bb“ closes if the power is switched on and all monitoring functions are signalling that all is in order</p> <p>Diagnosis: any unit that has failed in the drive package cannot be determined via the Bb contact</p>	<p>DDS drive controller ready for power to be switched on</p> <p>(Bb cannot be used as signal to bridge the charging resistors)</p> <p>Contact „Bb“ closes if the control voltage is switched on and all monitoring functions are signalling that all is in order.</p> <p>Diagnosis: any unit that has failed in the drive package can be determined via the Bb contact.</p>

Fig. 8-1: Comparison of ready to operate signals

Control voltage for KDV 1.3, TVM 2.1 and TVM 2.4 supply units:

- with charging resistors
- with DC bus dynamic brake

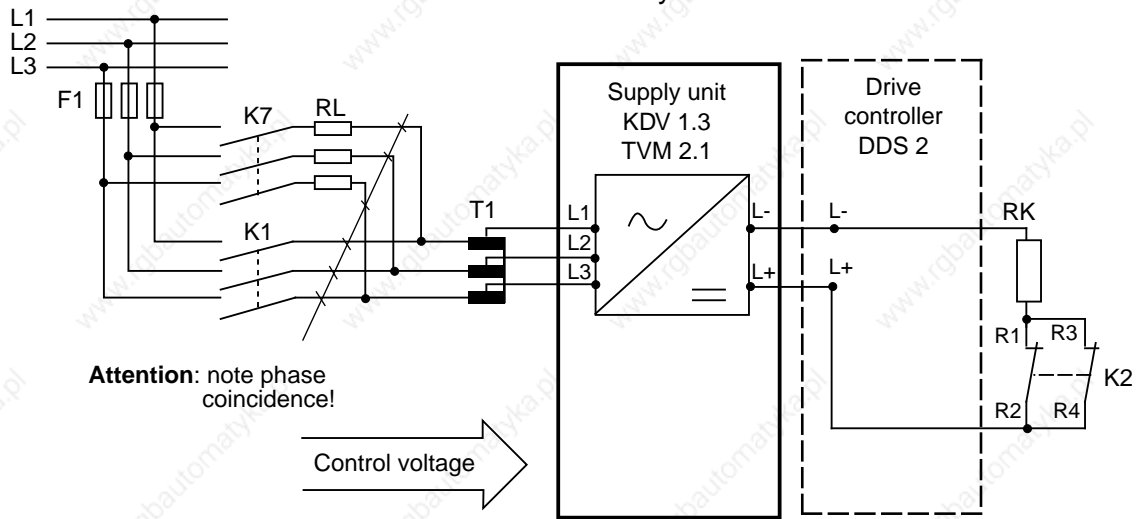

Attention: note phase coincidence!

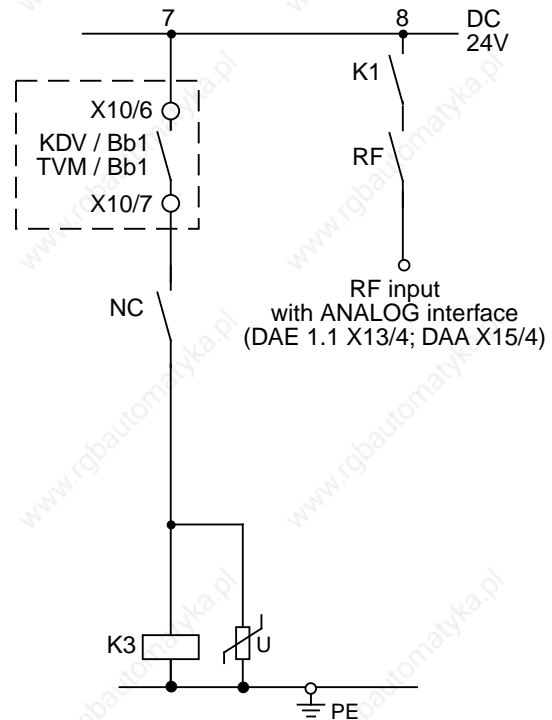
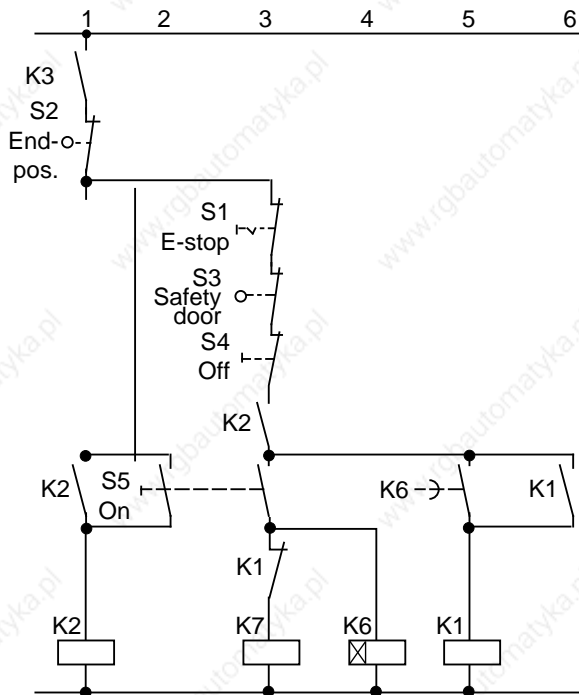

- Bb1 = Supply module ready (drive system)
- F1 = Power supply fuse
- K1 = Mains contactor
- K2 = DC bus dyn. brake contactor
- K3 = Release Bb1
- K6 = Pickup delay approx. 500 ms
- K7 = Load contactor
- NC = Control error message
 - open with fault in drive (servo error)
 - closed with E-stop

- RF = Control drive enable signal
- RK = DC bus dyn. brake resistor
- RL = Charging resistor
- S1 = E-stop
- S2 = End pos. of axis
- S3 = Safety doors
- S4 = Power off
- S5 = Power on, reset DC bus dyn. brake
- T1 = No matching transf. with 3 x AC 220 V

ATTENTION: Once K2 has been released, do not switch contactor back on for 0.5s. It must be prevented that K2 is released and picked up due to successive opening and closing of S2 or K3. This could damage K2. Contactor K2, once switched off, may only be switched back on with a defined command (e.g., S5).

B01DSF1P.FH5

Fig. 8-2: Control voltage with indirect powering up of the power section via charging resistors in DDS drive controllers

9 Condition at delivery

The merchandise is packed into cartons at the time of delivery. In the case of individual or mixed orders (several different units), all units are packed in individual one-way cartons. Accessories are in a separate carton. All individual cartons are combined in one large transport container at the time of delivery (on a carton or pallet).

If several units are delivered, then two-way packaging can be used.

There is an envelope containing two delivery slips on the transport container. There are no other papers, unless specifically requested.

Packaging can be opened without causing damage by simply separating the glued strips!

10 Identifying the merchandise

In the case of a mixed order, the transport container contains the individually packaged controllers and accessories. In the case of a multiple order of the same units, the accessories may be placed in a separate transport container.

There is a barcode sticker on the DDS package. It identifies the contents in type and order processing.



Fig. 10-1: Barcode sticker on the DDS packaging (example)

If several identical units are in one package, then the serial numbers of all the units contained therein are under the barcode sticker (only in the case of two-way packaging).

There is a rating plate on the front of the DDS.

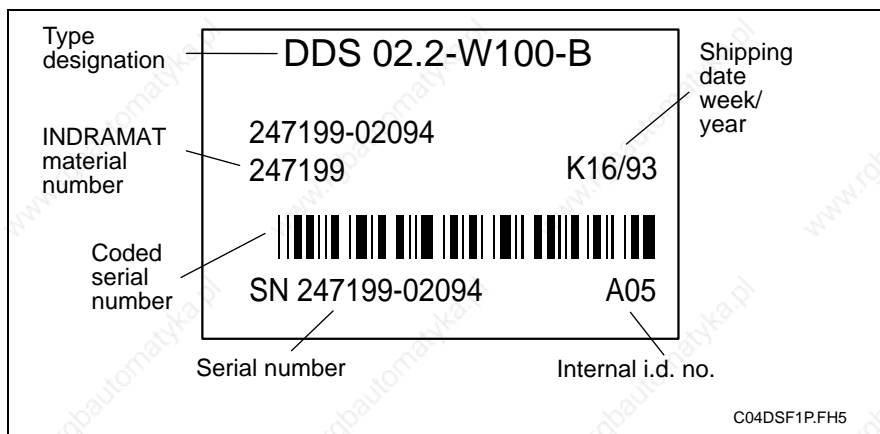

Fig. 10-2: Rating plate on the basic DDS unit

Accessories

The accessories are packed in bags. The order designation is written on the bag. There is a slip in the bag which lists order number and the accessory parts. In the case of ready-made cables, the order number is affixed to the cable. Any other types of cables have the cable number printed on them.







<p>Page 1</p> <p style="text-align: right;">INDRAMAT</p> <p style="text-align: center;">S1 - DDS 2</p>  <p style="text-align: center;">250 811</p> <p>For unit configurations:</p> <p>DA01-00 DA02-00</p> <p>Page 3</p>	<p>Page 2</p> <table border="1"> <thead> <tr> <th>No.</th> <th>Designation</th> <th>Mat.</th> </tr> </thead> <tbody> <tr> <td>1</td> <td>D-SUB conn. 15 pin, bushing </td> <td>223008</td> </tr> <tr> <td>1</td> <td>D-SUB conn. 15 pin, pin </td> <td>220623</td> </tr> <tr> <td>4</td> <td>screw </td> <td>221657</td> </tr> <tr> <td>2</td> <td>housing 15 pin </td> <td>221661</td> </tr> <tr> <td>1</td> <td>plugin terminal 10 pin </td> <td>241647</td> </tr> </tbody> </table> <p>Page 4</p> <table border="1"> <tr> <td>Date: 04.11.92 File: S1-DDS2 Mat.no. BPZ:</td> <td>Delivery slip for kit S1-DDS2 Z.no.:109-0852-4206-00</td> </tr> </table> <p style="text-align: right;">G01DSF1P.FH5</p>	No.	Designation	Mat.	1	D-SUB conn. 15 pin, bushing 	223008	1	D-SUB conn. 15 pin, pin 	220623	4	screw 	221657	2	housing 15 pin 	221661	1	plugin terminal 10 pin 	241647	Date: 04.11.92 File: S1-DDS2 Mat.no. BPZ:	Delivery slip for kit S1-DDS2 Z.no.:109-0852-4206-00
No.	Designation	Mat.																			
1	D-SUB conn. 15 pin, bushing 	223008																			
1	D-SUB conn. 15 pin, pin 	220623																			
4	screw 	221657																			
2	housing 15 pin 	221661																			
1	plugin terminal 10 pin 	241647																			
Date: 04.11.92 File: S1-DDS2 Mat.no. BPZ:	Delivery slip for kit S1-DDS2 Z.no.:109-0852-4206-00																				

Fig. 10-3: Examples of a packing slip

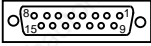
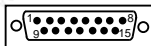
11 Storage and Transport

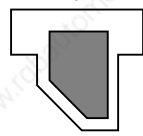
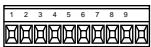
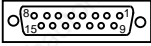
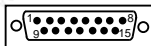
The controllers must be stored in a dry, dust and shock free environment within a permissible temperature range of -30 to +85°C.

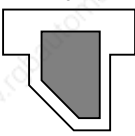
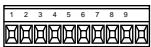
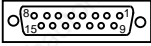
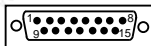
Use shock-absorbing supports during transport, if necessary!

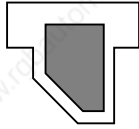
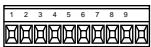
Transport notes found on the packaging:



Fig. 11-1: Some safety guidelines for transport

12 Index

A

- Accessories 10-2
 - mechanical 7-8, 7-9
- Accessory kit
 - M2-F 7-9
 - SH-FL 7-9
- Ambient conditions 4-4
- Ambient temperature 4-4

B

- Blower 5-5, 6-14
- Blower Unit 6-14, 7-8
- Bus cable 6-8
- Bus connection 6-8

C

- Cable length 6-4
- Cable lengths 6-12
- Chassis connection 6-4
- Clearance dimensions
 - DDS02.2 5-2
 - DDS03.2 5-3
- Condensation 5-13
- Configuration Rating Plates 3-12
- Configurations 3-13
- Configured drive controllers 3-1
- Connection accessories 7-1
- Connector kit 7-1
- Connectors kit 7-6
- Continuous current 4-1
- Current consumption 4-2

D

- DC bus voltage 6-7
- Diagnostic outputs 6-9
- Dimensional sheet
 - DDS02.2-A... 5-6
 - DDS02.2-W... 5-4
 - DDS03.2-W... 5-12
 - M2-F 5-11
 - SH-FL 5-11
- Drive controller
 - coolants 3-4
 - cooling methods 3-5
 - heat technology 3-4
- Drive controller - basic unit 3-4
- Drive controller - cold technology 3-4
- Drive controller components 3-1, 3-2
- Drive controllers
 - Type codes 3-3, 3-6

E

- EMC 5-13
- Energy loss 4-5
 - DDS02.2-A... 4-6
 - DDS02.2-F... 4-7
 - DDS02.2-W... 4-5
 - DDS03.2-W... 4-8
- Environmental conditions 4-4

F

- Feedback connection 6-13
- Fiber optic cables (LWL) 7-7
- Firmware 3-7, 3-9

H

- Heat-exchanger units 5-13
- Holding brake 6-7

I

- Individual components 1-2
- Installation elevation 4-4
- Interference suppression 5-13

M

- Motor feedback 6-12
- Motor power cable 6-4
- Motor power connection 6-5, 6-6
- Motor temperature monitor 6-7
- Mounting conditions 5-1
- Mounting panel 5-5

P

- Peak current 4-1
- Plugin module 6-16
- Plugin modules 3-10
- Power loss 5-5
- Power supply units 8-1

R

- Rating plate basic unit 10-1
- Ready to operate contact Bb 6-9
- RS232 6-11

S

- Safety guidelines 2-1
- Software module 3-7
- Starting lockout 6-10
- Storage 11-1
- Supply units 1-2

T

Technical Data 4-1

Terminal diagram 6-16

Transport 11-1

W

Weight 4-8

Directory of Customer Service Locations

Germany

Sales region central INDRAMAT GmbH D-97816 Lohr am Main Bgm.-Dr.-Nebel-Str. 2 Telefon: 09352/40-0 Telefax: 09352/40-4885	Sales region east INDRAMAT GmbH D-09120 Chemnitz Beckerstraße 31 Telefon: 0371/3555-0 Telefax: 0371/3555-230	Sales region west INDRAMAT GmbH D-40849 Ratingen Hansastraße 25 Telefon: 02102/4318-0 Telefax: 02102/41315	Sales region north INDRAMAT GmbH D-22085 Hamburg Fährhausstraße 11 Telefon: 040/227126-16 Telefax: 040/227126-15
Sales region south INDRAMAT GmbH D-80339 München Ridlerstraße 75 Telefon: 089/540138-20 Telefax: 089/540138-10	Sales region southwest INDRAMAT GmbH D-71229 Leonberg Böblinger Straße 25 Telefon: 07152/972-6 Telefax: 07152/972-727		INDRAMAT Service-Hotline INDRAMAT GmbH Telefon: D-0172/660 040 6 -oder- Telefon: D-0171/333 882 6

Customer service locations within Germany

Europe

Austria G.L.Rexroth Ges.m.b.H. Geschäftsbereich INDRAMAT A-1140 Wien Hägelingasse 3 Telefon: 1/9852540-400 Telefax: 1/9852540-93	Austria G.L.Rexroth Ges.m.b.H. Geschäftsbereich INDRAMAT A-4061 Pasching Randlstraße 14 Telefon: 07229/4401-36 Telefax: 07229/4401-80	Belgium Mannesmann Rexroth N.V.-S.A. Geschäftsbereich INDRAMAT B-1740 Ternat Industrielaan 8 Telefon: 02/5823180 Telefax: 02/5824310	Denmark BEC Elektronik AS DK-8900 Randers Zinkvej 6 Telefon: 086/447866 Telefax: 086/447160
England Mannesmann Rexroth Ltd. INDRAMAT Division Cirencester, Glos GL7 1YG 4 Esland Place, Love Lane Telefon: 01285/658671 Telefax: 01285/654991	Finnland Rexroth Mecman OY SF-01720 Vantaa Riihimiehentie 3 Telefon: 0/848511 Telefax: 0/846387	France Rexroth - Sigma S.A. Division INDRAMAT F-92632 Gennevilliers Cedex Parc des Barbanniers 4, Place du Village Telefon: 1/41475430 Telefax: 1/47946941	France Rexroth - Sigma S.A. Division INDRAMAT F-69634 Venissieux - Cx 91, Bd 1 Joliot Curie Telefon: 78785256 Telefax: 78785231
France Rexroth - Sigma S.A. Division INDRAMAT F-31100 Toulouse 270, Avenue de l'ardenne Telefon: 61499519 Telefax: 61310041	Italy Rexroth S.p.A. Divisione INDRAMAT I-20063 Cernusco S/N.MI Via G. Di Vittoria, 1 Telefon: 02/92365-270 Telefax: 02/92108069	Italy Rexroth S.p.A. Divisione INDRAMAT Via Borgomanero, 11 I-10145 Torino Telefon: 011/7712230 Telefax: 011/7710190	Netherlands Hydraudyne Hydrauliek B.V. Kruisbroeksestraat 1a P.O. Box 32 NL-5280 AA Boxtel Telefon: 04116/51951 Telefax: 04116/51483
Spain Rexroth S.A. Centro Industrial Santiago Obradors s/n E-08130 Santa Perpetua de Mo- goda (Barcelona) Telefon: 03/718 68 51 Telex: 591 81 Telefax: 03/718 98 62	Spain Goimendi S.A. División Indramat Jolastokieta (Herrera) Apartado 11 37 San Sebastian, 20017 Telefon: 043/40 01 63 Telex: 361 72 Telefax: 043/39 93 95	Sweden AB Rexroth Mecman INDRAMAT Division Varuvägen 7 S-125 81 Stockholm Telefon: 08/727 92 00 Telefax: 08/64 73 277	Switzerland Rexroth SA Département INDRAMAT Chemin de l'Ecole 6 CH-1036 Sullens Telefon: 021/731 43 77 Telefax: 021/731 46 78
Switzerland Rexroth AG Geschäftsbereich INDRAMAT Gewerbestraße 3 CH-8500 Frauenfeld Telefon: 052/720 21 00 Telefax: 052/720 21 11	Russia Tschudnenko E.B. Arsenia 22 153000 Ivanovo Rußland Telefon: 093/22 39 633		

European customer service locations without Germany

Outside of Europe

<p>Argentina</p> <p>Mannesmann Rexroth S.A.I.C. Division INDRAMAT Acassusso 48 41/7 1605 Munro (Buenos Aires) Argentina</p> <p>Telefon: 01/756 01 40 01/756 02 40 Telex: 262 66 rexro ar Telefax: 01/756 01 36</p>	<p>Argentina</p> <p>Nakase Asesoramiento Tecnico Diaz Velez 2929 1636 Olivos (Provincia de Buenos Aires) Argentina Argentina</p> <p>Telefon 01/790 52 30</p>	<p>Australia</p> <p>Australian Industrial Machinery Services Pty. Ltd. Unit 3/45 Home ST Campbellfield VIC 2061 Australia</p> <p>Telefon: 03/93 59 0228 Telefax: 03/93 59 02886</p>	<p>Brazil</p> <p>Mannesmann Rexroth Automação Ltda. Divisão INDRAMAT Rua Georg Rexroth, 609 Vila Padre Anchieta BR-09.951-250 Diadema-SP Caixa Postal 377 BR-09.901-970 Diadema-SP</p> <p>Telefon: 011/745 90 65 011/745 90 70 Telefax: 011/745 90 50</p>
<p>Canada</p> <p>Basic Technologies Corporation Burlington Division 3426 Mainway Drive Burlington, Ontario Canada L7M 1A8</p> <p>Telefon: 905/335-55 11 Telefax: 905/335-41 84</p>	<p>China</p> <p>Rexroth (China) Ltd. Shanghai Office Room 206 Shanghai Intern. Trade Centre 2200 Yanan Xi Lu Shanghai 200335 P.R. China</p> <p>Telefon: 021/627 55 333 Telefax: 021/627 55 666</p>	<p>China</p> <p>Rexroth (China) Ltd. Shanghai Parts & Service Centre 199 Wu Cao Road, Hua Cao Minhang District Shanghai 201 103 P.R. China</p> <p>Telefon: 021/622 00 058 Telefax: 021/622 00 068</p>	<p>China</p> <p>Rexroth (China) Ltd. 1430 China World Trade Centre 1, Jianguomenwai Avenue Beijing 100004 P.R. China</p> <p>Telefon: 010/50 50 380 Telefax: 010/50 50 379</p>
<p>China</p> <p>Rexroth (China) Ltd. A-5F., 123 Lian Shan Street Sha He Kou District Dalian 116 023 P.R. China</p> <p>Telefon: 0411/46 78 930 Telefax: 0411/46 78 932</p>	<p>Honkong</p> <p>Rexroth (China) Ltd. 19 Cheung Shun Street 1st Floor, Cheung Sha Wan, Kowloon, Honkong</p> <p>Telefon: 741 13 51/-54 and 741 14 30 Telex: 3346 17 GL REX HX Telefax: 786 40 19 786 07 33</p>	<p>India</p> <p>Mannesmann Rexroth (India) Ltd. INDRAMAT Division Plot. 96, Phase III Peenya Industrial Area Bangalore - 560058</p> <p>Telefon: 80/839 21 01 80/839 73 74 Telex: 845 5028 RexB Telefax: 80/839 43 45</p>	<p>Japan</p> <p>Rexroth Co., Ltd. INDRAMAT Division I.R. Building Nakamachidai 4-26-44 Tsuzuki-ku, Yokohama 226 Japan</p> <p>Telefon: 045/942-72 10 Telefax: 045/942-03 41</p>
<p>Korea</p> <p>Rexroth-Seki Co Ltd. 1500-12 Da-Dae-Dong Saha-Gu, Pusan, 604-050</p> <p>Telefon: 051/264 90 01 Telefax: 051/264 90 10</p>	<p>Korea</p> <p>Seo Chang Corporation Ltd. Room 903, Jeail Building 44-35 Yoido-Dong Youngdeungpo-Ku Seoul, Korea</p> <p>Telefon: 02/780-82 07 -9 Telefax: 02/784-54 08</p>	<p>Mexico</p> <p>Motorización y Diseño de Controles, S.A. de C.V. Av. Dr. Gustavo Baz No. 288 Col. Parque Industrial la loma Apartado Postal No. 318 54060 Tlalnepanla Estado de Mexico</p> <p>Telefon: 5/397 86 44 Telefax: 5/398 98 88</p>	
<p>USA</p> <p>Rexroth Corporation INDRAMAT Division 5150 Prairie Stone Parkway Hoffman Estates, Illinois 60192</p> <p>Telefon: 847/645-36 00 Telefax: 857/645-62 01</p>	<p>USA</p> <p>Rexroth Corporation INDRAMAT Division 2110 Austin Avenue Rochester Hills, Michigan 48309</p> <p>Telefon: 810/853-82 90 Telefax: 810/853-82 90</p>		

Customer service locations outside of Europe

