



Programming Guide

VLT® AutomationDrive

Contents

1 Introduction	3
1.1.1 Approvals	3
1.1.2 Symbols	3
1.1.3 Definitions	3
1.1.4 Electrical Wiring - Control Cables	8
2 How to Programme	11
2.1 The Graphical and Numerical Local Control Panels	11
2.1.1 The LCD-Display	12
2.1.3 Display Mode	14
2.1.4 Display Mode - Selection of Read-Outs	14
2.1.5 Parameter Set-Up	15
2.1.6 Quick Menu Key Functions	15
2.1.8 Main Menu Mode	18
2.1.9 Parameter Selection	18
2.1.10 Changing Data	19
2.1.11 Changing a Text Value	19
2.1.12 Changing	19
2.1.13 Infinitely Variable Change of Numeric Data Value	19
2.1.14 Value, Step-by-Step	19
2.1.15 Read-out and Programming of Indexed Parameters	20
2.1.16 Local Control Keys	21
2.1.17 Initialisation to Default Settings	21
3 Parameter Descriptions	23
3.2 Parameters: 0-** Operation and Display	24
3.3 Parameters: 1-** Load and Motor	34
3.4 Parameters: 2-** Brakes	52
3.5 Parameters: 3-** Reference/Ramps	57
3.6 Parameters: 4-** Limits/Warnings	67
3.7 Parameters: 5-** Digital In/Out	72
3.8 Parameters: 6-** Analog In/Out	91
3.9 Parameters: 7-** Controllers	100
3.10 Parameters: 8-** Communications and Options	106
3.11 Parameters: 9-** Profibus	112
3.12 Parameters: 10-** DeviceNet CAN Fieldbus	112
3.13 Parameters: 12-** Ethernet	112
3.14 Parameters: 13-** Smart Logic Control	112
3.15 Parameters: 14-** Special Functions	125
3.16 Parameters: 15-** Drive Information	133

3.17 Parameters: 16-** Data Read-outs	138
3.18 Parameters: 17-** Motor Feedb. Option	145
3.19 Parameters: 18-** Data Readouts 2	147
3.20 Parameters: 30-** Special Features	148
3.21 Parameters: 35-** Sensor Input Option	151
4 Parameter Lists	153
4.1.1 Conversion	154
4.1.2 Active/Inactive Parameters in Different Drive Control Modes	154
5 Troubleshooting	192
5.1.1 Warnings/Alarm Messages	192
Index	204

1 Introduction

Programming Guide
Software version: 6.7x

This Programming Guide can be used for all FC 300 frequency converters with software version 6.7x.
The software version number can be seen from *15-43 Software Version*.

Table 1.1

1.1.1 Approvals

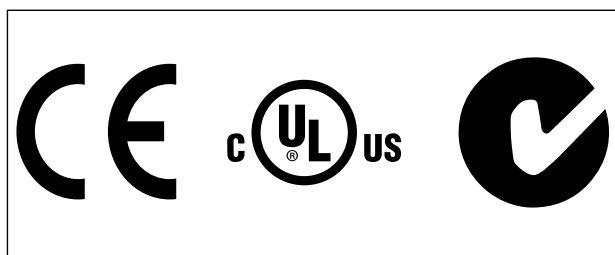

Table 1.2

1.1.2 Symbols

The following symbols are used in this manual.



Indicates a potentially hazardous situation which, if not avoided, could result in death or serious injury.



Indicates a potentially hazardous situation which, if not avoided, may result in minor or moderate injury. It may also be used to alert against unsafe practices.

CAUTION

Indicates a situation that may result in equipment or property-damage-only accidents.

NOTE

Indicates highlighted information that should be regarded with attention to avoid mistakes or operate equipment at less than optimal performance.

1.1.3 Definitions

Frequency converter

$I_{VLT, MAX}$
Maximum output current.

$I_{VLT, N}$
Rated output current supplied by the frequency converter.

$U_{VLT, MAX}$
Maximum output voltage.

Input

Control command

Start and stop the connected motor by means of LCP and digital inputs.

Functions are divided into two groups.

Functions in group 1 have higher priority than functions in group 2.

Group 1	Reset, Coasting stop, Reset and Coasting stop, Quick-stop, DC braking, Stop and the [OFF] key.
Group 2	Start, Pulse start, Reversing, Start reversing, Jog and Freeze output

Table 1.3

Motor

Motor Running

Torque generated on output shaft and speed from zero rpm to max. speed on motor.

f_{JOG}
Motor frequency when the jog function is activated (via digital terminals).

f_M
Motor frequency.

f_{MAX}
Maximum motor frequency.

f_{MIN}
Minimum motor frequency.

$f_{M, N}$
Rated motor frequency (nameplate data).

I_M
Motor current (actual).

$I_{M, N}$
Rated motor current (nameplate data).

$n_{M, N}$
Rated motor speed (nameplate data).

n_s
Synchronous motor speed

$$n_s = \frac{2 \times par. 1 - 23 \times 60 s}{par. 1 - 39}$$

n_{slip}
Motor slip.

$P_{M, N}$
Rated motor power (nameplate data in kW or HP).

T_{M,N}

Rated torque (motor).

U_M

Instantaneous motor voltage.

U_{M,N}

Rated motor voltage (nameplate data).

Break-away torque

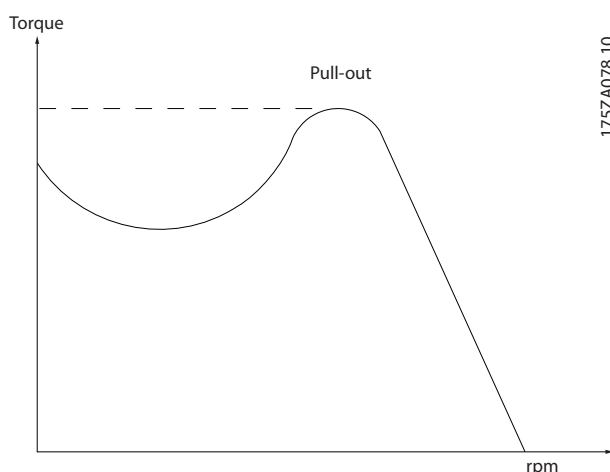

Illustration 1.1

η_{VLT}

The efficiency of the frequency converter is defined as the ratio between the power output and the power input.

Start-disable command

A stop command belonging to the group 1 control commands - see this group.

Stop command

See Control commands.

References

Analog Reference

A signal transmitted to the analog inputs 53 or 54, can be voltage or current.

Binary Reference

A signal transmitted to the serial communication port.

Preset Reference

A defined preset reference to be set from -100% to +100% of the reference range. Selection of eight preset references via the digital terminals.

Pulse Reference

A pulse frequency signal transmitted to the digital inputs (terminal 29 or 33).

Ref_{MAX}

Determines the relationship between the reference input at 100% full scale value (typically 10 V, 20 mA) and the resulting reference. The maximum reference value set in 3-03 *Maximum Reference*.

Ref_{MIN}

Determines the relationship between the reference input at 0% value (typically 0 V, 0 mA, 4 mA) and the resulting reference. The minimum reference value set in 3-02 *Minimum Reference*.

Miscellaneous

Analog Inputs

The analog inputs are used for controlling various functions of the frequency converter.

There are two types of analog inputs:

Current input, 0-20 mA and 4-20 mA

Voltage input, -10 to +10 V DC.

Analog Outputs

The analog outputs can supply a signal of 0-20 mA, 4-20 mA.

Automatic Motor Adaptation, AMA

AMA algorithm determines the electrical parameters for the connected motor at standstill.

Brake Resistor

The brake resistor is a module capable of absorbing the brake power generated in regenerative braking. This regenerative braking power increases the intermediate circuit voltage and a brake chopper ensures that the power is transmitted to the brake resistor.

CT Characteristics

Constant torque characteristics used for all applications such as conveyor belts, displacement pumps and cranes.

Digital Inputs

The digital inputs can be used for controlling various functions of the frequency converter.

Digital Outputs

The frequency converter features two Solid State outputs that can supply a 24 V DC (max. 40 mA) signal.

DSP

Digital Signal Processor.

ETR

Electronic Thermal Relay is a thermal load calculation based on present load and time. Its purpose is to estimate the motor temperature.

Hiperface®

Hiperface® is a registered trademark by Stegmann.

Initialising

If initialising is carried out (*14-22 Operation Mode*), the frequency converter returns to the default setting.

Intermittent Duty Cycle

An intermittent duty rating refers to a sequence of duty cycles. Each cycle consists of an on-load and an off-load period. The operation can be either periodic duty or non-periodic duty.

LCP

The Local Control Panel makes up a complete interface for control and programming of the frequency converter. The control panel is detachable and can be installed up to 3 m from the frequency converter, i.e. in a front panel with the installation kit option.

lsb

Least significant bit.

msb

Most significant bit.

MCM

Short for Mille Circular Mil, an American measuring unit for cable cross-section. 1 MCM = 0.5067mm².

On-line/Off-line Parameters

Changes to on-line parameters are activated immediately after the data value is changed. Changes to off-line parameters are not activated until you enter [OK] on the LCP.

Process PID

The PID control maintains the desired speed, pressure, temperature, etc. by adjusting the output frequency to match the varying load.

PCD

Process Control Data

Power Cycle

Switch off the mains until display (LCP) is dark – then turn power on again.

Pulse Input/Incremental Encoder

An external, digital pulse transmitter used for feeding back information on motor speed. The encoder is used in applications where great accuracy in speed control is required.

RCD

Residual Current Device.

Set-up

You can save parameter settings in four Set-ups. Change between the four parameter Set-ups and edit one Set-up, while another Set-up is active.

SFAVM

Switching pattern called Stator Flux oriented Asynchronous Vector Modulation (*14-00 Switching Pattern*).

Slip Compensation

The frequency converter compensates for the motor slip by giving the frequency a supplement that follows the measured motor load keeping the motor speed almost constant.

Smart Logic Control (SLC)

The SLC is a sequence of user defined actions executed when the associated user defined events are evaluated as true by the Smart Logic Controller. (Parameter group 13-**) *Smart Logic Control (SLC)*.

STW

Status Word

FC Standard Bus

Includes RS-485 bus with FC protocol or MC protocol. See *8-30 Protocol*.

Thermistor

A temperature-dependent resistor placed where the temperature is to be monitored (frequency converter or motor).

Trip

A state entered in fault situations, e.g. if the frequency converter is subject to an over-temperature or when the frequency converter is protecting the motor, process or mechanism. Restart is prevented until the cause of the fault has disappeared and the trip state is cancelled by activating reset or, in some cases, by being programmed to reset automatically. Trip may not be used for personal safety.

Trip Locked

A state entered in fault situations when the frequency converter is protecting itself and requiring physical intervention, e.g. if the frequency converter is subject to a short circuit on the output. A locked trip can only be cancelled by cutting off mains, removing the cause of the fault, and reconnecting the frequency converter. Restart is prevented until the trip state is cancelled by activating reset or, in some cases, by being programmed to reset automatically. Trip may not be used for personal safety.

VT Characteristics

Variable torque characteristics used for pumps and fans.

VVC^{plus}

If compared with standard voltage/frequency ratio control, Voltage Vector Control (VVC^{plus}) improves the dynamics and the stability, both when the speed reference is changed and in relation to the load torque.

60° AVM

Switching pattern called 60° Asynchronous Vector Modulation (*14-00 Switching Pattern*).

Power Factor

The power factor is the relation between I₁ and I_{RMS}.

$$\text{Power factor} = \frac{\sqrt{3} \times U \times I_1 \cos\varphi}{\sqrt{3} \times U \times I_{RMS}}$$

The power factor for 3-phase control:

$$= \frac{I_1 \times \cos\varphi_1}{I_{RMS}} = \frac{I_1}{I_{RMS}} \text{ since } \cos\varphi_1 = 1$$

The power factor indicates to which extent the frequency converter imposes a load on the mains supply.

The lower the power factor, the higher the I_{RMS} for the same kW performance.

$$I_{RMS} = \sqrt{I_1^2 + I_5^2 + I_7^2 + \dots + I_n^2}$$

In addition, a high power factor indicates that the different harmonic currents are low.

The frequency converters' built-in DC coils produce a high power factor, which minimizes the imposed load on the mains supply.

⚠ WARNING

The voltage of the frequency converter is dangerous whenever connected to mains. Incorrect installation of the motor, frequency converter or fieldbus may cause death, serious personal injury or damage to the equipment. Consequently, the instructions in this manual, as well as national and local rules and safety regulations, must be complied with.

Safety Regulations

1. The mains supply to the frequency converter must be disconnected whenever repair work is to be carried out. Check that the mains supply has been disconnected and that the necessary time has elapsed before removing motor and mains supply plugs.
2. [Off] does not disconnect the mains supply and consequently it must not be used as a safety switch.
3. The equipment must be properly earthed, the user must be protected against supply voltage and the motor must be protected against overload in accordance with applicable national and local regulations.
4. The earth leakage current exceeds 3.5 mA.
5. Protection against motor overload is not included in the factory setting. If this function is desired, set *1-90 Motor Thermal Protection* to data value ETR trip 1 [4] or data value ETR warning 1 [3].
6. Do not remove the plugs for the motor and mains supply while the frequency converter is connected to mains. Check that the mains supply has been disconnected and that the necessary time has elapsed before removing motor and mains plugs.

7. Please note that the frequency converter has more voltage sources than L1, L2 and L3, when load sharing (linking of DC intermediate circuit) or external 24 V DC are installed. Check that all voltage sources have been disconnected and that the necessary time has elapsed before commencing repair work.

Warning against unintended start

1. The motor can be brought to a stop by means of digital commands, bus commands, references or a local stop, while the frequency converter is connected to mains. If personal safety considerations (e.g. risk of personal injury caused by contact with moving machine parts following an unintentional start) make it necessary to ensure that no unintended start occurs, these stop functions are not sufficient. In such cases the mains supply must be disconnected or the Safe Stop function must be activated.
2. The motor may start while setting the parameters. If this means that personal safety may be compromised (e.g. personal injury caused by contact with moving machine parts), motor starting must be prevented, for instance by use of the Safe Stop function or secure disconnection of the motor connection.
3. A motor that has been stopped with the mains supply connected, may start if faults occur in the electronics of the frequency converter, through temporary overload or if a fault in the power supply grid or motor connection is remedied. If unintended start must be prevented for personal safety reasons (e.g. risk of injury caused by contact with moving machine parts), the normal stop functions of the frequency converter are not sufficient. In such cases the mains supply must be disconnected or the Safe Stop function must be activated.

NOTE

When using the Safe Stop function, always follow the instructions in the section *Safe Stop* of the Design Guide.

4. Control signals from, or internally within, the frequency converter may in rare cases be activated in error, be delayed or fail to occur entirely. When used in situations where safety is critical, e.g. when controlling the electromagnetic brake function of a hoist application, these control signals must not be relied on exclusively.

⚠ WARNING**High Voltage**

Touching the electrical parts may be fatal - even after the equipment has been disconnected from mains.

Also make sure that other voltage inputs have been disconnected, such as external 24 V DC, load sharing (linkage of DC intermediate circuit), as well as the motor connection for kinetic back up.

Systems where frequency converters are installed must, if necessary, be equipped with additional monitoring and protective devices according to the valid safety regulations, e.g. law on mechanical tools, regulations for the prevention of accidents etc. Modifications on the frequency converters by means of the operating software are allowed.

NOTE

Hazardous situations shall be identified by the machine builder/ integrator who is responsible for taking necessary preventive means into consideration. Additional monitoring and protective devices may be included, always according to valid national safety regulations, e.g. law on mechanical tools, regulations for the prevention of accidents.

NOTE

Crane, Lifts and Hoists:

The controlling of external brakes must always have a redundant system. The frequency converter can in no circumstances be the primary safety circuit. Comply with relevant standards, e.g.

Hoists and cranes: IEC 60204-32

Lifts: EN 81

Protection Mode

Once a hardware limit on motor current or dc-link voltage is exceeded the frequency converter will enter "Protection mode". "Protection mode" means a change of the PWM modulation strategy and a low switching frequency to minimize losses. This continues 10 s after the last fault and increases the reliability and the robustness of the frequency converter while re-establishing full control of the motor.

In hoist applications "Protection mode" is not usable because the frequency converter will usually not be able to leave this mode again and therefore it will extend the time before activating the brake - which is not recommendable. The "Protection mode" can be disabled by setting *14-26 Trip Delay at Inverter Fault* to zero which means that the frequency converter will trip immediately if one of the hardware limits is exceeded.

NOTE

It is recommended to disable protection mode in hoisting applications (*14-26 Trip Delay at Inverter Fault* = 0)

1.1.4 Electrical Wiring - Control Cables

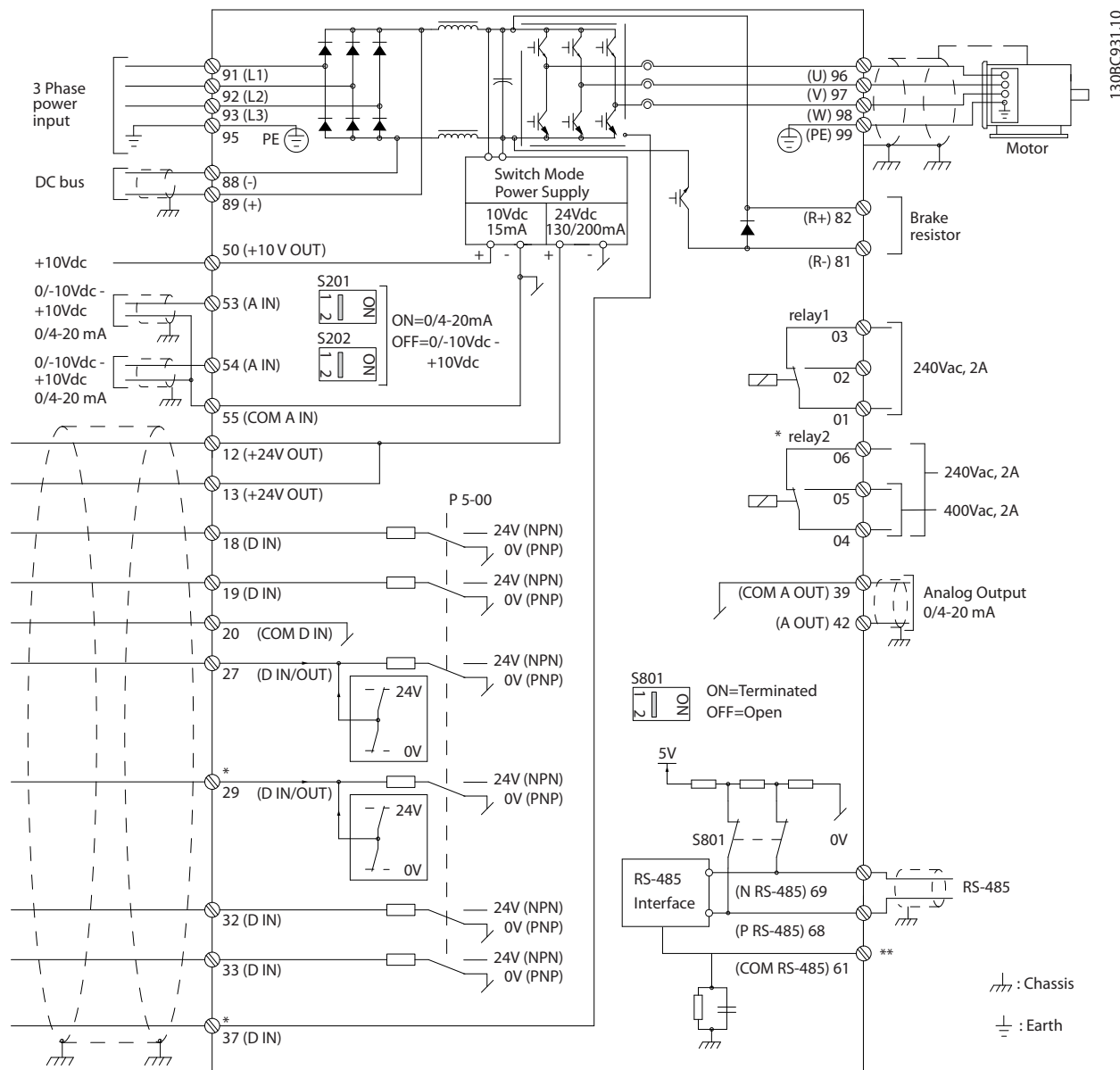

Illustration 1.2 Basic Wiring Schematic Drawing.

A=Analog, D=Digital

Terminal 37 is used for Safe Stop. For Safe Stop installation instructions, refer to the Design Guide.

* Terminal 37 is not included in FC 301 (except frame size A1). Relay 2 and terminal 29 have no function in FC 301.

** Do not connect cable screen.

Very long control cables and analog signals may in rare cases and depending on installation result in 50/60 Hz earth loops due to noise from mains supply cables.

If this occurs, it may be necessary to break the screen or insert a 100 nF capacitor between screen and chassis.

The digital and analog inputs and outputs must be connected separately to the common inputs (terminal 20, 55, 39) of the frequency converter to avoid ground currents from both groups to affect other groups. For example, switching on the digital input may disturb the analog input signal.

Input polarity of control terminals

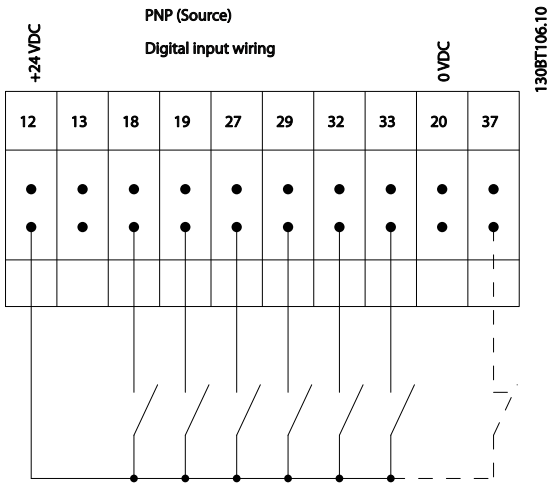

Illustration 1.3

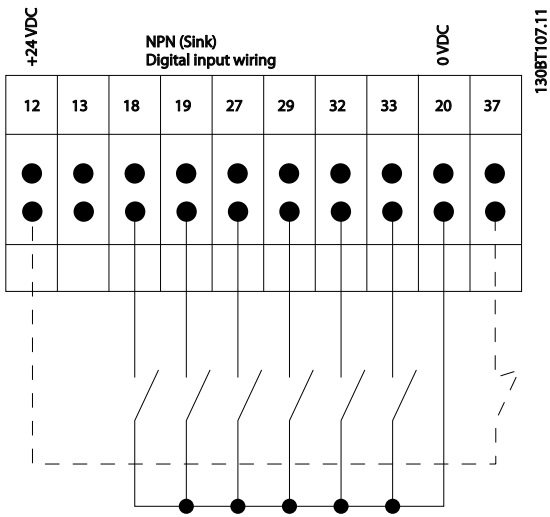

Illustration 1.4

NOTE

Control cables must be screened/armoured.

See section on earthing of screened/armoured control cables in the Design Guide for the correct termination of control cables.

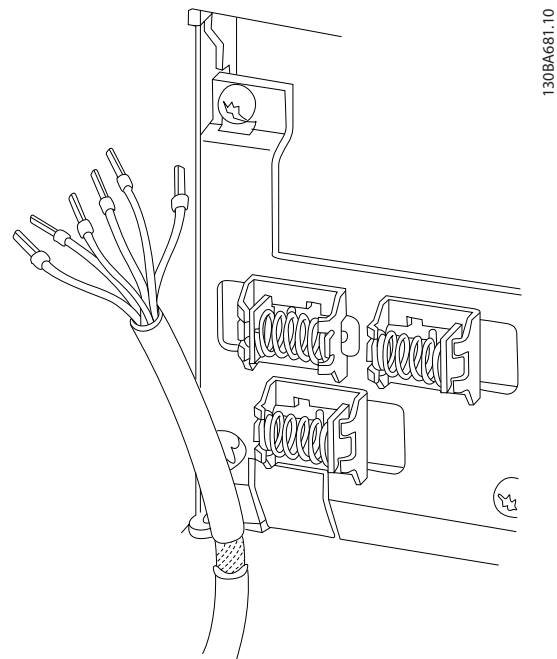

Illustration 1.5

1.1.5 Start/Stop

Terminal 18 = 5-10 Terminal 18 Digital Input [8] Start
Terminal 27 = 5-12 Terminal 27 Digital Input [0] No operation (Default coast inverse)
Terminal 37 = Safe stop (where available)

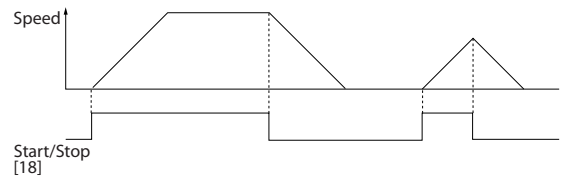
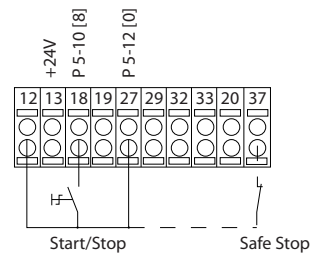
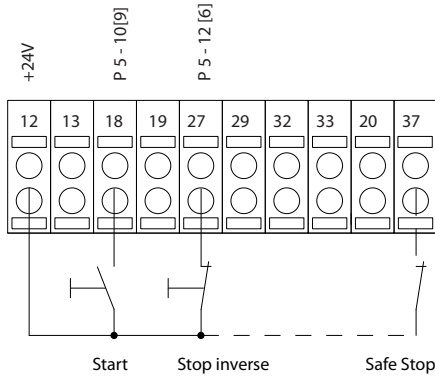

Illustration 1.6

1.1.6 Pulse Start/Stop

Terminal 18 = 5-10 Terminal 18 Digital Input Latched start, [9]
 Terminal 27 = 5-12 Terminal 27 Digital Input Stop inverse, [6]
 Terminal 37 = Safe stop (where available)



130BA156.12

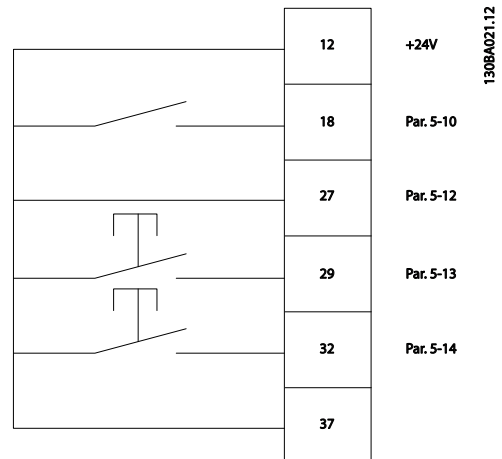

Illustration 1.8

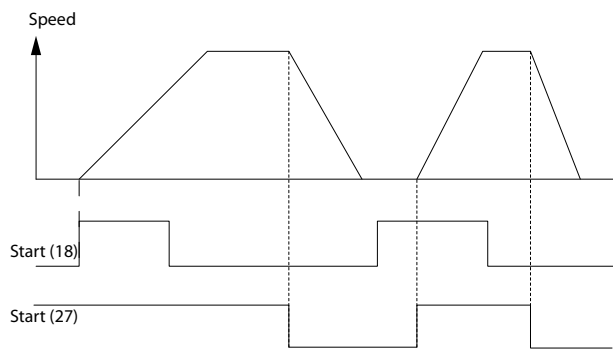

Illustration 1.7

1.1.7 Speed Up/Down

Terminals 29/32 = Speed up/down

- Terminal 18 = 5-10 Terminal 18 Digital Input Start [9] (default)
- Terminal 27 = 5-12 Terminal 27 Digital Input Freeze reference [19]
- Terminal 29 = 5-13 Terminal 29 Digital Input Speed up [21]
- Terminal 32 = 5-14 Terminal 32 Digital Input Speed down [22]

NOTE

Terminal 29 only in FC x02 (x=series type).

1.1.8 Potentiometer Reference

Voltage reference via a potentiometer

- Reference Source 1 = [1] Analog input 53 (default)
- Terminal 53, Low Voltage = 0 V
- Terminal 53, High Voltage = 10 V
- Terminal 53, Low Ref./Feedback = 0 RPM
- Terminal 53, High Ref./Feedback = 1500 RPM
- Switch S201 = OFF (U)

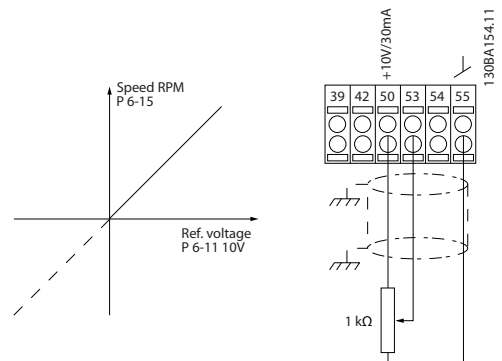

Illustration 1.9

2 How to Programme

2.1 The Graphical and Numerical Local Control Panels

The easiest programming of the frequency converter is performed by the Graphical LCP (LCP 102). It is necessary to consult the frequency converter Design Guide, when using the Numeric Local Control Panel (LCP 101).

The control panel is divided into four functional groups

1. Graphical display with Status lines.
2. Menu keys and indicator lights - changing parameters and switching between display functions.
3. Navigation keys and indicator lights (LEDs).
4. Operation keys and indicator lights (LEDs).

All data is displayed in a graphical LCP display, which can show up to five items of operating data while displaying [Status].

Display lines

- a. **Status line:** Status messages displaying icons and graphic.
- b. **Line 1-2:** Operator data lines displaying data defined or chosen by the user. By pressing [Status], up to one extra line can be added.
- c. **Status line:** Status messages displaying text.

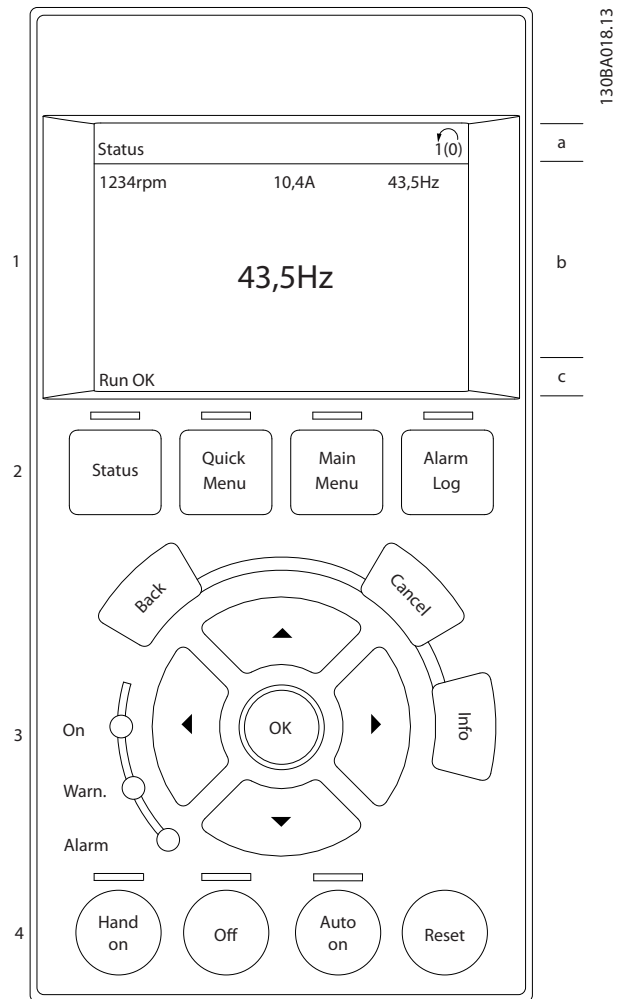

Illustration 2.1

2

2.1.1 The LCD-Display

The LCD-display has back light and a total of 6 alphanumeric lines. The display lines show the direction of rotation (arrow), the chosen Set-up as well as the programming Set-up. The display is divided into 3 sections.

Top section shows up to 2 measurements in normal operating status.

The top line in the **Middle section** shows up to 5 measurements with related unit, regardless of status (except in the case of alarm/warning).

Bottom section always shows the state of the frequency converter in Status mode.

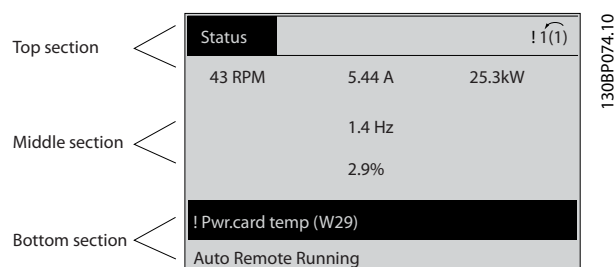

Illustration 2.2

The Active Set-up (selected as the Active Set-up in 0-10 Active Set-up) is shown. When programming another Set-up than the Active Set-up, the number of the programmed Set-up appears to the right.

Display contrast adjustment

Press [Status] and [▲] for darker display
 Press [Status] and [▼] for brighter display

Most parameter set-ups can be changed immediately via the LCP, unless a password has been created via 0-60 Main Menu Password or via 0-65 Quick Menu Password.

Indicator lights (LEDs)

If certain threshold values are exceeded, the alarm and/or warning LED lights up. A status and alarm text appear on the LCP.

The ON LED is activated when the frequency converter receives mains voltage or via a DC bus terminal or 24 V external supply. At the same time, the back light is on.

- Green LED/On: Control section is working.
- Yellow LED/Warn.: Indicates a warning.
- Flashing Red LED/Alarm: Indicates an alarm.

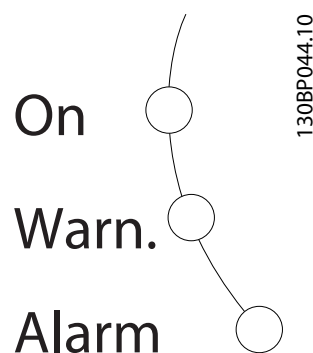

Illustration 2.3

LCP Keys

The control keys are divided into functions. The keys below the display and indicator lamps are used for parameter Set-up, including choice of display indication during normal operation.



Illustration 2.4

[Status] indicates the status of the frequency converter and/or the motor. Choose between 3 different readouts by pressing the [Status] key: 5 line readouts, 4 line readouts or Smart Logic Control.

Use **[Status]** for selecting the mode of display or for changing back to Display mode from either the Quick Menu mode, the Main Menu mode or Alarm mode. Also use the [Status] key to toggle single or double read-out mode.

[Quick Menu] allows quick access to different Quick Menus such as

- My Personal Menu
- Quick Set-up
- Changes Made
- Loggings

Use **[Quick Menu]** for programming the parameters belonging to the Quick Menu. It is possible to switch directly between Quick Menu mode and Main Menu mode.

[Main Menu] is used for programming all parameters. It is possible to switch directly between Main Menu mode and Quick Menu mode.

Parameter shortcut can be carried out by pressing down the **[Main Menu]** key for 3 seconds. The parameter shortcut allows direct access to any parameter.

[Alarm Log] displays an Alarm list of the five latest alarms (numbered A1-A5). To obtain additional details about an alarm, use the arrow keys to manoeuvre to the alarm number and press [OK]. Information is displayed about the condition of the frequency converter before it enters the alarm mode.

[Back] reverts to the previous step or layer in the navigation structure.

[Cancel] last change or command will be cancelled as long as the display has not been changed.

[Info] supplies information about a command, parameter, or function in any display window. [Info] provides detailed information whenever help is needed. Exit info mode by pressing either [Info], [Back], or [Cancel].



Illustration 2.5



Illustration 2.6



Illustration 2.7

Navigation Keys

The four navigation keys are used to navigate between the different choices available in **[Quick Menu]**, **[Main Menu]** and **[Alarm Log]**. Use the keys to move the cursor.

[OK] is used for choosing a parameter marked by the cursor and for enabling the change of a parameter.

Local Control Key for local control are found at the bottom of the LCP.

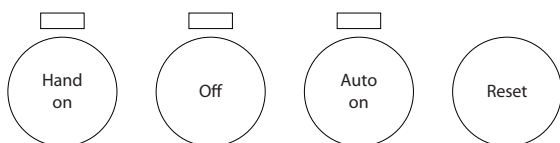

Illustration 2.8

130BP046.10

[Hand On] enables control of the frequency converter via the LCP. [Hand On] also starts the motor, and it is now possible to enter the motor speed data by means of the arrow keys. The key can be selected as *[1] Enable* or *[0] Disable* via 0-40 *[Hand on] Key on LCP*

External stop signals activated by means of control signals or a serial bus will override a “start” command via the LCP. The following control signals will still be active when [Hand On] is activated

- [Hand on] - [Off] - [Auto On]
- Reset
- Coasting stop inverse
- Reversing
- Set-up select bit 0- Set-up select bit 1
- Stop command from serial communication
- Quick stop
- DC brake

[Off] stops the connected motor. The key can be selected as *[1] Enable* or *[0] Disable* via 0-41 *[Off] Key on LCP*. If no external stop function is selected and the [Off] key is inactive the motor can be stopped by disconnecting the voltage.

[Auto On] enables the frequency converter to be controlled via the control terminals and/or serial communication. When a start signal is applied on the control terminals and/or the bus, the frequency converter will start. The key can be selected as *[1] Enable* or *[0] Disable* via 0-42 *[Auto on] Key on LCP*.

NOTE

An active HAND-OFF-AUTO signal via the digital inputs has higher priority than the control keys [Hand On] – [Auto On].

[Reset] is used for resetting the frequency converter after an alarm (trip). It can be selected as *[1] Enable* or *[0] Disable* via 0-43 *[Reset] Key on LCP*.

The parameter shortcut can be carried out by holding down the [Main Menu] key for 3 seconds. The parameter shortcut allows direct access to any parameter.

2.1.2 Quick Transfer of Parameter Settings between Multiple Frequency Converters

Once the set-up of a frequency converter is complete, we recommend that you store the data in the LCP or on a PC via MCT 10 Set-up Software Tool.

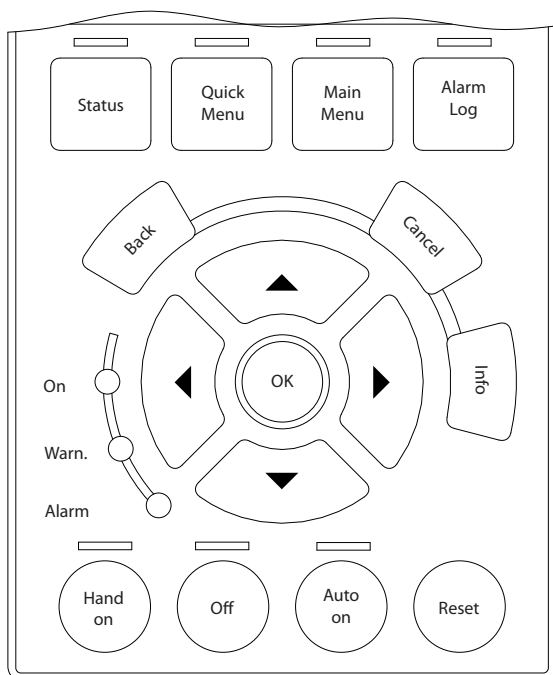

Illustration 2.9

Data storage in LCP

1. Go to 0-50 LCP Copy
2. Press the [OK] key
3. Select "All to LCP"
4. Press the [OK] key

All parameter settings are now stored in the LCP indicated by the progress bar. When 100% is reached, press [OK].

NOTE

Stop the motor before performing this operation.

Connect the LCP to another frequency converter and copy the parameter settings to this frequency converter as well.

Data transfer from LCP to frequency converter

1. Go to 0-50 LCP Copy
2. Press the [OK] key
3. Select "All from LCP"
4. Press the [OK] key

The parameter settings stored in the LCP are now transferred to the frequency converter indicated by the progress bar. When 100% is reached, press [OK].

NOTE

Stop the motor before performing this operation.

2.1.3 Display Mode

In normal operation, up to 5 different operating variables can be indicated continuously in the middle section: 1.1, 1.2, and 1.3 as well as 2 and 3.

2.1.4 Display Mode - Selection of Read-Outs

It is possible to toggle between three status read-out screens by pressing the [Status] key. Operating variables with different formatting are shown in each status screen - see below.

Table 2.1 shows the measurements you can link to each of the operating variables. When Options are mounted, additional measurements are available. Define the links via 0-20 Display Line 1.1 Small, 0-21 Display Line 1.2 Small, 0-22 Display Line 1.3 Small, 0-23 Display Line 2 Large, and 0-24 Display Line 3 Large.

Each readout parameter selected in 0-20 Display Line 1.1 Small to 0-24 Display Line 3 Large has its own scale and digits after a possible decimal point. By larger numeric value of a parameter fewer digits are displayed after the decimal point.

Ex.: Current readout 5.25A; 15.2A 105A.

Operating variable	Unit
16-00 Control Word	hex
16-01 Reference [Unit]	[unit]
16-02 Reference [%]	%
16-03 Status Word	hex
16-05 Main Actual Value [%]	%
16-10 Power [kW]	[kW]
16-11 Power [hp]	[HP]
16-12 Motor Voltage	[V]
16-13 Frequency	[Hz]
16-14 Motor Current	[A]
16-16 Torque [Nm]	Nm
16-17 Speed [RPM]	[RPM]
16-18 Motor Thermal	%
16-20 Motor Angle	
16-30 DC Link Voltage	V
16-32 Brake Energy /s	kW
16-33 Brake Energy /2 min	kW
16-34 Heatsink Temp.	C
16-35 Inverter Thermal	%
16-36 Inv. Nom. Current	A
16-37 Inv. Max. Current	A
16-38 SL Controller State	
16-39 Control Card Temp.	C
16-40 Logging Buffer Full	
16-50 External Reference	

Operating variable	Unit
16-51 Pulse Reference	
16-52 Feedback [Unit]	[Unit]
16-53 Digi Pot Reference	
16-60 Digital Input	bin
16-61 Terminal 53 Switch Setting	V
16-62 Analog Input 53	
16-63 Terminal 54 Switch Setting	V
16-64 Analog Input 54	
16-65 Analog Output 42 [mA]	[mA]
16-66 Digital Output [bin]	[bin]
16-67 Pulse Input #29 [Hz]	[Hz]
16-68 Freq. Input #33 [Hz]	[Hz]
16-69 Pulse Output #27 [Hz]	[Hz]
16-70 Pulse Output #29 [Hz]	[Hz]
16-71 Relay Output [bin]	
16-72 Counter A	
16-73 Counter B	
16-80 Fieldbus CTW 1	hex
16-82 Fieldbus REF 1	hex
16-84 Comm. Option STW	hex
16-85 FC Port CTW 1	hex
16-86 FC Port REF 1	hex
16-90 Alarm Word	
16-92 Warning Word	
16-94 Ext. Status Word	

Table 2.1

Status screen I

This read-out state is standard after start-up or initialization.

Use [INFO] to obtain information about the measurement links to the displayed operating variables (1.1, 1.2, 1.3, 2 and 3).

See the operating variables shown in the screen below.

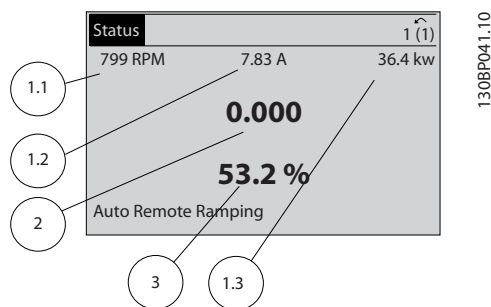

Illustration 2.10

Status screen II

See the operating variables (1.1, 1.2, 1.3 and 2) shown in the screen below.

In the example, Speed, Motor current, Motor power and Frequency are selected as variables in the first and second.

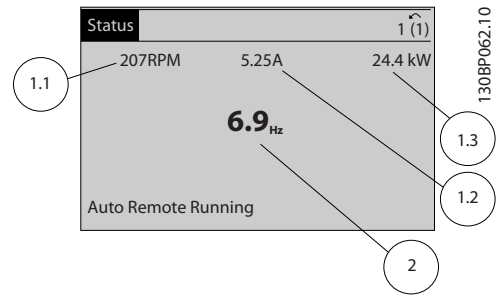

Illustration 2.11

Status screen III

This state displays the event and action of the Smart Logic Control. For further information, see section *Smart Logic Control*.

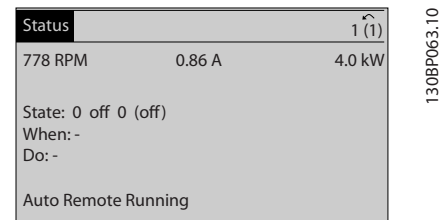

Illustration 2.12

2.1.5 Parameter Set-Up

The frequency converter can be used for practically all assignments, which is why the number of parameters is quite large. The frequency converter offers a choice between two programming modes - a Main Menu and a Quick Menu mode.

The former provides access to all parameters. The latter takes the user through a few parameters making it possible to start operating the frequency converter. Regardless of the mode of programming, you can change a parameter both in the Main Menu mode and in the Quick Menu mode.

2.1.6 Quick Menu Key Functions

Pressing [Quick Menus] The list indicates the different areas contained in the Quick menu.

Select *My Personal Menu* to display the chosen personal parameters. These parameters are selected in 0-25 *My Personal Menu*. Up to 50 different parameters can be added in this menu.

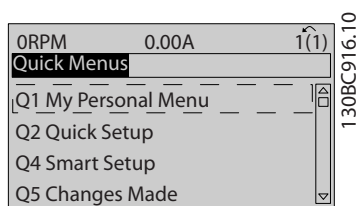

Illustration 2.13

Select *Quick setup* to go through a limited amount of parameters to get the motor running almost optimally. The default setting for the other parameters considers the desired control functions and the configuration of signal inputs/outputs (control terminals).

The selection of parameter is effected by means of the arrow keys. The parameters in the following table are accessible.

Parameter	Setting
0-01 Language	
1-20 Motor Power [kW]	[kW]
1-22 Motor Voltage	[V]
1-23 Motor Frequency	[Hz]
1-24 Motor Current	[A]
1-25 Motor Nominal Speed	[rpm]
5-12 Terminal 27 Digital Input	[0] No function*
1-29 Automatic Motor Adaptation (AMA)	[1] Enable complete AMA
3-02 Minimum Reference	[rpm]
3-03 Maximum Reference	[rpm]
3-41 Ramp 1 Ramp up Time	[sec]
3-42 Ramp 1 Ramp Down Time	[sec]
3-13 Reference Site	

Table 2.2

* If terminal 27 is set to “no function”, no connection to +24 V on terminal 27 is necessary.

Select *Changes made* to get information about:

- the last 10 changes. Use the [▲] [▼] navigation keys to scroll between the last 10 changed parameters.
- the changes made since default setting.

Select *Loggings* to get information about the display line read-outs. The information is shown as graphs.

Only display parameters selected in *0-20 Display Line 1.1 Small* and *0-24 Display Line 3 Large* can be viewed. It is possible to store up to 120 samples in the memory for later reference.

2.1.7 Initial Commissioning

The easiest way of carrying out the initial commissioning is by using the [Quick Menu] key and follow the quick set-up procedure using LCP 102 (read Table 2.3 Table 2.4 from left to right). The example applies to open loop applications.

Press				
		Q2 Quick Menu		
0-01 Language		Set language		
1-20 Motor Power [kW]		Set Motor nameplate power		
1-22 Motor Voltage		Set Nameplate voltage		
1-23 Motor Frequency		Set Nameplate frequency		
1-24 Motor Current		Set Nameplate current		
1-25 Motor Nominal Speed		Set Nameplate speed in RPM		
5-12 Terminal 27 Digital Input		If terminal default is <i>Coast inverse</i> it is possible to change this setting to <i>No function</i> . No connection to terminal 27 is then needed for running AMA		
1-29 Automatic Motor Adaptation (AMA)		Set desired AMA function. Enable complete AMA is recommended		
3-02 Minimum Reference		Set the minimum speed of the motor shaft		
3-03 Maximum Reference		Set the maximum speed of the motor shaft		
3-41 Ramp 1 Ramp up Time		Set the ramping up time with reference to synchronous motor speed, n_s		
3-42 Ramp 1 Ramp Down Time		Set the ramping down time with reference to synchronous motor speed, n_s		
3-13 Reference Site		Set the site from where the reference must work		

Table 2.3

Another easy way of commissioning the drive is by using the **Smart Application Setup (SAS)**, which can also be found under the Quick Menu. Follow the indications on the successive screens for setting-up the applications listed.

[Info] can be used throughout the SAS to see help information for various selections, settings, and messages. The following three applications are included:

- Mechanical Brake
- Conveyor
- Pump/Fan

The following four field-busses can be selected:

- Profibus
- Profinet
- DeviceNet
- EthernetIP

NOTE

The start conditions will be ignored while in the wizard.

NOTE

The Smart Setup runs automatically on the first power-up of the frequency converter or after a reset to factory settings. If no action is taken, the SAS screen will automatically disappear after 10 min.

2.1.8 Main Menu Mode

Start the Main Menu mode by pressing [Main Menu]. The read-out shown below appears on the display. The middle and bottom sections on the display show a list of parameter groups which can be chosen by toggling [▲] and [▼] keys.

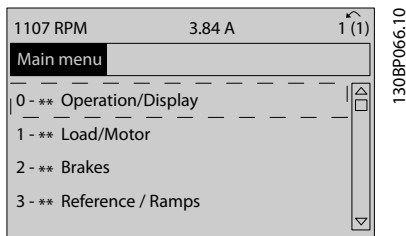

Illustration 2.14

Each parameter has a name and number which remain the same regardless of the programming mode. In the Main Menu mode, the parameters are divided into groups. The first digit of the parameter number (from the left) indicates the parameter group number.

All parameters can be changed in the Main Menu. However, depending on the choice of configuration (*1-00 Configuration Mode*), some parameters can be "missing". E.g. open loop hides all the PID parameters, and other enabled options make more parameter groups visible.

2.1.9 Parameter Selection

In the Main menu mode, the parameters are divided into groups. Select a parameter group with the navigation keys. The following parameter groups are accessible:

Group no.	Parameter group
0-**	Operation/Display
1-**	Load/Motor
2-**	Brakes
3-**	References/Ramps
4-**	Limits/Warnings
5-**	Digital In/Out
6-**	Analog In/Out
7-**	Controls
8-**	Comm. and Options
9-**	Profibus
10-**	CAN Fieldbus
11-**	Reserved Com. 1
12-**	Reserved Com. 2
13-**	Smart Logic
14-**	Special Functions
15-**	Drive Information
16-**	Data Readouts
17-**	Motor Feedb. Option
18-**	Data Readouts 2
30-**	Special Features
32-**	MCO Basic Settings
33-**	MCO Adv. Settings
34-**	MCO Data Readouts

Table 2.4

After selecting a parameter group, choose a parameter by means of the navigation keys. The middle section on the display shows the parameter number and name as well as the selected parameter value.

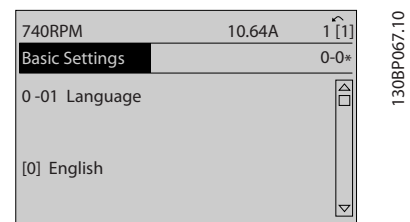
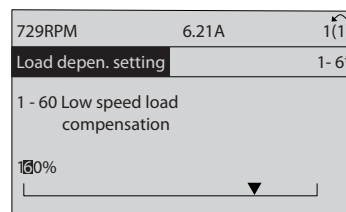

Illustration 2.15

2.1.10 Changing Data

The procedure for changing data is the same in the Quick menu and the Main menu mode. Press [OK] to change the selected parameter.

The procedure for changing data depends on whether the selected parameter represents a numerical data value or a text value.



130BP070.10

Illustration 2.18

2.1.11 Changing a Text Value

If the selected parameter is a text value, change the text value with the [▲] [▼] keys.

Place the cursor on the value to save and press [OK].

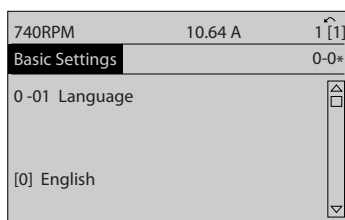

130BP068.10

Illustration 2.16

2.1.13 Infinitely Variable Change of Numeric Data Value

If the chosen parameter represents a numeric data value, select a digit with [◀] [▶].

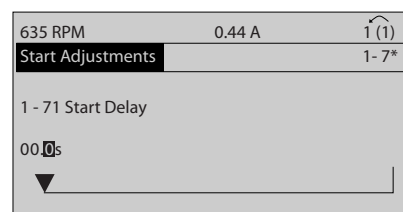

130BP073.10

Illustration 2.19

2.1.12 Changing

If the chosen parameter represents a numeric data value, change the chosen data value by means of the [◀] [▶] navigation keys as well as the [▲] [▼] navigation keys. Press [◀] [▶] keys to move the cursor horizontally.

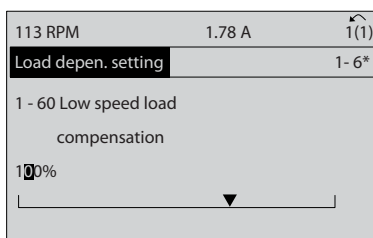

130BP069.10

Illustration 2.17

Press [▲] [▼] keys to change the data value. [▲] increases the data value, and [▼] decreases the data value. Place the cursor on the value to save and press [OK].

Change the selected digit infinitely variably with [▲] [▼]. The chosen digit is indicated by the cursor. Place the cursor on the digit to save and press [OK].

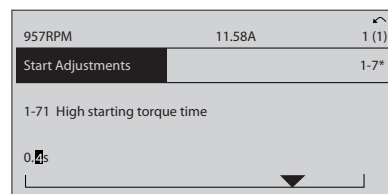

130BP072.10

Illustration 2.20

2.1.14 Value, Step-by-Step

Certain parameters can be changed step by step or infinitely varying. This applies to 1-20 Motor Power [kW], 1-22 Motor Voltage and 1-23 Motor Frequency. The parameters are changed both as a group of numeric data values and as numeric data values infinitely varying.

2

2.1.15 Read-out and Programming of Indexed Parameters

Parameters are indexed when placed in a rolling stack. 15-30 Fault Log: Error Code to 15-32 Alarm Log: Time contain a fault log which can be read out. Choose a parameter, press [OK], and use [▲] [▼] to scroll through the value log.

Use 3-10 Preset Reference as another example:

Choose the parameter, press [OK], and use [▲] [▼] to scroll through the indexed values. To change the parameter value, select the indexed value and press [OK]. Change the value by pressing [▲] [▼]. Press [OK] to accept the new setting. Press [Cancel] to abort. Press [Back] to leave the parameter.

The following instructions are valid for the Numerical LCP (LCP 101).

The control panel is divided into four functional groups:

1. Numerical display.
2. Menu keys and indicator lights - changing parameters and switching between display functions.
3. Navigation keys and indicator lights (LEDs).
4. Operation keys and indicator lights (LEDs).

Display line: Status messages displaying icons and numeric value.

Indicator lights (LEDs)

- Green LED/On: Indicates if control section is on.
- Yellow LED/Wrn.: Indicates a warning.
- Flashing red LED/Alarm: Indicates an alarm.

LCP keys

[Menu] Select one of the following modes:

- Status
- Quick Setup
- Main Menu

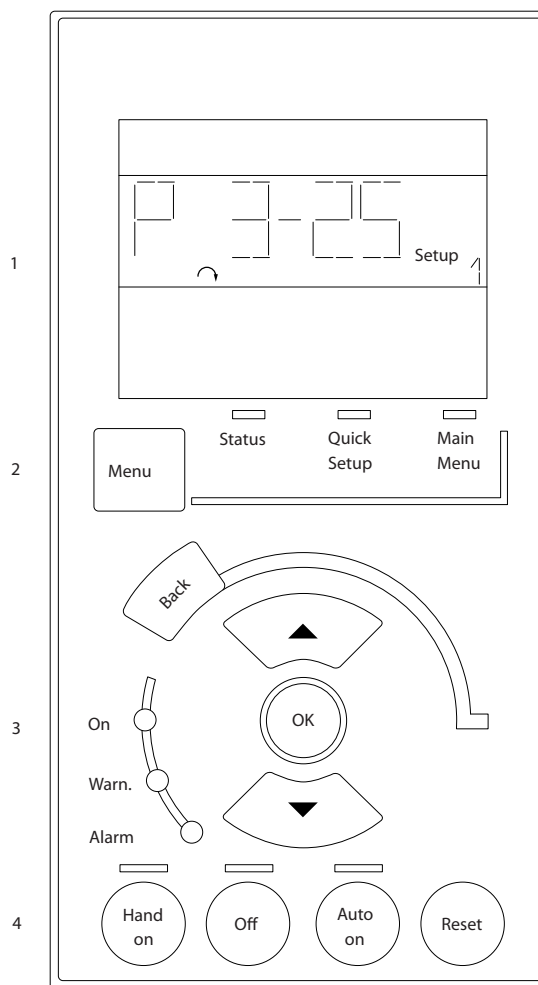

130BA191.10

Illustration 2.21

Status Mode

Displays the status of the frequency converter or the motor.

If an alarm occurs the NLCP automatically switches to status mode.

A number of alarms can be displayed.

NOTE

Parameter copy is not possible with LCP 101 Numerical Local Control Panel.

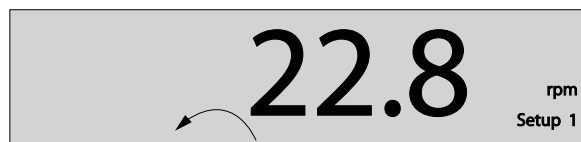

130BP077.10

Illustration 2.22



Illustration 2.23

Main Menu/Quick Setup is used for programming all parameters or only the parameters in the Quick Menu (see also description of the LCP 102 earlier in).

The parameter values can be changed by pressing [▲] or [▼] when the value is flashing.

Select Main Menu by pressing [Menu] a number of times.

Select the parameter group [xx-__] and press [OK]

Select the parameter [__-xx] and press [OK]

If the parameter is an array parameter select the array number and press [OK]

Select the wanted data value and press [OK]

Parameters with functional choices display values such as [1], [2], etc. For a description of the different choices, see the individual description of the parameters in *3 Parameter Descriptions*

[Back] for stepping backwards

[▲] [▼] are used for manoeuvring between commands and within parameters.

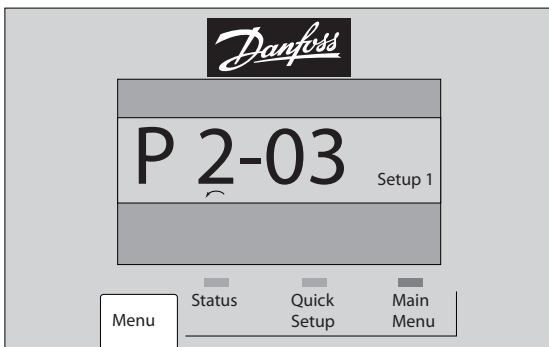

Illustration 2.24

2.1.16 Local Control Keys

Keys for local control are found at the bottom of the LCP.

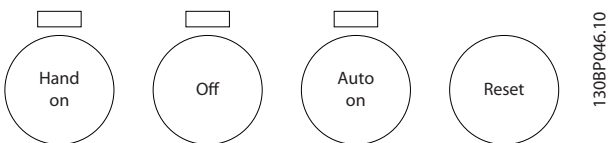

Illustration 2.25

[Hand On] enables control of the frequency converter via the LCP. [Hand On] also starts the motor and it is now

possible to enter the motor speed data by means of the arrow keys. The key can be selected as [1] Enable or [0] Disable via 0-40 [Hand on] Key on LCP.

External stop signals activated by means of control signals or a serial bus will override a 'start' command via the LCP. The following control signals are still active when [Hand On] is activated:

- [Hand On] - [Off] - [Auto On]
- Reset
- Coasting stop inverse
- Reversing
- Set-up select lsb - Set-up select msb
- Stop command from serial communication
- Quick stop
- DC brake

[Off] stops the connected motor. The key can be selected as [1] Enable or [0] Disable via 0-41 [Off] Key on LCP.

If no external stop function is selected and the [Off] key is inactive the motor can be stopped by disconnecting the voltage.

[Auto On] enables the frequency converter to be controlled via the control terminals and/or serial communication. When a start signal is applied on the control terminals and/or the bus, the frequency converter will start. The key can be selected as [1] Enable or [0] Disable via 0-42 [Auto on] Key on LCP.

NOTE

An active HAND-OFF-AUTO signal via the digital inputs has higher priority than the control keys [Hand On] [Auto On].

[Reset] is used for resetting the frequency converter after an alarm (trip). It can be selected as [1] Enable or [0] Disable via 0-43 [Reset] Key on LCP.

2.1.17 Initialisation to Default Settings

Initialise the frequency converter to default settings in two ways.

Recommended initialisation (via 14-22 Operation Mode)

1. Select 14-22 Operation Mode
2. Press [OK]
3. Select "Initialisation"
4. Press [OK]
5. Cut off the mains supply and wait until the display turns off.

6. Reconnect the mains supply - the frequency converter is now reset.

14-22 Operation Mode initialises all except:

- 14-50 RFI Filter
- 8-30 Protocol
- 8-31 Address
- 8-32 FC Port Baud Rate
- 8-35 Minimum Response Delay
- 8-36 Max Response Delay
- 8-37 Max Inter-Char Delay
- 15-00 Operating Hours to 15-05 Over Volt's
- 15-20 Historic Log: Event to 15-22 Historic Log: Time
- 15-30 Fault Log: Error Code to 15-32 Alarm Log: Time

Manual initialisation

1. Disconnect from mains and wait until the display turns off.
2.
 - 2a Press [Status] - [Main Menu] - [OK] at the same time while power up for LCP 102, Graphical Display
 - 2b Press [Menu] while power up for LCP 101, Numerical Display
3. Release the keys after 5 s.
4. The frequency converter is now programmed according to default settings.

This procedure initialises all except:

- 15-00 Operating Hours
- 15-03 Power Up's
- 15-04 Over Temp's
- 15-05 Over Volt's

NOTE

A manual initialisation also resets serial communication, RFI filter settings (14-50 RFI Filter) and fault log settings.

3 Parameter Descriptions

3.1 Parameter Selection

Parameters for FC 300 are grouped into various parameter groups for easy selection of the correct parameters for optimized operation of the frequency converter.

0-** Operation and Display parameters

- Basic Settings, set-up handling
- Display and Local Control Panel parameters for choosing readouts, setting up selections and copying functions

1-** Load and Motor parameters includes all load and motor related parameters

2-** Brake parameters

- DC brake
- Dynamic brake (Resistor brake)
- Mechanical brake
- Over Voltage Control

3-** References and ramping parameters includes DigiPot function

4-** Limits Warnings; setting of limits and warning parameters

5-** Digital inputs and outputs includes relay controls

6-** Analog inputs and outputs

7-** Controls; Setting parameters for speed and process controls

8-** Communication and option parameters for setting of FC RS485 and FC USB port parameters.

9-** Profibus parameters

10-** DeviceNet and CAN Fieldbus parameters

12-** Ethernet parameters

13-** Smart Logic Control parameters

14-** Special function parameters

15-** Drive information parameters

16-** Readout parameters

17-** Encoder Option parameters

18-** Readout 2 parameters

30-** Special Features

32-** MCO Basic Settings parameters

33-** MCO Adv. Settings parameters

34-** MCO Data Readouts

35-** Sensor Input Option parameters

To see if a parameter can be used in a specific control mode, use the table in *4.1.2 Active/Inactive Parameters in Different Drive Control Modes*.

3.2 Parameters: 0-** Operation and Display

Parameters related to the fundamental functions of the frequency converter, function of the LCP keys and configuration of the LCP display.

3.2.1 0-0* Basic Settings

0-01 Language		
Option:	Function:	
		Defines the language to be used in the display. The frequency converter can be delivered with 4 different language packages. English and German are included in all packages. English cannot be erased or manipulated.
[0] *	English	Part of Language packages 1 - 4
[1]	Deutsch	Part of Language packages 1 - 4
[2]	Francais	Part of Language package 1
[3]	Dansk	Part of Language package 1
[4]	Spanish	Part of Language package 1
[5]	Italiano	Part of Language package 1
[6]	Svenska	Part of Language package 1
[7]	Nederlands	Part of Language package 1
[10]	Chinese	Part of Language package 2
[20]	Suomi	Part of Language package 1
[22]	English US	Part of Language package 4
[27]	Greek	Part of Language package 4
[28]	Bras.port	Part of Language package 4
[36]	Slovenian	Part of Language package 3
[39]	Korean	Part of Language package 2
[40]	Japanese	Part of Language package 2
[41]	Turkish	Part of Language package 4
[42]	Trad.Chinese	Part of Language package 2
[43]	Bulgarian	Part of Language package 3
[44]	Srpski	Part of Language package 3
[45]	Romanian	Part of Language package 3
[46]	Magyar	Part of Language package 3
[47]	Czech	Part of Language package 3
[48]	Polski	Part of Language package 4
[49]	Russian	Part of Language package 3
[50]	Thai	Part of Language package 2

0-01 Language		
Option:	Function:	
[51]	Bahasa Indonesia	Part of Language package 2
[52]	Hrvatski	Part of Language package 3

0-02 Motor Speed Unit		
Option:	Function:	
		The display showing depends on settings in <i>0-02 Motor Speed Unit</i> and <i>0-03 Regional Settings</i> . The default setting of <i>0-02 Motor Speed Unit</i> and <i>0-03 Regional Settings</i> depends on which region of the world the frequency converter is supplied to, but can be re-programmed as required. NOTE Changing the <i>Motor Speed Unit</i> will reset certain parameters to their initial value. It is recommended to select the motor speed unit first, before modifying other parameters.
[0]	RPM	Selects display of motor speed variables and parameters (i.e. references, feedbacks and limits) in terms of motor speed (RPM).
[1] *	Hz	Selects display of motor speed variables and parameters (i.e. references, feedbacks and limits) in terms of output frequency to the motor (Hz).

NOTE

This parameter cannot be adjusted while the motor is running.

0-03 Regional Settings		
Option:	Function:	
[0] *	International	Activates <i>1-20 Motor Power [kW]</i> for setting the motor power in kW and sets the default value of <i>1-23 Motor Frequency</i> to 50Hz.
[1]	US	Activates <i>1-20 Motor Power [kW]</i> for setting the motor power in HP and sets the default value of <i>1-23 Motor Frequency</i> to 60Hz.

NOTE

This parameter cannot be adjusted while the motor is running.

0-04 Operating State at Power-up (Hand)		
Option:	Function:	
		Selects the operating mode upon reconnection of the frequency converter to mains voltage after power down in Hand (local) operation mode.
[0]	Resume	Restarts the frequency converter, maintaining the same and the same start/stop settings

0-04 Operating State at Power-up (Hand)		
Option:	Function:	
		(applied by [Hand On/Off]) as before the frequency converter was powered down.
[1] *	Forced stop, ref=old	Restarts the frequency converter with a saved local reference, after mains voltage reappears and after pressing [Hand On].
[2]	Forced stop, ref=0	Resets the local reference to 0 upon restarting the frequency converter.

3.2.2 0-1* Set-up Operations

Define and control the individual parameter setups. The frequency converter has four parameter setups that can be programmed independently of each other. This makes the frequency converter very flexible and able to solve advanced control functionality problems, often saving the cost of external control equipment. For example these can be used to program the frequency converter to operate according to one control scheme in one setup (e.g. motor 1 for horizontal movement) and another control scheme in another setup (e.g. motor 2 for vertical movement). Alternatively they can be used by an OEM machine builder to identically program all their factory fitted frequency converters for different machine types within a range to have the same parameters and then during production/commissioning simply select a specific setup depending on which machine the frequency converter is installed on.

The active setup (i.e. the setup in which the frequency converter is currently operating) can be selected in *0-10 Active Set-up* and is displayed in the LCP. Using Multi set-up it is possible to switch between setups with the frequency converter running or stopped, via digital input or serial communication commands. If it is necessary to change setups whilst running, ensure *0-12 This Set-up Linked to* is programmed as required. Using *0-11 Edit Set-up* it is possible to edit parameters within any of the setups whilst continuing the frequency converter operation in its Active Setup which can be a different setup to that being edited. Using *0-51 Set-up Copy* it is possible to copy parameter settings between the setups to enable quicker commissioning if similar parameter settings are required in different setups.

0-10 Active Set-up		
Option:	Function:	
		Select the set-up to control the frequency converter functions.
[0]	Factory setup	Cannot be changed. It contains the Danfoss data set, and can be used as a data source when returning the other set-ups to a known state.

0-10 Active Set-up		
Option:	Function:	
[1] *	Set-up 1	[1] Set-up 1 to [4] Set-up 4 are the four separate parameter set-ups within which all parameters can be programmed.
[2]	Set-up 2	
[3]	Set-up 3	
[4]	Set-up 4	
[9]	Multi Set-up	Remote selection of set-ups using digital inputs and the serial communication port. This set-up uses the settings from <i>0-12 This Set-up Linked to</i> . Stop the frequency converter before making changes to open- and closed loop functions

Use *0-51 Set-up Copy* to copy a set-up to one or all other set-ups. Stop the frequency converter before switching between set-ups where parameters marked 'not changeable during operation' have different values. To avoid conflicting settings of the same parameter within two different set-ups, link the set-ups together using *0-12 This Set-up Linked to*. Parameters which are 'not changeable during operation' are marked FALSE in the parameter lists in *4 Parameter Lists*.

0-11 Edit Set-up		
Option:	Function:	
		Select the set-up to be edited (i.e. programmed) during operation; either the active set-up or one of the inactive set-ups.
[0]	Factory setup	Cannot be edited but it is useful as a data source to return the other set-ups to a known state.
[1] *	Set-up 1	[1] Set-up 1 to [4] Set-up 4 can be edited freely during operation, independently of the active set-up.
[2]	Set-up 2	
[3]	Set-up 3	
[4]	Set-up 4	
[9]	Active Set-up	Can also be edited during operation. Edit the chosen set-up from a range of sources: LCP, FC RS-485, FC USB or up to five fieldbus sites.

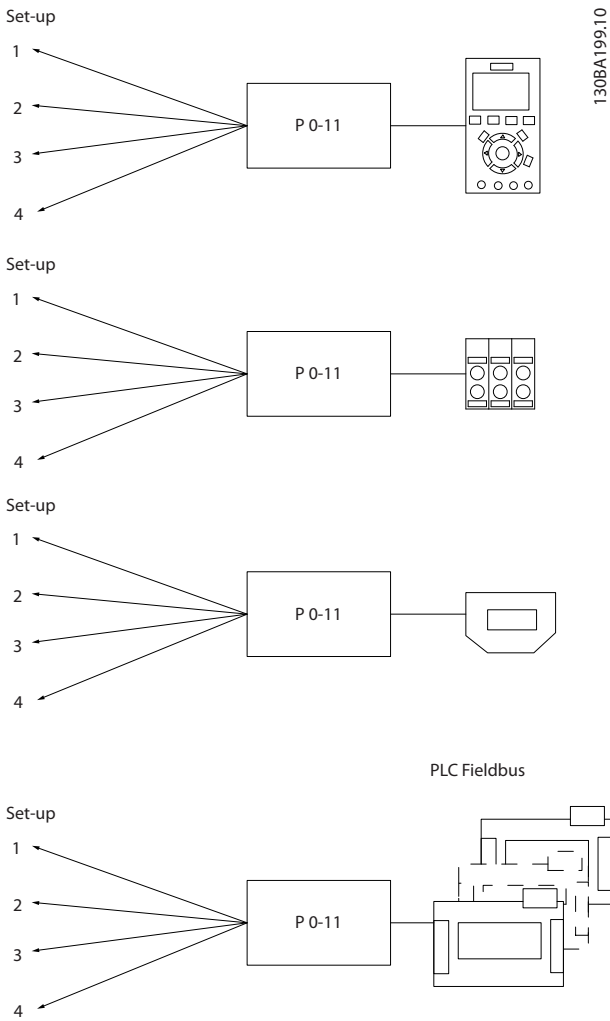

Illustration 3.1

130BA199;10

0-12 This Set-up Linked to	
Option:	Function:
	<p>To enable conflict-free changes from one set-up to another during operation, link set-ups containing parameters which are not changeable during operation. The link will ensure synchronising of the 'not changeable during operation' parameter values when moving from one set-up to another during operation. 'Not changeable during operation' parameters can be identified by the label FALSE in the parameter lists in the section <i>Parameter Lists</i>.</p> <p>0-12 This Set-up Linked to is used by Multi set-up in 0-10 Active Set-up. Multi set-up is used to move from one set-up to another during operation (i.e. while the motor is running). Example: Use Multi set-up to shift from Set-up 1 to Set-up 2 whilst the motor is running. Programme in Set-up 1 first, then ensure that Set-up 1 and</p>

0-12 This Set-up Linked to

Option:	Function:
	<p>Set-up 2 are synchronised (or 'linked'). Synchronisation can be performed in two ways:</p> <ol style="list-style-type: none"> 1. Change the edit set-up to Set-up 2 [2] in 0-11 Edit Set-up and set 0-12 This Set-up Linked to to Set-up 1 [1]. This will start the linking (synchronising) process. <div data-bbox="1061 555 1380 716" data-label="Image"> </div> <p>Illustration 3.2</p> <p>OR</p> <ol style="list-style-type: none"> 2. While still in Set-up 1, copy Set-up 1 to Set-up 2. Then set 0-12 This Set-up Linked to to Set-up 2 [2]. This will start the linking process. <div data-bbox="1061 996 1380 1158" data-label="Image"> </div> <p>Illustration 3.3</p> <p>After the link is complete, 0-13 Readout: Linked Set-ups will read {1,2} to indicate that all 'not changeable during operation' parameters are now the same in Set-up 1 and Set-up 2. If there are changes to a 'not changeable during operation' parameter, e.g. 1-30 Stator Resistance (Rs), in Set-up 2, they will also be changed automatically in Set-up 1. A switch between Set-up 1 and Set-up 2 during operation is now possible.</p>

[0] *	Not linked
[1]	Set-up 1
[2]	Set-up 2
[3]	Set-up 3
[4]	Set-up 4

0-13 Readout: Linked Set-ups														
Array [5]														
Range:	Function:													
0 *	[0 - 255]	View a list of all the set-ups linked by means of 0-12 <i>This Set-up Linked to</i> . The parameter has one index for each parameter set-up. The parameter value displayed for each index represents which set-ups are linked to that parameter set-up.												
<table border="1"> <thead> <tr> <th>Index</th> <th>LCP value</th> </tr> </thead> <tbody> <tr> <td>0</td> <td>{0}</td> </tr> <tr> <td>1</td> <td>{1,2}</td> </tr> <tr> <td>2</td> <td>{1,2}</td> </tr> <tr> <td>3</td> <td>{3}</td> </tr> <tr> <td>4</td> <td>{4}</td> </tr> </tbody> </table>			Index	LCP value	0	{0}	1	{1,2}	2	{1,2}	3	{3}	4	{4}
Index	LCP value													
0	{0}													
1	{1,2}													
2	{1,2}													
3	{3}													
4	{4}													
<p>Table 3.2 Example: Set-up 1 and Set-up 2 are linked</p>														

0-14 Readout: Edit Set-ups / Channel		
Range:	Function:	
0 N/A*	[-2147483648 - 2147483647 N/A]	View the setting of 0-11 <i>Edit Set-up</i> for each of the four different communication channels. When the number is displayed in hex, as it is in the LCP, each number represents one channel. Numbers 1-4 represent a set-up number; 'F' means factory setting; and 'A' means active set-up. The channels are, from right to left: LCP, FC-bus, USB, HPFB1-5. Example: The number AAAAAA21h means that the FC bus selected Set-up 2 in 0-11 <i>Edit Set-up</i> , the LCP selected Set-up 1 and all others used the active set-up.

0-15 Readout: actual setup		
Range:	Function:	
0 *	[0 - 255]	Makes it possible to read out the active set-up, also when multi set-up is selected in 0-10 <i>Active Set-up</i> .

3.2.3 0-2* LCP Display

Define the variables displayed in the Graphical Local Control Panel.

NOTE

Please refer to 0-37 *Display Text 1*, 0-38 *Display Text 2* and 0-39 *Display Text 3* for information on how to write display texts.

0-20 Display Line 1.1 Small		
Option:	Function:	
		Select a variable for display in line 1, left position.
[0] *	None	No display value selected.
[953]	Profibus Warning Word	
[1005]	Readout Transmit Error Counter	
[1006]	Readout Receive Error Counter	
[1007]	Readout Bus Off Counter	
[1013]	Warning Parameter	
[1230]	Warning Parameter	
[1472]	VLT Alarm Word	
[1473]	VLT Warning Word	
[1474]	VLT Ext. Status Word	
[1501]	Running Hours	
[1502]	kWh Counter	
[1600]	Control Word	Present control word
[1601]	Reference [Unit]	Total reference (sum of digital/analog/preset/bus/freeze ref./catch up and slow-down) in selected unit.
[1602]	Reference %	Total reference (sum of digital/analog/preset/bus/freeze ref./catch up and slow-down) in percent.
[1603]	Status Word	Present status word.
[1605]	Main Actual Value [%]	Actual value as a percentage.
[1609]	Custom Readout	
[1610]	Power [kW]	Actual power consumed by the motor in kW.
[1611]	Power [hp]	Actual power consumed by the motor in HP.
[1612]	Motor Voltage	Voltage supplied to the motor.
[1613]	Frequency	Motor frequency, i.e. the output frequency from the frequency converter in Hz
[1614]	Motor Current	Phase current of the motor measured as effective value.
[1615]	Frequency [%]	Motor frequency, i.e. the output frequency from the frequency converter in percent.
[1616]	Torque [Nm]	Actual motor torque in Nm
[1617] *	Speed [RPM]	Speed in RPM (revolutions per minute) i.e. the motor shaft speed in closed loop.

0-20 Display Line 1.1 Small		
Option:	Function:	
[1618]	Motor Thermal	Thermal load on the motor, calculated by the ETR function.
[1619]	KTY sensor temperature	
[1620]	Motor Angle	
[1622]	Torque [%]	Present motor load as a percentage of the rated motor torque.
[1625]	Torque [Nm] High	
[1630]	DC Link Voltage	Intermediate circuit voltage in the frequency converter.
[1632]	Brake Energy /s	Present brake power transferred to an external brake resistor. Stated as an instantaneous value.
[1633]	Brake Energy /2 min	Brake power transferred to an external brake resistor. The mean power is calculated continuously for the most recent 120 s.
[1634]	Heatsink Temp.	Present heat sink temperature of the frequency converter. The cut-out limit is 95 ±5 °C; cutting back in occurs at 70 ±5 °C.
[1635]	Inverter Thermal	Percentage load of the inverters.
[1636]	Inv. Nom. Current	Nominal current of the frequency converter.
[1637]	Inv. Max. Current	Maximum current of the frequency converter.
[1638]	SL Controller State	State of the event executed by the control.
[1639]	Control Card Temp.	Temperature of the control card.
[1650]	External Reference	Sum of the external reference as a percentage, i.e. the sum of analog/pulse/bus.
[1651]	Pulse Reference	Frequency in Hz connected to the digital inputs (18, 19 or 32, 33).
[1652]	Feedback [Unit]	Reference value from programmed digital input(s).
[1653]	Digi Pot Reference	
[1660]	Digital Input	Signal states from the 6 digital terminals (18, 19, 27, 29, 32 and 33). There are 16 bits in total, but only six of them are used. Input 18 corresponds to the leftmost of the used bits. Signal low = 0; Signal high = 1.

0-20 Display Line 1.1 Small		
Option:	Function:	
[1661]	Terminal 53 Switch Setting	Setting of input terminal 54. Current = 0; Voltage = 1.
[1662]	Analog Input 53	Actual value at input 53 either as a reference or protection value.
[1663]	Terminal 54 Switch Setting	Setting of input terminal 54. Current = 0; Voltage = 1.
[1664]	Analog Input 54	Actual value at input 54 either as reference or protection value.
[1665]	Analog Output 42 [mA]	Actual value at output 42 in mA. Use 6-50 Terminal 42 Output to select the value to be shown.
[1666]	Digital Output [bin]	Binary value of all digital outputs.
[1667]	Freq. Input #29 [Hz]	Actual value of the frequency applied at terminal 29 as an impulse input.
[1668]	Freq. Input #33 [Hz]	Actual value of the frequency applied at terminal 33 as an impulse input.
[1669]	Pulse Output #27 [Hz]	Actual value of impulses applied to terminal 27 in digital output mode.
[1670]	Pulse Output #29 [Hz]	Actual value of impulses applied to terminal 29 in digital output mode.
[1671]	Relay Output [bin]	
[1672]	Counter A	Application dependent (e.g. SLC Control)
[1673]	Counter B	Application dependent (e.g. SLC Control)
[1674]	Prec. Stop Counter	Display the actual counter value.
[1675]	Analog In X30/11	Actual value at input X30/11 either as reference or protection value.
[1676]	Analog In X30/12	Actual value at input X30/12 either as reference or protection value.
[1677]	Analog Out X30/8 [mA]	Actual value at output X30/8 in mA. Use 6-60 Terminal X30/8 Output to select the value to be shown.
[1678]	Analog Out X45/1 [mA]	
[1679]	Analog Out X45/3 [mA]	
[1680]	Fieldbus CTW 1	Control word (CTW) received from the Bus Master.

0-20 Display Line 1.1 Small		
Option:	Function:	
[1682]	Fieldbus REF 1	Main reference value sent with control word from the Bus Master.
[1684]	Comm. Option STW	Extended fieldbus communication option status word.
[1685]	FC Port CTW 1	Control word (CTW) received from the Bus Master.
[1686]	FC Port REF 1	Status word (STW) sent to the Bus Master.
[1690]	Alarm Word	One or more alarms in a Hex code.
[1691]	Alarm Word 2	One or more alarms in a Hex code.
[1692]	Warning Word	One or more warnings in a Hex code.
[1693]	Warning Word 2	One or more warnings in a Hex code.
[1694]	Ext. Status Word	One or more status conditions in a Hex code.
[3401]	PCD 1 Write to MCO	
[3402]	PCD 2 Write to MCO	
[3403]	PCD 3 Write to MCO	
[3404]	PCD 4 Write to MCO	
[3405]	PCD 5 Write to MCO	
[3406]	PCD 6 Write to MCO	
[3407]	PCD 7 Write to MCO	
[3408]	PCD 8 Write to MCO	
[3409]	PCD 9 Write to MCO	
[3410]	PCD 10 Write to MCO	
[3421]	PCD 1 Read from MCO	
[3422]	PCD 2 Read from MCO	
[3423]	PCD 3 Read from MCO	
[3424]	PCD 4 Read from MCO	
[3425]	PCD 5 Read from MCO	
[3426]	PCD 6 Read from MCO	
[3427]	PCD 7 Read from MCO	
[3428]	PCD 8 Read from MCO	
[3429]	PCD 9 Read from MCO	
[3430]	PCD 10 Read from MCO	
[3440]	Digital Inputs	

0-20 Display Line 1.1 Small		
Option:	Function:	
[3441]	Digital Outputs	
[3450]	Actual Position	
[3451]	Commanded Position	
[3452]	Actual Master Position	
[3453]	Slave Index Position	
[3454]	Master Index Position	
[3455]	Curve Position	
[3456]	Track Error	
[3457]	Synchronizing Error	
[3458]	Actual Velocity	
[3459]	Actual Master Velocity	
[3460]	Synchronizing Status	
[3461]	Axis Status	
[3462]	Program Status	
[3470]	MCO Alarm Word 1	
[3471]	MCO Alarm Word 2	
[9913]	Idle time	
[9914]	Paramdb requests in queue	
[9920]	HS Temp. (PC1)	
[9921]	HS Temp. (PC2)	
[9922]	HS Temp. (PC3)	
[9923]	HS Temp. (PC4)	
[9924]	HS Temp. (PC5)	
[9925]	HS Temp. (PC6)	
[9926]	HS Temp. (PC7)	
[9927]	HS Temp. (PC8)	

0-21 Display Line 1.2 Small

Option:	Function:	
[0] *	None	Select a variable for display in line 1, middle position. The options are the same as listed for 0-20 Display Line 1.1 Small.

0-22 Display Line 1.3 Small

Option:	Function:	
[30120] *	Mains Current [A]	Select a variable for display in line 1, right position. The options are the same as listed for 0-20 Display Line 1.1 Small.

0-23 Display Line 2 Large

Option:	Function:	
[30100] *	Output Current [A]	Select a variable for display in line 2. The options are the same as listed for 0-20 Display Line 1.1 Small.

0-24 Display Line 3 Large

Select a variable for display in line 3.

Option:	Function:	
[30121] *	Mains Frequency	The options are the same as those listed in 0-20 Display Line 1.1 Small.

0-25 My Personal Menu		
Range:	Function:	
0	[0 -	Define up to 50 parameters to appear in the Q1 Personal Menu, accessible via the [Quick Menu] key on the LCP. The parameters will be displayed in the Q1 Personal Menu in the order they are programmed into this array parameter. Delete parameters by setting the value to '0000'. For example, this can be used to provide quick, simple access to just one or up to 50 parameters which require changing on a regular basis (e.g. for plant maintenance reasons) or by an OEM to enable simple commissioning of their equipment.
N/A*	9999	
	N/A]	

3.2.4 0-3* LCP Custom Readout

It is possible to customize the display elements for various purposes: *Custom Readout. Value proportional to speed (Linear, squared or cubed depending on unit selected in 0-30 Custom Readout Unit) *Display Text. Text string stored in a parameter.

Custom Readout

The calculated value to be displayed is based on settings in 0-30 Custom Readout Unit, 0-31 Custom Readout Min Value (linear only), 0-32 Custom Readout Max Value, 4-13 Motor Speed High Limit [RPM], 4-14 Motor Speed High Limit [Hz] and actual speed.

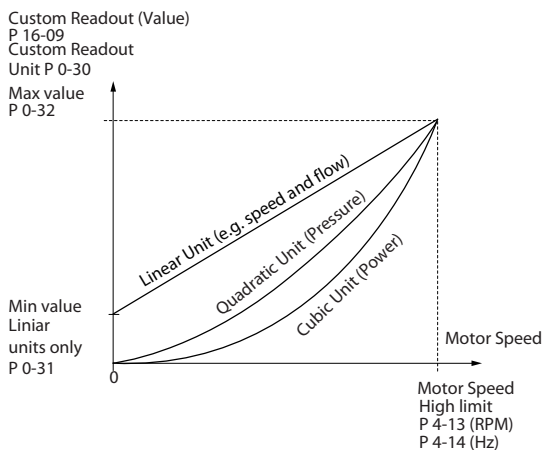

Illustration 3.4

The relation will depend on the type of unit selected in 0-30 Custom Readout Unit:

Unit Type	Speed Relation
Dimensionless	Linear
Speed	
Flow, volume	
Flow, mass	
Velocity	
Length	
Temperature	
Pressure	Quadratic
Power	Cubic

Table 3.3

0-30 Unit for User-defined Readout		
Option:	Function:	
		It is possible to program a value to be shown in the display of the LCP. The value will have a linear, squared or cubed relation to speed. This relation will depend on the unit selected (see table above). The actual calculated value can be read in 16-09 Custom Readout, and/or shown in the display by selecting Custom Readout [16-09] in 0-20 Display Line 1.1 Small to 0-24 Display Line 3 Large.
[0] *	None	
[1]	%	
[5]	PPM	
[10]	1/min	
[11]	rpm	
[12]	Pulse/s	
[20]	l/s	
[21]	l/min	
[22]	l/h	
[23]	m ³ /s	
[24]	m ³ /min	
[25]	m ³ /h	
[30]	kg/s	
[31]	kg/min	
[32]	kg/h	
[33]	t/min	
[34]	t/h	
[40]	m/s	
[41]	m/min	
[45]	m	
[60]	°C	
[70]	mbar	
[71]	bar	
[72]	Pa	
[73]	kPa	
[74]	m WG	
[80]	kW	
[120]	GPM	
[121]	gal/s	
[122]	gal/min	
[123]	gal/h	

0-30 Unit for User-defined Readout	
Option:	Function:
[124] CFM	
[125] ft ³ /s	
[126] ft ³ /min	
[127] ft ³ /h	
[130] lb/s	
[131] lb/min	
[132] lb/h	
[140] ft/s	
[141] ft/min	
[145] ft	
[160] °F	
[170] psi	
[171] lb/in ²	
[172] in WG	
[173] ft WG	
[180] HP	

0-31 Min Value of User-defined Readout		
Range:	Function:	
0.00 Custom-ReadoutUnit*	[-999999.99 - par. 0-32 CustomReadoutUnit]	This parameter sets the min. value of the custom defined readout (occurs at zero speed). Only possible to set different from 0 is when selecting a linear unit in 0-30 Unit for User-defined Readout. For Quadratic and Cubic units the minimum value will be 0.

0-32 Custom Readout Max Value		
Range:	Function:	
100.00 Custom-ReadoutUnit*	[par. 0-31 - 999999.99 CustomReadoutUnit]	This parameter sets the max value to be shown when the speed of the motor has reached the set value for 4-13 Motor Speed High Limit [RPM] or 4-14 Motor Speed High Limit [Hz] (depends on setting in 0-02 Motor Speed Unit).

0-37 Display Text 1	
Range:	Function:
0 * [0 - 0]	Enter a text which can be viewed in the graphical display by selecting Display Text 1 [37] in 0-20 Display Line 1.1 Small, 0-21 Display Line 1.2 Small, 0-22 Display Line 1.3 Small, 0-23 Display Line 2 Large or 0-24 Display Line 3 Large.

0-38 Display Text 2	
Range:	Function:
0 * [0 - 0]	Enter a text which can be viewed in the graphical display by selecting Display Text 2 [38] in 0-20 Display Line 1.1 Small, 0-21 Display Line 1.2 Small, 0-22 Display Line 1.3 Small, 0-23 Display Line 2 Large or 0-24 Display Line 3 Large.

0-39 Display Text 3	
Range:	Function:
0 * [0 - 0]	Enter a text which can be viewed in the graphical display by selecting Display Text 3 [39] in 0-20 Display Line 1.1 Small, 0-21 Display Line 1.2 Small, 0-22 Display Line 1.3 Small, 0-23 Display Line 2 Large or 0-24 Display Line 3 Large.

3.2.5 0-4* LCP Keypad

Enable, disable and password protect individual keys on the LCP.

0-40 [Hand on] Key on LCP		
Option:	Function:	
[0] * Disabled	No effect when [Hand On] is pressed. Select [0] Disabled to avoid accidental start of the frequency converter in Hand on mode.	
[1] * Enabled	The LCP switches to Hand on mode directly when [Hand on] is pressed.	
[2] Password	After pressing [Hand on] a password is required. If 0-40 [Hand on] Key on LCP is included in My Personal Menu, define the password in 0-65 Quick Menu Password. Otherwise define the password in 0-60 Main Menu Password.	

0-41 [Off] Key on LCP		
Option:	Function:	
[0] * Disabled	Avoids accidental stop of the frequency converter.	
[1] * Enabled		
[2] Password	Avoids unauthorised stop. If 0-41 [Off] Key on LCP is included in the Quick Menu, then define the password in 0-65 Quick Menu Password.	

0-42 [Auto on] Key on LCP		
Option:	Function:	
[0] * Disabled	Avoid accidental start of the frequency converter in Auto mode.	
[1] * Enabled		
[2] Password	Avoids unauthorised start in Auto mode. If 0-42 [Auto on] Key on LCP is included in the Quick Menu, then define the password in 0-65 Quick Menu Password.	

0-43 [Reset] Key on LCP		
Option:	Function:	
[0] *	Disabled	No effect when [Reset] is pressed. Avoids accidental alarm reset.
[1] *	Enabled	
[2]	Password	Avoids unauthorised resetting. If 0-43 [Reset] Key on LCP is included in the Quick Menu, then define the password in 0-65 Quick Menu Password.

3.2.6 0-5* Copy/Save

Copy parameter settings between set-ups and to/from the LCP.

0-50 LCP Copy		
Option:	Function:	
[0] *	No copy	
[1]	All to LCP	Copies all parameters in all set-ups from the frequency converter memory to the LCP memory.
[2]	All from LCP	Copies all parameters in all set-ups from the LCP memory to the frequency converter memory.
[3]	Size indep. from LCP	Copy only the parameters that are independent of the motor size. The latter selection can be used to programme several frequency converters with the same function without disturbing motor data.
[4]	File from MCO to LCP	
[5]	File from LCP to MCO	

NOTE

This parameter cannot be adjusted while the motor is running.

0-51 Set-up Copy		
Option:	Function:	
[0] *	No copy	No function
[1]	Copy to set-up 1	Copies all parameters in the present Programming Set-up (defined in 0-11 Programming Set-up) to Set-up 1.
[2]	Copy to set-up 2	Copies all parameters in the present Programming Set-up (defined in 0-11 Programming Set-up) to Set-up 2.
[3]	Copy to set-up 3	Copies all parameters in the present Programming Set-up (defined in 0-11 Programming Set-up) to Set-up 3.

0-51 Set-up Copy		
Option:	Function:	
[4]	Copy to set-up 4	Copies all parameters in the present Programming Set-up (defined in 0-11 Programming Set-up) to Set-up 4.
[9]	Copy to all	Copies the parameters in the present set-up over to each of the set-ups 1 to 4.

3.2.7 0-6* Password

0-60 Main Menu Password		
Range:	Function:	
100 *	[0 - 999]	Define the password for access to the Main Menu via the [Main Menu] key. If 0-61 Access to Main Menu w/o Password is set to [0] Full access, this parameter will be ignored.

0-61 Access to Main Menu w/o Password		
Option:	Function:	
[0] *	Full access	Disables password defined in 0-60 Main Menu Password.
[1]	LCP: Read only	Prevent unauthorized editing of Main Menu parameters.
[2]	LCP: No access	Prevent unauthorized viewing and editing of Main Menu parameters.
[3]	Bus: Read only	Read-only functions for parameters on Fieldbus and/or FC standard bus.
[4]	Bus: No access	No access to parameters is allowed via Fieldbus and/or FC standard bus.
[5]	All: Read only	Read-only function for parameters on LCP, Fieldbus or FC standard bus.
[6]	All: No access	No access from LCP, Fieldbus or FC standard bus is allowed.

If Full access [0] is selected then 0-60 Main Menu Password, 0-65 Personal Menu Password and 0-66 Access to Personal Menu w/o Password will be ignored.

NOTE

A more complex Password protection is available for OEMs upon request.

0-65 Quick Menu Password		
Range:	Function:	
200 N/A*	[-9999 - 9999 N/A]	Define the password for access to the Quick Menu via the [Quick Menu] key. If 0-66 Access to Quick Menu w/o Password is set to [0] Full access, this parameter will be ignored.

0-66 Access to Quick Menu w/o Password		
Option:	Function:	
[0] *	Full access	Disables the password defined in 0-65 Quick Menu Password.
[1]	LCP: Read only	Prevents unauthorised editing of Quick Menu parameters.
[2]	LCP: No access	Prevents unauthorised viewing and editing of Quick Menu parameters.
[3]	Bus: Read only	Read only functions for Quick Menu parameters on Fieldbus and/ or FC standard bus.
[4]	Bus: No access	No access to Quick Menu parameters is allowed via Fieldbus and/ or FC standard bus.
[5]	All: Read only	read only function for Quick Menu parameters on LCP, Fieldbus or FC standard bus.
[6]	All: No access	No access from LCP, Fieldbus or FC standard bus is allowed.

If 0-61 Access to Main Menu w/o Password is set to [0] Full access then this parameter will be ignored.

0-67 Bus Password Access		
Range:	Function:	
0 N/A*	[0 - 9999 N/A]	Writing to this parameter enables users to unlock the frequency converter from bus/MCT 10 Set-up Software.

3.3 Parameters: 1-** Load and Motor

3.3.1 1-0* General Settings

Define whether the frequency converter operates in speed mode or torque mode; and whether the internal PID control should be active or not.

1-00 Configuration Mode		
Option:	Function:	
		Select the application control principle to be used when a Remote Reference (i.e. via analog input or fieldbus) is active. A Remote Reference can only be active when 3-13 Reference Site is set to [0] or [1].
[0] *	Speed open loop	Enables speed control (without feedback signal from motor) with automatic slip compensation for almost constant speed at varying loads. Compensations are active but can be disabled in the Load/Motor parameter group 1-0*. The speed control parameters are set in parameter group 7-0*.
[1]	Speed closed loop	Enables Speed closed loop control with feedback. Obtain full holding torque at 0 RPM. For increased speed accuracy, provide a feedback signal and set the speed PID control. The speed control parameters are set in parameter group 7-0*.
[2]	Torque	Enables torque closed loop control with feedback. Only possible with "Flux with motor feedback" option, 1-01 Motor Control Principle. FC 302 only.
[3]	Process	Enables the use of process control in the frequency converter. The process control parameters are set in parameter groups 7-2* and 7-3*.
[4]	Torque open loop	Enables the use of torque open loop in VVC ⁺ mode (1-01 Motor Control Principle). The torque PID parameters are set in parameter group 7-1*.

1-01 Motor Control Principle		
Option:	Function:	
		Select which motor control principle to employ.
[0] *	U/f	special motor mode, for parallel connected motors in special motor applications. When U/f is selected the characteristic of the control principle can be edited in 1-55 U/f Characteristic - U and 1-56 U/f Characteristic - F.
[1] *	VVC+	Voltage Vector Control principle suitable for most applications. The main benefit of VVC ^{plus} operation is that it uses a robust motor model.

1-01 Motor Control Principle		
Option:	Function:	
[2]	Flux sensorless	Flux Vector control without encoder feedback, for simple installation and robustness against sudden load changes. FC 302 only.
[3]	Flux w/ motor feedb	very high accuracy speed and torque control, suitable for the most demanding applications. FC 302 only.

The best shaft performance is normally achieved using either of the two Flux Vector control modes [2] Flux sensorless and [3] Flux with encoder feedback.

NOTE

This parameter cannot be adjusted while the motor is running.

NOTE

An overview of possible combinations of the settings in 1-00 Configuration Mode and 1-01 Motor Control Principle can be found in 4.1.2 Active/Inactive Parameters in Different Drive Control Modes.

1-02 Flux Motor Feedback Source		
Option:	Function:	
		Select the interface at which to receive feedback from the motor.
[0]	Motor feedb. P1-02	
[1] *	24V encoder	A and B channel encoder, which can be connected to the digital input terminals 32/33 only. Terminals 32/33 must be programmed to No operation.
[2]	MCB 102	Encoder module option which can be configured in parameter group 17-1* FC 302 only.
[3]	MCB 103	Optional resolver interface module which can be configured in parameter group 17-5*
[5]	MCO Encoder 2	encoder interface 2 of the optional programmable motion controller MCO 305.
[6]	Analog input 53	
[7]	Analog input 54	
[8]	Frequency input 29	
[9]	Frequency input 33	

NOTE

This parameter cannot be adjusted while the motor is running.

1-03 Torque Characteristics		
Option:	Function:	
		Select the torque characteristic required. VT and AEO are both energy saving operations.
[0] *	Constant torque	Motor shaft output provides constant torque under variable speed control.
[1]	Variable torque	Motor shaft output provides variable torque under variable speed control. Set the variable torque level in <i>14-40 VT Level</i> .
[2]	Auto Energy Optim.	Automatically optimises energy consumption by minimising magnetisation and frequency via <i>14-41 AEO Minimum Magnetisation</i> and <i>14-42 Minimum AEO Frequency</i> .

NOTE

This parameter cannot be adjusted while the motor is running.

1-04 Overload Mode		
Option:	Function:	
[0] *	High torque	Allows up to 160% over torque.
[1]	Normal torque	For oversized motor - allows up to 110% over torque.

NOTE

This parameter cannot be adjusted while the motor is running.

1-05 Local Mode Configuration		
Option:	Function:	
		Select which application configuration mode (<i>1-00 Configuration Mode</i>), i.e. application control principle, to use when a Local (LCP) Reference is active. A Local Reference can be active only when <i>3-13 Reference Site</i> is set to [0] or [2]. By default the local reference is active in Hand Mode only.
[0]	Speed open loop	
[1]	Speed closed loop	
[2] *	As mode par 1-00	

1-06 Clockwise Direction		
This parameter defines the term "Clockwise" corresponding to the LCP direction arrow. Used for easy change of direction of shaft rotation without swapping motor wires.		
Option:	Function:	
[0] *	Normal	Motor shaft will turn in clockwise direction when the frequency

1-06 Clockwise Direction		
This parameter defines the term "Clockwise" corresponding to the LCP direction arrow. Used for easy change of direction of shaft rotation without swapping motor wires.		
Option:	Function:	
		converter is connected U → U; V → V, and W → W to motor.
[1]	Inverse	Motor shaft will turn in counter clockwise direction when the frequency converter is connected U → U; V → V, and W → W to motor.

NOTE

This parameter cannot be adjusted while the motor is running.

1-07 Motor Angle Offset Adjust		
This parameter will adjust the motor angle offset for an absolute position feedback device mounted on the motor.		
Option:	Function:	
[0]	Manual	The frequency converter will use the motor angle offset entered in <i>1-41 Motor Angle Offset</i> .
[1]	Auto	The frequency converter will automatically adjust the motor angle offset by running a determined procedure.

NOTE

This parameter is only valid when PM motors in Flux with motor feedback are used and for FC 302 only.

3.3.2 1-1* Special Settings

NOTE

The parameters within this parameter group cannot be adjusted while the motor is running.

1-10 Motor Construction		
Option:	Function:	
		Select the motor design type.
[0] *	Asynchron	For asynchronous motors.
[1]	PM, non salient SPM	For salient or non-salient PM motors. PM motors are divided into two groups, with either surface mounted (non salient) or interior (salient) magnets.

1-11 Motor Model		
Automatically sets the manufacturer's values for the selected motor. If the default value [1] is used, settings must to be determined manually, according to the choice in <i>1-10 Motor Construction</i> . This parameter is FC 302 only.		
Option:	Function:	
[1]	Std. Asynchron	Default motor model when [0]* <i>Asynchron</i> is selected in <i>1-10 Motor Construction</i> . Enter motor parameter manually.
[2]	Std. PM, non salient	Selectable when [1] <i>PM, non salient SPM</i> is selected in <i>1-10 Motor Construction</i> . Enter motor parameter manually.
[10]	Danfoss OGD LA10	Selectable when [1] <i>PM, non salient SPM</i> is selected in <i>1-10 Motor Construction</i> . Only available for T4, T5 in 1.5-3 kW. Settings are loaded automatically for this specific motor. See table for details.

NOTE

This parameter is FC 302 only.

1-14 Damping Gain		
Range:	Function:	
140 %*	[0 - 250 %]	The damping gain will stabilize the PM machine in order to run the PM machine smooth and stable. The value of Damping gain will control the dynamic performance of the PM machine. High damping gain will give high dynamic performance and low damping gain will give low dynamic performance. The dynamic performance is related to the machine data and load type. If the damping gain is too high or low the control will become unstable.

1-15 Low Speed Filter Time Const.		
Range:	Function:	
Size related*	[0.01 - 20 s]	This time constant is used below 10% rated speed. Obtain quick control through a short damping time constant. However, if this value is too short, the control gets unstable.

1-16 High Speed Filter Time Const.		
Range:	Function:	
Size related*	[0.01 - 20 s]	This time constant is used above 10% rated speed. Obtain quick control through a short damping time constant. However, if this value

1-16 High Speed Filter Time Const.		
Range:	Function:	
		is too short, the control gets unstable.

1-17 Voltage filter time const.		
Range:	Function:	
Size related*	[0.001 - 1 s]	Reduces the influence of high frequency ripple and system resonance in the calculation of supply voltage. Without this filter, the ripples in the currents can distort the calculated voltage and affect the stability of the system.

3.3.3 1-2* Motor Data

Parameter group 1-2* comprises input data from the nameplate on the connected motor.

NOTE

Changing the value of these parameters affects the setting of other parameters.

NOTE

1-20 Motor Power [kW], 1-21 Motor Power [HP], 1-22 Motor Voltage and 1-23 Motor Frequency will not have effect when 1-10 Motor Construction = [1] PM, non salient SPM.

1-20 Motor Power [kW]		
Range:	Function:	
4.00 kW*	[0.09 - 3000.00 kW]	Enter the nominal motor power in kW according to the motor nameplate data. The default value corresponds to the nominal rated output of the unit. This parameter cannot be adjusted while the motor is running. This parameter is visible in LCP if <i>0-03 Regional Settings</i> is [0] <i>International</i> .
NOTE Four sizes down, one size up from nominal unit rating.		

1-21 Motor Power [HP]		
Range:	Function:	
4.00 hp*	[0.09 - 3000.00 hp]	Enter the nominal motor power in HP according to the motor nameplate data. The default value corresponds to the nominal rated output of the unit. This parameter is visible in LCP if <i>0-03 Regional Settings</i> is [1] <i>US</i>

1-22 Motor Voltage		
Range:		Function:
500. V*	[10. - 1000. V]	Enter the nominal motor voltage according to the motor nameplate data. The default value corresponds to the nominal rated output of the unit.

1-23 Motor Frequency		
Range:		Function:
50. Hz*	[20 - 1000 Hz]	Min - Max motor frequency: 20-1000 Hz. Select the motor frequency value from the motor nameplate data. If a value different from 50 Hz or 60 Hz is selected, it is necessary to adapt the load independent settings in <i>1-50 Motor Magnetisation at Zero Speed</i> to <i>1-53 Model Shift Frequency</i> . For 87 Hz operation with 230/400 V motors, set the nameplate data for 230 V/50 Hz. Adapt <i>4-13 Motor Speed High Limit [RPM]</i> and <i>3-03 Maximum Reference</i> to the 87 Hz application.

1-24 Motor Current		
Range:		Function:
7.20 A*	[0.10 - 10000.00 A]	Enter the nominal motor current value from the motor nameplate data. The data are used for calculating torque, motor protection etc.

1-25 Motor Nominal Speed		
Range:		Function:
1420. RPM*	[10 - 60000 RPM]	Enter the nominal motor speed value from the motor nameplate data. The data are used for calculating motor compensations. $n_{m,n} = n_s - n_{slip}$.

1-26 Motor Cont. Rated Torque		
Range:		Function:
0 Nm*	[0.1 - 10000.0 Nm]	Enter the value from the motor nameplate data. The default value corresponds to the nominal rated output. This parameter is available when <i>1-10 Motor Construction</i> is set to <i>[1] PM, non salient SPM</i> , i.e. the parameter is valid for PM and non-salient SPM motors only.

1-29 Automatic Motor Adaptation (AMA)		
Option:		Function:
		The AMA function optimises dynamic motor performance by automatically optimising the advanced motor parameters (<i>1-30 Stator Resistance (Rs)</i> to <i>1-35 Main Reactance (Xh)</i>) at motor standstill.

1-29 Automatic Motor Adaptation (AMA)		
Option:		Function:
		Activate the AMA function by pressing [Hand on] after selecting [1] or [2]. See also the section <i>Automatic Motor Adaptation</i> in the Design Guide. After a normal sequence, the display will read: "Press [OK] to finish AMA". After pressing the [OK] key the frequency converter is ready for operation.
[0]	Off	
[1]	Enable complete AMA	Performs AMA of the stator resistance R_s , the rotor resistance R_r , the stator leakage reactance X_1 , the rotor leakage reactance X_2 and the main reactance X_h . Do <i>not</i> select this option if an LC filter is used between the frequency converter and the motor. FC 301: The Complete AMA does not include X_h measurement for FC 301. Instead, the X_h value is determined from the motor database. R_s is the best adjustment method (see <i>1-3* Adv. Motor Data</i>). T4/T5 E and F Frames, T7 D, E and F Frames will only run a Reduced AMA when the complete AMA is selected. It is recommended to obtain the Advanced Motor Data from the motor manufacturer to enter into <i>1-31 Rotor Resistance (Rr)</i> through <i>1-36 Iron Loss Resistance (Rfe)</i> for best performance.
[2]	Enable reduced AMA	Performs a reduced AMA of the stator resistance R_s in the system only.

Note:

- For the best adaptation of the frequency converter, run AMA on a cold motor.
- AMA cannot be performed while the motor is running.
- AMA cannot be performed on permanent magnet motors.

NOTE

This parameter cannot be adjusted while the motor is running.

NOTE

It is important to set motor parameter group *1-2* Motor Data* correctly, since these form part of the AMA algorithm. An AMA must be performed to achieve optimum dynamic motor performance. It may take up to 10 min, depending on the power rating of the motor.

NOTE

Avoid generating external torque during AMA.

NOTE

If one of the settings in parameter group 1-2* Motor Data is changed, 1-30 Stator Resistance (Rs) to 1-39 Motor Poles, the advanced motor parameters, will return to default setting.

NOTE

AMA will work problem-free on 1 motor size down, typically work on 2 motor sizes down, rarely work on 3 sizes down and never work on 4 sizes down. Keep in mind that the accuracy of the measured motor data will be poorer when operating on motors smaller than nominal frequency converter size.

3.3.4 1-3* Adv. Motor Data

Parameters for advanced motor data. The motor data in 1-30 Stator Resistance (Rs) to 1-39 Motor Poles must match the relevant motor in order to run the motor optimally. The default settings are figures based on common motor parameter values from standard motors. If the motor parameters are not set correctly, a malfunction of the frequency converter system may occur. If the motor data is not known, running an AMA (Automatic Motor Adaptation) is recommended. See the Automatic Motor Adaptation section in the Design Guide. The AMA sequence will adjust all motor parameters except the moment of inertia of the rotor and the iron loss resistance (1-36 Iron Loss Resistance (Rfe)).

Parameter groups 1-3* and 1-4* cannot be adjusted while the motor is running.

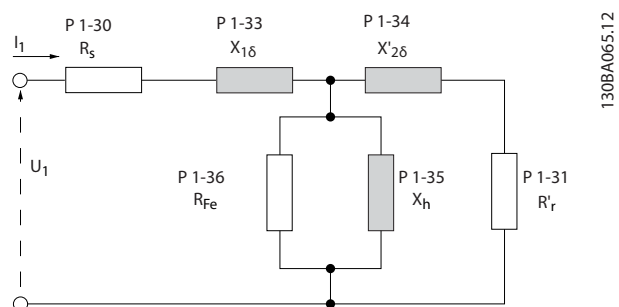

Illustration 3.6 Motor equivalent diagram for an asynchronous motor

NOTE

A simple check of the $X_1 + X_h$ sum value is to divide the line to line motor voltage by the $\sqrt{3}$ and divide this value by the motor no load current. $[V_L - L / \sqrt{3}] / I_{NL} = X_1 + X_h$. These values are important to properly magnetize the motor. For high pole motors it is highly recommended to perform this check.

1-30 Stator Resistance (Rs)		
Range:		Function:
1.4000 Ohm*	[0.0140 - 140.0000 Ohm]	Set the stator resistance value. Enter the value from a motor data sheet or perform an AMA on a cold motor.

1-31 Rotor Resistance (Rr)		
Range:		Function:
1.0000 Ohm*	[0.0100 - 100.0000 Ohm]	Fine-tuning R_r will improve shaft performance. Set the rotor resistance value using one of these methods: <ol style="list-style-type: none"> Run an AMA on a cold motor. The frequency converter will measure the value from the motor. All compensations are reset to 100%. Enter the R_r value manually. Obtain the value from the motor supplier. Use the R_r default setting. The frequency converter establishes the setting on the basis of the motor nameplate data.

NOTE

1-31 Rotor Resistance (Rr) will not have effect when 1-10 Motor Construction = [1] PM, non salient SPM.

1-33 Stator Leakage Reactance (X1)		
Range:		Function:
4.0000 Ohm*	[0.0400 - 400.0000 Ohm]	Set the stator leakage reactance of the motor using one of these methods: <ol style="list-style-type: none"> Run an AMA on a cold motor. The frequency converter will measure the value from the motor. Enter the X_1 value manually. Obtain the value from the motor supplier. Use the X_1 default setting. The frequency converter establishes the setting on the basis of the motor name plate data.

See Illustration 3.6.

NOTE

1-33 Stator Leakage Reactance (X1) will not have effect when 1-10 Motor Construction = [1] PM, non salient SPM.

1-34 Rotor Leakage Reactance (X ₂)		
Range:		Function:
4.0000 Ohm*	[0.0400 - 400.0000 Ohm]	Set the rotor leakage reactance of the motor using one of these methods: <ol style="list-style-type: none"> 1. Run an AMA on a cold motor. The frequency converter will measure the value from the motor. 2. Enter the X₂ value manually. Obtain the value from the motor supplier. 3. Use the X₂ default setting. The frequency converter establishes the setting on the basis of the motor name plate data. See <i>Illustration 3.6</i> .

NOTE

1-34 Rotor Leakage Reactance (X₂) will not have effect when 1-10 Motor Construction = [1] PM, non salient SPM.

1-37 d-axis Inductance (L _d)		
Range:		Function:
0 mH*	[0 - 0 mH]	Enter the value of the d-axis inductance. Obtain the value from the permanent magnet motor data sheet. This parameter is only active when <i>1-10 Motor Construction</i> has the value [1] PM, non-salient SPM (Permanent Magnet Motor). For a selection with one decimal, use this parameter. For a selection with three decimals, use <i>30-80 d-axis Inductance (L_d)</i> . FC 302 only.

1-38 q-axis Inductance (L _q)		
Range:		Function:
Size related*	[0.000 - 1000 mH]	Set the value of the q-axis inductance. See a motor data sheet.

1-35 Main Reactance (X _h)		
Range:		Function:
100.0000 Ohm*	[1.0000 - 10000.0000 Ohm]	Set the main reactance of the motor using one of these methods: <ol style="list-style-type: none"> 1. Run an AMA on a cold motor. The frequency converter will measure the value from the motor. 2. Enter the X_h value manually. Obtain the value from the motor supplier. 3. Use the X_h default setting. The frequency converter establishes the setting on the basis of the motor name plate data.

1-36 Iron Loss Resistance (R _{fe})		
Range:		Function:
10000.000 Ohm*	[0 - 10000.000 Ohm]	Enter the equivalent iron loss resistance (R _{Fe}) value to compensate for iron loss in the motor. The R _{Fe} value cannot be found by performing an AMA. The R _{Fe} value is especially important in torque control applications. If R _{Fe} is unknown, leave <i>1-36 Iron Loss Resistance (R_{fe})</i> on default setting.

1-39 Motor Poles		
Range:		Function:
4. N/A*	[2 - 100 N/A]	Enter the number of motor poles.

Poles	~n _n @ 50Hz	~n _n @60Hz
2	2700-2880	3250-3460
4	1350-1450	1625-1730
6	700-960	840-1153

Table 3.4

The table shows the number of poles for normal speed ranges of various motor types. Define motors designed for other frequencies separately. The motor pole value is always an even number, because it refers to the total number of poles, not pairs of poles. The frequency converter creates the initial setting of *1-39 Motor Poles* based on *1-23 Motor Frequency* and *1-25 Motor Nominal Speed*.

1-40 Back EMF at 1000 RPM		
Range:		Function:
500. V*	[10. - 9000 V]	Set the nominal back EMF for the motor when running at 1000 RPM. This parameter is only active when <i>1-10 Motor Construction</i> is set to [1] PM motor (Permanent Magnet Motor). FC 302 only.
<p>NOTE When using PM motors, it is recommended to use brake resistors.</p>		

1-41 Motor Angle Offset		
Range:		Function:
0 N/A*	[-32768 - 32767 N/A]	Enter the correct offset angle between the PM motor and the index position (single-turn) of the attached encoder or resolver. The value range of 0 - 32768 corresponds to 0 - 2 * pi (radians). To obtain the offset angle value: After frequency converter start-up apply DC-hold and enter the value of <i>16-20 Motor Angle</i> into this parameter. This parameter is only active when <i>1-10 Motor Construction</i> is set to [1] PM, non-salient SPM (Permanent Magnet Motor).

1-46 Position Detection Gain		
Range:		Function:
100 %*	[20 - 200 %]	Adjusts the amplitude of the test pulse during position detection at start. Adjust this parameter to improve the position measurement.

1-47 Low Speed Torque Calibration

This parameter is used to optimize the torque estimate at low speed. When running open loop flux at low speed the estimated torque is based on shaft power, $P_{\text{shaft}} = P_m - R_s \cdot I^2$. This means that it is important to have the correct R_s . The R_s in this formula must be equal to the loss in both motor, cable and frequency converter. Sometimes it is not possible to adjust *1-30 Stator Resistance (Rs)* on each frequency converter to compensate for cable length, frequency converter losses and temperature deviation on motor. Therefore the frequency converter must be able to calculate R_s when starting.

The parameter is only active when running PM motor in Flux Open Loop.

Option:	Function:	
[0]	Off	
[1]	1st start after pwr-up	Calibrates at the first start-up after power up and keeps this value until reset by a power cycle.
[2]	Every start	Calibrates at every start-up, compensating for a possible change in motor temperature since last start-up.

3.3.5 1-5* Load Indep. Setting

1-50 Motor Magnetisation at Zero Speed

Range:		Function:
100 %*	[0 - 300 %]	Use this parameter along with <i>1-51 Min Speed Normal Magnetising [RPM]</i> to obtain a different thermal load on the motor when running at low speed. Enter a value which is a percentage of the rated magnetizing current. If the setting is too low, the torque on the motor shaft may be reduced.
<p>Illustration 3.7</p>		

NOTE

1-50 Motor Magnetisation at Zero Speed will not have effect when *1-10 Motor Construction* = [1] PM, non salient SPM.

1-51 Min Speed Normal Magnetising [RPM]		
Range:	Function:	
Size related* [10 - 300 RPM]	Set the required speed for normal magnetising current. If the speed is set lower than the motor slip speed, <i>1-50 Motor Magnetisation at Zero Speed</i> and <i>1-51 Min Speed Normal Magnetising [RPM]</i> are of no significance. Use this parameter along with <i>1-50 Motor Magnetisation at Zero Speed</i> . See Table 3.4.	

NOTE

1-51 Min Speed Normal Magnetising [RPM] will not have effect when *1-10 Motor Construction* = [1] PM, non salient SPM.

1-52 Min Speed Normal Magnetising [Hz]		
Range:	Function:	
12.5 Hz* [0 - 250.0 Hz]	Set the required frequency for normal magnetising current. If the frequency is set lower than the motor slip frequency, <i>1-50 Motor Magnetisation at Zero Speed</i> is inactive. Use this parameter along with <i>1-50 Motor Magnetisation at Zero Speed</i> . See drawing for <i>1-50 Motor Magnetisation at Zero Speed</i> .	

1-53 Model Shift Frequency		
Range:	Function:	
0 Hz* [4.0 - 0 Hz]	<p>Flux Model shift</p> <p>Enter the frequency value for shift between two models for determining motor speed. Choose the value based on settings in <i>1-00 Configuration Mode</i> and <i>1-01 Motor Control Principle</i>. There are two options: shift between Flux model 1 and Flux model 2; or shift between Variable Current mode and Flux model 2.FC 302 only. This parameter cannot be adjusted while the motor is running.</p> <p>Flux Model 1 – Flux model 2</p> <p>This model is used when <i>1-00 Configuration Mode</i> is set to <i>Speed closed loop</i> [1] or <i>Torque</i> [2] and <i>1-01 Motor Control Principle</i> is set to <i>Flux w/motor feedback</i> [3]. With this parameter it is possible to make an adjustment of the shifting point where FC 302 changes between Flux model 1 and Flux model 2, which is useful in some sensitive speed and torque control applications.</p>	

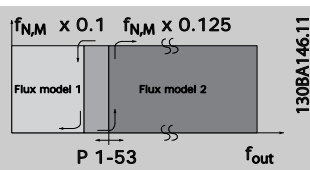
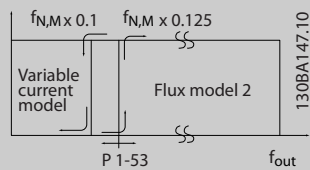
1-53 Model Shift Frequency		
Range:	Function:	
	 <p>Illustration 3.8 <i>1-00 Configuration Mode</i> = [1] <i>Speed closed loop</i> or [2] <i>Torque</i> and <i>1-01 Motor Control Principle</i> = [3] <i>Flux w/motor feedback</i></p> <p>Variable Current - Flux model - Sensorless</p> <p>This model is used when <i>1-00 Configuration Mode</i> is set to <i>Speed open loop</i> [0] and <i>1-01 Motor Control Principle</i> is set to <i>Flux sensorless</i> [2]. In speed open loop in flux mode, the speed is determined from the current measurement. Below $f_{norm} \times 0.1$, the frequency converter runs on a Variable Current model. Above $f_{norm} \times 0.125$ the frequency converter runs on a Flux model.</p>  <p>Illustration 3.9 <i>1-00 Configuration Mode</i> = [0] <i>Speed open loop</i>, <i>1-01 Motor Control Principle</i> = [2] <i>Flux sensorless</i></p>	

1-54 Voltage reduction in fieldweakening		
Range:	Function:	
0 V* [0 - 100 V]	The value of this parameter will reduce the maximal voltage available for the flux of the motor in fieldweakening, giving more voltage available for torque. Be aware that too high value may give stall problems at high speed.	

1-55 U/f Characteristic - U		
Range:	Function:	
0 V* [0.0 - 1000.0 V]	Enter the voltage at each frequency point to manually form a U/f characteristic matching the motor. The frequency points are defined in 1-56 U/f Characteristic - F. This parameter is an array parameter [0-5] and is only accessible when 1-01 Motor Control Principle is set to [0] U/f.	

1-56 U/f Characteristic - F		
Range:	Function:	
0 Hz* [0 - 1000.0 Hz]	Enter the frequency points to manually form a U/f-characteristic matching the motor. The voltage at each point is defined in 1-55 U/f Characteristic - U. This parameter is an array parameter [0-5] and is only accessible when 1-01 Motor Control Principle is set to [0] U/f.	

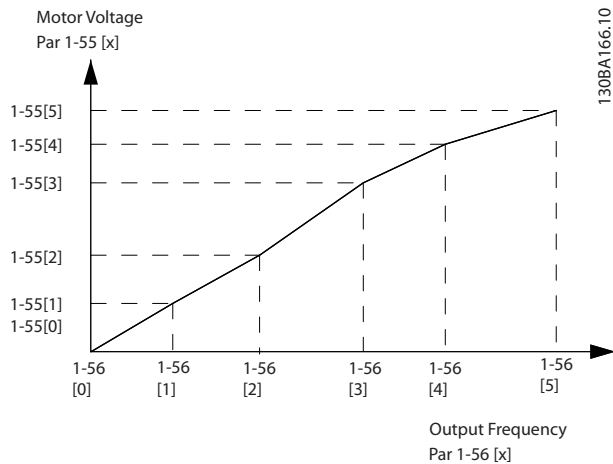

Illustration 3.10

1-58 Flystart Test Pulses Current		
Range:	Function:	
Size related* [0 - 0 %]	Sets the current level for the flystart test pulses that are used to detect the motor direction. 100% means $I_{m,n}$. Adjust the value to be big enough to avoid noise influence but low enough to avoid affecting the accuracy (current must be able to drop to zero before the next pulse). Reduce the value to reduce the generated torque. Default is 30% for asynchronous motors, but may vary for PM motors. For PM motors adjusting the value will tune for back EMF and d-axis inductance of the motor. This parameter is only available in VVC ^{plus} .	

1-59 Flystart Test Pulses Frequency		
Range:	Function:	
Size related* [0 - 0 %]	Sets the frequency of the flystart test pulses that are used to detect the motor direction. 100% means means 2 x fslip. Increase this value to reduce the generated torque. For PM motors this value is the percentage $n_{m,n}$ of the free running PM motor. Above this value flystart is always performed. Below this value, the start mode is selected in 1-70 PM Start Mode This parameter is only available in VVC ^{plus} .	

3.3.6 1-6* Load Depend. Setting

1-60 Low Speed Load Compensation		
Range:	Function:	
100 %* [0 - 300 %]	Enter the % value to compensate voltage in relation to load when the motor is running at low speed and obtain the optimum U/f characteristic. The motor size determines the frequency range within which this parameter is active.	

Motor size	Change over
0.25 kW - 7.5 kW	< 10 Hz

Table 3.5

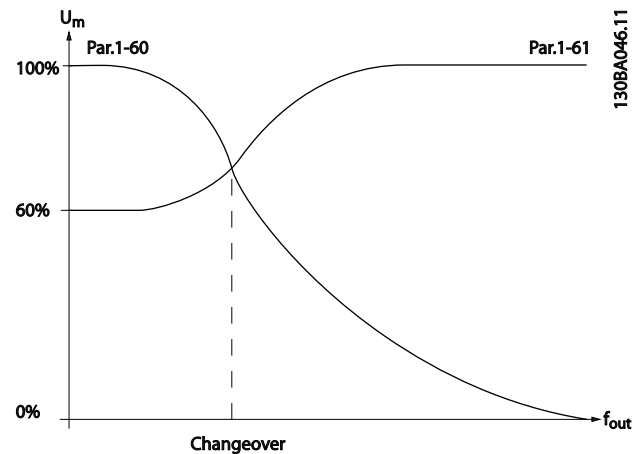

Illustration 3.11

1-61 High Speed Load Compensation		
Range:	Function:	
100 %* [0 - 300 %]	Enter the % value to compensate voltage in relation to load when the motor is running at high speed and obtain the optimum U/f characteristic. The motor size determines the frequency range within which this parameter is active.	

Motor size	Change-over
0.25 kW - 7.5 kW	> 10 Hz

Table 3.6

1-62 Slip Compensation		
Range:	Function:	
100. %*	[-500 - 500 %]	Enter the % value for slip compensation, to compensate for tolerances in the value of $n_{M,N}$. Slip compensation is calculated automatically, i.e. on the basis of the rated motor speed $n_{M,N}$. This function is not active when <i>1-00 Configuration Mode</i> is set to [1] <i>Speed closed loop</i> or [2] <i>Torque Torque control with speed feedback</i> or when <i>1-01 Motor Control Principle</i> is set to [0] <i>U/f special motor mode</i> .

1-63 Slip Compensation Time Constant		
Range:	Function:	
Size related*	[0.05 - 5.00 s]	Enter the slip compensation reaction speed. A high value results in slow reaction, and a low value results in quick reaction. If low-frequency resonance problems arise, use a longer time setting.

NOTE

1-63 Slip Compensation Time Constant will not have effect when 1-10 Motor Construction = [1] PM, non salient SPM.

1-64 Resonance Dampening		
Range:	Function:	
100 %*	[0 - 500 %]	Enter the resonance dampening value. Set <i>1-64 Resonance Dampening</i> and <i>1-65 Resonance Dampening Time Constant</i> to help eliminate high-frequency resonance problems. To reduce resonance oscillation, increase the value of <i>1-64 Resonance Dampening</i> .

NOTE

1-64 Resonance Dampening will not have effect when 1-10 Motor Construction = [1] PM, non salient SPM.

1-65 Resonance Dampening Time Constant		
Range:	Function:	
5 ms*	[5 - 50 ms]	Set <i>1-64 Resonance Dampening</i> and <i>1-65 Resonance Dampening Time Constant</i> to help eliminate high-frequency resonance problems. Enter the time constant that provides the best dampening.

NOTE

1-65 Resonance Dampening Time Constant will not have effect when 1-10 Motor Construction = [1] PM, non salient SPM.

1-66 Min. Current at Low Speed		
Range:	Function:	
100 %*	[1. - 200. %]	Enter the minimum motor current at low speed, see <i>1-53 Model Shift Frequency</i> . Increasing this current improves motor torque at low speed. <i>1-66 Min. Current at Low Speed</i> is enabled when <i>1-00 Configuration Mode [0] Speed open loop</i> only. The frequency converter runs with constant current through motor for speeds below 10æHz. For speeds above 10æHz, the motor flux model in the frequency converter controls the motor. <i>4-16 Torque Limit Motor Mode</i> and <i>æ/æor</i> <i>4-17 Torque Limit Generator Mode</i> automatically adjust <i>1-66 Min. Current at Low Speed</i> . The parameter with the highest value adjusts <i>1-66 Min. Current at Low Speed</i> . The current setting in <i>1-66 Min. Current at Low Speed</i> is composed of the torque generating current and the magnetizing current. Example: Set <i>4-16 Torque Limit Motor Mode</i> to 100% and set <i>4-17 Torque Limit Generator Mode</i> to 60%. <i>1-66 Min. Current at Low Speed</i> automatically adjusts to about 127%, depending on the motor size. FC 302 only.

1-67 Load Type		
Option:	Function:	
[0] *	Passive load	For conveyers, fan and pump applications.
[1]	Active load	For hoisting applications, used in slip compensation at low speed. When <i>Active Load [1]</i> is selected, set <i>1-66 Min. Current at Low Speed</i> to a level which corresponds to maximum torque.

FC 302 only.

1-68 Minimum Inertia		
Range:	Function:	
0.0048 kgm ² *	[0.0001 - par. 1-69 kgm ²]	Needed for average inertia calculation. Enter the minimum moment of inertia of the mechanical system. <i>1-68 Minimum Inertia</i> and <i>1-69 Maximum Inertia</i> are used for pre-adjustment of the Proportional Gain in the speed control, see <i>30-83 Speed PID Proportional Gain</i> . FC 302 only.

NOTE

This parameter cannot be adjusted while motor is running.

1-69 Maximum Inertia		
Range:		Function:
0.0048 kgm ² *	[par. 1-68 - 0.4800 kgm ²]	Active in Flux Open Loop only. Used to compute the acceleration torque at low speed. Used in the torque limit controller. FC 302 only.

NOTE

This parameter cannot be adjusted while motor is running.

3.3.7 1-7* Start Adjustments

1-70 PM Start Mode		
Select the PM motor start-up mode. This is done to initialize the VVC ^{plus} control core for previously free running PM motor. Both selections will estimate the speed and angle. Active for PM motors in VVC ^{plus} only.		
Option:		Function:
[0]	Rotor Detection	Estimates the electrical angle of the rotor and uses this as a starting point. Standard selection for AutomationDrive applications.
[1]	Parking	The Parking function applies DC current across the stator winding and rotates the rotor to electrical zero position (typically selected for HVAC applications).

1-71 Start Delay		
Range:		Function:
0.0 s*	[0.0 - 10.0 s]	This parameter refers to the start function selected in 1-72 Start Function. Enter the time delay required before commencing acceleration.

1-72 Start Function		
Option:		Function:
		Select the start function during start delay. This parameter is linked to 1-71 Start Delay.
[0]	DC Hold/delay time	Energizes motor with a DC holding current (2-00 DC Hold Current) during the start delay time.
[1]	DC Brake/delay time	Energizes motor with a DC braking current (2-01 DC Brake Current) during the start delay time.
[2]	Coast/delay time *	Motor coasted during the start delay time (inverter off).
[3]	Start speed cw	Only possible with VVC ^{plus} .

1-72 Start Function		
Option:		Function:
		Connect the function described in 1-74 Start Speed [RPM] and 1-76 Start Current in the start delay time. Regardless of the value applied by the reference signal, the output speed applies the setting of the start speed in 1-74 Start Speed [RPM] or 1-75 Start Speed [Hz] and the output current corresponds to the setting of the start current in 1-76 Start Current. This function is typically used in hoisting applications without counterweight and especially in applications with a Cone-motor, where the start is clockwise, followed by rotation in the reference direction.
[4]	Horizontal operation	Only possible with VVC ^{plus} . For obtaining the function described in 1-74 Start Speed [RPM] and 1-76 Start Current during the start delay time. The motor rotates in the reference direction. If the reference signal equals zero (0), 1-74 Start Speed [RPM] is ignored and the output speed equals zero (0). The output current corresponds to the setting of the start current in 1-76 Start Current.
[5]	VVC+/Flux clockwise	for the function described in 1-74 Start Speed [RPM] only. The start current is calculated automatically. This function uses the start speed in the start delay time only. Regardless of the value set by the reference signal, the output speed equals the setting of the start speed in 1-74 Start Speed [RPM]. Start speed/current clockwise [3] and VVC ^{plus} /Flux clockwise [5] are typically used in hoisting applications. Start speed/current in reference direction [4] is particularly used in applications with counterweight and horizontal movement.
[6]	Hoist Mech. Brake Rel	For utilizing mechanical brake control functions, 2-24 Stop Delay to 2-28 Gain Boost Factor. This parameter is only active when 1-01 Motor Control Principle is set to [3] Flux w/ motor feedback (FC 302 only).

1-73 Flying Start		
Option:		Function:
		This function makes it possible to catch a motor which is spinning freely due to a mains drop-out.
[0] *	Disabled	No function
[1]	Enabled	Enables the frequency converter to "catch" and control a spinning motor. When 1-73 Flying Start is enabled, 1-71 Start Delay and 1-72 Start Function have no function.

NOTE

This parameter cannot be adjusted while motor is running.

NOTE

This function is not recommended for hoisting applications.

For power levels above 55 kW, flux mode must be used to achieve the best performance.

NOTE

To obtain the best flying start performance the advanced motor data, 1-30 Stator Resistance (Rs) through 1-35 Main Reactance (Xh), must be correct.

1-74 Start Speed [RPM]		
Range:	Function:	
0 RPM*	[0 - 600 RPM]	Set a motor start speed. After the start signal, the output speed leaps to set value. Set the start function in 1-72 Start Function to [3], [4] or [5], and set a start delay time in 1-71 Start Delay.

1-75 Start Speed [Hz]		
Range:	Function:	
0 Hz*	[0.0 - 500.0 Hz]	This parameter can be used for hoist applications (cone rotor). Set a motor start speed. After the start signal, the output speed leaps to set value. Set the start function in 1-72 Start Function to [3], [4] or [5], and set a start delay time in 1-71 Start Delay.

1-76 Start Current		
Range:	Function:	
0.00 A*	[0.00 - par. 1-24 A]	Some motors, e.g. cone rotor motors, need extra current/starting speed to disengage the rotor. To obtain this boost, set the required current in 1-76 Start Current. Set 1-74 Start Speed [RPM]. Set 1-72 Start Function to [3] or [4], and set a start delay time in 1-71 Start Delay. This parameter can be used for hoist applications (cone rotor).

3.3.8 1-8* Stop Adjustments

1-80 Function at Stop		
Option:	Function:	
		Select the frequency converter function after a stop command or after the speed is ramped down to the settings in 1-81 Min Speed for Function at Stop [RPM].

1-80 Function at Stop		
Option:	Function:	
[0] *	Coast	Leaves motor in free mode. The motor is disconnected from the frequency converter.
[1]	DC hold	Energizes motor with a DC holding current (see 2-00 DC Hold Current).
[2]	Motor check	Checks if a motor has been connected.
[3]	Pre-magnetizing	Builds up a magnetic field while the motor is stopped. This allows the motor to produce torque quickly at subsequent start commands (asynchronous motors only). This Pre-magnetizing function does not help the very first start command. Two different solutions are available to pre-magnetize the machine for the first start command: <ol style="list-style-type: none"> 1. Start the frequency converter with a 0 RPM reference and wait 2 to 4 rotor time constants (see below) before increasing the speed reference. <ol style="list-style-type: none"> 2a. Set 1-71 Start Delay to the desired pre-mag time (2 to 4 rotor time constants - see below). 2b. Set 1-72 Start Function to either [0] DC-hold or [1] DC-Brake. Set the DC-hold or DC-brake current magnitude (2-00 DC Hold Current or 2-01 DC Brake Current) to be equal to $I_{pre-mag} = U_{nom} / (1.73 \times X_h)$ Sample rotor time constants = $(X_h + X_2) / (6.3 \times \text{Freq}_{nom} \times R_r)$ 1 kW = 0.2 s 10 kW = 0.5 s 100 kW = 1.7 s 1000 kW = 2.5 s
[4]	DC Voltage U0	When the motor is stopped, the 1-55 U/f Characteristic - U [0] parameter defines the voltage at 0 Hz.

1-81 Min Speed for Function at Stop [RPM]		
Range:	Function:	
Size related*	[0 - 600 RPM]	Set the speed at which to activate 1-80 Function at Stop.

1-82 Min Speed for Function at Stop [Hz]		
Range:	Function:	
Size related*	[0.0 - 20.0 Hz]	Set the output frequency at which to activate 1-80 Function at Stop.

1-83 Precise Stop Function		
FC 302 only.		
Option:	Function:	
[0] *	Precise ramp stop	Only optimal when the operational speed - of e.g. the conveyor belt - is constant. This is an open loop control. Achieves high repetitive precision at the stopping point.
[1]	Cnt stop with reset	Counts the number of pulses, typically from an encoder and generates a stop signal after a pre-programmed number of pulses - <i>1-84 Precise Stop Counter Value</i> - has been received at T29 or T33 [30]. This is a direct feedback with one-way closed loop control. The counter function is activated (starts timing) at the edge of the start signal (when it changes from stop to start). After each precise stop the number of pulses counted during ramp down to 0 RPM is reset.
[2]	Cnt stop w/o reset	Same as [1] but the number of pulses counted during ramp down to 0 rpm is deducted from the counter value entered in <i>1-84 Precise Stop Counter Value</i> . This reset function can for example be used to compensate for the extra distance done during ramping down and to reduce the impacts of gradual wear of mechanical parts.
[3]	Speed comp stop	Stops at precisely the same point, regardless of the present speed, the stop signal is delayed internally when the present speed is lower than the maximum speed (set in <i>4-19 Max Output Frequency</i>). The delay is calculated on the basis of the reference speed of the frequency converter and not on the basis of the actual speed. Please therefore make sure that the frequency converter has ramped up before you activate the speed compensated stop.
[4]	Com cnt stop w/rst	Same as [3] but after each precise stop the number of pulses counted during ramp down to 0 rpm is reset.
[5]	Comp cnt stop w/o r	Same as [3] but the number of pulses counted during ramp down to 0 rpm is deducted from the counter value entered in <i>1-84 Precise Stop Counter Value</i> . This reset function can for example be used to compensate for the extra distance done during ramping down and to reduce the impacts of gradual wear of mechanical parts.

The Precise Stop Functions are advantageous in applications where high precision is required. If you use a standard stop command the accuracy is determined by the internal task time. That is not the case

when using the precise stop function; it eliminates the task time dependence and increases the accuracy substantially. The frequency converter tolerance is normally given by its task time. However, by using its special precise stop function the tolerance is independent of the task time because the stop signal immediately interrupts the execution of the frequency converter program. The precise stop function gives a highly reproducible delay from the stop signal is given until the ramping down starts. A test must be done to find this delay as it is a sum of sensor, PLC, frequency converter and mechanical parts. To ensure optimum accuracy there should be at least 10 cycles during ramping down, see *3-42 Ramp 1 Ramp Down Time*, *3-52 Ramp 2 Ramp down Time*, *3-62 Ramp 3 Ramp down Time* and *3-72 Ramp 4 Ramp Down Time*. The Precise Stop Function is set up here and enabled from DI T29 or T33.

NOTE

This parameter cannot be adjusted while the motor is running.

1-84 Precise Stop Counter Value		
Range:	Function:	
100000 N/A*	[0 - 999999999 N/A]	Enter the counter value to be used in the integrated precise stop function, <i>1-83 Precise Stop Function</i> . The maximum permissible frequency at terminal 29 or 33 is 110 kHz. Not used for selection [0] and [3] in <i>1-83 Precise Stop Function</i>

1-85 Precise Stop Speed Compensation Delay		
Range:	Function:	
10 ms*	[0 - 100 ms]	Enter the delay time for sensors, PLCs, etc. for use in <i>1-83 Precise Stop Function</i> . In speed compensated stop mode, the delay time at different frequencies has a major influence on the stop function. Not used for selection [0], [1] and [2] in <i>1-83 Precise Stop Function</i>

3.3.9 1-9* Motor Temperature

1-90 Motor Thermal Protection		
Option:	Function:	
		Thermal motor protection can be implemented using a range of techniques:

1-90 Motor Thermal Protection		
Option:	Function:	
		<ul style="list-style-type: none"> Via a PTC sensor in the motor windings connected to one of the analog or digital inputs (1-93 Thermistor Source). See 3.3.10.1 PTC Thermistor Connection. Via a KTY sensor in the motor winding connected to an analog input (1-96 KTY Thermistor Resource). See 3.3.10.2 KTY Sensor Connection. Via calculation (ETR = Electronic Thermal Relay) of the thermal load, based on the actual load and time. The calculated thermal load is compared with the rated motor current $I_{M,N}$ and the rated motor frequency $f_{M,N}$. See 3.3.10.3 ETR and 3.3.10.4 ATEX ETR. Via a mechanical thermal switch (Klixon type). See 3.3.10.5 Klixon. <p>For the North American market: The ETR functions provide class 20 motor overload protection in accordance with NEC.</p>
[0] *	No protection	Continuously overloaded motor, when no warning or trip of the frequency converter is required.
[1]	Thermistor warning	Activates a warning when the connected thermistor or KTY-sensor in the motor reacts in the event of motor over-temperature.
[2]	Thermistor trip	Stops (trips) frequency converter when connected thermistor or KTY sensor in the motor reacts in the event of motor over-temperature. The thermistor cut-out value must be > 3 kΩ. Integrate a thermistor (PTC sensor) in the motor for winding protection.
[3]	ETR warning 1	Calculates the load when set-up 1 is active and activates a warning on the display when the motor is overloaded. Programme a warning signal via one of the digital outputs.
[4]	ETR trip 1	Calculates the load when set-up 1 is active and stops (trips) frequency converter when the motor is overloaded. Programme a warning signal via one of the digital outputs. The signal appears in the event of a warning and if the frequency converter trips (thermal warning).
[5]	ETR warning 2	
[6]	ETR trip 2	

1-90 Motor Thermal Protection		
Option:	Function:	
[7]	ETR warning 3	
[8]	ETR trip 3	
[9]	ETR warning 4	
[10]	ETR trip 4	

NOTE

If [20] is selected, follow strictly the instructions described in the dedicated chapter of the VLT® AutomationDrive design guide and the instructions given by the motor manufacturer.

NOTE

If [20] is selected, 4-18 Current Limit must be set to 150%.

3.3.10.1 PTC Thermistor Connection

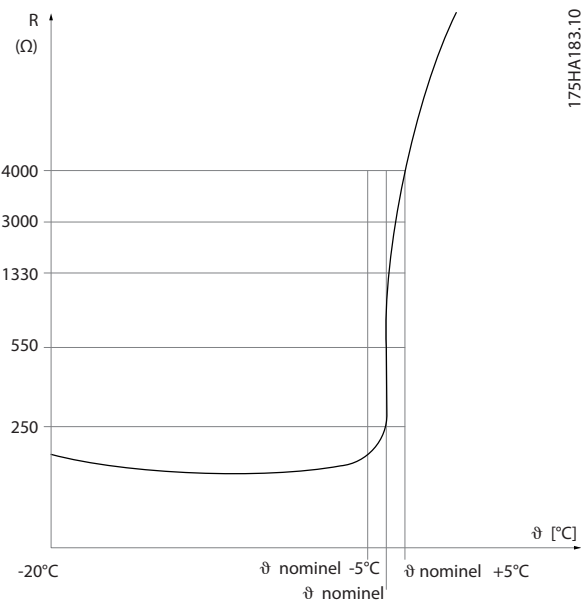

Illustration 3.12 PTC Profile

Using a digital input and 10 V as power supply:
Example: The frequency converter trips when the motor temperature is too high.

Parameter set-up:

- Set 1-90 Motor Thermal Protection to [2] Thermistor Trip
- Set 1-93 Thermistor Source to [6] Digital Input

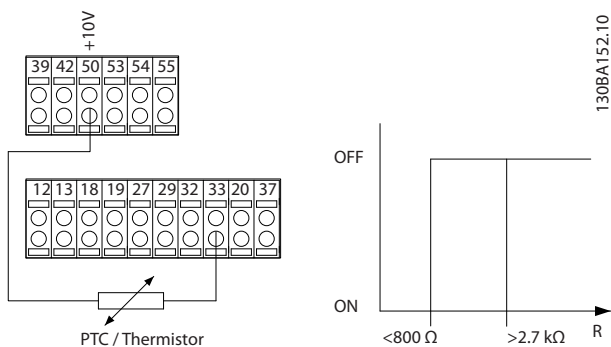

Illustration 3.13

Using an analog input and 10 V as power supply:
 Example: The frequency converter trips when the motor temperature is too high.
 Parameter set-up:
 Set 1-90 Motor Thermal Protection to [2] Thermistor Trip
 Set 1-93 Thermistor Source to [2] Analog Input 54

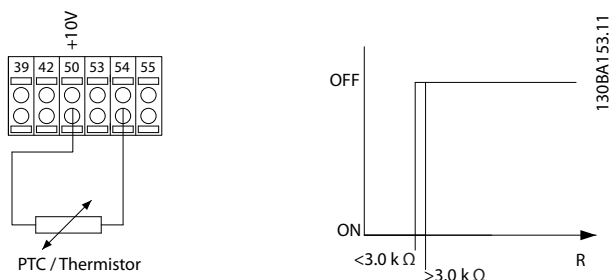

Illustration 3.14

Input	Supply Voltage	Threshold Cut-out Values
Digital/analog	10 V	800Ω - $2.7 \text{ k}\Omega$
Analog	10 V	$3.0 \text{ k}\Omega$ - $3.0 \text{ k}\Omega$

Table 3.7

NOTE

Check that the chosen supply voltage follows the specification of the used thermistor element.

3.3.10.2 KTY Sensor Connection

(FC 302 only)

KTY sensors are used especially in Permanent Magnet Servo Motors (PM motors) for dynamic adjusting of motor parameters as stator resistance (1-30 Stator Resistance (Rs)) for PM motors and also rotor resistance (1-31 Rotor Resistance (Rr)) for asynchronous motors, depending on winding temperature. The calculation is:

$$R_s = R_{s20} \cdot C \cdot (1 + \alpha_{cu} \cdot \Delta T) [\Omega] \text{ where } \alpha_{cu} = 0.00393$$

KTY sensors can be used for motor protecting (1-97 KTY Threshold level).

FC 302 can handle three types of KTY sensors, defined in 1-95 KTY Sensor Type. The actual sensor temperature can be read out from 16-19 KTY sensor temperature.

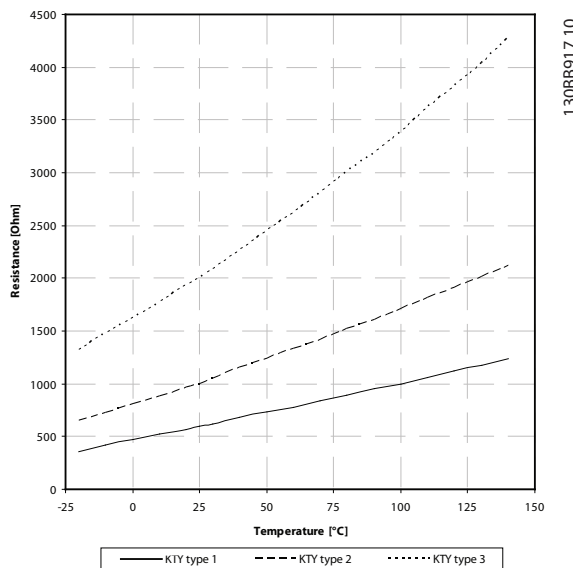

Illustration 3.15 KTY Type Selection

- KTY Sensor 1: 1 kΩ at 100 °C (e.g. Philips KTY 84-1)
- KTY Sensor 2: 1 kΩ at 25 °C (e.g. Philips KTY 83-1)
- KTY Sensor 3: 2 kΩ at 25 °C (e.g. Infineon KTY-10)

NOTE

If the temperature of the motor is utilized through a thermistor or KTY sensor the PELV is not complied with in case of short circuits between motor windings and sensor. In order to comply with PELV the sensor must be extra isolated.

3.3.10.3 ETR

The calculations estimate the need for a lower load at lower speed due to less cooling from the fan incorporated in the motor.

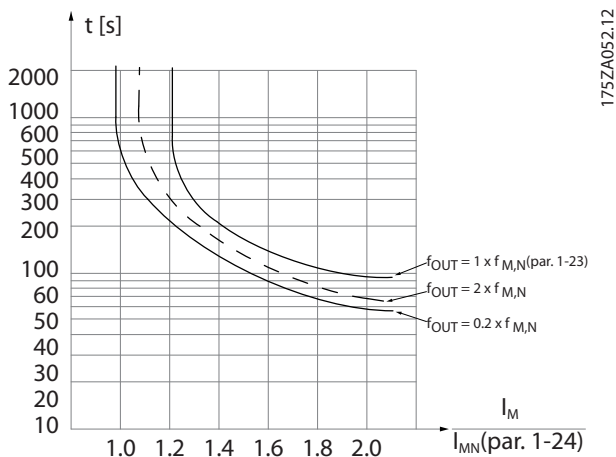

Illustration 3.16 ETR Profile

3.3.10.4 ATEX ETR

The B-option MCB 112 PTC Thermistor option offers ATEX approved monitoring of motor temperature. Alternatively, an external ATEX approved PTC protection device can be used.

NOTE

Only ATEX Ex-e approved motors may be used for this function. See motor nameplate, approval certificate, data sheet or contact motor supplier.

When controlling an Ex-e motor with “Increased Safety”, it is important to ensure certain limitations. The parameters that must be programmed are presented in the following application example.

Function	Setting
1-90 Motor Thermal Protection	[20] ATEX ETR
1-94 ATEX ETR cur.lim. speed reduction	20%
1-98 ATEX ETR interpol. points freq.	Motor name plate
1-99 ATEX ETR interpol. points current	
1-23 Motor Frequency	Enter the same value as for 4-19 Max Output Frequency
4-19 Max Output Frequency	Motor name plate, possibly reduced for long motor cables, sinus filter or reduced supply voltage
4-18 Current Limit	Forced to 150% by 1-90 [20]
5-15 Terminal 33 Digital Input	[80] PTC Card 1
5-19 Terminal 37 Safe Stop	[4] PTC 1 Alarm
14-01 Switching Frequency	Check that the default value fulfils the requirement from Motor name plate. If not -use sine wave filter.
14-26 Trip Delay at Inverter Fault	0

Table 3.8 Parameters

CAUTION

It is mandatory to compare the minimum switching frequency requirement stated by the motor manufacturer to the minimum switching frequency of the frequency converter, the default value in 14-01 Switching Frequency. If the frequency converter does not meet this requirement, a sine wave filter must be used.

More information about ATEX ETR Thermal Monitoring can be found in the Application Note MN33G.

3.3.10.5 Klixon

The Klixon type thermal circuit breaker uses a KLIXON® metal dish. At a predetermined overload, the heat caused by the current through the disc causes a trip.

Using a digital input and 24 V as power supply:
Example: The frequency converter trips when the motor temperature is too high

Parameter set-up:

Set 1-90 Motor Thermal Protection to [2] Thermistor Trip

Set 1-93 Thermistor Source to [6] Digital Input

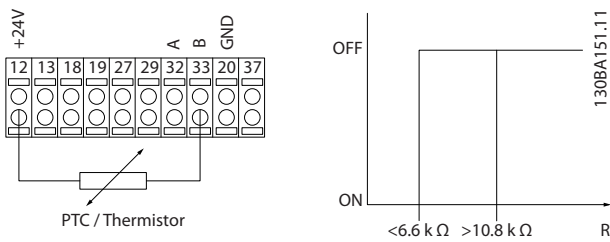

Illustration 3.17

1-91 Motor External Fan		
Option:	Function:	
[0] *	No	No external fan is required, i.e. the motor is derated at low speed.
[1]	Yes	Applies an external motor fan (external ventilation), so no derating of the motor is required at low speed. The upper curve in graph above ($f_{out} = 1 \times f_{M,N}$) is followed if the motor current is lower than nominal motor current (see 1-24 Motor Current). If the motor current exceeds nominal current, the operation time still decreases as if no fan were installed.

1-93 Thermistor Source		
Option:	Function:	
		Select the input to which the thermistor (PTC sensor) should be connected. An analog input option [1] or [2] cannot be selected if the analog input is already in use as a reference source (selected in 3-15 Reference 1 Source, 3-16 Reference 2 Source or 3-17 Reference 3 Source). When using MCB 112, choice [0] None must always be selected.
[0] *	None	
[1]	Analog input 53	
[2]	Analog input 54	
[3]	Digital input 18	
[4]	Digital input 19	
[5]	Digital input 32	
[6]	Digital input 33	

NOTE

This parameter cannot be adjusted while the motor is running.

NOTE

Digital input should be set to [0] PNP - Active at 24 V in 5-00 Digital I/O Mode.

1-94 ATEX ETR cur.lim. speed reduction		
FC 302 only. Only visible if 1-90 Motor Thermal Protection is set to [20].		
Range:	Function:	
0 %*	[0 - 100 %]	

The reaction for operating in Ex-e current limit must be configured.

0%: The frequency converter does not change anything besides issuing warning 163 ATEX ETR cur.lim.warning.

>0%: The frequency converter issuing warning 163 and reduces motor speed following ramp 2 (parameter group 3-5* Ramp 2).

Example:

Actual reference = 50 RPM

1-94 ATEX ETR cur.lim. speed reduction = 20%

Resulting reference = 40 RPM

1-95 KTY Sensor Type		
Option:	Function:	
		Select the used type of KTY sensor. FC 302 only.
[0] *	KTY Sensor 1	1 kΩ at 100 °C
[1]	KTY Sensor 2	1 kΩ at 25 °C
[2]	KTY Sensor 3	2 kΩ at 25 °C

1-96 KTY Thermistor Resource		
Option:	Function:	
		Selecting analog input terminal 54 to be used as KTY sensor input. Terminal 54 cannot be selected as KTY source if otherwise used as reference (see 3-15 Reference Resource 1 to 3-17 Reference Resource 3). FC 302 only.
		NOTE Connection of KTY-sensor between term. 54 and 55 (GND). See Illustration 3.15.
[0] *	None	
[2]	Analog input 54	

1-97 KTY Threshold level		
Range:	Function:	
80 °C*	[-40 - 140 °C]	Select the KTY sensor threshold level for motor thermal protection. FC 302 only.

1-98 ATEX ETR interpol. points freq.		
FC 302 only. Only visible if 1-90 Motor Thermal Protection is set to [20].		
Range:	Function:	
Size related*	[0 - 1000.0 Hz]	

Enter the four frequency points [Hz] from the motor name plate into this array. Together with 1-99 ATEX ETR interpol points current, these make up a table (f [Hz],I [%]).

NOTE

All frequency/current limit points from the motor name plate or motor data sheet must be programmed.

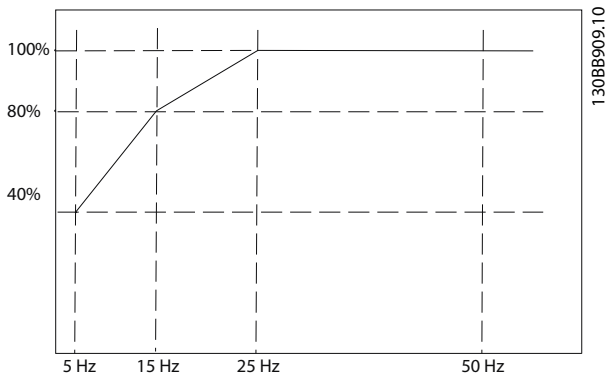

Illustration 3.18 Example of ATEX ETR thermal limitation curve.

x-axis: f_m [Hz]

y-axis: $I_m/I_{m,n} \times 100$ [%]

1-98 ATEX ETR interpol. points freq.	1-99 ATEX ETR interpol points current
[0] = 5 Hz	[0] = 40%
[1] = 15 Hz	[1] = 80%
[2] = 25 Hz	[2] = 100%
[3] = 50 Hz	[3] = 100%

Table 3.9

All operating points underneath the curve are allowed continuously. Above the line, however, only for a limited time calculated as a function of the overload. In the event of a machine current greater than 1.5 times the rated current, shut down is immediate.

1-99 ATEX ETR interpol points current		
FC 302 only. Only visible if 1-90 Motor Thermal Protection is set to [20] or [21].		
Range:	Function:	
Size related*	[0 - 100 %]	Definition of thermal limitation curve. For example, see 1-98 ATEX ETR interpol. points freq.

Use the four current points [A] from the motor name plate. Calculate the values as percentage of nominal motor current, $I_m/I_{m,n} \times 100$ [%], and enter into this array.

Together with 1-98 ATEX ETR interpol. points freq., these make up a table (f [Hz], I [%]).

NOTE

All frequency/current limit points from the motor name plate or motor data sheet must be programmed.

3.4 Parameters: 2-** Brakes

3.4.1 2-0* DC-Brakes

Parameter group for configuring the DC brake and DC hold functions.

2-00 DC Hold Current		
Range:		Function:
50 %*	[0 - 160. %]	Enter a value for holding current as a percentage of the rated motor current $I_{M,N}$ set in 1-24 Motor Current. 100% DC holding current corresponds to $I_{M,N}$. This parameter holds the motor function (holding torque) or pre-heats the motor. This parameter is active if DC hold is selected in 1-72 Start Function [0] or 1-80 Function at Stop [1].

NOTE

The maximum value depends on the rated motor current. Avoid 100 % current for too long. It may damage the motor.

Low values of DC hold will produce larger than expected currents with larger motor power sizes. This error will increase as the motor power increases.

2-01 DC Brake Current		
Range:		Function:
50 %*	[0 - 1000. %]	Enter a value for current as a percentage of the rated motor current $I_{M,N}$, see 1-24 Motor Current. 100% DC braking current corresponds to $I_{M,N}$. DC brake current is applied on a stop command, when the speed is lower than the limit set in 2-03 DC Brake Cut In Speed [RPM]; when the DC Brake Inverse function is active; or via the serial communication port. The braking current is active during the time period set in 2-02 DC Braking Time.

NOTE

The maximum value depends on the rated motor current. Avoid 100 % current for too long. It may damage the motor.

2-02 DC Braking Time		
Range:		Function:
10.0 s*	[0.0 - 60.0 s]	Set the duration of the DC braking current set in 2-01 DC Brake Current, once activated.

2-03 DC Brake Cut In Speed [RPM]		
Range:		Function:
0 RPM*	[0 - par. 4-13 RPM]	Set the DC brake cut-in speed for activation of the DC braking current

2-03 DC Brake Cut In Speed [RPM]		
Range:		Function:
		set in 2-01 DC Brake Current, upon a stop command.

2-04 DC Brake Cut In Speed [Hz]		
Range:		Function:
0.0 Hz*	[0.0 - par. 4-14 Hz]	Set the DC brake cut-in speed for activation of the DC braking current set in 2-01 DC Brake Current, upon a stop command.

NOTE

2-04 DC Brake Cut In Speed [Hz] will not have effect when 1-10 Motor Construction = [1] PM, non salient SPM.

2-06 Parking Current		
Range:		Function:
50 %*	[0 - 1000 %]	Set current as percentage of rated motor current, 1-24 Motor Current. Will be used when enabled in 1-70 PM Start Mode.

2-07 Parking Time		
Range:		Function:
3 s*	[0.1 - 60 s]	Set the duration of the Parking Current set in 2-06 Parking Current, once activated.

3.4.2 2-1* Brake Energy Funct.

Parameter group for selecting dynamic braking parameters. Only valid for frequency converters with brake chopper.

2-10 Brake Function		
Option:		Function:
[0] *	Off	No brake resistor is installed.
[1]	Resistor brake	A brake resistor is incorporated in the system, for dissipation of surplus brake energy as heat. Connecting a brake resistor allows a higher DC link voltage during braking (generating operation). The Resistor brake function is only active in frequency converters with an integral dynamic brake.
[2]	AC brake	Is selected to improve braking without using a brake resistor. This parameter controls an overmagnetization of the motor when running with a generative load. This function can improve the OVC-function. Increasing the electrical losses in the motor allows the OVC function to increase the braking torque without exceeding the over voltage limit. Please note that AC brake is not as effective as dynamic braking with resistor. AC brake is for VVC ^{plus} and flux mode in both open and closed loop.

2-11 Brake Resistor (ohm)		
Range:		Function:
Size related*	[5.00 - 65535.00 Ohm]	Set the brake resistor value in Ohms. This value is used for monitoring the power to the brake resistor in <i>2-13 Brake Power Monitoring</i> . This parameter is only active in frequency converters with an integral dynamic brake. Use this parameter for values without decimals. For a selection with two decimals, use <i>30-81 Brake Resistor (ohm)</i> .

2-12 Brake Power Limit (kW)		
Range:		Function:
Size related*	[0.001 - 2000.000 kW]	<p><i>2-12 Brake Power Limit (kW)</i> is the expected average power dissipated in the brake resistor over a period of 120 s. It is used as the monitoring limit for <i>16-33 Brake Energy /2 min</i> and thereby specifies when a warning/ alarm is to be given.</p> <p>To calculate <i>2-12 Brake Power Limit (kW)</i>, the following formula can be used.</p> $P_{br,avg}[W] = \frac{U_{br}^2[V] \times t_{br}[s]}{R_{br}[\Omega] \times T_{br}[s]}$ <p>$P_{br,avg}$ is the average power dissipated in the brake resistor, R_{br} is the resistance of the brake resistor. t_{br} is the active braking time within the 120 s period, T_{br}. U_{br} is the DC voltage where the brake resistor is active. This depends on the unit as follows:</p> <p>T2 units: 390 V T4 units: 778 V T5 units: 810 V T6 units: 943 V/1099 V for D – F frames T7 units: 1099 V</p> <p>NOTE If R_{br} is not known or if T_{br} is different from 120 s, the practical approach is to run the brake application, readout <i>16-33 Brake Energy /2 min</i> and then enter this + 20% in <i>2-12 Brake Power Limit (kW)</i>.</p>

2-13 Brake Power Monitoring		
Option:		Function:
		This parameter is only active in frequency converters with an integral dynamic brake. This parameter enables monitoring of the power to the brake resistor. The power is calculated on the basis of the resistance

2-13 Brake Power Monitoring		
Option:		Function:
		(<i>2-11 Brake Resistor (ohm)</i>), the DC link voltage, and the resistor duty time.
[0] *	Off	No brake power monitoring required.
[1]	Warning	Activates a warning on the display when the power transmitted over 120 s exceeds 100% of the monitoring limit (<i>2-12 Brake Power Limit (kW)</i>). The warning disappears when the transmitted power falls below 80% of the monitoring limit.
[2]	Trip	Trips frequency converter and displays an alarm when the calculated power exceeds 100% of the monitoring limit.
[3]	Warning and trip	Activates both of the above, including warning, trip and alarm.

If power monitoring is set to [0] Off or [1] Warning, the brake function remains active, even if the monitoring limit is exceeded. This may lead to thermal overload of the resistor. It is also possible to generate a warning via a relay/digital outputs. The measuring accuracy of the power monitoring depends on the accuracy of the resistance of the resistor (better than ±20%).

2-15 Brake Check		
Option:		Function:
		Select type of test and monitoring function to check the connection to the brake resistor, or whether a brake resistor is present, and then display a warning or an alarm in the event of a fault.
		<p>NOTE The brake resistor disconnection function is tested during power-up. However the brake IGBT test is performed when there is no braking. A warning or trip disconnects the brake function.</p> <p>The testing sequence is as follows:</p> <ol style="list-style-type: none"> 1. The DC link ripple amplitude is measured for 300 ms without braking. 2. The DC link ripple amplitude is measured for 300 ms with the brake turned on. 3. If the DC link ripple amplitude while braking is lower than the DC link ripple amplitude before braking + 1%: <i>Brake check has failed by returning a warning or alarm.</i> 4. If the DC link ripple amplitude while braking is higher than the DC link ripple

2-15 Brake Check		
Option:	Function:	
		amplitude before braking + 1%: <i>Brake check is OK.</i>
[0] *	Off	Monitors brake resistor and brake IGBT for a short-circuit during operation. If a short-circuit occurs, warning 25 appears.
[1]	Warning	Monitors brake resistor and brake IGBT for a short-circuit, and runs a test for brake resistor disconnection during power-up.
[2]	Trip	Monitors for a short-circuit or disconnection of the brake resistor, or a short-circuit of the brake IGBT. If a fault occurs, the frequency converter cuts out while displaying an alarm (trip locked).
[3]	Stop and trip	Monitors for a short-circuit or disconnection of the brake resistor, or a short-circuit of the brake IGBT. If a fault occurs, the frequency converter ramps down to coast and then trips. A trip lock alarm is displayed (e.g. warning 25, 27 or 28).
[4]	AC brake	Monitors for a short-circuit or disconnection of the brake resistor, or a short-circuit of the brake IGBT. If a fault occurs, the frequency converter performs a controlled ramp-down. This option is available for FC 302 only.

NOTE

Remove a warning arising in connection with [0] Off or [1] Warning by cycling the mains supply. The fault must be corrected first. For [0] Off or [1] Warning, the frequency converter keeps running even if a fault is located.

This parameter is only active in frequency converters with an integral dynamic brake.

2-16 AC brake Max. Current		
Range:	Function:	
100.0 %*	[0.0 - 1000.0 %]	Enter the maximum permissible current when using AC brake to avoid overheating of motor windings.

NOTE

2-16 AC brake Max. Current will not have effect when 1-10 Motor Construction = [1] PM, non salient SPM.

2-17 Over-voltage Control		
Option:	Function:	
		Over-voltage control (OVC) reduces the risk of the frequency converter tripping due to

2-17 Over-voltage Control		
Option:	Function:	
		an over voltage on the DC link caused by generative power from the load.
[0] *	Disabled	No OVC required.
[1]	Enabled (not at stop)	Activates OVC except when using a stop signal to stop the frequency converter.
[2]	Enabled	Activates OVC.

NOTE

OVC must not be enabled in hoisting applications.

2-18 Brake Check Condition		
Range:	Function:	
[0] *	At Power Up	Brake check will be performed at power up

2-19 Over-voltage Gain		
Range:	Function:	
100 %*	[0 - 200 %]	Select over-voltage gain.

3.4.3 2-2* Mechanical Brake

Parameters for controlling operation of an electro-magnetic (mechanical) brake, typically required in hoisting applications.

To control a mechanical brake, a relay output (relay 01 or relay 02) or a programmed digital output (terminal 27 or 29) is required. Normally this output must be closed during periods when the frequency converter is unable to 'hold' the motor, e.g. due to an excessive load. Select [32] *Mechanical Brake Control* for applications with an electro-magnetic brake in 5-40 *Function Relay*, 5-30 *Terminal 27 Digital Output*, or 5-31 *Terminal 29 Digital Output*. When selecting [32] *Mechanical brake control*, the mechanical brake is closed from start up until the output current is above the level selected in 2-20 *Release Brake Current*. During stop, the mechanical brake activates when the speed falls below the level specified in 2-21 *Activate Brake Speed [RPM]*. If the frequency converter enters an alarm condition or an over-current or over-voltage situation, the mechanical brake immediately cuts in. This is also the case during safe stop.

NOTE

Protection mode and trip delay features (14-25 *Trip Delay at Torque Limit* and 14-26 *Trip Delay at Inverter Fault*) may delay the activation of the mechanical brake in an alarm condition. These features must be disabled in hoisting applications.

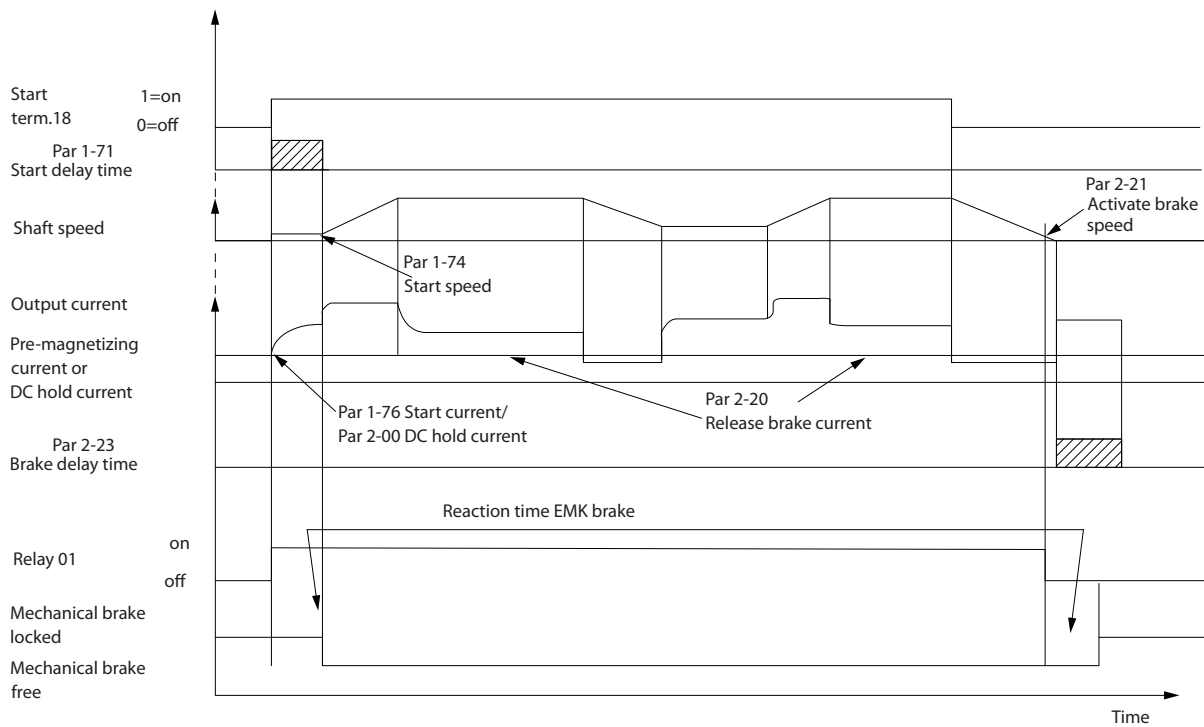

130BA074.12

3

Illustration 3.19 Mechanical Brake

2-20 Release Brake Current		
Range:	Function:	
par. 16-37 A*	[0.00 - par. 16-37 A]	Set the motor current for release of the mechanical brake, when a start condition is present. The default value is the maximum current the inverter can provide for the particular power size. The upper limit is specified in <i>16-37 Inv. Max. Current</i> .
<p>NOTE When Mechanical brake control output is selected but no mechanical brake is connected, the function will not work by default setting due to too low motor current.</p>		

2-23 Activate Brake Delay		
Range:	Function:	
0.0 s*	[0.0 - 5.0 s]	Enter the brake delay time of the coast after ramp-down time. The shaft is held at zero speed with full holding torque. Ensure that the mechanical brake has locked the load before the motor enters coast mode. See <i>Mechanical Brake Control</i> section in the Design Guide.

2-24 Stop Delay		
Range:	Function:	
0.0 s*	[0.0 - 5.0 s]	Set the time interval from the moment when the motor is stopped until the brake closes. This parameter is a part of the stopping function.

2-21 Activate Brake Speed [RPM]		
Range:	Function:	
0 RPM*	[0 - 30000 RPM]	Set the motor speed for activation of the mechanical brake, when a stop condition is present. The upper speed limit is specified in <i>4-53 Warning Speed High</i> .

2-25 Brake Release Time		
Range:	Function:	
0.20 s*	[0.00 - 5.00 s]	This value defines the time it takes for the mechanical brake to open. This parameter must act as a time-out when brake feedback is activated.

2-22 Activate Brake Speed [Hz]		
Range:	Function:	
0 Hz*	[0.0 - 5000.0 Hz]	Set the motor frequency for activation of the mechanical brake, when a stop condition is present.

2-26 Torque Ref		
Range:	Function:	
0.00 %*	[0 - 0 %]	The value defines the torque applied against the closed mechanical brake, before release

3

2-27 Torque Ramp Time		
Range:	Function:	
0.2 s*	[0.0 - 5.0 s]	The value defines the duration of the torque ramp in clockwise direction.

2-28 Gain Boost Factor		
Range:	Function:	
1.00 N/A*	[1.00 - 4.00 N/A]	Only active in flux closed loop. The function ensures a smooth transition from torque control mode to speed control mode when the motor takes over the load from the brake.

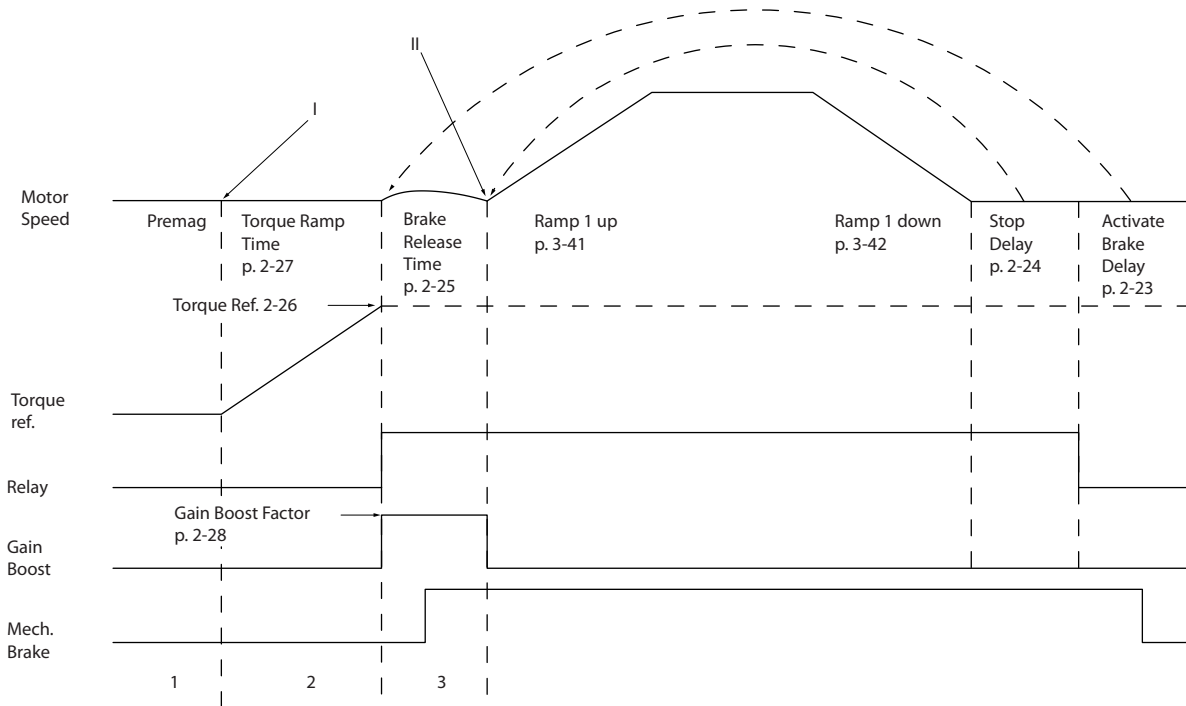

130BA642.12

Illustration 3.20 Brake release sequence for hoist mechanical brake control

- I) *Activate brake delay*: The frequency converter starts again from the *mechanical brake engaged* position.
- II) *Stop delay*: When the time between successive starts is shorter than the setting in 2-24 *Stop Delay*, the frequency converter starts without applying the mechanical brake (e.g. reversing).

3.5 Parameters: 3-** Reference/Ramps

Parameters for reference handling, definition of limitations, and configuration of the reaction of the frequency converter to changes.

3.5.1 3-0* Reference Limits

3-00 Reference Range		
Option:	Function:	
		Select the range of the reference signal and the feedback signal. Signal values can be positive only, or positive and negative. The minimum limit may have a negative value, unless [1] <i>Speed closed loop control</i> or [3] <i>Process</i> is selected in 1-00 Configuration Mode.
[0]	Min - Max	Select the range of the reference signal and the feedback signal. Signal values can be positive only, or positive and negative. The minimum limit may have a negative value, unless [1] <i>Speed closed loop control</i> or [3] <i>Process</i> is selected in 1-00 Configuration Mode.
[1] *	-Max - +Max	For both positive and negative values (both directions, relative to 4-10 Motor Speed Direction).

3-01 Reference/Feedback Unit		
Option:	Function:	
		Select the unit to be used in Process PID Control references and feedbacks. 1-00 Configuration Mode must be either [3] <i>Process</i> or [8] <i>Extended PID Control</i> .
[0] *	None	
[1]	%	
[2]	RPM	
[3]	Hz	
[4]	Nm	
[5]	PPM	
[10]	1/min	
[12]	Pulse/s	
[20]	l/s	
[21]	l/min	
[22]	l/h	
[23]	m ³ /s	
[24]	m ³ /min	
[25]	m ³ /h	
[30]	kg/s	
[31]	kg/min	
[32]	kg/h	
[33]	t/min	
[34]	t/h	
[40]	m/s	
[41]	m/min	
[45]	m	
[60]	°C	

3-01 Reference/Feedback Unit		
Option:	Function:	
[70]	mbar	
[71]	bar	
[72]	Pa	
[73]	kPa	
[74]	m WG	
[80]	kW	
[120]	GPM	
[121]	gal/s	
[122]	gal/min	
[123]	gal/h	
[124]	CFM	
[125]	ft ³ /s	
[126]	ft ³ /min	
[127]	ft ³ /h	
[130]	lb/s	
[131]	lb/min	
[132]	lb/h	
[140]	ft/s	
[141]	ft/min	
[145]	ft	
[150]	lb ft	
[160]	°F	
[170]	psi	
[171]	lb/in ²	
[172]	in WG	
[173]	ft WG	
[180]	HP	

3-02 Minimum Reference		
Range:	Function:	
0 Reference-FeedbackUnit*	[-999999.999 - par. 3-03 ReferenceFeedbackUnit]	<p>Enter the Minimum Reference. The Minimum Reference is the lowest value obtainable by summing all references. Minimum Reference is active only when 3-00 Reference Range is set to [0] <i>Min.- Max</i>. The Minimum Reference unit matches:</p> <ul style="list-style-type: none"> The choice of configuration in 1-00 Configuration Mode Configuration Mode: for [1] <i>Speed closed loop</i>, RPM; for [2] <i>Torque</i>, Nm. The unit selected in 3-01 Reference/Feedback Unit.

3

3-03 Maximum Reference		
Range:		Function:
1500.000 ReferenceFeed- backUnit*	[par. 3-02 - 999999.999 ReferenceFeed- backUnit]	Enter the Maximum Reference. The Maximum Reference is the highest value obtainable by summing all references. The Maximum Reference unit matches: <ul style="list-style-type: none"> The choice of configuration in 1-00 Configuration Mode: for [1] Speed closed loop, RPM; for [2] Torque, Nm. The unit selected in 3-00 Reference Range.

3-04 Reference Function		
Option:	Function:	
[0] *	Sum	Sums both external and preset reference sources.
[1]	External/Preset	Use either the preset or the external reference source. Shift between external and preset via a command or a digital input.

3.5.2 3-1* References

Select the preset reference(s). Select Preset ref. bit 0/1/2 [16], [17] or [18] for the corresponding digital inputs in parameter group 5-1*.

3-10 Preset Reference		
Array [8] Range: 0-7		
Range:	Function:	
0.00 %*	[-100.00 - 100.00 %]	Enter up to eight different preset references (0-7) in this parameter, using array programming. The preset reference is stated as a percentage of the value Ref _{MAX} (3-03 Maximum Reference) if a Ref _{MIN} different from 0 (3-02 Minimum Reference) is programmed, the preset reference is calculated as a percentage of the full reference range, i.e. on the basis of the difference between Ref _{MAX} and Ref _{MIN} . Afterwards, the value is added to Ref _{MIN} . When using preset references, select Preset ref. bit 0/1/2 [16], [17] or [18] for the corresponding digital inputs in parameter group 5-1*.

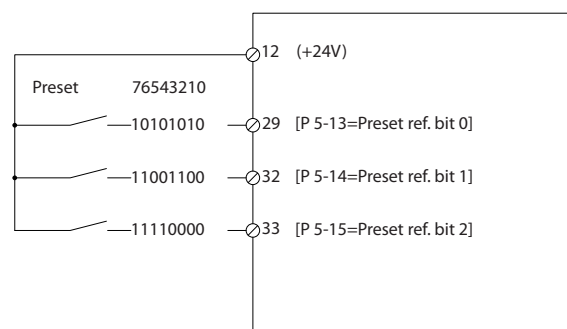

Illustration 3.21

Preset ref. bit	2	1	0
Preset ref. 0	0	0	0
Preset ref. 1	0	0	1
Preset ref. 2	0	1	0
Preset ref. 3	0	1	1
Preset ref. 4	1	0	0
Preset ref. 5	1	0	1
Preset ref. 6	1	1	0
Preset ref. 7	1	1	1

Table 3.10 Preset Ref. Bit

3-11 Jog Speed [Hz]		
Range:	Function:	
0 Hz* 4-14 Hz]	[0.0 - par.	The jog speed is a fixed output speed at which the frequency converter is running when the jog function is activated. See also 3-80 Jog Ramp Time.

3-12 Catch up/slow Down Value		
Range:	Function:	
0.00 %*	[0.00 - 100.00 %]	Enter a percentage (relative) value to be either added to or deducted from the actual reference for Catch up or Slow down respectively. If Catch up is selected via one of the digital inputs (5-10 Terminal 18 Digital Input to 5-15 Terminal 33 Digital Input), the percentage (relative) value is added to the total reference. If Slow down is selected via one of the digital inputs (5-10 Terminal 18 Digital Input to 5-15 Terminal 33 Digital Input), the percentage (relative) value is deducted from the total reference. Obtain extended functionality with the DigiPot function. See parameter group 3-9* Digital Potentiometer.

3-13 Reference Site		
Option:	Function:	
		Select which reference site to activate.
[0] *	Linked to Hand / Auto	Use local reference when in Hand mode; or remote reference when in Auto mode.
[1]	Remote	Use remote reference in both Hand mode and Auto mode.
[2]	Local	Use local reference in both Hand mode and Auto mode. NOTE When set to [2] Local, the frequency converter will start with this setting again following a 'power down'.

3-14 Preset Relative Reference		
Range:	Function:	
0.00 %*	[-100.00 - 100.00 %]	The actual reference, X, is increased or decreased with the percentage Y, set in 3-14 Preset Relative Reference. This results in the actual reference Z. Actual reference (X) is the sum of the inputs selected in 3-15 Reference 1 Source, 3-16 Reference 2 Source, 3-17 Reference 3 Source and 8-02 Control Source.

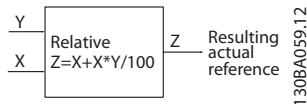

Illustration 3.22

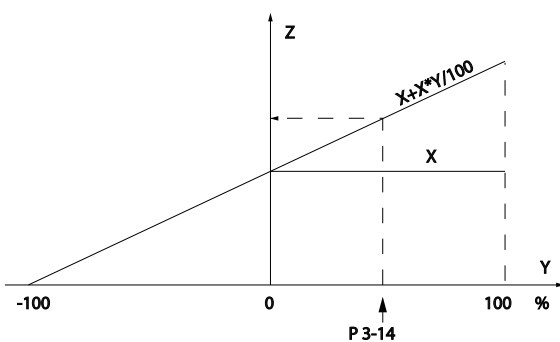

Illustration 3.23

3-15 Reference Resource 1		
Option:	Function:	
		Select the reference input to be used for the first reference signal. 3-15 Reference Resource 1, 3-16 Reference Resource 2 and 3-17 Reference Resource 3 define up to three different reference signals. The

3-15 Reference Resource 1		
Option:	Function:	
		sum of these reference signals defines the actual reference.
[0]	No function	
[1] *	Analog input 53	
[2]	Analog input 54	
[7]	Frequency input 29	
[8]	Frequency input 33	
[11]	Local bus reference	
[20]	Digital pot.meter	
[21]	Analog input X30-11	(General Purpose I/O Option Module)
[22]	Analog input X30-12	(General Purpose I/O Option Module)

3-16 Reference Resource 2		
Option:	Function:	
		Select the reference input to be used for the second reference signal. 3-15 Reference Resource 1, 3-16 Reference Resource 2 and 3-17 Reference Resource 3 define up to three different reference signals. The sum of these reference signals defines the actual reference.
[0]	No function	
[1]	Analog input 53	
[2]	Analog input 54	
[7]	Frequency input 29	
[8]	Frequency input 33	
[11]	Local bus reference	
[20] *	Digital pot.meter	
[21]	Analog input X30-11	
[22]	Analog input X30-12	

3-17 Reference Resource 3		
Option:	Function:	
		Select the reference input to be used for the third reference signal. 3-15 Reference Resource 1, 3-16 Reference Resource 2 and 3-17 Reference Resource 3 define up to three different reference signals. The sum of these reference signals defines the actual reference.
[0]	No function	
[1]	Analog input 53	
[2]	Analog input 54	
[7]	Frequency input 29	
[8]	Frequency input 33	
[11] *	Local bus reference	
[20]	Digital pot.meter	
[21]	Analog input X30-11	
[22]	Analog input X30-12	

3-18 Relative Scaling Reference Resource		
Option:	Function:	
		<p>Select a variable value to be added to the fixed value (defined in 3-14 Preset Relative Reference). The sum of the fixed and variable values (labelled Y in the illustration below) is multiplied with the actual reference (labelled X in the illustration below). This product is then added to the actual reference ($X+X*Y/100$) to give the resultant actual reference.</p> <div style="text-align: center;"> <p>130BA059.12</p> </div> <p>Illustration 3.24</p>
[0] *	No function	
[1]	Analog input 53	
[2]	Analog input 54	
[7]	Frequency input 29	
[8]	Frequency input 33	
[11]	Local bus reference	
[20]	Digital pot.meter	
[21]	Analog input X30-11	
[22]	Analog input X30-12	

NOTE

This parameter cannot be adjusted while the motor is running.

3-19 Jog Speed [RPM]		
Range:	Function:	
150. RPM*	[0 - par. 4-13 RPM]	<p>Enter a value for the jog speed n_{JOG}, which is a fixed output speed. The frequency converter runs at this speed when the jog function is activated. The maximum limit is defined in 4-13 Motor Speed High Limit [RPM]. See also 3-80 Jog Ramp Time.</p>

3.5.3 Ramps
3-4* Ramp 1

For each of four ramps (parameter groups 3-4*, 3-5*, 3-6* and 3-7*) configure the ramp parameters: ramp type, ramping times (duration of acceleration and deceleration) and level of jerk compensation for S ramps.

Start by setting the linear ramping times corresponding to the figures.

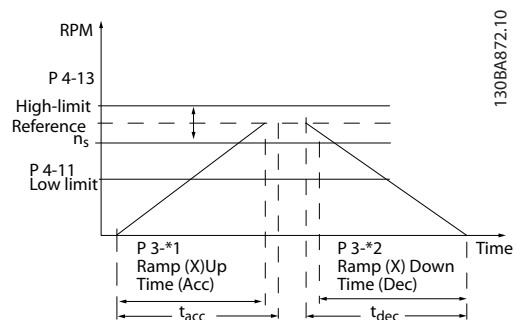

Illustration 3.25

If S-ramps are selected then set the level of non-linear jerk compensation required. Set jerk compensation by defining the proportion of ramp-up and ramp-down times where acceleration and deceleration are variable (i.e. increasing or decreasing). The S-ramp acceleration and deceleration settings are defined as a percentage of the actual ramp time.

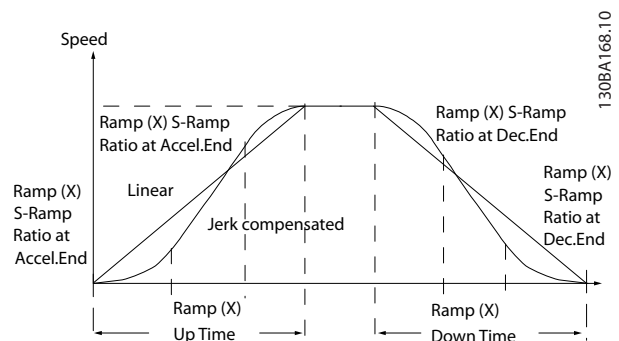

Illustration 3.26

3-40 Ramp 1 Type		
Option:	Function:	
		Select the ramp type, depending on requirements for acceleration/deceleration. A linear ramp will give constant acceleration during ramping. An S-ramp will give non-linear acceleration, compensating for jerk in the application.
[0] *	Linear	
[1]	S-ramp Const Jerk	Acceleration with lowest possible jerk.
[2]	S-ramp Const Time	S-ramp based on the values set in 3-41 Ramp 1 Ramp up Time and 3-42 Ramp 1 Ramp Down Time.

NOTE

If [1] *S-ramp Const Jerk* is selected and the reference during ramping is changed the ramp time may be prolonged in order to realize a jerk free movement which may result in a longer start or stop time.

Additional adjustment of the S-ramp ratios or switching initiators may be necessary.

3-41 Ramp 1 Ramp up Time		
Range:	Function:	
3.00 s*	[0.01 - 3600.00 s]	Enter the ramp-up time, i.e. the acceleration time from 0 RPM to the synchronous motor speed n_s . Choose a ramp-up time such that the output current does not exceed the current limit in 4-18 <i>Current Limit</i> during ramping. The value 0.00 corresponds to 0.01 s in speed mode. See ramp-down time in 3-42 Ramp 1 Ramp Down Time.
		$Par. 3 - 41 = \frac{t_{acc} [s] \times n_s [RPM]}{ref [RPM]}$

3-42 Ramp 1 Ramp Down Time		
Range:	Function:	
3.00 s*	[0.01 - 3600.00 s]	Enter the ramp-down time, that is, the deceleration time from the synchronous motor speed n_s to 0 RPM. Choose a ramp-down time such that no over-voltage arises in the inverter due to regenerative operation of the motor, and such that the generated current does not exceed the current limit set in 4-18 <i>Current Limit</i> . The value 0.00 corresponds to 0.01 s in speed mode. See ramp-up time in 3-41 Ramp 1 Ramp up Time.
		$Par. 3 - 42 = \frac{t_{dec} [s] \times n_s [RPM]}{ref [RPM]}$

3-45 Ramp 1 S-ramp Ratio at Accel. Start		
Range:	Function:	
50 %*	[1 - 99. %]	Enter the proportion of the total ramp-up time (3-41 Ramp 1 Ramp up Time) in which

3-45 Ramp 1 S-ramp Ratio at Accel. Start		
Range:	Function:	
		the acceleration torque increases. The larger the percentage value, the greater the jerk compensation achieved, and thus the lower the torque jerks occurring in the application.

3-46 Ramp 1 S-ramp Ratio at Accel. End		
Range:	Function:	
50 %*	[1 - 99. %]	Enter the proportion of the total ramp-up time (3-41 Ramp 1 Ramp up Time) in which the acceleration torque decreases. The larger the percentage value, the greater the jerk compensation achieved, and thus the lower the torque jerks in the application.

3-47 Ramp 1 S-ramp Ratio at Decel. Start		
Range:	Function:	
50 %*	[1 - 99. %]	Enter the proportion of the total ramp-down time (3-42 Ramp 1 Ramp Down Time) where the deceleration torque increases. The larger the percentage value, the greater the jerk compensation achieved, and thus the lower the torque jerks in the application.

3-48 Ramp 1 S-ramp Ratio at Decel. End		
Range:	Function:	
50 %*	[1 - 99. %]	Enter the proportion of the total ramp-down time (3-42 Ramp 1 Ramp Down Time) where the deceleration torque decreases. The larger the percentage value, the greater the jerk compensation achieved, and thus the lower the torque jerks in the application.

3.5.4 3-5* Ramp 2

Choosing ramp parameters, see parameter group 3-4*.

3-50 Ramp 2 Type		
Option:	Function:	
		Select the ramp type, depending on requirements for acceleration/deceleration. A linear ramp will give constant acceleration during ramping. An S-ramp will give non-linear acceleration, compensating for jerk in the application.
[0] *	Linear	
[1]	S-ramp Const Jerk	Acceleration with lowest possible jerk
[2]	S-ramp Const Time	S-ramp based on the values set in 3-51 Ramp 2 Ramp up Time and 3-52 Ramp 2 Ramp down Time

NOTE

If [1] *S-ramp Const Jerk* is selected and the reference during ramping is changed the ramp time may be prolonged in order to realize a jerk free movement which may result in a longer start or stop time.

Additional adjustment of the S-ramp ratios or switching initiators may be necessary.

3-51 Ramp 2 Ramp up Time		
Range:	Function:	
3.00 s*	[0.01 - 3600.00 s]	Enter the ramp-up time, i.e. the acceleration time from 0 RPM to the rated motor speed n_s . Choose a ramp-up time such that the output current does not exceed the current limit in 4-18 <i>Current Limit</i> during ramping. The value 0.00 corresponds to 0.01 s in speed mode. See ramp-down time in 3-52 <i>Ramp 2 Ramp down Time</i> . $Par. 3 - 51 = \frac{t_{acc}[s] \times n_s [RPM]}{ref[RPM]}$

3-52 Ramp 2 Ramp down Time		
Range:	Function:	
3.00 s*	[0.01 - 3600.00 s]	Enter the ramp-down time, i.e. the deceleration time from the rated motor speed n_s to 0 RPM. Choose a ramp-down time such that no over-voltage arises in the inverter due to regenerative operation of the motor, and such that the generated current does not exceed the current limit set in 4-18 <i>Current Limit</i> . The value 0.00 corresponds to 0.01 s in speed mode. See ramp-up time in 3-51 <i>Ramp 2 Ramp up Time</i> . $Par. 3 - 52 = \frac{t_{dec}[s] \times n_s [RPM]}{ref[RPM]}$

3-55 Ramp 2 S-ramp Ratio at Accel. Start		
Range:	Function:	
50 %*	[1 - 99. %]	Enter the proportion of the total ramp-up time (3-51 <i>Ramp 2 Ramp up Time</i>) in which the acceleration torque increases. The larger the percentage value, the greater the jerk compensation achieved, and thus the lower the torque jerks in the application.

3-56 Ramp 2 S-ramp Ratio at Accel. End		
Range:	Function:	
50 %*	[1 - 99. %]	Enter the proportion of the total ramp-up time (3-51 <i>Ramp 2 Ramp up Time</i>) in which the acceleration torque decreases. The larger the percentage value, the greater the jerk compensation achieved, and thus the lower the torque jerks in the application.

3-57 Ramp 2 S-ramp Ratio at Decel. Start		
Range:	Function:	
50 %*	[1 - 99. %]	Enter the proportion of the total ramp-down time (3-52 <i>Ramp 2 Ramp down Time</i>) where the deceleration torque increases. The larger the percentage value, the greater the jerk compensation achieved, and thus the lower the torque jerks in the application.

3-58 Ramp 2 S-ramp Ratio at Decel. End		
Range:	Function:	
50 %*	[1 - 99. %]	Enter the proportion of the total ramp-down time (3-52 <i>Ramp 2 Ramp down Time</i>) where the deceleration torque decreases. The larger the percentage value, the greater the jerk compensation achieved, and thus the lower the torque jerks in the application.

3.5.5 3-6* Ramp 3

Configure ramp parameters, see 3-4*.

3-60 Ramp 3 Type		
Option:	Function:	
		Select the ramp type, depending on requirements for acceleration and deceleration. A linear ramp will give constant acceleration during ramping. An S-ramp will give non-linear acceleration, compensating for jerk in the application.
[0] *	Linear	
[1]	S-ramp Const Jerk	Accelerates with lowest possible jerk.
[2]	S-ramp Const Time	S-ramp based on the values set in 3-61 <i>Ramp 3 Ramp up Time</i> and 3-62 <i>Ramp 3 Ramp down Time</i>

NOTE

If [1] *S-ramp Const Jerk* is selected and the reference during ramping is changed the ramp time may be prolonged in order to realize a jerk free movement which may result in a longer start or stop time.

Additional adjustment of the S-ramp ratios or switching initiators may be necessary.

3-61 Ramp 3 Ramp up Time		
Range:	Function:	
3.00 s*	[0.01 - 3600.00 s]	Enter the ramp-up time, i.e. the acceleration time from 0 RPM to the rated motor speed n_s . Choose a ramp-up time such that the output current does not exceed the current limit in 4-18 <i>Current Limit</i> during ramping. The value 0.00 corresponds to 0.01 s in speed mode. See

3-61 Ramp 3 Ramp up Time		
Range:		Function:
		ramp-down time in 3-62 Ramp 3 Ramp down Time.

3-62 Ramp 3 Ramp down Time		
Range:		Function:
3.00 s*	[0.01 - 3600.00 s]	Enter the ramp-down time, i.e. the deceleration time from the rated motor speed n_s to 0 RPM. Choose a ramp-down time such that no over-voltage arises in the inverter due to regenerative operation of the motor, and such that the generated current does not exceed the current limit set in 4-18 Current Limit. The value 0.00 corresponds to 0.01 s in speed mode. See ramp-up time in 3-61 Ramp 3 Ramp up Time. $Par. 3 - 62 = \frac{t_{dec} [s] \times n_s [RPM]}{ref [RPM]}$

3-65 Ramp 3 S-ramp Ratio at Accel. Start		
Range:		Function:
50 %*	[1 - 99. %]	Enter the proportion of the total ramp-up time (3-61 Ramp 3 Ramp up Time) in which the acceleration torque increases. The larger the percentage value, the greater the jerk compensation achieved, and thus the lower the torque jerks in the application.

3-66 Ramp 3 S-ramp Ratio at Accel. End		
Range:		Function:
50 %*	[1 - 99. %]	Enter the proportion of the total ramp-up time (3-61 Ramp 3 Ramp up Time) in which the acceleration torque decreases. The larger the percentage value, the greater the jerk compensation achieved, and thus the lower the torque jerks in the application.

3-67 Ramp 3 S-ramp Ratio at Decel. Start		
Range:		Function:
50 %*	[1 - 99. %]	Enter the proportion of the total ramp-down time (3-62 Ramp 3 Ramp down Time) where the deceleration torque increases. The larger the percentage value, the greater the jerk compensation achieved, and thus the lower the torque jerks in the application.

3-68 Ramp 3 S-ramp Ratio at Decel. End		
Range:		Function:
50 %*	[1 - 99. %]	Enter the proportion of the total ramp-down time (3-62 Ramp 3 Ramp down Time) where the deceleration torque decreases. The larger the percentage value, the greater the jerk compensation achieved, and thus the lower the torque jerks in the application.

3.5.6 3-7* Ramp 4

Configure ramp parameters, see parameter group 3-4*.

3-70 Ramp 4 Type		
Option:		Function:
		Select the ramp type, depending on requirements for acceleration and deceleration. A linear ramp will give constant acceleration during ramping. An S-ramp will give non-linear acceleration, compensating for jerk in the application
[0] *	Linear	
[1]	S-ramp Const Jerk	Accelerates with lowest possible jerk.
[2]	S-ramp Const Time	S-ramp based on the values set in 3-71 Ramp 4 Ramp up Time and 3-72 Ramp 4 Ramp Down Time.

NOTE

If [1] S-ramp Const Jerk is selected and the reference during ramping is changed the ramp time may be prolonged in order to realize a jerk free movement which may result in a longer start or stop time. Additional adjustment of the S-ramp ratios or switching initiators may be necessary.

3-71 Ramp 4 Ramp up Time		
Range:		Function:
3.00 s*	[0.01 - 3600.00 s]	Enter the ramp-up time, i.e. the acceleration time from 0 RPM to the rated motor speed n_s . Choose a ramp-up time such that the output current does not exceed the current limit in 4-18 Current Limit during ramping. The value 0.00 corresponds to 0.01 s in speed mode. See ramp-down time in 3-72 Ramp 4 Ramp Down Time. $Par. 3 - 71 = \frac{t_{acc} [s] \times n_s [RPM]}{ref [RPM]}$

3-72 Ramp 4 Ramp Down Time		
Range:		Function:
3.00 s*	[0.01 - 3600.00 s]	Enter the ramp-down time, i.e. the deceleration time from the rated motor speed n_s to 0 RPM. Choose a ramp-down time such

3-72 Ramp 4 Ramp Down Time		
Range:	Function:	
	that no over-voltage arises in the inverter due to regenerative operation of the motor, and such that the generated current does not exceed the current limit set in 4-18 <i>Current Limit</i> . The value 0.00 corresponds to 0.01 s in speed mode. See ramp-up time in 3-71 <i>Ramp 4 Ramp up Time</i> .	
	$\text{Par. 3 - 72} = \frac{t_{dec} [s] \times n_s [RPM]}{ref [RPM]}$	

3-75 Ramp 4 S-ramp Ratio at Accel. Start		
Range:	Function:	
50 %*	[1 - 99. %]	Enter the proportion of the total ramp-up time (3-71 <i>Ramp 4 Ramp up Time</i>) in which the acceleration torque increases. The larger the percentage value, the greater the jerk compensation achieved, and thus the lower the torque jerks in the application.

3-76 Ramp 4 S-ramp Ratio at Accel. End		
Range:	Function:	
50 %*	[1 - 99. %]	Enter the proportion of the total ramp-up time (3-71 <i>Ramp 4 Ramp up Time</i>) in which the acceleration torque decreases. The larger the percentage value, the greater the jerk compensation achieved, and thus the lower the torque jerks in the application.

3-77 Ramp 4 S-ramp Ratio at Decel. Start		
Range:	Function:	
50 %*	[1 - 99. %]	Enter the proportion of the total ramp-down time (3-72 <i>Ramp 4 Ramp Down Time</i>) where the deceleration torque increases. The larger the percentage value, the greater the jerk compensation achieved, and thus the lower the torque jerks in the application.

3-78 Ramp 4 S-ramp Ratio at Decel. End		
Range:	Function:	
50 %*	[1 - 99. %]	Enter the proportion of the total ramp-down time (3-72 <i>Ramp 4 Ramp Down Time</i>) where the deceleration torque decreases. The larger the percentage value, the greater the jerk compensation achieved, and thus the lower the torque jerks in the application.

3-80 Jog Ramp Time		
Range:	Function:	
	RPM and the rated motor frequency n_s . Ensure that the resultant output current required for the given jog ramp time does not exceed the current limit in 4-18 <i>Current Limit</i> . The jog ramp time starts upon activation of a jog signal via the LCP, a selected digital input, or the serial communication port. When jog state is disabled then the normal ramping times are valid.	

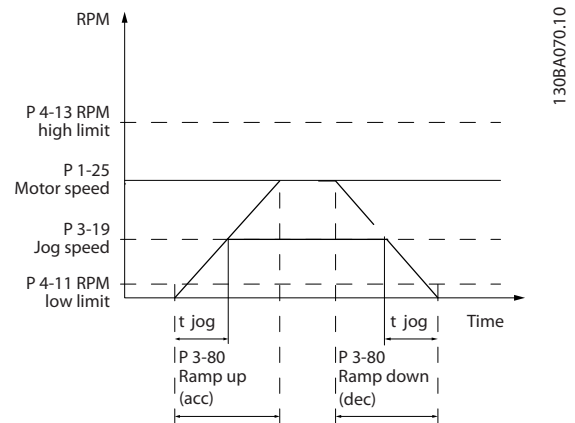

Illustration 3.27

$$\text{Par. 3 - 80} = \frac{t_{jog} [s] \times n_s [RPM]}{\Delta \text{ jog speed (par. 3 - 19) [RPM]}}$$

3-81 Quick Stop Ramp Time		
Range:	Function:	
3.00 s*	[0.01 - 3600.00 s]	Enter the quick-stop ramp-down time, i.e. the deceleration time from the synchronous motor speed to 0 RPM. Ensure that no resultant over-voltage will arise in the inverter due to regenerative operation of the motor required to achieve the given ramp-down time. Ensure also that the generated current required to achieve the given ramp-down time does not exceed the current limit (set in 4-18 <i>Current Limit</i>). Quick-stop is activated by means of a signal on a selected digital input, or via the serial communication port.

3.5.7 3-8* Other Ramps

3-80 Jog Ramp Time		
Range:	Function:	
3.00 s*	[0.01 - 3600.00 s]	Enter the jog ramp time, i.e. the acceleration/deceleration time between 0

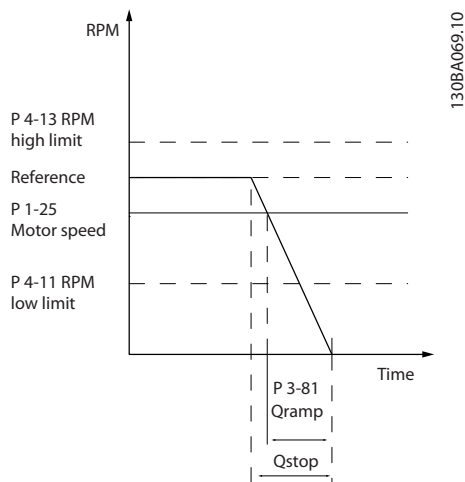

Illustration 3.28

3.5.8 3-9* Digital Pot.Meter

The digital potentiometer function allows the user to increase or decrease the actual reference by adjusting the set-up of the digital inputs using the functions *Increase*, *Decrease* or *Clear*. To activate the function, at least one digital input must be set up to *Increase* or *Decrease*.

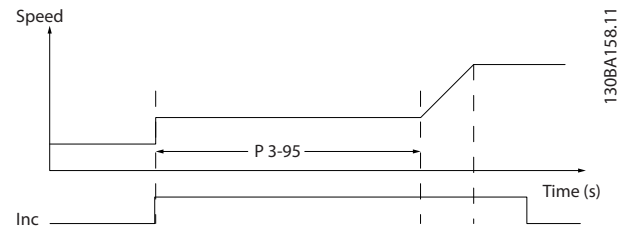

Illustration 3.29

3-82 Quick Stop Ramp Type		
Option:	Function:	
	Select the ramp type, depending on requirements for acceleration and deceleration. A linear ramp will give constant acceleration during ramping. An S-ramp will give non-linear acceleration, compensating for jerk in the application.	
[0] *	Linear	
[1]	S-ramp Const Jerk	
[2]	S-ramp Const Time	

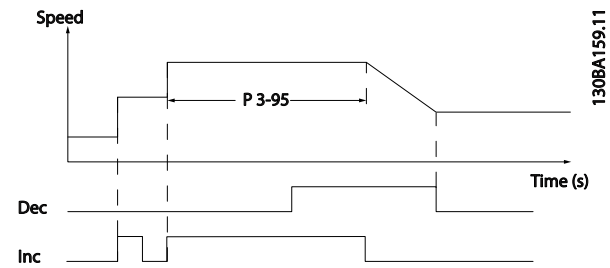

Illustration 3.30

3-83 Quick Stop S-ramp Ratio at Decel. Start		
Range:	Function:	
50 %* [1 - 99 %]	Enter the proportion of the total ramp-down time (3-42 Ramp 1 Ramp Down Time) where the deceleration torque increases. The larger the percentage value, the greater the jerk compensation achieved, and thus the lower the torque jerks in the application.	

3-84 Quick Stop S-ramp Ratio at Decel. End		
Range:	Function:	
50 %* [1 - 99 %]	Enter the proportion of the total ramp-down time (3-42 Ramp 1 Ramp Down Time) where the deceleration torque decreases. The larger the percentage value, the greater the jerk compensation achieved, and thus the lower the torque jerks in the application.	

3-90 Step Size		
Range:	Function:	
0.10 %* [0.01 - 200.00 %]	Enter the increment size required for INCREASE/DECREASE, as a percentage of the synchronous motor speed, n_s . If INCREASE/DECREASE is activated the resulting reference will be increased/ decreased by the amount set in this parameter.	

3-91 Ramp Time		
Range:	Function:	
1.00 s* [0.00 - 3600.00 s]	Enter the ramp time, i.e. the time for adjustment of the reference from 0% to 100% of the specified digital potentiometer function (Increase, Decrease or Clear). If Increase/ Decrease is activated for longer than the ramp delay period specified in 3-95 Ramp Delay the actual reference will be ramped up / down according to this ramp time. The ramp time is defined as the time used to adjust the reference by the step size specified in 3-90 Step Size.	

3-92 Power Restore		
Option:	Function:	
[0] *	Off	Resets the Digital Potentiometer reference to 0% after power up.
[1]	On	Restores the most recent Digital Potentiometer reference at power up.

3-93 Maximum Limit		
Range:	Function:	
100 %*	[-200 - 200 %]	Set the maximum permissible value for the resultant reference. This is advisable if the Digital Potentiometer is used for fine tuning of the resulting reference.

3-94 Minimum Limit		
Range:	Function:	
-100 %*	[-200 - 200 %]	Set the minimum permissible value for the resultant reference. This is advisable if the Digital Potentiometer is used for fine tuning of the resulting reference.

3-95 Ramp Delay		
Range:	Function:	
0 N/A*	[0 - 0 N/A]	Enter the delay required from activation of the digital potentiometer function until the frequency converter starts to ramp the reference. With a delay of 0 ms, the reference starts to ramp as soon as INCREASE/DECREASE is activated. See also <i>3-91 Ramp Time</i> .

3.6 Parameters: 4-** Limits/Warnings

3.6.1 4-1* Motor Limits

Define torque, current and speed limits for the motor, and the reaction of the frequency converter when the limits are exceeded.

A limit may generate a message on the display. A warning will always generate a message on the display or on the fieldbus. A monitoring function may initiate a warning or a trip, upon which the frequency converter will stop and generate an alarm message.

4-10 Motor Speed Direction		
Option:	Function:	
		Select the motor speed direction(s) required. Use this parameter to prevent unwanted reversing. When <i>1-00 Configuration Mode</i> is set to <i>Process</i> [3], <i>4-10 Motor Speed Direction</i> is set to <i>Clockwise</i> [0] as default. The setting in <i>4-10 Motor Speed Direction</i> does not limit options for setting <i>4-13 Motor Speed High Limit [RPM]</i> .
[0] *	Clockwise	The reference is set to CW rotation. Reversing input (Default term 19) must be open.
[1]	Counter clockwise	The reference is set to CCW rotation. Reversing input (Default term 19) must be closed. If Reversing is required with 'Reverse' input is open the motor direction can be changed by <i>1-06 Clockwise Direction</i>
[2]	Both directions	Allows the motor to rotate in both directions.

NOTE

This parameter cannot be adjusted while the motor is running.

4-11 Motor Speed Low Limit [RPM]		
Range:	Function:	
0 RPM*	[0 - par. 4-13 RPM]	Enter the minimum limit for motor speed. The Motor Speed Low Limit can be set to correspond to the manufacturer's recommended minimum motor speed. The Motor Speed Low Limit must not exceed the setting in <i>4-13 Motor Speed High Limit [RPM]</i> .

4-12 Motor Speed Low Limit [Hz]		
Range:	Function:	
0 Hz*	[0.0 - par. 4-14 Hz]	Enter the minimum limit for motor speed. The Motor Speed Low Limit can be set to correspond to the minimum output frequency of the motor shaft. The Motor Speed Low Limit must not exceed the setting in <i>4-14 Motor Speed High Limit [Hz]</i> .

4-13 Motor Speed High Limit [RPM]		
Range:	Function:	
3600. RPM*	[par. 4-11 - 60000. RPM]	Enter the maximum limit for motor speed. The Motor Speed High Limit can be set to correspond to the manufacturer's maximum rated motor speed. The Motor Speed High Limit must exceed the setting in <i>4-11 Motor Speed Low Limit [RPM]</i> .

NOTE

Max. output frequency cannot exceed 10% of the inverter switching frequency (*14-01 Switching Frequency*).

4-14 Motor Speed High Limit [Hz]		
Range:	Function:	
Size related*	[par. 4-12 - par. 4-19 Hz]	Enter the maximum limit for motor speed. The Motor Speed High Limit can be set to correspond to the manufacturer's recommended maximum of the motor shaft. The Motor Speed High Limit must exceed the in <i>4-12 Motor Speed Low Limit [Hz]</i> . Only <i>4-13 Motor Speed High Limit [RPM]</i> or <i>4-14 Motor Speed High Limit [Hz]</i> will be displayed depending on other parameters in the Main Menu and depending on default settings dependant on global location.

NOTE

Max. output frequency cannot exceed 10% of the inverter switching frequency (*14-01 Switching Frequency*).

4-16 Torque Limit Motor Mode		
Range:	Function:	
160.0 %* Application dependent*	[0.0 - 1000.0 %] [Application dependant]	This function limits the torque on the shaft to protect the mechanical installation.

NOTE

Changing *4-16 Torque Limit Motor Mode* when *1-00 Configuration Mode* is set to *Speed open loop* [0], *1-66 Min. Current at Low Speed* is automatically readjusted.

NOTE

The torque limit reacts on the actual, non-filtrated torque, including torque spikes. This is not the torque that is seen from the or the as that is filtered.

4-17 Torque Limit Generator Mode		
Range:		Function:
100.0 %*	[0.0 - 1000.0 %]	This function limits the torque on the shaft to protect the mechanical installation.

NOTE

The torque limit reacts on the actual, non-filtrated torque, including torque spikes. This is not the torque that is seen from the or the as that is filtered.

4-18 Current Limit		
Range:		Function:
160.0 %*	[1.0 - 1000.0 %]	This is a true current limit function that continues in the oversynchronous range, however due to field weakening the motor torque at current limit will drop accordingly when the voltage increase stops above the synchronised speed of the motor.

NOTE

If [20] is selected in *1-90 Motor Thermal Protection*, *4-18 Current Limit* current limit must be set to 150%.

4-19 Max Output Frequency		
Range:		Function:
132.0 Hz*	[1.0 - 1000.0 Hz]	Provides a final limit on the output frequency for improved safety in applications where you want to avoid accidental over-speeding. This limit is final in all configurations (independent of the setting in <i>1-00 Configuration Mode</i>).

NOTE

This parameter cannot be adjusted while the motor is running.

NOTE

Max. output frequency cannot exceed 10% of the inverter switching frequency (*14-01 Switching Frequency*).

4-20 Torque Limit Factor Source		
Option:	Function:	
	Select an analog input for scaling the settings in <i>4-16 Torque Limit Motor Mode</i> and <i>4-17 Torque Limit Generator Mode</i> from 0% to 100% (or inverse). The signal levels corresponding to 0% and 100% are defined in the analog input scaling, e.g. parameter group 6-1*. This parameter is only active when <i>1-00 Configuration Mode</i>	

4-20 Torque Limit Factor Source		
Option:	Function:	
	is in <i>Speed Open Loop</i> or <i>Speed Closed Loop</i> .	
[0] *	No function	
[2]	Analog in 53	
[4]	Analog in 53 inv	
[6]	Analog in 54	
[8]	Analog in 54 inv	
[10]	Analog in X30-11	
[12]	Analog in X30-11 inv	
[14]	Analog in X30-12	
[16]	Analog in X30-12 inv	

4-21 Speed Limit Factor SourceOption		
Option:	Function:	
	Select an analog input for scaling the settings in <i>4-19 Max Output Frequency</i> from 0% to 100% (or vice versa). The signal levels corresponding to 0% and 100% are defined in the analog input scaling, e.g. parameter group 6-1*. This parameter is only active when <i>1-00 Configuration Mode</i> is in <i>Torque Mode</i> .	
[0] *	No function	
[2]	Analog input 53	
[4]	Analog input 53 inv	
[6]	Analog input 54	
[8]	Analog input 54 inv	
[10]	Analog input X30-11	
[12]	Analog input X30-11 inv	
[14]	Analog input X30-12	
[16]	Analog input X30-12 inv	

3.6.2 4-3* Motor Feedback Monitoring

The parameter group includes monitoring and handling of motor feedback devices as encoders, resolvers etc.

4-30 Motor Feedback Loss Function		
Option:	Function:	
	This function is used to monitor for consistency in feedback signal, i.e. if the feedback signal is available. Select which reaction the frequency converter should take if a feedback fault is detected. The selected action is to take place when the feedback signal differs from the output speed	

4-30 Motor Feedback Loss Function		
Option:	Function:	
		by the value set in 4-31 <i>Motor Feedback Speed Error</i> for longer than the value set in 4-32 <i>Motor Feedback Loss Timeout</i> .
[0]	Disabled	
[1]	Warning	
[2] *	Trip	
[3]	Jog	
[4]	Freeze Output	
[5]	Max Speed	
[6]	Switch to Open Loop	
[7]	Select Setup 1	
[8]	Select Setup 2	
[9]	Select Setup 3	
[10]	Select Setup 4	
[11]	stop & trip	

Warning 90 is active as soon as the value in 4-31 *Motor Feedback Speed Error* is exceeded, regardless of the setting of 4-32 *Motor Feedback Loss Timeout*. Warning/Alarm 61 Feedback Error is related to the Motor Feedback Loss Function.

4-31 Motor Feedback Speed Error		
Range:	Function:	
300 RPM* [1 - 600 RPM]	Select the max allowed error in speed (output speed vs. feedback).	

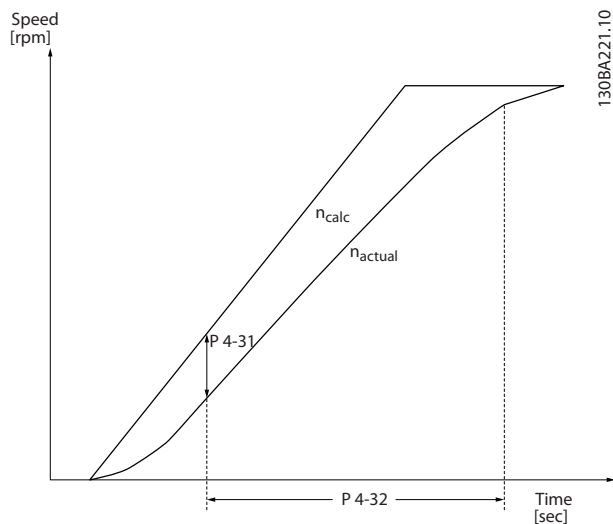

Illustration 3.31

4-32 Motor Feedback Loss Timeout		
Range:	Function:	
0.05 s* [0.00 - 60.00 s]	Set the timeout value allowing the speed error set in 4-31 <i>Motor Feedback Speed Error</i> to be exceeded before	

4-32 Motor Feedback Loss Timeout		
Range:	Function:	
	enabling the function selected in 4-30 <i>Motor Feedback Loss Function</i> .	

4-34 Tracking Error Function		
Option:	Function:	
	This function is used to monitor that the application follows the expected speed profile. In Closed loop the speed reference to the PID is compared to the encoder feedback (filtered) In open loop the speed reference to the PID is compensated for slip and compared to the frequency that is sent to the motor (16-13 Frequency). The reaction will be activated if the measured difference is more than specified in 4-35 <i>Tracking Error</i> for the time specified in 4-36 <i>Tracking Error Timeout</i> . A tracking error in closed loop does not imply that there is a problem with the feedback signal! A tracking error can be the result of torque limit at too big loads.	
[0] *	Disable	
[1]	Warning	
[2]	Trip	
[3]	Trip after stop	

Warning/Alarm 78 Tracking Error is related to the Tracking Error Function.

4-35 Tracking Error		
Range:	Function:	
10 RPM* [1 - 600 RPM]	Enter the maximum permissible speed error between the motor speed and the output of the ramp when not ramping. In open loop the motor speed is estimated and in closed loop it is the feedback from encoder/resolver.	

4-36 Tracking Error Timeout		
Range:	Function:	
1 s* [0 - 60 s]	Enter the time-out period during which an error greater than the value set in 4-35 <i>Tracking Error</i> is permissible.	

4-37 Tracking Error Ramping		
Range:	Function:	
100 RPM* [1 - 600 RPM]	Enter the maximum permissible speed error between the motor speed and the output of the ramp when ramping. In open loop the motor speed is estimated and in closed loop it is the feedback from encoder/resolver.	

4-38 Tracking Error Ramping Timeout		
Range:	Function:	
1 s*	[0 - 60 s]	Enter the time-out period during which an error greater than the value set in 4-37 <i>Tracking Error Ramping</i> while Ramping is permissible.

4-39 Tracking Error After Ramping Timeout		
Range:	Function:	
5 s*	[0 - 60 s]	Enter the time-out period after ramping where 4-37 <i>Tracking Error Ramping</i> and 4-38 <i>Tracking Error Ramping Timeout</i> are still active.

3.6.3 4-5* Adjustable Warnings

Use these parameters to adjust warning limits for current, speed, reference and feedback.

Warnings are shown on the LCP, and can be programmed to be outputs or to be read out via serial bus in the Extended Status Word.

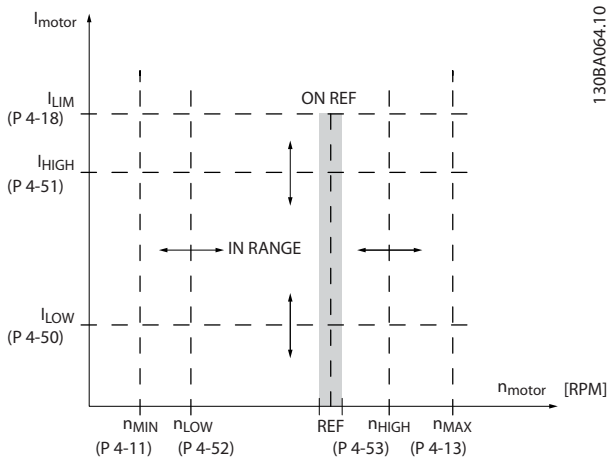

130BA064.10

Illustration 3.32 Adjustable Warnings

4-50 Warning Current Low		
Range:	Function:	
0.00 A*	[0.00 - par. 4-51 A]	Enter the I_{LOW} value. When the motor current falls below this limit, the display reads <i>Current Low</i> . The signal outputs can be programmed to produce a status signal on terminal 27 or 29 (FC 302 only) and on relay output 01 or 02 (FC 302 only). Refer to <i>Illustration 3.32</i> .

4-51 Warning Current High		
Range:	Function:	
par. 16-37 A*	[par. 4-50 - par. 16-37 A]	Enter the I_{HIGH} value. When the motor current exceeds this limit, the display reads <i>Current High</i> . The signal outputs can be programmed to produce a status

4-51 Warning Current High		
Range:	Function:	
		signal on terminal 27 or 29 (FC 302 only) and on relay output 01 or 02 (FC 302 only). Refer to <i>Illustration 3.32</i> .

4-52 Warning Speed Low		
Range:	Function:	
0 RPM*	[0 - par. 4-53 RPM]	Enter the n_{LOW} value. When the motor speed exceeds this limit, the display reads <i>Speed Low</i> . The signal outputs can be programmed to produce a status signal on terminal 27 or 29 (FC 302 only) and on relay output 01 or 02 (FC 302 only).

4-53 Warning Speed High		
Range:	Function:	
par. 4-13 RPM*	[par. 4-52 - par. 4-13 RPM]	Enter the n_{HIGH} value. When the motor speed exceeds this limit, the display reads <i>Speed High</i> . The signal outputs can be programmed to produce a status signal on terminal 27 or 29 and on relay output 01 or 02. Programme the upper signal limit of the motor speed, n_{HIGH} , within the normal working range of the frequency converter. Refer to <i>Illustration 3.32</i> .

4-54 Warning Reference Low		
Range:	Function:	
-999999.999 N/A*	[-999999.999 - par. 4-55 N/A]	Enter the lower reference limit. When the actual reference falls below this limit, the display indicates Ref_{LOW} . The signal outputs can be programmed to produce a status signal on terminal 27 or 29 (FC 302 only) and on relay output 01 or 02 (FC 302 only).

4-55 Warning Reference High		
Range:	Function:	
999999.999 N/A*	[par. 4-54 - 999999.999 N/A]	Enter the upper reference limit. When the actual reference exceeds this limit, the display reads <i>Ref High</i> . The signal outputs can be programmed to produce a status signal on terminal 27 or 29 (FC 302 only) and on relay output 01 or 02 (FC 302 only).

4-56 Warning Feedback Low		
Range:		Function:
-999999.999 ReferenceFeed- backUnit*	[-999999.999 - par. 4-57 ReferenceFeed- backUnit]	Enter the lower feedback limit. When the feedback falls below this limit, the display reads Feedb Low. The signal outputs can be programmed to produce a status signal on terminal 27 or 29 (FC 302 only) and on relay output 01 or 02 (FC 302 only).

4-57 Warning Feedback High		
Range:		Function:
999999.999 ReferenceFeed- backUnit*	[par. 4-56 - 999999.999 ReferenceFeed- backUnit]	Enter the upper feedback limit. When the feedback exceeds this limit, the display reads Feedb High. The signal outputs can be programmed to produce a status signal on terminal 27 or 29 (FC 302 only) and on relay output 01 or 02 (FC 302 only).

4-58 Missing Motor Phase Function		
Displays alarm 30, 31 or 32 in the event of a missing motor phase. It is strongly recommended to enable to avoid motor damage.		
Option:	Function:	
[0] * Disabled	The frequency converter does not issue a missing motor phase alarm. Not recommended due to risk of motor damage.	
[1] Trip 100 ms	For a quick detection time and alarm in the event of a missing motor phase.	
[2] Trip 1000 ms	For a slow detection time and alarm in the event of a missing motor phase.	

NOTE

This parameter cannot be adjusted while the motor is running.

3.6.4 4-6* Speed Bypass

Some systems call for avoiding certain output frequencies or speeds, due to resonance problems in the system. A maximum of four frequency or speed ranges can be avoided.

4-60 Bypass Speed From [RPM]		
Array [4]		
Range:		Function:
0 RPM*	[0 - par. 4-13 RPM]	Some systems call for avoiding certain output speeds due to resonance problems in the system. Enter the lower limits of the speeds to be avoided.

4-61 Bypass Speed From [Hz]		
Array [4]		
Range:		Function:
Size related*	[0.0 - par. 4-14 Hz]	Some systems call for avoiding certain output speeds due to resonance problems in the system. Enter the lower limits of the speeds to be avoided.

4-62 Bypass Speed To [RPM]		
Array [4]		
Range:		Function:
0 RPM*	[0 - par. 4-13 RPM]	Some systems call for avoiding certain output speeds due to resonance problems in the system. Enter the upper limits of the speeds to be avoided.

4-63 Bypass Speed To [Hz]		
Array [4]		
Range:		Function:
0 Hz*	[0.0 - par. 4-14 Hz]	Some systems call for avoiding certain output speeds due to resonance problems in the system. Enter the upper limits of the speeds to be avoided.

3.7 Parameters: 5-** Digital In/Out

3.7.1 5-0* Digital I/O Mode

Parameters for configuring the input and output using NPN and PNP.

5-00 Digital I/O Mode		
Option:	Function:	
		Digital inputs and programmed digital outputs are pre-programmable for operation either in PNP or NPN systems.
[0] *	PNP	Action on positive directional pulses (‡). PNP systems are pulled down to GND.
[1]	NPN	Action on negative directional pulses (‡). NPN systems are pulled up to + 24 V, internally in the frequency converter.

NOTE

Once this parameter has been changed, it must be activated by performing a power cycle.

5-01 Terminal 27 Mode		
Option:	Function:	
[0] *	Input	Defines terminal 27 as a digital input.
[1]	Output	Defines terminal 27 as a digital output.

NOTE

This parameter cannot be adjusted while the motor is running.

5-02 Terminal 29 Mode		
Option:	Function:	
[0] *	Input	Defines terminal 29 as a digital input.
[1]	Output	Defines terminal 29 as a digital output.

This parameter is available for FC 302 only.

3.7.2 Digital Inputs

The digital inputs are used for selecting various functions in the frequency converter. All digital inputs can be set to the following functions:

Digital input function	Select	Terminal
No operation	[0]	All *term 32, 33
Reset	[1]	All
Coast inverse	[2]	All *term 27
Coast and reset inverse	[3]	All
Quick stop inverse	[4]	All
DC-brake inverse	[5]	All
Stop inverse	[6]	All
Start	[8]	All *term 18

Digital input function	Select	Terminal
Latched start	[9]	All
Reversing	[10]	All *term 19
Start reversing	[11]	All
Enable start forward	[12]	All
Enable start reverse	[13]	All
Jog	[14]	All *term 29
Preset reference on	[15]	All
Preset ref bit 0	[16]	All
Preset ref bit 1	[17]	All
Preset ref bit 2	[18]	All
Freeze reference	[19]	All
Freeze output	[20]	All
Speed up	[21]	All
Speed down	[22]	All
Set-up select bit 0	[23]	All
Set-up select bit 1	[24]	All
Precise stop inverse	[26]	18, 19
Precises start, stop	[27]	18, 19
Catch up	[28]	All
Slow down	[29]	All
Counter input	[30]	29, 33
Pulse input Edge Triggered	[31]	29, 33
Pulse input Time Based	[32]	29, 33
Ramp bit 0	[34]	All
Ramp bit 1	[35]	All
Latched precise start	[40]	18, 19
Latched precise stop inverse	[41]	18, 19
External interlock	[51]	
DigiPot Increase	[55]	All
DigiPot Decrease	[56]	All
DigiPot Clear	[57]	All
Digipot Hoist	[58]	All
Counter A (up)	[60]	29, 33
Counter A (down)	[61]	29, 33
Reset Counter A	[62]	All
Counter B (up)	[63]	29, 33
Counter B (down)	[64]	29, 33
Reset Counter B	[65]	All
Mech. Brake Feedb.	[70]	All
Mech. Brake Feedb. Inv.	[71]	All
PID Error Inv.	[72]	All
PID Reset I-part	[73]	All
PID enable	[74]	All
MCO Specific	[75]	
PTC Card 1	[80]	All
Profidrive OFF2	[91]	
Profidrive OFF3	[92]	
Start edge triggered	[98]	
Safe Option Reset	[100]	

Table 3.11 Digital Input Function

FC 300 standard terminals are 18, 19, 27, 29, 32 and 33.
 MCB 101 terminals are X30/2, X30/3 and X30/4.
 Terminal 29 functions as an output only in FC 302.

Functions dedicated to only one digital input are stated in the associated parameter.

All digital inputs can be programmed to these functions:

[0]	No operation	No reaction to signals transmitted to the terminal.
[1]	Reset	Resets frequency converter after a TRIP/ALARM. Not all alarms can be reset.
[2]	Coast inverse	(Default Digital input 27): Coasting stop, inverted input (NC). The frequency converter leaves the motor in free mode. Logic '0' =>coasting stop.
[3]	Coast and reset inverse	Reset and coasting stop Inverted input (NC). Leaves motor in free mode and resets frequency converter. Logic '0' => coasting stop and reset.
[4]	Quick stop inverse	Inverted input (NC). Generates a stop in accordance with quick-stop ramp time set in 3-81 Quick Stop Ramp Time. When motor stops, the shaft is in free mode. Logic '0' => Quick-stop.
[5]	DC-brake inverse	Inverted input for DC braking (NC). Stops motor by energizing it with a DC current for a certain time period. See 2-01 DC Brake Current to 2-03 DC Brake Cut In Speed [RPM]. The function is only active when the value in 2-02 DC Braking Time is different from 0. Logic '0' => DC braking.
[6]	Stop inverse	Stop Inverted function. Generates a stop function when the selected terminal goes from logical level '1' to '0'. The stop is performed according to the selected ramp time (3-42 Ramp 1 Ramp Down Time, 3-52 Ramp 2 Ramp down Time, 3-62 Ramp 3 Ramp down Time, 3-72 Ramp 4 Ramp Down Time). NOTE When the frequency converter is at the torque limit and has received a stop command, it may not stop by itself. To ensure that the frequency converter stops, configure a digital output to Torque limit & stop [27] and connect this digital output to a digital input that is configured as coast.
[8]	Start	(Default Digital input 18): Select start for a start/stop command. Logic '1' = start, logic '0' = stop.
[9]	Latched start	The motor starts, if a pulse is applied for min. 2ms. The motor stops when Stop inverse is activated or a reset command (via DI) is given.

[10]	Reversing	(Default Digital input 19). Change the direction of motor shaft rotation. Select Logic '1' to reverse. The reversing signal only changes the direction of rotation. It does not activate the start function. Select both directions in 4-10 Motor Speed Direction. The function is not active in process closed loop.
[11]	Start reversing	Used for start/stop and for reversing on the same wire. Signals on start are not allowed at the same time.
[12]	Enable start forward	Disengages the counterclockwise movement and allows for the clockwise direction.
[13]	Enable start reverse	Disengages the clockwise movement and allows for the counterclockwise direction.
[14]	Jog	(Default Digital input 29): Use to activate jog speed. See 3-11 Jog Speed [Hz].
[15]	Preset reference on	Shifts between external reference and preset reference. It is assumed that [1] External/preset has been selected in 3-04 Reference Function. Logic '0' = external reference active; logic '1' = one of the eight preset references is active.
[16]	Preset ref bit 0	Preset ref. bit 0,1, and 2 enables a choice between one of the eight preset references according to Table 3.12.
[17]	Preset ref bit 1	Same as Preset ref bit 0 [16].
[18]	Preset ref bit 2	Same as Preset ref bit 0 [16].

Preset ref. bit	2	1	0
Preset ref. 0	0	0	0
Preset ref. 1	0	0	1
Preset ref. 2	0	1	0
Preset ref. 3	0	1	1
Preset ref. 4	1	0	0
Preset ref. 5	1	0	1
Preset ref. 6	1	1	0
Preset ref. 7	1	1	1

Table 3.12 Preset Ref. Bit

[19]	Freeze ref	Freezes the actual reference, which is now the point of enable/condition for Speed up and Speed down to be used. If Speed up/down is used, the speed change always follows ramp 2 (3-51 Ramp 2 Ramp up Time and 3-52 Ramp 2 Ramp down Time) in the range 0 - 3-03 Maximum Reference.
[20]	Freeze output	Freezes the actual motor frequency (Hz), which is now the point of enable/condition for Speed up and Speed down to be used. If Speed up/down is used, the speed change always follows ramp 2 (3-51 Ramp 2 Ramp up Time and 3-52 Ramp 2 Ramp down Time) in the range 0 - 1-23 Motor Frequency.

NOTE

When Freeze output is active, the frequency converter cannot be stopped via a low 'start [8]' signal. Stop the frequency converter via a terminal programmed for Coasting inverse [2] or Coast and reset, inverse.

[21]	Speed up	Select Speed up and Speed down if digital control of the up/down speed is desired (motor potentiometer). Activate this function by selecting either Freeze reference or Freeze output. When Speed up/down is activated for less than 400 msec. the resulting reference will be increased/ decreased by 0.1 %. If Speed up/down is activated for more than 400 msec. the resulting reference will follow the setting in ramping up/ down parameter 3-x1/ 3-x2.
------	----------	---

	Shut down	Catch up
Unchanged speed	0	0
Reduced by %-value	1	0
Increased by %-value	0	1
Reduced by %-value	1	1

Table 3.13

[22]	Speed down	Same as [21] Speed up.
[23]	Set-up select bit 0	Select Set-up select bit 0 or Select Set-up select bit 1 to select one of the four set-ups. Set 0-10 Active Set-up to Multi Set-up.
[24]	Set-up select bit 1	(Default Digital input 32): Same as [23] Set-up select bit 0.
[26]	Precise stop inv.	Sends an inverted stop signal when the precise stop function is activated in 1-83 Precise Stop Function. Precise stop inverse function is available for terminals 18 or 19.

[27]	Precise start, stop	Use when Precise ramp stop [0] is selected in 1-83 Precise Stop Function. Precise start, stop is available for terminals 18 and 19. Precise start makes sure that the angle that the rotor turns from standing still to reference is the same for each start (for same ramp time, same set-point). This is the equivalent to the precise stop where the angle that the rotor turns from reference to standing still is the same for each stop. When using for 1-83 Precise Stop Function [1] or [2]: The frequency converter needs a Precise Stop signal before the value of 1-84 Precise Stop Counter Value is reached. If this is not supplied, the frequency converter will not stop when the value in 1-84 Precise Stop Counter Value is reached. Precise start, stop must be triggered by a Digital Input and is available for terminals 18 and 19.
[28]	Catch up	Increases reference value by percentage (relative) set in 3-12 Catch up/slow Down Value.
[29]	Slow down	Reduces reference value by percentage (relative) set in 3-12 Catch up/slow Down Value.
[30]	Counter input	Precise stop function in 1-83 Precise Stop Function acts as Counter stop or speed compensated counter stop with or without reset. The counter value must be set in 1-84 Precise Stop Counter Value.
[31]	Pulse edge triggered	Counts the number of pulse flanks per sample time. This gives a higher resolution at high frequencies, but is not as precise at lower frequencies. Use this pulse principle for encoders with very low resolution (e.g. 30 ppr). 
[32]	Pulse time based	Measures the duration between pulse flanks. This gives a higher resolution at lower frequencies, but is not as precise at higher frequencies. This principle has a cut-off frequency which makes it unsuited for encoders with very low resolutions (e.g. 30 ppr) at low speeds.

Illustration 3.33

		<p>a: very low encoder resolution b: standard encoder resolution</p> <p>Table 3.14</p> <p>Illustration 3.34</p>
[34]	Ramp bit 0	Enables a choice between one of the 4 ramps available, according to the table below.
[35]	Ramp bit 1	Same as Ramp bit 0.

Preset ramp bit	1	0
Ramp 1	0	0
Ramp 2	0	1
Ramp 3	1	0
Ramp 4	1	1

Table 3.15 Preset Ramp Bit

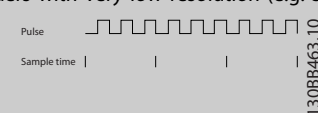
[40]	Latched Precise Start	A latched Precise Start only requires a pulse of 3ms on T18 or T19. When using for 1-83 [1] or [2]: When the reference is reached, the frequency converter will internally enable the Precise Stop signal. This means that the frequency converter will do the Precise Stop when the counter value of 1-84 Precise Stop Counter Value is reached.
[41]	Latched Precise Stop inverse	Sends a latched stop signal when the precise stop function is activated in 1-83 Precise Stop Function. The Latched Precise stop inverse function is available for terminals 18 or 19.
[51]	External interlock	This function makes it possible to give an external fault to the drive. This fault is treated in the same way as an internally generated alarm.
[55]	DigiPot Increase	INCREASE signal to the Digital Potentiometer function described in parameter group 3-9*
[56]	DigiPot Decrease	DECREASE signal to the Digital Potentiometer function described in parameter group 3-9*

[57]	DigiPot Clear	Clears the Digital Potentiometer reference described in parameter group 3-9*
[60]	Counter A	(Terminal 29 or 33 only) Input for increment counting in the SLC counter.
[61]	Counter A	(Terminal 29 or 33 only) Input for decrement counting in the SLC counter.
[62]	Reset Counter A	Input for reset of counter A.
[63]	Counter B	(Terminal 29 or 33 only) Input for increment counting in the SLC counter.
[64]	Counter B	(Terminal 29 or 33 only) Input for decrement counting in the SLC counter.
[65]	Reset Counter B	Input for reset of counter B.
[70]	Mech. Brake Feedback	Brake feedback for hoisting applications: Set 1-01 Motor Control Principle to [3] flux w/ motor feedback; set 1-72 Start Function to [6] Hoist mech brake Ref.
[71]	Mech. Brake Feedback inv.	Inverted brake feedback for hoisting applications
[72]	PID error inverse	When enabled, it inverts the resulting error from the process PID controller. Available only if "Configuration Mode" is set to "Surface Winder", "Extended PID Speed OL" or "Extended PID Speed CL".
[73]	PID reset I-part	When enabled, resets the I-part of the Process PID controller. Equivalent to 7-40 Process PID I-part Reset. Available only if "Configuration Mode" is set to "Surface Winder", "Extended PID Speed OL" or "Extended PID Speed CL".
[74]	PID enable	When enabled, enables the extended process PID controller. Equivalent to 7-50 Process PID Extended PID. Available only if "Configuration Mode" is set "Extended PID Speed OL" or "Extended PID Speed CL".
[80]	PTC Card 1	All Digital Inputs can be set to PTC Card 1 [80]. However, only one Digital Input must be set to this choice.
[91]	Profidrive OFF2	The functionality is the same as the according control word bit of the Profibus/Profinet option.
[92]	Profidrive OFF3	The functionality is the same as the according control word bit of the Profibus/Profinet option.
[98]	Start edge triggered	Edge triggered start command. Keeps the start command alive, even if the input is going back to low - can be used for a start push-button.
[100]	Safe Option Reset	

5-10 Terminal 18 Digital Input

Option: Function:

[8] *	Start	Functions are described under parameter group 5-1* Digital Inputs
-------	-------	---

5-11 Terminal 19 Digital Input

Option:		Function:
[10] *	Reversing	Functions are described under parameter group 5-1* <i>Digital Inputs</i>

5-12 Terminal 27 Digital Input

Option:		Function:
[2] *	Coast inverse	Functions are described under parameter group 5-1* <i>Digital Inputs</i>

5-13 Terminal 29 Digital Input

Option:		Function:
		Select the function from the available digital input range and the additional options [60], [61], [63] and [64]. Counters are used in Smart Logic Control functions. This parameter is available for FC 302 only.
[14] *	Jog	Functions are described under parameter group 5-1* <i>Digital Inputs</i>

5-14 Terminal 32 Digital Input

Option:		Function:
		Select the function from the available digital input range.
[0] *	No operation	Functions are described under 5-1* <i>Digital Inputs</i>

5-15 Terminal 33 Digital Input

Option:		Function:
		Select the function from the available digital input range and the additional options [60], [61], [63] and [64]. Counters are used in Smart Logic Control functions.
[0] *	No operation	Functions are described under 5-1* <i>Digital Inputs</i>

5-16 Terminal X30/2 Digital Input

Option:		Function:
[0] *	No operation	This parameter is active when option module MCB101 is installed in the frequency converter. Functions are described under 5-1* <i>Digital Inputs</i>

5-17 Terminal X30/3 Digital Input

Option:		Function:
[0] *	No operation	This parameter is active when option module MCB101 is installed in the frequency converter. Functions are described under 5-1* <i>Digital Inputs</i>

5-18 Terminal X30/4 Digital Input

Option:		Function:
[0] *	No operation	This parameter is active when option module MCB101 is installed in the frequency converter. Functions are described under 5-1* <i>Digital Inputs</i>

5-19 Terminal 37 Safe Stop

Option:		Function:
[1] *	Safe Stop Alarm	Coasts frequency converter when safe stop is activated. Manual reset from LCP, digital input or fieldbus.
[3]	Safe Stop Warning	Coasts frequency converter when safe stop is activated (T-37 off). When safe stop circuit is reestablished, the frequency converter will continue without manual reset.
[4]	PTC 1 Alarm	Coasts frequency converter when safe stop is activated. Manual reset from LCP, digital input or fieldbus. Choice 4 is only available when the MCB 112 PTC Thermistor Card is connected.
[5]	PTC 1 Warning	Coasts frequency converter when safe stop is activated (T-37 off). When safe stop circuit is reestablished, the frequency converter will continue without manual reset, unless a Digital Input set to PTC Card 1 [80] is still enabled. Choice 5 is only available when the MCB 112 PTC Thermistor Card is connected.
[6]	PTC 1 & Relay A	This choice is used when the PTC option is gated together with a Stop button through a Safety relay to T-37. Coasts frequency converter when safe stop is activated. Manual reset from LCP, digital input or fieldbus. Choice 6 is only available when the MCB 112 PTC Thermistor Card is connected.
[7]	PTC 1 & Relay W	This choice is used when the PTC option is gated together with a Stop button through a Safety relay to T-37. Coasts frequency converter when safe stop is activated (T-37 off). When safe stop circuit is reestablished, the frequency converter will continue without manual reset, unless a Digital Input set to PTC Card 1 [80] is (still) enabled. Choice 7 is only available when the MCB 112 PTC Thermistor Card is connected.
[8]	PTC 1 & Relay A/W	This choice makes it possible to use a combination of Alarm and Warning. Choice 8 is only available when the MCB 112 PTC Thermistor Card is connected.
[9]	PTC 1 & Relay W/A	This choice makes it possible to use a combination of Alarm and Warning. Choice 9 is only available when the MCB 112 PTC Thermistor Card is connected.

Choices 4 - 9 are only available when the MCB 112 PTC Thermistor Card is connected.

NOTE

When Auto Reset/Warning is selected the frequency converter opens up for automatic restart.

Function	No.	PTC	Relay
No Function	[0]	-	-
Safe Stop Alarm	[1]*	-	Safe Stop [A68]
Safe Stop Warning	[3]	-	Safe Stop [W68]
PTC 1 Alarm	[4]	PTC 1 Safe Stop [A71]	-
PTC 1 Warning	[5]	PTC 1 Safe Stop [W71]	-
PTC 1 & Relay A	[6]	PTC 1 Safe Stop [A71]	Safe Stop [A68]
PTC 1 & Relay W	[7]	PTC 1 Safe Stop [W71]	Safe Stop [W68]
PTC 1 & Relay A/W	[8]	PTC 1 Safe Stop [A71]	Safe Stop [W68]
PTC 1 & Relay W/A	[9]	PTC 1 Safe Stop [W71]	Safe Stop [A68]

Table 3.16 Overview of Functions, Alarms and Warnings

W means warning and A means alarm. For further information, see Alarms and Warnings in section Troubleshooting in the Design Guide or the Operating Instructions

A dangerous failure related to Safe Stop will give Alarm: Dangerous Failure [A72].

Refer to in *Table 5.3.*

5-20 Terminal X46/1 Digital Input

Option: **Function:**

[0] *	No operation	This parameter is active when option module MCB 113 is installed in the frequency converter. Functions are described under parameter group 5-1* Digital Inputs
-------	--------------	--

5-21 Terminal X46/3 Digital Input

Option: **Function:**

[0] *	No operation	This parameter is active when option module MCB 113 is installed in the frequency converter. Functions are described under parameter group 5-1* Digital Inputs
-------	--------------	--

5-22 Terminal X46/5 Digital Input

Option: **Function:**

[0] *	No operation	This parameter is active when option module MCB 113 is installed in the frequency converter. Functions are described under parameter group 5-1* Digital Inputs
-------	--------------	--

5-23 Terminal X46/7 Digital Input

Option: **Function:**

[0] *	No operation	This parameter is active when option module MCB 113 is installed in the frequency converter. Functions are described under parameter group 5-1* Digital Inputs
-------	--------------	--

5-24 Terminal X46/9 Digital Input

Option: **Function:**

[0] *	No operation	This parameter is active when option module MCB 113 is installed in the frequency converter. Functions are described under parameter group 5-1* Digital Inputs
-------	--------------	--

5-25 Terminal X46/11 Digital Input

Option: **Function:**

[0] *	No operation	This parameter is active when option module MCB 113 is installed in the frequency converter. Functions are described under parameter group 5-1* Digital Inputs
-------	--------------	--

5-26 Terminal X46/13 Digital Input

Option: **Function:**

[0] *	No operation	This parameter is active when option module MCB 113 is installed in the frequency converter. Functions are described under parameter group 5-1* Digital Inputs
-------	--------------	--

3.7.3 5-3* Digital Outputs

The 2 solid-state digital outputs are common for terminals 27 and 29. Set the I/O function for terminal 27 in *5-01 Terminal 27 Mode*, and set the I/O function for terminal 29 in *5-02 Terminal 29 Mode*.

NOTE

These parameters cannot be adjusted while the motor is running.

[0]	No operation	Default for all digital outputs and relay outputs
[1]	Control ready	The control card is ready. E.g.: Feedback from a frequency converter where the control is supplied by an external 24 V (MCB 107) and the main power to the unit is not detected.
[2]	Drive ready	The frequency converter is ready for operation and applies a supply signal on the control board.
[3]	Drive ready / remote control	The frequency converter is ready for operation and is in [Auto On] mode.
[4]	Enable / no warning	Ready for operation. No start or stop command is been given (start/disable). No warnings are active.
[5]	VLT running	Motor is running and shaft torque present.

[6]	Running / no warning	Output speed is higher than the speed set in 1-81 <i>Min Speed for Function at Stop [RPM]</i> . The motor is running and there are no warnings.
[7]	Run in range / no warning	Motor is running within the programmed current and speed ranges set in 4-50 <i>Warning Current Low</i> to 4-53 <i>Warning Speed High</i> . There are no warnings.
[8]	Run on reference / no warning	Motor runs at reference speed. No warnings.
[9]	Alarm	An alarm activates the output. There are no warnings.
[10]	Alarm or warning	An alarm or a warning activates the output.
[11]	At torque limit	The torque limit set in 4-16 <i>Torque Limit Motor Mode</i> or 4-17 <i>Torque Limit Generator Mode</i> has been exceeded.
[12]	Out of current range	The motor current is outside the range set in 4-18 <i>Current Limit</i> .
[13]	Below current, low	Motor current is lower than set in 4-50 <i>Warning Current Low</i> .
[14]	Above current, high	Motor current is higher than set in 4-51 <i>Warning Current High</i> .
[15]	Out of range	Output frequency is outside the frequency range set in 4-52 <i>Warning Speed Low</i> and 4-53 <i>Warning Speed High</i> .
[16]	Below speed, low	Output speed is lower than the setting in 4-52 <i>Warning Speed Low</i> .
[17]	Above speed, high	Output speed is higher than the setting in 4-53 <i>Warning Speed High</i> .
[18]	Out of feedback range	Feedback is outside the range set in 4-56 <i>Warning Feedback Low</i> and 4-57 <i>Warning Feedback High</i> .
[19]	Below feedback low	Feedback is below the limit set in 4-56 <i>Warning Feedback Low</i> .
[20]	Above feedback high	Feedback is above the limit set in 4-57 <i>Warning Feedback High</i> .
[21]	Thermal warning	The thermal warning turns on when the temperature exceeds the limit in the motor, the frequency converter, the brake resistor, or the thermistor.
[22]	Ready, no thermal warning	Frequency converter is ready for operation and there is no over-temperature warning.
[23]	Remote, ready, no thermal warning	Frequency converter is ready for operation and is in [Auto On] mode. There is no over-temperature warning.
[24]	Ready, no over-/ under voltage	Frequency converter is ready for operation and the mains voltage is within the specified voltage range (see <i>General Specifications</i> section in the Design Guide).
[25]	Reverse	The motor runs (or is ready to run) clockwise when logic=0 and counter clockwise when logic=1. The output

		changes as soon as the reversing signal is applied.
[26]	Bus OK	Active communication (no time-out) via the serial communication port.
[27]	Torque limit and stop	Use in performing a coasting stop and in torque limit condition. If the frequency converter has received a stop signal and is at the torque limit, the signal is Logic '0'.
[28]	Brake, no brake warning	Brake is active and there are no warnings.
[29]	Brake ready, no fault	Brake is ready for operation and there are no faults.
[30]	Brake fault (IGBT)	Output is Logic '1' when the brake IGBT is short-circuited. Use this function to protect the frequency converter if there is a fault on the brake modules. Use the output/relay to cut out the main voltage from the frequency converter.
[31]	Relay 123	Relay is activated when Control Word [0] is selected in parameter group 8-**.
[32]	Mechanical brake control	Enables control of an external mechanical brake, see description in the section <i>Control of Mechanical Brake</i> , and parameter group 2-2*
[33]	Safe stop activated (FC 302 only)	Indicates that the safe stop on terminal 37 has been activated.
[40]	Out of ref range	Active when the actual speed is outside settings in 4-52 <i>Warning Speed Low</i> to 4-55 <i>Warning Reference High</i> .
[41]	Below reference low	Active when actual speed is below speed reference setting.
[42]	Above reference high	Active when actual speed is above speed reference setting
[43]	Extended PID Limit	
[45]	Bus Ctrl	Controls output via bus. The state of the output is set in 5-90 <i>Digital & Relay Bus Control</i> . The output state is retained in the event of bus time-out.
[46]	Bus Ctrl On at timeout	Controls output via bus. The state of the output is set in 5-90 <i>Digital & Relay Bus Control</i> . In the event of bus time-out the output state is set high (On).
[47]	Bus Ctrl Off at timeout	Controls output via bus. The state of the output is set in 5-90 <i>Digital & Relay Bus Control</i> . In the event of bus time-out the output state is set low (Off).
[51]	MCO controlled	Active when a MCO 302 or MCO 305 is connected. The output is controlled from option.
[55]	Pulse output	
[60]	Comparator 0	See parameter group 13-1*. If Comparator 0 is evaluated as TRUE, the output will go high. Otherwise, it will be low.

[61]	Comparator 1	See parameter group 13-1*. If Comparator 1 is evaluated as TRUE, the output will go high. Otherwise, it will be low.
[62]	Comparator 2	See parameter group 13-1*. If Comparator 2 is evaluated as TRUE, the output will go high. Otherwise, it will be low.
[63]	Comparator 3	See parameter group 13-1*. If Comparator 3 is evaluated as TRUE, the output will go high. Otherwise, it will be low.
[64]	Comparator 4	See parameter group 13-1*. If Comparator 4 is evaluated as TRUE, the output will go high. Otherwise, it will be low.
[65]	Comparator 5	See parameter group 13-1*. If Comparator 5 is evaluated as TRUE, the output will go high. Otherwise, it will be low.
[70]	Logic Rule 0	See parameter group 13-4*. If Logic Rule 0 is evaluated as TRUE, the output will go high. Otherwise, it will be low.
[71]	Logic Rule 1	See parameter group 13-4*. If Logic Rule 1 is evaluated as TRUE, the output will go high. Otherwise, it will be low.
[72]	Logic Rule 2	See parameter group 13-4*. If Logic Rule 2 is evaluated as TRUE, the output will go high. Otherwise, it will be low.
[73]	Logic Rule 3	See parameter group 13-4*. If Logic Rule 3 is evaluated as TRUE, the output will go high. Otherwise, it will be low.
[74]	Logic Rule 4	See parameter group 13-4*. If Logic Rule 4 is evaluated as TRUE, the output will go high. Otherwise, it will be low.
[75]	Logic Rule 5	See parameter group 13-4*. If Logic Rule 5 is evaluated as TRUE, the output will go high. Otherwise, it will be low.
[80]	SL Digital Output A	See 13-52 SL Controller Action. The output will go high whenever the Smart Logic Action [38] Set dig. out. A high is executed. The output will go low whenever the Smart Logic Action [32] Set dig. out. A low is executed.
[81]	SL Digital Output B	See 13-52 SL Controller Action. The input will go high whenever the Smart Logic Action [39] Set dig. out. B high is executed. The input will go low whenever the Smart Logic Action [33] Set dig. out. B low is executed.
[82]	SL Digital Output C	See 13-52 SL Controller Action. The input will go high whenever the Smart Logic Action [40] Set dig. out. C high is executed. The input will go low whenever the Smart Logic Action [34] Set dig. out. C low is executed.

[83]	SL Digital Output D	See 13-52 SL Controller Action. The input will go high whenever the Smart Logic Action [41] Set dig. out. D high is executed. The input will go low whenever the Smart Logic Action [35] Set dig. out. D low is executed.																								
[84]	SL Digital Output E	See 13-52 SL Controller Action. The input will go high whenever the Smart Logic Action [42] Set dig. out. E high is executed. The input will go low whenever the Smart Logic Action [36] Set dig. out. E low is executed.																								
[85]	SL Digital Output F	See 13-52 SL Controller Action. The input will go high whenever the Smart Logic Action [43] Set dig. out. F high is executed. The input will go low whenever the Smart Logic Action [37] Set dig. out. F low is executed.																								
[120]	Local reference active	<p>Output is high when 3-13 Reference Site = [2] Local or when 3-13 Reference Site = [0] Linked to hand auto at the same time as the LCP is in [Hand On] mode.</p> <table border="1"> <thead> <tr> <th>Reference site set in 3-13 Reference Site</th> <th>Local reference active [120]</th> <th>Remote reference active [121]</th> </tr> </thead> <tbody> <tr> <td>Reference site: Local 3-13 Reference Site [2]</td> <td>1</td> <td>0</td> </tr> <tr> <td>Reference site: Remote 3-13 Reference Site [1]</td> <td>0</td> <td>1</td> </tr> <tr> <td>Reference site: Linked to Hand/ Auto</td> <td></td> <td></td> </tr> <tr> <td>Hand</td> <td>1</td> <td>0</td> </tr> <tr> <td>Hand -> off</td> <td>1</td> <td>0</td> </tr> <tr> <td>Auto -> off</td> <td>0</td> <td>0</td> </tr> <tr> <td>Auto</td> <td>0</td> <td>1</td> </tr> </tbody> </table> <p>Table 3.17</p>	Reference site set in 3-13 Reference Site	Local reference active [120]	Remote reference active [121]	Reference site: Local 3-13 Reference Site [2]	1	0	Reference site: Remote 3-13 Reference Site [1]	0	1	Reference site: Linked to Hand/ Auto			Hand	1	0	Hand -> off	1	0	Auto -> off	0	0	Auto	0	1
Reference site set in 3-13 Reference Site	Local reference active [120]	Remote reference active [121]																								
Reference site: Local 3-13 Reference Site [2]	1	0																								
Reference site: Remote 3-13 Reference Site [1]	0	1																								
Reference site: Linked to Hand/ Auto																										
Hand	1	0																								
Hand -> off	1	0																								
Auto -> off	0	0																								
Auto	0	1																								
[121]	Remote reference active	Output is high when 3-13 Reference Site = Remote [1] or Linked to hand/auto [0] while the LCP is in [Auto on] mode. See above.																								
[122]	No alarm	Output is high when no alarm is present.																								
[123]	Start command active	Output is high when there is an active Start command (i.e. via digital input bus connection or [Hand on] or [Auto on]), and no Stop or Start command is active.																								

[124]	Running reverse	Output is high when the frequency converter is running counter clockwise (the logical product of the status bits 'running' AND 'reverse').
[125]	Drive in hand mode	Output is high when the frequency converter is in [Hand on] mode (as indicated by the LED light above [Hand on]).
[126]	Drive in auto mode	Output is high when the frequency converter is in [Hand on] mode (as indicated by the LED light above [Auto on]).
[151]	ATEX ETR cur. alarm	Selectable if <i>1-90 Motor Thermal Protection</i> is set to [20] or [21]. If the alarm 164 ATEX ETR cur.lim.alarm is active, the output will be 1.
[152]	ATEX ETR freq. alarm	Selectable if <i>1-90 Motor Thermal Protection</i> is set to [20] or [21]. If the alarm 166 ATEX ETR freq.lim.alarm is active, the output will be 1.
[153]	ATEX ETR cur. warning	Selectable if <i>1-90 Motor Thermal Protection</i> is set to [20] or [21]. If the alarm 163 ATEX ETR cur.lim.warning is active, the output will be 1.
[154]	ATEX ETR freq. warning	Selectable if <i>1-90 Motor Thermal Protection</i> is set to [20] or [21]. If the warning 165 ATEX ETR freq.lim.warning is active, the output will be 1.
[188]	AHF Capacitor Connect	The capacitors will be turned on at 20% (hysteresis of 50% gives an interval of 10% - 30%). The capacitors will be disconnected below 10%. The off delay is 10s and will restart if the nominal power goes above 10% during the delay. <i>5-80 AHF Cap Reconnect Delay</i> is used to guarantee a minimum off-time for the capacitors.
[189]	External fan control	The internal logics for the internal fan control is transferred to this output to make it possible to control an external fan (relevant for HP duct cooling).
[190]	Safe Function active	
[191]	Safe Opt. Reset req.	
[192]	RS Flipflop 0	See parameter group <i>13-1* Comparators</i>
[193]	RS Flipflop 1	See parameter group <i>13-1* Comparators</i>
[194]	RS Flipflop 2	See parameter group <i>13-1* Comparators</i>
[195]	RS Flipflop 3	See parameter group <i>13-1* Comparators</i>
[196]	RS Flipflop 4	See parameter group <i>13-1* Comparators</i>
[197]	RS Flipflop 5	See parameter group <i>13-1* Comparators</i>
[198]	RS Flipflop 6	See parameter group <i>13-1* Comparators</i>
[199]	RS Flipflop 7	See parameter group <i>13-1* Comparators</i>

5-30 Terminal 27 Digital Output
Option: **Function:**

[0] *	No operation	Functions are described under parameter group <i>5-3* Digital Outputs</i>
-------	--------------	---

5-31 Terminal 29 Digital Output
Option: **Function:**

[0] *	No operation	Functions are described under parameter group <i>5-3* Digital Outputs</i> This parameter only applies to FC 302
-------	--------------	--

5-32 Term X30/6 Digi Out (MCB 101)
Option: **Function:**

[0] *	No operation	This parameter is active when option module MCB 101 is mounted in the frequency converter. Functions are described under parameter group <i>5-3* Digital Outputs</i>
[1]	Control ready	
[2]	Drive ready	
[3]	Drive rdy/rem ctrl	
[4]	Enable / no warning	
[5]	VLT running	
[6]	Running / no warning	
[7]	Run in range/no warn	
[8]	Run on ref/no warn	
[9]	Alarm	
[10]	Alarm or warning	
[11]	At torque limit	
[12]	Out of current range	
[13]	Below current, low	
[14]	Above current, high	
[15]	Out of speed range	
[16]	Below speed, low	
[17]	Above speed, high	
[18]	Out of feedb. range	
[19]	Below feedback, low	
[20]	Above feedback, high	
[21]	Thermal warning	
[22]	Ready,no thermal W	
[23]	Remote,ready,no TW	
[24]	Ready, Voltage OK	
[25]	Reverse	
[26]	Bus OK	
[27]	Torque limit & stop	
[28]	Brake, no brake war	
[29]	Brake ready, no fault	
[30]	Brake fault (IGBT)	
[31]	Relay 123	
[32]	Mech brake ctrl	
[33]	Safe stop active	
[40]	Out of ref range	
[41]	Below reference, low	
[42]	Above ref, high	

5-32 Term X30/6 Digi Out (MCB 101)		
Option:	Function:	
[45]	Bus ctrl.	
[46]	Bus ctrl, 1 if timeout	
[47]	Bus ctrl, 0 if timeout	
[51]	MCO controlled	
[55]	Pulse output	
[60]	Comparator 0	
[61]	Comparator 1	
[62]	Comparator 2	
[63]	Comparator 3	
[64]	Comparator 4	
[65]	Comparator 5	
[70]	Logic rule 0	
[71]	Logic rule 1	
[72]	Logic rule 2	
[73]	Logic rule 3	
[74]	Logic rule 4	
[75]	Logic rule 5	
[80]	SL digital output A	
[81]	SL digital output B	
[82]	SL digital output C	
[83]	SL digital output D	
[84]	SL digital output E	
[85]	SL digital output F	
[120]	Local ref active	
[121]	Remote ref active	
[122]	No alarm	
[123]	Start command activ	
[124]	Running reverse	
[125]	Drive in hand mode	
[126]	Drive in auto mode	

5-33 Term X30/7 Digi Out (MCB 101)		
Option:	Function:	
[0] *	No operation	This parameter is active when option module option module MCB 101 is mounted in the frequency converter. Functions are described under parameter group 5-3* <i>Digital Outputs</i>
[1]	Control ready	
[2]	Drive ready	
[3]	Drive rdy/rem ctrl	
[4]	Enable / no warning	
[5]	VLT running	
[6]	Running / no warning	
[7]	Run in range/no warn	
[8]	Run on ref/no warn	
[9]	Alarm	
[10]	Alarm or warning	
[11]	At torque limit	
[12]	Out of current range	
[13]	Below current, low	
[14]	Above current, high	

5-33 Term X30/7 Digi Out (MCB 101)		
Option:	Function:	
[15]	Out of speed range	
[16]	Below speed, low	
[17]	Above speed, high	
[18]	Out of feedb. range	
[19]	Below feedback, low	
[20]	Above feedback, high	
[21]	Thermal warning	
[22]	Ready,no thermal W	
[23]	Remote,ready,no TW	
[24]	Ready, Voltage OK	
[25]	Reverse	
[26]	Bus OK	
[27]	Torque limit & stop	
[28]	Brake, no brake war	
[29]	Brake ready, no fault	
[30]	Brake fault (IGBT)	
[31]	Relay 123	
[32]	Mech brake ctrl	
[33]	Safe stop active	
[40]	Out of ref range	
[41]	Below reference, low	
[42]	Above ref, high	
[45]	Bus ctrl.	
[46]	Bus ctrl, 1 if timeout	
[47]	Bus ctrl, 0 if timeout	
[51]	MCO controlled	
[55]	Pulse output	
[60]	Comparator 0	
[61]	Comparator 1	
[62]	Comparator 2	
[63]	Comparator 3	
[64]	Comparator 4	
[65]	Comparator 5	
[70]	Logic rule 0	
[71]	Logic rule 1	
[72]	Logic rule 2	
[73]	Logic rule 3	
[74]	Logic rule 4	
[75]	Logic rule 5	
[80]	SL digital output A	
[81]	SL digital output B	
[82]	SL digital output C	
[83]	SL digital output D	
[84]	SL digital output E	
[85]	SL digital output F	
[120]	Local ref active	
[121]	Remote ref active	
[122]	No alarm	
[123]	Start command activ	
[124]	Running reverse	
[125]	Drive in hand mode	
[126]	Drive in auto mode	

3.7.4 5-4* Relays

Parameters for configuring the timing and the output functions for the relays.

3

5-40 Function Relay		
Array [9] (Relay 1 [0], Relay 2 [1], Relay 3 [2] (MCB 113), Relay 4 [3] (MCB 113), Relay 5 [4] (MCB 113), Relay 6 [5] (MCB 113), Relay 7 [6] (MCB 105), Relay 8 [7] (MCB 105), Relay 9 [8] (MCB 105))		
Option:		Function:
[0] *	No operation	All digital and relay outputs are default set to "No Operation".
[1]	Control ready	The control card is ready. E.g.: Feedback from a drive where the control is supplied by an external 24 V (MCB 107) and the main power to drive is not detected.
[2]	Drive ready	Drive is ready to operate. Mains and control supplies are OK.
[3]	Drive rdy/rem ctrl	The frequency converter is ready for operation and is in Auto On mode
[4]	Enable / no warning	Ready for operation. No start or stop commands have been applied (start/disable). No warnings are active.
[5]	VLT running	Motor is running, and shaft torque present.
[6]	Running / no warning	Output speed is higher than the speed set in <i>1-81 Min Speed for Function at Stop [RPM]</i> Min Speed for Function at Stop [RPM]. The motor is running and no warnings.
[7]	Run in range/no warn	Motor is running within the programmed current and speed ranges set in <i>4-50 Warning Current Low</i> and <i>4-53 Warning Speed High</i> . No warnings.
[8]	Run on ref/no warn	Motor runs at reference speed. No warnings.
[9]	Alarm	An alarm activates the output. No warnings
[10]	Alarm or warning	An alarm or a warning activates the output.
[11]	At torque limit	The torque limit set in <i>4-16 Torque Limit Motor Mode</i> or <i>4-17 Torque Limit Generator Mode</i> has been exceeded.
[12]	Out of current range	The motor current is outside the range set in <i>4-18 Current Limit</i> .
[13]	Below current, low	Motor current is lower than set in <i>4-50 Warning Current Low</i> .

5-40 Function Relay		
Array [9] (Relay 1 [0], Relay 2 [1], Relay 3 [2] (MCB 113), Relay 4 [3] (MCB 113), Relay 5 [4] (MCB 113), Relay 6 [5] (MCB 113), Relay 7 [6] (MCB 105), Relay 8 [7] (MCB 105), Relay 9 [8] (MCB 105))		
Option:		Function:
[14]	Above current, high	Motor current is higher than set in <i>4-51 Warning Current High</i> .
[15]	Out of speed range	Output speed/frequency is outside the frequency range set in <i>4-52 Warning Speed Low</i> and <i>4-53 Warning Speed High</i> .
[16]	Below speed, low	Output speed is lower than the setting in <i>4-52 Warning Speed Low</i>
[17]	Above speed, high	Output speed is higher than the setting in <i>4-53 Warning Speed High</i> .
[18]	Out of feedb. range	Feedback is outside the range set in <i>4-56 Warning Feedback Low</i> and <i>4-57 Warning Feedback High</i> .
[19]	Below feedback, low	Feedback is below the limit set in <i>4-56 Warning Feedback Low</i> .
[20]	Above feedback, high	Feedback is above the limit set in <i>4-57 Warning Feedback High</i> .
[21]	Thermal warning	Thermal warning turns on when the temperature exceeds the limit either in motor, frequency converter, brake resistor, or connected thermistor.
[22]	Ready,no thermal W	Frequency converter is ready for operation and there is no over-temperature warning.
[23]	Remote,ready,no TW	Frequency converter is ready for operation and is in Auto On mode. There is no over-temperature warning.
[24]	Ready, Voltage OK	Frequency converter is ready for operation and the mains voltage is within the specified voltage range (see General Specifications section in Design Guide).
[25]	Reverse	The motor runs (or is ready to run) clockwise when logic=0 and counter clockwise when logic=1. The output changes as soon as the reversing signal is applied.
[26]	Bus OK	Active communication (no time-out) via the serial communication port.
[27]	Torque limit & stop	Use in performing a coasted stop and frequency converter in torque limit condition. If the frequency converter has received a stop signal

5-40 Function Relay		
Array [9] (Relay 1 [0], Relay 2 [1], Relay 3 [2] (MCB 113), Relay 4 [3] (MCB 113), Relay 5 [4] (MCB 113), Relay 6 [5] (MCB 113), Relay 7 [6] (MCB 105), Relay 8 [7] (MCB 105), Relay 9 [8] (MCB 105))		
Option:		Function: and is in torque limit, the signal is Logic '0'.
[28]	Brake, no brake war	Brake is active and there are no warnings.
[29]	Brake ready, no fault	Brake is ready for operation and there are no faults.
[30]	Brake fault (IGBT)	Output is Logic '1' when the brake IGBT is short-circuited. Use this function to protect the frequency converter if there is a fault on the brake module. Use the digital output/relay to cut out the main voltage from the frequency converter.
[31]	Relay 123	Digital output/relay is activated when Control Word [0] is selected in parameter group 8-**.
[32]	Mech brake ctrl	Selection of mechanical brake control. When selected parameters in parameter group 2-2* are active. The output must be reinforced to carry the current for the coil in the brake. Usually solved by connecting an external relay to the selected digital output.
[33]	Safe stop active	(FC 302 only) Indicates that the safe stop on terminal 37 has been activated.
[36]	Control word bit 11	Activate relay 1 by control word from fieldbus. No other functional impact in the frequency converter. Typical application: controlling auxiliary device from fieldbus. The function is valid when FC profile [0] in <i>8-10 Control Word Profile</i> is selected.
[37]	Control word bit 12	Activate relay 2 FC 302 only) by control word from fieldbus. No other functional impact in the frequency converter. Typical application: controlling auxiliary device from fieldbus. The function is valid when FC profile [0] in <i>8-10 Control Word Profile</i> is selected.
[40]	Out of ref range	Active when the actual speed is outside settings in <i>4-52 Warning</i>

5-40 Function Relay		
Array [9] (Relay 1 [0], Relay 2 [1], Relay 3 [2] (MCB 113), Relay 4 [3] (MCB 113), Relay 5 [4] (MCB 113), Relay 6 [5] (MCB 113), Relay 7 [6] (MCB 105), Relay 8 [7] (MCB 105), Relay 9 [8] (MCB 105))		
Option:		Function: <i>Speed Low to 4-55 Warning Reference High.</i>
[41]	Below reference, low	Active when actual speed is below speed reference setting.
[42]	Above ref, high	Active when actual speed is above speed reference setting.
[45]	Bus ctrl.	Controls digital output/relay via bus. The state of the output is set in <i>5-90 Digital & Relay Bus Control</i> . The output state is retained in the event of bus time-out.
[46]	Bus ctrl, 1 if timeout	Controls output via bus. The state of the output is set in <i>5-90 Digital & Relay Bus Control</i> . In the event of bus time-out the output state is set high (On).
[47]	Bus ctrl, 0 if timeout	Controls output via bus. The state of the output is set in <i>5-90 Digital & Relay Bus Control</i> . In the event of bus time-out the output state is set low (Off).
[51]	MCO controlled	Active when a MCO 302 or MCO 305 is connected. The output is controlled from option.
[60]	Comparator 0	See parameter group 13-1* (Smart Logic Control). If Comparator 0 in SLC is TRUE, the output will go high. Otherwise, it will be low.
[61]	Comparator 1	See parameter group 13-1* (Smart Logic Control). If Comparator 1 in SLC is TRUE, the output will go high. Otherwise, it will be low.
[62]	Comparator 2	See parameter group 13-1* (Smart Logic Control). If Comparator 2 in SLC is TRUE, the output will go high. Otherwise, it will be low.
[63]	Comparator 3	See parameter group 13-1* (Smart Logic Control). If Comparator 3 in SLC is TRUE, the output will go high. Otherwise, it will be low.
[64]	Comparator 4	See parameter group 13-1* (Smart Logic Control). If Comparator 4 in SLC is TRUE, the output will go high. Otherwise, it will be low.
[65]	Comparator 5	See parameter group 13-1* <i>Smart Logic Control</i> . If Comparator 5 in SLC

5-40 Function Relay		
Array [9] (Relay 1 [0], Relay 2 [1], Relay 3 [2] (MCB 113), Relay 4 [3] (MCB 113), Relay 5 [4] (MCB 113), Relay 6 [5] (MCB 113), Relay 7 [6] (MCB 105), Relay 8 [7] (MCB 105), Relay 9 [8] (MCB 105))		
Option:		Function:
		is TRUE, the output will go high. Otherwise, it will be low.
[70]	Logic rule 0	See parameter group 13-4* <i>Smart Logic Control</i> . If Logic Rule 0 in SLC is TRUE, the output will go high. Otherwise, it will be low.
[71]	Logic rule 1	See parameter group 13-4* <i>Smart Logic Control</i> . If Logic Rule 1 in SLC is TRUE, the output will go high. Otherwise, it will be low.
[72]	Logic rule 2	See parameter group 13-4* <i>Smart Logic Control</i> . If Logic Rule 2 in SLC is TRUE, the output will go high. Otherwise, it will be low.
[73]	Logic rule 3	See parameter group 13-4* <i>Smart Logic Control</i> . If Logic Rule 3 in SLC is TRUE, the output will go high. Otherwise, it will be low.
[74]	Logic rule 4	See parameter group 13-4* <i>Smart Logic Control</i> . If Logic Rule 4 in SLC is TRUE, the output will go high. Otherwise, it will be low.
[75]	Logic rule 5	See parameter group 13-4* <i>Smart Logic Control</i> . If Logic Rule 5 in SLC is TRUE, the output will go high. Otherwise, it will be low.
[80]	SL digital output A	See 13-52 <i>SL Controller Action</i> . Output A is low on Smart Logic Action [32]. Output A is high on Smart Logic Action [38].
[81]	SL digital output B	See 13-52 <i>SL Controller Action</i> . Output B is low on Smart Logic Action [33]. Output B is high on Smart Logic Action [39].
[82]	SL digital output C	See 13-52 <i>SL Controller Action</i> . Output C is low on Smart Logic Action [34]. Output C is high on Smart Logic Action [40].
[83]	SL digital output D	See 13-52 <i>SL Controller Action</i> . Output D is low on Smart Logic Action [35]. Output D is high on Smart Logic Action [41].
[84]	SL digital output E	See 13-52 <i>SL Controller Action</i> . Output E is low on Smart Logic Action [36]. Output E is high on Smart Logic Action [42].

5-40 Function Relay																																			
Array [9] (Relay 1 [0], Relay 2 [1], Relay 3 [2] (MCB 113), Relay 4 [3] (MCB 113), Relay 5 [4] (MCB 113), Relay 6 [5] (MCB 113), Relay 7 [6] (MCB 105), Relay 8 [7] (MCB 105), Relay 9 [8] (MCB 105))																																			
Option:		Function:																																	
[85]	SL digital output F	See 13-52 <i>SL Controller Action</i> . Output F is low on Smart Logic Action [37]. Output F is high on Smart Logic Action [43].																																	
[120]	Local ref active	Output is high when 3-13 <i>Reference Site</i> = [2] Local or when 3-13 <i>Reference Site</i> = [0] Linked to hand auto at the same time as the LCP is in [Hand on] mode. <table border="1" data-bbox="1098 786 1449 1440"> <thead> <tr> <th>Reference site set in</th> <th>Local reference active</th> <th>Remote reference active</th> </tr> </thead> <tbody> <tr> <td>3-13 <i>Reference Site</i></td> <td>[120]</td> <td>[121]</td> </tr> <tr> <td>Reference site: Local</td> <td>1</td> <td>0</td> </tr> <tr> <td>3-13 <i>Reference Site</i> [2]</td> <td></td> <td></td> </tr> <tr> <td>Reference site: Remote</td> <td>0</td> <td>1</td> </tr> <tr> <td>3-13 <i>Reference Site</i> [1]</td> <td></td> <td></td> </tr> <tr> <td>Reference site: Linked to Hand/ Auto</td> <td></td> <td></td> </tr> <tr> <td>Hand</td> <td>1</td> <td>0</td> </tr> <tr> <td>Hand -> off</td> <td>1</td> <td>0</td> </tr> <tr> <td>Auto -> off</td> <td>0</td> <td>0</td> </tr> <tr> <td>Auto</td> <td>0</td> <td>1</td> </tr> </tbody> </table>	Reference site set in	Local reference active	Remote reference active	3-13 <i>Reference Site</i>	[120]	[121]	Reference site: Local	1	0	3-13 <i>Reference Site</i> [2]			Reference site: Remote	0	1	3-13 <i>Reference Site</i> [1]			Reference site: Linked to Hand/ Auto			Hand	1	0	Hand -> off	1	0	Auto -> off	0	0	Auto	0	1
Reference site set in	Local reference active	Remote reference active																																	
3-13 <i>Reference Site</i>	[120]	[121]																																	
Reference site: Local	1	0																																	
3-13 <i>Reference Site</i> [2]																																			
Reference site: Remote	0	1																																	
3-13 <i>Reference Site</i> [1]																																			
Reference site: Linked to Hand/ Auto																																			
Hand	1	0																																	
Hand -> off	1	0																																	
Auto -> off	0	0																																	
Auto	0	1																																	
[121]	Remote ref active	Output is high when 3-13 <i>Reference Site</i> = Remote [1] or Linked to hand/auto [0] while the LCP is in [Auto on] mode. See above.																																	
[122]	No alarm	Output is high when no alarm is present.																																	
[123]	Start command activ	Output is high when the Start command high (i.e. via digital input, bus connection or [Hand On] or [Auto On]), and a Stop has been last command.																																	
[124]	Running reverse	Output is high when the frequency converter is running counter clockwise (the logical product of the status bits 'running' AND 'reverse').																																	

Table 3.18

5-40 Function Relay		
Array [9] (Relay 1 [0], Relay 2 [1], Relay 3 [2] (MCB 113), Relay 4 [3] (MCB 113), Relay 5 [4] (MCB 113), Relay 6 [5] (MCB 113), Relay 7 [6] (MCB 105), Relay 8 [7] (MCB 105), Relay 9 [8] (MCB 105))		
Option:	Function:	
[125]	Drive in hand mode	Output is high when the frequency converter is in [Hand on] mode (as indicated by the LED light above [Hand on]).
[126]	Drive in auto mode	Output is high when the frequency converter is in 'Auto' mode (as indicated by LED on above [Auto on]).

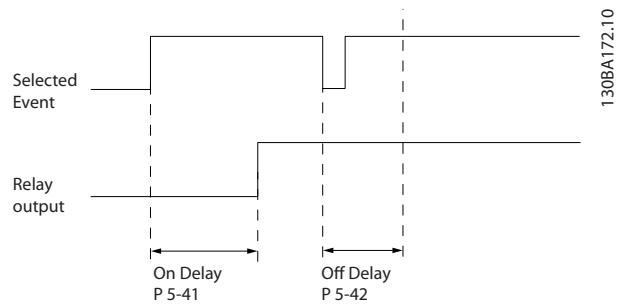

Illustration 3.36

If the selected Event condition changes before the on- or off delay timer expires, the relay output is unaffected.

5-41 On Delay, Relay		
Array [9], (Relay 1 [0], Relay 2 [1], Relay 3 [2], Relay 4 [3], Relay 5 [4], Relay 6 [5], Relay 7 [6], Relay 8 [7], Relay 9 [8])		
Range:	Function:	
0.01 s*	[0.01 - 600.00 s]	Enter the delay of the relay cut-in time. The relay will only cut in if the condition in 5-40 Function Relay is uninterrupted during the specified time. Select one of available mechanical relays and MCB 105 in an array function. See 5-40 Function Relay. Relay 3-6 are included in MCB 113.

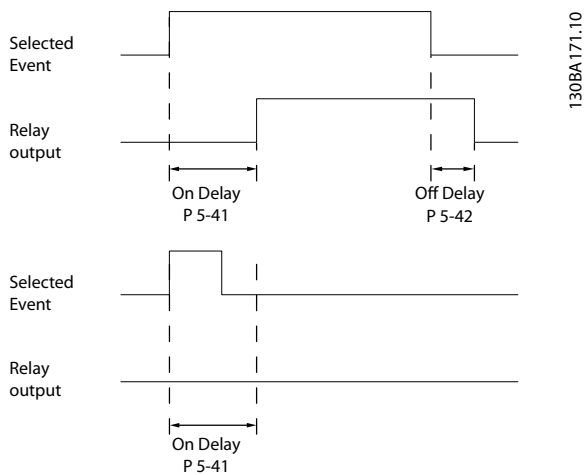

Illustration 3.35

5-42 Off Delay, Relay		
Array[2]: Relay1[0], Relay2[1]		
Range:	Function:	
0.01 s*	[0.01 - 600.00 s]	Enter the delay of the relay cut-out time. Select one of available mechanical relays and MCB 105 in an array function. See 5-40 Function Relay.

3.7.5 5-5* Pulse Input

The pulse input parameters are used to define an appropriate window for the impulse reference area by configuring the scaling and filter settings for the pulse inputs. Input terminals 29 or 33 act as frequency reference inputs. Set terminal 29 (5-13 Terminal 29 Digital Input) or terminal 33 (5-15 Terminal 33 Digital Input) to [32] Pulse input . If terminal 29 is used as an input, then set 5-01 Terminal 27 Mode to [0] Input.

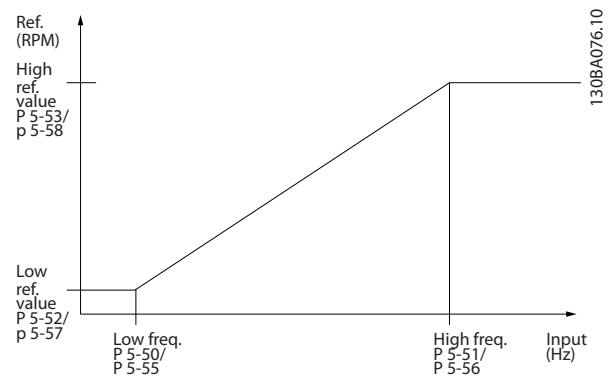

Illustration 3.37

5-50 Term. 29 Low Frequency		
Range:	Function:	
100 Hz*	[0 - 110000 Hz]	Enter the low frequency limit corresponding to the low motor shaft speed (i.e. low reference value) in 5-52 Term. 29 Low Ref./Feedb. Value. Refer to the diagram in this section. This parameter is available for FC 302 only.

5-51 Term. 29 High Frequency		
Range:		Function:
100 Hz*	[0 - 110000 Hz]	Enter the high frequency limit corresponding to the high motor shaft speed (i.e. high reference value) in 5-53 Term. 29 High Ref./Feedb. Value. This parameter is available for FC 302 only.

5-52 Term. 29 Low Ref./Feedb. Value		
Range:		Function:
0.000 Reference-FeedbackUnit*	[-999999.999 - 999999.999 ReferenceFeed-backUnit]	Enter the low reference value limit for the motor shaft speed [RPM]. This is also the lowest feedback value, see also 5-57 Term. 33 Low Ref./Feedb. Value. Set terminal 29 to digital input (5-02 Terminal 29 Mode =input [0] (default) and 5-13 Terminal 29 Digital Input = applicable value). This parameter is available for FC 302 only.

5-53 Term. 29 High Ref./Feedb. Value		
Range:		Function:
1500.000 ReferenceFeedbackUnit*	[-999999.999 - 999999.999 ReferenceFeed-backUnit]	Enter the high reference value [RPM] for the motor shaft speed and the high feedback value, see also 5-58 Term. 33 High Ref./Feedb. Value. Select terminal 29 as a digital input (5-02 Terminal 29 Mode = [0] input (default) and 5-13 Terminal 29 Digital Input = applicable value). This parameter is available for FC 302 only.

5-54 Pulse Filter Time Constant #29		
Range:		Function:
100 ms*	[1 - 1000 ms]	Enter the pulse filter time constant. The pulse filter dampens oscillations of the feedback signal, which is an advantage if there is a lot of noise in the system. A high time constant value results in better dampening but also increases the time delay through the filter. This parameter is available for FC 302 only. This parameter cannot be adjusted while the motor is running.

5-55 Term. 33 Low Frequency		
Range:		Function:
100 Hz*	[0 - 110000 Hz]	Enter the low frequency corresponding to the low motor shaft speed (i.e. low reference value) in 5-57 Term. 33 Low Ref./Feedb. Value.

5-56 Term. 33 High Frequency		
Range:		Function:
100 Hz*	[0 - 110000 Hz]	Enter the high frequency corresponding to the high motor shaft speed (i.e. high reference value) in 5-58 Term. 33 High Ref./Feedb. Value.

5-57 Term. 33 Low Ref./Feedb. Value		
Range:		Function:
0.000 *	[-999999.999 - 999999.999]	Enter the low reference value [RPM] for the motor shaft speed. This is also the low feedback value, see also 5-52 Term. 29 Low Ref./Feedb. Value.

5-58 Term. 33 High Ref./Feedb. Value		
Range:		Function:
1500.000 Reference-FeedbackUnit*	[-999999.999 - 999999.999 ReferenceFeed-backUnit]	Enter the high reference value [RPM] for the motor shaft speed. See also 5-53 Term. 29 High Ref./Feedb. Value.

5-59 Pulse Filter Time Constant #33		
Range:		Function:
100 ms*	[1 - 1000 ms]	Enter the pulse filter time constant. The low-pass filter reduces the influence on and dampens oscillations on the feedback signal from the control. This is an advantage, e.g. if there is a great amount on noise in the system.

NOTE

This parameter cannot be adjusted while the motor is running.

3.7.6 5-6* Pulse Outputs

These parameters are to configure pulse outputs with their functions and scaling. Terminal 27 and 29 are allocated to pulse output via 5-01 Terminal 27 Mode and 5-02 Terminal 29 Mode, respectively.

NOTE

These parameters cannot be adjusted while the motor is running.

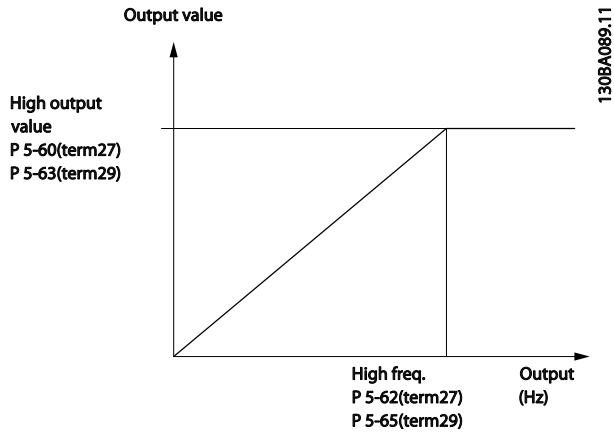

Illustration 3.38

Options for readout output variables:

		Parameters for configuring the scaling and output functions of pulse outputs. The pulse outputs are designated to terminals 27 or 29. Select terminal 27 output in <i>5-01 Terminal 27 Mode</i> and terminal 29 output in <i>5-02 Terminal 29 Mode</i> .
[0]	No operation	
[45]	Bus control	
[48]	Bus control time-out	
[51]	MCO controlled	
[100]	Output frequency	
[101]	Reference	
[102]	Feedback	
[103]	Motor current	
[104]	Torque relative to limit	
[105]	Torque relative to rated	
[106]	Power	
[107]	Speed	
[108]	Torque	
[109]	Max Out Freq	

5-60 Terminal 27 Pulse Output Variable		
Option:	Function:	
[0] *	No operation	Select the desired display output for terminal 27.
[45]	Bus ctrl.	
[48]	Bus ctrl., timeout	
[51]	MCO controlled	
[100]	Output frequency	
[101]	Reference	
[102]	Feedback	

5-60 Terminal 27 Pulse Output Variable		
Option:	Function:	
[103]	Motor current	
[104]	Torque rel to limit	
[105]	Torq relate to rated	
[106]	Power	
[107]	Speed	
[108]	Torque	
[109]	Max Out Freq	
[119]	Torque % lim	

5-62 Pulse Output Max Freq #27		
Range:	Function:	
5000. Hz*	[0 - 32000 Hz]	Set the maximum frequency for terminal 27, corresponding to the output variable selected in <i>5-60 Terminal 27 Pulse Output Variable</i> .

5-63 Terminal 29 Pulse Output Variable		
Option:	Function:	
[0] *	No operation	Select the desired display output for terminal 29. This parameter is available for FC 302 only.
[45]	Bus ctrl.	
[48]	Bus ctrl., timeout	
[51]	MCO controlled	
[100]	Output frequency	
[101]	Reference	
[102]	Feedback	
[103]	Motor current	
[104]	Torque rel to limit	
[105]	Torq relate to rated	
[106]	Power	
[107]	Speed	
[108]	Torque	
[109]	Max Out Freq	
[119]	Torque % lim	

5-65 Pulse Output Max Freq #29		
Range:	Function:	
5000 Hz*	[0 - 32000 Hz]	Set the maximum frequency for terminal 29 corresponding to the output variable set in <i>5-63 Terminal 29 Pulse Output Variable</i> .

5-66 Terminal X30/6 Pulse Output Variable		
Option:	Function:	
[0] *	No operation	
[45]	Bus ctrl.	
[48]	Bus ctrl., timeout	

5-66 Terminal X30/6 Pulse Output Variable

Select the variable for read-out on terminal X30/6.
 This parameter is active when option module MCB 101 is installed in the frequency converter.
 Same options and functions as parameter group 5-6*.

Option:	Function:
[51]	MCO controlled
[100]	Output frequency
[101]	Reference
[102]	Feedback
[103]	Motor current
[104]	Torque rel to limit
[105]	Torq relate to rated
[106]	Power
[107]	Speed
[108]	Torque
[109]	Max Out Freq
[119]	Torque % lim

NOTE

This parameter cannot be adjusted while the motor is running.

5-68 Pulse Output Max Freq #X30/6

Select the maximum frequency on terminal X30/6 referring to the output variable in 5-66 Terminal X30/6 Pulse Output Variable.
 This parameter is active when option module MCB 101 is mounted in the frequency converter.

Range:	Function:
5000. Hz*	[0 - 32000 Hz]

3.7.7 5-7* 24 V Encoder Input

Connect the 24 V encoder to terminal 12 (24 V DC supply), terminal 32 (Channel A), terminal 33 (Channel B), and terminal 20 (GND). The digital inputs 32/33 are active for encoder inputs when [1] 24 V encoder is selected in 1-02 Flux Motor Feedback Source and 7-00 Speed PID Feedback Source. The encoder used is a dual channel (A and B) 24 V type. Max input frequency: 110 kHz.

Encoder Connection to the frequency converter
 24 V incremental encoder. Max. cable length 5 m.

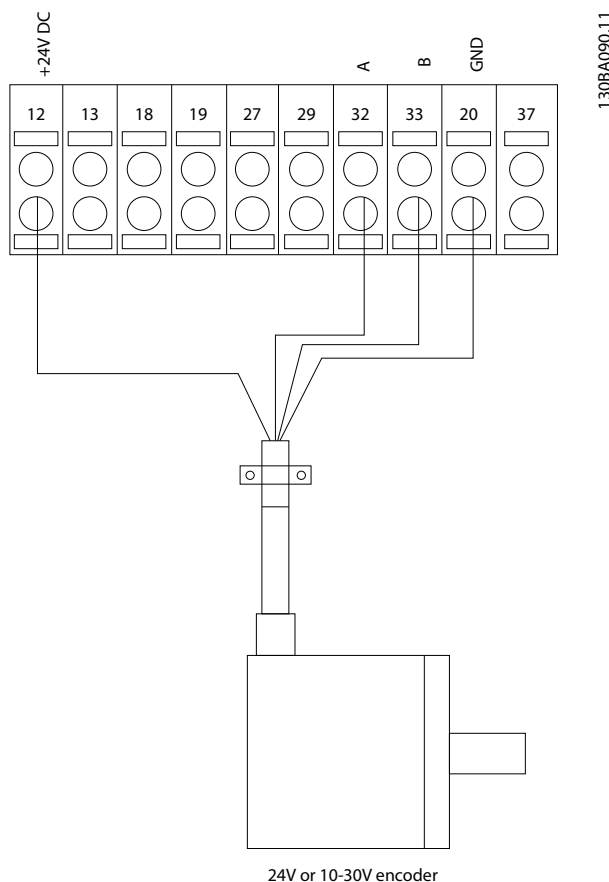

Illustration 3.39

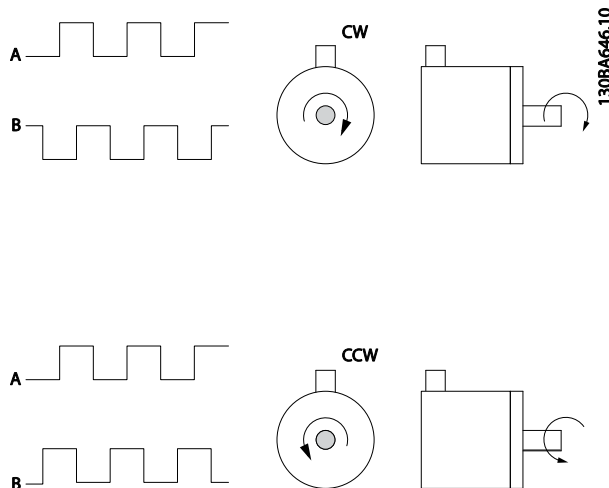

Illustration 3.40

5-70 Term 32/33 Pulses per Revolution

Range:	Function:
1024 N/A*	[1 - 4096 N/A] Set the encoder pulses per revolution on the motor shaft. Read the correct value from the encoder.

NOTE

This parameter cannot be adjusted while the motor is running.

5-71 Term 32/33 Encoder Direction		
Option:	Function:	
		Change the detected encoder rotation direction without changing the wiring to the encoder.
[0] *	Clockwise	Sets channel A 90° (electrical degrees) behind channel B upon clockwise rotation of the encoder shaft.
[1]	Counter clockwise	Sets channel A 90° (electrical degrees) ahead of channel B upon clockwise rotation of the encoder shaft.

NOTE

This parameter cannot be adjusted while the motor is running.

3.7.8 5-8* I/O Options

5-80 AHF Cap Reconnect Delay		
Range:	Function:	
25 s*	[1 - 120 s]	Guarantees a minimum off-time for the capacitors. The timer starts once the AHF capacitor disconnects and needs to expire before the output is allowed to be on again. It will only turn on again if the drive power is between 20% and 30%.

3.7.9 5-9*

This parameter group selects digital and relay outputs via a fieldbus setting.

5-90 Digital & Relay Bus Control		
Range:	Function:	
0 N/A*	[0 - 2147483647 N/A]	This parameter holds the state of the digital outputs and relays that is controlled by bus. A logical '1' indicates that the output is high or active. A logical '0' indicates that the output is low or inactive.

Bit 0	Digital Output Terminal 27
Bit 1	Digital Output Terminal 29
Bit 2	Digital Output Terminal X 30/6
Bit 3	Digital Output Terminal X 30/7
Bit 4	Relay 1 output terminal
Bit 5	Relay 2 output terminal
Bit 6	Option B Relay 1 output terminal
Bit 7	Option B Relay 2 output terminal
Bit 8	Option B Relay 3 output terminal
Bit 9-15	Reserved for future terminals
Bit 16	Option C Relay 1 output terminal
Bit 17	Option C Relay 2 output terminal
Bit 18	Option C Relay 3 output terminal
Bit 19	Option C Relay 4 output terminal
Bit 20	Option C Relay 5 output terminal
Bit 21	Option C Relay 6 output terminal
Bit 22	Option C Relay 7 output terminal
Bit 23	Option C Relay 8 output terminal
Bit 24-31	Reserved for future terminals

Table 3.19

5-93 Pulse Out #27 Bus Control		
Range:	Function:	
0.00 %*	[0.00 - 100.00 %]	Set the output frequency transferred to the output terminal 27 when the terminal is configured as [45] Bus Controlled in 5-60 Terminal 27 Pulse Output Variable.

5-94 Pulse Out #27 Timeout Preset		
Range:	Function:	
0.00 %*	[0.00 - 100.00 %]	Set the output frequency transferred to the output terminal 27 when the terminal is configured as [48] Bus Ctrl Timeout in 5-60 Terminal 27 Pulse Output Variable. And a time-out is detected.

5-95 Pulse Out #29 Bus Control		
Range:	Function:	
0.00 %*	[0.00 - 100.00 %]	Set the output frequency transferred to the output terminal 29 when the terminal is configured as [45] Bus Controlled in 5-63 Terminal 29 Pulse Output Variable. This parameter only applies for FC 302.

5-96 Pulse Out #29 Timeout Preset		
Range:	Function:	
0.00 %*	[0.00 - 100.00 %]	Set the output frequency transferred to the output terminal 29 when the terminal is configured as [48] Bus Ctrl Timeout in 5-63 Terminal 29 Pulse Output Variable. And a time-out is detected. This parameter only applies for FC 302.

5-97 Pulse Out #X30/6 Bus Control		
Range:		Function:
0 %*	[0 - 100 %]	Set the output frequency transferred to the output terminal X30/6 when the terminal is configured as 'Bus Controlled' in <i>5-66 Terminal X30/6 Pulse Output Variable</i> , Terminal X30/6 Pulse Output Variable [45].

5-98 Pulse Out #X30/6 Timeout Preset		
Range:		Function:
0 %*	[0 - 100 %]	Set the output frequency transferred to the output terminal X30/6 when the terminal is configured as [48] <i>Bus Ctrl Timeout</i> in <i>5-66 Terminal X30/6 Pulse Output Variable</i> . And a time-out is detected.

3.8 Parameters: 6-** Analog In/Out

3.8.1 6-0* Analog I/O Mode

The analog inputs can freely be allocated to be either voltage (FC 301: 0..10 V, FC 302: 0..± 10 V) or current (FC 301/FC 302: 0/4..20 mA) input.

NOTE

Thermistors may be connected to either an analog or a digital input.

6-00 Live Zero Timeout Time		
Range:	Function:	
10 s* [1 - 99 s]	Enter the Live Zero Time-out time period. Live Zero Time-out Time is active for analog inputs, i.e. terminal 53 or terminal 54, used as reference or feedback sources. If the reference signal value associated with the selected current input falls below 50% of the value set in 6-10 Terminal 53 Low Voltage, 6-12 Terminal 53 Low Current, 6-20 Terminal 54 Low Voltage or 6-22 Terminal 54 Low Current for a time period longer than the time set in 6-00 Live Zero Timeout Time, the function selected in 6-01 Live Zero Timeout Function will be activated.	

6-01 Live Zero Timeout Function		
Option:	Function:	
	Select the time-out function. The function set in 6-01 Live Zero Timeout Function will be activated if the input signal on terminal 53 or 54 is below 50% of the value in 6-10 Terminal 53 Low Voltage, 6-12 Terminal 53 Low Current, 6-20 Terminal 54 Low Voltage or 6-22 Terminal 54 Low Current for a time period defined in 6-00 Live Zero Timeout Time. If several time-outs occur simultaneously, the frequency converter prioritises the time-out functions as follows:	
	<ol style="list-style-type: none"> 1. 6-01 Live Zero Timeout Function 2. 8-04 Control Word Timeout Function 	
[0] *	Off	
[1]	Freeze output	Frozen at the present value
[2]	Stop	Overruled to stop
[3]	Jogging	Overruled to jog speed
[4]	Max. speed	Overruled to max. speed
[5]	Stop and trip	Overruled to stop with subsequent trip
[20]	Coast	
[21]	Coast and trip	

3.8.2 6-1* Analog Input 1

Parameters for configuring the scaling and limits for analog input 1 (terminal 53).

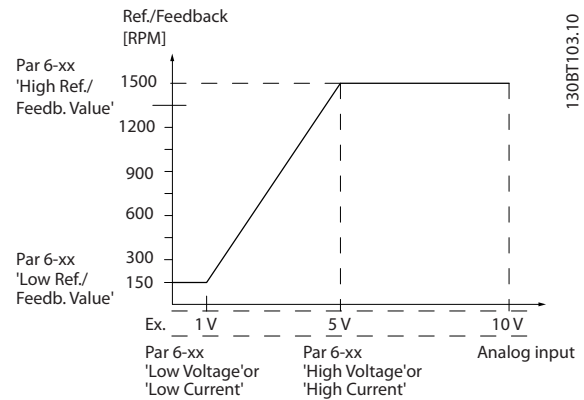

Illustration 3.41

6-10 Terminal 53 Low Voltage		
Range:	Function:	
0.07 V* [-10.00 - par. 6-11 V]	Enter the low voltage value. This analog input scaling value should correspond to the minimum reference value, set in 6-14 Terminal 53 Low Ref./Feedb. Value. See also the section Reference Handling.	

6-11 Terminal 53 High Voltage		
Range:	Function:	
10.00 V* [par. 6-10 - 10.00 V]	Enter the high voltage value. This analog input scaling value should correspond to the high reference/feedback value set in 6-15 Terminal 53 High Ref./Feedb. Value.	

6-12 Terminal 53 Low Current		
Range:	Function:	
0.14 mA* [0.00 - par. 6-13 mA]	Enter the low current value. This reference signal should correspond to the minimum reference value, set in 3-02 Minimum Reference. The value must be set at >2 mA in order to activate the Live Zero Time-out Function in 6-01 Live Zero Timeout Function.	

6-13 Terminal 53 High Current		
Range:	Function:	
20.00 mA* [par. 6-12 - 20.00 mA]	Enter the high current value corresponding to the high reference/feedback set in 6-15 Terminal 53 High Ref./Feedb. Value.	

6-14 Terminal 53 Low Ref./Feedb. Value		
Range:		Function:
0.000 *	[-999999.999 - 999999.999]	Enter the analog input scaling value that corresponds to the low voltage/low current set in <i>6-10 Terminal 53 Low Voltage</i> and <i>6-12 Terminal 53 Low Current</i> .

6-15 Terminal 53 High Ref./Feedb. Value		
Range:		Function:
1500.000 ReferenceFeedbackUnit*	[-999999.999 - 999999.999 ReferenceFeed-backUnit]	Enter the analog input scaling value that corresponds to the maximum reference feedback value set in <i>6-11 Terminal 53 High Voltage</i> and <i>6-13 Terminal 53 High Current</i> .

6-16 Terminal 53 Filter Time Constant		
Range:		Function:
0.001 s*	[0.001 - 10.000 s]	Enter the time constant. This is a first-order digital low pass filter time constant for suppressing electrical noise in terminal 53. A high time constant value improves dampening but also increases the time delay through the filter.

NOTE

This parameter cannot be adjusted while the motor is running.

3.8.3 6-2* Analog Input 2

Parameters for configuring the scaling and limits for analog input 2 (terminal 54).

6-20 Terminal 54 Low Voltage		
Range:		Function:
0.07 V*	[-10.00 - par. 6-21 V]	Enter the low voltage value. This analog input scaling value should correspond to the minimum reference value, set in <i>3-02 Minimum Reference</i> . See also <i>3.5 Parameters: 3-** Reference/Ramps</i> .

6-21 Terminal 54 High Voltage		
Range:		Function:
10.00 V*	[par. 6-20 - 10.00 V]	Enter the high voltage value. This analog input scaling value should correspond to the high reference/feedback value set in <i>6-25 Terminal 54 High Ref./Feedb. Value</i> .

6-22 Terminal 54 Low Current		
Range:		Function:
0.14 mA*	[0.00 - par. 6-23 mA]	Enter the low current value. This reference signal should correspond to the minimum reference value, set in <i>3-02 Minimum Reference</i> . The value must be set at >2 mA in order to activate the Live Zero Time-out Function in <i>6-01 Live Zero Timeout Function</i> .

6-23 Terminal 54 High Current		
Range:		Function:
20.00 mA*	[par. 6-22 - 20.00 mA]	Enter the high current value corresponding to the high reference/feedback value set in <i>6-25 Terminal 54 High Ref./Feedb. Value</i> .

6-24 Terminal 54 Low Ref./Feedb. Value		
Range:		Function:
0 ReferenceFeed-backUnit*	[-999999.999 - 999999.999 ReferenceFeed-backUnit]	Enter the analog input scaling value that corresponds to the minimum reference feedback value set in <i>3-02 Minimum Reference</i> .

6-25 Terminal 54 High Ref./Feedb. Value		
Range:		Function:
1500.000 ReferenceFeedbackUnit*	[-999999.999 - 999999.999 ReferenceFeed-backUnit]	Enter the analog input scaling value that corresponds to the maximum reference feedback value set in <i>3-03 Maximum Reference</i> .

6-26 Terminal 54 Filter Time Constant		
Range:		Function:
0.001 s*	[0.001 - 10.000 s]	Enter the time constant. This is a first-order digital low pass filter time constant for suppressing electrical noise in terminal 54. A high time constant value improves dampening but also increases the time delay through the filter.

NOTE

This parameter cannot be adjusted while the motor is running.

3.8.4 6-3* Analog Input 3 MCB 101

Parameter group for configuring the scale and limits for analog input 3 (X30/11) placed on option module MCB 101.

6-30 Terminal X30/11 Low Voltage		
Range:	Function:	
0.07 V* [0.00 - par. 6-31 V]	Sets the analog input scaling value to correspond to the low reference/feedback value (set in 6-34 Term. X30/11 Low Ref./Feedb. Value).	

6-31 Terminal X30/11 High Voltage		
Range:	Function:	
10.00 V* [par. 6-30 - 10.00 V]	Sets the analog input scaling value to correspond to the high reference/feedback value (set in 6-35 Term. X30/11 High Ref./Feedb. Value).	

6-34 Term. X30/11 Low Ref./Feedb. Value		
Range:	Function:	
0.000 * [-999999.999 - 999999.999]	Sets the analog input scaling value to correspond to the low voltage value (set in 6-30 Terminal X30/11 Low Voltage).	

6-35 Term. X30/11 High Ref./Feedb. Value		
Range:	Function:	
100.000 * [-999999.999 - 999999.999]	Sets the analog input scaling value to correspond to the high voltage value (set in 6-31 Terminal X30/11 High Voltage).	

6-36 Term. X30/11 Filter Time Constant		
Range:	Function:	
0.001 s* [0.001 - 10.000 s]	A 1 st order digital low pass filter time constant for suppressing electrical noise on terminal X30/11.	

NOTE

This parameter cannot be adjusted while the motor is running.

3.8.5 6-4* Analog Input 4 MCB 101

Parameter group for configuring the scale and limits for analog input 4 (X30/12) placed on option module MCB 101.

6-40 Terminal X30/12 Low Voltage		
Range:	Function:	
0.07 V* [0.00 - par. 6-41 V]	Sets the analog input scaling value to correspond to the low reference/	

6-40 Terminal X30/12 Low Voltage		
Range:	Function:	
	feedback value set in 6-44 Term. X30/12 Low Ref./Feedb. Value.	

6-41 Terminal X30/12 High Voltage		
Range:	Function:	
10.00 V* [par. 6-40 - 10.00 V]	Sets the analog input scaling value to correspond to the high reference/feedback value set in 6-45 Term. X30/12 High Ref./Feedb. Value.	

6-44 Term. X30/12 Low Ref./Feedb. Value		
Range:	Function:	
0.000 * [-999999.999 - 999999.999]	Sets the analog output scaling value to correspond to the low voltage value set in 6-40 Terminal X30/12 Low Voltage.	

6-45 Term. X30/12 High Ref./Feedb. Value		
Range:	Function:	
100.000 * [-999999.999 - 999999.999]	Sets the analog input scaling value to correspond to the high voltage value set in 6-41 Terminal X30/12 High Voltage.	

6-46 Term. X30/12 Filter Time Constant		
Range:	Function:	
0.001 s* [0.001 - 10.000 s]	A 1 st order digital low pass filter time constant for suppressing electrical noise on terminal X30/12.	

NOTE

This parameter cannot be adjusted while the motor is running.

3.8.6 6-5* Analog Output 1

Parameters for configuring the scaling and limits for analog output 1, i.e. Terminal 42. Analog outputs are current outputs: 0/4 to 20 mA. Common terminal (terminal 39) is the same terminal and has the same electrical potential for analog common and digital common connection. Resolution on analog output is 12 bit.

6-50 Terminal 42 Output		
Option:	Function:	
	Select the function of Terminal 42 as an analog current output. Depending on the selection the output is either a 0-20 mA or 4-20 mA output. The current value can be read out in LCP in 16-65 Analog Output 42 [mA].	

6-50 Terminal 42 Output		
Option:	Function:	
[0] *	No operation	When no signal on the analog output.
[52]	MCO 0-20mA	
[53]	MCO 4-20mA	
[100]	Output frequency	0 Hz = 0 mA; 100 Hz = 20 mA.
[101]	Reference	3-00 Reference Range [Min - Max] 0% = 0 mA; 100% = 20 mA 3-00 Reference Range [-Max - Max] -100% = 0 mA; 0% = 10 mA; +100% = 20 mA
[102]	Feedback	
[103]	Motor current	Value is taken from 16-37 <i>Inv. Max. Current</i> . Inverter max. current (160% current) is equal to 20 mA. Example: Inverter norm current (11 kW) = 24 A. 160% = 38.4 A. Motor norm current = 22 A Read-out 11.46 mA. $\frac{20 \text{ mA} \times 22 \text{ A}}{38.4 \text{ A}} = 11.46 \text{ mA}$ In case the norm motor current is equal to 20 mA, the output setting of 6-52 Terminal 42 Output Max Scale is: $\frac{I_{VLT_Max} \times 100}{I_{Motor\ Norm}} = \frac{38.4 \times 100}{22} = 175 \%$
[104]	Torque rel to limit	The torque setting is related to setting in 4-16 <i>Torque Limit Motor Mode</i>
[105]	Torq relate to rated	The torque is related to the motor torque setting.
[106]	Power	Taken from 1-20 <i>Motor Power [kW]</i> .
[107]	Speed	Taken from 3-03 <i>Maximum Reference</i> . 20 mA = value in 3-03 <i>Maximum Reference</i>
[108]	Torque	Torque reference related to 160% torque.
[109]	Max Out Freq	0 Hz = 0 mA, 4-19 <i>Max Output Frequency</i> = 20 mA.
[119]	Torque % lim	
[130]	Output freq. 4-20mA	0 Hz = 4 mA, 100 Hz = 20 mA
[131]	Reference 4-20mA	3-00 Reference Range [Min-Max] 0% = 4 mA; 100% = 20 mA 3-00 Reference Range [-Max-Max] -100% = 4 mA; 0% = 12 mA; +100% = 20 mA
[132]	Feedback 4-20mA	
[133]	Motor cur. 4-20mA	Value is taken from 16-37 <i>Inv. Max. Current</i> . Inverter max. current (160% current) is equal to 20 mA.

6-50 Terminal 42 Output		
Option:	Function:	
		Example: Inverter norm current (11 kW) = 24 A. 160% = 38.4 A. Motor norm current = 22 A Read-out 11.46 mA. $\frac{16 \text{ mA} \times 22 \text{ A}}{38.4 \text{ A}} + 4 \text{ mA} = 13.17 \text{ mA}$ In case the norm motor current is equal to 20 mA, the output setting of 6-62 Terminal X30/8 Max. Scale is: $\frac{I_{VLT_Max} \times 100}{I_{Motor\ Norm}} = \frac{38.4 \times 100}{22} = 175 \%$
[134]	Torq.% lim 4-20 mA	The torque setting is related to setting in 4-16 <i>Torque Limit Motor Mode</i> .
[135]	Torq.% nom 4-20 mA	The torque setting is related to the motor torque setting.
[136]	Power 4-20mA	Taken from 1-20 <i>Motor Power [kW]</i>
[137]	Speed 4-20mA	Taken from 3-03 <i>Maximum Reference</i> . 20 mA = Value in 3-03 <i>Maximum Reference</i> .
[138]	Torque 4-20mA	Torque reference related to 160% torque.
[139]	Bus ctrl. 0-20 mA	An output value set from fieldbus process data. The output will work independently of internal functions in the frequency converter.
[140]	Bus ctrl. 4-20 mA	An output value set from fieldbus process data. The output will work independently of internal functions in the frequency converter.
[141]	Bus ctrl 0-20mA t.o.	4-54 <i>Warning Reference Low</i> defines the behaviour of the analog output in case of bus time-out.
[142]	Bus ctrl 4-20mA t.o.	4-54 <i>Warning Reference Low</i> defines the behaviour of the analog output in case of bus time-out.
[149]	Torque % lim 4-20mA	Analog output at zero torque = 12 mA. Motoric torque will increase the output current to max torque limit 20 mA (set in 4-16 <i>Torque Limit Motor Mode</i>). Generative torque will decrease the output to torque limit Generator Mode (set in 4-17 <i>Torque Limit Generator Mode</i>) Ex: 4-16 <i>Torque Limit Motor Mode</i> : 200% and 4-17 <i>Torque Limit Generator Mode</i> : 200%. 20 mA = 200% Motoric and 4 mA = 200% Generatoric. Illustration 3.42

6-60 Terminal X30/8 Output		
Option:	Function:	
		Example: Inverter norm current (11 kW) = 24 A. 160% = 38.4 A. Motor norm current = 22 A Read-out 11.46 mA. $\frac{20 \text{ mA} \times 22 \text{ A}}{38.4 \text{ A}} = 11.46 \text{ mA}$ In case the norm motor current is equal to 20 mA, the output setting of 6-62 Terminal X30/8 Max. Scale is: $\frac{I_{VLT_Max} \times 100}{I_{Motor_Norm}} = \frac{38.4 \times 100}{22} = 175 \%$
[104]	Torque rel to limit	The torque setting is related to setting in 4-16 Torque Limit Motor Mode.
[105]	Torq relate to rated	The torque is related to the motor torque setting.
[106]	Power	Taken from 1-20 Motor Power [kW].
[107]	Speed	Taken from 3-03 Maximum Reference. 20 mA = value in 3-03 Maximum Reference
[108]	Torque	Torque reference related to 160% torque.
[109]	Max Out Freq	In relation to 4-19 Max Output Frequency.
[119]	Torque % lim	
[130]	Output freq. 4-20mA	0 Hz = 4 mA, 100 Hz = 20 mA
[131]	Reference 4-20mA	3-00 Reference Range [Min-Max] 0% = 4 mA; 100% = 20 mA 3-00 Reference Range [-Max-Max] -100% = 4 mA; 0% = 12 mA; +100% = 20 mA
[132]	Feedback 4-20mA	
[133]	Motor cur. 4-20mA	Value is taken from 16-37 Inv. Max. Current. Inverter max. current (160% current) is equal to 20 mA. Example: Inverter norm current (11 kW) = 24 A. 160% = 38.4 A. Motor norm current = 22 A Read-out 11.46 mA. $\frac{16 \text{ mA} \times 22 \text{ A}}{38.4 \text{ A}} = 9.17 \text{ mA}$ In case the norm motor current is equal to 20 mA, the output setting of 6-62 Terminal X30/8 Max. Scale is: $\frac{I_{VLT_Max} \times 100}{I_{Motor_Norm}} = \frac{38.4 \times 100}{22} = 175 \%$
[134]	Torq.% lim 4-20 mA	The torque setting is related to setting in 4-16 Torque Limit Motor Mode.
[135]	Torq.% nom 4-20 mA	The torque setting is related to the motor torque setting.

6-60 Terminal X30/8 Output		
Option:	Function:	
[136]	Power 4-20mA	Taken from 1-20 Motor Power [kW]
[137]	Speed 4-20mA	Taken from 3-03 Maximum Reference. 20 mA = Value in 3-03 Maximum Reference.
[138]	Torque 4-20mA	Torque reference related to 160% torque.
[139]	Bus ctrl. 0-20 mA	An output value set from fieldbus process data. The output will work independently of internal functions in the frequency converter.
[140]	Bus ctrl. 4-20 mA	An output value set from fieldbus process data. The output will work independently of internal functions in the frequency converter.
[141]	Bus ctrl 0-20mA t.o.	4-54 Warning Reference Low defines the behaviour of the analog output in case of bus time-out.
[142]	Bus ctrl 4-20mA t.o.	4-54 Warning Reference Low defines the behaviour of the analog output in case of bus time-out.
[149]	Torque % lim 4-20mA	Torque% Lim 4-20 mA: Torque reference. 3-00 Reference Range [Min-Max] 0% = 4 mA; 100% = 20 mA 3-00 Reference Range [-Max - Max] -100% = 4 mA; 0% = 12 mA; +100% = 20 mA
[150]	Max Out Fr 4-20mA	In relation to 4-19 Max Output Frequency.

6-61 Terminal X30/8 Min. Scale		
Range:	Function:	
0.00 %* [0.00 - 200.00 %]	Scales the minimum output of the selected analog signal on terminal X30/8. Scale the minimum value as a percentage of the maximum signal value, i.e. 0 mA (or 0 Hz) is desired at 25% of the maximum output value and 25% is programmed. The value can never be higher than the corresponding setting in 6-62 Terminal X30/8 Max. Scale if value is below 100%. This parameter is active when option module MCB 101 is mounted in the frequency converter.	

6-62 Terminal X30/8 Max. Scale		
Range:	Function:	
100.00 %* [0.00 - 200.00 %]	Scales the maximum output of the selected analog signal on terminal X30/8. Scale the value to the desired maximum value of the current signal output. Scale the output to give a lower current than 20 mA at full scale or 20 mA at an output below 100% of the maximum signal value. If 20 mA is the desired output current at a value between 0 - 100% of the full-scale output, program the	

6-62 Terminal X30/8 Max. Scale		
Range:	Function:	
		percentage value in the parameter, i.e. 50% = 20 mA. If a current between 4 and 20 mA is desired at maximum output (100%), calculate the percentage value as follows:

$20 \text{ mA} / \text{desired maximum current} \times 100 \%$

i.e. $10 \text{ mA} : \frac{20 - 4}{10} \times 100 = 160 \%$

6-63 Terminal X30/8 Bus Control		
Range:	Function:	
0 %*	[0 - 100 %]	Holds the level of Output X30/8 if controlled by bus.

6-64 Terminal X30/8 Output Timeout Preset		
Range:	Function:	
0 %*	[0 - 100 %]	Holds the preset level of Output X30/8. In case of a bus timeout and a timeout function is selected in 6-60 Terminal X30/8 Output, the output will preset to this level.

3.8.8 6-7* Analog Output 3 MCB 113

Parameters for configuring the scaling and limits for analog output 3, Terminal X45/1 and X45/2. Analog outputs are current outputs: 0/4–20 mA. Resolution on analog output is 11 bit.

6-70 Terminal X45/1 Output		
Option:	Function:	
		Select the function of Terminal X45/1 as an analog current output.
[0]	No operation	When no signal on the analog output.
[52]	MCO 305 0-20 mA	
[53]	MCO 305 4-20 mA	
[100]	Output frequency 0-20 mA	0 Hz = 0 mA; 100 Hz = 20 mA.
[101]	Reference 0-20 mA	3-00 Reference Range [Min - Max] 0% = 0 mA; 100% = 20 mA 3-00 Reference Range [-Max - Max] -100% = 0 mA; 0% = 10 mA; +100% = 20 mA
[102]	Feedback	
[103]	Motor current 0-20 mA	Value is taken from 16-37 Inv. Max. Current. Inverter max. current (160% current) is equal to 20 mA. Example: Inverter norm current (11 kW) = 24 A. 160% = 38.4 A. Motor norm current = 22 A Read-out 11.46 mA. $\frac{20 \text{ mA} \times 22 \text{ A}}{38.4 \text{ A}} = 11.46 \text{ mA}$

6-70 Terminal X45/1 Output		
Option:	Function:	
		In case the norm motor current is equal to 20 mA, the output setting of 6-52 Terminal 42 Output Max Scale is: $\frac{I_{VLT_Max} \times 100}{I_{Motor_Norm}} = \frac{38.4 \times 100}{22} = 175 \%$
[104]	Torque rel to lim 0-20 mA	The torque setting is related to setting in 4-16 Torque Limit Motor Mode
[105]	Torque rel to rated motor torque 0-20 mA	The torque is related to the motor torque setting.
[106]	Power 0-20 mA	Taken from 1-20 Motor Power [kW].
[107]	Speed 0-20 mA	Taken from 3-03 Maximum Reference. 20 mA = value in 3-03 Maximum Reference
[108]	Torque ref. 0-20 mA	Torque reference related to 160% torque.
[109]	Max Out Freq 0-20 mA	In relation to 4-19 Max Output Frequency.
[130]	Output freq. 4-20 mA	0 Hz = 4 mA, 100 Hz = 20 mA
[131]	Reference 4-20 mA	3-00 Reference Range [Min-Max] 0% = 4 mA; 100% = 20 mA 3-00 Reference Range [-Max-Max] -100% = 4 mA; 0% = 12 mA; +100% = 20 mA
[132]	Feedback 4-20 mA	
[133]	Motor cur. 4-20 mA	Value is taken from 16-37 Inv. Max. Current. Inverter max. current (160% current) is equal to 20 mA. Example: Inverter norm current (11 kW) = 24 A. 160% = 38.4 A. Motor norm current = 22 A Read-out 11.46 mA. $\frac{16 \text{ mA} \times 22 \text{ A}}{38.4 \text{ A}} = 9.17 \text{ mA}$ In case the norm motor current is equal to 20 mA, the output setting of 6-52 Terminal 42 Output Max Scale is: $\frac{I_{VLT_Max} \times 100}{I_{Motor_Norm}} = \frac{38.4 \times 100}{22} = 175 \%$
[134]	Torque% lim. 4-20 mA	The torque setting is related to setting in 4-16 Torque Limit Motor Mode.
[135]	Torque% nom 4-20 mA	The torque setting is related to the motor torque setting.
[136]	Power 4-20 mA	Taken from 1-20 Motor Power [kW]
[137]	Speed 4-20 mA	Taken from 3-03 Maximum Reference. 20 mA = Value in 3-03 Maximum Reference.

6-70 Terminal X45/1 Output

Option:	Function:
[138] Torque 4-20 mA	Torque reference related to 160% torque.
[139] Bus ctrl. 0-20 mA	An output value set from fieldbus process data. The output will work independently of internal functions in the frequency converter.
[140] Bus ctrl. 4-20 mA	An output value set from fieldbus process data. The output will work independently of internal functions in the frequency converter.
[141] Bus ctrl. 0-20 mA, timeout	4-54 <i>Warning Reference Low</i> defines the behaviour of the analog output in case of bus time-out.
[142] Bus ctrl. 4-20 mA, timeout	4-54 <i>Warning Reference Low</i> defines the behaviour of the analog output in case of bus time-out.
[150] Max Out Freq 4-20 mA	In relation to 4-19 <i>Max Output Frequency</i> .

6-71 Terminal X45/1 Output Min Scale

Range:	Function:
0.00%* [0.00 - 200.00%]	Scale the minimum output of the selected analog signal at terminal X45/1, as a percentage of the maximum signal value. E.g. if 0 mA (or 0 Hz) is desired at 25% of the maximum output value, then programme 25%. Scaling values up to 100% can never be higher than the corresponding setting in 6-72 <i>Terminal X45/1 Max. Scale</i> .

6-72 Terminal X45/1 Output Max Scale

Range:	Function:
100%* [0.00 - 200.00%]	Scale the maximum output of the selected analog signal at terminal X45/1. Set the value to the maximum value of the current signal output. Scale the output to give a current lower than 20 mA at full scale; or 20 mA at an output below 100% of the maximum signal value. If 20 mA is the desired output current at a value between 0 - 100% of the full-scale output, programme the percentage value in the parameter, i.e. 50% = 20 mA. If a current between 4 and 20 mA is desired at maximum output (100%), calculate the percentage value as follows (example where desired max. output is 10 mA):
	$\frac{I_{RANGE} [mA]}{I_{DESIRED MAX} [mA]} \times 100 \%$ $= \frac{20 - 4 mA}{10 mA} \times 100 \% = 160 \%$

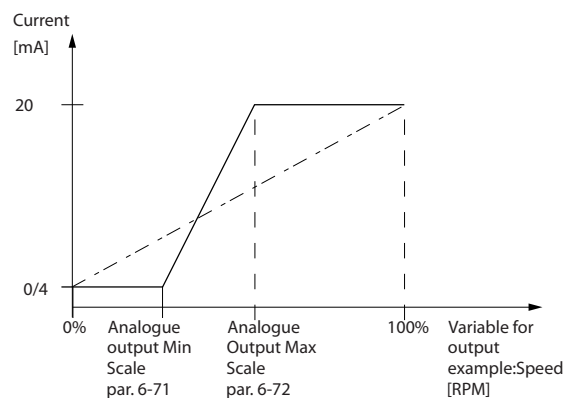

Illustration 3.44

130BA877.10

6-73 Terminal X45/1 Output Bus Control

Range:	Function:
0.00%* [0.00 - 100.00%]	Holds the level of Analog Output 3 (terminal X45/1) if controlled by bus.

6-74 Terminal X45/1 Output Timeout Preset

Range:	Function:
0.00%* [0.00 - 100.00%]	Holds the preset level of Analog Output 3 (terminal X45/1). In case of a bus timeout and a timeout function is selected in 6-70 <i>Terminal X45/1 Output</i> the output will preset to this level.

3.8.9 6-8* Analog Output 4 MCB 113

Parameters for configuring the scaling and limits for analog output 4. Terminal X45/3 and X45/4. Analog outputs are current outputs: 0/4 to 20 mA. Resolution on analog output is 11 bit.

6-80 Terminal X45/3 Output

Option:	Function:
[0] *	No operation
	Select the function of Terminal X45/3 as an analog current output.
	Same selections available as for 6-70 <i>Terminal X45/1 Output</i>

6-81 Terminal X45/3 Output Min Scale

Option:	Function:
[0.00%] * 0.00 - 200.00%	<p>Scales the minimum output of the selected analog signal on terminal X45/3. Scale the minimum value as a percentage of the maximum signal value, i.e. 0 mA (or 0 Hz) is desired at 25% of the maximum output value and 25% is programmed. The value can never be higher than the corresponding setting in <i>6-82 Terminal X45/3 Max. Scale</i> if value is below 100%.</p> <p>This parameter is active when option module MCB 113 is mounted in the frequency converter.</p>

6-82 Terminal X45/3 Output Max Scale

Option:	Function:
[0.00%] * 0.00 - 200.00%	<p>Scales the maximum output of the selected analog signal on terminal X45/3. Scale the value to the desired maximum value of the current signal output. Scale the output to give a lower current than 20 mA at full scale or 20 mA at an output below 100% of the maximum signal value. If 20 mA is the desired output current at a value between 0 - 100% of the full-scale output, program the percentage value in the parameter, i.e. 50% = 20 mA. If a current between 4 and 20 mA is desired at maximum output (100%), calculate the percentage value as follows (example where desired max. output is 10 mA):</p>
	$\frac{I_{RANGE} [mA]}{I_{DESIRED MAX} [mA]} \times 100 \%$ $= \frac{20 - 4 \text{ mA}}{10 \text{ mA}} \times 100 \% = 160 \%$

6-83 Terminal X45/3 Output Bus Control

Option:	Function:
[0.00%] * 0.00 - 100.00%	Holds the level of output 4 (X45/3) if controlled by bus.

6-84 Terminal X45/3 Output Timeout Preset

Option:	Function:
[0.00%] * 0.00 - 100.00%	Holds the present level of output 4 (X45/3). In case of a bus timeout and a timeout function is selected in <i>6-80 Terminal X45/3 Output</i> the output will preset to this level.

3.9 Parameters: 7-** Controllers

3.9.1 7-0* Speed PID Ctrl.

7-00 Speed PID Feedback Source		
Option:	Function:	
		Select the encoder for closed loop feedback. The feedback may come from a different encoder (typically mounted on the application itself) than the motor mounted encoder feedback selected in <i>1-02 Flux Motor Feedback Source</i> .
[0] *	Motor feedb. P1-02	
[1]	24V encoder	
[2]	MCB 102	
[3]	MCB 103	
[5]	MCO Encoder 2	
[6]	Analog input 53	
[7]	Analog input 54	
[8]	Frequency input 29	
[9]	Frequency input 33	

NOTE

This parameter cannot be adjusted while the motor is running.

NOTE

If separate encoders are used (FC 302 only) the ramp settings parameters in the following parameter groups: 3-4*, 3-5*, 3-6*, 3-7* and 3-8* must be adjusted according to the gear ratio between the two encoders.

7-02 Speed PID Proportional Gain		
Range:	Function:	
0 N/A*	[0.000 - 1.000 N/A]	Enter the speed controller proportional gain. The proportional gain amplifies the error (i.e. the deviation between the feedback signal and the set-point). This parameter is used with <i>1-00 Configuration Mode [0] Speed open loop</i> and <i>[1] Speed closed loop</i> control. Quick control is obtained at high amplification. However if the amplification is too great, the process may become unstable. Use this parameter for values with three decimals. For a selection with four decimals, use <i>3-83 Quick Stop S-ramp Ratio at Decel. Start</i> .

7-03 Speed PID Integral Time		
Range:	Function:	
8.0 ms*	[2.0 - 20000.0 ms]	Enter the speed controller integral time, which determines the time the internal PID control takes to correct errors. The greater the error, the more quickly the gain increases. The integral time causes a delay of the signal and therefore a dampening effect, and can be used to eliminate steady state speed error. Obtain quick control through a short integral time, though if the integral time is too short, the process becomes unstable. An excessively long integral time disables the integral action, leading to major deviations from the required reference, since the process regulator takes too long to regulate errors. This parameter is used with <i>[0] Speed open loop</i> and <i>[1] Speed closed loop</i> control, set in <i>1-00 Configuration Mode</i> .

7-04 Speed PID Differentiation Time		
Range:	Function:	
30.0 ms*	[0.0 - 200.0 ms]	Enter the speed controller differentiation time. The differentiator does not react to constant error. It provides gain proportional to the rate of change of the speed feedback. The quicker the error changes, the stronger the gain from the differentiator. The gain is proportional with the speed at which errors change. Setting this parameter to zero disables the differentiator. This parameter is used with <i>1-00 Configuration Mode [1] Speed closed loop</i> control.

7-05 Speed PID Diff. Gain Limit		
Range:	Function:	
5.0 N/A*	[1.0 - 20.0 N/A]	Set a limit for the gain provided by the differentiator. Since the differential gain increases at higher frequencies, limiting the gain may be useful. For example, set up a pure D-link at low frequencies and a constant D-link at higher frequencies. This parameter is used with <i>1-00 Configuration Mode [1] Speed closed loop</i> control.

7-06 Speed PID Lowpass Filter Time		
Range:	Function:	
10.0 ms*	[1.0 - 100.0 ms]	Set a time constant for the speed control low-pass filter. The low-pass filter improves steady-state performance and dampens oscillations on the feedback signal. This is an advantage if there is a great amount on noise in the system, see <i>Illustration 3.45</i> . For example, if a time constant (τ) of 100 ms is programmed, the cut-off frequency for the low-pass filter will be $1/0.1 = 10 \text{ RAD/s}$., corresponding to $(10/2 \times \pi) =$

7-06 Speed PID Lowpass Filter Time											
Range:	Function:										
	1.6 Hz. The PID regulator only regulates a feedback signal that varies by a frequency of less than 1.6 Hz. If the feedback signal varies by a higher frequency than 1.6 Hz, the PID regulator does not react. Practical settings of 7-06 Speed PID Lowpass Filter Time taken from the number of pulses per revolutions from encoder:										
	<table border="1"> <thead> <tr> <th>Encoder PPR</th> <th>7-06 Speed PID Lowpass Filter Time</th> </tr> </thead> <tbody> <tr> <td>512</td> <td>10 ms</td> </tr> <tr> <td>1024</td> <td>5 ms</td> </tr> <tr> <td>2048</td> <td>2 ms</td> </tr> <tr> <td>4096</td> <td>1 ms</td> </tr> </tbody> </table>	Encoder PPR	7-06 Speed PID Lowpass Filter Time	512	10 ms	1024	5 ms	2048	2 ms	4096	1 ms
Encoder PPR	7-06 Speed PID Lowpass Filter Time										
512	10 ms										
1024	5 ms										
2048	2 ms										
4096	1 ms										
	Table 3.21										

NOTE

Severe filtering can be detrimental to dynamic performance.
 This parameter is used with 1-00 Configuration Mode [1] Speed closed loop and [2] Torque control.
 The filter time in flux sensorless must be adjusted to 3-5 ms.

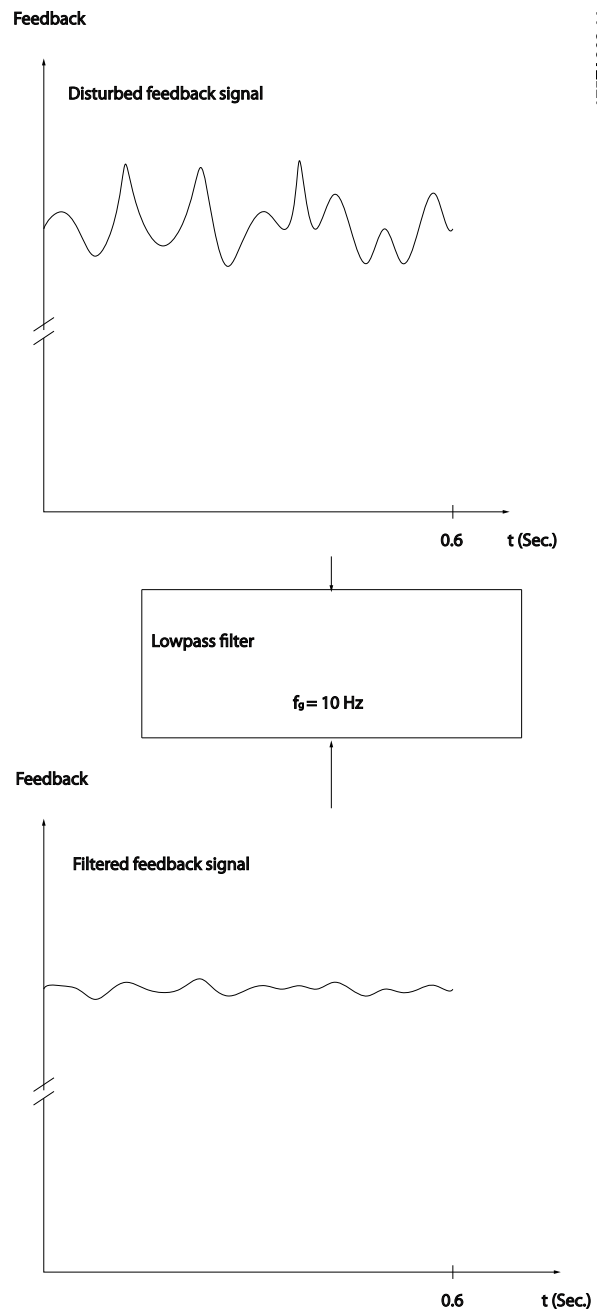

175ZA293.11

Illustration 3.45

7-07 Speed PID Feedback Gear Ratio	
Range:	Function:
1.0000 N/A*	[0.0001 - 32.0000 N/A]

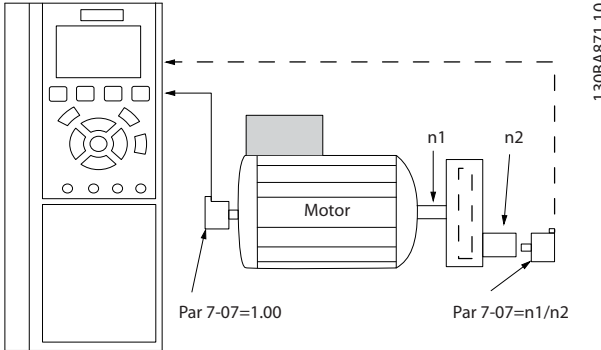

Illustration 3.46

7-08 Speed PID Feed Forward Factor	
Range:	Function:
0 %*	[0 - 500 %]
	The reference signal bypasses the speed controller by the amount specified. This feature increases the dynamic performance of the speed control loop.

7-09 Speed PID Error Correction w/ Ramp	
Range:	Function:
300 RPM*	[10 - 100000 RPM]
	The speed error between ramp and actual speed is held up against the setting in this parameter. If the speed error exceeds this parameter entry, the speed error will be corrected via ramping in a controlled way.

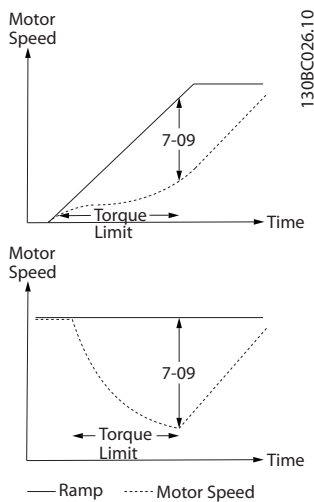

Illustration 3.47

3.9.2 7-1* Torque PI Control

Parameters for configuring the torque PI control in torque open loop (1-00 Configuration Mode).

7-12 Torque PI Proportional Gain	
Range:	Function:
100 %*	[0 - 500 %]
	Enter the proportional gain value for the torque controller. Selection of a high value makes the controller react faster. Too high a setting leads to controller instability.

7-13 Torque PI Integration Time	
Range:	Function:
0.020 s*	[0.002 - 2.000 s]
	Enter the integration time for the torque controller. Selection of a low value makes the controller react faster. Too low a setting leads to control instability.

3.9.3 7-2* Process Ctrl. Feedb.

Select the feedback sources for the Process PID Control, and how this feedback should be handled.

7-20 Process CL Feedback 1 Resource	
Option:	Function:
	The effective feedback signal is made up of the sum of up to two different input signals. Select which input should be treated as the source of the first of these signals. The second input signal is defined in 7-22 Process CL Feedback 2 Resource.
[0] *	No function
[1]	Analog input 53
[2]	Analog input 54
[3]	Frequency input 29
[4]	Frequency input 33
[7]	Analog input X30/11
[8]	Analog input X30/12

7-22 Process CL Feedback 2 Resource	
Option:	Function:
	The effective feedback signal is made up of the sum of up to two different input signals. Select which input should be treated as the source of the second of these signals. The first input signal is defined in 7-20 Process CL Feedback 1 Resource.
[0] *	No function
[1]	Analog input 53
[2]	Analog input 54

7-22 Process CL Feedback 2 Resource		
Option:	Function:	
[3]	Frequency input 29	
[4]	Frequency input 33	
[7]	Analog input X30/11	
[8]	Analog input X30/12	

3.9.4 7-3* Process PID Ctrl.

7-30 Process PID Normal/ Inverse Control		
Option:	Function:	
		Normal and inverse control are implemented by introducing a difference between the reference signal and the feedback signal.
[0] *	Normal	Sets process control to increase the output frequency.
[1]	Inverse	Sets process control to reduce the output frequency.

7-31 Process PID Anti Windup		
Option:	Function:	
[0]	Off	Continues regulation of an error even when the output frequency cannot be increased or decreased.
[1] *	On	Ceases regulation of an error when the output frequency can no longer be adjusted.

7-32 Process PID Start Speed		
Range:	Function:	
0 RPM*	[0 - 6000 RPM]	Enter the motor speed to be attained as a start signal for commencement of PID control. When the power is switched on, the will commence ramping and then operate under speed open loop control. Thereafter, when the Process PID start speed is reached, the will change over to Process PID control.

7-33 Process PID Proportional Gain		
Range:	Function:	
0.01 N/A*	[0.00 - 10.00 N/A]	Enter the PID proportional gain. The proportional gain multiplies the error between the set point and the feedback signal.

7-34 Process PID Integral Time		
Range:	Function:	
10000.00 s*	[0.01 - 10000.00 s]	Enter the PID integral time. The integrator provides an increasing gain at a constant error between the set point and the feedback signal. The integral time is the time needed by the integrator to reach the same gain as the proportional gain.

7-35 Process PID Differentiation Time		
Range:	Function:	
0.00 s*	[0.00 - 10.00 s]	Enter the PID differentiation time. The differentiator does not react to a constant error, but provides a gain only when the error changes. The shorter the PID differentiation time, the stronger the gain from the differentiator.

7-36 Process PID Diff. Gain Limit		
Range:	Function:	
5.0 N/A*	[1.0 - 50.0 N/A]	Enter a limit for the differentiator gain (DG). If there is no limit, the DG will increase when there are fast changes. Limit the DG to obtain a pure differentiator gain at slow changes and a constant differentiator gain where fast changes occur.

7-38 Process PID Feed Forward Factor		
Range:	Function:	
0 %*	[0 - 500 %]	Enter the PID feed forward (FF) factor. The FF factor sends a constant fraction of the reference signal to bypass the PID control, so the PID control only affects the remaining fraction of the control signal. Any change to this parameter will thus affect the motor speed. When the FF factor is activated it provides less overshoot, and high dynamics when changing the set point. <i>7-38 Process PID Feed Forward Factor is active when 1-00 Configuration Mode is set to [3] Process.</i>

7-39 On Reference Bandwidth		
Range:	Function:	
5 %*	[0 - 200 %]	Enter the On Reference bandwidth. When the PID Control Error (the difference between the reference and the feedback) is less than the set value of this parameter the On Reference status bit is high, i.e. =1.

3.9.5 7-4* Advanced Process PID Ctrl.

Parameter group 7-4* is only used if *1-00 Configuration Mode* is set to [7] *Extended PID speed CL* or [8] *Extended PID Speed OL*.

7-40 Process PID I-part Reset		
Option:	Function:	
[0] *	No	
[1]	Yes	Select [1] Yes to reset the I-part of the process PID controller. The selection will automatically revert to [0] No. Resetting the I-part makes it possible to start from a welldefined point after changing something in the process, e.g. changing a textile roll.

7-41 Process PID Output Neg. Clamp		
Range:	Function:	
-100 %* [-100 - par. 7-42 %]	Enter a negative limit for the process PID controller output.	

7-42 Process PID Output Pos. Clamp		
Range:	Function:	
100 %* [par. 7-41 - 100 %]	Enter a positive limit for the process PID controller output.	

7-43 Process PID Gain Scale at Min. Ref.		
Range:	Function:	
100 %* [0 - 100 %]	Enter a scaling percentage to apply to the process PID output when operating at the minimum reference. The scaling percentage will be adjusted linearly between the scale at min. ref. (7-43 Process PID Gain Scale at Min. Ref.) and the scale at max. ref. (7-44 Process PID Gain Scale at Max. Ref.).	

7-44 Process PID Gain Scale at Max. Ref.		
Range:	Function:	
100 %* [0 - 100 %]	Enter a scaling percentage to apply to the process PID output when operating at the maximum reference. The scaling percentage will be adjusted linearly between the scale at min. ref. (7-43 Process PID Gain Scale at Min. Ref.) and the scale at max. ref. (7-44 Process PID Gain Scale at Max. Ref.).	

7-45 Process PID Feed Fwd Resource		
Option:	Function:	
[0] * No function	Select which drive input should be used as the feed forward factor. The FF factor is added directly to the output of the PID controller. This increases dynamic performance.	
[1] Analog Input 53		
[2] Analog Input 54		
[7] Frequency input 29		
[8] Frequency input 33		
[11] Local bus reference		
[20] Digital pot.meter		
[21] Analog input X30-11		
[22] Analog input X30-12		
[29] Analog Input X48/2		
[32] Bus PCD	Selects a bus reference configured by 8-02 Control Word Source. Change 8-42 PCD Write Configuration for the bus used in order to make the feed-forward available in 7-48 PCD Feed Forward. Use index 1 for feed-forward [748] (and index 2 for reference [1682]).	

7-46 Process PID Feed Fwd Normal/ Inv. Ctrl.		
Option:	Function:	
[0] * Normal	Select [0] Normal to set the feed forward factor to treat the FF resource as a positive value.	
[1] Inverse	Select [1] Inverse to treat the FF resource as a negative value.	

7-48 PCD Feed Forward		
Range:	Function:	
0 * [0 - 65535]	Read-out parameter where the bus 7-45 Process PID Feed Fwd Resource [32]) can be read.	

7-49 Process PID Output Normal/ Inv. Ctrl.		
Option:	Function:	
[0] * Normal	Select [0] Normal to use the resulting output from the process PID controller as is.	
[1] Inverse	Select [1] Inverse to invert the resulting output from the process PID controller. This operation is performed after the feed forward factor is applied.	

3.9.6 7-5*Ext. Process PID Ctrl.

Parameter group 7-5* is only used if 1-00 Configuration Mode is set to [7] Extended PID speed CL or [8] Extended PID Speed OL.

7-50 Process PID Extended PID		
Option:	Function:	
[0] Disabled	Disables the extended parts of the process PID controller.	
[1] * Enabled	Enables the extended parts of the PID controller.	

7-51 Process PID Feed Fwd Gain		
Range:	Function:	
1 * [0 - 100]	The feed forward is used to obtain the desired level, based on a well-known signal available. The PID controller then only takes care of the smaller part of the control, necessary because of unknown characters. The standard feed fwd factor in 7-38 Process PID Feed Forward Factor is always related to the reference whereas 7-51 Process PID Feed Fwd Gain has more choices. In winder applications, the feed fwd factor will typically be the line speed of the system.	

7-52 Process PID Feed Fwd Ramp up		
Range:	Function:	
0.01 s* [0.01 - 10 s]	Controls the dynamics of the feed forward signal when ramping up.	

7-53 Process PID Feed Fwd Ramp down		
Range:		Function:
0.01 s*	[0.01 - 10 s]	Controls the dynamics of the feed forward signal when ramping down.

7-56 Process PID Ref. Filter Time		
Range:		Function:
0.001 s*	[0.001 - 1 s]	Set a time constant for the reference first order low-pass filter. The low-pass filter improves steady-state performance and dampens oscillations on the reference/ feedback signals. However severe filtering can be detrimental to dynamic performance.

7-57 Process PID Fb. Filter Time		
Range:		Function:
0.001 s*	[0.001 - 1 s]	Set a time constant for the feedback first order low-pass filter. The low-pass filter improves steady-state performance and dampens oscillations on the reference/ feedback signals. However severe filtering can be detrimental to dynamic performance.

3.10 Parameters: 8-** Communications and Options

3.10.1 8-0* General Settings

8-01 Control Site		
Option:	Function:	
		The setting in this parameter overrides the settings in <i>8-50 Coasting Select</i> to <i>8-56 Preset Reference Select</i> .
[0] *	Digital and ctrl.word	Control by using both digital input and control word.
[1]	Digital only	Control by using digital inputs only.
[2]	Controlword only	Control by using control word only.

8-02 Control Word Source		
Option:	Function:	
		Select the source of the control word: one of two serial interfaces or four installed options. During initial power-up, the frequency converter automatically sets this parameter to [3] <i>Option A</i> if it detects a valid fieldbus option installed in slot A. If the option is removed, the frequency converter detects a change in the configuration, sets <i>8-02 Control Word Source</i> back to default setting RS-485, and the frequency converter trips. If an option is installed after initial power-up, the setting of <i>8-02 Control Word Source</i> does not change, but the frequency converter trips and displays: <i>Alarm 67 Option Changed</i> . When retrofitting a bus option into a frequency converter, that did not have a bus option installed to begin with, take an ACTIVE decision to move the control to Bus based. This is done for safety reasons to avoid an accidental change.
[0]	None	
[1] *	FC RS485	
[2]	FC USB	
[3] *	Option A	
[4]	Option B	
[5]	Option C0	
[6]	Option C1	
[30]	External Can	

NOTE

This parameter cannot be adjusted while the motor is running.

8-03 Control Word Timeout Time		
Range:	Function:	
[1.0 s]	0.1-18000.0 s	Enter the maximum time expected to pass between the reception of two consecutive telegrams. If this time is exceeded, it indicates that the serial communication has stopped. The function selected in <i>8-04 Control Word Timeout Function</i> is then carried out. A

8-03 Control Word Timeout Time		
Range:	Function:	
20 s*	[0.1 - 18000.0 s]	valid control word triggers the time-out counter. Enter the maximum time expected to pass between the reception of two consecutive telegrams. If this time is exceeded, it indicates that the serial communication has stopped. The function selected in <i>8-04 Control Word Timeout Function</i> is then carried out. A valid control word triggers the time-out counter.

8-04 Control Word Timeout Function		
Option:	Function:	
		Select the time-out function. The time-out function activates when the control word fails to be updated within the time period specified in <i>8-03 Control Word Timeout Time</i> .
[0] *	Off	Resumes control via serial bus (fieldbus or standard) using the most recent control word.
[1]	Freeze output	Freezes output frequency until communication resumes.
[2]	Stop	Stops with auto restart when communication resumes.
[3]	Jogging	Runs the motor at JOG frequency until communication resumes.
[4]	Max. speed	Runs the motor at maximum frequency until communication resumes.
[5]	Stop and trip	Stops the motor, then resets the frequency converter to restart: via the fieldbus, via [Reset], or via a digital input.
[7]	Select setup 1	Changes the set-up upon reestablishment of communication following a control word time-out. If communication resumes after a time-out, <i>8-05 End-of-Timeout Function</i> defines whether to resume the set-up used before the time-out, or to retain the set-up endorsed by the time-out function.
[8]	Select setup 2	See [7] <i>Select setup 1</i>
[9]	Select setup 3	See [7] <i>Select setup 1</i>
[10]	Select setup 4	See [7] <i>Select setup 1</i>

NOTE

To change the set-up after a time-out, the following configuration is required:
Set *0-10 Active Set-up* to [9] *Multi set-up* and select the relevant link in *0-12 This Set-up Linked to*.

8-05 End-of-Timeout Function		
Option:	Function:	
		Select the action after receiving a valid control word following a time-out. This parameter is active only when 8-04 Control Timeout Function is set to [7] Set-up 1, [8] Set-up 2, [9] Set-up 3 or [10] Set-up 4.
[0]	Hold set-up	Retains the set-up selected in 8-04 Control Timeout Function and displays a warning, until 8-06 Reset Control Timeout toggles. Then the frequency converter resumes its original set-up.
[1] *	Resume set-up	Resumes the set-up active before the time-out.

8-06 Reset Control Word Timeout		
This parameter is active only when [0] Hold set-up has been selected in 8-05 End-of-Timeout Function.		
Option:	Function:	
[0] *	Do not reset	Retains the set-up specified in 8-04 Control Word Timeout Function, following a control word time-out.
[1]	Do reset	Returns the frequency converter to the original set-up following a control word time-out. The frequency converter performs the reset and then immediately reverts to the [0] Do not reset setting

3.10.2 8-1* Ctrl. Word Settings

8-10 Control Word Profile		
Select the interpretation of the control and status words corresponding to the installed fieldbus. Only the selections valid for the fieldbus installed in slot A will be visible in the LCP display.		
For guidelines in selection of [0] FC profile and [1] PROFIdrive profile please refer to the <i>Serial communication via RS-485 Interface</i> section in the Design Guide.		
For additional guidelines in the selection of [1] PROFIdrive profile, please refer to the Operating Instructions for the installed fieldbus.		
Option:	Function:	
[0] *	FC profile	
[1]	PROFIdrive profile	

8-13 Configurable Status Word STW		
Option:	Function:	
[0]	No function	The input is always low.
[1] *	Profile Default	Depended on the profile set in 8-10 Control Profile.
[2]	Alarm 68 Only	The input goes high whenever Alarm 68 is active and goes low whenever no alarm 68 is activated

8-13 Configurable Status Word STW		
Option:	Function:	
[3]	Trip excl Alarm 68	
[16]	T37 DI status	The input goes high whenever T37 has 0 V and goes low whenever T37 has 24 V

8-14 Configurable Control Word CTW		
Option:	Function:	
		Selection of control word bit 10 if it is active low or active high.
[0]	None	
[1] *	Profile default	
[2]	CTW Valid, active low	

8-19 Product Code		
Range:	Function:	
Size related*	[0 - 2147483647]	Select [0] to readout the actual fieldbus product code according to the mounted fieldbus option. Select [1] to readout the actual Vendor ID.

3.10.3 8-3* FC Port Settings

8-30 Protocol		
Option:	Function:	
		Select the protocol to be used. Changing protocol will not be effective until after powering off the frequency converter.
[0] *	FC	
[1]	FC MC	
[2]	Modbus RTU	

8-31 Address		
Range:	Function:	
Size related*	[1. - 255.]	Enter the address for the FC (standard) port. Valid range: 1-126.

8-32 FC Port Baud Rate		
Option:	Function:	
[0]	2400 Baud	Baud rate selection for the FC (standard) port.
[1]	4800 Baud	
[2] *	9600 Baud	
[3]	19200 Baud	
[4]	38400 Baud	
[5]	57600 Baud	
[6]	76800 Baud	
[7]	115200 Baud	

8-33 Parity / Stop Bits		
Option:	Function:	
[0] *	Even Parity, 1 Stop Bit	
[1]	Odd Parity, 1 Stop Bit	
[2]	No Parity, 1 Stop Bit	
[3]	No Parity, 2 Stop Bits	

8-35 Minimum Response Delay		
Range:	Function:	
10 ms* [1 - 10000. ms]	Specify the minimum delay time between receiving a request and transmitting a response. This is used for overcoming modem turnaround delays.	

8-36 Max Response Delay		
Range:	Function:	
10001. ms* [11. - 10001 ms]	Specify the maximum permissible delay time between transmitting a request and receiving a response. If a response from the frequency converter is exceeding the time setting then it will be discarded.	

8-37 Max Inter-Char Delay		
Range:	Function:	
25.00 ms* [0.00 - 35.00 ms]	Specify the maximum permissible time interval between receipt of two bytes. This parameter activates time-out if transmission is interrupted. This parameter is active only when 8-30 Protocol is set to [1] FC MC protocol.	

3.10.4 8-4* FC MC Protocol Set

8-40 Telegram selection		
Option:	Function:	
[1] *	Standard telegram 1	Enables use of freely configurable telegrams or standard telegrams for the FC port.
[101]	PPO 1	
[102]	PPO 2	
[103]	PPO 3	
[104]	PPO 4	
[105]	PPO 5	
[106]	PPO 6	
[107]	PPO 7	
[108]	PPO 8	
[200]	Custom telegram 1	Enables use of freely configurable telegrams or standard telegrams for the FC port.

8-41 Parameters for Signals		
Option:	Function:	
[0] *	None	This parameter contains a list of signals available for selection in 8-42 PCD Write Configuration and 8-43 PCD Read Configuration.
[15]	Readout: actual setup	
[302]	Minimum Reference	
[303]	Maximum Reference	
[312]	Catch up/slow Down Value	
[341]	Ramp 1 Ramp Up Time	
[342]	Ramp 1 Ramp Down Time	
[351]	Ramp 2 Ramp Up Time	
[352]	Ramp 2 Ramp Down Time	
[380]	Jog Ramp Time	
[381]	Quick Stop Ramp Time	
[411]	Motor Speed Low Limit [RPM]	
[412]	Motor Speed Low Limit [Hz]	
[413]	Motor Speed High Limit [RPM]	
[414]	Motor Speed High Limit [Hz]	
[416]	Torque Limit Motor Mode	
[417]	Torque Limit Generator Mode	
[590]	Digital & Relay Bus Control	
[593]	Pulse Out #27 Bus Control	
[595]	Pulse Out #29 Bus Control	
[597]	Pulse Out #X30/6 Bus Control	
[653]	Term 42 Output Bus Ctrl	
[663]	Terminal X30/8 Bus Control	
[673]	Terminal X45/1 Bus Control	
[683]	Terminal X45/3 Bus Control	
[748]	PCD Feed Forward	
[890]	Bus Jog 1 Speed	
[891]	Bus Jog 2 Speed	
[1472]	Legacy Alarm Word	
[1473]	Legacy Warning Word	
[1474]	Leg. Ext. Status Word	
[1500]	Operating hours	
[1501]	Running Hours	
[1502]	kWh Counter	
[1600]	Control Word	
[1601]	Reference [Unit]	
[1602]	Reference %	
[1603]	Status Word	
[1605]	Main Actual Value [%]	
[1609]	Custom Readout	
[1610]	Power [kW]	
[1611]	Power [hp]	
[1612]	Motor Voltage	
[1613]	Frequency	
[1614]	Motor current	
[1615]	Frequency [%]	
[1616]	Torque [Nm]	

8-41 Parameters for Signals		Function:
Option:		
[1617]	Speed [RPM]	
[1618]	Motor Thermal	
[1619]	KTY sensor temperature	
[1620]	Motor Angle	
[1621]	Torque [%] High Res.	
[1622]	Torque [%]	
[1625]	Torque [Nm] High	
[1630]	DC Link Voltage	
[1632]	Brake Energy /s	
[1633]	Brake Energy /2 min	
[1634]	Heatsink Temp.	
[1635]	Inverter Thermal	
[1638]	SL Controller State	
[1639]	Control Card Temp.	
[1648]	Speed Ref. After Ramp [RPM]	
[1650]	External Reference	
[1651]	Pulse Reference	
[1652]	Feedback[Unit]	
[1653]	Digi Pot Reference	
[1657]	Feedback [RPM]	
[1660]	Digital Input	
[1661]	Terminal 53 Switch Setting	
[1662]	Analog Input 53	
[1663]	Terminal 54 Switch Setting	
[1664]	Analog Input 54	
[1665]	Analog Output 42 [mA]	
[1666]	Digital Output [bin]	
[1667]	Freq. Input #29 [Hz]	
[1668]	Freq. Input #33 [Hz]	
[1669]	Pulse Output #27 [Hz]	
[1670]	Pulse Output #29 [Hz]	
[1671]	Relay Output [bin]	
[1672]	Counter A	
[1673]	Counter B	
[1674]	Prec. Stop Counter	
[1675]	Analog In X30/11	
[1676]	Analog In X30/12	
[1677]	Analog Out X30/8 [mA]	
[1678]	Analog Out X45/1 [mA]	
[1679]	Analog Out X45/3 [mA]	
[1680]	Fieldbus CTW 1	
[1682]	Fieldbus REF 1	
[1684]	Comm. Option STW	
[1685]	FC Port CTW 1	
[1686]	FC Port REF 1	
[1687]	Bus Readout Alarm/Warning	
[1690]	Alarm Word	
[1691]	Alarm Word 2	
[1692]	Warning Word	
[1693]	Warning Word 2	
[1694]	Ext. Status Word	
[1860]	Digital Input 2	

8-41 Parameters for Signals		Function:
Option:		
[3310]	Sync Factor Master	
[3311]	Sync Factor Slave	
[3401]	PCD 1 Write to MCO	
[3402]	PCD 2 Write to MCO	
[3403]	PCD 3 Write to MCO	
[3404]	PCD 4 Write to MCO	
[3405]	PCD 5 Write to MCO	
[3406]	PCD 6 Write to MCO	
[3407]	PCD 7 Write to MCO	
[3408]	PCD 8 Write to MCO	
[3409]	PCD 9 Write to MCO	
[3410]	PCD 10 Write to MCO	
[3421]	PCD 1 Read from MCO	
[3422]	PCD 2 Read from MCO	
[3423]	PCD 3 Read from MCO	
[3424]	PCD 4 Read from MCO	
[3425]	PCD 5 Read from MCO	
[3426]	PCD 6 Read from MCO	
[3427]	PCD 7 Read from MCO	
[3428]	PCD 8 Read from MCO	
[3429]	PCD 9 Read from MCO	
[3430]	PCD 10 Read from MCO	
[3440]	Digital Inputs	
[3441]	Digital Outputs	
[3450]	Actual Position	
[3451]	Commanded Position	
[3452]	Actual Master Position	
[3453]	Slave Index Position	
[3454]	Master Index Position	
[3455]	Curve Position	
[3456]	Track Error	
[3457]	Synchronizing Error	
[3458]	Actual Velocity	
[3459]	Actual Master Velocity	
[3460]	Synchronizing Status	
[3461]	Axis Status	
[3462]	Program Status	
[3464]	MCO 302 Status	
[3465]	MCO 302 Control	
[3470]	MCO Alarm Word 1	
[3471]	MCO Alarm Word 2	
[4280]	Safe Option Status	
[4285]	Active Safe Func.	
[4286]	Safe Option Info	

8-42 PCD Write Configuration		
Range:		Function:
Size related*	[0 - 9999]	Select the parameters to be assigned to PCD's telegrams. The number of available PCDs depends on the telegram type. The values in PCD's

8-42 PCD Write Configuration		
Range:	Function:	
		will then be written to the selected parameters as data values.

8-43 PCD Read Configuration		
Range:	Function:	
Size related*	[0 - 9999]	Select the parameters to be assigned to PCD's of the telegrams. The number of available PCDs depends on the telegram type. PCDs contain the actual data values of the selected parameters.

3.10.5 8-5* Digital/Bus

Parameters for configuring the control word Digital/Bus merging.

NOTE

These parameters are active only when 8-01 Control Site is set to [0] Digital and control word.

8-50 Coasting Select		
Option:	Function:	
		Select control of the coasting function via the terminals (digital input) and/or via the bus.
[0]	Digital input	Activates Start command via a digital input.
[1]	Bus	Activates Start command via the serial communication port or fieldbus option.
[2]	Logic AND	Activates Start command via the fieldbus/serial communication port, AND additionally via one of the digital inputs.
[3] *	Logic OR	Activates Start command via the fieldbus/serial communication port OR via one of the digital inputs.

8-51 Quick Stop Select		
Select control of the Quick Stop function via the terminals (digital input) and/or via the bus.		
Option:	Function:	
[0]	Digital input	
[1]	Bus	
[2]	Logic AND	
[3] *	Logic OR	

8-52 DC Brake Select		
Option:	Function:	
		Select control of the DC brake via the terminals (digital input) and/or via the fieldbus.

8-52 DC Brake Select		
Option:	Function:	
		NOTE Only selection [0] Digital input is available when 1-10 Motor Construction is set to [1] PM non-salient SPM.
[0]	Digital input	Activates Start command via a digital input.
[1]	Bus	Activates Start command via the serial communication port or fieldbus option.
[2]	Logic AND	Activates Start command via the fieldbus/serial communication port, AND additionally via one of the digital inputs.
[3] *	Logic OR	Activates Start command via the fieldbus/serial communication port OR via one of the digital inputs.

8-53 Start Select		
Option:	Function:	
		Select control of the frequency converter start function via the terminals (digital input) and/or via the fieldbus.
[0]	Digital input	Activates Start command via a digital input.
[1]	Bus	Activates Start command via the serial communication port or fieldbus option.
[2]	Logic AND	Activates Start command via the fieldbus/serial communication port, AND additionally via one of the digital inputs.
[3] *	Logic OR	Activates Start command via the fieldbus/serial communication port OR via one of the digital inputs.

8-54 Reversing Select		
Option:	Function:	
[0]	Digital input	Select control of the frequency converter reverse function via the terminals (digital input) and/or via the fieldbus.
[1]	Bus	Activates the Reverse command via the serial communication port or fieldbus option.
[2]	Logic AND	Activates the Reverse command via the fieldbus/serial communication port, AND additionally via one of the digital inputs.
[3] *	Logic OR	Activates the Reverse command via the fieldbus/serial communication port OR via one of the digital inputs.

8-55 Set-up Select		
Option:	Function:	
		Select control of the frequency converter set-up selection via the terminals (digital input) and/or via the fieldbus.
[0]	Digital input	Activates the set-up selection via a digital input.
[1]	Bus	Activates the set-up selection via the serial communication port or fieldbus option.
[2]	Logic AND	Activates the set-up selection via the fieldbus/serial communication port, AND additionally via one of the digital inputs.
[3] *	Logic OR	Activate the set-up selection via the fieldbus/serial communication port OR via one of the digital inputs.

8-56 Preset Reference Select		
Option:	Function:	
		Select control of the frequency converter Preset Reference selection via the terminals (digital input) and/or via the fieldbus.
[0]	Digital input	Activates Preset Reference selection via a digital input.
[1]	Bus	Activates Preset Reference selection via the serial communication port or fieldbus option.
[2]	Logic AND	Activates Preset Reference selection via the fieldbus/serial communication port, AND additionally via one of the digital inputs.
[3] *	Logic OR	Activates the Preset Reference selection via the fieldbus/serial communication port OR via one of the digital inputs.

8-57 Profdrive OFF2 Select		
Select control of the OFF2 selection via the terminals (digital input) and/or via the fieldbus. This parameter is active only when par. 8-01 Control Site is set to [0] Digital and ctrl. word and par. 8-10 is set to [1] Profdrive profile.		
Option:	Function:	
[0]	Digital input	
[1]	Bus	
[2]	Logic AND	
[3] *	Logic OR	

8-58 Profdrive OFF3 Select		
Select control of the OFF3 selection via the terminals (digital input) and/or via the fieldbus. This parameter is active only when par. 8-01 Control Site is set to [0] Digital and control word and par. 8-10 is set to [1] Profdrive profile.		
Option:	Function:	
[0]	Digital input	
[1]	Bus	
[2]	Logic AND	

8-58 Profdrive OFF3 Select		
Select control of the OFF3 selection via the terminals (digital input) and/or via the fieldbus. This parameter is active only when par. 8-01 Control Site is set to [0] Digital and control word and par. 8-10 is set to [1] Profdrive profile.		
Option:	Function:	
[3] *	Logic OR	

3.10.6 8-8* FC Port Diagnostics

These parameters are used for monitoring the Bus communication via the FC Port.

8-80 Bus Message Count		
Range:	Function:	
0 *	[0 - 0]	This parameter shows the number of valid telegrams detected on the bus.

8-81 Bus Error Count		
Range:	Function:	
0 *	[0 - 0]	This parameter shows the number of telegrams with faults (e.g. CRC fault), detected on the bus.

8-82 Slave Messages Rcvd		
Range:	Function:	
0 *	[0 - 0]	This parameter shows the number of valid telegrams addressed to the slave, sent by the frequency converter.

8-83 Slave Error Count		
Range:	Function:	
0 *	[0 - 0]	This parameter shows the number of error telegrams, which could not be executed by the frequency converter.

3.10.7 8-9* Bus Jog

8-90 Bus Jog 1 Speed		
Range:	Function:	
100 RPM*	[0 - par. 4-13 RPM]	Enter the jog speed. Activate this fixed jog speed via the serial port or fieldbus option.

8-91 Bus Jog 2 Speed		
Range:	Function:	
200 RPM*	[0 - par. 4-13 RPM]	Enter the jog speed. Activate this fixed jog speed via the serial port or fieldbus option.

3.11 Parameters: 9-** Profibus

For Profibus parameter descriptions, see the Profibus Operating Instructions.

3.12 Parameters: 10-** DeviceNet CAN Fieldbus

For Devicenet parameter descriptions, see the Devicenet Operating Instructions.

3.13 Parameters: 12-** Ethernet

For Ethernet parameter descriptions, see the Ethernet Operating Instructions.

3.14 Parameters: 13-** Smart Logic Control

3.14.1 Prog. Features

Smart Logic Control (SLC) is essentially a sequence of user defined actions (see 13-52 *SL Controller Action [x]*) executed by the SLC when the associated user defined event (see 13-51 *SL Controller Event [x]*) is evaluated as TRUE by the SLC.

The condition for an event can be a particular status or that the output from a Logic Rule or a Comparator Operand becomes TRUE. That will lead to an associated Action as illustrated:

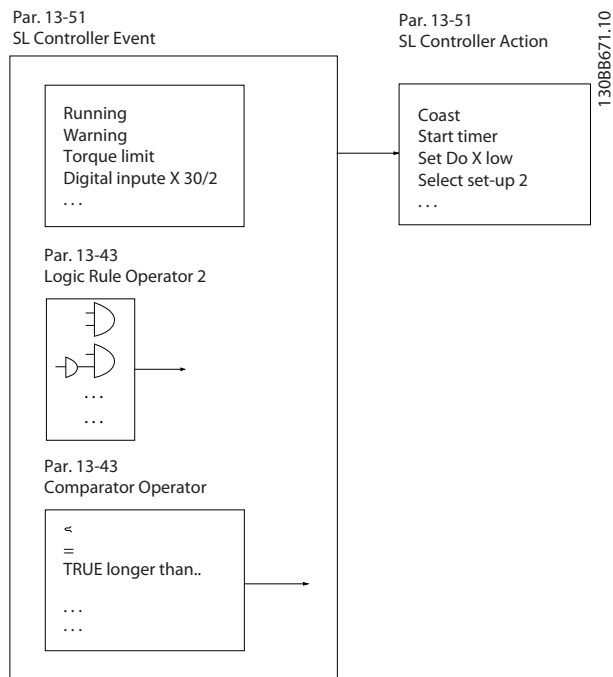

Illustration 3.48

Events and *actions* are each numbered and linked together in pairs (states). This means that when *event* [0] is fulfilled (attains the value TRUE), *action* [0] is executed. After this, the conditions of *event* [1] will be evaluated and if evaluated TRUE, *action* [1] will be executed and so on. Only one *event* will be evaluated at any time. If an *event* is evaluated as FALSE, nothing happens (in the SLC) during the current scan interval and no other *events* will be evaluated. This means that when the SLC starts, it evaluates *event* [0] (and only *event* [0]) each scan interval. Only when *event* [0] is evaluated TRUE, will the SLC execute *action* [0] and start evaluating *event* [1]. It is possible to programme from 1 to 20 *events* and *actions*. When the last *event/action* has been executed, the sequence starts over again from *event* [0]/*action* [0]. The illustration shows an example with three *event / actions*:

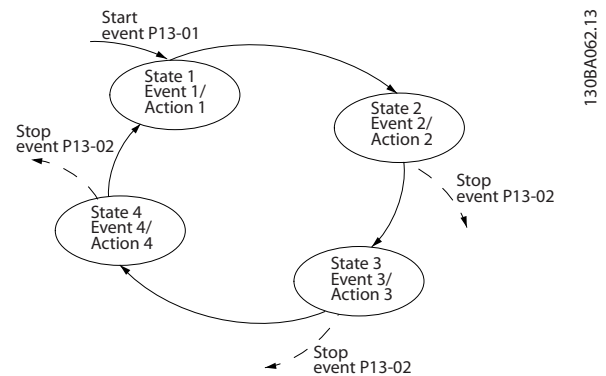

Illustration 3.49

Starting and stopping the SLC:

Starting and stopping the SLC can be done by selecting .On [1]. or .Off [0]. in 13-00 *SL Controller Mode*. The SLC always starts in state 0 (where it evaluates *event* [0]). The SLC starts when the Start Event (defined in 13-01 *Start Event*) is evaluated as TRUE (provided that On [1] is selected in 13-00 *SL Controller Mode*). The SLC stops when the Stop Event (13-02 *Stop Event*) is TRUE. 13-03 *Reset SLC* resets all SLC parameters and start programming from scratch.

NOTE

SLC is only active in AUTO mode, not Hand On mode

3.14.2 13-0* SLC Settings

Use the SLC settings to activate, deactivate and reset the Smart Logic Control sequence. The logic functions and comtors are always running in the background, which opens for sete control of digital inputs and outputs.

13-00 SL Controller Mode		
Option:	Function:	
[0]	Off	Disables the **Smart Logic Controller.
[1]	On	Enables the Smart Logic Controller.

13-01 Start Event		
Select the boolean (TRUE or FALSE) input to activate Smart Logic Control.		
Option:	Function:	
[0] *	False	Select the boolean (TRUE or FALSE) input to activate Smart Logic Control. Enters the fixed value - FALSE
[1]	True	Enters the fixed value - TRUE.
[2]	Running	The motor is running.
[3]	In range	The motor is running within the programmed current and speed ranges set in 4-50 <i>Warning Current Low</i> to 4-53 <i>Warning Speed High</i> .
[4]	On reference	The motor is running on reference.
[5]	Torque limit	The torque limit, set in 4-16 <i>Torque Limit Motor Mode</i> or 4-17 <i>Torque Limit Generator Mode</i> , has been exceeded.
[6]	Current limit	The motor current limit, set in 4-18 <i>Current Limit</i> , has been exceeded.
[7]	Out of current range	The motor current is outside the range set in 4-18 <i>Current Limit</i> .
[8]	Below I low	The motor current is lower than set in 4-50 <i>Warning Current Low</i> .
[9]	Above I high	The motor current is higher than set in 4-51 <i>Warning Current High</i> .
[10]	Out of speed range	The speed is outside the range set in 4-52 <i>Warning Speed Low</i> and 4-53 <i>Warning Speed High</i> .
[11]	Below speed low	The output speed is lower than the setting in 4-52 <i>Warning Speed Low</i> .
[12]	Above speed high	The output speed is higher than the setting in 4-53 <i>Warning Speed High</i> .
[13]	Out of feedb. range	The feedback is outside the range set in 4-56 <i>Warning Feedback Low</i> and 4-57 <i>Warning Feedback High</i> .
[14]	Below feedb. low	The feedback is below the limit set in 4-56 <i>Warning Feedback Low</i> .
[15]	Above feedb. high	The feedback is above the limit set in 4-57 <i>Warning Feedback High</i> .
[16]	Thermal warning	The thermal warning turns on when the temperature exceeds the limit in the motor, the frequency converter, the brake resistor or the thermistor.

13-01 Start Event		
Select the boolean (TRUE or FALSE) input to activate Smart Logic Control.		
Option:	Function:	
[17]	Mains out of range	The mains voltage is outside the specified voltage range.
[18]	Reversing	The output is high when the frequency converter is running counter clockwise (the logical product of the status bits "running" AND "reverse").
[19]	Warning	A warning is active.
[20]	Alarm (trip)	A (trip) alarm is active.
[21]	Alarm (trip lock)	A (Trip lock) alarm is active.
[22]	Comparator 0	Use the result of comparator 0.
[23]	Comparator 1	Use the result of comparator 1.
[24]	Comparator 2	Use the result of comparator 2.
[25]	Comparator 3	Use the result of comparator 3.
[26]	Logic rule 0	Use the result of logic rule 0.
[27]	Logic rule 1	Use the result of logic rule 1.
[28]	Logic rule 2	Use the result of logic rule 2.
[29]	Logic rule 3	Use the result of logic rule 3.
[33]	Digital input DI18	Use the result of digital input 18.
[34]	Digital input DI19	Use the result of digital input 19.
[35]	Digital input DI27	Use the result of digital input 27.
[36]	Digital input DI29	Use the result of digital input 29.
[37]	Digital input DI32	Use the result of digital input 32.
[38]	Digital input DI33	Use the result of digital input 33.
[39]	Start command	A start command is issued.
[40]	Drive stopped	A stop command (Jog, Stop, Qstop, Coast) is issued – and not from the SLC itself.
[41]	Reset Trip	A reset is issued
[42]	Auto-reset Trip	An Auto reset is performed.
[43]	Ok key	The [OK] key is pressed.
[44]	Reset key	The [Reset] key is pressed.
[45]	Left key	The [◀] key is pressed.
[46]	Right key	The [▶] key is pressed.
[47]	Up key	The [▲] key is pressed.
[48]	Down key	The [▼] key is pressed.
[50]	Comparator 4	Use the result of comparator 4.
[51]	Comparator 5	Use the result of comparator 5.
[60]	Logic rule 4	Use the result of logic rule 4.
[61]	Logic rule 5	Use the result of logic rule 5.

13-02 Stop Event		
Select the boolean (TRUE or FALSE) input to deactivate Smart Logic Control.		
Option:	Function:	
[0] * False	For descriptions [0]-[61], see <i>13-01 Start Event Start Event</i>	
[1] True		
[2] Running		
[3] In range		
[4] On reference		
[5] Torque limit		
[6] Current limit		
[7] Out of current range		
[8] Below I low		
[9] Above I high		
[10] Out of speed range		
[11] Below speed low		
[12] Above speed high		
[13] Out of feedb. range		
[14] Below feedb. low		
[15] Above feedb. high		
[16] Thermal warning		
[17] Mains out of range		
[18] Reversing		
[19] Warning		
[20] Alarm (trip)		
[21] Alarm (trip lock)		
[22] Comparator 0		
[23] Comparator 1		
[24] Comparator 2		
[25] Comparator 3		
[26] Logic rule 0		
[27] Logic rule 1		
[28] Logic rule 2		
[29] Logic rule 3		
[30] SL Time-out 0		
[31] SL Time-out 1		
[32] SL Time-out 2		
[33] Digital input DI18		
[34] Digital input DI19		
[35] Digital input DI27		
[36] Digital input DI29		
[37] Digital input DI32		
[38] Digital input DI33		
[39] Start command		
[40] Drive stopped		
[41] Reset Trip		
[42] Auto-reset Trip		
[43] Ok key		
[44] Reset key		
[45] Left key		
[46] Right key		
[47] Up key		
[48] Down key		

13-02 Stop Event		
Select the boolean (TRUE or FALSE) input to deactivate Smart Logic Control.		
Option:	Function:	
[50] Comparator 4		
[51] Comparator 5		
[60] Logic rule 4		
[61] Logic rule 5		
[70] SL Time-out 3	Smart Logic Controller timer 3 is timed out.	
[71] SL Time-out 4	Smart Logic Controller timer 4 is timed out.	
[72] SL Time-out 5	Smart Logic Controller timer 5 is timed out.	
[73] SL Time-out 6	Smart Logic Controller timer 6 is timed out.	
[74] SL Time-out 7	Smart Logic Controller timer 7 is timed out.	
[75] Start command given		

13-03 Reset SLC		
Option:	Function:	
[0] * Do not reset SLC	Retains programmed settings in all parameter group <i>13-** Smart Logic Control</i> .	
[1] Reset SLC	Resets all parameters in parameter group <i>13-** Smart Logic Control</i> to default settings.	

3.14.3 13-1* Comparators

Comparators are used for comparing continuous variables (i.e. output frequency, output current, analog input etc.) to fixed preset values.

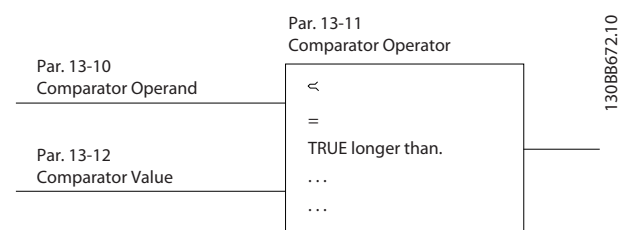

Illustration 3.50

In addition, there are digital values that will be compared to fixed time values. See explanation in *13-10 Comparator Operand*. Comparators are evaluated once in each scan interval. Use the result (TRUE or FALSE) directly. All parameters in this parameter group are array parameters with index 0 to 5. Select index 0 to programme Comparator 0, select index 1 to programme Comparator 1, and so on.

13-10 Comparator Operand		
Array [6]		
Option:	Function:	
	Choices [1] to [31] are variables which will be compared based on their values. Choices [50] to [186] are digital values (TRUE/FALSE) where the comparison is based on the amount of time during which they are set to TRUE or FALSE, respectively. See <i>13-11 Comparator Operator</i> . Select the variable to be monitored by the comparator.	
[0] *	DISABLED	The comparator is disabled.
[1]	Reference	The resulting remote reference (not local) as a percentage.
[2]	Feedback	In the unit [RPM] or [Hz]
[3]	Motor speed	[RPM] or [Hz]
[4]	Motor current	[A]
[5]	Motor torque	[Nm]
[6]	Motor power	[kW] or [hp]
[7]	Motor voltage	[V]
[8]	DC-link voltage	[V]
[9]	Motor thermal	Expressed as a percentage.
[10]	VLT thermal	Expressed as a percentage.
[11]	Heat sink temp.	Expressed as a percentage.
[12]	Analog input AI53	Expressed as a percentage.
[13]	Analog input AI54	Expressed as a percentage.
[14]	Analog input AIFB10	[V]. AIFB10 is internal 10 V supply.
[15]	Analog input AIS24V	[V] Analog input AICCT [17] [°]. AIS24V is switch mode power supply: SMPS 24V.
[17]	Analog input AICCT	[°]. AICCT is control card temperature.
[18]	Pulse input FI29	Expressed as a percentage.
[19]	Pulse input FI33	Expressed as a percentage.
[20]	Alarm number	The error number.
[30]	Counter A	Number of counts
[31]	Counter B	Number of counts
[50]	FALSE	Enters the fixed value of false in the comparator.
[51]	TRUE	Enters the fixed value of true in the comparator.
[52]	Control ready	The control board receives supply voltage

13-10 Comparator Operand		
Array [6]		
Option:	Function:	
[53]	Drive ready	The frequency converter is ready for operation and applies a supply signal on the control board.
[54]	Running	The motor is running.
[55]	Reversing	The output is high when the frequency converter is running counter clockwise (the logical product of the status bits "running" AND "reverse")
[56]	In range	The motor is running within the programmed current and speed ranges set in <i>4-50 Warning Current Low</i> to <i>4-53 Warning Speed High</i> .
[60]	On reference	The motor is running on reference.
[61]	Below reference, low	The motor is running below the value given in <i>4-54 Warning Reference Low</i>
[62]	Above ref, high	The motor is running above the value given in <i>4-55 Warning Reference High</i>
[65]	Torque limit	The torque limit, set in <i>4-16 Torque Limit Motor Mode</i> or <i>4-17 Torque Limit Generator Mode</i> , has been exceeded.
[66]	Current limit	The motor current limit, set in <i>4-18 Current Limit</i> , has been exceeded.
[67]	Out of current range	The motor current is outside the range set in <i>4-18 Current Limit</i> .
[68]	Below I low	The motor current is lower than set in <i>4-50 Warning Current Low</i> .
[69]	Above I high	The motor current is higher than set in <i>4-51 Warning Current High</i> .
[70]	Out of speed range	The speed is outside the range set in <i>4-52 Warning Speed Low</i> and <i>4-53 Warning Speed High</i> .
[71]	Below speed low	The output speed is lower than the setting in <i>4-52 Warning Speed Low</i> .
[72]	Above speed high	The output speed is higher than the setting in <i>4-53 Warning Speed High</i> .
[75]	Out of feedb. range	The feedback is outside the range set in <i>4-56 Warning Feedback Low</i> and <i>4-57 Warning Feedback High</i> .
[76]	Below feedb. low	The feedback is below the limit set in <i>4-56 Warning Feedback Low</i> .
[77]	Above feedb. high	The feedback is above the limit set in <i>4-57 Warning Feedback High</i> .
[80]	Thermal warning	The thermal warning turns on when the temperature exceeds the limit in the motor, the frequency converter, the brake resistor or thermistor.

13-10 Comparator Operand		
Array [6]		
Option:	Function:	
[82]	Mains out of range	The mains voltage is outside the specified voltage range.
[85]	Warning	A warning is active.
[86]	Alarm (trip)	A (trip) alarm is active.
[87]	Alarm (trip lock)	A (Trip lock) alarm is active.
[90]	Bus OK	Active communication (no time-out) via the serial communication port.
[91]	Torque limit & stop	If the frequency converter has received a stop signal and is at the torque limit, the signal is logic "0".
[92]	Brake fault (IGBT)	The brake IGBT is short circuited.
[93]	Mech. brake control	The mechanical brake is active.
[94]	Safe stop active	
[100]	Comparator 0	The result of comparator 0.
[101]	Comparator 1	The result of comparator 1.
[102]	Comparator 2	The result of comparator 2.
[103]	Comparator 3	The result of comparator 3.
[104]	Comparator 4	The result of comparator 4.
[105]	Comparator 5	The result of comparator 5.
[110]	Logic rule 0	The result of Logic rule 0.
[111]	Logic rule 1	The result of Logic rule 1.
[112]	Logic rule 2	The result of Logic rule 2.
[113]	Logic rule 3	The result of Logic rule 3.
[114]	Logic rule 4	The result of Logic rule 4.
[115]	Logic rule 5	The result of Logic rule 5.
[120]	SL Time-out 0	The result of SLC timer 0.
[121]	SL Time-out 1	The result of SLC timer 1.
[122]	SL Time-out 2	The result of SLC timer 2.
[123]	SL Time-out 3	The result of SLC timer 3.
[124]	SL Time-out 4	The result of SLC timer 4.
[125]	SL Time-out 5	The result of SLC timer 5.
[126]	SL Time-out 6	The result of SLC timer 6.
[127]	SL Time-out 7	The result of SLC timer 7.
[130]	Digital input DI18	Digital input 18. High = True.
[131]	Digital input DI19	Digital input 19. High = True.
[132]	Digital input DI27	Digital input 27. High = True.
[133]	Digital input DI29	Digital input 29. High = True.
[134]	Digital input DI32	Digital input 32. High = True.
[135]	Digital input DI33	Digital input 33. High = True.

13-10 Comparator Operand		
Array [6]		
Option:	Function:	
[150]	SL digital output A	Use the result of the SLC output A.
[151]	SL digital output B	Use the result of the SLC output B.
[152]	SL digital output C	Use the result of the SLC output C.
[153]	SL digital output D	Use the result of the SLC output D.
[154]	SL digital output E	Use the result of the SLC output E.
[155]	SL digital output F	Use the result of the SLC output F.
[160]	Relay 1	Relay 1 is active
[161]	Relay 2	Relay 2 is active
[180]	Local ref. active	High when 3-13 Reference Site = [2] Local or when 3-13 Reference Site is [0] Linked to hand Auto, at the same time as the LCP is in Hand On mode.
[181]	Remote ref. active	High when 3-13 Reference Site= [1] Remote or [0] Linked to hand/auto, while the LCP is in Auto On mode.
[182]	Start command	High when there is an active start command, and no stop command.
[183]	Drive stopped	A stop command (Jog, Stop, Qstop, Coast) is issued – and not from the SLC itself.
[185]	Drive in hand mode	High when the frequency converter is in hand mode.
[186]	Drive in auto mode	High when the frequency converter is in auto mode.
[187]	Start command given	

13-11 Comparator Operator		
Array [6]		
Option:	Function:	
		Select the operator to be used in the comparison. This is an array parameter containing comparator operators 0 to 5.
[0]	<	The result of the evaluation is TRUE, when the variable selected in 13-10 Comparator Operand is smaller than the fixed value in 13-12 Comparator Value. The result is FALSE, if the variable selected in 13-10 Comparator Operand is greater than the fixed value in 13-12 Comparator Value.
[1] *	≈ (equal)	The result of the evaluation is TRUE, when the variable selected in 13-10 Comparator Operand is approximately equal to the fixed value in 13-12 Comparator Value.

13-11 Comparator Operator		
Array [6]		
Option:	Function:	
[2]	>	Inverse logic of option < [0].
[5]	TRUE longer than..	
[6]	FALSE longer than..	
[7]	TRUE shorter than..	
[8]	FALSE shorter than..	

13-12 Comparator Value		
Array [6]		
Range:	Function:	
Size related*	[-100000.000 - 100000.000]	Enter the 'trigger level' for the variable that is monitored by this comtor. This is an array parameter containing comtor values 0 to 5.

3.14.4 13-1* RS Flip Flops

The Reset-Set Flip Flops hold the signal until set/reset.

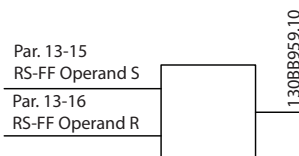

Illustration 3.51

Two parameters are used and the output can be used in the logic rules and as events.

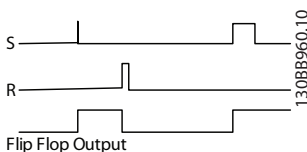

Illustration 3.52

The two operators can be selected from a long list. As a special case, the same digital input can be used as both Set and Reset, making it possible to use the same digital input as start/stop. The following settings can be used to set up the same digital input as start/stop (example given with DI32 but is not a requirement).

Parameter	Setting	Notes
13-00 SL Controller Mode	On	
13-01 Start Event	TRUE	
13-02 Stop Event	FALSE	
13-40 Logic Rule Boolean 1 [0]	[37] Digital Input DI32	
13-42 Logic Rule Boolean 2 [0]	[2] Running	
13-41 Logic Rule Operator 1 [0]	[3] AND NOT	
13-40 Logic Rule Boolean 1 [1]	[37] Digital Input DI32	
13-42 Logic Rule Boolean 2 [1]	[2] Running	
13-41 Logic Rule Operator 1 [1]	[1] AND	
13-15 RS-FF Operand S [0]	[26] Logicrule 0	Output from 13-41 [0]
13-16 RS-FF Operand R [0]	[27] Logicrule 1	Output from 13-41 [1]
13-51 SL Controller Event [0]	[94] RS Flipflop 0	Output from evaluating 13-15 and 13-16
13-52 SL Controller Action [0]	[22] Run	
13-51 SL Controller Event [1]	[27] Logicrule 1	
13-52 SL Controller Action [1]	[24] Stop	

Table 3.22

13-15 RS-FF Operand S		
Option:		Function:
[0]	False	
[1]	True	
[2]	Running	
[3]	In range	
[4]	On reference	
[5]	Torque limit	
[6]	Current Limit	
[7]	Out of current range	
[8]	Below I low	
[9]	Above I high	
[10]	Out of speed range	
[11]	Below speed low	
[12]	Above speed high	
[13]	Out of feedb. range	
[14]	Below feedb. low	
[15]	Above feedb. high	
[16]	Thermal warning	
[17]	Mains out of range	
[18]	Reversing	
[19]	Warning	

13-15 RS-FF Operand S		
Option:	Function:	
[20]	Alarm (trip)	
[21]	Alarm (trip lock)	
[22]	Comparator 0	
[23]	Comparator 1	
[24]	Comparator 2	
[25]	Comparator 3	
[26]	Logic rule 0	
[27]	Logic rule 1	
[28]	Logic rule 2	
[29]	Logic rule 3	
[30]	SL Time-out 0	
[31]	SL Time-out 1	
[32]	SL Time-out 2	
[33]	Digital input DI18	
[34]	Digital input DI19	
[35]	Digital input DI27	
[36]	Digital input DI29	
[37]	Digital input DI32	
[38]	Digital input DI33	
[39]	Start command	
[40]	Drive stopped	
[41]	Reset Trip	
[42]	Auto-reset Trip	
[43]	Ok key	
[44]	Reset key	
[45]	Left key	
[46]	Right key	
[47]	Up key	
[48]	Down key	
[50]	Comparator 4	
[51]	Comparator 5	
[60]	Logic rule 4	
[61]	Logic rule 5	
[70]	SL Time-out 3	
[71]	SL Time-out 4	
[72]	SL Time-out 5	
[73]	SL Time-out 6	
[74]	SL Time-out 7	
[75]	Start command given	
[76]	Digital input x30/2	
[77]	Digital input x30/3	
[78]	Digital input x30/4	
[79]	Digital input x46/1	
[80]	Digital input x46/3	
[81]	Digital input x46/5	
[82]	Digital input x46/7	
[83]	Digital input x46/9	
[84]	Digital input x46/11	
[85]	Digital input x46/13	
[90]	ATEX ETR cur. warning	
[91]	ATEX ETR cur. alarm	
[92]	ATEX ETR freq. warning	

13-15 RS-FF Operand S		
Option:	Function:	
[93]	ATEX ETR freq. alarm	
[94]	RS Flipflop 0	
[95]	RS Flipflop 1	
[96]	RS Flipflop 2	
[97]	RS Flipflop 3	
[98]	RS Flipflop 4	
[99]	RS Flipflop 5	
[100]	RS Flipflop 6	
[101]	RS Flipflop 7	

13-16 RS-FF Operand R		
Option:	Function:	
[0]	False	
[1]	True	
[2]	Running	
[3]	In range	
[4]	On reference	
[5]	Torque limit	
[6]	Current Limit	
[7]	Out of current range	
[8]	Below I low	
[9]	Above I high	
[10]	Out of speed range	
[11]	Below speed low	
[12]	Above speed high	
[13]	Out of feedb. range	
[14]	Below feedb. low	
[15]	Above feedb. high	
[16]	Thermal warning	
[17]	Mains out of range	
[18]	Reversing	
[19]	Warning	
[20]	Alarm (trip)	
[21]	Alarm (trip lock)	
[22]	Comparator 0	
[23]	Comparator 1	
[24]	Comparator 2	
[25]	Comparator 3	
[26]	Logic rule 0	
[27]	Logic rule 1	
[28]	Logic rule 2	
[29]	Logic rule 3	
[30]	SL Time-out 0	
[31]	SL Time-out 1	
[32]	SL Time-out 2	
[33]	Digital input DI18	
[34]	Digital input DI19	
[35]	Digital input DI27	
[36]	Digital input DI29	
[37]	Digital input DI32	
[38]	Digital input DI33	
[39]	Start command	

13-16 RS-FF Operand R		
Option:	Function:	
[40]	Drive stopped	
[41]	Reset Trip	
[42]	Auto-reset Trip	
[43]	Ok key	
[44]	Reset key	
[45]	Left key	
[46]	Right key	
[47]	Up key	
[48]	Down key	
[50]	Comparator 4	
[51]	Comparator 5	
[60]	Logic rule 4	
[61]	Logic rule 5	
[70]	SL Time-out 3	
[71]	SL Time-out 4	
[72]	SL Time-out 5	
[73]	SL Time-out 6	
[74]	SL Time-out 7	
[75]	Start command given	
[76]	Digital input x30/2	
[77]	Digital input x30/3	
[78]	Digital input x30/4	
[79]	Digital input x46/1	
[80]	Digital input x46/3	
[81]	Digital input x46/5	
[82]	Digital input x46/7	
[83]	Digital input x46/9	
[84]	Digital input x46/11	
[85]	Digital input x46/13	
[90]	ATEX ETR cur. warning	
[91]	ATEX ETR cur. alarm	
[92]	ATEX ETR freq. warning	
[93]	ATEX ETR freq. alarm	
[94]	RS Flipflop 0	
[95]	RS Flipflop 1	
[96]	RS Flipflop 2	
[97]	RS Flipflop 3	
[98]	RS Flipflop 4	
[99]	RS Flipflop 5	
[100]	RS Flipflop 6	
[101]	RS Flipflop 7	

3.14.5 13-2* Timers

Use the result (TRUE or FALSE) from *timers* directly to define an *event* (see 13-51 *SL Controller Event*), or as boolean input in a *logic rule* (see 13-40 *Logic Rule Boolean 1*, 13-42 *Logic Rule Boolean 2* or 13-44 *Logic Rule Boolean 3*). A timer is only FALSE when started by an action (i.e. [29] *Start timer 1*) until the timer value entered in this parameter is elapsed. Then it becomes TRUE again.

All parameters in this parameter group are array parameters with index 0 to 2. Select index 0 to program Timer 0, select index 1 to program Timer 1, and so on.

13-20 SL Controller Timer		
Range:	Function:	
0.000 N/A*	[0.000 - 0.000 N/A]	Enter the value to define the duration of the FALSE output from the programmed timer. A timer is only FALSE if it is started by an action (i.e. <i>Start timer 1</i> [29]) and until the given timer value has elapsed.

3.14.6 13-4* Logic Rules

Combine up to three boolean inputs (TRUE/FALSE inputs) from timers, comtors, digital inputs, status bits and events using the logical operators AND, OR, and NOT. Select boolean inputs for the calculation in 13-40 *Logic Rule Boolean 1*, 13-42 *Logic Rule Boolean 2* and 13-44 *Logic Rule Boolean 3*. Define the operators used to logically combine the selected inputs in 13-41 *Logic Rule Operator 1* and 13-43 *Logic Rule Operator 2*.

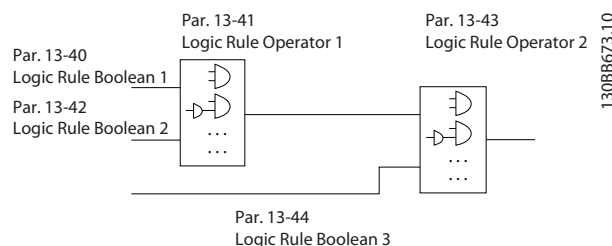

Illustration 3.53

Priority of calculation

The results of 13-40 *Logic Rule Boolean 1*, 13-41 *Logic Rule Operator 1* and 13-42 *Logic Rule Boolean 2* are calculated first. The outcome (TRUE/FALSE) of this calculation is combined with the settings of 13-43 *Logic Rule Operator 2* and 13-44 *Logic Rule Boolean 3*, yielding the final result (TRUE/FALSE) of the logic rule.

13-40 Logic Rule Boolean 1		
Option:	Function:	
[0] *	False	Select the first boolean (TRUE or FALSE) input for the selected logic rule. See 13-01 <i>Start Event</i> ([0] - [61]) and 13-02 <i>Stop Event</i> ([70] - [75]) for further description.
[1]	True	
[2]	Running	
[3]	In range	
[4]	On reference	

13-40 Logic Rule Boolean 1		
Array [6]		
Option:	Function:	
[5]	Torque limit	
[6]	Current limit	
[7]	Out of current range	
[8]	Below I low	
[9]	Above I high	
[10]	Out of speed range	
[11]	Below speed low	
[12]	Above speed high	
[13]	Out of feedb. range	
[14]	Below feedb. low	
[15]	Above feedb. high	
[16]	Thermal warning	
[17]	Mains out of range	
[18]	Reversing	
[19]	Warning	
[20]	Alarm (trip)	
[21]	Alarm (trip lock)	
[22]	Comparator 0	
[23]	Comparator 1	
[24]	Comparator 2	
[25]	Comparator 3	
[26]	Logic rule 0	
[27]	Logic rule 1	
[28]	Logic rule 2	
[29]	Logic rule 3	
[30]	SL Time-out 0	
[31]	SL Time-out 1	
[32]	SL Time-out 2	
[33]	Digital input DI18	
[34]	Digital input DI19	
[35]	Digital input DI27	
[36]	Digital input DI29	
[37]	Digital input DI32	
[38]	Digital input DI33	
[39]	Start command	
[40]	Drive stopped	
[41]	Reset Trip	
[42]	Auto-reset Trip	
[43]	Ok key	
[44]	Reset key	
[45]	Left key	
[46]	Right key	
[47]	Up key	
[48]	Down key	
[50]	Comparator 4	
[51]	Comparator 5	
[60]	Logic rule 4	
[61]	Logic rule 5	
[70]	SL Time-out 3	
[71]	SL Time-out 4	
[72]	SL Time-out 5	

13-40 Logic Rule Boolean 1		
Array [6]		
Option:	Function:	
[73]	SL Time-out 6	
[74]	SL Time-out 7	
[75]	Start command given	

13-41 Logic Rule Operator 1		
Array [6]		
Option:	Function:	
		Select the first logical operator to use on the Boolean inputs from 13-40 Logic Rule Boolean 1 and 13-42 Logic Rule Boolean 2. [13-**] signifies the boolean input of parameter group 13-** Smart Logic Control.
[0] *	DISABLED	Ignores 13-42 Logic Rule Boolean 2, 13-43 Logic Rule Operator 2, and 13-44 Logic Rule Boolean 3.
[1]	AND	Evaluates the expression [13-40] AND [13-42].
[2]	OR	Evaluates the expression [13-40] OR [13-42].
[3]	AND NOT	Evaluates the expression [13-40] AND NOT [13-42].
[4]	OR NOT	Evaluates the expression [13-40] OR NOT [13-42].
[5]	NOT AND	Evaluates the expression NOT [13-40] AND [13-42].
[6]	NOT OR	Evaluates the expression NOT [13-40] OR [13-42].
[7]	NOT AND NOT	Evaluates the expression NOT [13-40] AND NOT [13-42].
[8]	NOT OR NOT	Evaluates the expression NOT [13-40] OR NOT [13-42].

13-42 Logic Rule Boolean 2		
Array [6]		
Option:	Function:	
[0] *	False	Select the second boolean (TRUE or FALSE) input for the selected logic rule. See 13-01 Start Event ([0] - [61]) and 13-02 Stop Event ([70] - [75]) for further description.
[1]	True	
[2]	Running	
[3]	In range	
[4]	On reference	
[5]	Torque limit	
[6]	Current limit	
[7]	Out of current range	
[8]	Below I low	
[9]	Above I high	

13-42 Logic Rule Boolean 2		
Array [6]		
Option:	Function:	
[10]	Out of speed range	
[11]	Below speed low	
[12]	Above speed high	
[13]	Out of feedb. range	
[14]	Below feedb. low	
[15]	Above feedb. high	
[16]	Thermal warning	
[17]	Mains out of range	
[18]	Reversing	
[19]	Warning	
[20]	Alarm (trip)	
[21]	Alarm (trip lock)	
[22]	Comparator 0	
[23]	Comparator 1	
[24]	Comparator 2	
[25]	Comparator 3	
[26]	Logic rule 0	
[27]	Logic rule 1	
[28]	Logic rule 2	
[29]	Logic rule 3	
[30]	SL Time-out 0	
[31]	SL Time-out 1	
[32]	SL Time-out 2	
[33]	Digital input DI18	
[34]	Digital input DI19	
[35]	Digital input DI27	
[36]	Digital input DI29	
[37]	Digital input DI32	
[38]	Digital input DI33	
[39]	Start command	
[40]	Drive stopped	
[41]	Reset Trip	
[42]	Auto-reset Trip	
[43]	Ok key	
[44]	Reset key	
[45]	Left key	
[46]	Right key	
[47]	Up key	
[48]	Down key	
[50]	Comparator 4	
[51]	Comparator 5	
[60]	Logic rule 4	
[61]	Logic rule 5	
[70]	SL Time-out 3	
[71]	SL Time-out 4	
[72]	SL Time-out 5	
[73]	SL Time-out 6	
[74]	SL Time-out 7	
[75]	Start command given	

13-43 Logic Rule Operator 2		
Array [6]		
Option:	Function:	
		Select the second logical operator to be used on the boolean input calculated in 13-40 Logic Rule Boolean 1, 13-41 Logic Rule Operator 1, and 13-42 Logic Rule Boolean 2, and the boolean input coming from 13-42 Logic Rule Boolean 2. [13-44] signifies the boolean input of 13-44 Logic Rule Boolean 3. [13-40/13-42] signifies the boolean input calculated in 13-40 Logic Rule Boolean 1, 13-41 Logic Rule Operator 1, and 13-42 Logic Rule Boolean 2. [0] DISABLED (factory setting). select this option to ignore 13-44 Logic Rule Boolean 3.
[0] *	DISABLED	
[1]	AND	
[2]	OR	
[3]	AND NOT	
[4]	OR NOT	
[5]	NOT AND	
[6]	NOT OR	
[7]	NOT AND NOT	
[8]	NOT OR NOT	

13-44 Logic Rule Boolean 3		
Array [6]		
Option:	Function:	
[0] *	False	Select the third boolean (TRUE or FALSE) input for the selected logic rule. See 13-01 Start Event ([0] - [61]) and 13-02 Stop Event ([70] - [75]) for further description.
[1]	True	
[2]	Running	
[3]	In range	
[4]	On reference	
[5]	Torque limit	
[6]	Current limit	
[7]	Out of current range	
[8]	Below I low	
[9]	Above I high	
[10]	Out of speed range	
[11]	Below speed low	
[12]	Above speed high	
[13]	Out of feedb. range	
[14]	Below feedb. low	
[15]	Above feedb. high	
[16]	Thermal warning	
[17]	Mains out of range	
[18]	Reversing	
[19]	Warning	

13-44 Logic Rule Boolean 3		
Array [6]		
Option:	Function:	
[20]	Alarm (trip)	
[21]	Alarm (trip lock)	
[22]	Comparator 0	
[23]	Comparator 1	
[24]	Comparator 2	
[25]	Comparator 3	
[26]	Logic rule 0	
[27]	Logic rule 1	
[28]	Logic rule 2	
[29]	Logic rule 3	
[30]	SL Time-out 0	
[31]	SL Time-out 1	
[32]	SL Time-out 2	
[33]	Digital input DI18	
[34]	Digital input DI19	
[35]	Digital input DI27	
[36]	Digital input DI29	
[37]	Digital input DI32	
[38]	Digital input DI33	
[39]	Start command	
[40]	Drive stopped	
[41]	Reset Trip	
[42]	Auto-reset Trip	
[43]	Ok key	
[44]	Reset key	
[45]	Left key	
[46]	Right key	
[47]	Up key	
[48]	Down key	
[50]	Comparator 4	
[51]	Comparator 5	
[60]	Logic rule 4	
[61]	Logic rule 5	
[70]	SL Time-out 3	
[71]	SL Time-out 4	
[72]	SL Time-out 5	
[73]	SL Time-out 6	
[74]	SL Time-out 7	
[75]	Start command given	

3.14.7 13-5* States

13-51 SL Controller Event		
Array [20]		
Option:	Function:	
[0] *	False	Select the boolean input (TRUE or FALSE) to define the Smart Logic Controller event. See <i>13-01 Start Event</i> ([0] - [61]) and <i>13-02 Stop Event</i> ([70] - [74]) for further description.

13-51 SL Controller Event		
Array [20]		
Option:	Function:	
[1]	True	
[2]	Running	
[3]	In range	
[4]	On reference	
[5]	Torque limit	
[6]	Current limit	
[7]	Out of current range	
[8]	Below I low	
[9]	Above I high	
[10]	Out of speed range	
[11]	Below speed low	
[12]	Above speed high	
[13]	Out of feedb. range	
[14]	Below feedb. low	
[15]	Above feedb. high	
[16]	Thermal warning	
[17]	Mains out of range	
[18]	Reversing	
[19]	Warning	
[20]	Alarm (trip)	
[21]	Alarm (trip lock)	
[22]	Comparator 0	
[23]	Comparator 1	
[24]	Comparator 2	
[25]	Comparator 3	
[26]	Logic rule 0	
[27]	Logic rule 1	
[28]	Logic rule 2	
[29]	Logic rule 3	
[30]	SL Time-out 0	
[31]	SL Time-out 1	
[32]	SL Time-out 2	
[33]	Digital input DI18	
[34]	Digital input DI19	
[35]	Digital input DI27	
[36]	Digital input DI29	
[37]	Digital input DI32	
[38]	Digital input DI33	
[39]	Start command	
[40]	Drive stopped	
[41]	Reset Trip	
[42]	Auto-reset Trip	
[43]	Ok key	
[44]	Reset key	
[45]	Left key	
[46]	Right key	
[47]	Up key	
[48]	Down key	
[50]	Comparator 4	
[51]	Comparator 5	
[60]	Logic rule 4	

13-51 SL Controller Event	
Array [20]	
Option:	Function:
[61]	Logic rule 5
[70]	SL Time-out 3
[71]	SL Time-out 4
[72]	SL Time-out 5
[73]	SL Time-out 6
[74]	SL Time-out 7
[75]	Start command given

13-52 SL Controller Action	
Array [20]	
Option:	Function:
[0] *	DISABLED Select the action corresponding to the SLC event. Actions are executed when the corresponding event (defined in 13-51 SL Controller Event) is evaluated as true. The following actions are available for selection: [0] *DISABLED
[1]	No action
[2]	Select set-up 1 Changes the active set-up (0-10 Active Set-up) to '1'. If the set-up is changed, it will merge with other set-up commands coming from either the digital inputs or via a fieldbus.
[3]	Select set-up 2 Changes the active set-up 0-10 Active Set-up) to '2'. If the set-up is changed, it will merge with other set-up commands coming from either the digital inputs or via a fieldbus.
[4]	Select set-up 3 Changes the active set-up (0-10 Active Set-up) to '3'. If the set-up is changed, it will merge with other set-up commands coming from either the digital inputs or via a fieldbus.
[5]	Select set-up 4 Changes the active set-up (0-10 Active Set-up) to '4'. If the set-up is changed, it will merge with other set-up commands coming from either the digital inputs or via a fieldbus.
[10]	Select preset ref 0 Selects preset reference 0. If the active preset reference is changed, it will merge with other preset reference commands coming from either the digital inputs or via a fieldbus.
[11]	Select preset ref 1 Selects preset reference 1.

13-52 SL Controller Action	
Array [20]	
Option:	Function:
[12]	Select preset ref 2 Selects preset reference 2. If the active preset reference is changed, it will merge with other preset reference commands coming from either the digital inputs or via a fieldbus.
[13]	Select preset ref 3 Selects preset reference 3. If the active preset reference is changed, it will merge with other preset reference commands coming from either the digital inputs or via a fieldbus.
[14]	Select preset ref 4 Selects preset reference 4. If the active preset reference is changed, it will merge with other preset reference commands coming from either the digital inputs or via a fieldbus.
[15]	Select preset ref 5 Selects preset reference 5. If the active preset reference is changed, it will merge with other preset reference commands coming from either the digital inputs or via a fieldbus.
[16]	Select preset ref 6 Selects preset reference 6. If the active preset reference is changed, it will merge with other preset reference commands coming from either the digital inputs or via a fieldbus.
[17]	Select preset ref 7 Selects preset reference 7. If the active preset reference is changed, it will merge with other preset reference commands coming from either the digital inputs or via a fieldbus.
[18]	Select ramp 1 Selects ramp 1.
[19]	Select ramp 2 Selects ramp 2.
[20]	Select ramp 3 Selects ramp 3.
[21]	Select ramp 4 Selects ramp 4.
[22]	Run Issues a start command to the frequency converter.
[23]	Run reverse Issues a start reverse command to the frequency converter.
[24]	Stop Issues a stop command to the frequency converter.
[25]	Qstop Issues a quick stop command to the frequency converter.
[26]	Dcstop Issues a DC stop command to the frequency converter.

13-52 SL Controller Action		
Array [20]		
Option:	Function:	
[27]	Coast	The frequency converter coasts immediately. All stop commands including the coast command stop the SLC.
[28]	Freeze output	Freezes the output frequency of the frequency converter.
[29]	Start timer 0	Starts timer 0, see <i>13-20 SL Controller Timer</i> for further description.
[30]	Start timer 1	Starts timer 1, see <i>13-20 SL Controller Timer</i> for further description.
[31]	Start timer 2	Starts timer 2, see <i>13-20 SL Controller Timer</i> for further description.
[32]	Set digital out A low	Any output with SL output A will be low.
[33]	Set digital out B low	Any output with SL output B will be low.
[34]	Set digital out C low	Any output with SL output C will be low.
[35]	Set digital out D low	Any output with SL output D will be low.
[36]	Set digital out E low	Any output with SL output E will be low.
[37]	Set digital out F low	Any output with SL output F will be low.
[38]	Set digital out A high	Any output with SL output A will be high.
[39]	Set digital out B high	Any output with SL output B will be high.
[40]	Set digital out C high	Any output with SL output C will be high.
[41]	Set digital out D high	Any output with SL output D will be high.
[42]	Set digital out E high	Any output with SL output E will be high.
[43]	Set digital out F high	Any output with SL output F will be high.
[60]	Reset Counter A	Resets Counter A to zero.
[61]	Reset Counter B	Resets Counter B to zero.
[70]	Start timer 3	Start Timer 3, see <i>13-20 SL Controller Timer</i> for further description.
[71]	Start timer 4	Start Timer 4, see <i>13-20 SL Controller Timer</i> for further description.
[72]	Start timer 5	Start Timer 5, see <i>13-20 SL Controller Timer</i> for further description.
[73]	Start timer 6	Start Timer 6, see <i>13-20 SL Controller Timer</i> for further description.
[74]	Start timer 7	Start Timer 7, see <i>p13-20 SL Controller Timer</i> for further description.

3.15 Parameters: 14-** Special Functions

3.15.1 14-0* Inverter Switching

14-00 Switching Pattern		
Option:	Function:	
		Select the switching pattern: 60° AVM or SFAVM.
[0]	60 AVM	
[1] *	SFAVM	

NOTE

The switching pattern may be automatically adapted by the frequency converter in order to avoid a trip. See application note on derating for more details.

14-01 Switching Frequency		
Select the inverter switching frequency. Changing the switching frequency can help to reduce acoustic noise from the motor. Default depends on power size.		
Option:	Function:	
[0]	1.0 kHz	
[1]	1.5 kHz	Default switching frequency for 355-1200 kW, 690 V
[2]	2.0 kHz	Default switching frequency for 250-800 kW, 400 V and 37-315 kW, 690 V
[3]	2.5 kHz	
[4]	3.0 kHz	Default switching frequency for 18.5-37 kW, 200 V and 37-200 kW, 400 V
[5]	3.5 kHz	
[6]	4.0 kHz	Default switching frequency for 5.5-15 kW, 200 V and 11-30 kW, 400 V
[7] *	5.0 kHz	Default switching frequency for 0.25-3,7 kW, 200 V and 0.37-7.5 kW, 400 V
[8]	6.0 kHz	
[9]	7.0 kHz	
[10]	8.0 kHz	
[11]	10.0 kHz	
[12]	12.0 kHz	
[13]	14.0 kHz	
[14]	16.0 kHz	

NOTE

The output frequency value of the frequency converter must never exceed 1/10 of the switching frequency. When the motor is running, adjust the switching frequency in 14-01 Switching Frequency until the motor is as noiseless as possible.

NOTE

The switching frequency may be automatically adapted by the frequency converter in order to avoid a trip. See application note on derating for more details.

14-03 Overmodulation		
Option:	Function:	
[0]	Off	Select [0] Off for no overmodulation of the output voltage, in order to avoid torque ripple on the motor shaft. This feature may be useful for applications such as grinding machines.
[1] *	On	Select [1] On to enable the overmodulation function for the output voltage. This is the right choice when it is required that the output voltage is higher than 95% of the input voltage (typical when running over-synchronously). The output voltage is increased according to the degree of overmodulation. Overmodulation leads to increased torque ripple as harmonics are increased. Control in FLUX mode provides an output current of up to 98% of the input current, regardless of 14-03 Overmodulation.

14-04 PWM Random		
Option:	Function:	
[0] *	Off	No change of the acoustic motor switching noise.
[1]	On	Transforms the acoustic motor switching noise from a clear ringing tone to a less noticeable 'white' noise. This is achieved by slightly and randomly altering the synchronism of the pulse width modulated output phases.

14-06 Dead Time Compensation		
Option:	Function:	
[0]	Off	No compensation.
[1] *	On	Activates dead time compensation.

3.15.2 14-1* Mains On/Off

Parameters for configuring mains failure monitoring and handling. If a mains failure appears, the frequency converter will try to continue in a controlled way until the power in the DC link has been exhausted.

14-10 Mains Failure		
Option:	Function:	
		14-10 Mains Failure is typically used where very short mains interruptions (voltage dips) are present. At 100% load and a short voltage interruption, the DC voltage on the main capacitors drops quickly. For larger drives it only takes a few milliseconds before the DC level is

14-10 Mains Failure		
Option:	Function:	
		<p>down to about 373 V DC and the IGBTs cut off and loses the control over the motor. When the mains is restored, and the IGBTs start again, the output frequency and voltage vector does not correspond to the speed/frequency of the motor, and the result is normally an overvoltage or overcurrent, mostly resulting in a trip lock.</p> <p><i>14-10 Mains Failure</i> can be programmed to avoid this situation.</p> <p>Select the function to which the frequency converter must act when the threshold in <i>14-11 Mains Voltage at Mains Fault</i> has been reached.</p> <p><i>14-10 Mains Failure</i> cannot be changed while motor is running.</p>
[0] *	No function	The frequency converter will not compensate for a mains interruption. The voltage on the DC-link will drop quickly and motor control will be lost within milliseconds to seconds. Trip lock will be the result.
[1]	Ctrl. ramp-down	The frequency converter will remain control of the motor and do a controlled ramp down from <i>14-11 Mains Voltage at Mains Fault</i> level. If <i>2-10 Brake Function</i> is [0] Off or [2] AC brake, the ramp will follow the Over Voltage Ramping. If <i>2-10 Brake Function</i> is [1] Resistor Brake the ramp will follow the setting in <i>3-81 Quick Stop Ramp Time</i> . This selection is particularly useful in pump applications, where the inertia is low and the friction is high. When the mains is restored, the output frequency will ramp the motor up to the reference speed (if the mains interruption is prolonged, the controlled ramp down might take the output frequency all the way down to 0 RPM, and when the mains is restored, the application is ramped up from 0rpm to the previous reference speed via the normal ramp up). If the energy in the DC-link disappears before the motor is ramped to zero the motor will be coasted.
[2]	Ctrl. ramp-down, trip	This selection is similar to selection [1] except that in [2] a reset is necessary for starting up after power-up.
[3]	Coasting	Centrifuges can run for an hour without power supply. In those situations it is possible to select a coast function at mains interruption, together with a flying start which occurs when the mains is restored.
[4]	Kinetic back-up	Kinetic back-up ensures that the frequency converter keeps running as long as there is energy in the system due to the inertia from motor and load. This is done by converting the mechanical energy to the DC-link and thereby

14-10 Mains Failure							
Option:	Function:						
	<p>maintaining control of the drive and motor. This can extend the controlled operation, depending on the inertia in the system. For fans it is typically several seconds, for pumps up to 2 seconds and for compressors only for a fraction of a second. Many industry applications can extend controlled operation for many seconds, which is often enough time for the mains to return.</p>						
Illustration 3.57							
<table border="1"> <tr> <td>A = Normal Operation</td> <td>D = Mains return</td> </tr> <tr> <td>B = Mains failure</td> <td>E = Normal Operation: ramping</td> </tr> <tr> <td>C = Kinetic back-up</td> <td></td> </tr> </table>		A = Normal Operation	D = Mains return	B = Mains failure	E = Normal Operation: ramping	C = Kinetic back-up	
A = Normal Operation	D = Mains return						
B = Mains failure	E = Normal Operation: ramping						
C = Kinetic back-up							
Table 3.26							
<p>The DC-level during [4] Kinetic back-up is <i>14-11 Mains Voltage at Mains Fault</i>* 1,35. If the mains do not return U_{DC} is maintained as long as possible by ramping the speed down towards 0 RPM. Finally the frequency converter coasts.</p> <p>If the mains return while in kinetic back-up U_{DC} will increase above <i>14-11 Mains Voltage at Mains Fault</i>*1.35. This is detected in one of the following ways.</p> <ol style="list-style-type: none"> 1. If $U_{DC} > 14-11 \text{ Mains Voltage at Mains Fault} * 1.35 * 1.05$ 2. If the speed is above the reference. This is relevant if the mains come back at a lower level than before, e.g. <i>14-11 Mains Voltage at Mains Fault</i>*1.35*1.02. This does not fulfil the criterion in point one and the frequency converter will try to reduce U_{DC} to <i>14-11 Mains Voltage at Mains Fault</i>*1.35 by increasing the speed. This will not succeed as the mains cannot be lowered. 3. If running motoric. The same mechanism as in point two, but where the inertia will prevent that the speed goes above the reference speed. This will lead to the 							

14-10 Mains Failure						
Option:	Function:					
	motor running motoric until the speed is above the reference speed and the situation in point two occurs. Instead of waiting for that criterion three is introduced.					
[5]	Kinetic back-up, trip	<p>The difference between kinetic back-up with and without trip is that the latter will always ramp down to 0 RPM and trip, regardless of whether mains return or not.</p> <p>The function is made so that it will not even detect if mains return, this is the reason for the relatively high level on the DC-link during ramp down.</p> <p>Illustration 3.58</p> <table border="1"> <tr> <td>A = Normal Operation</td> <td>C = Kinetic back-up</td> </tr> <tr> <td>B = Mains failure</td> <td>D = Trip</td> </tr> </table> <p>Table 3.27</p>	A = Normal Operation	C = Kinetic back-up	B = Mains failure	D = Trip
A = Normal Operation	C = Kinetic back-up					
B = Mains failure	D = Trip					
[6]	Alarm					

14-11 Mains Voltage at Mains Fault		
Range:	Function:	
Size related*	[180 - 600 V]	This parameter defines the threshold voltage at which the selected function in <i>14-10 Mains Failure</i> should be activated. It may be considered to choose 90% of the nominal mains as the detection level, depending on the supply quality. For a supply of 380 V <i>14-11 Mains Voltage at Mains Fault</i> should thus be set to 342 V. This results in a DC detection level of 462 V (14-11 * 1.35)

14-11 Mains Voltage at Mains Fault		
Range:	Function:	
	<p>NOTE</p> <p>Note for converting between VLT 5000 and FC 300:</p> <p>Even though the setting of the Mains Voltage at Mains Fault is the same for VLT 5000 and FC 300, the detection level is different. Use the following formula to obtain the same detection level as in VLT 5000: <i>14-11 Mains Voltage at Mains Fault</i> (VLT 5000 level) = Value used in VLT 5000 * 1,35/sqrt(2).</p>	

14-12 Function at Mains Imbalance		
Operation under severe main imbalance conditions reduces the lifetime of the motor. Conditions are considered severe if the motor is operated continuously near nominal load (e.g. a pump or fan running near full speed).		
Option:	Function:	
[0] *	Trip	Trips the frequency converter
[1]	Warning	Issues a warning
[2]	Disabled	No action

14-14 Kin. Backup Time Out		
Range:	Function:	
60 s*	[0 - 60 s]	This parameter defines the Kinetic Backup Time Out in flux mode when running on low voltage grids. If the supply voltage does not increase above the value defined in <i>14-11 Mains Voltage at Mains Fault</i> +5% within the specified time, the drive will then automatically run a controlled ramp-down profile prior to stop.

14-15 Kin. Backup Trip Recovery Level		
Range:	Function:	
Size related*	[0 - 60000.000 ReferenceFeedbackUnit]	This parameter specifies the Kinetic Backup Trip Recovery Level. The unit is defined in <i>0-02 Motor Speed Unit</i> .

Parameters for configuring auto reset handling, special trip handling and control card self test or initialisation.

14-20 Reset Mode		
Option:	Function:	
	Select the reset function after tripping. Once reset, the frequency converter can be restarted.	

14-20 Reset Mode		
Option:	Function:	
[0] *	Manual reset	Select [0] <i>Manual reset</i> , to perform a reset via [RESET] or via the digital inputs.
[1]	Automatic reset x 1	Select [1]-[12] <i>Automatic reset x 1... x20</i> to perform between one and twenty automatic resets after tripping.
[2]	Automatic reset x 2	
[3]	Automatic reset x 3	
[4]	Automatic reset x 4	
[5]	Automatic reset x 5	
[6]	Automatic reset x 6	
[7]	Automatic reset x 7	
[8]	Automatic reset x 8	
[9]	Automatic reset x 9	
[10]	Automatic reset x 10	
[11]	Automatic reset x 15	
[12]	Automatic reset x 20	
[13]	Infinite auto reset	Select [13] <i>Infinite Automatic Reset</i> for continuous resetting after tripping.
[14]	Reset at power-up	

NOTE

The motor may start without warning. If the specified number of AUTOMATIC RESETs is reached within 10 minutes, the frequency converter enters Manual reset [0] mode. After the Manual reset is performed, the setting of 14-20 Reset Mode reverts to the original selection. If the number of automatic resets is not reached within 10 minutes, or when a Manual reset is performed, the internal AUTOMATIC RESET counter returns to zero.

NOTE

Automatic reset will also be active for resetting safe stop function in firmware version < 4.3x.

14-21 Automatic Restart Time		
Range:	Function:	
10 s*	[0 - 600 s]	Enter the time interval from trip to start of the automatic reset function. This parameter is active when 14-20 Reset Mode is set to [1] - [13] <i>Automatic reset</i> .

NOTE

Remember to set switches S201 (A53) and S202 (A54) as specified below when performing a control card test in 14-22 Operation Mode [1]. Otherwise, the test will fail!

14-22 Operation Mode		
Option:	Function:	
		<p>Use this parameter to specify normal operation; to perform tests; or to initialise all parameters except 15-03 Power Up's, 15-04 Over Temp's and 15-05 Over Volt's. This function is active only when the power is cycled to the frequency converter.</p> <p>Select [0] <i>Normal operation</i> for normal operation of the frequency converter with the motor in the selected application.</p> <p>Select [1] <i>Control card test</i> to test the analog and digital inputs and outputs and the +10 V control voltage. The test requires a test connector with internal connections. Use the following procedure for the control card test:</p> <ol style="list-style-type: none"> 1. Select [1] <i>Control card test</i>. 2. Disconnect the mains supply and wait for the light in the display to go out. 3. Set switches S201 (A53) and S202 (A54) = 'ON'/I. 4. Insert the test plug (see <i>Illustration 3.59</i>). 5. Connect to mains supply. 6. Carry out various tests. 7. The results are displayed on the LCP and the frequency converter moves into an infinite loop. 8. 14-22 Operation Mode is automatically set to Normal operation. Carry out a power cycle to start up in Normal operation after a control card test. <p>If the test is OK LCP read-out: Control Card OK. Disconnect the mains supply and remove the test plug. The green LED on the Control Card will light up.</p> <p>If the test fails LCP read-out: Control Card I/O failure. Replace the frequency converter or Control card. The red LED on the Control Card is turned on. Test plugs (connect the following terminals to each other): 18 - 27 - 32; 19 - 29 - 33; 42 - 53 - 54</p>

14-22 Operation Mode	
Option:	Function:
	<p style="text-align: right;">1308A097.12</p> <p style="text-align: center;">Illustration 3.59</p> <p>Select [2] Initialization to reset all parameter values to default settings, except for 15-03 Power Up's, 15-04 Over Temp's, and 15-05 Over Volt's. The frequency converter will reset during the next power-up. 14-22 Operation Mode will also revert to the default setting [0] Normal operation.</p>
[0] *	Normal operation
[1]	Control card test
[2]	Initialisation
[3]	Boot mode

14-24 Trip Delay at Current Limit	
Range:	Function:
60 s* [0 - 60 s]	Enter the current limit trip delay in seconds. When the output current reaches the current limit (4-18 Current Limit), a warning is triggered. When the current limit warning has been continuously present for the period specified in this parameter, the frequency converter trips. To run continuously in current limit without tripping, set the parameter to 60 s = Off. Thermal monitoring of the frequency converter will still remain active.

14-25 Trip Delay at Torque Limit	
Range:	Function:
60 s* [0 - 60 s]	Enter the torque limit trip delay in seconds. When the output torque reaches the torque limits (4-16 Torque Limit Motor Mode and 4-17 Torque Limit Generator Mode), a warning is triggered. When the torque limit warning has been continuously present for the period specified in this parameter, the frequency converter trips. Disable the trip delay by setting

14-25 Trip Delay at Torque Limit	
Range:	Function:
	the parameter to 60 s = Off. Thermal monitoring of the frequency converter will still remain active.

14-26 Trip Delay at Inverter Fault	
Range:	Function:
0. s* [0 - 35 s]	When the frequency converter detects an over-voltage in the set time trip will be effected after the set time. If value = 0, protection mode is disabled
<p>NOTE</p> <p>It is recommended to disable protection mode in hoisting applications.</p>	

14-29 Service Code	
Range:	Function:
0 N/A* [-2147483647 - 2147483647 N/A]	For internal service only.

3.15.3 14-3* Current Limit Control

The frequency converter features an integral Current Limit Controller which is activated when the motor current, and thus the torque, is higher than the torque limits set in 4-16 Torque Limit Motor Mode and 4-17 Torque Limit Generator Mode.

When the current limit is reached during motor operation or regenerative operation, the frequency converter will try to reduce torque below the preset torque limits as quickly as possible without losing control of the motor.

While the current control is active, the frequency converter can only be stopped by setting a digital input to [2] Coast inverse or [3] Coast and reset inv.. Any signal on terminals 18 to 33 will not be active until the frequency converter is no longer near the current limit.

By using a digital input set to [2] Coast inverse or [3] Coast and reset inv., the motor does not use the ramp-down time, since the frequency converter is coasted. If a quick stop is necessary, use the mechanical brake control function along with an external electro-mechanical brake attached to the application.

14-30 Current Lim Ctrl, Proportional Gain	
Range:	Function:
100 %* [0 - 500 %]	Enter the proportional gain value for the current limit controller. Selection of a high value makes the controller react faster. Too high a setting leads to controller instability.

14-31 Current Lim Ctrl, Integration Time		
Range:		Function:
Size related*	[0.002 - 2.000 s]	Controls the current limit control integration time. Setting it to a lower value makes it react faster. A setting too low leads to control instability.

14-32 Current Lim Ctrl, Filter Time		
Range:		Function:
Size related*	[1 - 100 ms]	

14-35 Stall Protection		
Option:		Function:
		Select Enable [1] to enable the stall protection in field-weakening in flux mode. Select [0] Disabled if you desire to disable it. This might cause the motor to be lost. 14-35 Stall Protection is active in Flux mode only.
[0]	Disabled	
[1] *	Enabled	

3.15.4 14-4* Energy Optimising

Parameters for adjusting the energy optimisation level in both Variable Torque (VT) and Automatic Energy Optimization (AEO) mode in *1-03 Torque Characteristics*.

14-40 VT Level		
Range:		Function:
66 %*	[40 - 90 %]	Enter the level of motor magnetisation at low speed. Selection of a low value reduces energy loss in the motor, but also reduces load capability.

NOTE

This parameter cannot be adjusted while the motor is running.

NOTE

This parameter is not active when *1-10 Motor Construction* is set to [1] PM non salient SPM.

14-41 AEO Minimum Magnetisation		
Range:		Function:
Size related*	[40 - 75 %]	Enter the minimum allowable magnetisation for AEO. Selection of a low value reduces energy loss in the motor, but can also reduce resistance to sudden load changes.

NOTE

This parameter is not active when *1-10 Motor Construction* is set to [1] PM non salient SPM.

14-42 Minimum AEO Frequency		
Range:		Function:
10 Hz*	[5 - 40 Hz]	Enter the minimum frequency at which the Automatic Energy Optimisation (AEO) is to be active.

NOTE

This parameter is not active when *1-10 Motor Construction* is set to [1] PM non salient SPM.

14-43 Motor Cosphi		
Range:		Function:
0.66 N/A*	[0.40 - 0.95 N/A]	The Cos(phi) setpoint is automatically set for optimum AEO performance. This parameter should normally not be altered. However in some situations it may be necessary to enter a new value to fine-tune.

3.15.5 14-5* Environment

These parameters help the frequency converter to operate under special environmental conditions.

14-50 RFI Filter		
This parameter is only available for FC 302. It is not relevant to FC 301 due to different design and shorter motor cables.		
Option:		Function:
[0]	Off	Select [0] Off if the frequency converter is fed by an isolated mains source (IT mains). If a filter is used, select Off [0] during charging to prevent a high leakage current making the RCD switch. In this mode, the internal RFI filter capacitors between chassis and the mains RFI filter circuit are cut-out to reduce the ground capacity currents.
[1] *	On	Select [1] On to ensure that the frequency converter complies with EMC standards.

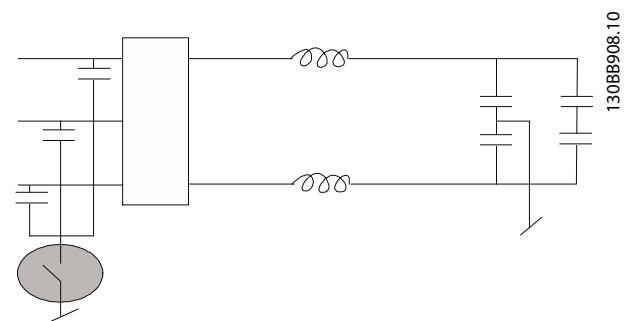

Illustration 3.60

14-51 DC Link Compensation		
Option:	Function:	
		The rectified AC-DC voltage at the frequency converter's DC link is associated with voltage ripples. These ripples can increase in magnitude with increased load. These ripples are undesirable because they can generate current and torque ripples. A compensation method is used to reduce these voltage ripples at DC link. In general, DC link compensation is recommended for most applications, but care must be taken when operating in field weakening as it can generate speed oscillations at the motor shaft. In field weakening, it is recommended to turn DC link compensation off.
[0]	Off	Disables DC Link Compensation.
[1] *	On	Enables DC Link Compensation.

14-52 Fan Control		
Select minimum speed of the main fan.		
Option:	Function:	
[0] *	Auto	Select [0] Auto to run fan only when internal temperature in frequency converter is in range 35 °C to approx. 55 °C. Fan will run at low speed below 35 °C, and at full speed at approx. 55 °C.
[1]	On 50%	The fan will always run at 50% speed or above. The fan will run at 50% speed at 35 °C, and at full speed at approx. 55 °C.
[2]	On 75%	The fan will always run at 75% speed or above. The fan will run at 75% speed at 35 °C, and at full speed at approx. 55 °C.
[3]	On 100%	The fan will run at 100% speed always.

14-53 Fan Monitor		
Option:	Function:	
		Select which reaction the frequency converter should take in case a fan fault is detected.
[0]	Disabled	
[1] *	Warning	
[2]	Trip	

14-55 Output Filter		
Option:	Function:	
		Select the type of output filter connected. This parameter cannot be adjusted while motor is running.
[0] *	No Filter	This is the default setting and should be used with dU/dt filters or high-frequency common-mode (HF-CM) filters.
[1]	Sine-Wave Filter	This setting is only for backwards compatibility. It enables operation with FLUX control principle when the parameters 14-56 Capacitance Output

14-55 Output Filter		
Option:	Function:	
		Filter and 14-57 Inductance Output Filter are programmed with the output filter capacitance and inductance. It DOES NOT limit the range of the switching frequency.

14-56 Capacitance Output Filter		
Compensation function of the LC-filter requires the per phase equivalent star connected capacitance of the filter (3 times the capacity between two phases when capacitance is 'Delta' connection).		
Range:	Function:	
2.0 uF*	[0.1 - 6500.0 uF]	Set the capacitance of the output filter. The value can be found on the filter label.
NOTE This is required for correct compensation in Flux mode (1-01 Motor Control Principle)		

14-57 Inductance Output Filter		
Range:	Function:	
7.000 mH*	[0.001 - 65.000 mH]	Set the inductance of the output filter. The value can be found on the filter label.
NOTE This is required for correct compensation in Flux mode (1-01 Motor Control Principle)		

3.15.6 14-7* Compatibility

The parameters in this group are for setting of compatibility for VLT 3000, VLT 5000 to FC 300.

14-72 VLT Alarm Word		
Option:	Function:	
[0]	0 - 4294967295	Read out the alarm word corresponding to VLT 5000.

14-73 VLT Warning Word		
Option:	Function:	
[0]	0 - 4294967295	Read out the warning word corresponding to VLT 5000.

14-74 VLT Ext. Status Word		
Range:	Function:	
0 N/A*	[0 - 4294967295 N/A]	Read out the ext. status word corresponding to VLT 5000

3.15.7 14-8* Options

14-80 Option Supplied by External 24VDC		
Option:	Function:	
[0]	No	Select [0] No to use the frequency converter's 24 V DC supply.
[1] *	Yes	Select [1] Yes if an external 24 V DC supply will be used to power the option. Inputs/Outputs will be galvanically isolated from the drive when operated from an external supply.

NOTE

This parameter is only changing function by performing a power cycle.

14-89 Option Detection		
Selects the behaviour of the frequency converter when a change in the option configuration is detected.		
Option:	Function:	
[0] *	Protect Option Config.	Freezes the current settings and prevents unwanted changes when missing or defective options are detected.

14-89 Option Detection		
Selects the behaviour of the frequency converter when a change in the option configuration is detected.		
Option:	Function:	
[1]	Enable Option Change	Changes drive settings and is used when modifying the system configuration. This Parameter setting will return to [0] after an Option Change.

14-90 Fault Level		
Option:	Function:	
[0] *	Off	Use this parameter to customize Fault levels. Use [0] Off with caution as it will ignore all Warnings & Alarms for the chosen source.
[1]	Warning	
[2]	Trip	
[3]	Trip Lock	

Failure	Alarm	Off	Warning	Trip	Trip Lock
10 V low	1	X	D		
24 V low	47	X			D
1.8 V supply low	48	X			D
Voltage limit	64	X	D		
Earth fault during ramping	14			D	X
Earth fault 2 during cont. operation	45			D	X
Torque Limit	12	X	D		
Over Current	13			X	D
Short Circuit	16			X	D
Heatsink temperature	29			X	D
Heatsink sensor	39			X	D
Control card temperature	65			X	D
Power card temperature	6		²⁾	X	D
Heatsink temperature ¹⁾	244			X	D
Heatsink sensor ¹⁾	245			X	D
Power card temperature ¹⁾	247				

Table 3.28 Table for Selection of Choice of Action when Selected Alarm Appears

D = Default setting. x = possible selection.

1) Only high power drives

In FC small and medium A69 is only a warning

3.16 Parameters: 15-** Drive Information

3.16.1 15-0* Operating Data

15-00 Operating Hours		
Range:		Function:
0 h*	[0 - 2147483647 h]	View how many hours the frequency converter has run. The value is saved when the frequency converter is turned off.

15-01 Running Hours		
Range:		Function:
0 h*	[0 - 2147483647 h]	View how many hours the motor has run. Reset the counter in <i>15-07 Reset Running Hours Counter</i> . The value is saved when the frequency converter is turned off.

15-02 kWh Counter		
Range:		Function:
0 kWh*	[0 - 2147483647 kWh]	Registering the power consumption of the motor as a mean value over one hour. Reset the counter in <i>15-06 Reset kWh Counter</i> .

15-03 Power Up's		
Range:		Function:
0 *	[0 - 2147483647]	View the number of times the frequency converter has been powered up.

15-04 Over Temp's		
Range:		Function:
0 *	[0 - 65535]	View the number of frequency converter temperature faults which have occurred.

15-05 Over Volt's		
Range:		Function:
0 *	[0 - 65535]	View the number of frequency converter overvoltages which have occurred.

15-06 Reset kWh Counter		
Option:		Function:
[0] *	Do not reset	Nno reset of the kWh counter is desired.
[1]	Reset counter	Press [OK] to reset the kWh counter to zero (see <i>15-02 kWh Counter</i>).

NOTE

The reset is carried out by pressing [OK].

15-07 Reset Running Hours Counter		
Option:		Function:
[0] *	Do not reset	
[1]	Reset counter	Select [1] <i>Reset</i> and press [OK] to reset the Running Hours counter to zero (see <i>15-01 Running Hours</i>). This parameter cannot be selected via the serial port, RS-485. Select [0] <i>Do not reset</i> if no reset of the Running Hours counter is desired.

3.16.2 15-1* Data Log Settings

The Data Log enables continuous logging of up to 4 data sources (*15-10 Logging Source*) at individual rates (*15-11 Logging Interval*). A trigger event (*15-12 Trigger Event*) and window (*15-14 Samples Before Trigger*) are used to start and stop the logging conditionally.

15-10 Logging Source		
Array [4]		
Option:		Function:
		Select which variables are to be logged.
[0] *	None	
[1472]	VLT Alarm Word	
[1473]	VLT Warning Word	
[1474]	VLT Ext. Status Word	
[1600]	Control Word	
[1601]	Reference [Unit]	
[1602]	Reference %	
[1603]	Status Word	
[1610]	Power [kW]	
[1611]	Power [hp]	
[1612]	Motor Voltage	
[1613]	Frequency	
[1614]	Motor Current	
[1616]	Torque [Nm]	
[1617]	Speed [RPM]	
[1618]	Motor Thermal	
[1622]	Torque [%]	
[1625]	Torque [Nm] High	
[1630]	DC Link Voltage	
[1632]	Brake Energy /s	
[1633]	Brake Energy /2 min	
[1634]	Heatsink Temp.	
[1635]	Inverter Thermal	
[1650]	External Reference	
[1651]	Pulse Reference	
[1652]	Feedback [Unit]	
[1660]	Digital Input	
[1662]	Analog Input 53	
[1664]	Analog Input 54	
[1665]	Analog Output 42 [mA]	
[1666]	Digital Output [bin]	

15-10 Logging Source		
Array [4]		
Option:	Function:	
[1675]	Analog In X30/11	
[1676]	Analog In X30/12	
[1677]	Analog Out X30/8 [mA]	
[1690]	Alarm Word	
[1692]	Warning Word	
[1694]	Ext. Status Word	
[3470]	MCO Alarm Word 1	
[3471]	MCO Alarm Word 2	

15-11 Logging Interval		
Array [4]		
Range:	Function:	
Size related*	[0.000 - 0.000]	Enter the interval in milliseconds between each sampling of the variables to be logged.

15-12 Trigger Event		
Select the trigger event. When the trigger event occurs, a window is applied to freeze the log. The log will then retain a specified percentage of samples before the occurrence of the trigger event (<i>15-14 Samples Before Trigger</i>).		
Option:	Function:	
[0] *	False	
[1]	True	
[2]	Running	
[3]	In range	
[4]	On reference	
[5]	Torque limit	
[6]	Current limit	
[7]	Out of current range	
[8]	Below I low	
[9]	Above I high	
[10]	Out of speed range	
[11]	Below speed low	
[12]	Above speed high	
[13]	Out of feedb. range	
[14]	Below feedb. low	
[15]	Above feedb. high	
[16]	Thermal warning	
[17]	Mains out of range	
[18]	Reversing	
[19]	Warning	
[20]	Alarm (trip)	
[21]	Alarm (trip lock)	
[22]	Comparator 0	
[23]	Comparator 1	
[24]	Comparator 2	
[25]	Comparator 3	
[26]	Logic rule 0	
[27]	Logic rule 1	
[28]	Logic rule 2	

15-12 Trigger Event		
Select the trigger event. When the trigger event occurs, a window is applied to freeze the log. The log will then retain a specified percentage of samples before the occurrence of the trigger event (<i>15-14 Samples Before Trigger</i>).		
Option:	Function:	
[29]	Logic rule 3	
[33]	Digital input DI18	
[34]	Digital input DI19	
[35]	Digital input DI27	
[36]	Digital input DI29	
[37]	Digital input DI32	
[38]	Digital input DI33	
[50]	Comparator 4	
[51]	Comparator 5	
[60]	Logic rule 4	
[61]	Logic rule 5	

15-13 Logging Mode		
Option:	Function:	
[0] *	Log always	Select [0] <i>Log always</i> for continuous logging.
[1]	Log once on trigger	Select [1] <i>Log once on trigger</i> to conditionally start and stop logging using <i>15-12 Trigger Event</i> and <i>15-14 Samples Before Trigger</i> .

15-14 Samples Before Trigger		
Range:	Function:	
50 N/A*	[0 - 100 N/A]	Enter the percentage of all samples prior to a trigger event which are to be retained in the log. See also <i>15-12 Trigger Event</i> and <i>15-13 Logging Mode</i> .

3.16.3 15-2* Historic Log

View up to 50 logged data items via the array parameters in this parameter group. For all parameters in the group, [0] is the most recent data and [49] the oldest data. Data is logged every time an *event* occurs (not to be confused with SLC events). *Events* in this context are defined as a change in one of the following areas

1. Digital input
2. Digital outputs (not monitored in this SW release)
3. Warning word
4. Alarm word
5. Status word
6. Control word
7. Extended status word

Events are logged with value, and time stamp in ms. The time interval between two events depends on how often

events occur (maximum once every scan time). Data logging is continuous but if an alarm occurs, the log is saved and the values can be viewed on the display. This feature is useful, for example when carrying out service following a trip. View the historic log contained in this parameter via the serial communication port or via the display.

15-20 Historic Log: Event		
Array [50]		
Range:	Function:	
0 *	[0 - 255]	View the event type of the logged events.

15-21 Historic Log: Value		
Array [50]		
Range:	Function:	
0 *	[0 - 2147483647]	View the value of the logged event. Interpret the event values according to this table:
	Digital input	Decimal value. See <i>16-60 Digital Input</i> for description after converting to binary value.
	Digital output (not monitored in this SW release)	Decimal value. See <i>16-66 Digital Output [bin]</i> for description after converting to binary value.
	Warning word	Decimal value. See <i>16-92 Warning Word</i> for description.
	Alarm word	Decimal value. See <i>16-90 Alarm Word</i> for description.
	Status word	Decimal value. See <i>16-03 Status Word</i> for description after converting to binary value.
	Control word	Decimal value. See <i>16-00 Control Word</i> for description.
	Extended status word	Decimal value. See <i>16-94 Ext. Status Word</i> for description.
Table 3.30		

15-22 Historic Log: Time		
Array [50]		
Range:	Function:	
0 ms*	[0 - 2147483647 ms]	View the time at which the logged event occurred. Time is measured in ms since frequency converter start.

15-22 Historic Log: Time		
Array [50]		
Range:	Function:	
		The max. value corresponds to approx. 24 days which means that the count will restart at zero after this time period.

3

3.16.4 15-3* Alarm Log

Parameters in this group are array parameters, where up to 10 fault logs can be viewed. [0] is the most recent logged data, and [9] the oldest. Error codes, values, and time stamp can be viewed for all logged data.

15-30 Fault Log: Error Code		
Array [10]		
Range:	Function:	
0 N/A*	[0 - 255 N/A]	View the error code and look up its meaning in <i>5 Troubleshooting</i> .

15-31 Alarm Log: Value		
Array [10]		
Range:	Function:	
0 *	[-32767 - 32767]	View an extra description of the error. This parameter is mostly used in combination with alarm 38 'internal fault'.

15-32 Alarm Log: Time		
Array [10]		
Range:	Function:	
0 s*	[0 - 2147483647 s]	View the time when the logged event occurred. Time is measured in seconds from frequency converter start-up.

3.16.5 15-4* Drive Identification

Parameters containing read only information about the hardware and software configuration of the frequency converter.

15-40 FC Type		
Range:	Function:	
0 N/A*	[0 - 0 N/A]	View the frequency converter type. The read-out is identical to the FC 300 Series power field of the type code definition, characters 1-6.

15-41 Power Section		
Range:	Function:	
0 N/A* [0 - 0 N/A]	View the FC type. The read-out is identical to the FC 300 Series power field of the type code definition, characters 7-10.	

15-42 Voltage		
Range:	Function:	
0 N/A* [0 - 0 N/A]	View the FC type. The read-out is identical to the FC 300 Series power field of the type code definition, characters 11-12.	

15-43 Software Version		
Range:	Function:	
0 * [0 - 0]	View the combined SW version (or 'package version') consisting of power SW and control SW.	

15-44 Ordered Typecode String		
Range:	Function:	
0 * [0 - 0]	View the type code string used for re-ordering the frequency converter in its original configuration.	

15-45 Actual Typecode String		
Range:	Function:	
0 * [0 - 0]	View the actual type code string.	

15-46 Frequency Converter Ordering No		
Range:	Function:	
0 * [0 - 0]	View the 8-digit ordering number used for re-ordering the frequency converter in its original configuration.	

15-47 Power Card Ordering No		
Range:	Function:	
0 * [0 - 0]	View the power card ordering number.	

15-48 LCP Id No		
Range:	Function:	
0 * [0 - 0]	View the LCP ID number.	

15-49 SW ID Control Card		
Range:	Function:	
0 * [0 - 0]	View the control card software version number.	

15-50 SW ID Power Card		
Range:	Function:	
0 * [0 - 0]	View the power card software version number.	

15-51 Frequency Converter Serial Number		
Range:	Function:	
0 * [0 - 0]	View the frequency converter serial number.	

15-53 Power Card Serial Number		
Range:	Function:	
0 * [0 - 0]	View the power card serial number.	

15-58 Smart Setup Filename		
Range:	Function:	
Size related* [0 - 0]	Shows the currently used smart application setup filename.	

15-59 CSIV Filename		
Range:	Function:	
Size related* [0 - 0]	Shows the currently used CSIV (Customer Specific Initial Values) filename.	

3.16.6 15-6* Option Ident.

This read-only parameter group contains information about the hardware and software configuration of the options installed in slots A, B, C0 and C1.

15-60 Option Mounted		
Range:	Function:	
Array [8]		
0 * [0 - 0]	View the installed option type.	

15-61 Option SW Version		
Range:	Function:	
Array [8]		
0 * [0 - 0]	View the installed option software version.	

15-62 Option Ordering No		
Range:	Function:	
Array [8]		
0 * [0 - 0]	Shows the ordering number for the installed options.	

15-63 Option Serial No		
Range:	Function:	
Array [8]		
0 * [0 - 0]	View the installed option serial number.	

15-80 Fan Running Hours		
Range:	Function:	
0 h* [0 - 2147483647 h]	View how many hours the heatsink fan has run (increments for each hour). The value is saved when the drive is turned off.	

15-92 Defined Parameters		
Array [1000]		
Range:		Function:
0 *	[0 - 9999]	View a list of all defined parameters in the frequency converter. The list ends with 0.

15-93 Modified Parameters		
Array [1000]		
Range:		Function:
0 *	[0 - 9999]	View a list of the parameters that have been changed from their default setting. The list ends with 0. Changes may not be visible until up to 30 s after implementation.

15-99 Parameter Metadata		
Array [30]		
Range:		Function:
0 N/A*	[0 - 9999 N/A]	This parameter contains data used by the MCT 10 Set-up Software.

3.17 Parameters: 16-** Data Read-outs

16-00 Control Word		
Range:	Function:	
0 * [0 - 65535]	View the Control word sent from the frequency converter via the serial communication port in hex code.	

16-01 Reference [Unit]		
Range:	Function:	
0.000 Reference-FeedbackUnit*	[-999999.000 - 999999.000 ReferenceFeed-backUnit]	View the present reference value applied on impulse or analog basis in the unit resulting from the configuration selected in <i>1-00 Configuration Mode</i> (Hz, Nm or RPM).

16-02 Reference [%]		
Range:	Function:	
0.0 %* [-200.0 - 200.0 %]	View the total reference. The total reference is the sum of digital, analog, preset, bus, and freeze references, plus catch-up and slow-down.	

16-03 Status Word		
Range:	Function:	
0 * [0 - 65535]	View the Status word sent from the frequency converter via the serial communication port in hex code.	

16-05 Main Actual Value [%]		
Range:	Function:	
0.00 %* [-100.00 - 100.00 %]	View the two-byte word sent with the Status word to the bus Master reporting the Main Actual Value.	

16-09 Custom Readout		
Range:	Function:	
0.00 CustomReadoutUnit*	[0.00 - 0.00 CustomReadoutUnit]	View the value of custom readout from <i>0-30 Unit for User-defined Readout</i> to <i>0-32 Custom Readout Max Value</i>

3.17.1 16-1* Motor Status

16-10 Power [kW]		
Range:	Function:	
0.00 kW* [0.00 - 10000.00 kW]	Displays motor power in kW. The value shown is calculated on the basis of the actual motor voltage and motor current. The value is filtered, and therefore approx.	

16-10 Power [kW]		
Range:	Function:	
		30 ms may pass from when an input value changes to when the data read-out values change. The resolution of read-out value on fieldbus is in 10 W steps.

16-11 Power [hp]		
Range:	Function:	
0.00 hp* [0.00 - 10000.00 hp]	View the motor power in HP. The value shown is calculated on the basis of the actual motor voltage and motor current. The value is filtered, and therefore approximately 30 ms may pass from when an input value changes to when the data read-out values change.	

16-12 Motor Voltage		
Range:	Function:	
0.0 V* [0.0 - 6000.0 V]	View the motor voltage, a calculated value used for controlling the motor.	

16-13 Frequency		
Range:	Function:	
0.0 Hz* [0.0 - 6500.0 Hz]	View the motor frequency, without resonance dampening.	

16-14 Motor Current		
Range:	Function:	
0.00 A* [0.00 - 10000.00 A]	View the motor current measured as a mean value, I_{RMS} . The value is filtered, and thus approximately 30 ms may pass from when an input value changes to when the data read-out values change.	

16-15 Frequency [%]		
Range:	Function:	
0.00 %* [-100.00 - 100.00 %]	View a two-byte word reporting the actual motor frequency (without resonance dampening) as a percentage (scale 0000-4000 Hex) of <i>4-19 Max Output Frequency</i> . Set <i>9-16 PCD Read Configuration</i> index 1 to send it with the Status Word instead of the MAV.	

16-16 Torque [Nm]		
Range:	Function:	
0.0 Nm* [-3000.0 - 3000.0 Nm]	View the torque value with sign, applied to the motor shaft. Linearity is not exact between 160% motor current and torque in relation to the rated torque. Some motors supply more than 160% torque. Consequently, the min. value and the max. value will depend on the max. motor current	

16-16 Torque [Nm]		
Range:	Function:	
		as well as the motor used. The value is filtered, and thus approx. 30 ms may pass from when an input changes value to when the data read-out values change.

16-17 Speed [RPM]		
Range:	Function:	
0 RPM*	[-30000 - 30000 RPM]	View the actual motor RPM. In open loop or closed loop process control the motor RPM is estimated. In speed closed loop modes the motor RPM is measured.

16-18 Motor Thermal		
Range:	Function:	
0 %*	[0 - 100 %]	View the calculated thermal load on the motor. The cut-out limit is 100%. The basis for calculation is the ETR function selected in 1-90 Motor Thermal Protection.

16-19 KTY sensor temperature		
Range:	Function:	
0 °C*	[0 - 0 °C]	Returning the actual temperature on KTY sensor built into the motor. See parameter group 1-9* Motor Temperature.

16-20 Motor Angle		
Range:	Function:	
0 N/A*	[0 - 65535 N/A]	View the current encoder/resolver angle offset relative to the index position. The value range of 0-65535 corresponds to 0-2*pi (radians).

16-21 Torque [%] High Res.		
Range:	Function:	
0 %*	[-200 - 200 %]	The value shown is the torque in percent of nominal torque, with sign and 0.1% resolution, applied to the motor shaft.

16-22 Torque [%]		
Range:	Function:	
0 %*	[-200 - 200 %]	Value shown is the torque in percent of nominal torque, with sign, applied to the motor shaft.

16-25 Torque [Nm] High		
Range:	Function:	
0.0 Nm*	[-200000000.0 - 200000000.0 Nm]	View the torque value with sign, applied to the motor shaft. Some motors supply more than 160% torque. Consequently, the min. value and the max. value will depend on the max. motor current as well as the

16-25 Torque [Nm] High		
Range:	Function:	
		motor used. This specific readout has been adapted to be able to show higher values than the standard readout in 16-16 Torque [Nm].

3.17.2 16-3* Drive Status

16-30 DC Link Voltage		
Range:	Function:	
0 V*	[0 - 10000 V]	View a measured value. The value is filtered with an 30 ms time constant.

16-32 Brake Energy /s		
Range:	Function:	
0.000 kW*	[0.000 - 10000.000 kW]	View the brake power transmitted to an external brake resistor, stated as an instantaneous value.

16-33 Brake Energy /2 min		
Range:	Function:	
0.000 kW*	[0.000 - 10000.000 kW]	View the brake power transmitted to an external brake resistor. The mean power is calculated on an average basis for the most recent 120 s.

16-34 Heatsink Temp.		
Range:	Function:	
0 °C*	[0 - 255 °C]	View the frequency converter heatsink temperature. The cut-out limit is 90 ±5 °C, and the motor cuts back in at 60 ±5 °C.

16-35 Inverter Thermal		
Range:	Function:	
0 %*	[0 - 100 %]	View the percentage load on the inverter.

16-36 Inv. Nom. Current		
Range:	Function:	
10.00 A*	[0.01 - 10000.00 A]	View the inverter nominal current, which should match the nameplate data on the connected motor. The data are used for calculation of torque, motor protection, etc.

16-37 Inv. Max. Current		
Range:	Function:	
16.00 A*	[0.01 - 10000.00 A]	View the inverter maximum current, which should match the nameplate data on the connected motor. The

16-37 Inv. Max. Current		
Range:	Function:	
		data are used for calculation of torque, motor protection, etc.

16-38 SL Controller State		
Range:	Function:	
0 N/A* [0 - 100 N/A]	View the state of the event under execution by the SL controller.	

16-39 Control Card Temp.		
Range:	Function:	
0 °C* [0 - 100 °C]	View the temperature on the control card, stated in °C	

16-40 Logging Buffer Full		
Option:	Function:	
	View whether the logging buffer is full (see parameter group 15-1* <i>Data Log Settings</i>). The logging buffer will never be full when 15-13 <i>Logging Mode</i> is set to [0] <i>Log always</i> .	
[0] *	No	
[1]	Yes	

16-48 Speed Ref. After Ramp [RPM]		
Range:	Function:	
0 RPM* [-30000 - 30000 RPM]	This parameter specifies the reference given to the drive after the speed ramp.	

16-49 Current Fault Source		
Range:	Function:	
0 * [0 - 8]	Value indicates source of current faults including short circuit, over current, and phase imbalance (from left): 1-4 Inverter 5-8 Rectifier 0 No fault recorded	

3.17.3 16-5* Ref. & Feedb.

16-50 External Reference		
Range:	Function:	
0.0 N/A* [-200.0 - 200.0 N/A]	View the total reference, the sum of digital, analog, preset, bus and freeze references, plus catch-up and slow-down.	

16-51 Pulse Reference		
Range:	Function:	
0.0 N/A* [-200.0 - 200.0 N/A]	View the reference value from programmed digital input(s). The	

16-51 Pulse Reference		
Range:	Function:	
	read-out can also reflect the impulses from an incremental encoder.	

16-52 Feedback [Unit]		
Range:	Function:	
0.000 Reference-FeedbackUnit* [-999999.999 - 999999.999 ReferenceFeed-backUnit]	View the feedback unit resulting from the selection of unit and scaling in 3-00 <i>Reference Range</i> , 3-01 <i>Reference/Feedback Unit</i> , 3-02 <i>Minimum Reference</i> and 3-03 <i>Maximum Reference</i> .	

16-53 Digi Pot Reference		
Range:	Function:	
0.00 N/A* [-200.00 - 200.00 N/A]	View the contribution of the Digital Potentiometer to the actual reference.	

16-57 Feedback [RPM]		
Range:	Function:	
0 RPM* [-30000 - 30000 RPM]	Read-out parameter where the actual motor RPM from the feed-back source can be read in both closed loop and open loop. The feed-back source is selected by 7-00 <i>Speed PID Feedback Source</i> .	

3.17.4 16-6* Inputs and Outputs

16-60 Digital Input		
Range:	Function:	
0 * [0 - 1023]	View the signal states from the active digital inputs. Example: Input 18 corresponds to bit no. 5, '0' = no signal, '1' = connected signal. Bit 6 works in the opposite way, on = '0', off = '1' (safe stop input).	
Bit 0	Digital input term. 33	
Bit 1	Digital input term. 32	
Bit 2	Digital input term. 29	
Bit 3	Digital input term. 27	
Bit 4	Digital input term. 19	
Bit 5	Digital input term. 18	
Bit 6	Digital input term. 37	
Bit 7	Digital input GP I/O term. X30/4	
Bit 8	Digital input GP I/O term. X30/3	
Bit 9	Digital input GP I/O term. X30/2	
Bit 10-63	Reserved for future terminals	

Table 3.34

Illustration 3.63

16-61 Terminal 53 Switch Setting		
Option:	Function:	
	View the setting of input terminal 53. Current = 0; Voltage = 1.	
[0]	Current	
[1]	Voltage	
[2]	Pt 1000 [°C]	
[3]	Pt 1000 [°F]	
[4]	Ni 1000 [°C]	
[5]	Ni 1000 [°F]	

16-62 Analog Input 53		
Range:	Function:	
0.000 N/A*	[-20.000 - 20.000 N/A]	View the actual value at input 53.

16-63 Terminal 54 Switch Setting		
Option:	Function:	
	View the setting of input terminal 54. Current = 0; Voltage = 1.	
[0]	Current	
[1]	Voltage	
[2]	Pt 1000 [°C]	
[3]	Pt 1000 [°F]	
[4]	Ni 1000 [°C]	
[5]	Ni 1000 [°F]	

16-64 Analog Input 54		
Range:	Function:	
0.000 N/A*	[-20.000 - 20.000 N/A]	View the actual value at input 54.

16-65 Analog Output 42 [mA]		
Range:	Function:	
0.000 N/A*	[0.000 - 30.000 N/A]	View the actual value at output 42 in mA. The value shown reflects the selection in 6-50 Terminal 42 Output.

16-66 Digital Output [bin]		
Range:	Function:	
0 N/A*	[0 - 15 N/A]	View the binary value of all digital outputs.

16-67 Pulse Input #29 [Hz]		
Range:	Function:	
0 *	[0 - 130000]	View the actual frequency rate on terminal 29.

16-68 Freq. Input #33 [Hz]		
Range:	Function:	
0 N/A*	[0 - 130000 N/A]	View the actual value of the frequency applied at terminal 33 as an impulse input.

16-69 Pulse Output #27 [Hz]		
Range:	Function:	
0 N/A*	[0 - 40000 N/A]	View the actual value of pulses applied to terminal 27 in digital output mode.

16-70 Pulse Output #29 [Hz]		
Range:	Function:	
0 N/A*	[0 - 40000 N/A]	View the actual value of pulses at terminal 29 in digital output mode. This parameter is available for FC 302 only.

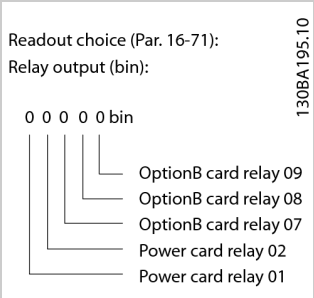
16-71 Relay Output [bin]		
Range:	Function:	
0 * [0 - 511]	View the settings of all relays.	
	<p>Readout choice (Par. 16-71): Relay output (bin):</p>  <p>Illustration 3.65</p>	

16-72 Counter A		
Range:	Function:	
0 N/A* [-2147483648 - 2147483647 N/A]	View the present value of Counter A. Counters are useful as comparator operands, see <i>13-10 Comparator Operand</i> . The value can be reset or changed either via digital inputs (parameter group 5-1* <i>Digital Inputs</i>) or by using an SLC action (<i>13-52 SL Controller Action</i>).	

16-73 Counter B		
Range:	Function:	
0 N/A* [-2147483648 - 2147483647 N/A]	View the present value of Counter B. Counters are useful as comparator operands (<i>13-10 Comparator Operand</i>). The value can be reset or changed either via digital inputs (parameter group 5-1*) or by using an SLC action (<i>13-52 SL Controller Action</i>).	

16-74 Prec. Stop Counter		
Range:	Function:	
0 N/A* [0 - 2147483647 N/A]	Returns the actual counter value of precise counter (<i>1-84 Precise Stop Counter Value</i>).	

16-75 Analog In X30/11		
Range:	Function:	
0.000 * [-20.000 - 20.000]	View the actual value at input X30/11 of MCB 101.	

16-76 Analog In X30/12		
Range:	Function:	
0.000 * [-20.000 - 20.000]	View the actual value at input X30/12 of MCB 101.	

16-77 Analog Out X30/8 [mA]		
Range:	Function:	
0.000 * [0.000 - 30.000]	View the actual value at input X30/8 in mA.	

16-78 Analog Out X45/1 [mA]		
Range:	Function:	
0.000 N/A* [0.000 - 30.000 N/A]	View the actual value at output X45/1. The value shown reflects the selection in <i>6-70 Terminal X45/1 Output</i> .	

16-79 Analog Out X45/3 [mA]		
Range:	Function:	
0.000 N/A* [0.000 - 30.000 N/A]	View the actual value at output X45/3. The value shown reflects the selection in <i>6-80 Terminal X45/3 Output</i> .	

3.17.5 16-8* Fieldbus & FC Port

Parameters for reporting the BUS references and control words.

16-80 Fieldbus CTW 1		
Range:	Function:	
0 * [0 - 65535]	View the two-byte Control word (CTW) received from the Bus-Master. Interpretation of the Control word depends on the Fieldbus option installed and the Control word profile selected in <i>8-10 Control Profile</i> . For more information, refer to the relevant Fieldbus manual.	

16-82 Fieldbus REF 1		
Range:	Function:	
0 * [-200 - 200]	View the two-byte word sent with the control word from the Bus-Master to set the reference value. For more information, refer to the relevant fieldbus manual.	

16-84 Comm. Option STW		
Range:	Function:	
0 * [0 - 65535]	View the extended Fieldbus comm. option status word. For more information, refer to the relevant Fieldbus manual.	

16-85 FC Port CTW 1		
Range:	Function:	
0 * [0 - 65535]	View the two-byte Control word (CTW) received from the Bus-Master. Interpretation of the control word depends on the Fieldbus option installed and the Control word profile selected in <i>8-10 Control Profile</i> .	

16-86 FC Port REF 1		
Range:	Function:	
0 * [-200 - 200]	View the two-byte Status word (STW) sent to the Bus-Master. Interpretation of the Status word depends on the fieldbus option installed and the Control word profile selected in <i>8-10 Control Profile</i> .	

16-87 Bus Readout Alarm/Warning		
Range:	Function:	
0 * [0 - 65535]	Alarm and Warning numbers in hex as displayed in the Alarm log. The High byte contains the Alarm, the Low byte the Warning. The Alarm number is the first one that occurred after the last reset.	

3.17.6 16-9* Diagnosis Read-Outs

When using MCT-10, the read-out parameters can only be read online, i.e. as the actual status. This means that the status is not stored in the MCT-10 file.

16-90 Alarm Word		
Range:	Function:	
0 * [0 - 4294967295]	View the alarm word sent via the serial communication port in hex code.	

16-91 Alarm Word 2		
Range:	Function:	
0 N/A* [0 - 4294967295 N/A]	View the alarm word sent via the serial communication port in hex code.	

16-92 Warning Word		
Range:	Function:	
0 * [0 - 4294967295]	View the warning word sent via the serial communication port in hex code.	

16-93 Warning Word 2		
Range:	Function:	
0 N/A* [0 - 4294967295 N/A]	View the warning word sent via the serial communication port in hex code.	

16-94 Ext. Status Word		
Range:	Function:	
0 N/A* [0 - 4294967295 N/A]	Returns the extended warning word sent via the serial communication port in hex code.	

16-96 Maintenance Word		
Range:	Function:	
0 [0 - 4294967295]	Readout of the Preventive Maintenance Word. The bits reflect the status for the programmed Preventive Maintenance Events in parameter group 23-1*. 13 bits represent combinations of all the possible items:	
* [0 - 4294967295]	<ul style="list-style-type: none"> • Bit 0: Motor bearings • Bit 1: Pump bearings • Bit 2: Fan bearings • Bit 3: Valve • Bit 4: Pressure transmitter • Bit 5: Flow transmitter • Bit 6: Temperature transmitter • Bit 7: Pump seals • Bit 8: Fan belt • Bit 9: Filter • Bit 10: Drive cooling fan • Bit 11: Drive system health check • Bit 12: Warranty • Bit 13: Maintenance Text 0 • Bit 14: Maintenance Text 1 • Bit 15: Maintenance Text 2 • Bit 16: Maintenance Text 3 • Bit 17: Maintenance Text 4 	

3

16-96 Maintenance Word				
Range:	Function:			
Position 4 →	Valve	Fan bearings	Pump bearings	Motor bearings
Position 3 →	Pump seals	Temperature transmitter	Flow transmitter	Pressure transmitter
Position 2 →	Drive system health check	Drive cooling fan	Filter	Fan belt
Position 1 →				Warranty
0 _{hex}	-	-	-	-
1 _{hex}	-	-	-	+
2 _{hex}	-	-	+	-
3 _{hex}	-	-	+	+
4 _{hex}	-	+	-	-
5 _{hex}	-	+	-	+
6 _{hex}	-	+	+	-
7 _{hex}	-	+	+	+
8 _{hex}	+	-	-	-
9 _{hex}	+	-	-	+
A _{hex}	+	-	+	-
B _{hex}	+	-	+	+
C _{hex}	+	+	-	-
D _{hex}	+	+	-	+
E _{hex}	+	+	+	-
F _{hex}	+	+	+	+

Table 3.37

Example:
The Preventive Maintenance Word shows 040A_{hex}.

Position	1	2	3	4
hex-value	0	4	0	A

Table 3.38

The first digit 0 indicates that no items from the fourth row requires maintenance
 The second digit 4 refers to the third row indicating that the Drive Cooling Fan requires maintenance
 The third digit 0 indicates that no items from the second row requires maintenance
 The fourth digit A refers to the top row indicating that the Valve and the Pump Bearings require maintenance

3.18 Parameters: 17-** Motor Feedb. Option

Additional parameters to configure the Encoder (MCB 102) or the Resolver (MCB 103) Feedback Option.

3.18.1 17-1* Inc. Enc. Interface

Parameters in this group configure the incremental interface of the MCB 102 option. Note that both the incremental and absolute interfaces are active at the same time.

NOTE

These parameters cannot be adjusted while the motor is running.

17-10 Signal Type		
Select the incremental type (A/B channel) of the encoder in use. Find the information on the encoder data sheet. Select [0] None if the feedback sensor is an absolute encoder only.		
Option:	Function:	
[0]	None	
[1] *	RS422 (5V TTL)	
[2]	Sinusoidal 1Vpp	

17-11 Resolution (PPR)		
Range:	Function:	
1024 N/A* [10 - 10000 N/A]	Enter the resolution of the incremental track, i.e. the number of pulses or periods per revolution.	

3.18.2 17-2* Abs. Enc. Interface

Parameters in this group configure the absolute interface of the MCB 102 option. Note that both the incremental and absolute interfaces are active at the same time.

17-20 Protocol Selection		
Select [1] HIPERFACE if the encoder is absolute only. Select [0] None if the feedback sensor is an incremental encoder only.		
Option:	Function:	
[0] *	None	
[1]	HIPERFACE	
[2]	EnDat	
[4]	SSI	

NOTE

This parameter cannot be adjusted while the motor is running.

17-21 Resolution (Positions/Rev)		
Select the resolution of the absolute encoder, i.e. the number of counts per revolution. The value depends on setting in 17-20 Protocol Selection.		
Range:	Function:	
8192. N/A*	[4. - 131072. N/A]	

NOTE

This parameter cannot be adjusted while the motor is running.

17-24 SSI Data Length		
Range:	Function:	
13 N/A* [13 - 25 N/A]	Set the number of bits for the SSI telegram. Choose 13 bits for single-turn encoders and 25 bits for multi-turn encoder.	

17-25 Clock Rate		
Range:	Function:	
0 kHz* [100 - 0 kHz]	Set the SSI clock rate. With long encoder cables the clock rate must be reduced.	

17-26 SSI Data Format		
Option:	Function:	
[0] * Gray code		
[1] Binary code	Set the data format of the SSI data. Choose between Gray or Binary format.	

17-34 HIPERFACE Baudrate		
Select the baud rate of the attached encoder. The parameter is only accessible when 17-20 Protocol Selection is set to [1] HIPERFACE.		
Option:	Function:	
[0]	600	
[1]	1200	
[2]	2400	
[3]	4800	
[4] *	9600	
[5]	19200	
[6]	38400	

NOTE

This parameter cannot be adjusted while the motor is running.

3.18.3 17-5* Resolver Interface

Parameter group 17-5* is used for setting parameters for the MCB 103 Resolver Option.

Usually the resolver feedback is used as motor feedback from Permanent Magnet motors with 1-01 Motor Control Principle set to Flux with motor feedback.

Resolver parameters cannot be adjusted while the motor is running.

17-50 Poles		
Range:		Function:
2 N/A*	[2 - 2 N/A]	Set the number of poles on the resolver. The value is stated in the data sheet for resolvers.

17-51 Input Voltage		
Range:		Function:
7.0 V*	[2.0 - 8.0 V]	Set the input voltage to the resolver. The voltage is stated as RMS value. The value is stated in the data sheet for resolvers

17-52 Input Frequency		
Range:		Function:
10.0 kHz*	[2.0 - 15.0 kHz]	Set the input frequency to the resolver. The value is stated in the data sheet for resolvers.

17-53 Transformation Ratio		
Range:		Function:
0.5 N/A*	[0.1 - 1.1 N/A]	Set the transformation ratio for the resolver. The transformation ratio is: $T_{ratio} = \frac{V_{Out}}{V_{In}}$ The value is stated in the data sheet for resolvers.

17-56 Encoder Sim. Resolution		
Set the resolution and activate the encoder emulation function (generation of encoder signals from the measured position from a resolver). Needed when necessary to transfer the speed or position information from one drive to another. To disable the function, select [0] Disabled.		
Option:		Function:
[0] *	Disabled	
[1]	512	
[2]	1024	
[3]	2048	
[4]	4096	

17-59 Resolver Interface		
Activate the MCB 103 resolver option when the resolver parameters are selected. To avoid damage to resolvers 17-50 Poles – 17-53 Transformation Ratio must be adjusted before activating this parameter.		
Option:		Function:
[0] *	Disabled	
[1]	Enabled	

3.18.4 17-6* Monitoring and Application

This parameter group is for selecting additional functions when MCB 102 Encoder option or MCB 103 Resolver option is fitted into option slot B as speed feedback. Monitoring and Application parameters cannot be adjusted while the motor is running.

17-60 Feedback Direction		
Change the detected encoder rotation direction without changing the wiring to the encoder.		
Option:		Function:
[0] *	Clockwise	
[1]	Counter clockwise	

NOTE

This parameter cannot be adjusted while the motor is running.

17-61 Feedback Signal Monitoring		
Select which reaction the frequency converter should take in case a faulty encoder signal is detected. The encoder function in 17-61 Feedback Signal Monitoring is an electrical check of the hardware circuit in the encoder system.		
Option:		Function:
[0]	Disabled	
[1] *	Warning	
[2]	Trip	
[3]	Jog	
[4]	Freeze Output	
[5]	Max Speed	
[6]	Switch to Open Loop	
[7]	Select Setup 1	
[8]	Select Setup 2	
[9]	Select Setup 3	
[10]	Select Setup 4	
[11]	stop & trip	

3.19 Parameters: 18-** Data Readouts 2

18-36 Analog Input X48/2 [mA]		
Range:	Function:	
0 * [-20 - 20]	View the actual current measured at input X48/2.	

18-37 Temp. Input X48/4		
Range:	Function:	
0 * [-500 - 500]	View the actual temperature measured at input X48/4. The temperature unit is based on the selection in 35-00 Term. X48/4 Temperature Unit.	

18-38 Temp. Input X48/7		
Range:	Function:	
0 * [-500 - 500]	View the actual temperature measured at input X48/7. The temperature unit is based on the selection in 35-02 Term. X48/7 Temperature Unit.	

18-39 Temp. Input X48/10		
Range:	Function:	
0 * [-500 - 500]	View the actual temperature measured at input X48/10. The temperature unit is based on the selection in 35-04 Term. X48/10 Temperature Unit.	

18-60 Digital Input 2		
Range:	Function:	
0 * [0 - 65535]	View the signal states from the active digital inputs. '0' = no signal, '1' = connected signal.	

18-90 Process PID Error		
Range:	Function:	
0 %* [-200 - 200 %]		

18-91 Process PID Output		
Range:	Function:	
0 %* [-200 - 200 %]		

18-92 Process PID Clamped Output		
Range:	Function:	
0 %* [-200 - 200 %]		

18-93 Process PID Gain Scaled Output		
Range:	Function:	
0 %* [-200 - 200 %]		

3.20 Parameters: 30-** Special Features

3.20.1 30-0* Wobble Function

The wobble function is primarily used for synthetic yarn winding applications. The wobble option is to be installed in the frequency converter controlling the traverse drive. The traverse drive frequency converter will move the yarn back and forth in a diamond pattern across the surface of the yarn package. To prevent a buildup of yarn at the same points at the surface, this pattern must be altered. The wobble option can accomplish this by continuously varying the traverse velocity in a programmable cycle. The wobble function is created by superimposing a delta frequency around a center frequency. To compensate for the inertia in the system a quick frequency jump can be included. Especially suitable for elastic yarn applications the option features a randomized wobble ratio.

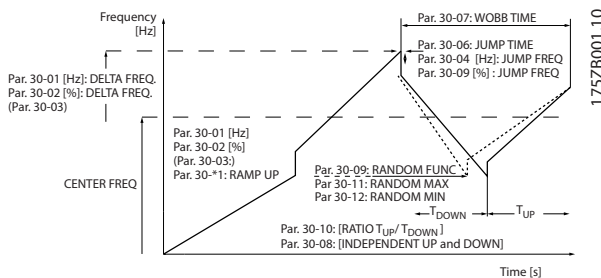

Illustration 3.66

30-00 Wobble Mode		
Option:	Function:	
	The standard speed open loop mode in 1-00 Configuration Mode is extended with a wobble function. In this parameter it is possible to select which method to be used for the wobblers. The parameters can be set as absolute values (direct frequencies) or as relative values (percentage of other parameter). The wobble cycle time can be set as an absolute value or as independent up- and down times. When using an absolute cycle time, the up- and down times are configured through the wobble ratio.	
[0] *	Abs. Freq., Abs. Time	
[1]	Abs. Freq., Up/ Down Time	
[2]	Rel. Freq., Abs. Time	
[3]	Rel. Freq., Up/ Down Time	

NOTE

This parameter cannot be adjusted while running.

NOTE

The setting of "Center Frequency" takes place via the normal reference handling parameter group, 3-1*

30-01 Wobble Delta Frequency [Hz]		
Range:	Function:	
5 Hz* [0 - 25 Hz]	The delta frequency is determining the magnitude of the wobble frequency. The delta frequency is superimposed on the center frequency. 30-01 Wobble Delta Frequency [Hz] is selecting both the positive and negative delta frequency. The setting of 30-01 Wobble Delta Frequency [Hz] must thus not be higher than the setting of the center frequency. The initial ramp up time from standstill until the wobble sequence is running is determined by parameter group 3-1*.	

30-02 Wobble Delta Frequency [%]		
Range:	Function:	
25 %* [0 - 100 %]	The delta frequency can also be expressed as percentage of the center frequency and can thus be maximum 100%. The function is the same as for 30-01 Wobble Delta Frequency [Hz].	

30-03 Wobble Delta Freq. Scaling Resource		
Option:	Function:	
	Select which drive input should be used to scale the delta frequency setting.	
[0] *	No function	
[1]	Analog Input 53	
[2]	Analog Input 54	
[3]	Frequency input 29	FC 302 only
[4]	Frequency input 33	
[7]	Analog Input X30/11	
[8]	Analog Input X30/12	
[15]	Analog Input X48/2	

30-04 Wobble Jump Frequency [Hz]		
Range:	Function:	
0 Hz* [0 - 20.0 Hz]	The jump frequency is used to compensate for the inertia in the traverse system. If a jump in the output frequency is required in the top and in the bottom of the wobble sequence, the frequency jump is set in this parameter. If the traverse system has a very high inertia a high jump frequency may create a torque limit warning or trip (warning/alarm 12) or an over	

30-04 Wobble Jump Frequency [Hz]		
Range:	Function:	
		voltage warning or trip (warning/alarm 7). This parameter can only be changed in stop-mode

30-05 Wobble Jump Frequency [%]		
Range:	Function:	
0 %*	[0 - 100 %]	The jump frequency can also be expressed as percentage of the center frequency. The function is the same as for 30-04 Wobble Jump Frequency [Hz].

30-06 Wobble Jump Time		
Range:	Function:	
Size related*	[0.005 - 5.000 s]	

30-07 Wobble Sequence Time		
Range:	Function:	
10 s*	[1 - 1000 s]	This parameter determines the wobble sequence period. This parameter can only be changed in stop-mode. Wobble time = $t_{up} + t_{down}$

30-08 Wobble Up/ Down Time		
Range:	Function:	
5 s*	[0.1 - 1000 s]	Defines the individual up- and down times for each wobble cycle.

30-09 Wobble Random Function		
Option:	Function:	
[0] *	Off	
[1]	On	

30-10 Wobble Ratio		
Range:	Function:	
1 *	[0.1 - 10]	If the ratio 0.1 is selected: t_{down} is 10 times greater than t_{up} . If the ratio 10 is selected: t_{up} is 10 times greater than t_{down} .

30-11 Wobble Random Ratio Max.		
Range:	Function:	
10 *	[par. 17-53 - 10]	Enter the maximum allowed wobble ratio.

30-12 Wobble Random Ratio Min.		
Range:	Function:	
0.1 *	[0.1 - par. 30-11]	Enter the minimum allowed wobble ratio.

30-19 Wobble Delta Freq. Scaled		
Range:	Function:	
0 Hz*	[0 - 1000 Hz]	Readout parameter. View the actual wobble delta frequency after scaling has been applied.

3.20.2 30-2* Adv. Start Adjust

30-20 High Starting Torque Time [s]		
Range:	Function:	
Size related*	[0 - 60 s]	High starting torque time for PM-Motor in Flux mode without feedback. This parameter is available for FC 302 only.

30-21 High Starting Torque Current [%]		
Range:	Function:	
Size related*	[0 - 200.0 %]	

30-22 Locked Rotor Protection		
Locked Rotor Protection for PM-Motor in Flux mode without feedback. This parameter is available for FC 302 only.		
Option:	Function:	
[0] *	Off	
[1]	On	

30-23 Locked Rotor Detection Time [s]		
Locked Rotor Detection Time for PM-Motor in Flux mode without feedback. This parameter is available for FC 302 only.		
Range:	Function:	
Size related*	[0.05 - 1 s]	

3.20.3 30-8* Compatibility

30-80 d-axis Inductance (Ld)		
Range:	Function:	
0 mH*	[0 - 0.000 mH]	Enter the value of the d-axis inductance. Obtain the value from the permanent magnet motor data sheet. The d-axis inductance cannot be found by performing an AMA.

30-81 Brake Resistor (ohm)		
Range:	Function:	
50. Ohm*	[5. - 32000.0 Ohm]	

30-83 Speed PID Proportional Gain		
Range:	Function:	
0 N/A*	[0.0000 - 1.0000 N/A]	Enter the speed controller proportional gain. Quick control is obtained at high amplification. However if amplification is too great, the process may become unstable.

30-84 Process PID Proportional Gain

Range:		Function:
0.100 *	[0 - 10]	Enter the process controller proportional gain. Quick control is obtained at high amplification. However if amplification is too great, the process may become unstable.

3

3.21 Parameters: 35-** Sensor Input Option

3.21.1 35-0* Temp. Input Mode (MCB 114)

35-00 Term. X48/4 Temperature Unit		
Select the unit to be used with temperature input X48/4 settings and readouts:		
Option:	Function:	
[60] *	°C	
[160]	°F	

35-01 Term. X48/4 Input Type		
View the temperature sensor type detected at input X48/4:		
Option:	Function:	
[0] *	Not Connected	
[1]	PT100 2-wire	
[3]	PT1000 2-wire	
[5]	PT100 3-wire	
[7]	PT1000 3-wire	

35-02 Term. X48/7 Temperature Unit		
Select the unit to be used with temperature input X48/7 settings and readouts:		
Option:	Function:	
[60] *	°C	
[160]	°F	

35-03 Term. X48/7 Input Type		
View the temperature sensor type detected at input X48/7:		
Option:	Function:	
[0] *	Not Connected	
[1]	PT100 2-wire	
[3]	PT1000 2-wire	
[5]	PT100 3-wire	
[7]	PT1000 3-wire	

35-04 Term. X48/10 Temperature Unit		
Select the unit to be used with temperature input X48/10 settings and readouts:		
Option:	Function:	
[60] *	°C	
[160]	°F	

35-05 Term. X48/10 Input Type		
View the temperature sensor type detected at input X48/10:		
Option:	Function:	
[0] *	Not Connected	
[1]	PT100 2-wire	
[3]	PT1000 2-wire	
[5]	PT100 3-wire	
[7]	PT1000 3-wire	

35-06 Temperature Sensor Alarm Function		
Select the alarm function:		
Option:	Function:	
[0]	Off	
[2]	Stop	
[5] *	Stop and trip	

3.21.2 35-1* Temp. Input X48/4 (MCB 114)

35-14 Term. X48/4 Filter Time Constant		
Range:	Function:	
0.001 s* [0.001 - 10 s]	Enter the filter time constant. This is a first-order digital low pass filter time constant for suppressing electrical noise in terminal X48/4. A high time constant value improves dampening but also increases the time delay through the filter.	

35-15 Term. X48/4 Temp. Monitor		
This parameter gives the possibility of enabling or disabling the temperature monitor for terminal X48/4. The temperature limits can be set in 35-16 Term. X48/4 Low Temp. Limit and 35-17 Term. X48/4 High Temp. Limit.		
Option:	Function:	
[0] *	Disabled	
[1]	Enabled	

35-16 Term. X48/4 Low Temp. Limit		
Range:	Function:	
Size related* [-50 - par. 35-17]	Enter the minimum temperature reading that is expected for normal operation of the temperature sensor at terminal X48/4.	

35-17 Term. X48/4 High Temp. Limit		
Range:	Function:	
Size related* [par. 35-16 - 204]	Enter the maximum temperature reading that is expected for normal operation of the temperature sensor at terminal X48/4.	

3.21.3 35-2* Temp. Input X48/7 (MCB 114)

35-24 Term. X48/7 Filter Time Constant		
Range:	Function:	
0.001 s* [0.001 - 10 s]	Enter the filter time constant. This is a first-order digital low pass filter time constant for suppressing electrical noise in terminal X48/7. A high time constant value improves dampening but also	

35-24 Term. X48/7 Filter Time Constant		
Range:	Function:	
		increases the time delay through the filter.

35-25 Term. X48/7 Temp. Monitor		
This parameter gives the possibility of enabling or disabling the temperature monitor for terminal X48/7. The temperature limits can be set in 35-26 <i>Term. X48/7 Low Temp. Limit</i> and 35-27 <i>Term. X48/7 High Temp. Limit</i> .		
Option:	Function:	
[0] *	Disabled	
[1]	Enabled	

35-26 Term. X48/7 Low Temp. Limit		
Range:	Function:	
Size related*	[-50 - par. 35-27]	

35-27 Term. X48/7 High Temp. Limit		
Range:	Function:	
Size related*	[par. 35-26 - 204]	

3.21.4 35-3* Temp. Input X48/10 (MCB 114)

35-34 Term. X48/10 Filter Time Constant		
Range:	Function:	
0.001 s* [0.001 - 10 s]		Enter the filter time constant. This is a first-order digital low pass filter time constant for suppressing electrical noise in terminal X48/10. A high time constant value improves dampening but also increases the time delay through the filter.

35-35 Term. X48/10 Temp. Monitor		
This parameter gives the possibility of enabling or disabling the temperature monitor for terminal X48/10. The temperature limits can be set in 35-36 <i>Term. X48/10 Low Temp. Limit</i> /35-37 <i>Term. X48/10 High Temp. Limit</i> .		
Option:	Function:	
[0] *	Disabled	
[1]	Enabled	

35-36 Term. X48/10 Low Temp. Limit		
Range:	Function:	
Size related*	[-50 - par. 35-37]	Enter the minimum temperature reading that is expected for normal operation of the temperature sensor at terminal X48/10.

35-37 Term. X48/10 High Temp. Limit		
Range:	Function:	
Size related*	[par. 35-36 - 204]	Enter the maximum temperature reading that is expected for normal operation of the temperature sensor at terminal X48/10.

3.21.5 35-4* Analog Input X48/2 (MCB 114)

35-42 Term. X48/2 Low Current		
Range:	Function:	
4 mA*	[0 - par. 35-43 mA]	Enter the current (mA) that corresponds to the low reference value, set in 35-44 <i>Term. X48/2 Low Ref./Feedb. Value</i> . The value must be set at >2 mA in order to activate the Live Zero Time-out Function in 6-01 <i>Live Zero Timeout Function</i> .

35-43 Term. X48/2 High Current		
Range:	Function:	
20 mA*	[par. 35-42 - 20 mA]	Enter the current (mA) that corresponds to the high reference value (set in 35-45 <i>Term. X48/2 High Ref./Feedb. Value</i>).

35-44 Term. X48/2 Low Ref./Feedb. Value		
Range:	Function:	
0 *	[-999999.999 - 999999.999]	Enter the reference or feedback value (in RPM, Hz, bar, etc.) that corresponds to the voltage or current set in 35-42 <i>Term. X48/2 Low Current</i> .

35-45 Term. X48/2 High Ref./Feedb. Value		
Range:	Function:	
100 *	[-999999.999 - 999999.999]	Enter the reference or feedback value (in RPM, Hz, bar, etc.) that corresponds to the voltage or current set in 35-43 <i>Term. X48/2 High Current</i> .

35-46 Term. X48/2 Filter Time Constant		
Range:	Function:	
0.001 s* [0.001 - 10 s]		Enter the filter time constant. This is a first-order digital low pass filter time constant for suppressing electrical noise in terminal X48/2. A high time constant value improves dampening but also increases the time delay through the filter.

4 Parameter Lists

Frequency converter series

All = valid for FC 301 and FC 302 series

01 = valid for FC 301 only

02 = valid for FC 302 only

Changes during operation

"TRUE" means that the parameter can be changed while the frequency converter is in operation and "FALSE" means that the frequency converter must be stopped before a change can be made.

4-Set-up

'All set-ups': the parameter can be set individually in each of the four set-ups, i. e. one single parameter can have four different data values.

'1 set-up': data value will be the same in all set-ups.

Data type	Description	Type
2	Integer 8	Int8
3	Integer 16	Int16
4	Integer 32	Int32
5	Unsigned 8	UInt8
6	Unsigned 16	UInt16
7	Unsigned 32	UInt32
9	Visible String	VisStr
33	Normalized value 2 bytes	N2
35	Bit sequence of 16 boolean variables	V2
54	Time difference w/o date	TimD

Table 4.1

4.1.1 Conversion

The various attributes of each parameter are displayed in Factory Setting. Parameter values are transferred as whole numbers only. Conversion factors are therefore used to transfer decimals.

4-12 Motor Speed Low Limit [Hz] has a conversion factor of 0.1. To preset the minimum frequency to 10 Hz, transfer the value 100. A conversion factor of 0.1 means that the value transferred is multiplied by 0.1. The value 100 is therefore read as 10.0.

Examples:

0s ⇒ conversion index 0

0.00s ⇒ conversion index -2

0ms ⇒ conversion index -3

0.00ms ⇒ conversion index -5

Conversion index	Conversion factor
100	
75	
74	
67	
6	1000000
5	100000
4	10000
3	1000
2	100
1	10
0	1
-1	0.1
-2	0.01
-3	0.001
-4	0.0001
-5	0.00001
-6	0.000001
-7	0.0000001

Table 4.2 Conversion Table

4.1.2 Active/Inactive Parameters in Different Drive Control Modes

+ = active

- = not active

1-10 Motor Construction	AC motor				PM Non salient Motor			
1-01 Motor Control Principle	U/f mode	VVC ^{plus}	Flux sensorless	Flux w/ motor feedback	U/f mode	VVC ^{plus}	Flux sensorless	Flux w/ motor feedback
0-** Operation and Display (all parameters)	+	+	+	+				
1-00 Configuration Mode								
[0] Speed Open Loop	+	+	+	-				
[1] Speed Closed Loop	-	+	-	+				
[2] Torque	-	-	-	+				
[3] Process	+	+	+	-				
[4] Torque Open Loop	-	+	-	-				
[5] Wobble	+	+	+	+				
[6] Surface Winder	+	+	+	-				
[7] Ext. PID Open Loop	+	+	+	-				
[8] Ext. PID Closed Loop	-	+	-	+				
1-02 Flux Motor Feedback Source	-	-	-	+				
1-03 Torque Characteristics	-	see 1, 2, 3)	see 1, 3, 4)	see 1, 3, 4)				
1-04 Overload Mode	+	+	+	+	+		+	+
1-05 Local Mode Configuration	+	+	+	+	+		+	+
1-06 Clockwise Direction	+	+	+	+	+		+	+
1-20 Motor Power [kW] (Par. 023 = International)	+	+	+	+				

1-10 Motor Construction	AC motor				PM Non salient Motor			
1-01 Motor Control Principle	U/f mode	VVC ^{plus}	Flux sensorless	Flux w/ motor feedback	U/f mode	VVC ^{plus}	Flux sensorless	Flux w/ motor feedback
1-21 Motor Power [HP] (Par. 023 = US)	+	+	+	+				
1-22 Motor Voltage	+	+	+	+				
1-23 Motor Frequency	+	+	+	+				
1-24 Motor Current	+	+	+	+				
1-25 Motor Nominal Speed	+	+	+	+				
1-26 Motor Cont. Rated Torque	-	-	-	-	+		+	+
1-29 Automatic Motor Adaptation (AMA)	+	+	+	+				
1-30 Stator Resistance (Rs)	+	+	+	+	+			
1-31 Rotor Resistance (Rr)	-	+ see 5)	+	+				
1-33 Stator Leakage Reactance (X1)	+	+	+	+	+			
1-34 Rotor Leakage Reactance (X2)	-	+ see 5)	+	+				
1-35 Main Reactance (Xh)	+	+	+	+	+			
1-36 Iron Loss Resistance (Rfe)	-	-	+	+	-		-	-
1-37 d-axis Inductance (Ld)	-	-	-	-			+	+
1-39 Motor Poles	+	+	+	+				
1-40 Back EMF at 1000 RPM	-	-	-	-	+		+	+
1-41 Motor Angle Offset	-	-	-	-				+
1-50 Motor Magnetisation at Zero Speed	-	+	-	-	-		-	-
1-51 Min Speed Normal Magnetising [RPM](Par. 002 = rmp)	-	+	-	-	-		-	-
1-52 Min Speed Normal Magnetising [Hz](Par. 002 = Hz)	-	+	-	-	-		-	-
1-53 Model Shift Frequency	-	-	+	+	-		+	+
1-54 Voltage reduction in fieldweakening	-	-	+ see 6)	+	-		-	-
1-55 U/f Characteristic - U	+	-	-	-	+		-	-
1-56 U/f Characteristic - F	+	-	-	-	+		-	-
1-58 Flystart Test Pulses Current	-	+	-	-	-		-	-
1-59 Flystart Test Pulses Frequency	-	+	-	-	-		-	-
1-60 Low Speed Load Compensation	-	+	-	-	-		-	-
1-61 High Speed Load Compensation	-	+	-	-	-		-	-
1-62 Slip Compensation	-	+ see 7)	+	-	-		-	-
1-63 Slip Compensation Time Constant	+ see 8)	+	+ see 8)	-	+ see 8)		+ see 8)	-
1-64 Resonance Dampening	+	+	+	-	+		+	-
1-65 Resonance Dampening Time Constant	+	+	+	-	+		+	-
1-66 Min. Current at Low Speed	-	-	+	+	-		+	+
1-67 Load Type	-	-	+	-	-		-	-

1-10 Motor Construction	AC motor				PM Non salient Motor			
1-01 Motor Control Principle	U/f mode	VVC ^{plus}	Flux sensorless	Flux w/ motor feedback	U/f mode	VVC ^{plus}	Flux sensorless	Flux w/ motor feedback
1-68 Minimum Inertia	-	-	+	-	-	-	-	-
1-69 Maximum Inertia	-	-	+	-	-	-	-	-
1-71 Start Delay	+	+	+	+	+	+	+	+
1-72 Start Function	+	+	+	+	+	+	+	+
1-73 Flying Start	-	+	+	+	-	-	-	-
1-74 Start Speed [RPM](Par. 002 = rpm)	-	+	-	-	-	-	-	-
1-75 Start Speed [Hz](Par. 002 = Hz)	-	+	-	-	-	-	-	-
1-76 Start Current	-	+	-	-	-	-	-	-
1-80 Function at Stop	+	+	+	+	+	+	+	+
1-81 Min Speed for Function at Stop [RPM] (Par. 002 = rpm)	+	+	+	+	+	+	+	+
1-82 Min Speed for Function at Stop [Hz] (Par. 002 = Hz)	+	+	+	+	+	+	+	+
1-83 Precise Stop Function	+	+	+	+	+	+	+	+
1-84 Precise Stop Counter Value	+	+	+	+	+	+	+	+
1-85 Precise Stop Speed Compensation Delay	+	+	+	+	+	+	+	+
1-90 Motor Thermal Protection	+	+	+	+				
1-91 Motor External Fan	+	+	+	+				
1-93 Thermistor Resource	+	+	+	+				
1-95 KTY Sensor Type	+	+	+	+				
1-96 KTY Thermistor Resource	+	+	+	+				
1-97 KTY Threshold level	+	+	+	+				
1-98 ATEX ETR interpol. points freq.	+	+	+	+				
1-99 ATEX ETR interpol points current	+	+	+	+				
2-00 DC Hold Current	+	+	+	+				
2-01 DC Brake Current	+	+	+	+				
2-02 DC Braking Time	+	+	+	+				
2-03 DC Brake Cut In Speed [RPM]	+	+	+	+				
2-04 DC Brake Cut In Speed [Hz]	+	+	+	+				
2-05 Maximum Reference	+	+	+	+				
2-10 Brake Function	+	+	+	+				
	see 9)							
2-11 Brake Resistor (ohm)	+	+	+	+				
2-12 Brake Power Limit (kW)	+	+	+	+				
2-13 Brake Power Monitoring	+	+	+	+				
2-15 Brake Check	+	+	+	+				
	see 9)							
2-16 AC brake Max. Current	-	+	+	+				
2-17 Over-voltage Control	+	+	+	+				
2-18 Brake Check Condition	+	+	+	+				
2-19 Over-voltage Gain	+	+	+	-				
2-20 Release Brake Current	+	+	+	+				

1-10 Motor Construction	AC motor				PM Non salient Motor			
	U/f mode	VVC ^{plus}	Flux sensorless	Flux w/ motor feedback	U/f mode	VVC ^{plus}	Flux sensorless	Flux w/ motor feedback
2-21 Activate Brake Speed [RPM]	+	+	+	+				
2-22 Activate Brake Speed [Hz]	+	+	+	+				
2-23 Activate Brake Delay	+	+	+	+				
2-24 Stop Delay	-	-	-	+				
2-25 Brake Release Time	-	-	-	+				
2-26 Torque Ref	-	-	-	+				
2-27 Torque Ramp Time	-	-	-	+				
2-28 Gain Boost Factor	-	-	-	+				
3-** Reference/Ramps (all parameters)	+	+	+	+				
4-10 Motor Speed Direction	+	+	+	+				
4-11 Motor Speed Low Limit [RPM]	+	+	+	+				
4-12 Motor Speed Low Limit [Hz]	+	+	+	+				
4-13 Motor Speed High Limit [RPM]	+	+	+	+				
4-14 Motor Speed High Limit [Hz]	+	+	+	+				
4-16 Torque Limit Motor Mode	+	+	+	+				
4-17 Torque Limit Generator Mode	+	+	+	+				
4-18 Current Limit	+	+	+	+				
4-19 Max Output Frequency	+	+	+	+				
4-20 Torque Limit Factor Source	+	+	+	+				
4-21 Speed Limit Factor Source	-	+ see 10)	-	+ see 11)				
4-30 Motor Feedback Loss Function	-	+ see 12)	-	+ see 12)				
4-31 Motor Feedback Speed Error	-	+ see 12)	-	+ see 12)				
4-32 Motor Feedback Loss Timeout	-	+ see 12)	-	+ see 12)				
4-34 Tracking Error Function	+	+	+	+				
4-35 Tracking Error	+	+	+	+				
4-36 Tracking Error Timeout	+	+	+	+				
4-37 Tracking Error Ramping	+	+	+	+				
4-38 Tracking Error Ramping Timeout	+	+	+	+				
4-39 Tracking Error After Ramping Timeout	+	+	+	+				
4-50 Warning Current Low	+	+	+	+				
4-51 Warning Current High	+	+	+	+				
4-52 Warning Speed Low	+	+	+	+				
4-53 Warning Speed High	+	+	+	+				
4-54 Warning Reference Low	+	+	+	+				
4-55 Warning Reference High	+	+	+	+				
4-56 Warning Feedback Low	+	+	+	+				
4-57 Warning Feedback High	+	+	+	+				
4-58 Missing Motor Phase Function	+	+	+	+				

1-10 Motor Construction	AC motor				PM Non salient Motor			
1-01 Motor Control Principle	U/f mode	VVC ^{plus}	Flux sensorless	Flux w/ motor feedback	U/f mode	VVC ^{plus}	Flux sensorless	Flux w/ motor feedback
4-60 Bypass Speed From [RPM]	+	+	+	+				
4-61 Bypass Speed From [Hz]	+	+	+	+				
4-62 Bypass Speed To [RPM]	+	+	+	+				
4-63 Bypass Speed To [Hz]	+	+	+	+				
5-** Digital In/Out (all parameters except 5-70 and 71)	+	+	+	+				
5-70 Term 32/33 Pulses per Revolution	-	+ see 12)	-	+				
5-71 Term 32/33 Encoder Direction	-	+ see 12)	-	+				
6-** Analog In/Out (all parameters)	+	+	+	+				
7-00 Speed PID Feedback Source	-	+ see 12)	-	+				
7-02 Speed PID Proportional Gain	-	+ see 12)	+	+				
7-03 Speed PID Integral Time	-	+ see 12)	+	+				
7-04 Speed PID Differentiation Time	-	+ see 12)	+	+				
7-05 Speed PID Diff. Gain Limit	-	+ see 12)	+	+				
7-06 Speed PID Lowpass Filter Time	-	+ see 12)	+	+				
7-07 Speed PID Feedback Gear Ratio	-	+ see 12)	-	+				
7-08 Speed PID Feed Forward Factor	-	+ see 12)	-	-				
7-12 Torque PI Proportional Gain	-	+ see 10)	-	-				
7-13 Torque PI Integration Time	-	+ see 10)	-	-				
7-20 Process CL Feedback 1 Resource	+	+	+	+				
7-22 Process CL Feedback 2 Resource	+	+	+	+				
7-30 Process PID Normal/ Inverse Control	+	+	+	+				
7-31 Process PID Anti Windup	+	+	+	+				
7-32 Process PID Start Speed	+	+	+	+				
7-33 Process PID Proportional Gain	+	+	+	+				
7-34 Process PID Integral Time	+	+	+	+				
7-35 Process PID Differentiation Time	+	+	+	+				
7-36 Process PID Diff. Gain Limit	+	+	+	+				
7-38 Process PID Feed Forward Factor	+	+	+	+				
7-39 On Reference Bandwidth	+	+	+	+				
7-40 Process PID I-part Reset	+	+	+	+				
7-41 Process PID Output Neg. Clamp	+	+	+	+				
7-42 Process PID Output Pos. Clamp	+	+	+	+				

1-10 Motor Construction	AC motor				PM Non salient Motor			
	U/f mode	VVC ^{plus}	Flux sensorless	Flux w/ motor feedback	U/f mode	VVC ^{plus}	Flux sensorless	Flux w/ motor feedback
1-01 Motor Control Principle								
7-43 Process PID Gain Scale at Min. Ref.	+	+	+	+				
7-44 Process PID Gain Scale at Max. Ref.	+	+	+	+				
7-45 Process PID Feed Fwd Resource	+	+	+	+				
7-46 Process PID Feed Fwd Normal/ Inv. Ctrl.	+	+	+	+				
7-48 PCD Feed Forward	+	+	+	+				
7-49 Process PID Output Normal/ Inv. Ctrl.	+	+	+	+				
7-50 Process PID Extended PID	+	+	+	+				
7-51 Process PID Feed Fwd Gain	+	+	+	+				
7-52 Process PID Feed Fwd Ramp up	+	+	+	+				
7-53 Process PID Feed Fwd Ramp down	+	+	+	+				
7-56 Process PID Ref. Filter Time	+	+	+	+				
7-57 Process PID Fb. Filter Time	+	+	+	+				
8-** Communications and Options (all parameters)	+	+	+	+				
13-** Smart Logic Control (all parameters)	+	+	+	+				
14-00 Switching Pattern	+	+	+	+				
14-01 Switching Frequency	+	+	+	+				
14-03 Overmodulation	+	+	+	+				
14-04 PWM Random	+	+	+	+				
14-06 Dead Time Compensation	+	+	+	+				
14-10 Mains Failure								
[0] No function	+	+	+	+				
[1] Ctrl. rampdown	-	+	+	+				
[2] Ctrl. rampdown, trip	-	+	+	+				
[3] Coasting	+	+	+	+				
[4] Kinetic back-up	-	+	+	+				
[5] Kinetic back-up, trip	-	+	+	+				
[6] Alarm	+	+	+	+				
14-11 Mains Voltage at Mains Fault	+	+	+	+				
14-12 Function at Mains Imbalance	+	+	+	+				
14-14 Kin. Backup Time Out	-	-	+	+				
14-15 Kin. Backup Trip Recovery Level	+	+	+	+				
14-20 Reset Mode	+	+	+	+				
14-21 Automatic Restart Time	+	+	+	+				
14-22 Operation Mode	+	+	+	+				
14-24 Trip Delay at Current Limit	+	+	+	+				
14-25 Trip Delay at Torque Limit	+	+	+	+				
14-26 Trip Delay at Inverter Fault	+	+	+	+				
14-29 Service Code	+	+	+	+				

1-10 Motor Construction	AC motor				PM Non salient Motor			
1-01 Motor Control Principle	U/f mode	VVC ^{plus}	Flux sensorless	Flux w/ motor feedback	U/f mode	VVC ^{plus}	Flux sensorless	Flux w/ motor feedback
14-30 Current Lim Ctrl, Proportional Gain	+	+	+	+				
14-31 Current Lim Ctrl, Integration Time	+	+	+	+				
14-32 Current Lim Ctrl, Filter Time	+	+	+	+				
14-35 Stall Protection	-	-	+	+				
14-40 VT Level	-	+	+	+				
14-41 AEO Minimum Magnetisation	-	+	+	+				
14-42 Minimum AEO Frequency	-	+	+	+				
14-43 Motor Cosphi	-	+	+	+				
14-50 RFI Filter	+	+	+	+				
14-51 DC Link Compensation	+	+	+	+				
14-52 Fan Control	+	+	+	+				
14-53 Fan Monitor	+	+	+	+				
14-55 Output Filter	+	+	+	+				
14-56 Capacitance Output Filter	-	-	+	+				
14-57 Inductance Output Filter	-	-	+	+				
14-74 VLT Ext. Status Word	+	+	+	+				
14-80 Option Supplied by External 24VDC	+	+	+	+				
14-89 Option Detection	+	+	+	+				
14-90 Fault Level	+	+	+	+				

Table 4.3

- 1) Constant torque
- 2) Variable torque
- 3) AEO
- 4) Constant power
- 5) Used in flystart
- 6) Used when 1-03 Torque Characteristics is constant power
- 7) Not used when 1-03 Torque Characteristics = VT
- 8) Part of resonance damping
- 9) Not AC brake
- 10) Torque open loop
- 11) Torque
- 12) Speed closed loop

4.1.3 0-** Operation/Display

Par. No. #	Parameter description	Default value	4-set-up	FC 302 only	Change during operation	Conversion index	Type
0-0* Basic Settings							
0-01	Language	[0] English	1 set-up		TRUE	-	Uint8
0-02	Motor Speed Unit	[0] RPM	2 set-ups		FALSE	-	Uint8
0-03	Regional Settings	[0] International	2 set-ups		FALSE	-	Uint8
0-04	Operating State at Power-up (Hand)	[1] Forced stop, ref=old	All set-ups		TRUE	-	Uint8
0-09	Performance Monitor	0.0 %	All set-ups		TRUE	-1	Uint16
0-1* Set-up Operations							
0-10	Active Set-up	[1] Set-up 1	1 set-up		TRUE	-	Uint8
0-11	Edit Set-up	[1] Set-up 1	All set-ups		TRUE	-	Uint8
0-12	This Set-up Linked to	[0] Not linked	All set-ups		FALSE	-	Uint8
0-13	Readout: Linked Set-ups	0 N/A	All set-ups		FALSE	0	Uint16
0-14	Readout: Edit Set-ups / Channel	0 N/A	All set-ups		TRUE	0	Int32
0-15	Readout: actual setup	0 N/A	All set-ups		FALSE	0	Uint8
0-2* LCP Display							
0-20	Display Line 1.1 Small	1617	All set-ups		TRUE	-	Uint16
0-21	Display Line 1.2 Small	1614	All set-ups		TRUE	-	Uint16
0-22	Display Line 1.3 Small	1610	All set-ups		TRUE	-	Uint16
0-23	Display Line 2 Large	1613	All set-ups		TRUE	-	Uint16
0-24	Display Line 3 Large	1602	All set-ups		TRUE	-	Uint16
0-25	My Personal Menu	App.Dependent	1 set-up		TRUE	0	Uint16
0-3* LCP Custom Readout							
0-30	Unit for User-defined Readout	[0] None	All set-ups		TRUE	-	Uint8
0-31	Min Value of User-defined Readout	0.00 CustomReadoutUnit	All set-ups		TRUE	-2	Int32
0-32	Max Value of User-defined Readout	100.00 CustomReadoutUnit	All set-ups		TRUE	-2	Int32
0-37	Display Text 1	0 N/A	1 set-up		TRUE	0	VisStr[25]
0-38	Display Text 2	0 N/A	1 set-up		TRUE	0	VisStr[25]
0-39	Display Text 3	0 N/A	1 set-up		TRUE	0	VisStr[25]
0-4* LCP Keypad							
0-40	[Hand on] Key on LCP	null	All set-ups		TRUE	-	Uint8
0-41	[Off] Key on LCP	null	All set-ups		TRUE	-	Uint8
0-42	[Auto on] Key on LCP	null	All set-ups		TRUE	-	Uint8
0-43	[Reset] Key on LCP	null	All set-ups		TRUE	-	Uint8
0-44	[Off/Reset] Key on LCP	null	All set-ups		TRUE	-	Uint8
0-45	[Drive Bypass] Key on LCP	null	All set-ups		TRUE	-	Uint8
0-5* Copy/Save							
0-50	LCP Copy	[0] No copy	All set-ups		FALSE	-	Uint8
0-51	Set-up Copy	[0] No copy	All set-ups		FALSE	-	Uint8
0-6* Password							
0-60	Main Menu Password	100 N/A	1 set-up		TRUE	0	Int16
0-61	Access to Main Menu w/o Password	[0] Full access	1 set-up		TRUE	-	Uint8
0-65	Quick Menu Password	200 N/A	1 set-up		TRUE	0	Int16
0-66	Access to Quick Menu w/o Password	[0] Full access	1 set-up		TRUE	-	Uint8
0-67	Bus Password Access	0 N/A	All set-ups		TRUE	0	Uint16

Table 4.4

4.1.4 1-** Load/Motor

4

Par. No. #	Parameter description	Default value	4-set-up	Change during operation	Conversion index	Type
1-0* General Settings						
1-00	Configuration Mode	App.Dependent	All set-ups	TRUE	-	Uint8
1-01	Motor Control Principle	App.Dependent	All set-ups	FALSE	-	Uint8
1-02	Flux Motor Feedback Source	[1] 24 V encoder	All set-ups	FALSE	-	Uint8
1-03	Torque Characteristics	[0] Constant torque	All set-ups	TRUE	-	Uint8
1-04	Overload Mode	[0] High torque	All set-ups	FALSE	-	Uint8
1-05	Local Mode Configuration	[2] As mode par 1-00	All set-ups	TRUE	-	Uint8
1-06	Clockwise Direction	[0] Normal	All set-ups	FALSE	-	Uint8
1-07	Motor Angle Offset Adjust	[0] Manual	All set-ups	FALSE	-	Uint8
1-1* Motor Selection						
1-10	Motor Construction	App.Dependent	All set-ups	FALSE	-	Uint8
1-11	Motor Model	App.Dependent	All set-ups	FALSE	-	Uint8
1-14	Damping Gain	140%	All set-ups	TRUE	0	Int16
1-15	Low Speed Filter Time Const.	App.Dependent	All set-ups	TRUE	-2	Uint16
1-16	High Speed Filter Time Const.	App.Dependent	All set-ups	TRUE	-2	Uint16
1-17	Voltage filter time const.	App.Dependent	All set-ups	TRUE	-3	Uint16
1-2* Motor Data						
1-20	Motor Power [kW]	App.Dependent	All set-ups	FALSE	1	Uint32
1-21	Motor Power [HP]	App.Dependent	All set-ups	FALSE	-2	Uint32
1-22	Motor Voltage	App.Dependent	All set-ups	FALSE	0	Uint16
1-23	Motor Frequency	App.Dependent	All set-ups	FALSE	0	Uint16
1-24	Motor Current	App.Dependent	All set-ups	FALSE	-2	Uint32
1-25	Motor Nominal Speed	App.Dependent	All set-ups	FALSE	67	Uint16
1-26	Motor Cont. Rated Torque	App.Dependent	All set-ups	FALSE	-1	Uint32
1-29	Automatic Motor Adaptation (AMA)	[0] Off	All set-ups	FALSE	-	Uint8
1-3* Adv. Motor Data						
1-30	Stator Resistance (Rs)	App.Dependent	All set-ups	FALSE	-4	Uint32
1-31	Rotor Resistance (Rr)	App.Dependent	All set-ups	FALSE	-4	Uint32
1-33	Stator Leakage Reactance (X1)	App.Dependent	All set-ups	FALSE	-4	Uint32
1-34	Rotor Leakage Reactance (X2)	App.Dependent	All set-ups	FALSE	-4	Uint32
1-35	Main Reactance (Xh)	App.Dependent	All set-ups	FALSE	-4	Uint32
1-36	Iron Loss Resistance (Rfe)	App.Dependent	All set-ups	FALSE	-3	Uint32
1-37	d-axis Inductance (Ld)	App.Dependent	All set-ups	FALSE	-4	Int32
1-39	Motor Poles	App.Dependent	All set-ups	FALSE	0	Uint8
1-40	Back EMF at 1000 RPM	App.Dependent	All set-ups	FALSE	0	Uint16
1-41	Motor Angle Offset	0 N/A	All set-ups	FALSE	0	Int16
1-46	Position Detection Gain	100%	All set-ups	TRUE	0	Uint16
1-47	Low Speed Torque Calibration	App.Dependent	All set-ups	TRUE	-	Uint8
1-5* Load Indep. Setting						
1-50	Motor Magnetisation at Zero Speed	100%	All set-ups	TRUE	0	Uint16
1-51	Min Speed Normal Magnetising [RPM]	App.Dependent	All set-ups	TRUE	67	Uint16
1-52	Min Speed Normal Magnetising [Hz]	App.Dependent	All set-ups	TRUE	-1	Uint16
1-53	Model Shift Frequency	App.Dependent	All set-ups	FALSE	-1	Uint16
1-54	Voltage reduction in fieldweakening	0 V	All set-ups	FALSE	0	Uint8
1-55	U/f Characteristic - U	App.Dependent	All set-ups	TRUE	-1	Uint16
1-56	U/f Characteristic - F	App.Dependent	All set-ups	TRUE	-1	Uint16
1-58	Flystart Test Pulses Current	App.Dependent	All set-ups	FALSE	0	Uint16
1-59	Flystart Test Pulses Frequency	App.Dependent	All set-ups	FALSE	0	Uint16
1-6* Load Depen. Setting						

Par. No. #	Parameter description	Default value	4-set-up	Change during operation	Conversion index	Type
1-60	Low Speed Load Compensation	100%	All set-ups	TRUE	0	Int16
1-61	High Speed Load Compensation	100%	All set-ups	TRUE	0	Int16
1-62	Slip Compensation	App.Dependent	All set-ups	TRUE	0	Int16
1-63	Slip Compensation Time Constant	App.Dependent	All set-ups	TRUE	-2	UInt16
1-64	Resonance Dampening	100%	All set-ups	TRUE	0	UInt16
1-65	Resonance Dampening Time Constant	5 ms	All set-ups	TRUE	-3	UInt8
1-66	Min. Current at Low Speed	100%	All set-ups	TRUE	0	UInt8
1-67	Load Type	[0] Passive load	All set-ups	TRUE	-	UInt8
1-68	Minimum Inertia	App.Dependent	All set-ups	FALSE	-4	UInt32
1-69	Maximum Inertia	App.Dependent	All set-ups	FALSE	-4	UInt32
1-7* Start Adjustments						
1-70	PM Start Mode	[0] Rotor Detection	All set-ups	TRUE	-	UInt8
1-71	Start Delay	0.0 s	All set-ups	TRUE	-1	UInt8
1-72	Start Function	[2] Coast/delay time	All set-ups	TRUE	-	UInt8
1-73	Flying Start	null	All set-ups	FALSE	-	UInt8
1-74	Start Speed [RPM]	App.Dependent	All set-ups	TRUE	67	UInt16
1-75	Start Speed [Hz]	App.Dependent	All set-ups	TRUE	-1	UInt16
1-76	Start Current	0.00 A	All set-ups	TRUE	-2	UInt32
1-8* Stop Adjustments						
1-80	Function at Stop	[0] Coast	All set-ups	TRUE	-	UInt8
1-81	Min Speed for Function at Stop [RPM]	App.Dependent	All set-ups	TRUE	67	UInt16
1-82	Min Speed for Function at Stop [Hz]	App.Dependent	All set-ups	TRUE	-1	UInt16
1-83	Precise Stop Function	[0] Precise ramp stop	All set-ups	FALSE	-	UInt8
1-84	Precise Stop Counter Value	100000 N/A	All set-ups	TRUE	0	UInt32
1-85	Precise Stop Speed Compensation Delay	10 ms	All set-ups	TRUE	-3	UInt8
1-9* Motor Temperature						
1-90	Motor Thermal Protection	[0] No protection	All set-ups	TRUE	-	UInt8
1-91	Motor External Fan	[0] No	All set-ups	TRUE	-	UInt16
1-93	Thermistor Resource	[0] None	All set-ups	TRUE	-	UInt8
1-94	ATEX ETR cur.lim. speed reduction	0.0%	2 set-ups	TRUE	-1	UInt16
1-95	KTY Sensor Type	[0] KTY Sensor 1	All set-ups	TRUE	-	UInt8
1-96	KTY Thermistor Resource	[0] None	All set-ups	TRUE	-	UInt8
1-97	KTY Threshold level	80 °C	1 set-up	TRUE	100	Int16
1-98	ATEX ETR interpol. points freq.	App.Dependent	1 set-up	TRUE	-1	Int16
1-99	ATEX ETR interpol points current	App.Dependent	2 set-ups	TRUE	0	Int16

Table 4.5

4.1.5 2-** Brakes

4

Par. No. #	Parameter description	Default value	4-set-up	Change during operation	Conversion index	Type
2-0* DC-Brake						
2-00	DC Hold Current	50%	All set-ups	TRUE	0	Uint8
2-01	DC Brake Current	50%	All set-ups	TRUE	0	Uint16
2-02	DC Braking Time	10.0 s	All set-ups	TRUE	-1	Uint16
2-03	DC Brake Cut In Speed [RPM]	App.Dependent	All set-ups	TRUE	67	Uint16
2-04	DC Brake Cut In Speed [Hz]	App.Dependent	All set-ups	TRUE	-1	Uint16
2-05	Maximum Reference	MaxReference (P303)	All set-ups	TRUE	-3	Int32
2-06	Parking Current	50%	All set-ups	TRUE	0	Uint16
2-07	Parking Time	3.0 s	All set-ups	TRUE	-1	Uint16
2-1* Brake Energy Funct.						
2-10	Brake Function	null	All set-ups	TRUE	-	Uint8
2-11	Brake Resistor (ohm)	App.Dependent	All set-ups	TRUE	0	Uint16
2-12	Brake Power Limit (kW)	App.Dependent	All set-ups	TRUE	0	Uint32
2-13	Brake Power Monitoring	[0] Off	All set-ups	TRUE	-	Uint8
2-15	Brake Check	[0] Off	All set-ups	TRUE	-	Uint8
2-16	AC brake Max. Current	100.0%	All set-ups	TRUE	-1	Uint32
2-17	Over-voltage Control	[0] Disabled	All set-ups	TRUE	-	Uint8
2-18	Brake Check Condition	[0] At Power Up	All set-ups	TRUE	-	Uint8
2-19	Over-voltage Gain	100%	All set-ups	TRUE	0	Uint16
2-2* Mechanical Brake						
2-20	Release Brake Current	ImaxVLT (P1637)	All set-ups	TRUE	-2	Uint32
2-21	Activate Brake Speed [RPM]	App.Dependent	All set-ups	TRUE	67	Uint16
2-22	Activate Brake Speed [Hz]	App.Dependent	All set-ups	TRUE	-1	Uint16
2-23	Activate Brake Delay	0.0 s	All set-ups	TRUE	-1	Uint8
2-24	Stop Delay	0.0 s	All set-ups	TRUE	-1	Uint8
2-25	Brake Release Time	0.20 s	All set-ups	TRUE	-2	Uint16
2-26	Torque Ref	0.00%	All set-ups	TRUE	-2	Int16
2-27	Torque Ramp Time	0.2 s	All set-ups	TRUE	-1	Uint8
2-28	Gain Boost Factor	1.00 N/A	All set-ups	TRUE	-2	Uint16

Table 4.6

4.1.6 3-** Reference/Ramps

Par. No. #	Parameter description	Default value	4-set-up	Change during operation	Conversion index	Type
3-0* Reference Limits						
3-00	Reference Range	null	All set-ups	TRUE	-	Uint8
3-01	Reference/Feedback Unit	null	All set-ups	TRUE	-	Uint8
3-02	Minimum Reference	App.Dependent	All set-ups	TRUE	-3	Int32
3-03	Maximum Reference	App.Dependent	All set-ups	TRUE	-3	Int32
3-04	Reference Function	[0] Sum	All set-ups	TRUE	-	Uint8
3-1* References						
3-10	Preset Reference	0.00%	All set-ups	TRUE	-2	Int16
3-11	Jog Speed [Hz]	App.Dependent	All set-ups	TRUE	-1	Uint16
3-12	Catch up/slow Down Value	0.00%	All set-ups	TRUE	-2	Int16
3-13	Reference Site	[0] Linked to Hand / Auto	All set-ups	TRUE	-	Uint8
3-14	Preset Relative Reference	0.00%	All set-ups	TRUE	-2	Int32
3-15	Reference Resource 1	null	All set-ups	TRUE	-	Uint8
3-16	Reference Resource 2	null	All set-ups	TRUE	-	Uint8
3-17	Reference Resource 3	null	All set-ups	TRUE	-	Uint8
3-18	Relative Scaling Reference Resource	[0] No function	All set-ups	TRUE	-	Uint8
3-19	Jog Speed [RPM]	App.Dependent	All set-ups	TRUE	67	Uint16
3-4* Ramp 1						
3-40	Ramp 1 Type	[0] Linear	All set-ups	TRUE	-	Uint8
3-41	Ramp 1 Ramp up Time	App.Dependent	All set-ups	TRUE	-2	Uint32
3-42	Ramp 1 Ramp Down Time	App.Dependent	All set-ups	TRUE	-2	Uint32
3-45	Ramp 1 S-ramp Ratio at Accel. Start	50%	All set-ups	TRUE	0	Uint8
3-46	Ramp 1 S-ramp Ratio at Accel. End	50%	All set-ups	TRUE	0	Uint8
3-47	Ramp 1 S-ramp Ratio at Decel. Start	50%	All set-ups	TRUE	0	Uint8
3-48	Ramp 1 S-ramp Ratio at Decel. End	50%	All set-ups	TRUE	0	Uint8
3-5* Ramp 2						
3-50	Ramp 2 Type	[0] Linear	All set-ups	TRUE	-	Uint8
3-51	Ramp 2 Ramp up Time	App.Dependent	All set-ups	TRUE	-2	Uint32
3-52	Ramp 2 Ramp down Time	App.Dependent	All set-ups	TRUE	-2	Uint32
3-55	Ramp 2 S-ramp Ratio at Accel. Start	50%	All set-ups	TRUE	0	Uint8
3-56	Ramp 2 S-ramp Ratio at Accel. End	50%	All set-ups	TRUE	0	Uint8
3-57	Ramp 2 S-ramp Ratio at Decel. Start	50%	All set-ups	TRUE	0	Uint8
3-58	Ramp 2 S-ramp Ratio at Decel. End	50%	All set-ups	TRUE	0	Uint8
3-6* Ramp 3						
3-60	Ramp 3 Type	[0] Linear	All set-ups	TRUE	-	Uint8
3-61	Ramp 3 Ramp up Time	App.Dependent	All set-ups	TRUE	-2	Uint32
3-62	Ramp 3 Ramp down Time	App.Dependent	All set-ups	TRUE	-2	Uint32
3-65	Ramp 3 S-ramp Ratio at Accel. Start	50%	All set-ups	TRUE	0	Uint8
3-66	Ramp 3 S-ramp Ratio at Accel. End	50%	All set-ups	TRUE	0	Uint8
3-67	Ramp 3 S-ramp Ratio at Decel. Start	50%	All set-ups	TRUE	0	Uint8
3-68	Ramp 3 S-ramp Ratio at Decel. End	50%	All set-ups	TRUE	0	Uint8
3-7* Ramp 4						
3-70	Ramp 4 Type	[0] Linear	All set-ups	TRUE	-	Uint8
3-71	Ramp 4 Ramp up Time	App.Dependent	All set-ups	TRUE	-2	Uint32
3-72	Ramp 4 Ramp Down Time	App.Dependent	All set-ups	TRUE	-2	Uint32
3-75	Ramp 4 S-ramp Ratio at Accel. Start	50%	All set-ups	TRUE	0	Uint8
3-76	Ramp 4 S-ramp Ratio at Accel. End	50%	All set-ups	TRUE	0	Uint8
3-77	Ramp 4 S-ramp Ratio at Decel. Start	50%	All set-ups	TRUE	0	Uint8
3-78	Ramp 4 S-ramp Ratio at Decel. End	50%	All set-ups	TRUE	0	Uint8

Par. No. #	Parameter description	Default value	4-set-up	Change during operation	Conversion index	Type
3-80	Jog Ramp Time	App.Dependent	All set-ups	TRUE	-2	Uint32
3-81	Quick Stop Ramp Time	App.Dependent	2 set-ups	TRUE	-2	Uint32
3-82	Quick Stop Ramp Type	[0] Linear	All set-ups	TRUE	-	Uint8
3-83	Quick Stop S-ramp Ratio at Decel. Start	50%	All set-ups	TRUE	0	Uint8
3-84	Quick Stop S-ramp Ratio at Decel. End	50%	All set-ups	TRUE	0	Uint8
3-9* Digital Pot.Meter						
3-90	Step Size	0.10%	All set-ups	TRUE	-2	Uint16
3-91	Ramp Time	1.00 s	All set-ups	TRUE	-2	Uint32
3-92	Power Restore	[0] Off	All set-ups	TRUE	-	Uint8
3-93	Maximum Limit	100%	All set-ups	TRUE	0	Int16
3-94	Minimum Limit	-100%	All set-ups	TRUE	0	Int16
3-95	Ramp Delay	App.Dependent	All set-ups	TRUE	-3	TimD

Table 4.7

4.1.7 4-** Limits / Warnings

Par. No. #	Parameter description	Default value	4-set-up	Change during operation	Conversion index	Type
4-1* Motor Limits						
4-10	Motor Speed Direction	null	All set-ups	FALSE	-	Uint8
4-11	Motor Speed Low Limit [RPM]	App.Dependent	All set-ups	TRUE	67	Uint16
4-12	Motor Speed Low Limit [Hz]	App.Dependent	All set-ups	TRUE	-1	Uint16
4-13	Motor Speed High Limit [RPM]	App.Dependent	All set-ups	TRUE	67	Uint16
4-14	Motor Speed High Limit [Hz]	App.Dependent	All set-ups	TRUE	-1	Uint16
4-16	Torque Limit Motor Mode	App.Dependent	All set-ups	TRUE	-1	Uint16
4-17	Torque Limit Generator Mode	100.0%	All set-ups	TRUE	-1	Uint16
4-18	Current Limit	App.Dependent	All set-ups	TRUE	-1	Uint32
4-19	Max Output Frequency	132.0 Hz	All set-ups	FALSE	-1	Uint16
4-2* Limit Factors						
4-20	Torque Limit Factor Source	[0] No function	All set-ups	TRUE	-	Uint8
4-21	Speed Limit Factor Source	[0] No function	All set-ups	TRUE	-	Uint8
4-3* Motor Speed Mon.						
4-30	Motor Feedback Loss Function	[2] Trip	All set-ups	TRUE	-	Uint8
4-31	Motor Feedback Speed Error	300 RPM	All set-ups	TRUE	67	Uint16
4-32	Motor Feedback Loss Timeout	0.05 s	All set-ups	TRUE	-2	Uint16
4-34	Tracking Error Function	null	All set-ups	TRUE	-	Uint8
4-35	Tracking Error	10 RPM	All set-ups	TRUE	67	Uint16
4-36	Tracking Error Timeout	1.00 s	All set-ups	TRUE	-2	Uint16
4-37	Tracking Error Ramping	100 RPM	All set-ups	TRUE	67	Uint16
4-38	Tracking Error Ramping Timeout	1.00 s	All set-ups	TRUE	-2	Uint16
4-39	Tracking Error After Ramping Timeout	5.00 s	All set-ups	TRUE	-2	Uint16
4-5* Adj. Warnings						
4-50	Warning Current Low	0.00 A	All set-ups	TRUE	-2	Uint32
4-51	Warning Current High	I _{maxVLT} (P1637)	All set-ups	TRUE	-2	Uint32
4-52	Warning Speed Low	0 RPM	All set-ups	TRUE	67	Uint16
4-53	Warning Speed High	outputSpeedHighLimit (P413)	All set-ups	TRUE	67	Uint16
4-54	Warning Reference Low	-999999.999 N/A	All set-ups	TRUE	-3	Int32
4-55	Warning Reference High	999999.999 N/A	All set-ups	TRUE	-3	Int32
4-56	Warning Feedback Low	-999999.999 ReferenceFeed-backUnit	All set-ups	TRUE	-3	Int32
4-57	Warning Feedback High	999999.999 ReferenceFeed-backUnit	All set-ups	TRUE	-3	Int32
4-58	Missing Motor Phase Function	null	All set-ups	TRUE	-	Uint8
4-6* Speed Bypass						
4-60	Bypass Speed From [RPM]	App.Dependent	All set-ups	TRUE	67	Uint16
4-61	Bypass Speed From [Hz]	App.Dependent	All set-ups	TRUE	-1	Uint16
4-62	Bypass Speed To [RPM]	App.Dependent	All set-ups	TRUE	67	Uint16
4-63	Bypass Speed To [Hz]	App.Dependent	All set-ups	TRUE	-1	Uint16

Table 4.8

4.1.8 5-** Digital In/Out

4

Par. No. #	Parameter description	Default value	4-set-up	Change during operation	Conversion index	Type
5-0* Digital I/O mode						
5-00	Digital I/O Mode	[0] PNP	All set-ups	FALSE	-	Uint8
5-01	Terminal 27 Mode	[0] Input	All set-ups	TRUE	-	Uint8
5-02	Terminal 29 Mode	[0] Input	All set-ups	TRUE	-	Uint8
5-1* Digital Inputs						
5-10	Terminal 18 Digital Input	null	All set-ups	TRUE	-	Uint8
5-11	Terminal 19 Digital Input	null	All set-ups	TRUE	-	Uint8
5-12	Terminal 27 Digital Input	null	All set-ups	TRUE	-	Uint8
5-13	Terminal 29 Digital Input	null	All set-ups	TRUE	-	Uint8
5-14	Terminal 32 Digital Input	null	All set-ups	TRUE	-	Uint8
5-15	Terminal 33 Digital Input	null	All set-ups	TRUE	-	Uint8
5-19	Terminal 37 Safe Stop	[1] Safe Stop Alarm	1 set-up	TRUE	-	Uint8
5-3* Digital Outputs						
5-30	Terminal 27 Digital Output	null	All set-ups	TRUE	-	Uint8
5-31	Terminal 29 Digital Output	null	All set-ups	TRUE	-	Uint8
5-4* Relays						
5-40	Function Relay	null	All set-ups	TRUE	-	Uint8
5-41	On Delay, Relay	0.01 s	All set-ups	TRUE	-2	Uint16
5-42	Off Delay, Relay	0.01 s	All set-ups	TRUE	-2	Uint16
5-5* Pulse Input						
5-50	Term. 29 Low Frequency	100 Hz	All set-ups	TRUE	0	Uint32
5-51	Term. 29 High Frequency	100 Hz	All set-ups	TRUE	0	Uint32
5-52	Term. 29 Low Ref./Feedb. Value	0.000 ReferenceFeedbackUnit	All set-ups	TRUE	-3	Int32
5-53	Term. 29 High Ref./Feedb. Value	App.Dependent	All set-ups	TRUE	-3	Int32
5-54	Pulse Filter Time Constant #29	100 ms	All set-ups	FALSE	-3	Uint16
5-55	Term. 33 Low Frequency	100 Hz	All set-ups	TRUE	0	Uint32
5-56	Term. 33 High Frequency	100 Hz	All set-ups	TRUE	0	Uint32
5-57	Term. 33 Low Ref./Feedb. Value	0.000 ReferenceFeedbackUnit	All set-ups	TRUE	-3	Int32
5-58	Term. 33 High Ref./Feedb. Value	App.Dependent	All set-ups	TRUE	-3	Int32
5-59	Pulse Filter Time Constant #33	100 ms	All set-ups	FALSE	-3	Uint16
5-6* Pulse Output						
5-60	Terminal 27 Pulse Output Variable	null	All set-ups	TRUE	-	Uint8
5-62	Pulse Output Max Freq #27	App.Dependent	All set-ups	TRUE	0	Uint32
5-63	Terminal 29 Pulse Output Variable	null	All set-ups	TRUE	-	Uint8
5-65	Pulse Output Max Freq #29	App.Dependent	All set-ups	TRUE	0	Uint32
5-7* 24V Encoder Input						
5-70	Term 32/33 Pulses per Revolution	1024 N/A	All set-ups	FALSE	0	Uint16
5-71	Term 32/33 Encoder Direction	[0] Clockwise	All set-ups	FALSE	-	Uint8
5-8* I/O Options						
5-80	AHF Cap Reconnect Delay	25 s	2 set-ups	TRUE	0	Uint16
5-9* Bus Controlled						
5-90	Digital & Relay Bus Control	0 N/A	All set-ups	TRUE	0	Uint32
5-93	Pulse Out #27 Bus Control	0.00%	All set-ups	TRUE	-2	N2
5-94	Pulse Out #27 Timeout Preset	0.00%	1 set-up	TRUE	-2	Uint16
5-95	Pulse Out #29 Bus Control	0.00%	All set-ups	TRUE	-2	N2
5-96	Pulse Out #29 Timeout Preset	0.00%	1 set-up	TRUE	-2	Uint16

Table 4.9

4.1.9 6-** Analog In/Out

Par. No. #	Parameter description	Default value	4-set-up	Change during operation	Conversion index	Type
6-0* Analog I/O Mode						
6-00	Live Zero Timeout Time	10 s	All set-ups	TRUE	0	Uint8
6-01	Live Zero Timeout Function	[0] Off	All set-ups	TRUE	-	Uint8
6-1* Analog Input 1						
6-10	Terminal 53 Low Voltage	0.07 V	All set-ups	TRUE	-2	Int16
6-11	Terminal 53 High Voltage	10.00 V	All set-ups	TRUE	-2	Int16
6-12	Terminal 53 Low Current	0.14 mA	All set-ups	TRUE	-5	Int16
6-13	Terminal 53 High Current	20.00 mA	All set-ups	TRUE	-5	Int16
6-14	Terminal 53 Low Ref./Feedb. Value	0 ReferenceFeedbackUnit	All set-ups	TRUE	-3	Int32
6-15	Terminal 53 High Ref./Feedb. Value	App.Dependent	All set-ups	TRUE	-3	Int32
6-16	Terminal 53 Filter Time Constant	0.001 s	All set-ups	TRUE	-3	Uint16
6-2* Analog Input 2						
6-20	Terminal 54 Low Voltage	0.07 V	All set-ups	TRUE	-2	Int16
6-21	Terminal 54 High Voltage	10.00 V	All set-ups	TRUE	-2	Int16
6-22	Terminal 54 Low Current	0.14 mA	All set-ups	TRUE	-5	Int16
6-23	Terminal 54 High Current	20.00 mA	All set-ups	TRUE	-5	Int16
6-24	Terminal 54 Low Ref./Feedb. Value	0 ReferenceFeedbackUnit	All set-ups	TRUE	-3	Int32
6-25	Terminal 54 High Ref./Feedb. Value	App.Dependent	All set-ups	TRUE	-3	Int32
6-26	Terminal 54 Filter Time Constant	0.001 s	All set-ups	TRUE	-3	Uint16
6-5* Analog Output 1						
6-50	Terminal 42 Output	null	All set-ups	TRUE	-	Uint8
6-51	Terminal 42 Output Min Scale	0.00%	All set-ups	TRUE	-2	Int16
6-52	Terminal 42 Output Max Scale	100.00%	All set-ups	TRUE	-2	Int16
6-53	Term 42 Output Bus Ctrl	0.00%	All set-ups	TRUE	-2	N2
6-54	Terminal 42 Output Timeout Preset	0.00%	1 set-up	TRUE	-2	Uint16
6-55	Analog Output Filter	[0] Off	1 set-up	TRUE	-	Uint8

Table 4.10

4.1.10 7-** Controllers

4

Par. No. #	Parameter description	Default value	4-set-up	Change during operation	Conversion index	Type
7-0* Speed PID Ctrl.						
7-00	Speed PID Feedback Source	null	All set-ups	FALSE	-	Uint8
7-02	Speed PID Proportional Gain	App.Dependent	All set-ups	TRUE	-3	Uint16
7-03	Speed PID Integral Time	App.Dependent	All set-ups	TRUE	-4	Uint32
7-04	Speed PID Differentiation Time	App.Dependent	All set-ups	TRUE	-4	Uint16
7-05	Speed PID Diff. Gain Limit	5.0 N/A	All set-ups	TRUE	-1	Uint16
7-06	Speed PID Lowpass Filter Time	App.Dependent	All set-ups	TRUE	-4	Uint16
7-07	Speed PID Feedback Gear Ratio	1.0000 N/A	All set-ups	FALSE	-4	Uint32
7-08	Speed PID Feed Forward Factor	0%	All set-ups	FALSE	0	Uint16
7-09	Speed PID Error Correction w/ Ramp	300RPM	All set-ups	TRUE	67	Uint32
7-1* Torque PI Ctrl.						
7-12	Torque PI Proportional Gain	100%	All set-ups	TRUE	0	Uint16
7-13	Torque PI Integration Time	0.020 s	All set-ups	TRUE	-3	Uint16
7-2* Process Ctrl. Feedb						
7-20	Process CL Feedback 1 Resource	[0] No function	All set-ups	TRUE	-	Uint8
7-22	Process CL Feedback 2 Resource	[0] No function	All set-ups	TRUE	-	Uint8
7-3* Process PID Ctrl.						
7-30	Process PID Normal/ Inverse Control	[0] Normal	All set-ups	TRUE	-	Uint8
7-31	Process PID Anti Windup	[1] On	All set-ups	TRUE	-	Uint8
7-32	Process PID Start Speed	0 RPM	All set-ups	TRUE	67	Uint16
7-33	Process PID Proportional Gain	0.01 N/A	All set-ups	TRUE	-2	Uint16
7-34	Process PID Integral Time	10000.00 s	All set-ups	TRUE	-2	Uint32
7-35	Process PID Differentiation Time	0.00 s	All set-ups	TRUE	-2	Uint16
7-36	Process PID Diff. Gain Limit	5.0 N/A	All set-ups	TRUE	-1	Uint16
7-38	Process PID Feed Forward Factor	0%	All set-ups	TRUE	0	Uint16
7-39	On Reference Bandwidth	5%	All set-ups	TRUE	0	Uint8
7-4* Adv. Process PID I						
7-40	Process PID I-part Reset	[0] No	All set-ups	TRUE	-	Uint8
7-41	Process PID Output Neg. Clamp	-100%	All set-ups	TRUE	0	Int16
7-42	Process PID Output Pos. Clamp	100%	All set-ups	TRUE	0	Int16
7-43	Process PID Gain Scale at Min. Ref.	100%	All set-ups	TRUE	0	Int16
7-44	Process PID Gain Scale at Max. Ref.	100%	All set-ups	TRUE	0	Int16
7-45	Process PID Feed Fwd Resource	[0] No function	All set-ups	TRUE	-	Uint8
7-46	Process PID Feed Fwd Normal/ Inv. Ctrl.	[0] Normal	All set-ups	TRUE	-	Uint8
7-48	PCD Feed Forward	0 N/A	All set-ups	TRUE	0	Uint16
7-49	Process PID Output Normal/ Inv. Ctrl.	[0] Normal	All set-ups	TRUE	-	Uint8
7-5* Adv. Process PID II						
7-50	Process PID Extended PID	[1] Enabled	All set-ups	TRUE	-	Uint8
7-51	Process PID Feed Fwd Gain	1.00 N/A	All set-ups	TRUE	-2	Uint16
7-52	Process PID Feed Fwd Ramp up	0.01 s	All set-ups	TRUE	-2	Uint32
7-53	Process PID Feed Fwd Ramp down	0.01 s	All set-ups	TRUE	-2	Uint32
7-56	Process PID Ref. Filter Time	0.001 s	All set-ups	TRUE	-3	Uint16
7-57	Process PID Fb. Filter Time	0.001 s	All set-ups	TRUE	-3	Uint16

Table 4.11

4.1.11 8-** Comm. and Options

Par. No. #	Parameter description	Default value	4-set-up	Change during operation	Conversion index	Type
8-0* General Settings						
8-01	Control Site	[0] Digital and ctrl.word	All set-ups	TRUE	-	Uint8
8-02	Control Word Source	null	All set-ups	TRUE	-	Uint8
8-03	Control Word Timeout Time	1.0 s	1 set-up	TRUE	-1	Uint32
8-04	Control Word Timeout Function	null	1 set-up	TRUE	-	Uint8
8-05	End-of-Timeout Function	[1] Resume set-up	1 set-up	TRUE	-	Uint8
8-06	Reset Control Word Timeout	[0] Do not reset	All set-ups	TRUE	-	Uint8
8-07	Diagnosis Trigger	[0] Disable	2 set-ups	TRUE	-	Uint8
8-08	Readout Filtering	null	All set-ups	TRUE	-	Uint8
8-1* Ctrl. Word Settings						
8-10	Control Word Profile	[0] FC profile	All set-ups	TRUE	-	Uint8
8-13	Configurable Status Word STW	null	All set-ups	TRUE	-	Uint8
8-14	Configurable Control Word CTW	[1] Profile default	All set-ups	TRUE	-	Uint8
8-19	Product Code	App. Dependent	1 set-up	TRUE	0	Uint32
8-3* FC Port Settings						
8-30	Protocol	[0] FC	1 set-up	TRUE	-	Uint8
8-31	Address	1 N/A	1 set-up	TRUE	0	Uint8
8-32	FC Port Baud Rate	null	1 set-up	TRUE	-	Uint8
8-33	Parity / Stop Bits	[0] Even Parity, 1 Stop Bit	1 set-up	TRUE	-	Uint8
8-34	Estimated cycle time	0 ms	2 set-ups	TRUE	-3	Uint32
8-35	Minimum Response Delay	10 ms	All set-ups	TRUE	-3	Uint16
8-36	Max Response Delay	App.Dependent	1 set-up	TRUE	-3	Uint16
8-37	Max Inter-Char Delay	App.Dependent	1 set-up	TRUE	-5	Uint16
8-4* FC MC protocol set						
8-40	Telegram selection	[1] Standard telegram 1	2 set-ups	TRUE	-	Uint8
8-41	Parameters for signals	0	All set-ups	FALSE	-	Uint16
8-42	PCD write configuration	App.Dependent	All set-ups	TRUE	-	Uint16
8-43	PCD read configuration	App.Dependent	All set-ups	TRUE	-	Uint16
8-5* Digital/Bus						
8-50	Coasting Select	[3] Logic OR	All set-ups	TRUE	-	Uint8
8-51	Quick Stop Select	[3] Logic OR	All set-ups	TRUE	-	Uint8
8-52	DC Brake Select	[3] Logic OR	All set-ups	TRUE	-	Uint8
8-53	Start Select	[3] Logic OR	All set-ups	TRUE	-	Uint8
8-54	Reversing Select	[3] Logic OR	All set-ups	TRUE	-	Uint8
8-55	Set-up Select	[3] Logic OR	All set-ups	TRUE	-	Uint8
8-56	Preset Reference Select	[3] Logic OR	All set-ups	TRUE	-	Uint8
8-57	Profidrive OFF2 Select	[3] Logic OR	All set-ups	TRUE	-	Uint8
8-58	Profidrive OFF3 Select	[3] Logic OR	All set-ups	TRUE	-	Uint8
8-8* FC Port Diagnostics						
8-80	Bus Message Count	0 N/A	All set-ups	TRUE	0	Uint32
8-81	Bus Error Count	0 N/A	All set-ups	TRUE	0	Uint32
8-82	Slave Messages Rcvd	0 N/A	All set-ups	TRUE	0	Uint32
8-83	Slave Error Count	0 N/A	All set-ups	TRUE	0	Uint32
8-9* Bus Jog						
8-90	Bus Jog 1 Speed	100 RPM	All set-ups	TRUE	67	Uint16
8-91	Bus Jog 2 Speed	App.Dependent	All set-ups	TRUE	67	Uint16

Table 4.12

4.1.12 9-** Profibus

4

Par. No. #	Parameter description	Default value	4-set-up	Change during operation	Conversion index	Type
9-00	Setpoint	0 N/A	All set-ups	TRUE	0	Uint16
9-07	Actual Value	0 N/A	All set-ups	FALSE	0	Uint16
9-15	PCD Write Configuration	App.Dependent	1 set-up	TRUE	-	Uint16
9-16	PCD Read Configuration	App.Dependent	2 set-ups	TRUE	-	Uint16
9-18	Node Address	126 N/A	1 set-up	TRUE	0	Uint8
9-22	Telegram Selection	[100] None	1 set-up	TRUE	-	Uint8
9-23	Parameters for Signals	0	All set-ups	TRUE	-	Uint16
9-27	Parameter Edit	[1] Enabled	2 set-ups	FALSE	-	Uint16
9-28	Process Control	[1] Enable cyclic master	2 set-ups	FALSE	-	Uint8
9-44	Fault Message Counter	0 N/A	All set-ups	TRUE	0	Uint16
9-45	Fault Code	0 N/A	All set-ups	TRUE	0	Uint16
9-47	Fault Number	0 N/A	All set-ups	TRUE	0	Uint16
9-52	Fault Situation Counter	0 N/A	All set-ups	TRUE	0	Uint16
9-53	Profibus Warning Word	0 N/A	All set-ups	TRUE	0	V2
9-63	Actual Baud Rate	[255] No baudrate found	All set-ups	TRUE	-	Uint8
9-64	Device Identification	0 N/A	All set-ups	TRUE	0	Uint16
9-65	Profile Number	0 N/A	All set-ups	TRUE	0	OctStr[2]
9-67	Control Word 1	0 N/A	All set-ups	TRUE	0	V2
9-68	Status Word 1	0 N/A	All set-ups	TRUE	0	V2
9-71	Profibus Save Data Values	[0] Off	All set-ups	TRUE	-	Uint8
9-72	ProfibusDriveReset	[0] No action	1 set-up	FALSE	-	Uint8
9-75	DO Identification	0 N/A	All set-ups	TRUE	0	Uint16
9-80	Defined Parameters (1)	0 N/A	All set-ups	FALSE	0	Uint16
9-81	Defined Parameters (2)	0 N/A	All set-ups	FALSE	0	Uint16
9-82	Defined Parameters (3)	0 N/A	All set-ups	FALSE	0	Uint16
9-83	Defined Parameters (4)	0 N/A	All set-ups	FALSE	0	Uint16
9-84	Defined Parameters (5)	0 N/A	All set-ups	FALSE	0	Uint16
9-90	Changed Parameters (1)	0 N/A	All set-ups	FALSE	0	Uint16
9-91	Changed Parameters (2)	0 N/A	All set-ups	FALSE	0	Uint16
9-92	Changed Parameters (3)	0 N/A	All set-ups	FALSE	0	Uint16
9-93	Changed parameters (4)	0 N/A	All set-ups	FALSE	0	Uint16
9-94	Changed parameters (5)	0 N/A	All set-ups	FALSE	0	Uint16
9-99	Profibus Revision Counter	0 N/A	All set-ups	TRUE	0	Uint16

Table 4.13

4.1.13 10-** CAN Fieldbus

Par. No. #	Parameter description	Default value	4-set-up	FC 302 only	Change during operation	Conversion index	Type
10-0* Common Settings							
10-00	CAN Protocol	null	2 set-ups		FALSE	-	Uint8
10-01	Baud Rate Select	null	2 set-ups		TRUE	-	Uint8
10-02	MAC ID	App.Dependent	2 set-ups		TRUE	0	Uint8
10-05	Readout Transmit Error Counter	0 N/A	All set-ups		TRUE	0	Uint8
10-06	Readout Receive Error Counter	0 N/A	All set-ups		TRUE	0	Uint8
10-07	Readout Bus Off Counter	0 N/A	All set-ups		TRUE	0	Uint8
10-1* DeviceNet							
10-10	Process Data Type Selection	null	All set-ups		TRUE	-	Uint8
10-11	Process Data Config Write	App.Dependent	All set-ups		TRUE	-	Uint16
10-12	Process Data Config Read	App.Dependent	All set-ups		TRUE	-	Uint16
10-13	Warning Parameter	0 N/A	All set-ups		TRUE	0	Uint16
10-14	Net Reference	[0] Off	2 set-ups		TRUE	-	Uint8
10-15	Net Control	[0] Off	2 set-ups		TRUE	-	Uint8
10-2* COS Filters							
10-20	COS Filter 1	0 N/A	All set-ups		FALSE	0	Uint16
10-21	COS Filter 2	0 N/A	All set-ups		FALSE	0	Uint16
10-22	COS Filter 3	0 N/A	All set-ups		FALSE	0	Uint16
10-23	COS Filter 4	0 N/A	All set-ups		FALSE	0	Uint16
10-3* Parameter Access							
10-30	Array Index	0 N/A	2 set-ups		TRUE	0	Uint8
10-31	Store Data Values	[0] Off	All set-ups		TRUE	-	Uint8
10-32	Devicenet Revision	App.Dependent	All set-ups		TRUE	0	Uint16
10-33	Store Always	[0] Off	1 set-up		TRUE	-	Uint8
10-34	DeviceNet Product Code	App.Dependent	1 set-up		TRUE	0	Uint16
10-39	Devicenet F Parameters	0 N/A	All set-ups		TRUE	0	Uint32
10-5* CANopen							
10-50	Process Data Config Write.	App.Dependent	2 set-ups		TRUE	-	Uint16
10-51	Process Data Config Read.	App.Dependent	2 set-ups		TRUE	-	Uint16

Table 4.14

4.1.14 12-** Ethernet

Par. No. #	Parameter description	Default value	4-set-up	FC 302 only	Change during operation	Conversion index	Type
12-0* IP Settings							
12-00	IP Address Assignment	null	2 set-ups		TRUE	-	UInt8
12-01	IP Address	0 N/A	1 set-up		TRUE	0	OctStr[4]
12-02	Subnet Mask	0 N/A	1 set-up		TRUE	0	OctStr[4]
12-03	Default Gateway	0 N/A	1 set-up		TRUE	0	OctStr[4]
12-04	DHCP Server	0 N/A	2 set-ups		TRUE	0	OctStr[4]
12-05	Lease Expires	App.Dependent	All set-ups		TRUE	0	TimD
12-06	Name Servers	0 N/A	1 set-up		TRUE	0	OctStr[4]
12-07	Domain Name	0 N/A	1 set-up		TRUE	0	VisStr[48]
12-08	Host Name	0 N/A	1 set-up		TRUE	0	VisStr[48]
12-09	Physical Address	0 N/A	1 set-up		TRUE	0	VisStr[17]
12-1* Ethernet Link Parameters							
12-10	Link Status	[0] No Link	1 set-up		TRUE	-	UInt8
12-11	Link Duration	App.Dependent	All set-ups		TRUE	0	TimD
12-12	Auto Negotiation	[1] On	2 set-ups		TRUE	-	UInt8
12-13	Link Speed	[0] None	2 set-ups		TRUE	-	UInt8
12-14	Link Duplex	[1] Full Duplex	2 set-ups		TRUE	-	UInt8
12-2* Process Data							
12-20	Control Instance	App.Dependent	1 set-up		TRUE	0	UInt8
12-21	Process Data Config Write	App.Dependent	All set-ups		TRUE	-	UInt16
12-22	Process Data Config Read	App.Dependent	All set-ups		TRUE	-	UInt16
12-23	Process Data Config Write Size	16 N/A	All set-ups		TRUE	0	UInt32
12-24	Process Data Config Read Size	16 N/A	All set-ups		TRUE	0	UInt32
12-27	Primary Master	0 N/A	1 set-up		FALSE	0	
12-28	Store Data Values	[0] Off	All set-ups		TRUE	-	UInt8
12-29	Store Always	[0] Off	1 set-up		TRUE	-	UInt8
12-3* EtherNet/IP							
12-30	Warning Parameter	0 N/A	All set-ups		TRUE	0	UInt16
12-31	Net Reference	[0] Off	2 set-ups		TRUE	-	UInt8
12-32	Net Control	[0] Off	2 set-ups		TRUE	-	UInt8
12-33	CIP Revision	App.Dependent	All set-ups		TRUE	0	UInt16
12-34	CIP Product Code	App.Dependent	1 set-up		TRUE	0	UInt16
12-35	EDS Parameter	0 N/A	All set-ups		TRUE	0	UInt32
12-37	COS Inhibit Timer	0 N/A	All set-ups		TRUE	0	UInt16
12-38	COS Filter	0 N/A	All set-ups		TRUE	0	UInt16
12-4* Modbus TCP							
12-40	Status Parameter	0 N/A	All set-ups		TRUE	0	UInt16
12-41	Slave Message Count	0 N/A	All set-ups		TRUE	0	UInt32
12-42	Slave Exception Message Count	0 N/A	All set-ups		TRUE	0	UInt32
12-5* EtherCAT							
12-50	Configured Station Alias	0 N/A	1 set-up		FALSE	0	UInt16
12-51	Configured Station Address	0 N/A	All set-ups		TRUE	0	UInt16
12-59	EtherCAT Status	0 N/A	All set-ups		TRUE	0	UInt32

Table 4.15

Par. No. #	Parameter description	Default value	4-set-up	FC 302 only	Change during operation	Conversion index	Type
12-8* Other Ethernet Services							
12-80	FTP Server	[0] Disabled	2 set-ups		TRUE	-	Uint8
12-81	HTTP Server	[0] Disabled	2 set-ups		TRUE	-	Uint8
12-82	SMTP Service	[0] Disabled	2 set-ups		TRUE	-	Uint8
12-89	Transparent Socket Channel Port	App.Dependent	2 set-ups		TRUE	0	Uint16
12-9* Advanced Ethernet Services							
12-90	Cable Diagnostic	[0] Disabled	2 set-ups		TRUE	-	Uint8
12-91	MDI-X	[1] Enabled	2 set-ups		TRUE	-	Uint8
12-92	IGMP Snooping	[1] Enabled	2 set-ups		TRUE	-	Uint8
12-93	Cable Error Length	0 N/A	1 set-up		TRUE	0	Uint16
12-94	Broadcast Storm Protection	-1 %	2 set-ups		TRUE	0	Int8
12-95	Broadcast Storm Filter	[0] Broadcast only	2 set-ups		TRUE	-	Uint8
12-96	Port Mirroring	null	2 set-ups		TRUE	-	Uint8
12-98	Interface Counters	4000 N/A	All set-ups		TRUE	0	Uint32
12-99	Media Counters	0 N/A	All set-ups		TRUE	0	Uint32

Table 4.16

4.1.15 13-** Smart Logic

4

Par. No. #	Parameter description	Default value	4-set-up	Change during operation	Conversion index	Type
13-0* SLC Settings						
13-00	SL Controller Mode	null	2 set-ups	TRUE	-	UInt8
13-01	Start Event	null	2 set-ups	TRUE	-	UInt8
13-02	Stop Event	null	2 set-ups	TRUE	-	UInt8
13-03	Reset SLC	[0] Do not reset SLC	All set-ups	TRUE	-	UInt8
13-1* Comparators						
13-10	Comparator Operand	null	2 set-ups	TRUE	-	UInt8
13-11	Comparator Operator	null	2 set-ups	TRUE	-	UInt8
13-12	Comparator Value	App.Dependent	2 set-ups	TRUE	-3	Int32
13-1* RS Flip Flops						
13-15	RS-FF Operand S	null	2 set-ups	TRUE	-	UInt8
13-16	RS-FF Operand R	null	2 set-ups	TRUE	-	UInt8
13-2* Timers						
13-20	SL Controller Timer	App.Dependent	1 set-up	TRUE	-3	TimD
13-4* Logic Rules						
13-40	Logic Rule Boolean 1	null	2 set-ups	TRUE	-	UInt8
13-41	Logic Rule Operator 1	null	2 set-ups	TRUE	-	UInt8
13-42	Logic Rule Boolean 2	null	2 set-ups	TRUE	-	UInt8
13-43	Logic Rule Operator 2	null	2 set-ups	TRUE	-	UInt8
13-44	Logic Rule Boolean 3	null	2 set-ups	TRUE	-	UInt8
13-5* States						
13-51	SL Controller Event	null	2 set-ups	TRUE	-	UInt8
13-52	SL Controller Action	null	2 set-ups	TRUE	-	UInt8

Table 4.17

4.1.16 14-** Special Functions

Par. No. #	Parameter description	Default value	4-set-up	Change during operation	Conversion index	Type
14-0* Inverter Switching						
14-00	Switching Pattern	null	All set-ups	TRUE	-	Uint8
14-01	Switching Frequency	null	All set-ups	TRUE	-	Uint8
14-03	Overmodulation	[1] On	All set-ups	FALSE	-	Uint8
14-04	PWM Random	[0] Off	All set-ups	TRUE	-	Uint8
14-06	Dead Time Compensation	[1] On	All set-ups	TRUE	-	Uint8
14-1* Mains On/Off						
14-10	Mains Failure	[0] No function	All set-ups	FALSE	-	Uint8
14-11	Mains Voltage at Mains Fault	App.Dependent	All set-ups	TRUE	0	Uint16
14-12	Function at Mains Imbalance	[0] Trip	All set-ups	TRUE	-	Uint8
14-13	Mains Failure Step Factor	1.0 N/A	All set-ups	TRUE	-1	Uint8
14-14	Kin. Backup Time Out	60 s	All set-ups	TRUE	0	Uint8
14-15	Kin. Backup Trip Recovery Level	App.Dependent	All set-ups	TRUE	-3	Uint32
14-2* Trip Reset						
14-20	Reset Mode	[0] Manual reset	All set-ups	TRUE	-	Uint8
14-21	Automatic Restart Time	App.Dependent	All set-ups	TRUE	0	Uint16
14-22	Operation Mode	[0] Normal operation	All set-ups	TRUE	-	Uint8
14-24	Trip Delay at Current Limit	60 s	All set-ups	TRUE	0	Uint8
14-25	Trip Delay at Torque Limit	60 s	All set-ups	TRUE	0	Uint8
14-26	Trip Delay at Inverter Fault	App.Dependent	All set-ups	TRUE	0	Uint8
14-28	Production Settings	[0] No action	All set-ups	TRUE	-	Uint8
14-29	Service Code	0 N/A	All set-ups	TRUE	0	Int32
14-3* Current Limit Ctrl.						
14-30	Current Lim Ctrl, Proportional Gain	100%	All set-ups	FALSE	0	Uint16
14-31	Current Lim Ctrl, Integration Time	0.020 s	All set-ups	FALSE	-3	Uint16
14-32	Current Lim Ctrl, Filter Time	1.0 ms	All set-ups	TRUE	-4	Uint16
14-35	Stall Protection	[1] Enabled	All set-ups	FALSE	-	Uint8
14-4* Energy Optimising						
14-40	VT Level	66%	All set-ups	FALSE	0	Uint8
14-41	AEO Minimum Magnetisation	App.Dependent	All set-ups	TRUE	0	Uint8
14-42	Minimum AEO Frequency	10 Hz	All set-ups	TRUE	0	Uint8
14-43	Motor Cosphi	App.Dependent	All set-ups	TRUE	-2	Uint16
14-5* Environment						
14-50	RFI Filter	[1] On	1 set-up	FALSE	-	Uint8
14-51	DC Link Compensation	[1] On	1 set-up	TRUE	-	Uint8
14-52	Fan Control	[0] Auto	All set-ups	TRUE	-	Uint8
14-53	Fan Monitor	[1] Warning	All set-ups	TRUE	-	Uint8
14-55	Output Filter	[0] No Filter	All set-ups	FALSE	-	Uint8
14-56	Capacitance Output Filter	App.Dependent	All set-ups	FALSE	-7	Uint16
14-57	Inductance Output Filter	App.Dependent	All set-ups	FALSE	-6	Uint16
14-59	Actual Number of Inverter Units	App.Dependent	1 set-up	FALSE	0	Uint8
14-7* Compatibility						
14-72	Legacy Alarm Word	0 N/A	All set-ups	FALSE	0	Uint32
14-73	Legacy Warning Word	0 N/A	All set-ups	FALSE	0	Uint32
14-74	Leg. Ext. Status Word	0 N/A	All set-ups	FALSE	0	Uint32
14-8* Options						
14-80	Option Supplied by External 24VDC	[1] Yes	2 set-ups	FALSE	-	Uint8
14-89	Option Detection	[0] Protect Option Config.	1 set-up	TRUE	-	Uint8
14-9* Fault Settings						

Par. No. #	Parameter description	Default value	4-set-up	Change during operation	Conversion index	Type
14-90	Fault Level	null	1 set-up	TRUE	-	Uint8

Table 4.18

4.1.17 15-** Drive Information

Par. No. #	Parameter description	Default value	4-set-up	Change during operation	Conversion index	Type
15-0* Operating Data						
15-00	Operating Hours	0 h	All set-ups	FALSE	74	Uint32
15-01	Running Hours	0 h	All set-ups	FALSE	74	Uint32
15-02	kWh Counter	0 kWh	All set-ups	FALSE	75	Uint32
15-03	Power Up's	0 N/A	All set-ups	FALSE	0	Uint32
15-04	Over Temp's	0 N/A	All set-ups	FALSE	0	Uint16
15-05	Over Volt's	0 N/A	All set-ups	FALSE	0	Uint16
15-06	Reset kWh Counter	[0] Do not reset	All set-ups	TRUE	-	Uint8
15-07	Reset Running Hours Counter	[0] Do not reset	All set-ups	TRUE	-	Uint8
15-1* Data Log Settings						
15-10	Logging Source	0	2 set-ups	TRUE	-	Uint16
15-11	Logging Interval	App.Dependent	2 set-ups	TRUE	-3	TimD
15-12	Trigger Event	[0] False	1 set-up	TRUE	-	Uint8
15-13	Logging Mode	[0] Log always	2 set-ups	TRUE	-	Uint8
15-14	Samples Before Trigger	50 N/A	2 set-ups	TRUE	0	Uint8
15-2* Historic Log						
15-20	Historic Log: Event	0 N/A	All set-ups	FALSE	0	Uint8
15-21	Historic Log: Value	0 N/A	All set-ups	FALSE	0	Uint32
15-22	Historic Log: Time	0 ms	All set-ups	FALSE	-3	Uint32
15-3* Fault Log						
15-30	Fault Log: Error Code	0 N/A	All set-ups	FALSE	0	Uint8
15-31	Fault Log: Value	0 N/A	All set-ups	FALSE	0	Int16
15-32	Fault Log: Time	0 s	All set-ups	FALSE	0	Uint32
15-4* Drive Identification						
15-40	FC Type	0 N/A	All set-ups	FALSE	0	VisStr[6]
15-41	Power Section	0 N/A	All set-ups	FALSE	0	VisStr[20]
15-42	Voltage	0 N/A	All set-ups	FALSE	0	VisStr[20]
15-43	Software Version	0 N/A	All set-ups	FALSE	0	VisStr[5]
15-44	Ordered Typecode String	0 N/A	All set-ups	FALSE	0	VisStr[40]
15-45	Actual Typecode String	0 N/A	All set-ups	FALSE	0	VisStr[40]
15-46	Frequency Converter Ordering No	0 N/A	All set-ups	FALSE	0	VisStr[8]
15-47	Power Card Ordering No	0 N/A	All set-ups	FALSE	0	VisStr[8]
15-48	LCP Id No	0 N/A	All set-ups	FALSE	0	VisStr[20]
15-49	SW ID Control Card	0 N/A	All set-ups	FALSE	0	VisStr[20]
15-50	SW ID Power Card	0 N/A	All set-ups	FALSE	0	VisStr[20]
15-51	Frequency Converter Serial Number	0 N/A	All set-ups	FALSE	0	VisStr[10]
15-53	Power Card Serial Number	0 N/A	All set-ups	FALSE	0	VisStr[19]
15-58	Smart Setup Filename	App.Dependent	1 set-up	FALSE	0	VisStr[16]
15-59	CSIV Filename	App.Dependent	1 set-up	FALSE	0	VisStr[16]
15-6* Option Ident						
15-60	Option Mounted	0 N/A	All set-ups	FALSE	0	VisStr[30]
15-61	Option SW Version	0 N/A	All set-ups	FALSE	0	VisStr[20]
15-62	Option Ordering No	0 N/A	All set-ups	FALSE	0	VisStr[8]
15-63	Option Serial No	0 N/A	All set-ups	FALSE	0	VisStr[18]
15-70	Option in Slot A	0 N/A	All set-ups	FALSE	0	VisStr[30]
15-71	Slot A Option SW Version	0 N/A	All set-ups	FALSE	0	VisStr[20]
15-72	Option in Slot B	0 N/A	All set-ups	FALSE	0	VisStr[30]
15-73	Slot B Option SW Version	0 N/A	All set-ups	FALSE	0	VisStr[20]
15-74	Option in Slot C0	0 N/A	All set-ups	FALSE	0	VisStr[30]

Par. No. #	Parameter description	Default value	4-set-up	Change during operation	Conversion index	Type
15-75	Slot C0 Option SW Version	0 N/A	All set-ups	FALSE	0	VisStr[20]
15-76	Option in Slot C1	0 N/A	All set-ups	FALSE	0	VisStr[30]
15-77	Slot C1 Option SW Version	0 N/A	All set-ups	FALSE	0	VisStr[20]
15-9* Operating Data II						
15-80	Fan Running Hours	0 h	All set-ups	TRUE	74	Uint32
15-9* Parameter Info						
15-92	Defined Parameters	0 N/A	All set-ups	FALSE	0	Uint16
15-93	Modified Parameters	0 N/A	All set-ups	FALSE	0	Uint16
15-98	Drive Identification	0 N/A	All set-ups	FALSE	0	VisStr[40]
15-99	Parameter Metadata	0 N/A	All set-ups	FALSE	0	Uint16

Table 4.19

4.1.18 16-** Data Readouts

Par. No. #	Parameter description	Default value	4-set-up	Change during operation	Conversion index	Type
16-0* General Status						
16-00	Control Word	0 N/A	All set-ups	FALSE	0	V2
16-01	Reference [Unit]	0.000 ReferenceFeedbackUnit	All set-ups	FALSE	-3	Int32
16-02	Reference %	0.0%	All set-ups	FALSE	-1	Int16
16-03	Status Word	0 N/A	All set-ups	FALSE	0	V2
16-05	Main Actual Value [%]	0.00%	All set-ups	FALSE	-2	N2
16-09	Custom Readout	0.00 CustomReadoutUnit	All set-ups	FALSE	-2	Int32
16-1* Motor Status						
16-10	Power [kW]	0.00 kW	All set-ups	FALSE	1	Int32
16-11	Power [hp]	0.00 hp	All set-ups	FALSE	-2	Int32
16-12	Motor Voltage	0.0 V	All set-ups	FALSE	-1	UInt16
16-13	Frequency	0.0 Hz	All set-ups	FALSE	-1	UInt16
16-14	Motor Current	0.00 A	All set-ups	FALSE	-2	Int32
16-15	Frequency [%]	0.00%	All set-ups	FALSE	-2	N2
16-16	Torque [Nm]	0.0 Nm	All set-ups	FALSE	-1	Int16
16-17	Speed [RPM]	0 RPM	All set-ups	FALSE	67	Int32
16-18	Motor Thermal	0%	All set-ups	FALSE	0	UInt8
16-19	KTY sensor temperature	0 °C	All set-ups	FALSE	100	Int16
16-20	Motor Angle	0 N/A	All set-ups	TRUE	0	UInt16
16-21	Torque [%] High Res.	0.0%	All set-ups	FALSE	-1	Int16
16-22	Torque [%]	0%	All set-ups	FALSE	0	Int16
16-25	Torque [Nm] High	0.0 Nm	All set-ups	FALSE	-1	Int32
16-3* Drive Status						
16-30	DC Link Voltage	0 V	All set-ups	FALSE	0	UInt16
16-32	Brake Energy /s	0.000 kW	All set-ups	FALSE	0	UInt32
16-33	Brake Energy /2 min	0.000 kW	All set-ups	FALSE	0	UInt32
16-34	Heatsink Temp.	0 °C	All set-ups	FALSE	100	UInt8
16-35	Inverter Thermal	0%	All set-ups	FALSE	0	UInt8
16-36	Inv. Nom. Current	App.Dependent	All set-ups	FALSE	-2	UInt32
16-37	Inv. Max. Current	App.Dependent	All set-ups	FALSE	-2	UInt32
16-38	SL Controller State	0 N/A	All set-ups	FALSE	0	UInt8
16-39	Control Card Temp.	0 °C	All set-ups	FALSE	100	UInt8
16-40	Logging Buffer Full	[0] No	All set-ups	TRUE	-	UInt8
16-41	LCP Bottom Statusline	0 N/A	All set-ups	TRUE	0	VisStr[50]
16-48	Speed Ref. After Ramp [RPM]	0 RPM	All set-ups	FALSE	67	Int32
16-49	Current Fault Source	0 N/A	All set-ups	TRUE	0	UInt8
16-5* Ref. & Feedb.						
16-50	External Reference	0.0 N/A	All set-ups	FALSE	-1	Int16
16-51	Pulse Reference	0.0 N/A	All set-ups	FALSE	-1	Int16
16-52	Feedback [Unit]	0.000 ReferenceFeedbackUnit	All set-ups	FALSE	-3	Int32
16-53	Digi Pot Reference	0.00 N/A	All set-ups	FALSE	-2	Int16
16-57	Feedback [RPM]	0 RPM	All set-ups	FALSE	67	Int32
16-6* Inputs & Outputs						
16-60	Digital Input	0 N/A	All set-ups	FALSE	0	UInt16
16-61	Terminal 53 Switch Setting	[0] Current	All set-ups	FALSE	-	UInt8
16-62	Analog Input 53	0.000 N/A	All set-ups	FALSE	-3	Int32
16-63	Terminal 54 Switch Setting	[0] Current	All set-ups	FALSE	-	UInt8
16-64	Analog Input 54	0.000 N/A	All set-ups	FALSE	-3	Int32

Par. No. #	Parameter description	Default value	4-set-up	Change during operation	Conversion index	Type
16-65	Analog Output 42 [mA]	0.000 N/A	All set-ups	FALSE	-3	Int16
16-66	Digital Output [bin]	0 N/A	All set-ups	FALSE	0	Int16
16-67	Freq. Input #29 [Hz]	0 N/A	All set-ups	FALSE	0	Int32
16-68	Freq. Input #33 [Hz]	0 N/A	All set-ups	FALSE	0	Int32
16-69	Pulse Output #27 [Hz]	0 N/A	All set-ups	FALSE	0	Int32
16-70	Pulse Output #29 [Hz]	0 N/A	All set-ups	FALSE	0	Int32
16-71	Relay Output [bin]	0 N/A	All set-ups	FALSE	0	Int16
16-72	Counter A	0 N/A	All set-ups	TRUE	0	Int32
16-73	Counter B	0 N/A	All set-ups	TRUE	0	Int32
16-74	Prec. Stop Counter	0 N/A	All set-ups	TRUE	0	UInt32
16-75	Analog In X30/11	0.000 N/A	All set-ups	FALSE	-3	Int32
16-76	Analog In X30/12	0.000 N/A	All set-ups	FALSE	-3	Int32
16-77	Analog Out X30/8 [mA]	0.000 N/A	All set-ups	FALSE	-3	Int16
16-78	Analog Out X45/1 [mA]	0.000 N/A	All set-ups	FALSE	-3	Int16
16-79	Analog Out X45/3 [mA]	0.000 N/A	All set-ups	FALSE	-3	Int16
16-8* Fieldbus & FC Port						
16-80	Fieldbus CTW 1	0 N/A	All set-ups	FALSE	0	V2
16-82	Fieldbus REF 1	0 N/A	All set-ups	FALSE	0	N2
16-84	Comm. Option STW	0 N/A	All set-ups	FALSE	0	V2
16-85	FC Port CTW 1	0 N/A	All set-ups	FALSE	0	V2
16-86	FC Port REF 1	0 N/A	All set-ups	FALSE	0	N2
16-87	Bus Readout Alarm/Warning	0 N/A	All set-ups	FALSE	0	UInt16
16-9* Diagnosis Readouts						
16-90	Alarm Word	0 N/A	All set-ups	FALSE	0	UInt32
16-91	Alarm Word 2	0 N/A	All set-ups	FALSE	0	UInt32
16-92	Warning Word	0 N/A	All set-ups	FALSE	0	UInt32
16-93	Warning Word 2	0 N/A	All set-ups	FALSE	0	UInt32
16-94	Ext. Status Word	0 N/A	All set-ups	FALSE	0	UInt32

Table 4.20

4.1.19 17-** Motor Feedb.Option

Par. No. #	Parameter description	Default value	4-set-up	Change during operation	Conversion index	Type
17-1* Inc. Enc. Interface						
17-10	Signal Type	[1] RS422 (5V TTL)	All set-ups	FALSE	-	Uint8
17-11	Resolution (PPR)	1024 N/A	All set-ups	FALSE	0	Uint16
17-2* Abs. Enc. Interface						
17-20	Protocol Selection	[0] None	All set-ups	FALSE	-	Uint8
17-21	Resolution (Positions/Rev)	App.Dependent	All set-ups	FALSE	0	Uint32
17-24	SSI Data Length	13 N/A	All set-ups	FALSE	0	Uint8
17-25	Clock Rate	App.Dependent	All set-ups	FALSE	3	Uint16
17-26	SSI Data Format	[0] Gray code	All set-ups	FALSE	-	Uint8
17-34	HIPERFACE Baudrate	[4] 9600	All set-ups	FALSE	-	Uint8
17-5* Resolver Interface						
17-50	Poles	2 N/A	1 set-up	FALSE	0	Uint8
17-51	Input Voltage	7.0 V	1 set-up	FALSE	-1	Uint8
17-52	Input Frequency	10.0 kHz	1 set-up	FALSE	2	Uint8
17-53	Transformation Ratio	0.5 N/A	1 set-up	FALSE	-1	Uint8
17-56	Encoder Sim. Resolution	[0] Disabled	1 set-up	FALSE	-	Uint8
17-59	Resolver Interface	[0] Disabled	All set-ups	FALSE	-	Uint8
17-6* Monitoring and App.						
17-60	Feedback Direction	[0] Clockwise	All set-ups	FALSE	-	Uint8
17-61	Feedback Signal Monitoring	[1] Warning	All set-ups	TRUE	-	Uint8

Table 4.21

4.1.20 18-** Data Readouts 2

Par. No. #	Parameter description	Default value	4-set-up	FC 302 only	Change during operation	Conversion index	Type
18-3* Analog Readouts							
18-36	Analog Input X48/2 [mA]	0.000 N/A	All set-ups		TRUE	-3	Int32
18-37	Temp. Input X48/4	0 N/A	All set-ups		TRUE	0	Int16
18-38	Temp. Input X48/7	0 N/A	All set-ups		TRUE	0	Int16
18-39	Temp. Input X48/10	0 N/A	All set-ups		TRUE	0	Int16
18-6* Inputs & Outputs 2							
18-60	Digital Input 2	0 N/A	All set-ups		FALSE	0	UInt16
18-90 PID Readouts							
18-90	Process PID Error	0.0 %	All set-ups		FALSE	-1	Int16
18-91	Process PID Output	0.0 %	All set-ups		FALSE	-1	Int16
18-92	Process PID Clamped Output	0.0 %	All set-ups		FALSE	-1	Int16
18-93	Process PID Gain Scaled Output	0.0 %	All set-ups		FALSE	-1	Int16

Table 4.22

4.1.21 30-** Special Features

Par. No. #	Parameter description	Default value	4-set-up	Change during operation	Conversion index	Type
30-0* Wobbler						
30-00	Wobble Mode	[0] Abs. Freq., Abs. Time	All set-ups	FALSE	-	Uint8
30-01	Wobble Delta Frequency [Hz]	5.0 Hz	All set-ups	TRUE	-1	Uint8
30-02	Wobble Delta Frequency [%]	25%	All set-ups	TRUE	0	Uint8
30-03	Wobble Delta Freq. Scaling Resource	[0] No function	All set-ups	TRUE	-	Uint8
30-04	Wobble Jump Frequency [Hz]	0.0 Hz	All set-ups	TRUE	-1	Uint8
30-05	Wobble Jump Frequency [%]	0%	All set-ups	TRUE	0	Uint8
30-06	Wobble Jump Time	App.Dependent	All set-ups	TRUE	-3	Uint16
30-07	Wobble Sequence Time	10.0 s	All set-ups	TRUE	-1	Uint16
30-08	Wobble Up/ Down Time	5.0 s	All set-ups	TRUE	-1	Uint16
30-09	Wobble Random Function	[0] Off	All set-ups	TRUE	-	Uint8
30-10	Wobble Ratio	1.0 N/A	All set-ups	TRUE	-1	Uint8
30-11	Wobble Random Ratio Max.	10.0 N/A	All set-ups	TRUE	-1	Uint8
30-12	Wobble Random Ratio Min.	0.1 N/A	All set-ups	TRUE	-1	Uint8
30-19	Wobble Delta Freq. Scaled	0.0 Hz	All set-ups	FALSE	-1	Uint16
30-2* Adv. Start Adjust						
30-20	High Starting Torque Time [s]	0.00 s	All set-ups	TRUE	-2	Uint8
30-21	High Starting Torque Current [%]	100.0%	All set-ups	TRUE	-1	Uint32
30-22	Locked Rotor Protection	[0] Off	All set-ups	TRUE	-	Uint8
30-23	Locked Rotor Detection Time [s]	0.10 s	All set-ups	TRUE	-2	Uint8
30-8* Compatibility (I)						
30-80	d-axis Inductance (Ld)	App.Dependent	All set-ups	FALSE	-6	Int32
30-81	Brake Resistor (ohm)	App.Dependent	1 set-up	TRUE	-2	Uint32
30-83	Speed PID Proportional Gain	App.Dependent	All set-ups	TRUE	-4	Uint32
30-84	Process PID Proportional Gain	0.100 N/A	All set-ups	TRUE	-3	Uint16

Table 4.23

4.1.22 32-** MCO Basic Settings

4

Par. No. #	Parameter description	Default value	4-set-up	FC 302 only	Change during operation	Conversion index	Type
32-0* Encoder 2							
32-00	Incremental Signal Type	[1] RS422 (5V TTL)	2 set-ups		TRUE	-	Uint8
32-01	Incremental Resolution	1024 N/A	2 set-ups		TRUE	0	Uint32
32-02	Absolute Protocol	[0] None	2 set-ups		TRUE	-	Uint8
32-03	Absolute Resolution	8192 N/A	2 set-ups		TRUE	0	Uint32
32-04	Absolute Encoder Baudrate X55	[4] 9600	All set-ups		FALSE	-	Uint8
32-05	Absolute Encoder Data Length	25 N/A	2 set-ups		TRUE	0	Uint8
32-06	Absolute Encoder Clock Frequency	262.000 kHz	2 set-ups		TRUE	0	Uint32
32-07	Absolute Encoder Clock Generation	[1] On	2 set-ups		TRUE	-	Uint8
32-08	Absolute Encoder Cable Length	0 m	2 set-ups		TRUE	0	Uint16
32-09	Encoder Monitoring	[0] Off	2 set-ups		TRUE	-	Uint8
32-10	Rotational Direction	[1] No action	2 set-ups		TRUE	-	Uint8
32-11	User Unit Denominator	1 N/A	2 set-ups		TRUE	0	Uint32
32-12	User Unit Numerator	1 N/A	2 set-ups		TRUE	0	Uint32
32-13	Enc.2 Control	[0] No soft changing	2 set-ups		TRUE	-	Uint8
32-14	Enc.2 node ID	127 N/A	2 set-ups		TRUE	0	Uint8
32-15	Enc.2 CAN guard	null	2 set-ups		TRUE	-	Uint8
32-3* Encoder 1							
32-30	Incremental Signal Type	[1] RS422 (5V TTL)	2 set-ups		TRUE	-	Uint8
32-31	Incremental Resolution	1024 N/A	2 set-ups		TRUE	0	Uint32
32-32	Absolute Protocol	[0] None	2 set-ups		TRUE	-	Uint8
32-33	Absolute Resolution	8192 N/A	2 set-ups		TRUE	0	Uint32
32-35	Absolute Encoder Data Length	25 N/A	2 set-ups		TRUE	0	Uint8
32-36	Absolute Encoder Clock Frequency	262.000 kHz	2 set-ups		TRUE	0	Uint32
32-37	Absolute Encoder Clock Generation	[1] On	2 set-ups		TRUE	-	Uint8
32-38	Absolute Encoder Cable Length	0 m	2 set-ups		TRUE	0	Uint16
32-39	Encoder Monitoring	[0] Off	2 set-ups		TRUE	-	Uint8
32-40	Encoder Termination	[1] On	2 set-ups		TRUE	-	Uint8
32-43	Enc.1 Control	[0] No soft changing	2 set-ups		TRUE	-	Uint8
32-44	Enc.1 node ID	127 N/A	2 set-ups		TRUE	0	Uint8
32-45	Enc.1 CAN guard	null	2 set-ups		TRUE	-	Uint8
32-5* Feedback Source							
32-50	Source Slave	[2] Encoder 2	2 set-ups		TRUE	-	Uint8
32-51	MCO 302 Last Will	[1] Trip	2 set-ups		TRUE	-	Uint8
32-52	Source Master	[1] Encoder 1 X56	2 set-ups		TRUE	-	Uint8
32-6* PID Controller							
32-60	Proportional factor	30 N/A	2 set-ups		TRUE	0	Uint32
32-61	Derivative factor	0 N/A	2 set-ups		TRUE	0	Uint32
32-62	Integral factor	0 N/A	2 set-ups		TRUE	0	Uint32
32-63	Limit Value for Integral Sum	1000 N/A	2 set-ups		TRUE	0	Uint16
32-64	PID Bandwidth	1000 N/A	2 set-ups		TRUE	0	Uint16
32-65	Velocity Feed-Forward	0 N/A	2 set-ups		TRUE	0	Uint32
32-66	Acceleration Feed-Forward	0 N/A	2 set-ups		TRUE	0	Uint32
32-67	Max. Tolerated Position Error	20000 N/A	2 set-ups		TRUE	0	Uint32
32-68	Reverse Behavior for Slave	[0] Reversing allowed	2 set-ups		TRUE	-	Uint8
32-69	Sampling Time for PID Control	1 ms	2 set-ups		TRUE	-3	Uint16
32-70	Scan Time for Profile Generator	1 ms	2 set-ups		TRUE	-3	Uint8
32-71	Size of the Control Window (Activation)	0 N/A	2 set-ups		TRUE	0	Uint32
32-72	Size of the Control Window (Deactiv.)	0 N/A	2 set-ups		TRUE	0	Uint32

Par. No. #	Parameter description	Default value	4-set-up	FC 302 only	Change during operation	Conversion index	Type
32-73	Integral limit filter time	0 ms	2 set-ups		TRUE	-3	Int16
32-74	Position error filter time	0 ms	2 set-ups		TRUE	-3	Int16
32-8* Velocity & Accel.							
32-80	Maximum Velocity (Encoder)	1500 RPM	2 set-ups		TRUE	67	Uint32
32-81	Shortest Ramp	1.000 s	2 set-ups		TRUE	-3	Uint32
32-82	Ramp Type	[0] Linear	2 set-ups		TRUE	-	Uint8
32-83	Velocity Resolution	100 N/A	2 set-ups		TRUE	0	Uint32
32-84	Default Velocity	50 N/A	2 set-ups		TRUE	0	Uint32
32-85	Default Acceleration	50 N/A	2 set-ups		TRUE	0	Uint32
32-86	Acc. up for limited jerk	100 ms	2 set-ups		TRUE	-3	Uint32
32-87	Acc. down for limited jerk	0 ms	2 set-ups		TRUE	-3	Uint32
32-88	Dec. up for limited jerk	0 ms	2 set-ups		TRUE	-3	Uint32
32-89	Dec. down for limited jerk	0 ms	2 set-ups		TRUE	-3	Uint32
32-9* Development							
32-90	Debug Source	[0] Controlcard	2 set-ups		TRUE	-	Uint8

Table 4.24

4.1.23 33-** MCO Adv. Settings

4

Par. No. #	Parameter description	Default value	4-set-up	FC 302 only	Change during operation	Conversion index	Type
33-0* Home Motion							
33-00	Force HOME	[0] Home not forced	2 set-ups		TRUE	-	UInt8
33-01	Zero Point Offset from Home Pos.	0 N/A	2 set-ups		TRUE	0	Int32
33-02	Ramp for Home Motion	10 N/A	2 set-ups		TRUE	0	UInt32
33-03	Velocity of Home Motion	10 N/A	2 set-ups		TRUE	0	Int32
33-04	Behaviour during HomeMotion	[0] Revers and index	2 set-ups		TRUE	-	UInt8
33-1* Synchronization							
33-10	Sync Factor Master	1 N/A	2 set-ups		TRUE	0	Int32
33-11	Sync Factor Slave	1 N/A	2 set-ups		TRUE	0	Int32
33-12	Position Offset for Synchronization	0 N/A	2 set-ups		TRUE	0	Int32
33-13	Accuracy Window for Position Sync.	1000 N/A	2 set-ups		TRUE	0	Int32
33-14	Relative Slave Velocity Limit	0 %	2 set-ups		TRUE	0	UInt8
33-15	Marker Number for Master	1 N/A	2 set-ups		TRUE	0	UInt16
33-16	Marker Number for Slave	1 N/A	2 set-ups		TRUE	0	UInt16
33-17	Master Marker Distance	4096 N/A	2 set-ups		TRUE	0	UInt32
33-18	Slave Marker Distance	4096 N/A	2 set-ups		TRUE	0	UInt32
33-19	Master Marker Type	[0] Encoder Z positive	2 set-ups		TRUE	-	UInt8
33-20	Slave Marker Type	[0] Encoder Z positive	2 set-ups		TRUE	-	UInt8
33-21	Master Marker Tolerance Window	0 N/A	2 set-ups		TRUE	0	UInt32
33-22	Slave Marker Tolerance Window	0 N/A	2 set-ups		TRUE	0	UInt32
33-23	Start Behaviour for Marker Sync	[0] Start Function 1	2 set-ups		TRUE	-	UInt16
33-24	Marker Number for Fault	10 N/A	2 set-ups		TRUE	0	UInt16
33-25	Marker Number for Ready	1 N/A	2 set-ups		TRUE	0	UInt16
33-26	Velocity Filter	0 us	2 set-ups		TRUE	-6	Int32
33-27	Offset Filter Time	0 ms	2 set-ups		TRUE	-3	UInt32
33-28	Marker Filter Configuration	[0] Marker filter 1	2 set-ups		TRUE	-	UInt8
33-29	Filter Time for Marker Filter	0 ms	2 set-ups		TRUE	-3	Int32
33-30	Maximum Marker Correction	0 N/A	2 set-ups		TRUE	0	UInt32
33-31	Synchronisation Type	[0] Standard	2 set-ups		TRUE	-	UInt8
33-32	Feed Forward Velocity Adaptation	0 N/A	2 set-ups		TRUE	0	UInt32
33-33	Velocity Filter Window	0 N/A	2 set-ups		TRUE	0	UInt32
33-34	Slave Marker filter time	0 ms	2 set-ups		TRUE	-3	UInt32
33-4* Limit Handling							
33-40	Behaviour at End Limit Switch	[0] Call error handler	2 set-ups		TRUE	-	UInt8
33-41	Negative Software End Limit	-500000 N/A	2 set-ups		TRUE	0	Int32
33-42	Positive Software End Limit	500000 N/A	2 set-ups		TRUE	0	Int32
33-43	Negative Software End Limit Active	[0] Inactive	2 set-ups		TRUE	-	UInt8
33-44	Positive Software End Limit Active	[0] Inactive	2 set-ups		TRUE	-	UInt8
33-45	Time in Target Window	0 ms	2 set-ups		TRUE	-3	UInt8
33-46	Target Window LimitValue	1 N/A	2 set-ups		TRUE	0	UInt16
33-47	Size of Target Window	0 N/A	2 set-ups		TRUE	0	UInt16
33-5* I/O Configuration							
33-50	Terminal X57/1 Digital Input	[0] No function	2 set-ups		TRUE	-	UInt8
33-51	Terminal X57/2 Digital Input	[0] No function	2 set-ups		TRUE	-	UInt8
33-52	Terminal X57/3 Digital Input	[0] No function	2 set-ups		TRUE	-	UInt8
33-53	Terminal X57/4 Digital Input	[0] No function	2 set-ups		TRUE	-	UInt8
33-54	Terminal X57/5 Digital Input	[0] No function	2 set-ups		TRUE	-	UInt8
33-55	Terminal X57/6 Digital Input	[0] No function	2 set-ups		TRUE	-	UInt8
33-56	Terminal X57/7 Digital Input	[0] No function	2 set-ups		TRUE	-	UInt8

Par. No. #	Parameter description	Default value	4-set-up	FC 302 only	Change during operation	Conversion index	Type
33-57	Terminal X57/8 Digital Input	[0] No function	2 set-ups		TRUE	-	Uint8
33-58	Terminal X57/9 Digital Input	[0] No function	2 set-ups		TRUE	-	Uint8
33-59	Terminal X57/10 Digital Input	[0] No function	2 set-ups		TRUE	-	Uint8
33-60	Terminal X59/1 and X59/2 Mode	[1] Output	2 set-ups		FALSE	-	Uint8
33-61	Terminal X59/1 Digital Input	[0] No function	2 set-ups		TRUE	-	Uint8
33-62	Terminal X59/2 Digital Input	[0] No function	2 set-ups		TRUE	-	Uint8
33-63	Terminal X59/1 Digital Output	[0] No function	2 set-ups		TRUE	-	Uint8
33-64	Terminal X59/2 Digital Output	[0] No function	2 set-ups		TRUE	-	Uint8
33-65	Terminal X59/3 Digital Output	[0] No function	2 set-ups		TRUE	-	Uint8
33-66	Terminal X59/4 Digital Output	[0] No function	2 set-ups		TRUE	-	Uint8
33-67	Terminal X59/5 Digital Output	[0] No function	2 set-ups		TRUE	-	Uint8
33-68	Terminal X59/6 Digital Output	[0] No function	2 set-ups		TRUE	-	Uint8
33-69	Terminal X59/7 Digital Output	[0] No function	2 set-ups		TRUE	-	Uint8
33-70	Terminal X59/8 Digital Output	[0] No function	2 set-ups		TRUE	-	Uint8
33-8* Global Parameters							
33-80	Activated Program Number	-1 N/A	2 set-ups		TRUE	0	Int8
33-81	Power-up State	[1] Motor on	2 set-ups		TRUE	-	Uint8
33-82	Drive Status Monitoring	[1] On	2 set-ups		TRUE	-	Uint8
33-83	Behaviour afterError	[0] Coast	2 set-ups		TRUE	-	Uint8
33-84	Behaviour afterEsc.	[0] Controlled stop	2 set-ups		TRUE	-	Uint8
33-85	MCO Supplied by External 24VDC	[0] No	2 set-ups		TRUE	-	Uint8
33-86	Terminal at alarm	[0] Relay 1	2 set-ups		TRUE	-	Uint8
33-87	Terminal state at alarm	[0] Do nothing	2 set-ups		TRUE	-	Uint8
33-88	Status word at alarm	0 N/A	2 set-ups		TRUE	0	Uint16
33-9* MCO Port Settings							
33-90	X62 MCO CAN node ID	127 N/A	2 set-ups		TRUE	0	Uint8
33-91	X62 MCO CAN baud rate	[20] 125 Kbps	2 set-ups		TRUE	-	Uint8
33-94	X60 MCO RS485 serial termination	[0] Off	2 set-ups		TRUE	-	Uint8
33-95	X60 MCO RS485 serial baud rate	[2] 9600 Baud	2 set-ups		TRUE	-	Uint8

Table 4.25

4.1.24 34-** MCO Data Readouts

Par. No. #	Parameter description	Default value	4-set-up	FC 302 only	Change during operation	Conversion index	Type
34-0* PCD Write Par.							
34-01	PCD 1 Write to MCO	0 N/A	All set-ups		TRUE	0	Uint16
34-02	PCD 2 Write to MCO	0 N/A	All set-ups		TRUE	0	Uint16
34-03	PCD 3 Write to MCO	0 N/A	All set-ups		TRUE	0	Uint16
34-04	PCD 4 Write to MCO	0 N/A	All set-ups		TRUE	0	Uint16
34-05	PCD 5 Write to MCO	0 N/A	All set-ups		TRUE	0	Uint16
34-06	PCD 6 Write to MCO	0 N/A	All set-ups		TRUE	0	Uint16
34-07	PCD 7 Write to MCO	0 N/A	All set-ups		TRUE	0	Uint16
34-08	PCD 8 Write to MCO	0 N/A	All set-ups		TRUE	0	Uint16
34-09	PCD 9 Write to MCO	0 N/A	All set-ups		TRUE	0	Uint16
34-10	PCD 10 Write to MCO	0 N/A	All set-ups		TRUE	0	Uint16
34-2* PCD Read Par.							
34-21	PCD 1 Read from MCO	0 N/A	All set-ups		TRUE	0	Uint16
34-22	PCD 2 Read from MCO	0 N/A	All set-ups		TRUE	0	Uint16
34-23	PCD 3 Read from MCO	0 N/A	All set-ups		TRUE	0	Uint16
34-24	PCD 4 Read from MCO	0 N/A	All set-ups		TRUE	0	Uint16
34-25	PCD 5 Read from MCO	0 N/A	All set-ups		TRUE	0	Uint16
34-26	PCD 6 Read from MCO	0 N/A	All set-ups		TRUE	0	Uint16
34-27	PCD 7 Read from MCO	0 N/A	All set-ups		TRUE	0	Uint16
34-28	PCD 8 Read from MCO	0 N/A	All set-ups		TRUE	0	Uint16
34-29	PCD 9 Read from MCO	0 N/A	All set-ups		TRUE	0	Uint16
34-30	PCD 10 Read from MCO	0 N/A	All set-ups		TRUE	0	Uint16
34-4* Inputs & Outputs							
34-40	Digital Inputs	0 N/A	All set-ups		TRUE	0	Uint16
34-41	Digital Outputs	0 N/A	All set-ups		TRUE	0	Uint16
34-5* Process Data							
34-50	Actual Position	0 N/A	All set-ups		TRUE	0	Int32
34-51	Commanded Position	0 N/A	All set-ups		TRUE	0	Int32
34-52	Actual Master Position	0 N/A	All set-ups		TRUE	0	Int32
34-53	Slave Index Position	0 N/A	All set-ups		TRUE	0	Int32
34-54	Master Index Position	0 N/A	All set-ups		TRUE	0	Int32
34-55	Curve Position	0 N/A	All set-ups		TRUE	0	Int32
34-56	Track Error	0 N/A	All set-ups		TRUE	0	Int32
34-57	Synchronizing Error	0 N/A	All set-ups		TRUE	0	Int32
34-58	Actual Velocity	0 N/A	All set-ups		TRUE	0	Int32
34-59	Actual Master Velocity	0 N/A	All set-ups		TRUE	0	Int32
34-60	Synchronizing Status	0 N/A	All set-ups		TRUE	0	Int32
34-61	Axis Status	0 N/A	All set-ups		TRUE	0	Int32
34-62	Program Status	0 N/A	All set-ups		TRUE	0	Int32
34-64	MCO 302 Status	0 N/A	All set-ups		TRUE	0	Uint16
34-65	MCO 302 Control	0 N/A	All set-ups		TRUE	0	Uint16
34-7* Diagnosis readouts							
34-70	MCO Alarm Word 1	0 N/A	All set-ups		FALSE	0	Uint32
34-71	MCO Alarm Word 2	0 N/A	All set-ups		FALSE	0	Uint32

Table 4.26

4.1.25 35-** Sensor Input Option

Par. No. #	Parameter description	Default value	4-set-up	FC 302 only	Change during operation	Conversion index	Type
35-0* Temp. Input Mode							
35-00	Term. X48/4 Temp. Unit	[60] °C	All set-ups		TRUE	-	Uint8
35-01	Term. X48/4 Input Type	[0] Not Connected	All set-ups		TRUE	-	Uint8
35-02	Term. X48/7 Temp. Unit	[60] °C	All set-ups		TRUE	-	Uint8
35-03	Term. X48/7 Input Type	[0] Not Connected	All set-ups		TRUE	-	Uint8
35-04	Term. X48/10 Temp. Unit	[60] °C	All set-ups		TRUE	-	Uint8
35-05	Term. X48/10 Input Type	[0] Not Connected	All set-ups		TRUE	-	Uint8
35-06	Temperature Sensor Alarm Function	[5] Stop and trip	All set-ups		TRUE	-	Uint8
35-1* Temp. Input X48/4							
35-14	Term. X48/4 Filter Time Constant	0.001 s	All set-ups		TRUE	-3	Uint16
35-15	Term. X48/4 Temp. Monitor	[0] Disabled	All set-ups		TRUE	-	Uint8
35-16	Term. X48/4 Low Temp. Limit	App.Dependent	All set-ups		TRUE	0	Int16
35-17	Term. X48/4 High Temp. Limit	App.Dependent	All set-ups		TRUE	0	Int16
35-2* Temp. Input X48/7							
35-24	Term. X48/7 Filter Time Constant	0.001 s	All set-ups		TRUE	-3	Uint16
35-25	Term. X48/7 Temp. Monitor	[0] Disabled	All set-ups		TRUE	-	Uint8
35-26	Term. X48/7 Low Temp. Limit	App.Dependent	All set-ups		TRUE	0	Int16
35-27	Term. X48/7 High Temp. Limit	App.Dependent	All set-ups		TRUE	0	Int16
35-3* Temp. Input X48/10							
35-34	Term. X48/10 Filter Time Constant	0.001 s	All set-ups		TRUE	-3	Uint16
35-35	Term. X48/10 Temp. Monitor	[0] Disabled	All set-ups		TRUE	-	Uint8
35-36	Term. X48/10 Low Temp. Limit	App.Dependent	All set-ups		TRUE	0	Int16
35-37	Term. X48/10 High Temp. Limit	App.Dependent	All set-ups		TRUE	0	Int16
35-4* Analog Input X48/2							
35-42	Term. X48/2 Low Current	4.00 mA	All set-ups		TRUE	-5	Int16
35-43	Term. X48/2 High Current	20.00 mA	All set-ups		TRUE	-5	Int16
35-44	Term. X48/2 Low Ref./Feedb. Value	0.000 N/A	All set-ups		TRUE	-3	Int32
35-45	Term. X48/2 High Ref./Feedb. Value	100.000 N/A	All set-ups		TRUE	-3	Int32
35-46	Term. X48/2 Filter Time Constant	0.001 s	All set-ups		TRUE	-3	Uint16

Table 4.27

5 Troubleshooting

5.1.1 Warnings/Alarm Messages

A warning or an alarm is signalled by the relevant LED on the front of the frequency converter and indicated by a code on the display.

A warning remains active until its cause is no longer present. Under certain circumstances, operation of the motor may still be continued. Warning messages may be critical, but are not necessarily so.

In the event of an alarm, the frequency converter trips. Reset the alarm to resume operation once the cause has been rectified.

Three ways to reset:

- Press [Reset].
- Via a digital input with the “Reset” function.
- Via serial communication/optional fieldbus.

NOTE

After a manual reset pressing [Reset] press [Auto On] to restart the motor.

If an alarm cannot be reset, the reason may be that its cause has not been rectified, or the alarm is trip-locked (see also *Table 5.1*).

Alarms that are trip-locked offer additional protection, meaning that the mains supply must be switched off before the alarm can be reset. After being switched back on, the frequency converter is no longer blocked and can be reset as described above once the cause has been rectified.

Alarms that are not trip-locked can also be reset using the automatic reset function in *14-20 Reset Mode* (Warning: automatic wake-up is possible!)

If a warning or alarm is marked against a code in *Table 5.1*, this means that either a warning occurs before an alarm, or else that it is possible to specify whether a warning or an alarm should be displayed for a given fault.

This is possible, for instance, in *1-90 Motor Thermal Protection*. After an alarm or trip, the motor carries on coasting, and the alarm and warning flash. Once the problem has been rectified, only the alarm continues flashing until the frequency converter is reset.

NOTE

No missing motor phase detection (numbers 30-32) and no stall detection is active when *1-10 Motor Construction* is set to [1] *PM non salient SPM*.

No.	Description	Warning	Alarm/Trip	Alarm/Trip Lock	Parameter Reference
1	10 Volts low	X			
2	Live zero error	(X)	(X)		6-01 Live Zero Timeout Function
3	No motor	(X)			1-80 Function at Stop
4	Mains phase loss	(X)	(X)	(X)	14-12 Function at Mains Imbalance
5	DC link voltage high	X			
6	DC link voltage low	X			
7	DC over-voltage	X	X		
8	DC under voltage	X	X		
9	Inverter overloaded	X	X		
10	Motor ETR over temperature	(X)	(X)		1-90 Motor Thermal Protection
11	Motor thermistor over temperature	(X)	(X)		1-90 Motor Thermal Protection
12	Torque limit	X	X		
13	Over Current	X	X	X	
14	Earth Fault	X	X		

No.	Description	Warning	Alarm/Trip	Alarm/Trip Lock	Parameter Reference
15	Hardware mismatch		X	X	
16	Short Circuit		X	X	
17	Control word time-out	(X)	(X)		8-04 Control Word Timeout Function
18	Start Failed		X		1-77 Compressor Start Max Speed [RPM] and 1-79 Compressor Start Max Time to Trip
19	Discharge Temp. High	X	X		28-2x Discharge Temp. Monitor
20	Temp. Input Error				
21	Param Error				
22	Hoist Mech. Brake	(X)	(X)		Parameter group 2-2*
23	Internal Fans	X			
24	External Fans	X			
25	Brake resistor short-circuited	X			
26	Brake resistor power limit	(X)	(X)		2-13 Brake Power Monitoring
27	Brake chopper short-circuited	X	X		
28	Brake check	(X)	(X)		2-15 Brake Check
29	Heatsink temp	X	X	X	
30	Motor phase U missing	(X)	(X)	(X)	4-58 Missing Motor Phase Function
31	Motor phase V missing	(X)	(X)	(X)	4-58 Missing Motor Phase Function
32	Motor phase W missing	(X)	(X)	(X)	4-58 Missing Motor Phase Function
33	Inrush Fault		X	X	
34	Fieldbus communication fault	X	X		
35	Option Fault				
36	Mains failure	X	X		
37	Phase imbalance		X		
38	Internal Fault		X	X	
39	Heatsink sensor		X	X	
40	Overload of Digital Output Terminal 27	(X)			5-00 Digital I/O Mode, 5-01 Terminal 27 Mode
41	Overload of Digital Output Terminal 29	(X)			5-00 Digital I/O Mode, 5-02 Terminal 29 Mode
42	Ovrlld X30/6-7	(X)			
43	Ext. Supply (option)				
45	Earth Fault 2	X	X		
46	Pwr. card supply		X	X	
47	24 V supply low	X	X	X	
48	1.8 V supply low		X	X	
49	Speed limit		X		1-86 Trip Speed Low [RPM]
50	AMA calibration failed		X		
51	AMA check U_{nom} and I_{nom}		X		
52	AMA low I_{nom}		X		
53	AMA motor too big		X		
54	AMA motor too small		X		
55	AMA parameter out of range		X		

No.	Description	Warning	Alarm/Trip	Alarm/Trip Lock	Parameter Reference
56	AMA interrupted by user		X		
57	AMA time-out		X		
58	AMA internal fault	X	X		
59	Current limit	X			
60	External Interlock	X	X		
61	Feedback Error	(X)	(X)		4-30 Motor Feedback Loss Function
62	Output Frequency at Maximum Limit	X			
63	Mechanical Brake Low		(X)		2-20 Release Brake Current
64	Voltage Limit	X			
65	Control Board Over-temperature	X	X	X	
66	Heat sink Temperature Low	X			
67	Option Configuration has Changed		X		
68	Safe Stop	(X)	(X) ¹⁾		5-19 Terminal 37 Safe Stop
69	Pwr. Card Temp		X	X	
70	Illegal FC configuration			X	
71	PTC 1 Safe Stop				
72	Dangerous failure				
73	Safe Stop Auto Restart	(X)	(X)		5-19 Terminal 37 Safe Stop
74	PTC Thermistor			X	
75	Illegal Profile Sel.		X		
76	Power Unit Setup	X			
77	Reduced power mode	X			14-59 Actual Number of Inverter Units
78	Tracking Error	(X)	(X)		4-34 Tracking Error Function
79	Illegal PS config		X	X	
80	Drive Initialized to Default Value		X		
81	CSIV corrupt		X		
82	CSIV parameter error		X		
83	Illegal Option Combination			X	
84	No Safety Option		X		
88	Option Detection			X	
89	Mechanical Brake Sliding	X			
90	Feedback Monitor	(X)	(X)		17-61 Feedback Signal Monitoring
91	Analog input 54 wrong settings			X	S202
163	ATEX ETR cur.lim.warning	X			
164	ATEX ETR cur.lim.alarm		X		
165	ATEX ETR freq.lim.warning	X			
166	ATEX ETR freq.lim.alarm		X		
246	Pwr.card supply				
250	New spare parts			X	
251	New Type Code		X	X	

Table 5.1 Alarm/Warning Code List
(X) Dependent on parameter
1) Cannot be Auto reset via 14-20 Reset Mode

A trip is the action when an alarm has appeared. The trip coasts the motor and is reset by pressing [Reset] or by a digital input (parameter group 5-1* [1]). The origin event

that caused an alarm cannot damage the frequency converter or cause dangerous conditions. A trip lock is an action when an alarm occurs, which could damage the frequency converter or connected parts. A Trip Lock situation can only be reset by a power cycling.

Warning	yellow
Alarm	flashing red
Trip locked	yellow and red

Table 5.2 LED Indication

Bit	Hex	Dec	Alarm Word	Alarm Word 2	Warning Word	Warning Word 2	Extended Status Word	Extended Status Word 2
Alarm Word Extended Status Word								
0	00000001	1	Brake Check (A28)	ServiceTrip, Read/Write	Brake Check (W28)	Start Delayed	Ramping	Off
1	00000002	2	Pwr.card temp (A69)	ServiceTrip, (reserved)	Pwr.card temp (A69)	Stop Delayed	AMA Running	Hand/Auto
2	00000004	4	Earth Fault (A14)	ServiceTrip, Typecode/ Sparepart	Earth Fault (W14)	reserved	Start CW/CCW start_possible is active, when the DI selections [12] OR [13] are active and the requested direction matches the reference sign	Profibus OFF1 active
3	00000008	8	Ctrl.Card Temp (A65)	ServiceTrip, (reserved)	Ctrl.Card Temp (W65)	reserved	Slow Down slow down command active, e.g. via CTW bit 11 or DI	Profibus OFF2 active
4	00000010	16	Ctrl. Word TO (A17)	ServiceTrip, (reserved)	Ctrl. Word TO (W17)		Catch Up catch up command active, e.g. via CTW bit 12 or DI	Profibus OFF3 active
5	00000020	32	Over Current (A13)	reserved	Over Current (W13)	reserved	Feedback High feedback > 4-57	Relay 123 active
6	00000040	64	Torque Limit (A12)	reserved	Torque Limit (W12)	reserved	Feedback Low feedback < 4-56	Start Prevented
7	00000080	128	Motor Th Over (A11)	reserved	Motor Th Over (W11)	reserved	Output Current High current > 4-51	Control Ready
8	00000100	256	Motor ETR Over (A10)	reserved	Motor ETR Over (W10)	reserved	Output Current Low current < 4-50	Drive Ready
9	00000200	512	Inverter Overld. (A9)	Discharge High	Inverter Overld (W9)	Discharge High	Output Freq High speed > 4-53	Quick Stop
10	00000400	1024	DC under Volt (A8)	Start Failed	DC under Volt (W8)	Multi-motor underload	Output Freq Low speed < 4-52	DC Brake
11	00000800	2048	DC over Volt (A7)	Speed Limit	DC over Volt (W7)	Multi-motor Overload	Brake Check OK brake test NOT ok	Stop
12	00001000	4096	Short Circuit (A16)	External Interlock	DC Voltage Low (W6)	Compress or Interlock	Braking Max BrakePower > BrakePowerLimit (2-12)	Stand by
13	00002000	8192	Inrush Fault (A33)	Illegal Option Combi.	DC Voltage High (W5)	Mechanical Brake Sliding	Braking	Freeze Output Request

Bit	Hex	Dec	Alarm Word	Alarm Word 2	Warning Word	Warning Word 2	Extended Status Word	Extended Status Word 2
14	0000400 0	16384	Mains ph. Loss (A4)	No Safety Option	Mains ph. Loss (W4)	Safe Option Warning	Out of Speed Range	Freeze Output
15	0000800 0	32768	AMA Not OK	reserved	No Motor (W3)	Auto DC Braking	OVC Active	Jog Request
16	0001000 0	65536	Live Zero Error (A2)	reserved	Live Zero Error (W2)		AC Brake	Jog
17	0002000 0	131072	Internal Fault (A38)	KTY error	10V Low (W1)	KTY Warn	Password Timelock number of allowed password trials exceeded - timelock active	Start Request
18	0004000 0	262144	Brake Overload (A26)	Fans error	Brake Overload (W26)	Fans Warn	Password Protection 0-61 = ALL_NO_ACCESS OR BUS_NO_ACCESS OR BUS_READONLY	Start
19	0008000 0	524288	U phase Loss (A30)	ECB error	Brake Resistor (W25)	ECB Warn	Reference High reference > 4-55	Start Applied
20	0010000 0	1048576	V phase Loss (A31)	reserved	Brake IGBT (W27)	reserved	Reference Low reference < 4-54	Start delay
21	0020000 0	2097152	W phase Loss (A32)	reserved	Speed Limit (W49)	reserved	Local Reference reference site = REMOTE -> auto on pressed & active	Sleep
22	0040000 0	4194304	Fieldbus Fault (A34)	reserved	Fieldbus Fault (W34)	reserved	Protection mode notifikation	Sleep Boost
23	0080000 0	8388608	24 V Supply Low (A47)	reserved	24V Supply Low (W47)	reserved	Unused	Running
24	0100000 0	16777216	Mains Failure (A36)	reserved	Mains Failure (W36)	reserved	Unused	Drive Bypass
25	0200000 0	33554432	1.8V Supply Low (A48)	Current Limit (A59)	Current Limit (W59)	reserved	Unused	Fire Mode
26	0400000 0	67108864	Brake Resistor (A25)	reserved	Low Temp (W66)	reserved	Unused	External Interlock
27	0800000 0	134217728	Brake IGBT (A27)	reserved	Voltage Limit (W64)	reserved	Unused	Firemode Limit Exceed
28	1000000 0	268435456	Option Change (A67)	reserved	Encoder loss (W90)	reserved	Unused	FlyStart active
29	2000000 0	536870912	Drive Initialized(A80)	Encoder loss (A90)	Output freq. lim. (W62)	BackEMF too High	Unused	
30	4000000 0	107374182 4	Safe Stop (A68)	PTC Thermistor (A74)	Safe Stop (W68)	PTC Thermistor (W74)	Unused	
31	8000000 0	214748364 8	Mech. brake low (A63)	Dangerous failure (A72)	Extended Status Word		Protection Mode	

Table 5.3 Description of Alarm Word, Warning Word and Extended Status Word

The alarm words, warning words and extended status words can be read out via serial bus or optional fieldbus for diagnostics. See also *16-94 Ext. Status Word*.

WARNING 1, 10 Volts low

The control card voltage is below 10 V from terminal 50. Remove some of the load from terminal 50, as the 10 V supply is overloaded. Max. 15 mA or minimum 590 Ω.

This condition can be caused by a short in a connected potentiometer or improper wiring of the potentiometer.

Troubleshooting

Remove the wiring from terminal 50. If the warning clears, the problem is with the customer wiring. If the warning does not clear, replace the control card.

WARNING/ALARM 2, Live zero error

This warning or alarm only appears if programmed by the user in *6-01 Live Zero Timeout Function*. The signal on one of the analog inputs is less than 50% of the minimum value programmed for that input. Broken wiring or faulty device sending the signal can cause this condition.

Troubleshooting

Check connections on all the analog input terminals. Control card terminals 53 and 54 for signals, terminal 55 common. MCB 101 terminals 11 and 12 for signals, terminal 10 common. MCB 109 terminals 1, 3, 5 for signals, terminals 2, 4, 6 common).

Check that the frequency converter programming and switch settings match the analog signal type.

Perform Input Terminal Signal Test.

WARNING/ALARM 3, No motor

No motor has been connected to the output of the frequency converter.

WARNING/ALARM 4, Mains phase loss

A phase is missing on the supply side, or the mains voltage imbalance is too high. This message also appears for a fault in the input rectifier on the frequency converter. Options are programmed at *14-12 Function at Mains Imbalance*.

Troubleshooting

Check the supply voltage and supply currents to the frequency converter.

WARNING 5, DC link voltage high

The intermediate circuit voltage (DC) is higher than the high voltage warning limit. The limit is dependent on the frequency converter voltage rating. The unit is still active.

WARNING 6, DC link voltage low

The intermediate circuit voltage (DC) is lower than the low voltage warning limit. The limit is dependent on the frequency converter voltage rating. The unit is still active.

WARNING/ALARM 7, DC overvoltage

If the intermediate circuit voltage exceeds the limit, the frequency converter trips after a time.

Troubleshooting

Connect a brake resistor

Extend the ramp time

Change the ramp type

Activate the functions in *2-10 Brake Function*

Increase *14-26 Trip Delay at Inverter Fault*

If the alarm/warning occurs during a power sag the solution is to use kinetic back-up (*14-10 Mains Failure*)

WARNING/ALARM 8, DC under voltage

If the intermediate circuit voltage (DC link) drops below the under voltage limit, the frequency converter checks if a 24 V DC backup supply is connected. If no 24 V DC backup supply is connected, the frequency converter trips after a fixed time delay. The time delay varies with unit size.

Troubleshooting

Check that the supply voltage matches the frequency converter voltage.

Perform input voltage test.

Perform soft charge circuit test.

WARNING/ALARM 9, Inverter overload

The frequency converter is about to cut out because of an overload (too high current for too long). The counter for electronic, thermal inverter protection issues a warning at 98% and trips at 100%, while giving an alarm. The frequency converter *cannot* be reset until the counter is below 90%.

The fault is that the frequency converter has run with more than 100% overload for too long.

Troubleshooting

Compare the output current shown on the LCP with the frequency converter rated current.

Compare the output current shown on the LCP with measured motor current.

Display the Thermal Drive Load on the LCP and monitor the value. When running above the frequency converter continuous current rating, the counter increases. When running below the frequency converter continuous current rating, the counter decreases.

WARNING/ALARM 10, Motor overload temperature

According to the electronic thermal protection (ETR), the motor is too hot. Select whether the frequency converter issues a warning or an alarm when the counter reaches 100% in *1-90 Motor Thermal Protection*. The fault occurs when the motor runs with more than 100% overload for too long.

Troubleshooting

Check for motor overheating.

Check if the motor is mechanically overloaded

Check that the motor current set in *1-24 Motor Current* is correct.

Ensure that Motor data in parameters 1-20 through 1-25 are set correctly.

If an external fan is in use, check in *1-91 Motor External Fan* that it is selected.

Running AMA in *1-29 Automatic Motor Adaptation (AMA)* tunes the frequency converter to the motor more accurately and reduces thermal loading.

WARNING/ALARM 11, Motor thermistor over temp

Check whether the thermistor is disconnected. Select whether the frequency converter issues a warning or an alarm in *1-90 Motor Thermal Protection*.

Troubleshooting

Check for motor overheating.

Check if the motor is mechanically overloaded.

When using terminal 53 or 54, check that the thermistor is connected correctly between either terminal 53 or 54 (analog voltage input) and terminal 50 (+10 V supply). Also check that the terminal switch for 53 or 54 is set for voltage. Check *1-93 Thermistor Source* selects terminal 53 or 54.

When using digital inputs 18 or 19, check that the thermistor is connected correctly between either terminal 18 or 19 (digital input PNP only) and terminal 50. Check *1-93 Thermistor Source* selects terminal 18 or 19.

WARNING/ALARM 12, Torque limit

The torque has exceeded the value in *4-16 Torque Limit Motor Mode* or the value in *4-17 Torque Limit Generator Mode*. *14-25 Trip Delay at Torque Limit* can change this from a warning only condition to a warning followed by an alarm.

Troubleshooting

If the motor torque limit is exceeded during ramp up, extend the ramp up time.

If the generator torque limit is exceeded during ramp down, extend the ramp down time.

If torque limit occurs while running, possibly increase the torque limit. Make sure that the system can operate safely at a higher torque.

Check the application for excessive current draw on the motor.

WARNING/ALARM 13, Over current

The inverter peak current limit (approximately 200% of the rated current) is exceeded. The warning lasts about 1.5 s, then the frequency converter trips and issues an alarm. This fault can be caused by shock loading or quick

acceleration with high inertia loads. It can also appear after kinetic back-up if the acceleration during ramp up is quick. If extended mechanical brake control is selected, trip can be reset externally.

Troubleshooting

Remove power and check if the motor shaft can be turned.

Check that the motor size matches the frequency converter.

Check parameters 1-20 to 1-25 for correct motor data.

ALARM 14, Earth (ground) fault

There is current from the output phases to earth, either in the cable between the frequency converter and the motor or in the motor itself.

Troubleshooting:

Remove power to the frequency converter and repair the earth fault.

Check for earth faults in the motor by measuring the resistance to ground of the motor leads and the motor with a megohmmeter.

ALARM 15, Hardware mismatch

A fitted option is not operational with the present control board hardware or software.

Record the value of the following parameters and contact your Danfoss supplier:

15-40 FC Type

15-41 Power Section

15-42 Voltage

15-43 Software Version

15-45 Actual Typecode String

15-49 SW ID Control Card

15-50 SW ID Power Card

15-60 Option Mounted

15-61 Option SW Version (for each option slot)

ALARM 16, Short circuit

There is short-circuiting in the motor or motor wiring.

Remove power to the frequency converter and repair the short circuit.

WARNING/ALARM 17, Control word timeout

There is no communication to the frequency converter.

The warning is only active when *8-04 Control Word Timeout Function* is NOT set to [0] Off.

If *8-04 Control Word Timeout Function* is set to [5] Stop and Trip, a warning appears and the frequency converter ramps down until it stops then displays an alarm.

Troubleshooting:

Check connections on the serial communication cable.

Increase *8-03 Control Word Timeout Time*

Check the operation of the communication equipment.

Verify a proper installation based on EMC requirements.

ALARM 18, Start failed

The speed has not been able to exceed *1-77 Compressor Start Max Speed [RPM]* during start within the allowed time. (set in *1-79 Compressor Start Max Time to Trip*). This may be caused by a blocked motor.

Warning/ Alarm 19, Discharge Temperature High

Warning:

The discharge temperature exceeds the level programmed in *28-25 Warning Level*.

Alarm:

The discharge temperature exceeds the level programmed in *28-26 Emergency Level*.

WARNING/ALARM 20, Temp. input error

The temperature sensor is not connected.

WARNING/ALARM 21, Parameter error

The parameter is out of range. The parameter number is reported in the LCP. The affected parameter must be set to a valid value.

WARNING/ALARM 22, Hoist mechanical brake

Report value shows what kind it is.

0 = The torque ref. was not reached before timeout.

1 = There was no brake feedback before timeout.

WARNING 23, Internal fan fault

The fan warning function is an extra protective function that checks if the fan is running/mounted. The fan warning can be disabled in *14-53 Fan Monitor ([0] Disabled)*.

For the D, E, and F Frame filters, the regulated voltage to the fans is monitored.

Troubleshooting

Check for proper fan operation.

Cycle power to the frequency converter and check that the fan operates briefly at start-up.

Check the sensors on the heatsink and control card.

WARNING 24, External fan fault

The fan warning function is an extra protective function that checks if the fan is running/mounted. The fan warning can be disabled in *14-53 Fan Monitor ([0] Disabled)*.

Troubleshooting

Check for proper fan operation.

Cycle power to the frequency converter and check that the fan operates briefly at start-up.

Check the sensors on the heatsink and control card.

WARNING 25, Brake resistor short circuit

The brake resistor is monitored during operation. If a short circuit occurs, the brake function is disabled and the warning appears. The frequency converter is still operational but without the brake function. Remove power to the frequency converter and replace the brake resistor (see *2-15 Brake Check*).

WARNING/ALARM 26, Brake resistor power limit

The power transmitted to the brake resistor is calculated as a mean value over the last 120 seconds of run time. The calculation is based on the intermediate circuit voltage and the brake resistance value set in *2-16 AC brake Max. Current*. The warning is active when the dissipated braking is higher than 90% of the brake resistance power. If *[2] Trip* is selected in *2-13 Brake Power Monitoring*, the frequency converter trips when the dissipated braking power reaches 100%.

WARNING/ALARM 27, Brake chopper fault

The brake transistor is monitored during operation and if a short circuit occurs, the brake function is disabled and a warning is issued. The frequency converter is still operational but, since the brake transistor has short-circuited, substantial power is transmitted to the brake resistor, even if it is inactive.

Remove power to the frequency converter and remove the brake resistor.

WARNING/ALARM 28, Brake check failed

The brake resistor is not connected or not working. Check *2-15 Brake Check*.

ALARM 29, Heatsink temp

The maximum temperature of the heatsink has been exceeded. The temperature fault will not reset until the temperature falls below a defined heatsink temperature. The trip and reset points are different based on the frequency converter power size.

Troubleshooting

Check for the following conditions.

Ambient temperature too high.

Motor cable too long.

Incorrect airflow clearance above and below the frequency converter.

Blocked airflow around the frequency converter.

Damaged heatsink fan.

Dirty heatsink.

ALARM 30, Motor phase U missing

Motor phase U between the frequency converter and the motor is missing.

Remove power from the frequency converter and check motor phase U.

ALARM 31, Motor phase V missing

Motor phase V between the frequency converter and the motor is missing.

Remove power from the frequency converter and check motor phase V.

ALARM 32, Motor phase W missing

Motor phase W between the frequency converter and the motor is missing.

Remove power from the frequency converter and check motor phase W.

ALARM 33, Inrush fault

Too many power-ups have occurred within a short time period. Let the unit cool to operating temperature.

WARNING/ALARM 34, Fieldbus communication fault

The fieldbus on the communication option card is not working.

WARNING/ALARM 35, Option fault

An option alarm is received. The alarm is option-specific. The most likely cause is a power-up or a communication fault.

WARNING/ALARM 36, Mains failure

This warning/alarm is only active if the supply voltage to the frequency converter is lost and *14-10 Mains Failure* is NOT set to [0] *No Function*. Check the fuses to the frequency converter and mains power supply to the unit.

ALARM 37, Phase imbalance

There is a current imbalance between the power units

ALARM 38, Internal fault

When an internal fault occurs, a code number defined in *Table 5.4* is displayed.

Troubleshooting

- Cycle power
- Check that the option is properly installed
- Check for loose or missing wiring

It may be necessary to contact your Danfoss supplier or service department. Note the code number for further troubleshooting directions.

No.	Text
0	Serial port cannot be initialised. Contact your Danfoss supplier or Danfoss Service Department.
256-258	Power EEPROM data is defective or too old. Replace power card.
512-519	Internal fault. Contact your Danfoss supplier or Danfoss Service Department.
783	Parameter value outside of min/max limits
1024-1284	Internal fault. Contact your Danfoss supplier or the Danfoss Service Department.
1299	Option SW in slot A is too old
1300	Option SW in slot B is too old
1302	Option SW in slot C1 is too old
1315	Option SW in slot A is not supported (not allowed)

No.	Text
1316	Option SW in slot B is not supported (not allowed)
1318	Option SW in slot C1 is not supported (not allowed)
1379-2819	Internal fault. Contact your Danfoss supplier or Danfoss Service Department.
2561	Replace control card
2820	LCP stack overflow
2821	Serial port overflow
2822	USB port overflow
3072-5122	Parameter value is outside its limits
5123	Option in slot A: Hardware incompatible with control board hardware
5124	Option in slot B: Hardware incompatible with control board hardware
5125	Option in slot C0: Hardware incompatible with control board hardware
5126	Option in slot C1: Hardware incompatible with control board hardware
5376-6231	Internal fault. Contact your Danfoss supplier or Danfoss Service Department.

Table 5.4 Internal Fault Codes

ALARM 39, Heatsink sensor

No feedback from the heatsink temperature sensor.

The signal from the IGBT thermal sensor is not available on the power card. The problem could be on the power card, on the gate drive card, or the ribbon cable between the power card and gate drive card.

WARNING 40, Overload of digital output terminal 27

Check the load connected to terminal 27 or remove short-circuit connection. Check *5-00 Digital I/O Mode* and *5-01 Terminal 27 Mode*.

WARNING 41, Overload of digital output terminal 29

Check the load connected to terminal 29 or remove short-circuit connection. Check *5-00 Digital I/O Mode* and *5-02 Terminal 29 Mode*.

WARNING 42, Overload of digital output on X30/6 or overload of digital output on X30/7

For X30/6, check the load connected to X30/6 or remove the short-circuit connection. Check *5-32 Term X30/6 Digi Out (MCB 101)*.

For X30/7, check the load connected to X30/7 or remove the short-circuit connection. Check *5-33 Term X30/7 Digi Out (MCB 101)*.

ALARM 43, Ext. supply

MCB 113 Ext. Relay Option is mounted without ext. 24V DC. Either connect an ext. 24V DC supply or specify that no external supply is used via *14-80 Option Supplied by External 24VDC* [0]. A change in *14-80 Option Supplied by External 24VDC* requires a power cycle.

ALARM 45, Earth fault 2

Earth (ground) fault on start-up.

Troubleshooting

Check for proper earthing (grounding) and loose connections.

Check for proper wire size.

Check motor cables for short-circuits or leakage currents.

ALARM 46, Power card supply

The supply on the power card is out of range.

There are three power supplies generated by the switch mode power supply (SMPS) on the power card: 24 V, 5 V, ± 18 V. When powered with 24 V DC with the MCB 107 option, only the 24 V and 5 V supplies are monitored. When powered with three phase mains voltage, all three supplies are monitored.

Troubleshooting

Check for a defective power card.

Check for a defective control card.

Check for a defective option card.

If a 24 V DC power supply is used, verify proper supply power.

WARNING 47, 24 V supply low

The 24 V DC is measured on the control card. The external 24 V DC backup power supply may be overloaded, otherwise contact the Danfoss supplier.

WARNING 48, 1.8 V supply low

The 1.8 V DC supply used on the control card is outside of allowable limits. The power supply is measured on the control card. Check for a defective control card. If an option card is present, check for an overvoltage condition.

WARNING 49, Speed limit

When the speed is not within the specified range in 4-11 *Motor Speed Low Limit [RPM]* and 4-13 *Motor Speed High Limit [RPM]*, the frequency converter shows a warning. When the speed is below the specified limit in 1-86 *Trip Speed Low [RPM]* (except when starting or stopping) the frequency converter will trip.

ALARM 50, AMA calibration failed

Contact your Danfoss supplier or Danfoss Service Department.

ALARM 51, AMA check U_{nom} and I_{nom}

The settings for motor voltage, motor current and motor power are wrong. Check the settings in parameters 1-20 to 1-25.

ALARM 52, AMA low I_{nom}

The motor current is too low. Check the settings.

ALARM 53, AMA motor too big

The motor is too big for the AMA to operate.

ALARM 54, AMA motor too small

The motor is too small for the AMA to operate.

ALARM 55, AMA Parameter out of range

The parameter values of the motor are outside of the acceptable range. AMA will not run.

ALARM 56, AMA interrupted by user

The user has interrupted the AMA.

ALARM 57, AMA internal fault

Try to restart AMA again. Repeated restarts can over heat the motor.

ALARM 58, AMA internal fault

Contact your Danfoss supplier.

WARNING 59, Current limit

The current is higher than the value in 4-18 *Current Limit*. Ensure that Motor data in parameters 1-20 to 1-25 are set correctly. Possibly increase the current limit. Be sure that the system can operate safely at a higher limit.

WARNING 60, External interlock

A digital input signal is indicating a fault condition external to the frequency converter. An external interlock has commanded the frequency converter to trip. Clear the external fault condition. To resume normal operation, apply 24 V DC to the terminal programmed for external interlock. Reset the frequency converter.

WARNING/ALARM 61, Feedback error

An error between calculated speed and speed measurement from feedback device. The function Warning/Alarm/Disabling setting is in 4-30 *Motor Feedback Loss Function*. Accepted error setting in 4-31 *Motor Feedback Speed Error* and the allowed time the error occur setting in 4-32 *Motor Feedback Loss Timeout*. During a commissioning procedure the function may be effective.

WARNING 62, Output frequency at maximum limit

The output frequency has reached the value set in 4-19 *Max Output Frequency*. Check the application to determine the cause. Possibly increase the output frequency limit. Be sure the system can operate safely at a higher output frequency. The warning will clear when the output drops below the maximum limit.

ALARM 63, Mechanical brake low

The actual motor current has not exceeded the "release brake" current within the "Start delay" time window.

WARNING/ALARM 65, Control card over temperature

The cutout temperature of the control card is 80 °C.

Troubleshooting

- Check that the ambient operating temperature is within limits
- Check for clogged filters
- Check fan operation
- Check the control card

WARNING 66, Heatsink temperature low

The frequency converter is too cold to operate. This warning is based on the temperature sensor in the IGBT module.

Increase the ambient temperature of the unit. Also, a trickle amount of current can be supplied to the frequency converter whenever the motor is stopped by setting *2-00 DC Hold/Preheat Current* at 5% and *1-80 Function at Stop*

ALARM 67, Option module configuration has changed

One or more options have either been added or removed since the last power-down. Check that the configuration change is intentional and reset the unit.

ALARM 68, Safe Stop activated

Loss of the 24 V DC signal on terminal 37 has caused the filter to trip. To resume normal operation, apply 24 V DC to terminal 37 and reset the filter.

ALARM 69, Power card temperature

The temperature sensor on the power card is either too hot or too cold.

Troubleshooting

Check that the ambient operating temperature is within limits.

Check for clogged filters.

Check fan operation.

Check the power card.

ALARM 70, Illegal frequency converter configuration

The control card and power card are incompatible. Contact your supplier with the type code of the unit from the nameplate and the part numbers of the cards to check compatibility.

ALARM 71, PTC 1 safe stop

Safe Stop has been activated from the MCB 112 PTC Thermistor Card (motor too warm). Normal operation can be resumed when the MCB 112 applies 24 V DC to T-37 again (when the motor temperature reaches an acceptable level) and when the Digital Input from the MCB 112 is deactivated. When that happens, a reset signal must be sent (via Bus, Digital I/O, or by pressing [Reset]).

ALARM 72, Dangerous failure

Safe Stop with Trip Lock. The Dangerous Failure Alarm is issued if the combination of safe stop commands is unexpected. This is the case if the MCB 112 VLT PTC Thermistor Card enables X44/10 but safe stop is somehow not enabled. Furthermore, if the MCB 112 is the only device using safe stop (specified through selection [4] or [5] in *5-19 Terminal 37 Safe Stop*), an unexpected combination is activation of safe stop without the X44/10 being activated. The following table summarizes the unexpected combinations that lead to Alarm 72. Note that if X44/10 is activated in selection 2 or 3, this signal is ignored! However, the MCB 112 will still be able to activate Safe Stop.

WARNING 73, Safe stop auto restart

Safe stopped. With automatic restart enabled, the motor may start when the fault is cleared.

ALARM 74, PTC Thermistor

Alarm related to the ATEX option. The PTC is not working.

ALARM 75, Illegal profile sel.

Parameter value must not be written while motor is running. Stop motor before writing MCO profile to *8-10 Control Word Profile* for instance.

WARNING 76, Power unit setup

The required number of power units does not match the detected number of active power units.

Troubleshooting:

When replacing an F-frame module, this will occur if the power specific data in the module power card does not match the rest of the frequency converter. Confirm the spare part and its power card are the correct part number.

WARNING 77, Reduced power mode

This warning indicates that the frequency converter is operating in reduced power mode (i.e. less than the allowed number of inverter sections). This warning will be generated on power cycle when the frequency converter is set to run with fewer inverters and will remain on.

ALARM 78, Tracking error

The difference between set point value and actual value has exceeded the value in *4-35 Tracking Error*. Disable the function by *4-34 Tracking Error Function* or select an alarm/warning also in *4-34 Tracking Error Function*. Investigate the mechanics around the load and motor, Check feedback connections from motor – encoder – to frequency converter. Select motor feedback function in *4-30 Motor Feedback Loss Function*. Adjust tracking error band in *4-35 Tracking Error* and *4-37 Tracking Error Ramping*.

ALARM 79, Illegal power section configuration

The scaling card is the incorrect part number or not installed. Also MK102 connector on the power card could not be installed.

ALARM 80, Drive initialised to default value

Parameter settings are initialised to default settings after a manual reset. Reset the unit to clear the alarm.

ALARM 81, CSIV corrupt

CSIV file has syntax errors.

ALARM 82, CSIV parameter error

CSIV failed to init a parameter.

ALARM 83, Illegal option combination

The mounted options are not supported to work together.

ALARM 84, No safety option

The safety option was removed without applying a general reset. Reconnect the safety option.

ALARM 88, Option detection

A change in the option layout has been detected. This alarm occurs when *14-89 Option Detection* is set to [0] *Frozen configuration* and the option layout for some reason has changed. An option layout change has to be enabled in *14-89 Option Detection* before the change is accepted. If the change of configuration is not accepted, it is only

possible to reset Alarm 88 (Trip-lock) when the option configuration has been re-established/corrected.

WARNING 89, Mechanical brake sliding

The hoist brake monitor has detected a motor speed > 10 RPM.

ALARM 90, Feedback monitor

Check the connection to encoder/resolver option and eventually replace the MCB 102 or MCB 103.

ALARM 91, Analog input 54 wrong settings

Switch S202 has to be set in position OFF (voltage input) when a KTY sensor is connected to analog input terminal 54.

WARNING/ALARM 104, Mixing fan fault

The fan monitor checks that the fan is spinning at power-up or whenever the mixing fan is turned on. If the fan is not operating, then the fault is annunciated. The mixing-fan fault can be configured as a warning or an alarm trip by *14-53 Fan Monitor*.

Troubleshooting Cycle power to the frequency converter to determine if the warning/alarm returns.

WARNING 163, ATEX ETR cur.lim.warning

The frequency converter has run above the characteristic curve for more than 50 s. The warning is activated at 83% and de-activated at 65% of the permitted thermal overload.

ALARM 164, ATEX ETR cur.lim.alarm

Operating above the characteristic curve for more than 60 s within a period of 600 s activates the alarm and the frequency converter trips.

WARNING 165, ATEX ETR freq.lim.warning

The frequency converter is running more than 50 s below the permitted minimum frequency (*1-98 ATEX ETR interpol. points freq. [0]*).

ALARM 166, ATEX ETR freq.lim.alarm

The frequency converter has operated more than 60 s (in a period of 600 s) below the permitted minimum frequency (*1-98 ATEX ETR interpol. points freq. [0]*).

ALARM 246, Power card supply

This alarm is only for F Frame frequency converters. It is equivalent to Alarm 46. The report value in the alarm log indicates which power module generated the alarm:

- 1 = left most inverter module.
- 2 = middle inverter module in F2 or F4 frequency converter.
- 2 = right inverter module in F1 or F3 frequency converter.
- 3 = right inverter module in F2 or F4 frequency converter.
- 5 = rectifier module.

WARNING 250, New spare part

A component in the frequency converter has been replaced. Reset the frequency converter for normal operation.

WARNING 251, New typecode

The power card or other components have been replaced and the typecode changed. Reset to remove the warning and resume normal operation.

Index

A

Abs. Enc. Interface, 17-2*..... 145

Adjustable Warnings, 4-5*..... 70

Adv.

- Motor Data, 1-3*..... 38
- Start Adjust, 30-2*..... 149

Advanced Process PID Ctrl., 7-4*..... 103

Alarm

- Log, 15-3*..... 135
- Messages..... 192

AMA..... 198, 201

Analog

- I/O Mode, 6-0*..... 91
- Input..... 197
- Input 1, 6-1*..... 91
- Input 2, 6-2*..... 92
- Input 3 MCB 101..... 93
- Input 4 MCB 101..... 93
- Input X48/2 (MCB 114), 35-4*..... 152
- Inputs..... 4
- Output 1, 6-5*..... 93
- Output 2 MCB 101..... 95
- Output 3 MCB 113, 6-7*..... 97
- Output 4 MCB 113, 6-8*..... 98
- Signal..... 197

B

Brake

- Energy Funct..... 52
- Power..... 4

Braking..... 199

Break-away Torque..... 4

Bus

- Controlled, 5-9*..... 89
- Jog, 8-9*..... 111

C

Catch Up..... 74

Clockwise..... 44

Coasting..... 3, 13

Communication Option..... 200

Comparators, 13-1*..... 114

Compatibility,

- 14-7*..... 131
- 30-8*..... 149

Configuration..... 106

Control

- Cables..... 9
- Card..... 197
- Principle..... 34

Cooling..... 49

Copy/Save, 0-5*..... 32

Ctrl. Word Settings, 8-1*..... 107

Current

- Limit Control, 14-3*..... 129
- Rating..... 197

D

Data

- Log Settings..... 133
- Readouts 2, 18-**..... 147
- Readouts, 16-**..... 138

DC Link..... 197

DC-Brakes..... 52

Default Settings..... 1, 153

Definitions..... 3

DeviceNet CAN Fieldbus, 10-**..... 112

Diagnosis Read-Outs, 16-9*..... 143

Digital

- I/O Mode, 5-0*..... 72
- Input..... 198
- Inputs..... 72
- Pot.Meter, 3-9*..... 65

Digital/Bus, 8-5*..... 110

Display Mode..... 14

Drive

- Identification..... 135
- Status, 16-3*..... 139

E

Encoder Pulses..... 88

Energy Optimising, 14-4*..... 130

Environment, 14-5*..... 130

Ethernet, 12-**..... 112

ETR..... 139

Ext. Process PID Ctrl., 7-5*..... 104

F

FC

- MC Protocol Set, 8-4*..... 108
- Port Diagnostics, 8-8*..... 111
- Port Settings, 8-3*..... 107

Feedback..... 200

Fieldbus & FC Port, 16-8*..... 142

Freeze Output..... 3

Fuses..... 200

G

General

- Settings..... 34
- Settings, 8-0*..... 106
- Status, 16-0*..... 138

Graphical Display..... 11

H
Historic Log, 15-2*..... 134

I
I/O Options, 5-8*..... 89
Inc. Enc. Interface, 17-1*..... 145
Indexed Parameters..... 20
Indicator Lights..... 12
Initialisation..... 1
Input Terminal..... 197
Inputs And Outputs..... 141
Inverter Switching, 14-0*..... 125

J
Jog..... 3

L
Language Package..... 24

LCP
 LCP..... 3, 5, 11, 13, 20
 Custom Readout, 0-3*..... 30
 Display, 0-2*..... 27
 Keypad, 0-4*..... 31

LEDs..... 11
Load Depend. Setting, 1-6*..... 42

Local
 Control Keys..... 1
 Reference..... 25

Logic Rules, 13-4*..... 119

M
Main
 Menu..... 15
 Menu Mode..... 12, 18
 Reactance..... 37

Mains
 On/Off, 14-1*..... 125
 Supply..... 6

MCB
 113..... 77, 82, 97, 98
 114..... 151

Mechanical Brake..... 54
Monitoring And Application, 17-6*..... 146

Motor
 Current..... 201
 Data..... 198, 201
 Data, 1-2*..... 36
 Feedb. Option, 17-**..... 145
 Feedback Monitoring, 4-3*..... 68
 Limits, 4-1*..... 67
 Power..... 201
 Protection..... 46
 Status..... 138
 Temperature, 1-9*..... 46

N
Numerical Local Control Panel..... 20

O
Operating
 Data, 15-0*..... 133
 Mode..... 24

Operation/Display, 0-**..... 24
Option Ident. , 15*6*..... 136
Options, 14-8*..... 132
Other Ramps, 3-8*..... 64

Output
 Current..... 197
 Speed..... 44

P
Parameter
 Info..... 137
 Selection..... 18
 Set-Up..... 15

Password, 0-6*..... 32
Phase Loss..... 197
Potentiometer Reference..... 10

Process
 Ctrl. Feedb., 7-2*..... 102
 PID Ctrl., 7-3*..... 103

Profibus, 9-**..... 112
Programming..... 197
Protection Mode..... 7

Pulse
 Input, 5-5*..... 85
 Outputs, 5-6*..... 86
 Start/Stop..... 10

Q
Quick
 Menu..... 12, 15
 Menu Mode..... 12, 15
 Transfer Of Parameter Settings Between Multiple Frequency Converters..... 13

R

Ramp
 2, 3-5* 61
 3, 3-6* 62
 4, 3-7* 63

Ramps, 3-4* Ramp 1 60

Rated Motor Speed 3

RCD 5

Ref. & Feedb 140

Reference Limits, 3-0* 57

Reference/Reference Limits/Ramps, 3-** 57

References, 3-1* 58

Relay Outputs 77

Relays, 5-4* 82

Reset 197, 202, 13

Resolver Interface, 17-5* 145

RS Flip Flops, 13-1* 117

S

Safety Precautions 6

Screened/armoured 9

Sensor Input Option, 35-** 151

Serial Communication 4

Set-up Operations, 0-1* 25

Short Circuit 198

Smart
 Application Setup (SAS) 18
 Logic Control, 112

Special
 Features, 30-** 148
 Settings, 1-1* 35

Speed
 Bypass, 4-6* 71
 PID Ctrl 100
 Up/Down 10

Start
 /Stop 9
 Adjustments 44
 Delay 44
 Function 44

States, 13-5* 122

Stator Leakage Reactance 37

Status
 Status 12
 Messages 11

Step-by-Step 19

Stop Adjustments, 1-8* 45

Supply Voltage 200

Symbols 3

Synchronous Motor Speed 3

T

Temp.
 Input Mode (MCB 114), 35-0* 151
 Input X48/10 (MCB 114), 35-3* 152
 Input X48/4 (MCB 114), 35-1* 151
 Input X48/7 (MCB 114), 35-2* 151

Terminal
 54 203
 X45/1 Output Min Scale, 6-71 98
 X45/3 Output Min Scale, 6-81 99

Thermal Load 40, 139

Thermistor 47, 5

Timers, 13-2* 119

Torque PI Control, 7-1* 102

Trip Reset 127

V

Value 19

Voltage
 Imbalance 197
 Reference Via A Potentiometer 10

WCplus 5

W

Warnings 192

Wobble Function, 30-0* 148

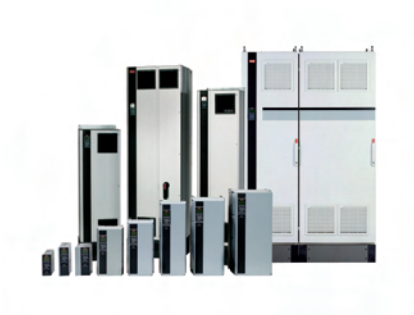

www.danfoss.com/drives

Danfoss can accept no responsibility for possible errors in catalogues, brochures and other printed material. Danfoss reserves the right to alter its products without notice. This also applies to products already on order provided that such alterations can be made without subsequential changes being necessary in specifications already agreed. All trademarks in this material are property of the respective companies. Danfoss and the Danfoss logotype are trademarks of Danfoss A/S. All rights reserved.



