

SIEMENS

SIMATIC HMI

OP5, OP15 Operator Panel

Equipment Manual

Preface, Contents

	1
Teil I: Introduction	∇
	2
	3
Teil II: Basic Functions	∇
	10
	11
Teil III: Expanded, Configurable Functions	∇
	13
	14
Teil IV: Commissioning and Description of Devices	∇
	20
	A
Teil V: Appendix	∇
	F

Glossary, Index

6AV3991-1 AB20-0AB0

Release 01/96

Safety Guidelines

This manual contains notices which you should observe to ensure your own personal safety, as well as to protect the product and connected equipment. These notices are highlighted in the manual by a warning triangle and are marked as follows according to the level of danger:



Warning

indicates that death, severe personal injury or substantial property damage **can** result if proper precautions are not taken.



Caution

indicates that minor personal injury or property damage can result if proper precautions are not taken.

Note

draws your attention to particularly important information on the product, handling the product, or to a particular part of the documentation.

Qualified Personnel

Equipment may be commissioned and operated only by **qualified personnel**. Qualified personnel within the meaning of the safety notices in this manual are persons who are authorized to commission, ground and identify equipment, systems and circuits in accordance with safety engineering standards.

Correct Usage

Note the following:



Warning

The equipment may be used only for the applications stipulated in the catalog and in the technical description and only in conjunction with other equipment and components recommended or approved by Siemens.

Startup must not take place until it is established that the machine, which is to accommodate this component, is in conformity with the guideline 89/392/EEC.

Faultless and safe operation of the product presupposes proper transportation, proper storage, erection and installation as well as careful operation and maintenance.

Trademarks

SIMATIC® is a registered trademark of Siemens AG.

Some of the other designations used in these documents are also registered trademarks; the owner's rights may be violated if they are used by third parties for their own purposes.

Impressum

Editor and Publisher: AUT 91

Copyright © Siemens AG 1996 All rights reserved

The reproduction, transmission or use of this document or its contents is not permitted without express written authority. Offenders will be liable for damages. All rights, including rights created by patent grant or registration of a utility model or design, are reserved.

Siemens AG,
Bereich Automatisierungstechnik,
Bedienen und Beobachten
Postfach 4848, D-90327 Nuernberg

Disclaimer of Liability

We have checked the contents of this manual for agreement with the hardware and software described. Since deviations cannot be precluded entirely, we cannot guarantee full agreement. However, the data in this manual are reviewed regularly and any necessary corrections included in subsequent editions. Suggestions for improvement are welcomed.

Technical data subject to change.
© Siemens AG 1996





Preface

Purpose

This equipment manual is a part of the documentation for the OP5 and OP15 Operator Panels **which have been configured with ProTool configuration software**. It provides operators, fitters, configurers and system support engineers with information on functionality and the technical design of the OP5 and OP15 Operator Panels.

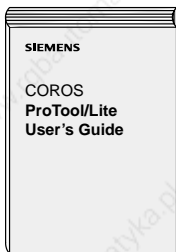
Complete documentation

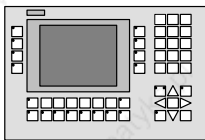
The following manuals/media make up the complete set of documentation for the OP5 and OP15 Operator Panels.

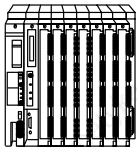
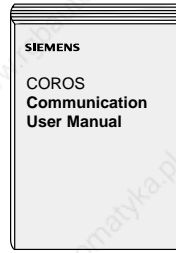
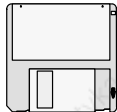
<p>PC Configuration</p> 		
<p>OP Installation Operator control</p> 		
<p>PLC Coupling</p> 		<p>Other PLCs</p> 

How the Manual is Organized

This manual is divided into five parts:

Part I

Chapters 1 and 2 contain information of a general nature. They describe the general design of Operator Panels OP5 and OP15 and provide an overview of the functions of the different device versions.

Part II

Chapters 3 and 4 describe how you operate the devices. You should study these chapters before using the different functions.

Chapters 5 to 10 provide a detailed description of how you use different functions – for instance, screens, messages, password protection and recipes.

Part III

Chapters 11 to 13 describe the expanded functions of the OP such as online modification of system settings, controller jobs and schedulers.

Part IV

Chapters 14 to 20 inform you about installation, connecting, commissioning, testing and maintenance of the Operator Panels. This part is aimed primarily at installation and commissioning personnel.

Part V

Appendices A to F contain miscellaneous tables, ESD guidelines and a glossary of the terms used in this manual.

Conventions

The following conventions are used in this manual:

<code>Motor off</code>	Text on the display of the OP is shown in “typewriter” style
<i>Variable</i>	Symbolic names representing variable values on the display are shown in italic “typewriter” style.
<i>Screens</i>	Functions which you can choose are shown in normal italics.
<i>Screens</i> → <i>Print</i>	Steps that are performed in succession are linked by an arrow.
ESC	The names of keys are shown in a different typeface.

History

The different editions of the equipment manual refer to the following Pro-Tool/Lite versions or OP firmware versions.

Edition	Remarks	ProTool/Lite-Version	OP-Firmware
06/95	First edition of the manual	Up to V 1.01	OP5: From V 1.20 OP15: From V 2.20
01/96	Expansion of the manual to include recipe and scheduler functions	From V 2.0	OP5: From V 1.30 OP15: From V 2.30

Other support

For technical questions, get in touch with your local Siemens representative. You will find the addresses in appendix F of this manual, in our catalogs and under Compuserve (go autforum) to mention a few examples. In addition, our hotline is ready to help you (telephone +49 (911) 895-7000, fax +49 (911) 895-7001).

Abbreviations

AS511	Protocol of the PU interface to the SIMATIC S5
ASIC	Application-specific integrated circuit
CPU	Central processing unit
EM	Equipment manual (German abbreviation: GHB)
EPROM	(with UV light) erasable programmable read-only memory
EV	Event messages
FB	Function block
IF	Interface designation
LCD	Liquid-crystal display
LED	Light-emitting diode
MPI	Multipoint Interface
OD	Output double word (on the PLC)
OP	Operator Panel
PLC	Programmable Logic Controller
PPI	Point to Point Interface
PU	Programming Unit (German abbreviation: PG)
RAM	Random access memory (working memory)
SRAM	Static RAM (buffered)
VF	Vacuum fluorescence

www.rgbautomatyka.pl

Contents

Preface

Part I Introduction

1	Product Description	1-1
1.1	Configuration and process control phases	1-1
1.2	Functions of an Operator Panel	1-3
1.3	Design of Operator Panel OP5	1-6
1.4	Design of Operator Panel OP15	1-7
2	Functionality	2-1

Part II Basic functions

3	Using the OP with Its Standard Functions	3-1
3.1	Operating Levels	3-1
3.2	Standard Screens	3-3
3.3	Branching in Standard Screens	3-5
4	General Operation	4-1
4.1	System Keyboard	4-1
4.1.1	ESCAPE Functions	4-4
4.1.2	Information Text	4-5
4.2	Entering Values	4-6
4.2.1	Entering Numerical Values	4-7
4.2.2	Entering Alphanumeric Values	4-8
4.2.3	Entering Symbolic Values	4-9
5	Screens	5-1
5.1	Screen Entries	5-2
5.2	Choosing Screens	5-3
5.3	Editing Screens	5-4
5.4	Printing Screens	5-4

6	Password Protection	6-1
6.1	Password Levels and Access	6-1
6.2	Login/Logout on OP (LOGIN/LOGOUT)	6-2
6.3	Password Management	6-3
7	Message Handling	7-1
7.1	Event Messages and Alarm Messages	7-2
7.1.1	Acknowledging Alarm Messages	7-3
7.1.2	Inhibiting Alarm Messages	7-4
7.2	System Messages	7-5
7.3	Displaying Messages	7-6
7.3.1	Display Sequences	7-7
7.3.2	Scrolling through Waiting Messages at Message Level	7-8
7.3.3	Viewing Event and Alarm Message Text	7-8
7.4	Viewing Message Buffers	7-9
7.5	Deleting Messages	7-12
7.5.1	Deleting Event and Alarm Messages Using Standard Screens	7-12
7.5.2	Automatically Deleting the Alarm Buffer upon Buffer Overflow	7-12
7.5.3	Automatically Deleting the Event Buffer upon Buffer Overflow	7-13
7.5.4	Automatically Deleting the System Message Buffer upon Buffer Overflow	7-13
7.6	Printing Messages	7-14
7.6.1	Direct Message Logging	7-14
7.6.2	Printing the Message Buffer	7-15
8	Recipes	8-1
8.1	Setting Up and Editing Data Records	8-5
8.2	Copying Data Records	8-7
8.3	Transferring Data Records	8-8
8.4	Deleting Data Records	8-11
9	STATUS VAR and FORCE VAR Functions with the OPs (S7/S5 Only)	9-1
10	System Settings on Standard Screens	10-1
10.1	Selecting a Language	10-1
10.2	Modifying Parameters in Online Mode	10-2
10.3	Adjusting Contrast	10-3
10.4	Modes	10-4

Part III Expanded, Configurable Functions

11	Process-Dependent Operator Guidance	11-1
11.1	Branching by Means of Soft Keys and Function Keys	11-1
11.2	Self-Defined Screen Hierarchy	11-2
12	Schedulers	12-1
13	Controlling the OP from the PLC	13-1

Part IV Commissioning and Description of Devices

14	Mechanical Installation	14-1
15	Electrical Installation	15-1
15.1	Setup Guidelines for Interference-Proof Installation	15-2
15.2	Assigning the Terminal Block	15-3
15.3	Connecting a Configuration Computer	15-5
15.4	Connections to PLC	15-6
15.5	Loop-Through Mode (OP15 only)	15-7
16	Commissioning	16-1
16.1	Commissioning Guide	16-2
16.2	Start-up Behavior	16-4
16.3	Testing the Configuration in OFFLINE Mode	16-5
16.4	Testing the Configuration in Conjunction with the PLC	16-6
17	Device Description	17-1
17.1	OP5	17-1
17.2	OP15	17-3
17.3	Labeling strips	17-5
17.4	External Floppy Disk Station (Option for OP15)	17-6
18	Connecting a Printer	18-1
19	Test and Monitoring Functions	19-1
20	Maintenance	20-1

Part V Appendices

A	Brief Description of Standard Screens	A-1
B	System Messages	B-1
C	Technical Data	C-1
D	Interface Assignment	D-1
	D.1 Interface Configuration	D-1
	D.2 Pin Assignment	D-1
E	ESD Guidelines	E-1
	E.1 What Does ESD Mean?	E-1
	E.2 Important Precautions against Electrostatic Discharge	E-2
	E.3 Handling ESD Assemblies	E-2
	E.4 Measuring and Modifying ESD Assemblies	E-2
	E.5 Shipping ESD Assemblies	E-3
F	Siemens Worldwide	F-1

Glossary

Index

Part I Introduction

Product Description

1

Functionality

2

Product Description

1

Applications of OP5 and OP15

Operator Panels OP5 and OP15 allow operating states, current process values and malfunctions of a connected PLC to be visualized. In addition, inputs can be made on the OP which can be written directly to the PLC. Some functions relating to machine diagnostics can also be executed on the Operator Panel.

The Operator Panels are suitable for fitting into switching cabinets and control desks. A printer can be attached to the OP for logging processes during automation operation.

The Operator Panels feature a number of standard functions. The displays and operation of the devices can be optimized by the configurer to meet the requirements of the process.

1.1 Configuration and process control phases

Creating data areas

Before an OP can go into service, it has to be prepared for its job of visualizing data from the PLC, i.e. it has to be configured. As far as the PLC is concerned, data areas used by the OP to communicate with the PLC have to be created in the memory.

Configuration with ProTool/Lite

The configuration for the OP is created on a computer (PC/PU) using ProTool/Lite configuration software under Microsoft® Windows™. When the configuration is ready, it is transferred to the OP. Before this can be done, however, the computer has to be connected to the Operator Panel. Following transfer of the configuration, the OP has to be connected to the PLC.

The OP now communicates with the PLC and reacts to program flows on the PLC on the basis of the configured requirements.

The following illustration depicts the configuration and process control phases de scribed above:

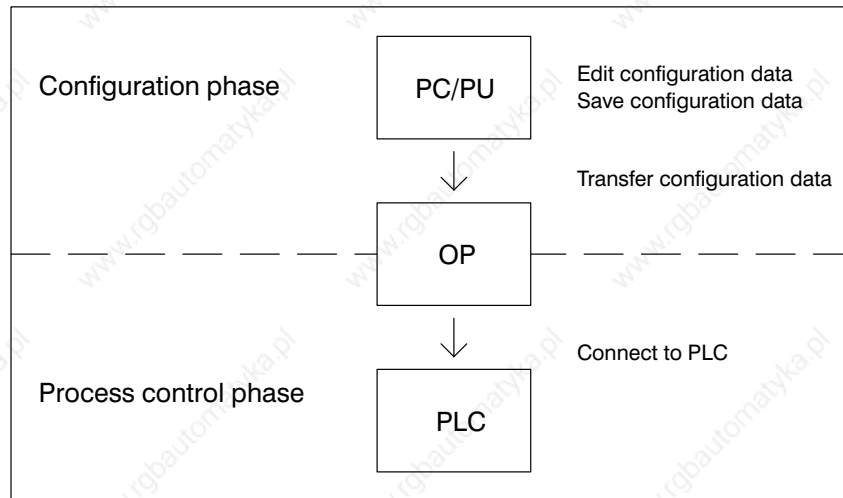

Figure 1-1 Configuration and Process Control Phase

Static and variable text components

Text which is required to be displayed on the OP has first to be created on the PC/PU with ProTool/Lite and then transferred to the OP. If, for example, text for display is required to comprise static and variable components, the variables have to be configured and the static text for explaining the variables has to be entered – for example:

Temperature *Variable_xx* C of Furnace 1

Here, Temperature C of Furnace 1 is the static text and *Variable_xx* is the variable that is read from the memory area of the PLC.

Further information

You will find information on configuring the OP in the *ProTool/Lite User's Guide*. The *Communications User's Guide* provides information on connecting the OP to the PLC.

1.2 Functions of an Operator Panel

Display and control functions

The basic functions of an OP consist in displaying process states and in controlling the process. The following display and control functions can be configured on Operator Panels OP5 and OP15:

- screens
- event messages
- alarm messages
- recipes
- information text
- logging
- languages.

Screens

Data supplied by the PLC may be displayed together on a screen and modified individually, if required. A screen consists of several screen entries since, for example, more related data are required for describing a machine state than can normally be displayed in the window of a screen. Therefore data on operating temperature, fill level, speed and running time can illustrate the current machine state.

The OP5 and OP15 are line displays. Accordingly, a screen on the display comprises text items which may include static text and current state values.

Screens may be combined on the OP in a directory. You can use the directory to display, print and edit screens.

Event messages

Event messages are information and operating notes on current machine and process states during regular production operations. Event messages may contain process values. Process values are displayed either numerically – for example,

Motor running at 3000 revs

or symbolically – for example,

Motor running normally,

where a specific control value is assigned to normally.

The classification of a message as an event message is done at the configuration stage.

Alarm messages

Alarm messages show, in contrast to event messages, critical machine states during production operations. Due to their urgency, they have to be acknowledged before any other action is possible.

Alarm messages may contain process values. Process values are displayed either numerically – for example

Motor speed 4500

or symbolically – for example

Motor speed too high,

where a specific control value is assigned to too high.

This type of message has a higher display priority than an event message. If an alarm message is issued, any event message or screen that is being displayed is replaced with a flashing alarm on the display.

The classification of a message as an alarm message is made at the configuration stage.

Recipes

When a product is made up of various ingredients in certain ratios, this information is stored in a so-called recipe.

Take orange juice for example. Its production and bottling requires that orange concentrate and water be mixed in a certain ratio. These values are stored as variables in a recipe.

Each recipe can be made up of several data records containing different values for the recipe.

The data can be edited in the OP, transferred to the PLC and read out from the PLC.

In the OP, the recipes are combined by recipe number and title in a recipe directory.

Information text

Information text is additional information and hints for operators referring to the current display on the screen (event messages, alarm messages and screens). This means that additional troubleshooting information can be displayed when, for instance, an alarm message is issued.

Information text can also be displayed by pressing a key, if required, when the LED of the HELP key is on.

Logging

Messages can be printed in online mode by means of the printer connected to the OP. Furthermore, there is a possibility of printing all the event and alarm messages that have accumulated in the buffer concerned.

Languages

Message text, screens, information text and system messages may be displayed in several languages. Up to three of the languages listed below can be loaded simultaneously on the same OP and presented to the operator for selection on line:

- German
- English
- French
- Italian
- Spanish.

For the OP15/C, displays can be configured in Russian, i.e. in Cyrillic characters.

1.3 Design of Operator Panel OP5

OP5 versions

The OP5 is available in the following two versions:

- OP5/A1 and
- OP5/A2.

The two versions differ only in their communication options.

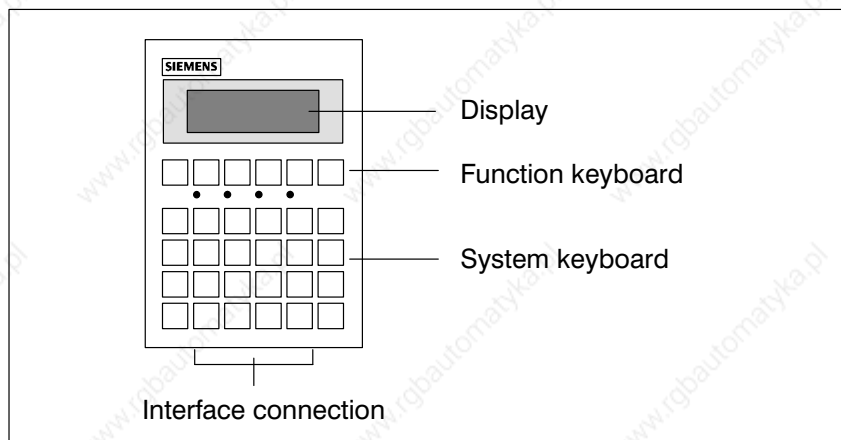

Figure 1-2 Design of Operator Panel OP5

LCD

Display of up to 4 lines each having a maximum length of 20 characters; the height of the characters is 5 mm.

Function keyboard

6 keys (F1 to F6) for calling freely programmable, generally valid standard functions.

Soft keys

4 keys (F2 to F5) may alternatively be configured as soft keys. Each of these keys can be configured with different functions for the various screens.

System keyboard

24 keys with permanently assigned function calls.

Interfaces

The OP5/A1 has an interface for connecting the PLC/computer and printer. The OP5/A2 has two interfaces for this purpose.

1.4 Design of Operator Panel OP15

OP15 versions

The OP15 is available in the following versions:

- OP15/A1,
- OP15/A2,
- OP15/A1-VF,
- OP15/A2-VF,
- OP15/C1 and
- OP15/C2.

The versions listed above differ in their display and communication options.

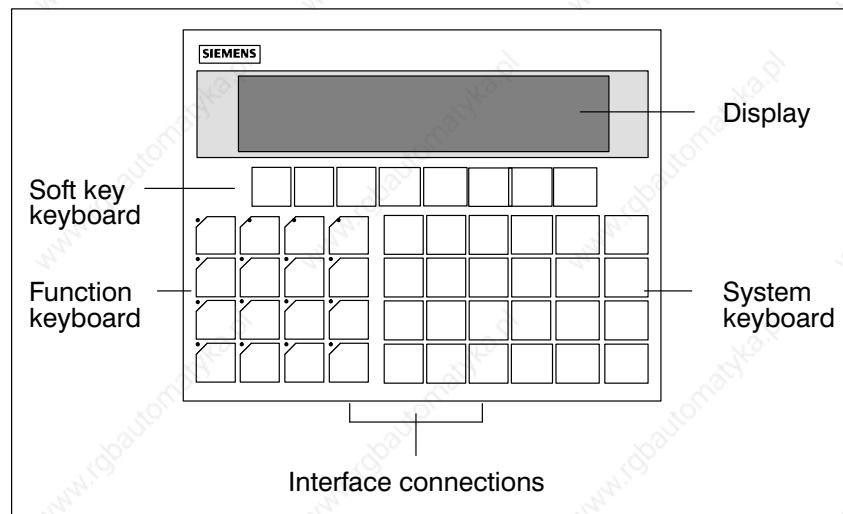

Figure 1-3 Design of Operator Panel OP15

LCD	OP15/A: Display of 2 lines each containing up to 40 characters; the height of the characters is 5 mm. OP15/C: Display of up to 4 lines each having a maximum length of 20 characters; the height of the characters is 8 mm; or display of up to 8 lines each having a maximum length of 40 characters; the height of the characters is 4 mm.
Vacuum-fluorescence display	OP15/A-VF: Display of 2 lines each containing up to 40 characters; the height of the characters is 5 mm.
Function keyboard	16 keys (K1 to K16), each having an LED for freely programmable functions. The LEDs can be driven from the PLC.
Soft keys	8 keys (F1 to F8) beneath the display, which can be configured with screen-specific functions.
System keyboard	24 keys with permanently assigned function calls.
Interfaces	3 interfaces for connecting the PLC and a printer or a computer.

Functionality

2

Functions of OP5 and OP15 versions

The table below provides an overview of the functions of Operator Panels OP5 and OP15 with their different versions.

Table 2-1 Functionality of OP5 and OP15

	OP5	OP15
Display		
– Technology	LCD	A, C: LCD A-VF: VF
– Lines x characters per line/character height (mm)	4x20/5	A, A-VF : 2x40/5 C: 4x20/8 or 8x40/4
– Contrast control	x	A, C
Event Messages		
– Maximum number	499	999
– Maximum length (characters)	80x	80
– Display	x	x
– Print	x	x
– View event message text	x	x
– Maximum number of entries in the event buffer	256	256
– View event buffer	x	x
– Print event buffer	x	x
– Delete event buffer	x	x
Alarm Messages		
– Maximum number	499	999
– Maximum length (characters)	80	80
– Display	x	x
– Print	x	x
– View alarm message text	x	x
– Maximum number of entries in alarm buffer	256	256
– View alarm buffer	x	x
– Print alarm buffer	x	x
– Delete alarm buffer	x	x

Table 2-1 Functionality of OP5 and OP15

	OP5	OP15
Message Acquisition		
– in buffer with date, time, state	x	x
Variable Input		
– Numbers or letters	x	x
– Symbolic variables	x	x
Display of Actual Value (numerical and symbolic)	x	x
Combined Actual Value Display and Variable Input	x	x
Limit Value Check of Operator Input	x	x
Password Protection (also by means of authorization input)	x	x
Screens		
– Maximum number	99	99
– Maximum number of lines per screen	396	396
– Display	x	x
– Print	x	x
– Screen entries per screen	99	99
– Maximum number of fields per screen	300	300
– Maximum number of fields per screen entry	32	32
Recipes		
– Maximum number	99	99
– View	x	x
– Print	x	x
– Recipe entries per recipe	99	99
– Recipe memory size (in Kbytes)	4	20
– Data records per recipe (maximum)	99	99
– Save/fetch data record in/from the OP	x	x
– Save/fetch data record on/from floppy disk (additional hardware required)	–	x
Information Text		
– Maximum length (characters)	320	320
Scheduler times	-	48
Function Keys		
– Number	6	16
– Integrated LEDs	–	x
Soft Keys (number)	4 (of funct. keys)	8 (extra)
Logs	x	x
Diagnostic Function (STATUS/FORCE VAR) S7/S5 only	x	x
Loop-Through Mode for Configuration Computer or Additional TD/OP	–	x
Configurable OP Languages German, English, French, Italian, Spanish Russian	x –	x C

Table 2-1 Functionality of OP5 and OP15

	OP5	OP15
Changing Languages in Online Mode	3	3
Communication by means of		
SIMATIC S5		
– AS511	A1	A1, A1-VF, C1
– FAP	A1	A1, A1-VF, C1
– SINEC L2-DP	A2	A2, A2-VF, C2
SIMATIC S7		
– PPI	A2	A2, A2-VF, C2
– MPI	A2	A2, A2-VF, C2
Other PLCs		
– SIMATIC 500/505	x	x
– Free serial	x	x
– Allen Bradley	1)	1)
– Mitsubishi	1)	1)

1) Driver optional

www.rgbautomatyka.pl

Part II Basic functions

Using the OP with Its Standard Functions	3
General Operation	4
Screens	5
Password Protection	6
Message Handling	7
Recipes	8
STATUS VAR and FORCE VAR Functions with the OPs	9
System Settings on Standard Screens	10

Using the OP with Its Standard Functions

3

Loading a configuration

Once the operating voltage has been connected, you have to load a configuration into the OP so that you can operate it. The OP is in Transfer mode until a configuration is loaded.

Using standard screens

The configuration software supplied to you, ProTool/Lite, includes a configuration which contains standard screens. You can choose all the functions required for operating the OPs by using these standard screens. The different functions are described in this manual with reference to the standard screens.

3.1 Operating Levels

Message level and screen level

In OP operation, you have to distinguish between two distinct operating levels, between which you can switch:

- **Message level**
At the message level, current messages are displayed.
- **Screen level**
At the screen level, functions are chosen, serviced and executed.

The message level is the highest level on the OP. At message level, waiting event messages, alarm messages and system messages are displayed. After the OP starts up, it changes to message level and displays the "standby message".

The screen level is reached by pressing the ENTER key. The first screen to be called is the "start" screen. From the start screen you branch, depending on the configuration, to other screens. On the screens, you view current process values, can enter values and initiate functions by means of soft keys.

Screen hierarchy

The linking of individual screens is referred to as a "screen hierarchy". If you go to the bottom of the screen hierarchy, you go back one stage by pressing key ESC, right back to the start screen should you wish. From here you can return to the message level by pressing the ESC key. You can also return directly to the message level from a screen, depending on the configuration.

Changing operating levels

You change the operating level

- from message level to screen level by pressing the ENTER key,
- from screen level to message level by pressing the ESCAPE key.

Figure 3-1 illustrates how you can change from one operating level to another.

You cannot branch backward from the message level by pressing ESCAPE. The key is designed to terminate the display of a system message at this level.

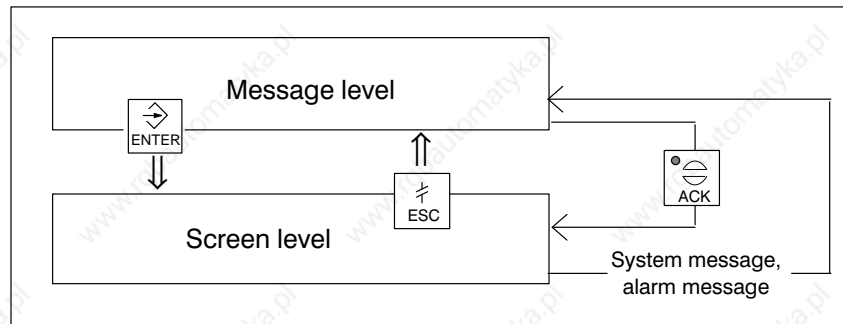

Figure 3-1 Changing between Message Level and Screen Level

Forced change to message level

You exit from the screen level automatically whenever a system message or an alarm message is waiting to be displayed. The OP then changes to message level to display the message. You cannot exit from the message level while a system message or unacknowledged alarm message is being displayed. The display of an unacknowledged alarm message is indicated on the OP by the

- alarm message flashing and
- lit ACK LED.

You acknowledge an alarm message by pressing the ACK key. You hide a system message by pressing the ESCAPE key.

Once the alarm message has been acknowledged or the system message cleared, the OP returns to the point from which it changed to the message level.

3.2 Standard Screens

Basic operations with standard screens

The standard screens contain functions that are fundamental to OP operation. They include, for instance, calling and printing message buffers, editing passwords and modifying parameters in online mode. Process-specific implementations, such as event messages or screens for the process, are not included.

Functions on standard screens

Standard screens are called from a basic screen by means of a soft key. From the basic screen, a jump is made to the following screens:

- Alarm messages
At this point the alarm buffer is called, printed or deleted.
- Event messages
At this point the event buffer is called, printed or deleted.
- Screens
At this point the screen directory is called to edit or print screens. All the screens which were given the "directory" attribute are listed here. If you still have not created any screens of your own, the directory will be empty.
- Data records
At this point you can set up and edit data records. You can also transfer data records from the OP to the PLC and back.
- System settings
At this point you can modify settings in online mode. This includes, for example, printer parameters, interface parameters, mode, and language changing.
- Status variable
At this point the PU function STATUS VAR is called; you can use it to display PLC operands.
- Force variable
At this point the PU function FORCE VAR is called; you can use it to display and modify PLC operands.
- Edit password
At this point the superuser assigns passwords for the different password levels. Furthermore, login and logout are included here.

Figure 3-2 shows an overview of the screen hierarchy of standard screens. You will find detailed information on functions and handling standard screens in the relevant chapters of this manual.

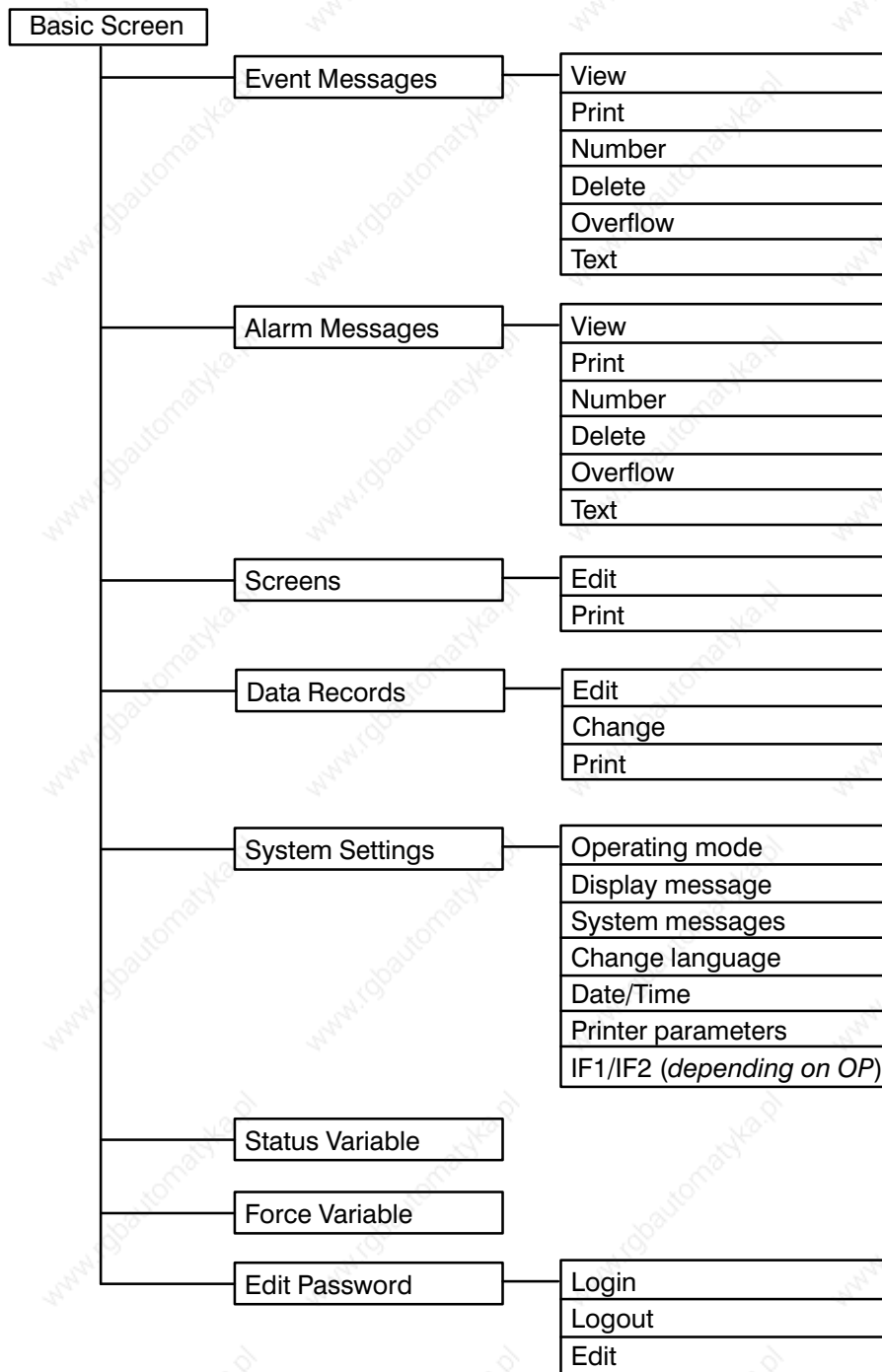

Figure 3-2 The Standard Screens

3.3 Branching in Standard Screens

Branching to screen level

With the ENTER-key, you change from message level to screen level. At this point you can control and monitor the process by means of suitable screens and standard screens and perform system settings.

With reference to the standard screens, a description is provided below of the procedure for branching between individual screens within the screen hierarchy.

Branching using soft keys

Call in your configured screen hierarchy the *Standard basic screen*. Its full name is displayed on the first line only with 4-line and 8-line displays. With 2-line displays, the screen name is not displayed. Depending on the OP version and display size concerned, the next lines include a different number of text elements of the current entry. These text elements show the name of other standard screens to which you can branch by using the assigned soft keys.

Using the soft keys beneath the symbols << and >>, you can move the displayed screen segment of the current screen. You branch to the next screen by pressing the soft key beneath the appropriate text indicating the name of the screen to be called.

Figure 3-3 shows the branch principle with reference to the 8-line display of the OP15/C. Figure 3-4 shows the branch principle of the 4-line display of the OP5.

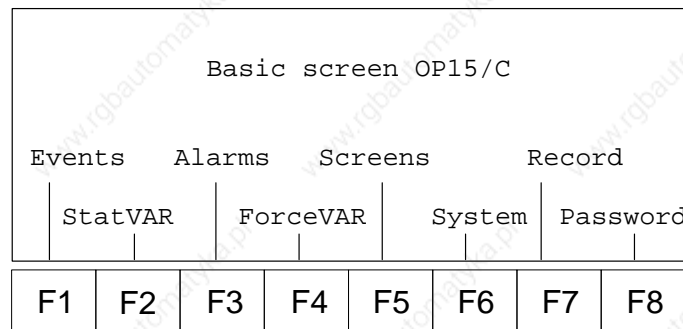

Figure 3-3 Branching at Screen Level (for an OP15/C having a 8x40 display)

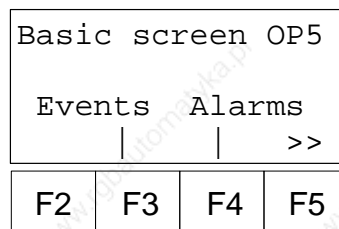

Figure 3-4 Branching at Screen Level (for OP5)

Choosing screens

You choose a screen by pressing the soft key assigned to it during configuration.

Use the horizontal scroll function << and >> if the required screen segment is not within the visible display area.

Calling functions

Functions are called by means of the soft keys assigned to them during configuration.

As protection against unauthorized use, a password having a specific password level has to be entered first for some functions (refer to Chapter 6).

General Operation

Keyboard layout

The Operator Panels are operated by means of the keyboard. There are three different keypads on the keyboard:

- System keyboard
- Function keyboard
- Soft-key keyboard

With the OP5, the soft-key keyboard is part of the function keyboard.

4.1 System Keyboard

Key assignment

The functions of the system keyboard are described below.

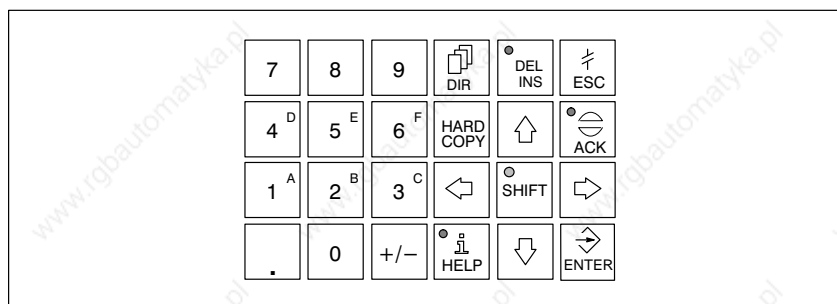

Figure 4-1 System Keyboard



SHIFT key.

By means of its Shift Lock mode, position it enables the second function of dual-assignment keys – for example, shift of numeric keys 1 – 6 for inserting characters A – F.

The enabled Shift Lock mode is indicated by the Shift LED being on after you press the SHIFT key. The second function of a dual-assignment key can then be called. On the OP15, the LED is located directly on the key, and on the OP5 it is beneath the function key strip adjacent to the SHIFT symbol.

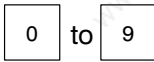

Numeric keys.

Input keys for numerical characters (0 – 9);
In Shift Lock mode of keys 1 – 6:
input keys for alphanumeric characters (A – F)



Sign key.

Changes sign from "plus" to "minus" and from "minus" to "plus".



Directory key

Displays screen directory.
In Shift Lock mode: sets display contrast.



Acknowledge key.

Acknowledges alarm messages.
The LED of the key is on when at least one unacknowledged alarm message is present. On the OP15, the LED is located directly on the key and on the OP5 it is beneath the function strip adjacent to the ACK symbol.



INSERT key.

In Shift Lock mode: DELETE key.

Pressing the insert key inserts a blank, when alphanumeric values are being entered, at the current cursor position. All subsequent characters are moved one position to the right.

The delete key deletes the character, when alphanumeric values are being entered, at the current cursor position. All the characters thereafter are moved one position to the left.

The key is enabled only when the LED is on. With the OP15, the LED is located on the key; with the OP5, it is located beneath the function key strip, next to the DEL/INS symbol.



ENTER key.

With this key you enter and terminate your input.
This means that, among other things, you also change from message level to screen level.



ESCAPE key.

(Escape, branch backward, change operating levels; refer to section 4.1.1).

**HARDCOPY key.**

Outputs the current display to the printer.

**HELP key (displays information text).**

When the assigned LED is on (on the OP15, on the key; on the OP5, beneath the function key strip, next to the HELP symbol), information text relating to the current display can be viewed on the screen (refer to section 4.1.2).

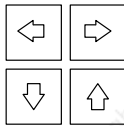
**Arrow keys.**

Move the cursor. Depending on the operating situation, the cursor is moved one character, field, entry or display to the left, right, up or down.

In Shift-Lock mode: scrolling in symbolic lists and calling of the extended font (refer to sections 4.2.2 and 4.2.3).

The numeric and arrow keys have a repetitive function, i.e. if you keep a key pressed, your input is repeated after a short delay until you release the key.

Note

Simultaneous pressing of more than one key may result, among other things, in erroneous input.

4.1.1 ESCAPE Functions

Cancel

Pressing ESCAPE cancels field inputs provided that they have not been terminated by pressing ENTER.

In addition, it is used to reply in the negative to a delete request in response to a corresponding prompt by the system.

Branch backward

If the ESCAPE key is pressed within a screen, you branch back to the configured cross-jump destination (by default, the last position called) and, finally, from the start screen to the message level.

To avoid branching back further than the message level, press the ESCAPE key.

Hide system message

At message level, the ESCAPE key is used to hide a system message.

Cancel display of information text

To cancel the display of information text, press ESCAPE to return to the previous display.

Reset while scrolling through messages

To cancel scrolling through messages at the message level, press ESCAPE to reset the display to the current message.

4.1.2 Information Text

Purpose

Information text contains information about the current display contents. It is created during configuration with ProTool/Lite and provides additional information in the language set on the OP. Information text can be configured for

- event messages and alarm messages,
- screens,
- screen entries,
- input fields and dual I/O fields,
- recipes, recipe entries,
- schedulers.

Information text can be used to convey, for example, information to the user on the current assignment of the soft keys. Information text relating to an alarm message may contain additional hints, for example, on the possible cause of the alarm and how to remedy it.

Displaying information text

The availability of information text is indicated by the **HELP** LED being lit. Configured information text can be output by pressing the **HELP** key on the OP.

If the cursor is positioned in an input field or in an I/O field for which information text is available (lit LED), the information text is output by pressing the **HELP** key. Pressing the **HELP** key a second time displays information text associated with the screen entry, if configured.

If the **HELP** key is pressed in a field for which information text is not available, information text associated with the screen entry, if configured, is displayed directly.

Information text about screens

Configured information text associated with a screen is obtained either by pressing the **HELP** key in the directory when the cursor is positioned on the corresponding screen or within a screen when the cursor is positioned on the screen title.

Scrolling through information text

The **UP** and **DOWN** keys \uparrow and \downarrow are used to scroll through information text, if appropriate. The **ESCAPE** key terminates display of information text, and the previous display is shown again.

4.2 Entering Values

General procedure

In input fields, values can be entered on the OP and transferred to the PLC .

1. Branch, as described in section 3.3, initially to the screen you require and then to the corresponding screen entry.
2. Using the arrow keys, select the input field you require within the screen entry.
3. Then enter your value. Depending on how the field has been configured, values may be input as
 - inputs of numerical values (refer to section 4.2.1),
 - inputs of alphanumeric values (refer to section 4.2.2),
 - inputs of symbolic values (refer to section 4.2.3).
4. Confirm your input with ENTER.
You can cancel any incorrect input by pressing ESCAPE. The original value is then automatically reinserted in the field. Insert the correct value and then enter the corrected value by pressing ENTER.
5. Position the cursor in the next input field using the RIGHT or LEFT arrow key, insert the next value etc.
You can also use the arrow keys to move the cursor to the left or right to the previous input field to insert a different value in it.
6. Close the screen by pressing ESCAPE.

4.2.1 Entering Numerical Values

Input using numerical keypad

In fields that allow the operator to enter a numerical value, you enter the numerical value character by character using the keypad on the system keyboard.

Changing the value

If there is a value in the field already, it is cleared completely from the field when the first character is entered. Once input has been started, you cannot exit from the field until the input has been entered or canceled.

Right-justified input

In numerical fields, input initially is normally right-justified. Digits that have already been entered are moved to the left (pocket-calculator format).

Exception:

Input fields for variables in KM format – for instance, when calling the PU functions STATUS/FORCE VAR – are changed to left-justified. When input begins, the old value does not disappear from the display completely but its bit pattern is overwritten one character at a time. You move the cursor in this type of field by pressing an arrow key (← and →) with activated Shift Lock mode.

Limit-value check

You can configure **limit values** for numerical input fields. In this type of field, a limit-value check takes place, i.e. the entered values are applied only if they lie within the configured limits. If a value outside these limits is entered, a system message is displayed and, after it has been canceled, the old value is restored in the field.

Decimal places

If a numerical field has been configured with a certain number of **decimal places** and too many have been entered, they are ignored; if too few have been entered, the field is padded with zeroes.

4.2.2 Entering Alphanumeric Values

Mixed input of digits and letters

With the input of alphanumeric values, digits and letters are mixed.

For the numerical components of the input, proceed as described in section 4.2.1. If, however, you wish to enter a letter at the current cursor position, you must enable the corresponding alphanumeric font. In this instance, you move the cursor with the cursor keys (← and →) with activated Shift Lock mode.

Entering A – F characters

A – F characters can be entered directly with activated Shift Lock mode using numeric keys 1 – 6. If you want to enter digits again after the letters, Shift Lock mode must be de-activated. To enter the alphanumeric string 7FEB53, for example, proceed as follows:

1. Enter 7 normally using the keypad on the system keyboard.
2. Press SHIFT.
Shift Lock mode is indicated by the LED being on.
3. Using the keypad, enter in succession the letters F (on key 6), E (on key 5), B (on key 2).
4. Press SHIFT.
Shift Lock is de-activated, the LED goes out.
5. Enter the remaining digits 5 and 3 with de-activated Shift Lock mode using keys 5 and 3 and confirm it by pressing ENTER.

Extended character set

If the characters available on the keypad are not sufficient for the alphanumeric input, you can select additional letters and special characters from the extended character set. The extended character set is available for all KC type fields.

To enter the string 18OKT61, for example, proceed as follows:

1. Enter 1 and 8 normally using the keypad on the system keyboard.
2. Press SHIFT.
Shift Lock mode is indicated by the LED being on.
The extended character set is available.
3. Scroll with the UP or DOWN arrow key through the valid extended character set.
4. Select O and, using the arrow key, move right one position.
5. Select K and, using the arrow key, move right one position.
6. Select T and, using the arrow key, move right one position.

7. Press SHIFT.
Shift Lock mode is de-activated, the LED goes out.
8. Enter the remaining digits 6 and 1 as before using keys 6 and 1 with de-activated Shift Lock mode and terminate with ENTER.

4.2.3 Entering Symbolic Values

Input using symbolic values

If a field has to be filled by entering symbolic values, take the value from a list of options.

1. Press SHIFT in the input field.
Shift Lock mode is indicated by the LED being on.
The list of options with its configured symbolic inputs is activated.
2. Select the value you require using the arrow keys.
3. Enter the value you selected by pressing ENTER.
Shift Lock mode is de-activated automatically when you press ENTER.

www.rgbautomatyka.pl

Screens

Displaying and influencing the process on screens

On the OP, the process – for example, a processing machine or a mixing unit – is displayed on screens and manipulated. The screens are configured by the configurator for specific users.

On screens, associated process values are acquired and provide an overview of a process or system. In addition to this alphanumeric "imaging" of the process, screens provide a means of entering process values and, consequently, of controlling the process.

Process values on a screen can be randomly assigned to subject-related groups. An example of this is shown in figure 5-1.

```
Furnace 1 temperature: 80 °C
Furnace 2 temperature: 78 °C
Furnace 1 contents: 1200 l
Furnace 2 contents: 3000 l
Valve 1 pressure: normal
Valve 2 pressure: slightly high
```

Figure 5-1 Example of Process Values Grouped by Subject on a Screen

Screen components

Every screen contains

- a title (optional),
- screen entries,
- a return destination reached by pressing the ESCAPE key. Possible return destinations are
 - the message level
 - another screen
 - a directory
 - the point at which the current screen was chosen.

Screen directory

Screens can be grouped during configuration in a screen directory, which is used to display them on screen or print and edit them. A screen can be retrieved from its screen directory by its screen number and its screen title, if configured.

5.1 Screen Entries

Displaying a screen entry

Screens consist of entries. Irrespective of the configured number of lines, precisely one entry is displayed per display page on the OP. Lines which may have not been fully configured are displayed as blank lines.

An example of a screen entry is the two lines in the afore mentioned example (figure 5-1)

```
Furnace 1 temperature: 80 5C
Furnace 2 temperature: 78 5C.
```

Components of a screen entry

A screen entry consists of the following components:

- entry text
The static text contains explanations for the operator. It may also include information on how the soft keys have been assigned.
- fields for the
 - output of date, time, PLC actual values,
 - input of PLC variables which are immediately transferred to the PLC after being entered,
 - combined I/O of PLC variables.
- soft keys
Different function calls for the different screens are assigned to the soft keys.

Updating values in screen entries

The configuration defines the intervals at which PLC values are updated, i.e. read again from the PLC and displayed.

With large screens containing more than 159 actual values or setpoint-actual values, "partial screen updating" is automatically enabled. To enhance performance, only those values are updated which are currently present on the display. This may mean that an older value is briefly displayed when scrolling through screen entries. Updating of the visible actual values is faster as a result, however.

I/O fields

Output fields display actual values of the PLC in numerical or symbolic form; input fields define variables in numerical or symbolic form. In input fields, the flashing cursor is visible.

For I/O fields, you can configure up to 256 text elements which you can call on the OP using a selection field and apply to the screen entry.

With inputs of numerical values, configured number formats and limit values apply with respect to the number of places before and after the decimal point.

5.2 Choosing Screens

Choosing screens Screens can be viewed on the OP and serviced (edited) and printed. Before this is possible, they have to be chosen.

A screen can readily be chosen by means of

- soft key,
- function key,
- directory,
- PLC job.

Choosing with soft key With soft keys, you can branch from one screen to another. The branch is defined in the configuration.

Choosing with function key The configured assignment of the function keys, unlike the soft keys, is valid globally. In this way the screen that was permanently defined during configuration can be selected in any operating situation.

Choosing with screen directory Depending on the action you want to take, call on of the two standard screens *Screens → Edit* or *Screens → Print*. Thereupon the screen directory is shown on the display. It contains only pictures which were included in the directory during configuration. You scroll through the screen directory using the arrow keys. A screen is chosen by pressing the ENTER key.

As an alternative to the standard screen *Screens → Edit*, you can call the screen directory using the DIR key on the system keyboard. A screen chosen with ENTER can be edited but not printed.

Choosing with PLC job To implement operator guidance, a screen can be chosen from the PLC by means of a PLC job. In this instance, the cursor is already positioned in a specified entry or in an input field, in which the operator can perform his input.

5.3 Editing Screens

Procedure

Screens can be manipulated, i.e. edited, by means of entries in input fields and combined I/O fields. To edit a screen, proceed as follows:

1. Choose the screen you wish to edit as described in section 5.2.
2. The cursor jumps to the first input field.
3. Use the RIGHT → or LEFT ← arrow keys to move the cursor to the field concerned.
4. Perform the modifications you wish to make as described in section 4.2.
5. After confirming your input, position the cursor again, if necessary, to perform further modifications.
6. Terminate editing – for example, by pressing ESCAPE.

5.4 Printing Screens

Procedure

To output a screen to a connected printer, proceed as follows:

1. Choose the screen you want to edit as described in section 5.2. The screen directory is displayed (but not when choosing by means of a function key or a PLC job; in these instances, the corresponding screen is printed immediately).
2. Scroll with the cursor keys DOWN ↓ or UP ↑ to the screen number you require or, if configured, to the screen title.
3. Press ENTER to print.
4. Terminate the action – for example, by pressing ESCAPE.

Password Protection

Preventing unauthorized operation

To prevent unauthorized operation of the OP, there is the possibility of protecting access by means of passwords and password levels. This is possible for the call of functions and inputs.

6.1 Password Levels and Access

Password hierarchy

When you are configuring, you assign ascending password levels from 0 to 9 for functions called on the OP by function keys, soft keys and input fields. The password levels assigned to standard screens are listed in Appendix A.

Issue of a password to an operator means that permission is granted simultaneously to execute functions at a specific password level.

Password level 0

At this level, the lowest in the hierarchy, functions are assigned which, when executed, have no or little effect on the course of the process; these are normally calls of functions not having input options – for example, viewing message buffers.

A password is not required to call functions of password level 0.

If an operator calls a function of a level other than 0, he is prompted on the display to enter a suitable password.

Password levels 1 to 8

Levels 0 to 8 are assigned to functions of ascending importance.

A password level is assigned to a password by the superuser as part of his password management responsibilities.

Password level 9

Permission to execute functions of password level 9 is the sole responsibility of the superuser, who has access to all OP functions. Only the superuser is allowed to perform password management.

The password for level 9 functions is created at the time of configuration. Synonymous with password level 9 is use of the authorization input.

If an operator logs in with the password of a specific password level on the display, he is authorized to execute functions of this and lower levels.

6.2 Login/Logout on OP (LOGIN/LOGOUT)

Logging in

You can log in on the OP in different ways:

- by means of the standard screen *Password* → *Login*,
- if a function call is made on the OP for which the current password level is too low, you are automatically prompted on the display to enter the corresponding password,
- by means of the authorization input (in special cases – for example, during the commissioning phase) corresponding to password level 9.

Logging in by standard screen

1. From the standard screen, choose *Password* → *Login*.
The password input screen is shown on the display. This screen is similarly displayed when a function call is made for which the current password level is too low. The cursor is located in the first field of the input area.

2. Enter the password on the system keyboard and terminate by pressing ENTER .

The cursor jumps automatically to the next field every time a character is entered. The input of every character is represented by an asterisk (*) in the input area. The cursor is no longer visible after the last character has been typed.

If the password is valid, the corresponding password level is shown on the display.

3. Exit from the standard screen – for example, by pressing the ESCAPE key.

Automatic call

If a function requires a higher password level than the current one, you are automatically requested to enter a suitable password when the function is called. After entering the password, you return to the calling function by pressing ESCAPE.

Authorization input

During commissioning, it may be useful to avoid repeated logins on the OP as the superuser. This is possible if the authorization input is connected on the terminal strip of the OP to the authorization output by means of a lock switch or a bridge or if a dc voltage (+ 15 to 30 V) is applied to the authorization input. The OP then automatically assumes password level 9, i.e. without requesting a password.

Logout

Choose the standard screen *Password* → *Logout*.

Upon selection of the standard screen, the OP switches from the current password level to the lowest password level, level 0, and branches to the message level.

6.3 Password Management

Password management authorization

Only the superuser (password level 9) is authorized to call the functions for password management.

Displaying the password list

Choose the standard screen *Password* → *Edit*.

The password list is shown on the display. The password list may contain a maximum of 50 passwords. The two-digit number at the beginning of a password entry indicates the password index. On the right of the password index is the field for the password. The password must be at least 3 but not more than 8 characters long; it may contain digits and the letters A – F.

On the right of the password you will see the assigned password level. During the initial call, only the superuser entry is included.

If a password has not been entered for a specific password index, dashed fields are shown for the password and the password level.

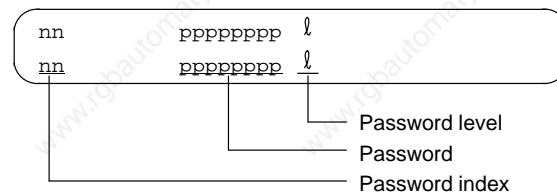

Figure 6-1 Password List (Example: 2 x 40 Representation)

You can scroll through the password list using the UP and DOWN arrow keys.

Allocating passwords and password levels

1. Select the line for the password entry on the password list.
The cursor is located on the first character of the field for password input.
2. Enter a unique password and confirm it. Leading zeroes are not allowed in passwords.
3. Move the cursor with the RIGHT arrow key to the field for the password level.
4. Insert and enter a password level of 1 to 8 for the password.
5. Exit from the standard screen by pressing the ESCAPE key.

Changing passwords and password levels

To change a password, call the password entry in the same way as you do for allocating a password and enter the new password by overwriting the old one.

If you just want to change the password level and not the password, skip the field containing the password entry by pressing ENTER. Then move the cursor with the RIGHT arrow key to the field for the password level and enter the new level.

Deleting passwords

To delete a password, call the password entry in the same way as you do for allocating and changing a password but overwrite the first character of the password with a zero.

Message Handling

7

Message types

Incidents and states in the control process are shown in message form on the OP display. A message consists of static text as a minimum. If required, variables are integrated into a message.

The following types of message are displayed on the OP:

- event messages,
- alarm messages and
- system messages.

Event and alarm messages

Event messages and alarm messages are initiated by the PLC. They are configured and contain process-related information. You have to acknowledge alarm messages.

System messages

System messages are initiated by the OP. They are not configured. They provide information on operating states of the OP or maloperations and break-downs in communication.

Issued event messages and alarm messages are stored in separate message buffers on the OP. Messages contained in the buffers can be displayed or output to a connected printer.

7.1 Event Messages and Alarm Messages

Definition

The process states indicated by event messages and those indicated by alarm messages are defined during configuration. Messages on malfunctions referring to processes or states – for example, `Motor temperature too high` or `Valve will not open` should be categorized as alarm messages. Messages that provide information on regular processes or states, such as `Temperature reached` or `Motor running` should be categorized as event messages.

Apart from status messages, information on operation can also be configured as event or alarm messages. If, for example, a machine operator wants to start the bottling process but has forgotten to open the water intake valve on the mixer, a message such as `Open water intake valve` can prompt him to rectify the error.

Presentation

Event and alarm messages can be configured so that any of their text components flash to distinguish them from message text. Unacknowledged alarm messages flash permanently.

Messages may contain static text and variable fields. The variable fields display, for example, current actual values of the PLC in numerical or symbolic form. In addition, the date and time can also be output in messages.

Message bit procedure

If there is a condition present in the current process for a message to be issued – for example, a variable has been reached – a bit is set by the PLC application program in the data area for event and alarm messages. The OP reads the data area after a configured polling time. In this way, a message is detected as having "arrived". The bit is reset by the PLC when the condition for issuing the message no longer exists. The message is then regarded as having "departed".

Alarm and event buffers

Alarm and event messages are written to alarm and event buffers, respectively, on the OP when they arrive. The following details are entered in the buffer in chronological order:

- times of incidents
- arrivals and departures of incidents
- acknowledgements of alarm messages
- message numbers
- values of variables at the time of arrival and departure.

The message buffer of the OP can store up to 256 events. Events are the:

- arrival of a message,
- acknowledgment of a message (alarm messages only),
- departure of a message.

Overflow warning

During configuration, you can define a remaining buffer space. When this remaining buffer space has been reached, an automatic overflow warning is issued – for example, `EM remaining buffer`. This overflow warning is a system message. Messages continue to be inserted into the buffer even after the remaining buffer space has been reached.

Standby message

A sub-category of the event message is the standby message. The standby message is the event message number 0. It appears on the display when the OP is operating at the message level and event or alarm messages are not waiting. The standby message is stored in the firmware and contains the version and the device type:

OP15/A	Vx.xx
2 x 40 char.	5 mm char. height

Figure 7-1 Example of Standard Standby Message on OP15/A

Depending on the configuration, the standby message can be represented by other text. It can contain the date and time but not variables.

7.1.1 Acknowledging Alarm Messages

Acknowledging alarm messages

Alarm messages have to be acknowledged on account of their priority. This can be done automatically by the PLC or by the operator pressing the Acknowledge key. The OP displays unacknowledged alarm messages in flashing mode. The LED (ACK) assigned to the Acknowledge key also flashes.

If several alarm messages are waiting to be displayed, after one has been acknowledged the next one is shown on the display, which similarly has to be acknowledged.

If no more alarm messages are waiting to be displayed, the OP reverts to the operating level from which it branched to the message level to display the alarm messages.

Acknowledgement groups

During configuration, you can combine several alarm messages to form an "acknowledgement group". In this way you can acknowledge all the other alarm messages (consequential faults) in that acknowledgment group by acknowledging the first alarm message – for example, the cause of the fault – without all of them having to be output to the display. You can configure up to four acknowledgment groups.

If alarm messages are not assigned to an acknowledgment group, only the one that happens to be on the display is acknowledged if more are waiting.

7.1.2 Inhibiting Alarm Messages

Inhibiting the display of alarm messages

There is the possibility of inhibiting the display of frequently occurring alarm messages for the time being until the OP starts up as a result of a cold or warm start. Password level 8, at least, is required to inhibit the display.

Operation

To inhibit an alarm message, press the Acknowledge key and ESCAPE simultaneously. This message will not be displayed until the next time the OP starts up.

Inhibited alarm messages are no longer inserted into the alarm buffer from the time of inhibition, either. They are stored in the alarm buffer only from the time they first occur until such time as the display is inhibited.

Note

The alarm message inhibit function should be used only during the commissioning phase of the OP.

7.2 System Messages

Definition

System messages indicate operating states within the OP. For example, they draw your attention to maloperations or a breakdown in communication. This message type has top display priority. If a relevant fault occurs on the OP, the active event message or alarm message is removed from the display and a system message is issued in its place.

Serious and non-serious system messages

System messages are classified as serious and non-serious system messages. A serious system message is based on an error that can be rectified only by a cold or warm restart of the OP.

All other errors generate a non-serious system message – for example, when printing has been initiated but a printer has not been connected to the OP. Display of a non-serious system message can be canceled by pressing ES-CAPE to the extent that it is not automatically hidden after a short while. Display of a non-serious system message can also be canceled automatically when a specific, configured display time has expired.

A list of possible system messages and their explanations will be found in the appendix.

Inhibiting system messages

Display of system messages (with the exception of internal errors 7xx) can be inhibited at the configuration stage. System messages whose display has been inhibited continue to be inserted into the system message buffer and thus can be viewed on the display later.

System message buffer

The system message buffer can store up to 100 messages. System messages are inserted into it with their message number and their arrival; their departure is not recorded. Some minor errors and operator errors are not logged in the system message buffer. Messages from the system message buffer are displayed in the same order as they arrived, i.e. first in first out, last in last out.

7.3 Displaying Messages

Display Event and alarm messages are always output to the display at message level and are displayed according to display and message priorities.

Display priorities System messages always have top priority in so far as display is concerned; unacknowledged alarm messages always have the second highest priority. Otherwise, messages are displayed in different sequences depending on whether separate or together output of event and alarm messages was configured.

Message priorities Message priorities of 1 (low) to 4 (high) can be set within event and alarm messages in the configuration according to their importance. If several messages of the same display priority exist simultaneously, they are displayed according to their message priorities, those with the highest message priority being shown first and those with the lowest last.

Displaying first/last message If several messages having identical display and message priorities exist simultaneously, the most recent is displayed in all cases, for both event and alarm messages.

Depending on the value preset during configuration, the oldest message or the most recent message is shown for alarm messages. You can use the standard screen to modify the setting for viewing the oldest (first) or most recent (last) alarm message when there are several of them waiting. To do this, choose *System* → *DispMsg* and set the corresponding parameter.

7.3.1 Display Sequences

Event and alarm messages can be configured as single- or double-line messages and displayed either separately or together.

Single message display (setting "separate")

With this display sequence, only one message is shown on the display.

Exception: On the OP15/C, four messages are displayed in the case of 8 x 40 representation.

If several messages are queuing, the messages are displayed in succession and output according to the following priorities:

1. System message, the most recent one, if there are several.
2. Unacknowledged alarm message.
3. Event message yet to depart.
4. Acknowledged alarm message yet to depart.
5. Standby message.

Combined message display (setting "together")

If there is no system message, the alarm and event messages having the highest priority are displayed simultaneously one on top of the other. For messages which extend beyond the limit of the display line, the full-length message text is repeated automatically across the display.

Exception: On the OP15/C, two event messages and two alarm messages are displayed with the **8 x 40 representation**.

If several messages are queuing in the case of combined output, the messages are output on **double-line displays** according to the following priorities:

1. System message, the most recent one, if there are several.
2. Unacknowledged alarm message; the second line displays simultaneously the most recent, highest-priority event message yet to depart.
3. Acknowledged alarm message yet to depart; the second line displays simultaneously the most recent highest-priority event message yet to depart.
4. Standby message.

7.3.2 Scrolling through Waiting Messages at Message Level

Scrolling through messages

If there are neither system messages nor unacknowledged alarm messages, you can scroll at message level through the messages that have not yet departed.

To scroll through the messages, use the following arrow keys at message level:

Next alarm message



Previous alarm message



Next event message



Previous event message



The message currently waiting will be displayed if you press ESCAPE or there is no operator input on the OP for one minute.

7.3.3 Viewing Event and Alarm Message Text

Displaying messages

Irrespective of the current contents of the event or alarm buffer, all configured event and alarm message text can be shown on the display. To do so, proceed as follows:

Choose the standard screen *Alarms* → *Text* (to display alarm messages) or *Events* → *Text* (to display event messages).

By using the UP and DOWN arrow keys, you can now scroll through the list of configured message text.

7.4 Viewing Message Buffers

Message buffer

Messages displayed on the OP are written to the message buffer concerned. The message buffers can be called to view message history by means of standard screens.

The times of occurrence, acknowledgment and departure are displayed in chronological order for all messages.

Viewing the alarm buffer

Choose the standard screen *Alarms* → *View*.

The messages contained in the alarm buffer are shown on the alarm message list together with their message number, the date and time of their occurrence and the message status (arrived, departed or acknowledged) and their acknowledgment group on the display:

Q-Gr/No.	04/112	K	on	08.12.92	09:34:00
Q-Gr/No.	04/112	Q	on	08.12.92	09:35:42

Figure 7-2 Example Display of Alarm Buffer (Shown here for OP15/A)

Explanation relating to example display (first message):

Using the UP and DOWN arrow keys, you can now scroll through the message text.

Q-Gr/No.	Details relating to next field: acknowledgment group and alarm message number.
04/112	The displayed alarm message belongs to acknowledgment group 04, the alarm message number is 112.
K	Message has arrived
Q	Message has been acknowledged
G	Message has departed
on <i>date time</i>	Date and time of arrival/acknowledgment/departure of alarm message.

Display of message text relating to selected alarm message:



Return to alarm message list:



Viewing total number of messages in event buffer

To obtain an overview of all the alarm messages and the total number of alarm messages still waiting in the buffer, choose the standard screen *Alarms* → *Number*.

Viewing the event buffer

Choose the standard screen *Events* → *View*.
 The event messages contained in the event buffer are now shown in the event message list together with details of the message number, the date and time of their occurrence and also the message status (arrived/departed) on the display:



```

Message No: 045   K
on 08.12.93 10:23:50
Message No: 031   K
on 08.12.92 10:23:56
    
```

Figure 7-3 Example Display of Event Buffer (Shown here for OP15/B/C)

Explanation relating to example display (first message):

Using the UP and DOWN arrow keys, you can scroll through the event buffer.

Message No.	Details relating to next field:
	Message number of event message.
045	The displayed event message is number 045.
K	Message has arrived
G	Message has departed
on <i>date time</i>	Date and time of arrival/departure of event message.
	Display message text relating to selected event message:
	
	Return to event message list:
	

Viewing the total number of messages in event buffer

To obtain an overview of all the event messages and the total number of event messages still waiting in the buffer, choose the standard screen *Events* → *Number*.

Viewing the system message buffer

Choose the standard screen *System* → *SysMsg*.

The messages contained in the system message buffer are now shown on the display together with details of the message number, and the date and time of their occurrence:

Message No:	200	on	08.12.92	10:23:50
Message No:	200	on	08.12.92	10:24:00

Figure 7-4 Example Display of System Message Buffer (Shown here for OP15/A)

Explanation relating to example display (first message):

Using the UP and DOWN arrow keys, you can now scroll through the list of system messages.

Message No. Details relating to next field:

Message number of the system message.

200

The displayed message number is number 200.

on *date time*

Date and time of occurrence of the system message.

Display message text of selected system message:



Return to system message list:



7.5 Deleting Messages

Preventing a buffer overflow

Event and alarm messages are stored automatically in the event and alarm buffers, respectively. Each of these buffers can contain as many as 256 events. To prevent a buffer overflowing, you should delete event and alarm messages from the buffer.

Messages from the event and alarm buffers are deleted

- by means of a standard screen or
- automatically upon buffer overflow.

System messages are deleted automatically only when the buffer overflows.

7.5.1 Deleting Event and Alarm Messages Using Standard Screens

Overview

Standard screens can be used to delete

- all (not individual) acknowledged and departed alarm messages
- all (not individual) arrived and departed event messages.

To delete event and alarm messages, proceed as follows:

Depending on the type of message you want to delete, choose one of two standard screens, either *Alarms* → *Delete* (for alarm messages) or *Events* → *Delete* (for event messages).

Delete buffer: Press ENTER.

Do not delete buffer: Press ESCAPE.

7.5.2 Automatically Deleting the Alarm Buffer upon Buffer Overflow

Remaining buffer size and buffer overflow

By default, an overflow warning is output to the display when the alarm buffer reaches the configured remaining buffer size. Output of the overflow warning can be enabled and disabled online by means of the standard screen *Alarms* → *Overflow*. If the alarm buffer cannot accept any more messages, those which have been acknowledged and have departed are the first to be deleted automatically until such time as the configured remaining buffer size is reached.

Deletion order If the remaining buffer size is still not freed by this action, more messages are deleted, in the following order, until it is depleted:

- Acknowledged alarm messages yet to depart
- Unacknowledged alarm messages that have already departed
- Unacknowledged alarm messages yet to depart.

Forced printout If a log layout has been configured and a printer ready for operation is attached to the OP, forced printout of all deleted messages is enabled .

7.5.3 Automatically Deleting the Event Buffer upon Buffer Overflow

Remaining buffer size and buffer overflow

By default, an overflow warning is output to the display when the event buffer reaches the configured remaining buffer size. Output of the overflow warning can be enabled and disabled online by means of the standard screen *Events* → *Overflow*. If the event buffer cannot accept any more messages, those which have already departed are the first to be deleted automatically until such time as the configured remaining buffer size is reached.

If the remaining buffer size is not freed by this action, as many of the oldest event messages are deleted – irrespective of priority and message status (arrived, departed) – as are necessary to restore the configured remaining buffer size.

If the remaining buffer size is still not available, as many of the oldest waiting messages are deleted as are necessary to restore the remaining buffer size.

Forced printout If a log layout has been configured and a printer ready for operation is attached to the OP, forced printout of all the deleted messages is enabled.

7.5.4 Automatically Deleting the System Message Buffer upon Buffer Overflow

Definition

If the system message buffer is completely full, the oldest message is deleted automatically from the buffer when another system message occurs. There is no overflow warning or forced printout of the deleted message, in the case of event and alarm messages.

7.6 Printing Messages

How to print out

You can print alarm and event messages as a

- direct message log and
- full printout of the message buffer
- forced printout upon buffer overflow (refer to section 7.5.2).

7.6.1 Direct Message Logging

Print time

Event and alarm messages can be printed upon arrival and departure (alarm messages upon acknowledgment, too) this was set when the message was configured. System messages are not logged directly.

If direct message logging follows another print function, the header of the direct message log is re-printed.

Temporary storage if the printer is disabled

If the printer is disabled, not ready or assigned to another print function, up to 16 messages are stored temporarily. Temporary storage of the messages for the message log is independent of the message buffer concerned.

Enabling and disabling direct message printing

Direct message printing can be enabled and disabled online by means of a standard screen:

1. Choose the standard screen *System* → *Printer*.
2. A parameter list is displayed.
3. Move the cursor on the parameter list to *Message Log*.
4. By entering a symbolic value, set *ON* or *OFF*.
5. Confirm by pressing the ENTER key.
6. Exit from the standard screen by pressing the ESCAPE key.

7.6.2 Printing the Message Buffer

How to print out

Messages from the alarm and event buffers, but not the system buffer, can be printed

- chronological, i.e. all messages contained in the buffer of the message type concerned are printed in the order in which they are contained in the buffer
- together, i.e. all messages contained in the buffer of the type of message concerned are printed in ascending message number order. If a message occurs more than once, it is slotted according to time-related subcriteria.

Choose the standard screen *Alarms* → *Print* to print alarm messages or *Events* → *Print* to print event messages.

The default setting is *Chronological*. The default setting can be modified during configuration. A choice of either *Chronological* or *Together* online on the OP is possible only when it has been configured.

www.rgbautomatyka.pl

Recipes

Overview

Recipes are combinations of variables for a certain purpose. The purpose of recipes is to transfer data together to the PLC.

During configuration, the recipe is used to specify the data structure. This structure is then assigned with data in the OP. Since multiple assignment of the data structure is possible, we will now speak of data records. Data records are stored on the OP which saves memory space on the PLC.

Example of a recipe

Let's assume that orange nectar, orange drink and orange juice are to be produced using the same bottling station in a fruit juice plant. The mixing ratios are different for each drink but the ingredients are the same. The information required for production can be configured as the recipe "Mixture".

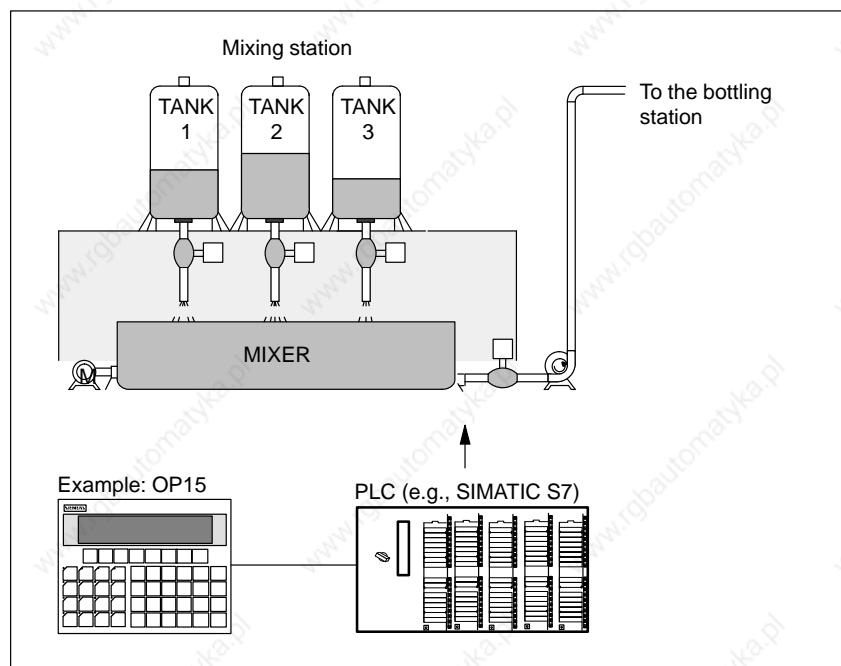

Figure 8-1 Example of a fruit juice plant

Components of a recipe

A recipe consists of a series of recipe entries. Each entry contains a maximum of one input field (i.e., variable). Depending on the configuration, either direct or symbolic value input can be used in an input field.

The recipe called *Mixture* could be set up from the following entries.

Name :	<input type="text"/>	
Orange :	<input type="text"/>	l
Water :	<input type="text"/>	l
Sugar :	<input type="text"/>	kg
Aroma :	<input type="text"/>	g

|
Input fields (variables)

In contrast to screens, several entries are displayed on the OP simultaneously for recipes.

Data records on the OP

On the OP, the variables allocated to the input fields are assigned with values and stored on the OP.

Together, these values form one data record of the recipe.

Several data records can be set up for one recipe. This permits a fruit juice plant to operate with different types of drinks, for example, by using a different data record for each type of drink.

Name : Orange : Water : Sugar : Aroma :	Drink 90 l 10 l 1.5 kg 200 g	Nectar 70 l 30 l 1.5 kg 400 g	Juice 95 l 5 l 0.5 l 100 g
 Entries of the recipe "Mixture"	 Data record 1	 Data record 2	 Data record 3

All data records are stored on the OP. Only the data record which is active at the moment is stored on the PLC. This saves memory space in the PLC.

Identification of recipes and data records

A recipe is identified by a recipe number and a recipe title specified during configuration.

A data record is identified by a data record number and a data record name assigned in the OP.

The clear and unmistakable identification factor for a data record is the data record number and not the data record name.

This means that, although several data records with the same name may exist, several data records with the same number cannot exist. If no name is assigned to a data record, it is assigned the name "data record".

Standard screens for data records

Standard screens with the following functions are available for data records.

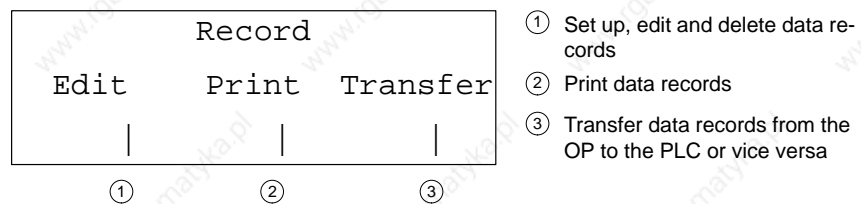

Figure 8-2 Standard screens for data records

Directory for recipes

Recipes are combined into a recipe directory which can be used to indicate them on the display, and to print and edit them. A recipe is located in the recipe directory under its recipe number and its recipe title.

Transferring data records

The OP offers a transfer screen for transferring data records from the OP to the PLC and back. Transfer a data record to the PLC when required by the PLC.

The data record in the PLC can be overwritten by another data record stored on the OP.

The active data record can also be transferred from the PLC to the OP and stored on the OP.

Note

Only one recipe data record at a time can be active on the PLC.

Transmission of data records between OP and PLC is synchronized to prevent uncontrolled overwriting.

Direct/indirect transfer

Transmission of data records between OP and PLC can be performed "directly" or "indirectly".

Direct transmission:

The variables of the data record are written directly to the defined addresses of the PLC.

Indirect transmission:

The variables of the data record are stored in an intermediate storage location on the PLC (e.g., recipe mailbox on the SIMATIC S5).

See *User manual Communication* for detailed information on the internal procedures.

8.1 Setting Up and Editing Data Records

The OP automatically sets up a data record with the number 1 and the name "data record" for each recipe. All values of the data records are preset with 0.

You can edit this data record. To set up more data records, either copy this data record (see chapter 8.2), or edit the first data record and save it under a different name.

Editing data records

Proceed as follows to change existing recipe, data record values.

1. Select standard screen *Records* → *Edit*
2. Select the desired recipe in the recipe directory.
3. Select the data record to be edited in the data record directory.

Note

You can have the recipe title displayed by paging up in the first entry.

4. Position cursor on the value to be changed.
5. Enter numeric or symbolic value.
6. Confirm the value. If you want to change more values, position the cursor in the input field of the next entry and change the value there.
7. To conclude editing data records after the last modified value has been accepted, press *ESCAPE*. You will then be asked whether you want to save the data record.
8. Save: Position cursor on the Yes field and confirm with *ENTER*.

Do not save: Press *ESCAPE*.

Since the data record number already exists, you will then be asked whether you want to overwrite the data record.

9. Overwrite: Press *ENTER*.

Do not overwrite: Press *ESCAPE*.

10. Exit standard screen with *ESCAPE*.

As long as you have not confirmed an input value, you can terminate editing with *ESCAPE*. The old value is then displayed again.

Storing a changed data record as a new data record

To save a changed data record as a new data record, do not overwrite the called data record when exiting the input screen. Instead, enter a new data record number and, if necessary, a new data record name before saving the data record.

1. Position cursor in the field for the data record number, enter the number, and confirm.
2. Position cursor in the field for the data record name, enter the name, and confirm. The data record name may not exceed 12 characters.

The next time you call the data record directory, you will find the new data record listed under the new data record number.

8.2 Copying Data Records

Overview

There are two ways to copy a data record.

- You can call an existing data record for editing, and save it unchanged under a new number and, if necessary, under a new name. Then make your changes.
- Save an existing record via data record transfer under a new number and, if necessary, under a new name. Then make your changes in the copy.

Copying a data record

Proceed as follows to obtain a copy of a data record whose values you want to change later.

1. Call the data record to be copied via the standard screen *Records* → *Edit*.
2. Instead of changing a value in the data record, exit the displayed data record again immediately by pressing ENTER.

When the standard screen is exited, you will be asked whether you want to save the data record regardless of whether values have been changed or not.

3. Position cursor in the field for the data record number, enter the number, and confirm.
4. Position cursor in the field for the data record name, enter the name, and confirm.

The next time you call the data record directory, you will find the new data record in the list.

8.3 Transferring Data Records

Overview

A transfer screen offering the following functions is available for transferring data records.

- OP → PLC

Before a changed or newly set up data record in a recipe can become effective in the PLC, it must first be transferred via data record transfer to the PLC.

- PLC → OP

Transfer the data record which is active in the PLC to the OP under a new number and a new name.

- OP → OP

Copy an already existing data record on the OP.

Transfer screen

The transfer screen is called via *Records* → *Transfer*. It is shown below.

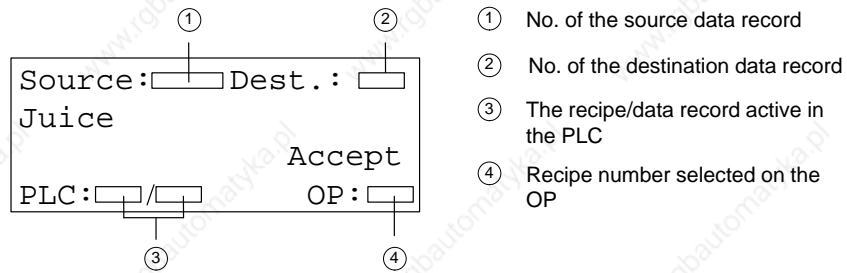

Figure 8-3 Transfer screen

Specifying source and destination

The data record numbers for the source data record and the destination data record must be entered in the transfer screen.

- The PLC data record is always "0" for both directions of transfer.
- The OP data record must always be specified as a number > 0.

Example of entering source and destination:

OP → PLC Transfer		
Source	Destination	Description
11	0	Source data record 11 is an existing data record on the OP and is to become the active data record on the PLC (destination).

PLC → OP Transfer		
Source	Destination	Description
0	22	The source data record is the active data record on the PLC which is to appear on the OP (destination) after the transfer under data record number 22 . If data record number 22 already exists, it can be overwritten or not if requested.

OP → OP Transfer (i.e., copying)		
Source	Destination	Description
33	44	Source data record 33 is an already existing data record on the OP which is to be copied as data record 44 . If data record number 44 already exists on the OP, it can be overwritten or not if requested.

Note

Symbolic value entries in the input fields source and destination:

The data record numbers from data records already stored on the OP can be taken from a data record selection list.

"PLC" stands for data record 0 in the selection list.

Using the transfer screen

Proceed as follows to transfer a data record.

1. Select the standard screen *Records* → *Transfer*.
2. Select the recipe in the recipe directory.
3. Position the cursor on the *Source* field in the transfer screen.

Depending on the direction of transfer desired, enter the appropriate source number (see examples), and confirm.

4. Position the cursor on the *Destination* field.

Depending on the direction of transfer desired, enter the appropriate destination number (see examples), and confirm.

5. Position the cursor on the *Accept* field, and confirm transfer.

During the data transfer, an asterisk ("*") is indicated in the acceptance field.

6. Exit the standard screen with `ESCAPE`.

8.4 Deleting Data Records

Data records of a recipe can be deleted from the data record directory. These data records are then no longer available for the recipe.

When a data record which is active in the PLC is deleted from the directory of the OP, this data record still continues to be active in the PLC.

How to proceed

Proceed as follows to delete data records.

1. Select *Records* → *Edit* in the standard screen.
2. Select the desired recipe from the recipe directory.
3. Using the cursor keys, select the data record to be deleted from the data record directory.
4. Press SHIFT + DELETE.
5. Delete: Press ENTER.
Do not delete: Press ESCAPE.
6. Repeat steps 3 and 4 as necessary.
If only one single data record exists, this record cannot be deleted.
7. Exit the standard screen with ESCAPE.

www.rgbautomatyka.pl

STATUS VAR and FORCE VAR Functions with the OPs (S7/S5 Only)

9

Accessing operand values of the PLC

With their PU functions STATUS VAR and FORCE VAR, the OPs provide means of displaying and modifying operand values supplied by a connected SIMATIC S5/S7 by means of standard screens. In online mode, this means that PLC operands can be edited directly on the OP without having to connect a programming unit to the PLC.

STATUS VAR can be used only to display operands.

FORCE VAR is used to display the operands and modify their variable values, and to transfer them back to the PLC. The specified operands remain in the static RAM and are still valid after a warm start of the OP.

Note for SIMATIC S7

Before calling the STATUS VAR and FORCE VAR functions, you must set the MPI address or PPI address of the connected SIMATIC S7. If only one PLC is connected, its address is address 2.

FORCE VAR

You call FORCE VAR by means of the standard screen *ForceVAR*. Following the call, the operand list is displayed. Depending on the line length of the display, an operand is displayed on either one or two lines.

Figure 9-1 shows the display for the SIMATIC S5 on the OP15/A (2x40). Figure 9-2 shows the display for the SIMATIC S7 on the same device.

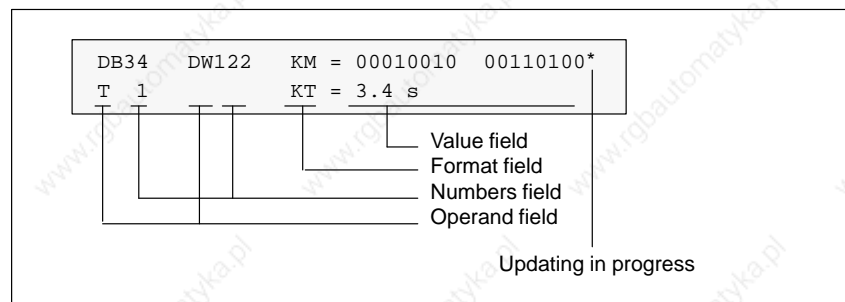

Figure 9-1 Display of PLC Operands for the SIMATIC S5 (Example: OP15/A, 2x40)

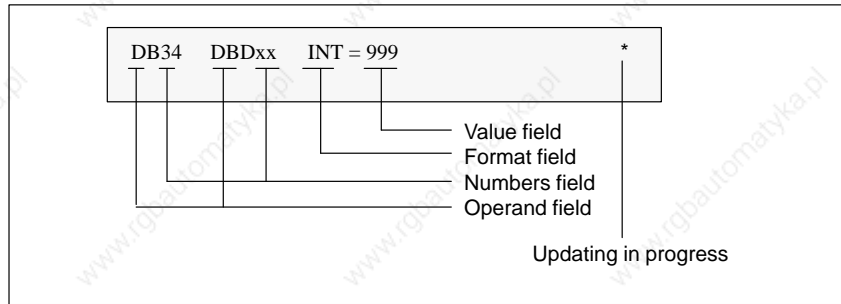

Figure 9-2 Display of PLC Operands for the SIMATIC S7 (Example: OP15/A, 2x40)

Displaying PLC operands

The PLC operands can be scrolled up or down. With activated SHIFT key, select the data type (e.g., DB, FW, IW, OW, Z, T) you wish to have displayed. Pressing ENTER automatically sets the corresponding data format in the format field. Shift Lock mode is de-activated at the same time.

Going to numbers fields

Use the → cursor key to go to the numbers field. Enter in the numbers field the number of the operand you want to display or modify by means of the keypad and confirm it by pressing ENTER. Use the activated SHIFT key to modify the default data format (e.g., KH, KF, KM, KS, KY, KT, KC). Refer to tables 9-1 and 9-2 for the valid S5 operands, data formats and ranges of values.

Entering values

Within the lines and value fields, the cursor can be moved horizontally. A total of ten lines can be assigned. Confirm inputs by pressing the ENTER key. The values of the operands you select are displayed in the value field in the specified format.

Inserting and changing lines

If the cursor is located in the first field and if input has not been started and updating is not in progress, you can insert a new variable line in front of the current line using the Insert key and you can delete the current line with the Delete key. If the cursor is located in a value field (not KM) containing at least one character, use the Delete key to delete the character at the cursor location.

Updating values

When you have finished editing the operand list, the values on the PLC have to be updated. Unlike screens, this is done immediately after an individual value has been entered. Not until you press the Enter key again after entering the final value is updating of all the new values explicitly initiated. During updating, a flashing asterisk, *, is visible in the top right corner of the display. If the asterisk does not flash, this means that the OP did not succeed in establishing a logical link to the PLC.

Inputs cannot be made while updating is in progress. Updating can be canceled by pressing ESCAPE.

Table 9-1 Operands, Data Formats and Ranges of Values for the SIMATIC S5

S5 Operand	Data Format	Range of Values	Example	
DB, DW FW OW IW	data blocks	KH: hexadecimal	0 to FFFF	1ABC
	flags	KF: fixed-point	-32768 to +32767	+46
	outputs	KM: bit pattern	0000000000000000 to 1111111111111111	0000000000001001
	inputs		Digits are overwrit ten character by character and are left justified	
		KC: ASCII		XY
		KY: double-byte	0.0 to 255.255	75.1
		KT: time-value	0.0 to 9990 (sec)	012.1 (coded time base)
	KZ: count-value	0 to 999 (decimal)	278	
C	counters	KH: hexadecimal	0 to FFFF	1ABC
		KM: bit pattern	0000000000000000 to 1111111111111111	0000000000001001
			Digits are overwrit ten character by character and are left justified	
	KZ: count-value (output only)	0 to 999 (decimal)	278	
T	times	KH: hexadecimal	0 to FFFF	1ABC
		KM: bit pattern	0000000000000000 to 1111111111111111	0000000000001001
			Digits are overwrit ten character by character and are left justified	
KT: time-value (output only)	0.0 to 9990 (sec)	012.1 (coded time base)		

Table 9-2 Operands, data formats and value ranges for the SIMATIC S7

S7 Operand		Data Format	Value Range	Example
DB ²	Address	HEX	0 to FFFF	2A3C
	Byte	DEC	-32768 to +32767	-117
VW ¹		BIN	16 bits	0110 1100 0100 1111
MW	Marker	CHR	2 characters	XY
O	Outputs			
I	Inputs			
PE ²				
PA ²				
Z	Counter	HEX	0 to FFFF	2A3C
		DEC	0 to 0999 (dec.)	777
		BIN	16 bits	0110 1100 0100 1111
T ¹	Timer	HEX	0 to FFFF	2A3C
		DEC	0.0 to 9990 (sec)	014.1
T ²	Timer	HEX	0 to FFFF	2A3C
		DEC	0.0 to 9990 (sec)	014.1
		BIN	16 bits	0110 1100 0100 1111

- 1 Only for PPI
- 2 Only for MPI

System Settings on Standard Screens

10

In this chapter

This chapter describes supplementary functions relating to system settings which can be executed by means of standard screens.

10.1 Selecting a Language

Online selection of three languages

Messages, screens and information text can be displayed in several languages. Up to three of the languages listed below can be loaded simultaneously on the same OP and presented to the operator for selection on line:

- German
- English
- French
- Italian
- Spanish.

Displays can also be configured in Russian, i.e. in Cyrillic characters, on the OP15/C.

Procedure

To choose another language, proceed as follows:

1. Choose the standard screen *System* → *Language*.
2. Select the language you require by means of a symbolic input. The selection list contains only the languages which have been loaded on the OP.
3. The OP performs a cold restart and loads all elements of language-dependent text in the new language.

10.2 Modifying Parameters in Online Mode

Modifying interface parameters

The parameters set as default parameters for the OP interfaces during configuration can be modified by means of standard screens. To do this, proceed as follows:

1. Depending on the OP you are using, choose one of the standard screens marked *System* → *IF*.
2. Scroll through the parameter list on the display using the UP and DOWN arrow keys to the parameter you require. Some of the parameters displayed cannot be modified.
3. Choose the value for the parameter by using a symbolic value.
4. Exit from the standard screen – for example, by pressing the ESCAPE key.

Modifying printer parameters and setting message logging ON/OFF

The default settings configured for printouts on the connected printer can be modified by means of a standard screen. In this instance, you can set the following:

- characters per line (parameter values: 20, 40 or 80)
- lines per page (parameter values: 60 to 72)
- message log (ON, OFF).

With message printing enabled (ON), every alarm message and event message can be printed in online mode as they arrive and depart (alarm messages also when they are acknowledged). OFF disables printing.

To set the parameters for your printer, proceed as follows:

1. Choose the standard screen *System* → *Printer*.
2. Scroll through the parameter list on the display using the UP and DOWN arrow keys.
3. Choose the value for the parameter at the cursor location by using a symbolic input.
4. Exit from the standard screen – for example, by pressing the ESCAPE key.

Setting first/last message display

To define whether the oldest or the most recent alarm messages (for first/last message refer to section 7.3) is displayed when several are waiting to be displayed, proceed as follows:

1. Choose the standard screen *System* → *DispMsg*.
2. Select the corresponding parameter, i.e. either *First* or *Last*.
3. Exit from the standard screen – for example, by pressing the ESCAPE key.

Setting date and time

You can adjust the current date and time on the OP – for example, to allow for summer or winter time. Any change you make will affect all messages and screens for which a date or time variable has been defined. The display format for date and time is defined in your configuration and cannot be changed by means of the menu system on the OP.

1. *Choose the standard screen System → Dat/Time.*
Use the LEFT and RIGHT arrow keys to move the cursor from the date field to the clock field and back again.
To move the LEFT and RIGHT arrow keys within the input field for the date or time, activate Shift Lock mode beforehand so that the LED is on. Change the day of the week using a symbolic input and the date and time of day by means a numeric input.
2. Confirm your input by pressing the ENTER key.
3. Exit from the standard screen – for example, by pressing the ESCAPE key.

Note for the OP5

The OP does not have a hardware clock. Since the date and time are generated by software, this information has to be updated every time the OP starts up.

10.3 Adjusting Contrast**Display contrast adjustment**

On the OP5 and OP15, you can adjust the contrast of the LCD. The display contrast can be adjusted by means of

- direct adjustment or a
- standard screen.

Direct contrast adjustment

The display contrast of the LCD on the OP5 and OP15 can be adjusted at all times in normal mode by means of direct control:

1. Press SHIFT. The SHIFT LED lights.
2. Use the sign key (one-shot or continuously enabled) to set the contrast to the value you require.
3. Press SHIFT. The SHIFT LED is off.

Contrast adjustment by means of a standard screen

LCD display contrast can also be adjusted by means of a standard screen. To do so, proceed as follows :

1. Choose the standard screen *System → Languages.*
2. Move the cursor to *Contrast.*
3. Select the contrast value you require by means of symbolic input (1 for minimum contrast, 16 for maximum contrast).

10.4 Modes

Settings on standard screens

A standard screen can be used to set the OP modes Online, Offline, Download and Loop-Through.

Online

In Online mode, there is a logical link between the OP and the PLC, or the OP attempts to establish a link. The OP cannot be switched to online mode by a PLC job.

Offline

In Offline mode, a logical link does not exist between the OP and the PLC. The OP does not even attempt to establish a link.

Download

In Download mode, data is transferred from the PU/PC to the OP. In this particular instance, a logical link does not exist between the PLC and the OP. The OP cannot be operated while data is being transferred.

Loop-Through (OP15 only)

While the OP is being commissioned, troubleshooting or optimization of the PLC program is often necessary. For this purpose, the PU or PC can be connected to the second interface of the OP in Loop-Through mode. This way it is possible to communicate between PC/PU and the PLC through the OP. For the restrictions which have to be taken into account in Loop-Through mode refer to section 15.5.

Setting the OP mode

Jobs from the PLC to the OP can be initiated only when the OP is working in normal Online mode or switched to Loop-Through mode.

To set OP modes, proceed as follows:

1. Choose the standard screen *System* → *OpMode*.
2. Set the mode you require by means of a symbolic input.
3. Terminate the function call.

You will find further information on OP modes in Chapter 16 of this manual.

Part III Expanded, Configurable Functions

Process-Dependent Operator
Guidance

11

Schedulers

12

Controlling the OP from the PLC

13

Process-Dependent Operator Guidance

11

Situation-specific process control

Different action is normally required or allowed in different operating situations. To support changing requirements during process control, you can configure the following measures, which provide the operator with situation-specific purposeful help:

- screen-dependent soft keys,
- global function keys and
- user-defined screen hierarchies.

11.1 Branching by Means of Soft Keys and Function Keys

Soft keys: function keys with a variable assignment

You can assign function calls to the function keys on the OP5 and the OP15. We distinguish in this instance between local and global assignment. Global means that the assignment applies to the entire configuration. Local means that the assignment applies to one screen entry only. This makes it possible for the operator to initiate functions as and when required by the situation. When the assignment of function keys may vary from screen entry to screen entry, the keys are referred to as soft keys.

The following keys can be assigned as soft keys on the different devices:

OP5

Keys F2 to F5 of the function keyboard may be configured as soft keys. Function keys F1 and F6 may be assigned globally during configuration.

OP15

Keys F1 to F8 beneath the display may be configured as soft keys. Function keys K1 to K16 may be assigned globally during configuration.

While configuring soft keys, you must make sure that function calls which are required to be permanently available, i.e. also during screen editing, are not assigned to keys which you intended to be soft keys.

Possible assignments of function keys and soft keys

You can assign the following functions to function keys and soft keys:

- branch to message level,
- select screen,
- initiate a print job.
- display directory,
- modify parameters in online mode.

Password level assignment

A password level may be assigned to a function key or a soft key. This means that you can make functions, such as "Modify parameters in online mode", available only to authorized persons.

Special feature with function keys

If a function can be called in a given situation by means of a specific function key, the LED assigned to the function key can be turned on by the PLC. Operator guidance, for instance, can be implemented in this manner.

Special feature with soft keys

A bit can be configured in a variable for every soft key. This insures that a bit is set in the PLC when a soft key is pressed. In this instance, the OP always transfers the whole variable to the PLC instead of the individual bits and overwrites the information it contains.

When the key is released or upon a change of display which modifies soft-key assignment, the bit is reset.

11.2 Self-Defined Screen Hierarchy

Defining the screen hierarchy

The screen hierarchy can be adapted to system-specific requirements and be modified either in part or in whole. Screens can be removed or added.

Screens can be linked together in random order. The design, sequence of the link, inclusion in the screen directory and the relevant cross-jump destinations are defined during configuration with ProTool/Lite.

Branching using soft keys and cross-jump destinations

You branch between the different screens by means of soft keys and configured cross-jump destinations. Branching from entries of different screens to one and the same screen is possible (figure 11-1). Cross-jumps are not restricted to screen level, but can branch to the message level too.

Defining the start-screen

Another feature that is configured is the picture you want to have displayed on the OP as your start screen.

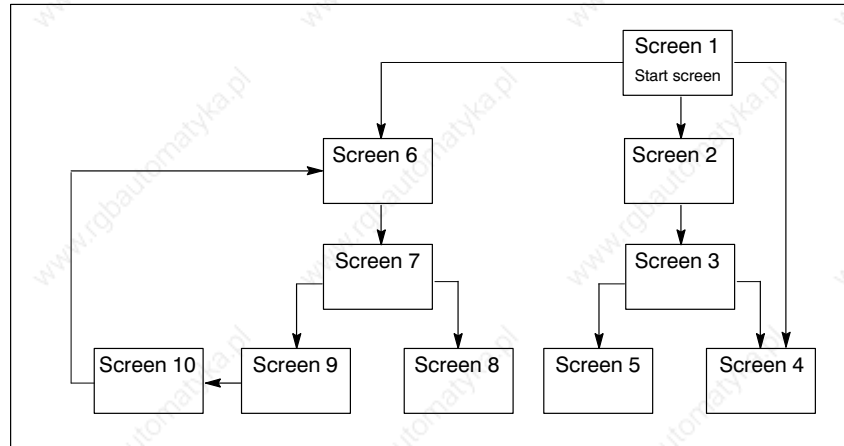

Figure 11-1 Principle of a Screen Hierarchy

An overview is presented below, with reference to an example, of the design of a screen hierarchy. Detailed information on configuration will be found in the *ProTool/Lite User's Guide*.

Example

The OP is used to operate and monitor a system for producing and bottling different fruit juices. The system consists basically of a mixing unit and a bottling machine.

Mixing unit

The ingredients for the fruit juices are contained in three tanks. Depending on the juice that you wish to manufacture, ingredients are mixed in certain ratios.

Bottling machine

After it has been mixed, the fruit juice flows into the bottling tank after a valve has been opened and then bottled in the correct quantities. The bottles are conveyed on a belt. Before being filled, they are checked for breakages. After they have been filled, the bottles are capped, labeled and transferred to pallets.

The configured basic screen could look – for example, on the OP5 display – like the one shown in figure 11-2. It consists of static text only.

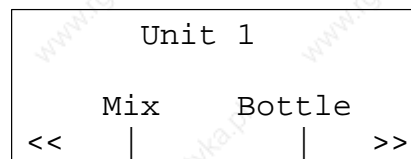

Figure 11-2 Start Screen of the System (in This Instance for the OP15/C, 4x20)

The screen segment on the display can be moved horizontally with the soft keys below the symbol << and >>.

Pressing the soft key beneath the "Mix" entry allows you to view the entry shown in figure 11-3. It similarly consists only of static text which refers to other screens ("Tank2", "Tank3" and "Mixer").

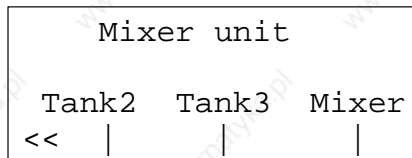

Figure 11-3 Screen with Static Text (Example)

If you press the "Tank2" soft key, the entry displayed in figure 11-4 appears. This entry contains static text and two output fields (Tank Contents and Set Temperature) as well as an input field (Valve Position). The position of the tank valve can be set in the input field by means of a symbolic value input – for example, OPEN or CLOSED).

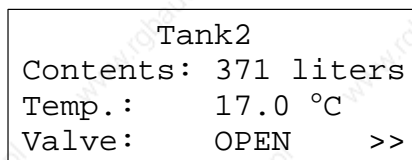

Figure 11-4 Screen with Input and Output Fields (Example)

Schedulers

12

Depending on the configuration, you can specify so-called schedulers for the OP15. A scheduler is a regularly recurring point in time (i.e., hourly, daily, weekly, annually) at which a certain function is to be executed. Up to 48 schedulers and their corresponding functions can be configured.

A scheduler is contained in a screen entry where it can be entered, changed or deactivated when the screen is displayed.

When a scheduler time is reached, the configured bit is set in the interface area of the PLC.

See *User Guide Communication* for detailed information on the interface area of the PLC.

Functions

The following functions can be called via schedulers.

- Print alarm message buffer (chronologically or together)
- Print event message buffer (chronologically or together)
- Select screen
- Print screen
- Print data record

Changing schedulers

The schedulers have already been preset via configuration. A scheduler can be changed or deactivated via input fields in a screen entry.

The scheduler is activated as long as a time is displayed in the input field. The LED of the DELETE key goes on when a scheduler is activated. Activated means that the configured function will be executed when the scheduler time is reached. If the input field contains ???, the scheduler is deactivated.

Proceed as follows to set a scheduler time.

1. Select input field.

You can use the cursor keys to switch between scheduler type and day of the week field, and date field and time field.

2. Enter scheduler time.

- Date and time are entered via the system keyboard.

Activate the SHIFT-LOCK combination to control the cursor within the input field for date or time.

- The day of the week is set via a symbolic entry.

3. Confirm entry with ENTER.

The scheduler is now activated.

Deactivating schedulers

You can delete the scheduler time in a screen entry by pressing the DELETE key. The scheduler is then deactivated (i.e., the configured function will not be executed).

Controlling the OP from the PLC

Common data areas

The OP and the application program communicate with each other by alternately reading from and writing to the data areas in the memory of the PLC. Thus the PLC and the OP can make each other execute different actions by evaluating data areas.

PLC jobs

PLC jobs are functions that are initiated on the OP – for example, selecting screens, printing screens, transferring the date and time from the OP to the PLC. Jobs are stored with a job number and parameters on the PLC.

The PLC, for example, can call a screen on the OP to draw the operator's attention to a particular condition or to the fact that inputs are required.

You will find a complete list of all the PLC jobs with their parameters and a description of all the data user areas that have to be configured on the PLC in the *Communication User's Manual*.

LED control

The LEDs on the keys of the OP can be driven from within the PLC. This means it is possible to signal to the operator by means of a lit key LED that it is advisable to press a specific key in a certain situation.

For LED control, it is necessary to create an LED image on the PLC. In the configuration, two bits are assigned to every LED in the LED image area. These two bits can be used to implement four different LED states: Off, Permanently On, Low-Speed Flashing, High-Speed Flashing.

Evaluating the screen number

The OP stores information about the object type called in the screen number area of the PLC. Thus it is possible for information about the current display contents of the OP to be transferred to the application program on the PLC and, from there, for certain reactions to be initiated – for example, calling another screen.

Function keyboard image

With pressing a function key, it can be used to set a bit on the PLC, where it is evaluated by the application program.

For this, you must have created the necessary data area on the PLC for the keyboard image and have specified the appropriate area pointer in the configuration for assigning the key to a bit.

At most, the activation of two simultaneously pressed keys can be transferred.

System keyboard image

A bit is permanently assigned to every key on the system key board – apart from the arrow keys and the directory key – in the data area for system keyboard bits. The bit remains set for as long as the corresponding key is pressed. The bit is reset when you release the key.

Owing to the evaluation of this data area, the operator's attention can be drawn to the wrong operation of a key – for example, by means of an error message.

Date and time

Transfer of date and time can be initiated from the OP by means of a PLC job in order to synchronize the OP and PLC.

PLC → OP acknowledgment area

By creating a suitable data area, it is possible for alarm messages to be acknowledged by the PLC instead of on the OP.

OP → PLC acknowledgment area

If the PLC is required to announce that an alarm message has been acknowledged, this can be done following creation of a suitable data area.

Part IV Commissioning and Description of Devices

Mechanical Installation	14
Electrical Installation	15
Commissioning	16
Device Description	17
Connecting a printer	18
Test and Monitoring Functions	19
Maintenance	20

Mechanical Installation

Mounting location and dimensions

Operator Panels OP5 and OP15 are suitable for fitting into control cabinets and consoles. For this, the front panel must be provided with a mounting cut-out (refer to Chapter 17). The front panel must not be thicker than 16 mm. No other drilled holes are required for mounting. You will find mounting depth details in Chapter 17.

Make sure at the location where you plan to install the OP that there is a clearance of at least 50 mm beneath its housing to accommodate protruding connectors.



Caution

To prevent the OP from overheating in operation,

- the device must not be exposed to direct sunlight (this simultaneously prevents fading of the foil front) and
 - the ventilation slits in the device housing must remain free after mounting.
-

Note

The IP65 degree of protection on the front panel can be insured only when the gasket on the front panel of the OP fits properly.

Installing the OP

Insert the OP from the front into the prepared cutout. Attach the OP5 firmly to the front panel from behind with the three screw type hooks enclosed with the device; four screw type hooks are enclosed with the OP15 for this purpose. Figure 14-1 shows the positions provided for this purpose at the rear of the devices.

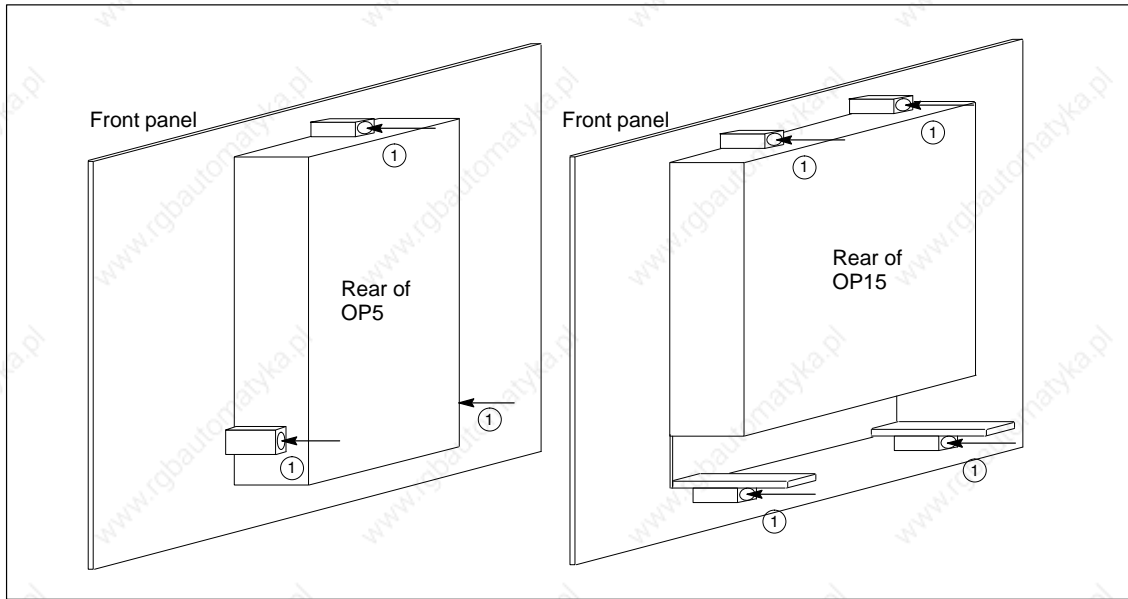

Figure 14-1 Positions for Screw Type Hooks on the OP5 and OP15

To attach them, you must put in the screw type clamps ① in the housing of the OP ② and screw the threaded spindles ③ at the rear with an Allen key ④ towards the front panel (14-2).

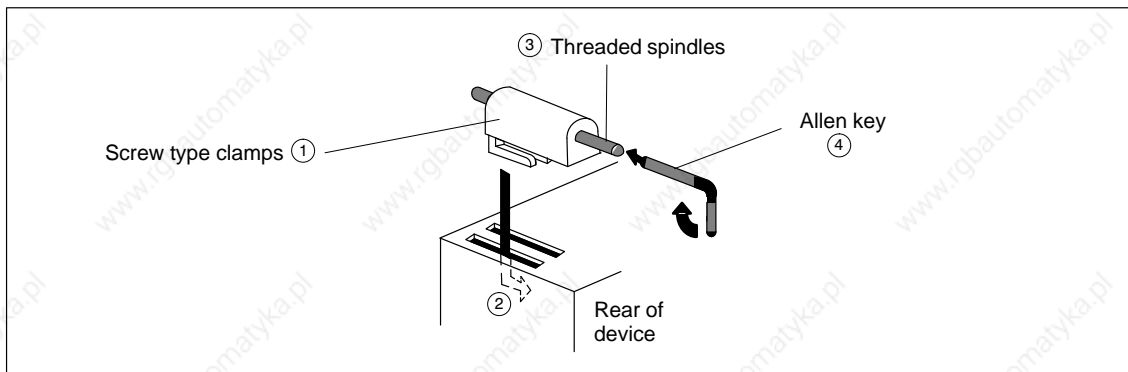

Figure 14-2 Tighten the OP to the Front Panel

Electrical Installation

Electrical connections

The OP requires the following electrical connections

- to the power supply,
- to the configuring computer (PC or programming unit),
- to the PLC.

The electrical connection to the configuration computer is required to download the configuration to the OP.

The basis for interference-free operation is interference-proof hardware design of the PLC in accordance with EMC guidelines and the use of interference-proof cables.



Caution

Assemblies may be changed only by suitably **qualified persons** who must be completely familiar with all the warning notices and steps of this manual.

15.1 Setup Guidelines for Interference-Proof Installation

Shielding

An automation system must be shielded to prevent interference.

When a system is poorly grounded, low-frequency and high-frequency interference signals can penetrate the internal bus of the PLC and cause malfunctions.

Interference signals can also be caused when relays or contactors switch (very rapid changes in current or voltage; high-frequency interference signals) or when two parts of a system have different grounding potentials (low-frequency signals).

Use and installation of interference-proof cables

Use only shielded cables for all signal connections.

Ground the shields of cables on two sides for

- cables to the PLC,
- bus cables,
- cables to I/O devices.

The standard cables specified in the *ST80.1* catalog meet these requirements.

Screw down or lock all plug connections.

Separate cable duct for signal lines

Do not install signal lines parallel to high-voltage lines. Use a separate cable duct located at least 50 cm from high-voltage lines.

Interference-proof hardware setup

The basis of interference-free operation is the hardware setup of the PLC. Any interference signals caused by the process must be kept away from the hardware setup to the extent possible.

Cabinet setup

Install devices which could bring in interference signals from the outside at the bottom of the cabinet. Place the grounding rail directly at the cabinet entrance so that cables which could be carrying interference signals can be applied directly to grounding potential. Apply all shielded lines with the shield here. Apply only the outer shield of double-shielded signal lines here.

Install long signal lines along the cabinet walls. Setting up the cabinet in accordance with EMC guidelines is an important factor in the reduction of interference. All grounding connections in the cabinet must have large cable cross sections and be applied over a large surface.

Insulate analog devices in the switching cabinet and ground them to a single point in the cabinet using copper tape.

Always use equivalent metals for the materials. Never use aluminum (danger of oxidation).

Connect all doors and metal parts (sides, back and cover) of the cabinet at least three times to the cabinet frame (short, paint-free, large-area connections).

Note

If your system generates high electrostatic voltages (for example, textile machines and special construction machines), run the grounding lines of the machine parts with interference signals to a separate operating ground isolated from the central grounding point of the cabinet (surface grounding with housing construction, reinforcement).

15.2 Assigning the Terminal Block

Power supply

Connect the power supply to the terminal block on the bottom of the housing and wire up the authorization input.

Figure 15-1 shows the assignment of the 3-pin terminal block for the OP5/A2, figure 15-2 shows the assignment of the 4-pin terminal block for the OP5/A1 and all OP15 versions.

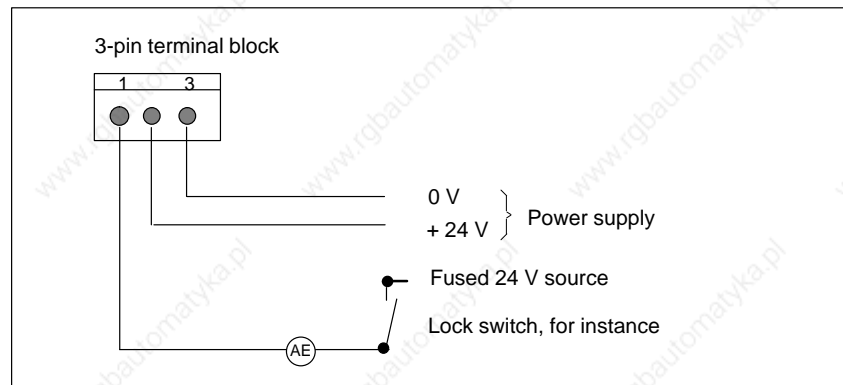

Figure 15-1 Assignment of the Terminal Block on the OP5/A2

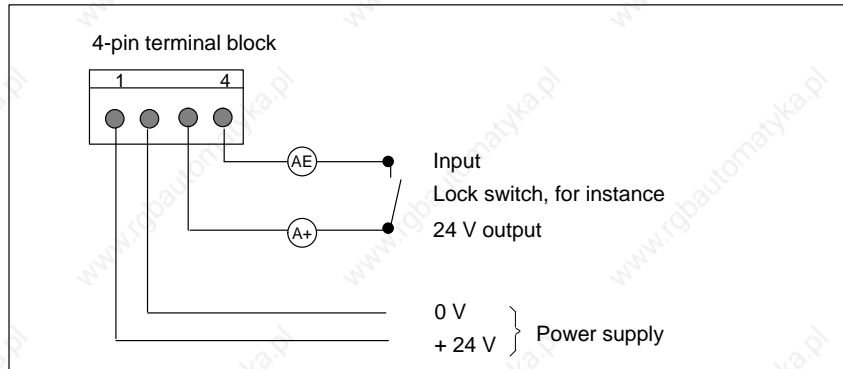

Figure 15-2 Assignment of the Terminal Block on the OP5/A1 and OP15

Requirements for the power supply

Rated voltage	+ 24 V DC
Voltage range	+ 18 V to + 30 V
Current (at rated voltage)	
• OP5	180 mA (typically), 250 mA (maximum continuous current)
• OP15	200 mA (typically), 300 mA (maximum continuous current)



Caution

- With a 24 V supply, make sure the extra-low voltage is isolated safely. Use only power supplies complying with ICE 364-4-41 or HD 384.04.41 (DE 0100. Part 410).
- The power supply must be within the aforementioned voltage range. If not, functional failures cannot be ruled out.

Chassis ground

Connect the chassis ground  on the bottom of the device to the cabinet ground.

15.3 Connecting a Configuration Computer

Interfaces for the connections

Connect a configuration computer – for example, a programming unit – temporarily to the OP interfaces which are shown in figure 15-3 and which are used only to download configuration data. Standard cables are available for the connections shown in the figure (refer to the ST80.1 catalog).

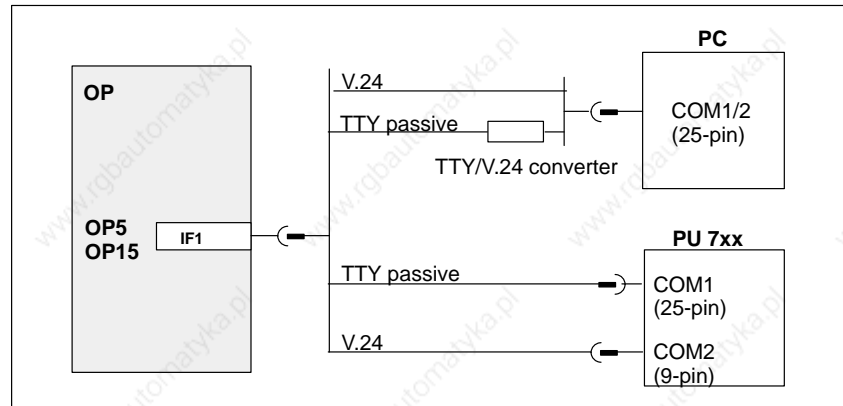
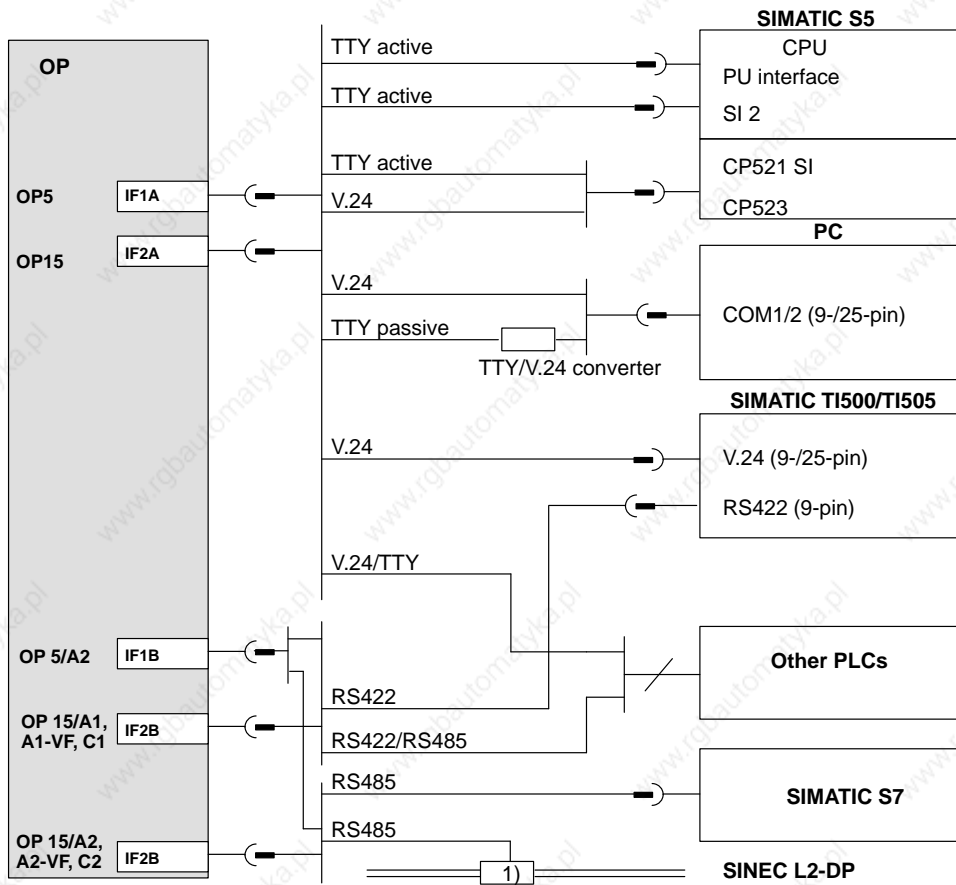

Figure 15-3 Connection Configuration Scheme for a Configuration Computer

15.4 Connections to PLC

Interconnection options

Figure 15-4 shows the options for interconnecting the OP and the PLC. Standard cables are available for the connections shown in the figure (refer to the ST80.1 catalog).



1) Any SINEC L2 bus terminal (except FSK)

Figure 15-4 Connection Configuration Scheme for PLCs

15.5 Loop-Through Mode (OP15 only)

IF1 interface of OP15 for loop-through mode

The IF1 interface of the OP15 is optionally available for the loop-through mode of a configuration computer or another OP. This means that

- the PLC can be accessed during operation
- a second OP can be connected to a PLC at a reasonable price

Figure 15-5 provides an overview of the connections in AS511 loop-through mode. Standard cables are available for the connections shown in the figure (refer to the ST80.1 catalog).

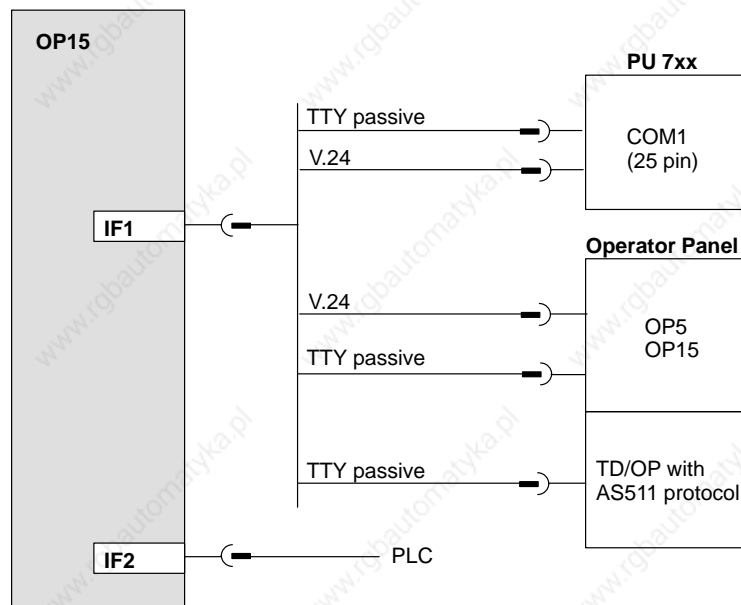

Figure 15-5 Connection Configuration Scheme for AS511 Loop-Through Mode

Constraints in loop-through mode

- Print functions of the looped-through OP cannot be used.
- The OP does not perform life-bit monitoring, i.e. it cannot detect whether the PLC is in Stop mode, for example. (Life-bit monitoring continues to be performed on the PLC.)
- System performance may deteriorate due to higher loading of the interface to the PLC.

Particularities for connection of a PU

If PU status functions are activated (message on PU: "Status processing in progress" – for example, for a block status, Force Var),

- the following system message is displayed on the Operator Panel "\$340 Status in progress, loop- through mode",
- the OP can no longer be operated,
- communication between the OP and the PLC is stopped. There is therefore little sense in evaluating error number 115 of the standard FB on the PLC in this particular instance.

Upon termination of status functions by means of the ESC key on the PU, OP functions are resumed.

If "Apply" is pressed **once only** with Force VAR after a value has been entered, the value you entered is transferred to the PLC, and the status function of the PU is still not active. This value (for example, a message bit or an actual value) can still be read by the looped-through OP and processed (for example, display of the associated message or the actual value). Not until "Apply" is pressed a second time is the PU status function activated.

16

Commissioning

Diagrammatic representation

Figure 16-1 shows the most important steps for initial startup, restart and normal operation of the OP. The commissioning guide which follows explains the different steps that have to be taken to commission the OP.

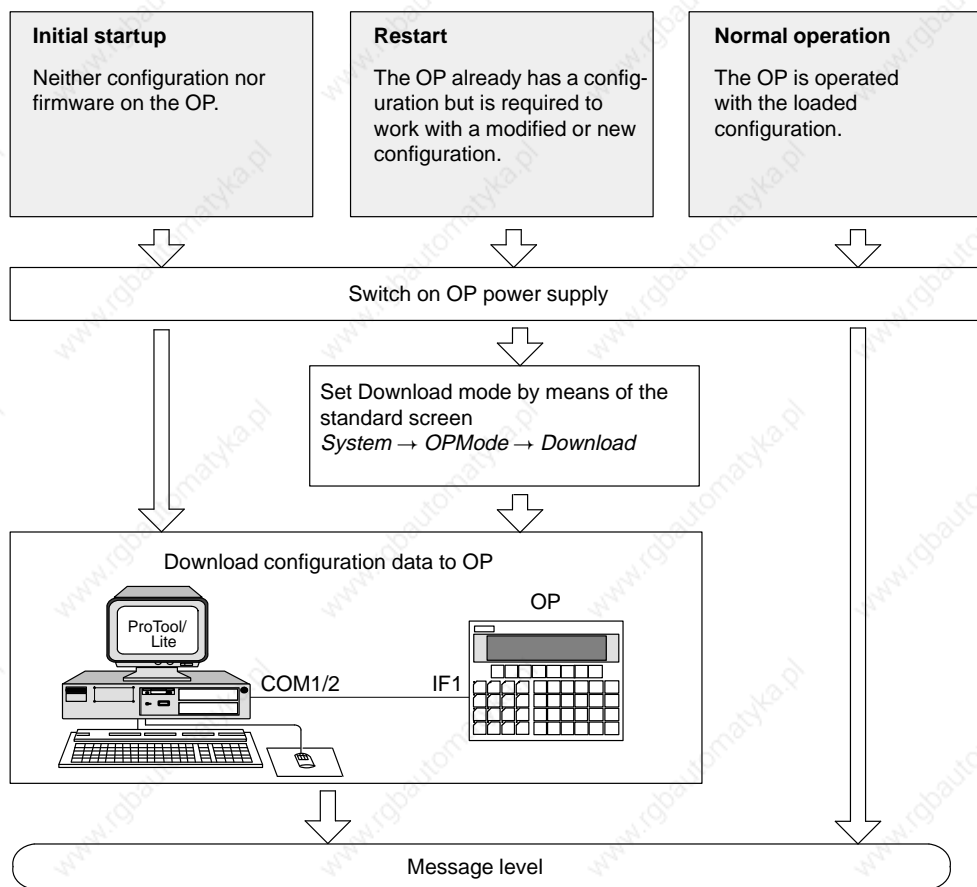

Figure 16-1 Diagram of Commissioning

16.1 Commissioning Guide

Initial startup

When your OP arrives, it contains firmware but not a configuration. This software, which is essential for operating the OP, has to be loaded for initial startup.

To do this, proceed as follows:

1. Connect interface IF1 of the OP by means of a suitable standard cable to the configuration computer (PC or programming unit).
2. Switch on the power supply of the OP. Since you have still not loaded a configuration, the OP automatically switches to Download mode with the message "Ready for Transfer" and waits for the data to be downloaded from the PC or PU. You cannot operate the OP in this mode.
3. Start the download operation to the OP on the PC or PU. The OP checks the link to the PC or PU. If a link is not available or if it is not functioning properly, the OP issues a corresponding error message. If the link is in order, downloading of the configuration from the PC or PU is initiated to the OP.

Note

Refer to the *ProTool/Lite Configuration Manual* for a detailed account of the procedure.

Once the configuration has been successfully downloaded, the OP runs up again and displays the standby message.

Restarting

If you wish to replace a configuration on the OP with another one, proceed as follows:

1. Connect interface IF1 of the OP by means of a suitable standard cable to the configuration computer (PC or programming unit).
2. Switch on the power supply of the OP.
3. Call the standard screen *System* → *OPMode* → *Download* to switch to Download mode on the OP. Before you do so, enter the password for the password level concerned, if required.

If this standard screen is not available in your configuration, press – while switching on the power supply – the following three keys

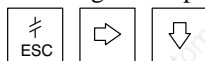

This key combination deletes the configuration from its memory. The OP then switches to Download mode with the message "Ready for Transfer".

4. Start the download operation to the OP on the PC or PU. The OP checks the link to the PC or PU. If a link is not available or if it is not functioning properly, the OP issues a corresponding error message. If the link is in order, downloading of the configuration from the PC or PU is initiated to the OP. In doing so, the present configuration on the OP is overwritten by the new one.

Once the configuration has been successfully downloaded, the OP runs up again and displays the standby message.

Fault diagnosis

Any fault occurring during commissioning or in operation is normally displayed by means of an error message on the display of the OP.

You will find an overview of the most important system messages together with notes on troubleshooting in an appendix to this manual.

16.2 Start-up Behavior

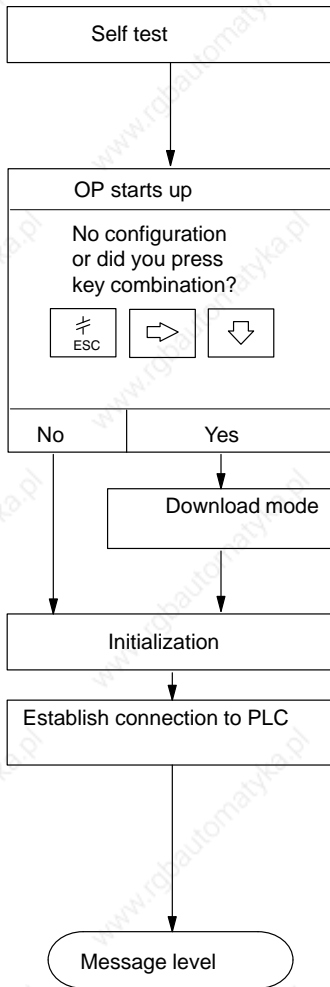

After the power supply has been turned on, the OP performs a self test.

In the test, it checks the operability of the most important device components and displays the test results.

If there is not a configuration on the OP, the OP switches automatically to Download mode.

The OP then performs various internal initializations.

In this start-up phase, the OP attempts to establish a connection to the PLC.

If communication is not possible – for example, because the cable to the PLC has not been inserted – the OP displays a system message.

After start-up, the OP is at message level.

16.3 Testing the Configuration in OFFLINE Mode

Purpose

In OFFLINE mode, you can test the different functions and the configurations downloaded from the PC or PU independently of the PLC.

In OFFLINE mode, variables are not updated.

Testing

1. Switch the OP to OFFLINE mode using the standard screen *System* → *OPMode*.
2. Check all configured screens for proper display.
3. Check the screen hierarchy.
4. Check the input fields.
5. Test the soft keys.
6. Check the different items of message text.
7. Test the function keys.

End of test

If errors occur when you perform tests 2 through 7 above, you must download the configuration again.

16.4 Testing the Configuration in Conjunction with the PLC

Test with PLC connected

Once the tests in OFFLINE mode have been performed successfully, the OP is tested in conjunction with the PLC that you connected. This test determines whether the correct data areas have been configured.

Procedure

1. Connect the OP to the PLC.
2. Proper connection is indicated on the OP by a corresponding message.
3. Acknowledge this message.
4. Switch the OP to ONLINE mode by means of the standard screen *System* → *OPMode*.

You can now test all items in your configuration for which communication with the PLC is necessary. Depending on the configuration, this might be

- event messages,
- alarm messages (for the "Inhibit Alarm Message" function refer to section 7.1.2),
- buffers for event messages and alarm messages,
- print functions,
- automatic message printout,
- screen selection,
- viewing variables, etc.

TIP

The OP15 has the built-in "loop-through mode" function.

The loop-through mode facilitates testing with the PLC during commissioning since there is then no need to keep on plugging the configuration computer alternately into the PLC and the OP.

Device Description

In this chapter

This chapter describes the versions, dimension drawings and connection elements of Operator Panels OP5 and OP15.

17.1 OP5

OP5 versions

The OP5 is available in versions A1 and A2. The functionality of the two versions is virtually identical.

Front view

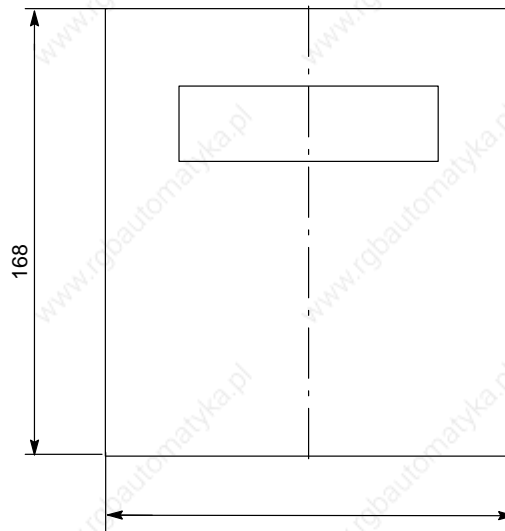

Side view

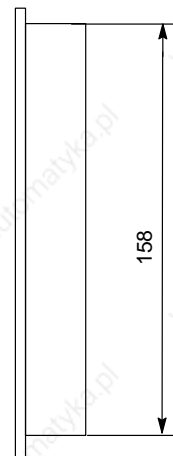

Top view

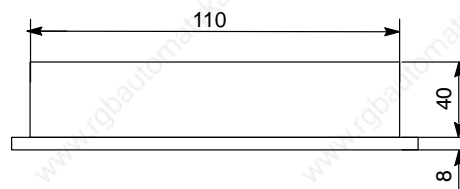

Mounting dimensions

The OP5 requires the following mounting cutout (W×H):
112₋₁ mm × 160₋₁ mm

Connection elements (on bottom of device)

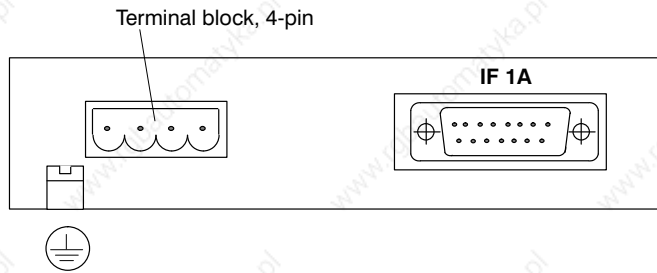

Figure 17-1 Location of connection elements on OP5/A1

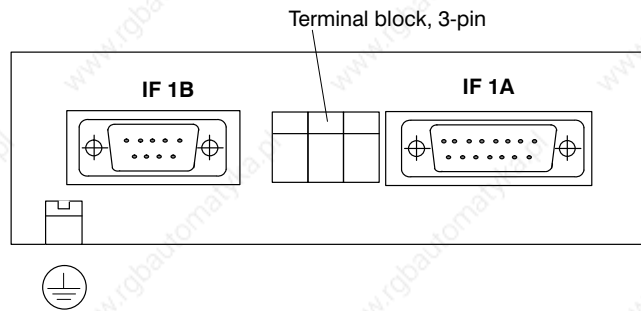

Figure 17-2 Location of connection elements on OP5/A2

OP5	Connections								
	SIMATIC S5			SIMATIC S7	SIMATIC TI 500/505		Other PLCs		Printer
	AS511	FAP	SINEC L2-DP		V24	RS422	V24/TTY	RS422/RS485	
A1	IF 1A	IF 1A	-	-	IF 1A	-	IF 1A	-	IF 1A
A2	-	-	IF 1B	IF 1B	IF 1A	IF 1B	IF 1A	IF 1B	IF 1A

IF 1A: TTY/V24
 IF 1B: MPI/RSx

17.2 OP15

OP15 versions

The OP15 is available in six versions. The functionality of the different versions is virtually identical.

Front view

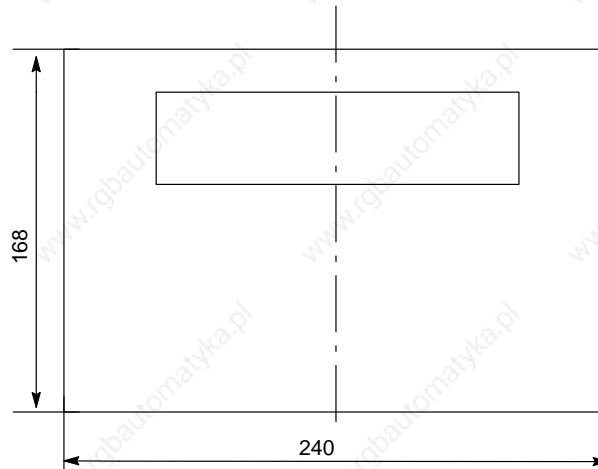

Side view

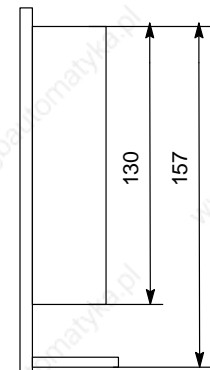

Top view

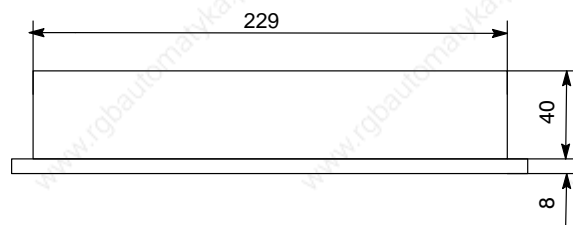

Mounting dimensions

The OP15 requires the following mounting cutout (W×H):
231₋₁ mm × 159₋₁ mm

Connection elements (on bottom of device)

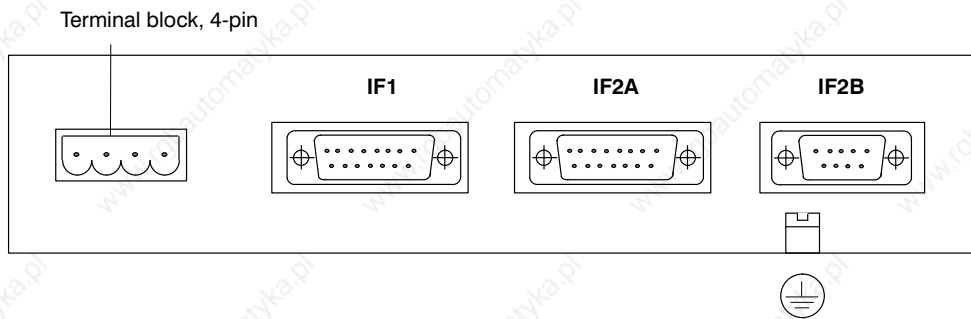

OP5	Connections								
	SIMATIC S5			SIMATIC S7	SIMATIC TI 500/505		Other PLCs		Printer
	AS511	FAP	SINEC L2-DP		V24	RS422	V24/TTY	RS422/RS485	
A1, A1-VF	IF 2A	IF 2A	-	-	IF 2A	IF 2B	IF 2A	IF 2B	IF 1
A2, A2-VF	-	-	IF 2B	IF 2B	IF 2A	-	IF 2A	-	IF 1
C1	IF 2A	IF 2A	-	-	IF 2A	IF 2B	IF 2A	IF 2B	IF 1
C2	-	-	IF 2B	IF 2B	IF 2A	-	IF 2A	-	IF 1

IF 1: TTY/V24
 IF 2A: TTY/V24
 IF 2B: For OP15/A1, A1-VF, C1:
 For OP15/A2, A2-VF, C2:

RSx
 MPI

17.3 Labeling strips

Labeling of function keys

Function keys are labeled by means of labeling strips, which are inserted into the keyboard from below (one strip for four keys).

The function keys of the OP15 are labeled K1 through K16 ex works.

A set of unlabeled strips (four) is enclosed with the OP. This means that you label the keys as you wish for your specific system.

Keep the following in mind before inserting labeling strips:



Caution

The labeling on the strips must be smudge-proof before they are inserted. A key membrane that is contaminated on its inside cannot be cleaned and can be replaced only at our works.

Replacing labeling strips

Labeling strips should be replaced only when the OP15 has been dismantled. To replace labeling strips, proceed as follows (figure 17-3):

- extract "old" labeling strips, if any, from the device and
- insert the labels you have prepared for your specific system from the rear of the device into the corresponding slits.

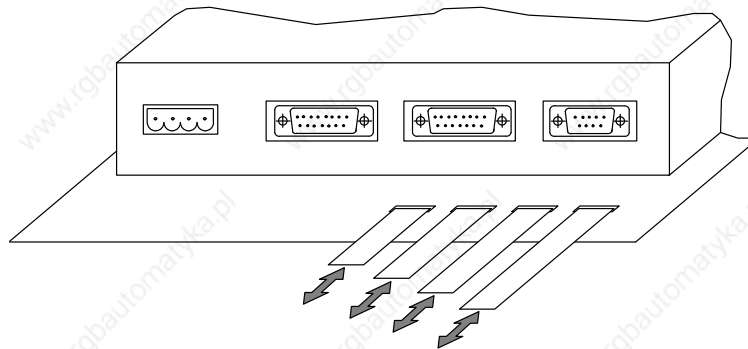

Figure 17-3 Replacing Labeling Strips on the OP15

17.4 External Floppy Disk Station (Option for OP15)

Functions

The floppy disk station offers the following functions.

- Read floppy disk directory
- Store data records
- Read in data records
- Delete files

The interface parameters on the OP are automatically set to permanently specified values for accesses to the floppy disk station. These values cannot be configured.

Use

The operator functions are integrated centrally in the OP.

Connection

The external floppy disk station is connected to the printer interface of the OP with standard cables.

The same type of interface must be used which was configured for the printer interface (i.e., TTY or V.24).

Printer operation

To permit operation of a printer despite a connected floppy disk station, this can be looped through.

Connection and setting elements

The figure below shows the location of the connection and setting elements on the back of the floppy disk station.

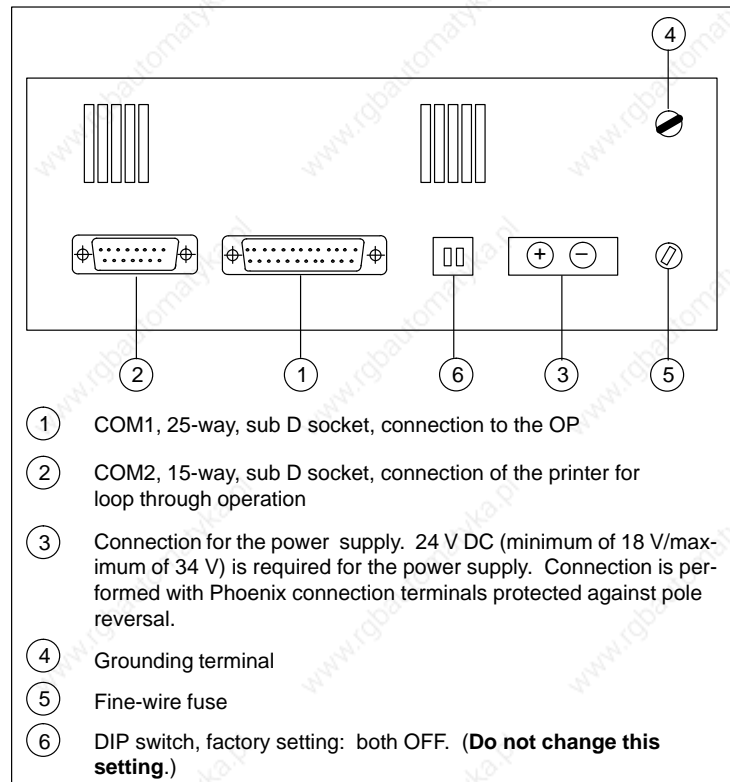

Figure 17-4 Connection and setting elements on the floppy disk station

www.rgbautomatyka.pl

Connecting a Printer

Printer connection

Always attach a printer to the PU interface on the OP. The connection to the PU has to be unplugged before you can do so.

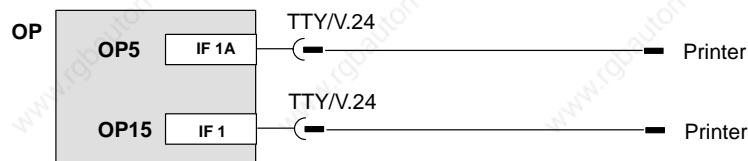

If the OP is connected to the PLC through a TTY or V.24 interface, a Y cable is required for simultaneous operation of a printer. The PLC and printer, in this case, are operated with physically different interfaces.

Figure 18-1 Connection Configuration Scheme for Printers

For attaching Siemens printers (DR210/211/230/231-N), there are standard cables available (refer to Catalog No. ST80.1).

For other printers, you have to use the cables supplied or specially manufactured ones.

Note

SIEMENS AG accepts no responsibility whatsoever for malfunctions and damage arising from the use of self-made cables or cables from other manufacturers.

Print functions

The OP makes the following print functions available:

- hardcopy
- printout of screens
- printout of alarm or event buffer
- direct message logging
- printout on buffer overload.

Settings

The settings of parameters for the print functions, the printer interface and the printer are configured.

Section 10.2 describes how you can modify the default printer parameters in Online mode. You will find the requisite printer settings in the User's Manual for your printer.

Print function settings

You can configure headers and footers for the print functions in various configurations and text with different attributes – for example, underline, *italics*). The text attributes have to be stored in ProTool/Lite for the different printers under *System* → *Printer* → *Settings* by using different control characters.

Test and Monitoring Functions

Monitoring functions

Without the operator normally being aware of it, the OP continually executes the following functions, which contribute to operating reliability of both the Operator Panel and the link to the PLC:

Voltage monitoring

The supply voltage applied to the device is permanently monitored. As soon as it falls below 14 V, the processor saves the data structure in the RAM and flash memory.

Battery monitoring

The voltage of the built-in backup battery is checked at intervals of ten minutes. If it drops below 2.5 V, system message "\$200 Change battery" is displayed.

Hardware test

Apart from a brief initial start test, which is performed for every cold start of the OP, a comprehensive hardware test with test functions for all the important components of the device can be initiated by operator input.

Hardware test displays are in German, irrespective of the language you set.

Initiation of hardware test

The hardware test is not initiated at screen level but upon the power supply being switched on. To initiate the hardware test, press three arrow keys

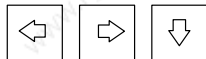

simultaneously.

Hardware test menu

From the hardware test menu, you can select individual components for testing. Selection is made by using the UP and DOWN arrow keys, and testing is initiated by pressing "ENTER".

Display contrast is set at the beginning of the hardware test to an average value and can be adjusted by means of the LEFT and RIGHT arrow keys.

End of test

Unless specified to the contrary, the system returns automatically to the menu after every individual test.

When you select "END TEST", a hardware reset is initiated and a cold start is executed.

CPU TEST	Internal registers, timers and the interrupt controller of the processor are tested.
RAM TEST	The entire static RAM is read and then write tested, its current contents are not overwritten as a result.
EPROM TEST	The checksums of the memories are determined.
FLASH TEST	In the FLASH TEST, the size and status of the FLASH memory is displayed – for example, 128 k, "empty" or "prg." for programmed.
TTY/V.24 TEST	During checking of the TTY/V.24 interfaces, data are transferred by the sender to the receiver of any interface by means of a shorting plug.

Note

For this test, loosen the terminal leads of IF1 and IF2 and connect a shorting plug you have made yourself to every socket connector. To do this, use a 15-pin Sub-D connector (plug connectors), on which the following pins are linked by insulated wire jumpers:

For the TTY test:

- 2 with 15,
- 6 with 11 and
- 7 with 9.

For the V.24 test:

- 3 with 4 and
 - 5 with 10.
-

CLOCK TEST (OP15 only)	The hardware clock on the OP15 is reset and the current time of day is displayed until some key or other is pressed.
BATTERY TEST	The range in which the battery voltage is located is displayed (in 1/16 of 5 V) Example: $(10-11)/16 \times V_{CC} = 3.13$ to 3.44 V

Note

If the battery voltage falls below a value of + 2.5 V, which corresponds to (7 to 8)/16 of + 5 V, a warning is issued in normal operation.

KEYBOARD TEST

When you press a key on the system keyboard, the name of the key – for example, "INFO" – is displayed; the key number is displayed for function keys.

End of test:

If no key is pressed for 5 seconds, the test is aborted and you go back to the menu.

DISPLAY TEST

The following test images are displayed one after the other:

1. Display light
2. Display dark
3. Character set

SUPPLEMENTARY FUNCTION TEST

Authorization:

The status of the authorization input is displayed (0 = inactive, 1 = active), until some key or other is pressed.

Watchdog:

The internal watchdog hardware initiates RESET of the processor, and the OP executes a cold start.

SPC TEST

A check determines whether the ASIC chip responsible for the SINEC L2-DP and MPI connection is present. If this is not the case, an appropriate error message is issued.

www.rgbautomatyka.pl

Maintenance

20

OP maintenance

The Operator Panels are designed for low-maintenance operation. Maintenance includes

- regular cleaning of the keyboard membrane and the display with a damp cloth (water only) and
- replacing the backup battery.

The procedure for changing the backup battery is described below.

Backup battery

The backup battery of the OP5 and the OP15 insures that, when the power supply is turned off,

- operating data are retained in the static RAM of the OP and
- the hardware clock continues to run (OP15 only).

Lifetime

The OP uses a 3.6 V/approx. 1.5 Ah lithium battery. It is installed in the device ex works and has a typical life of about four years under normal operating conditions.

Battery condition

An exhausted battery is indicated by a system message during routine operation of the OP. The backup battery should be changed as quickly as possible after the message is displayed.

Sources of supply

You can obtain new batteries from the Siemens spare parts service. They are made ready for installation and include a cable and plug connectors.

Safety notices

When you handle lithium batteries, keep in mind the following advice:



Warning

- With improper handling, there is a risk of lithium batteries exploding.
 - Batteries
 - must never be charged,
 - must not be opened,
 - must not be short-circuited,
 - must be protected against polarity reversal,
 - must not heat to more than 100 °C,
 - must be protected from direct sunshine.
 - Humidity should not be allowed to condense on batteries.
 - Should transportation become necessary, the forwarding agent concerned must comply with the Dangerous Chemicals Ordinance (obligatory labeling).
-

Replacing battery



Before you replace a battery, take note of the following:

Caution

- Battery replacement may be performed only by **qualified persons**.
 - Before replacing a battery, study the ESD guidelines in the appendices to this manual.
-

Note

Make sure the voltage supply is switched on when you replace a battery to prevent a loss of data.

To replace a battery, proceed as follows:

1. Remove the battery cover and take the battery from its holding device.
 2. Pull off the connector on the battery lead.
 3. Insert the new battery in reverse order.
-



Caution

Spent lithium batteries should be treated as special waste. Pack them separately in leakproof plastic bags for disposal.

Part V Appendices

Short Description of Standard
Screens

A

System Messages

B

Technical Data

C

Interface Assignment

D

ESD Guidelines

E

Siemens Worldwide

F

Brief Description of Standard Screens

A

The table below presents an overview of all the standard screens for Operating Panels OP5 and OP15. Apart from a brief comment on functions, mention is made of the requisite password level. The "Level 1" column lists the screens that you can choose from the basic screen. These screens allow you to make different calls, which are listed under "Level 2".

Level 1	Level 2	Function	Password Level
<i>Alarms</i> →	<i>View</i>	<ul style="list-style-type: none"> • Display alarm messages in alarm buffer • Display message text for message selected in alarm buffer. 	0
<i>Alarms</i> →	<i>Print</i>	Print alarm messages as history, i.e. all message events (arrive, depart, acknowledge) in chronological order of their occurrence.	2
<i>Alarms</i> →	<i>Number</i>	Display the messages entered in buffer, divided into 'messages over-all' and 'queuing messages'.	0
<i>Alarms</i> →	<i>Delete</i>	Delete all acknowledged and departed alarm messages from the buffer.	6
<i>Alarms</i> →	<i>Overflow</i>	Enable and disable a system message upon over flow of the alarm buffer.	4
<i>Alarms</i> →	<i>Text</i>	Display all text elements of alarm messages	0
<i>Events</i> →	<i>View</i>	<ul style="list-style-type: none"> • Display event messages in event buffer. • Display message text relating to a message selected in event buffer. 	0
<i>Events</i> →	<i>Print</i>	Print event messages as history, i.e. all message events (arrive, depart) in chronological order of their occurrence.	2
<i>Events</i> →	<i>Number</i>	Display messages entered in the buffer, divided into 'messages over-all' and 'queuing messages'.	0
<i>Events</i> →	<i>Delete</i>	Delete all event messages in the event buffer that have arrived and departed.	6
<i>Events</i> →	<i>Overflow</i>	Enable and disable system message upon overflow of event buffer.	4
<i>Events</i> →	<i>Text</i>	Display all text elements of event messages	0
<i>Screens</i> →	<i>Edit</i>	<ul style="list-style-type: none"> • Display directory for screens. • Display screens and edit fields 	0
<i>Screens</i> →	<i>Print</i>	<ul style="list-style-type: none"> • Display directory for screens. • Output selected screen to printer. 	2
<i>Records</i> →	<i>Edit</i>	<ul style="list-style-type: none"> • Display directories for recipes • Display and edit data records 	1

Level 1	Level 2	Function	Password Level
<i>Records</i> →	<i>Transfer</i>	<ul style="list-style-type: none"> • Copy data record • Transfer data record from PLC to OP • Fetch data record from PLC to OP 	1
<i>Records</i> →	<i>Print</i>	Print recipe with selected data record	2
<i>System</i> →	<i>OPMode</i>	Set OP operating modes: Online, Offline, Download, Loop-through	8
<i>System</i> →	<i>DispMsg</i>	Set whether the oldest (first) or latest (last) alarm message is displayed when there is more than one message waiting.	4
<i>System</i> →	<i>SysMsg</i>	Display system buffer.	0
<i>System</i> →	<i>Language</i>	Select language.	2
<i>System</i> →	<i>Dat/Time</i>	Set date and time	4
<i>System</i> →	<i>Printer</i>	Set printer parameters.	2
<i>System</i> →	<i>IF1A/V24</i> <i>IF1A/TTY</i> <i>IF1B</i> <i>IF1</i> <i>IF2A/B</i>	OP5 only: Set interface parameters. OP15 only: Set interface parameters.	6
<i>StatVAR</i>		Display S5/S7 operands	0
<i>ForceVAR</i>		Display and modify S5/S7 operands.	8
<i>Password</i> →	<i>Login</i>	Log in a user by entering a password.	0
<i>Password</i> →	<i>Logout</i>	Log out a user and branches backward to message level.	0
<i>Password</i> →	<i>Edit</i>	<ul style="list-style-type: none"> • Display password list. • Allocate and modify passwords and password levels. • Delete passwords. 	9

System Messages

B

Message number

System messages on the OP can be placed in different categories.

Information on the category to which a system message belongs is contained in the message number:

Message number	Message text
0	Driver error
1	Start-up message
2	Warning
3	Note
4	Operating error
5	Other message
6	Configuration error
7	Internal error

The message category gives you a rough idea of the cause of a system message.

A few important system messages are shown below together with their causes and the action that has to be taken to remedy the errors.

Self-explanatory system messages are not included.

Note

Messages are displayed in English until configuration data have been downloaded to the OP.

Procedure in case of "internal errors"

Proceed as follows for all system messages that relate to "internal errors":

- Switch off the OP, put the PLC in STOP mode and restart the OP and the PLC.
- Put the OP in Download mode during start-up (refer to section 16.1), download the configuration again and restart the OP and the PLC.
- If the error continues to occur, please contact the nearest Siemens branch office. Report the number of the error that has occurred and any variable that may be included in the message.

System Messages

Message	Cause	Action
Please wait	Mode in process of being changed	
Ready for transfer	Waiting for data from PU or PC	
Data transfer	Data being transferred between PU or PC and OP	
Firmware not compatible	Firmware cannot be used for current configuration.	
EPROM memory failure	Memory submodule defective, internal hardware error	Return device for repair with details of error
RAM failure		
Flash memory failure	Memory submodule defective or transfer failure	Repeat download configuration or return device for repair

Message	Cause	Action
\$ 005	Internal error	
\$ 006	Error during data transfer in Download mode (message with two variables) Var. 1 Status display Var. 2 1 Internal error 3 Timeout error 5 Parity error 6 Framing error 7 Overrun error 8 Line interruption 9 Receive buffer overflow 10 Wrong control character 11 Internal error	Check connection, repeat download
\$ 040	No response from PLC – Cable defective or not plugged in – Character delay time too short (FAP only)	– Check physical connection – Modify and repeat download configuration or PLC program
\$ 041	Temporary driver error	– Restart PC – Download configuration
\$ 100	Invalid RAM contents	
\$ 104	Download mode canceled by pressing a key	
\$ 106	Serious error eliminated and key pressed	
\$ 108	Mode change	
\$ 110	Mode change	
\$ 114	PLC cold restart	
\$ 115	Establishment of logical link	
\$ 117	Connection to PLC OK again following a fault	
\$ 119	Automatic start of OP (password list is not compulsorily deleted)	
\$ 125	Language changed by standard screen or PLC job	
\$ 131	Mode change	
\$ 133	Mode change	

System Messages

Message	Cause	Action
\$ 135	Mode change	
\$ 200	Backup battery voltage has fallen below minimum value or: wrong battery type inserted	Replace battery
\$ 201	Error during clock chip write (hardware error)	Return device for repair
\$ 202	Error when reading date	Re-enter date (return OP for repair)
\$ 203	Error when reading time	Re-enter time (return OP for repair)
\$ 204	Error when reading day	Re-enter day (return OP for repair)
\$ 205	Printer not ready and internal storage of print jobs is no longer possible (capacity exceeded)	Ready printer or disable message log
\$ 206	Printer not ready, print job will be stored temporarily	Ready printer
\$ 207	Print job was aborted	Check printer, cable and connector
\$ 210	Internal error	Refer to Action for internal errors
\$ 212	Internal error	Refer to Action for internal errors
\$ 213	Offline mode not possible at present	Try mode change again later
\$ 214	The job number sent by PLC is too high	Check PLC-user program
\$ 217 \$ 218	The addresses of two variables overlap	Modify configuration (variable)
\$ 220 \$ 221	Printer buffer overflowed, messages have been lost	
\$ 222	Event buffer full to remaining buffer space	Delete buffer or configure smaller remaining buffer space
\$ 224	Event buffer full; buffer partially deleted and forced printout initiated	
\$ 225	Alarm buffer full to remaining buffer space	Delete buffer or configure smaller remaining buffer space
\$ 227	Alarm buffer full; buffer partially deleted and forced printout initiated	
\$ 229	Keyboard connector faulty or loose (hardware fault)	Return device for repair

Message	Cause	Action
\$ 303	PLC did not invert life flag. Data have not been requested or are no longer valid	Check PLC status
\$ 304	Invalid job number or job parameters	Modify job on PLC
\$ 305	Data block number x missing	Create the data block that is missing
\$ 306	Temporary driver error	
\$ 307	Counter x not present on PLC	Modify configuration (variable)
\$ 308	Timer x not present on PLC	Modify configuration (variable)
\$ 309	Input x not present on PLC	Modify configuration (variable)
\$ 310	Output x not present on PLC	Modify configuration (variable)
\$ 311	Flag x not present on PLC	Modify configuration (variable)
\$ 312	Print job rejected because similar job now being executed	Wait until previous job terminated; initiate again
\$ 313	Print job will be processed later because printer now busy	
\$ 315	Information text has not been configured for highlighted object (e.g. message, variable)	
\$ 316 \$ 317	Current password level too low for required operator input	Log in at higher password level
\$ 318	Login attempted with invalid password	
\$ 319	You entered and tried to edit an existing password	
\$ 320 \$ 321		Enter password first, and then specify level
\$ 322		Password must contain at least 3 characters
\$ 323	In a buffer mask, you pressed  (message text), though an entry does not exist for the current message.	
\$ 324	The screen number or entry number in your input does not exist	

Message	Cause	Action
\$ 326	Recipe selected in the PLC is not active. Data record transfer not possible	Select active recipe on the OP
\$ 327	Invalid recipe number in the PLC job	
\$ 328	Recipe number in the PLC job greater than 99	
\$ 329	Same number for destination and source	Specify different data record numbers for source and destination.
\$ 330	Source or destination not specified	Specify source and destination.
\$ 331	Data record specified as source does not exist.	
\$ 332	Data record number in the PLC job greater than 99	Change PLC program.
\$ 333	Data record number in PLC job invalid	Set up missing data record or specify another data record in the PLC job.
\$ 335	Confirmation of alarm message inhibit	
\$ 336 \$ 337 \$ 338	Printer cannot be addressed	Check printer and connection to OP
\$ 339	Communication with PLC resumed	
\$ 340	You cannot operate the OP with status function running on PU	
\$ 401	Entered value does not match display format	
\$ 402	Operating error in STATUS VAR or FORCE VAR screen; (after pressing INS when 10th variable line already assigned).	
\$ 403	Incorrect time input	
\$ 404	Incorrect date input	
\$ 406	Operating error in STATUS VAR or FORCE VAR screen	Abort updating (ESCAPE key)
\$ 409	Lower limit for input ignored	Enter a value greater than or equal to <i>Var</i>
\$ 410	Upper limit for input ignored	Enter a value smaller than or equal to <i>Var</i>

Message	Cause	Action
\$ 500 \$ 501 \$ 502 \$ 503 \$ 504	Download to PLC not possible at present – PLC overloaded – Standard FB not called for more than 1.5 sec	– Check PLC program
\$ 506	Too many message blocks having the same block number in transit (overloading)	Error occurs when PLC sends too many jobs within a certain time with "Fetch message bit area"
\$ 507	Data transfer was not acknowledged by the PLC within a certain time.	DB check by user on PLC side must be speeded up (≤ 10 sec).
\$ 509	Firmware version different from standard FB version.	Load new standard FB onto PLC
\$ 510	DB for variable in recipe does not exist. Incorrect recipe data	Set up DB or change configuration.
\$ 511	Data record number in PLC job or function key invalid	Set up new data record or specify another data record in PLC job.
\$ 520	Too many returns stored	Go to message level (if necessary, by pressing ESCAPE key)
\$ 522	Screen cannot be selected due to inadequate storage space. Results in cold restart with memory optimization	1. Delete unused fields from configuration 2. Configure smaller screen (with fewer fields) or partition screen
\$ 526	Loop-through mode is set on OP	Change to Normal mode
\$ 527	An access to the floppy disk station was triggered (via operator input or job) although last access is still being performed.	
\$ 528	The specified recipe number does not exist.	
\$ 529	The specified file name does not exist.	
\$ 531	Because recipe configuration was changed, DS is no longer compatible and cannot be loaded.	

Message	Cause	Action
\$ 533	No connection between OP and floppy disk station <ul style="list-style-type: none"> • Connection cable not plugged in or is defective • Error on the floppy disk station • Floppy disk station not ready 	
\$ 534	No more memory space on the floppy disk	Insert a blank, formatted floppy disk and trigger transfer again.
\$ 535	<ul style="list-style-type: none"> • No floppy disk inserted • Floppy disk defective • Floppy disk not formatted 	Insert new, formatted floppy disk
\$ 536	Malfunction in the connection between OP and floppy disk station <ul style="list-style-type: none"> • Connection cable defective or not plugged in correctly 	
\$ 537	Read access to blank floppy disk	
\$ 538	Simultaneous access to data record via job and operator input	Repeat access which was not executed
\$ 540	Maximum number of data records already set up	
\$ 600	Wrong parameter transferred by ProTool/Lite (overflow warning)	Set required value by means of standard screen or PLC
\$ 601	Wrong parameter transferred by ProTool/Lite (message log)	Set required value by means of standard screen or PLC
\$ 602	Wrong parameter transferred by ProTool/Lite (remaining buffer size)	Re-configure and repeat download of required value
\$ 604	Message not configured for a set message bit	Configure messages and transfer
\$ 613	Data block does not exist or is too short	Create DB of requisite length in PLC
\$ 615	Line to be output is larger than the reserved print memory or the number of control sequences is too large	Check configuration for log
\$ 616 \$ 617		See Internal Errors

Message	Cause	Action
\$ 620	Wrong parameter transferred by ProTool/Lite (function keyboard)	Repeat download of configuration
\$ 621	Wrong parameter transferred by ProTool/Lite (message type)	Set required value by means of standard screen or PLC
\$ 622	Configured recipe does not fit in the recipe mailbox (greater than 256 data words).	Configure recipe shorter or set up subsequent recipe mailbox on line device
\$ 623		See Internal Errors
\$ 624	No recipe entries exist.	Configure recipe again.
\$ 625	Invalid recipe number in the PLC job	
\$ 626	No variables configured in the recipe	Configure recipe again.
\$ 628	Recipe too long for the mailboxes	Configure recipe shorter.
\$ 629	LED image area too small	Enlarge LED image area according to configured bit offsets
\$ 630	Keyboard image area too small	Enlarge image area according to configured bit offsets
\$ 631	(Message with one variable) 1, 2 Initiated alarm message not configured 5, 6 Initiated event message not configured 8 to 20 Internal errors 25 Invalid field type	Add to configuration and repeat download
\$ 632	(Message with one variable) 1, 4 Information text not available 2 Information text identifier not available for messages 12 Process screen does not contain entries 3, 6, 7, Internal errors 8, 11, 13	Add to configuration and repeat download
\$ 634	(Message with one variable) 18 Screen title or recipe title not configured 0 to 8, Internal errors 34	Add to configuration and repeat download

Message	Cause	Action
\$ 635	(Message with one variable) 6 Message, entry or information text not configured for current language 18 Screen title not configured 25 Invalid data format for symbolic field (KF and KY permissible only) 26 Recipe variable configured with string format 33 Invalid data format for setpoint field 45 For permanent cross-jump to screen: entry or field number not available 48 Too many fields in screen 50 Variable does not exist for soft keys 51 Soft key number too high 55 Soft key specified in entry does not exist 7 to 9, 19, 28, 41 to 43 Internal errors	Add to or modify configuration and repeat download
\$ 636 \$ 637	Initiated event message (No. x) not configured	Add to configuration and repeat download
\$ 640 \$ 641	Initiated alarm message (No. x) not configured	Add to configuration and repeat download
\$ 645 \$ 649	Internal error	
\$ 650	Area pointer for function you used not configured	Configure area pointer
\$ 653	Configured user version number does not agree with that stored in PLC	Connect OP to correct PLC or correct CP module or adjust user version number
\$ 655	PLC acknowledgment area not physically in back of alarm message bit area (serious error, no startup)	Re-configure PLC → OP acknowledgment areas and repeat download

Message	Cause	Action
\$ 657	Configured PLC driver not supported by version of device you are using (serious error)	Change protocol for version of device you are using and repeat download configuration
\$ 659	Illegal variable in recipe no. x (string format)	Change configuration and transfer again.
\$ 660	Invalid destination configured for cross-jump in screen	Add to configuration and repeat download
\$ 662	Invalid destination configured for cross-jump in screen	Add to configuration and repeat download
\$ 664	Too many data records in the configuration file	Reduce configuration of the recipes.
\$ 702	Internal Error (actual value error)	
\$ 703	Internal Error (job faulty)	
\$ 704	Flash memory full	Limit configuration
\$ 705	Internal Error (S5 error)	
\$ 706	Internal Error (unknown message acknowledged)	
\$ 7xx	Internal errors	

www.rgbautomatyka.pl

Technical Data

C

OP5		OP15					
A1	A2	A1	A2	A1-VF	A2-VF	C1	C2

Housing		
• External Dimensions BxHxD	120x168x48 mm	240x168x48 mm
• Mounting cutout BxH	112x160 mm	230x158 mm
• Useful depth	Approx. 40 mm	
• Degree of protection (front/rear)	IP65/IP20	
• Weight	Approx. 0.8 kg	Approx. 1.1 kg

Processor	
• Type	V25
• Clock frequency	12 MHz

Memories	
• Flash memory for configuration data	128 KBytes
• SRAM working memory	128 KBytes
• EPROM Firmware	512 KBytes

Display				
• Type	LCD		VF	LCD
• Number of lines	4	2	2	4 (8)
• Characters per line	20	40	40	20 (40)
• Character height	5 mm	5 mm	5 mm	8 (4) mm

OP5		OP15					
A1	A2	A1	A2	A1-VF	A2-VF	C1	C2

Keyboard		
• Type	Membrane keyboard	
• Number of system keys	24	
• Number of LEDs	4	20
• Number of function keys	6	16
• Softkeys	4	8

Supply voltage		
• Rated voltage	24 VDC	
• Permissible range	18 to 30 VDC	
• Maximum permissible transients	35 V (500 ms)	
• Time between transients	min. 50 sec.	
• Power input		
Typically	180 mA	200 mA
Maximum	250 mA	300 mA
• Fuse	internal	

Backup battery ¹	
• Type	Lithium cell
• Voltage	3.6 V
• Capacity	1.5 Ah

¹ Subject to change

Authorization input	
• Inhibited	$U < 3.6 \text{ V}$ or open input
• Enabled	$15 \text{ V} < U < 30 \text{ V}$

OP5		OP15					
A1	A2	A1	A2	A1-VF	A2-VF	C1	C2

Ambient Conditions			
<ul style="list-style-type: none"> Ambient temperature, operation Vertical installation Horizontal installation Transportation, storage 	<p>0° C to 45° C</p> <p>0° C to 35° C</p> <p>-25° C to 70° C</p>	<p>0° C to 55° C</p> <p>0° C to 45° C</p> <p>-25° C to 70° C</p>	<p>0° C to 45° C</p> <p>0° C to 35° C</p> <p>-25° C to 70° C</p>
<ul style="list-style-type: none"> Relative humidity Operation Transportation, storage 	<p>≤ 95%, no condensation</p> <p>≤ 95%</p>		
<ul style="list-style-type: none"> Shock load Operation Transportation, storage 	<p>5 g/11 msec</p> <p>25 g/6 msec</p>		
<ul style="list-style-type: none"> Vibration Operation Transportation, storage 	<p>0.075 mm/1 g</p> <p>3.5 mm/1 g</p>		
<ul style="list-style-type: none"> Max. pressure difference (front, back) 	<p>2 hPa</p>		
<ul style="list-style-type: none"> Air pressure Operation Transportation, storage 	<p>706 to 1030 hPa</p> <p>581 to 1030 hPa</p>		

Interference Immunity (EN 50082-1)	
<ul style="list-style-type: none"> Static discharge (contact discharge) 	IEC 801-2 class 3
<ul style="list-style-type: none"> RF irradiation 	ENV 50140 class 3
<ul style="list-style-type: none"> Burst interference 	IEC 801-4 class 3
<ul style="list-style-type: none"> Pulse modulation 	ENV 50204

Interference Emission (EN 50081-1)	
<ul style="list-style-type: none"> RFI suppression level 	In accordance with VDE 0878, EN 55022

www.rgbautomatyka.pl

D

Interface Assignment

D.1 Interface Configuration

The table below shows the interface configuration of the different OPs. The numbers **1** to **3** indicate the pin assignment (refer to D.2).

Interface designation	OP Device Family							
	OP5 A1	OP5 A2	OP15 A1	OP15 A2	OP15 A1-VF	OP15 A2-VF	OP15 C1	OP15 C2
IF1A	1	1	–	–	–	–	–	–
IF1B	–	2 / 3	–	–	–	–	–	–
IF1	–	–	1	1	1	1	1	1
IF2A	–	–	1	1	1	1	1	1
IF2B	–	–	2	3	2	3	2	3

D.2 Pin Assignment

1: 15-pin sub-D socket

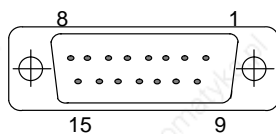

Pin	General	V.24	TTY
1	Protective conductor		
2			RxD–
3		RxD	
4		TxD	
5		CTS	
6			TxD+
7			TxD–
8	Protective conductor		
9			RxD+
10		RTS	
11			+20 mA
12	GND		
13			+20 mA
14	+5 Volt		
15	GND		

2: 9-pin sub-D socket

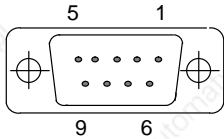

Pin	RS 422	RS 485
1		
2		
3	TxD (B)	Data B
4	RxD (B)	
5	GND	GND
6	+5 V	+5 V
7		
8	TxD (A)	Data A
9	TxD (A)	

3: 9-pin sub-D socket

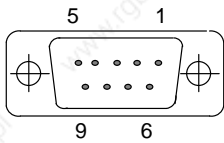

Pin	L2-DP/MPI/PPI
1	
2	
3	Data B (isolated)
4	
5	GND (isolated)
6	+5 V (isolated)
7	
8	Data A (isolated)
9	

ESD Guidelines

E

In this chapter

This chapter describes the most important precautions which must be taken to avoid damage to the electrostatically sensitive devices in the OP3.

E.1 What Does ESD Mean?

Electrostatically sensitive devices

Nearly all SIMATIC assemblies incorporate highly integrated MOS devices or components. For technological reasons, these electronic components are very sensitive to overvoltages and consequently therefore to electrostatic discharge.

These devices are known internationally as:

”ESD” (Electrostatic Sensitive Devices)

The German abbreviation for such devices is:

”EGB” (Elektrostatisch Gefährdete Bauelemente Baugruppen)

The following symbol on plates on cabinets, mounting racks or packages draws attention to the use of electrostatic sensitive devices and thus to the contact sensitivity of the assemblies concerned:

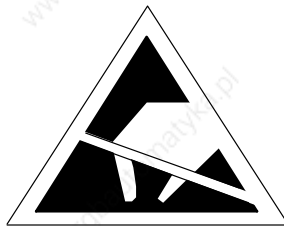

ESDs may be destroyed by voltages and energies well below the perception threshold of persons. Voltages of this kind occur as soon as a device or an assembly is touched by a person who is not electrostatically discharged. Devices exposed to such overvoltages cannot immediately be detected as defective in the majority of cases, since faulty behavior may occur only after a long period of operation.

E.2 Important Precautions against Electrostatic Discharge

Keep away from plastics

- Most plastics are capable of carrying high charges and it is therefore imperative that they not be placed near sensitive components.

Grounding

- When handling electrostatic sensitive devices, make sure persons, work-places and packages are properly grounded.

E.3 Handling ESD Assemblies

Rules for touching and environment

- A general rule is that assemblies should be touched only when this cannot be avoided owing to the work that has to be performed on them. If you have to touch them, under no circumstances should you handle printed circuit boards by touching device pins or circuitry.
- Devices may be touched only if
 - you are grounded by permanently wearing an ESD wrist strap or if
 - you are wearing ESD shoes or ESD grounding protection straps in conjunction with an ESD floor.
- Before you touch an electronic assembly, your body must be discharged. The simplest way of doing this is to touch a conductive, grounded object immediately beforehand – for example, bare metal parts of a switching cabinet, water pipe etc.).
- Assemblies should not be brought into contact with charge-susceptible and highly insulating materials, such as plastic films, insulating table tops and items of clothing containing synthetic fibers.
- Assemblies should be deposited only on conductive surfaces (tables with an ESD coating, conductive ESD cellular material, ESD bags, ESD shipping containers).
- Do not place assemblies near visual display units, monitors or television sets (minimum distance to screen > 10 cm).

E.4 Measuring and Modifying ESD Assemblies

Grounding the measuring instrument/soldering iron

- Measurements should only be made on assemblies when
 - the measuring instrument is grounded – for example, by means of a protective conductor or
 - the measuring head has been briefly discharged before measurements are made with a potential-free measuring instrument – for example, by touching a bare metal control cabinet.
- For soldering, you must use only a grounded soldering iron.

E.5 Shipping ESD Assemblies

Conductive packing

As a matter of policy, assemblies and devices should be stored and shipped only in conductive packing – for example, metallized plastic boxes, tin cans.

Should packing not be conductive, assemblies must be conductively wrapped before they are packed. You can use, for example, conductive foam rubber, ESD bags, domestic aluminum foil and paper (under no circumstances should you use plastic bags or foils).

Protecting/ covering battery connections

With assemblies containing fitted batteries, make sure that the conductive packing does not come into contact with or short-circuit battery connections; if necessary, cover battery connections beforehand with insulating tape or insulating material.

www.rgbautomatyka.pl

Siemens Worldwide

F

In this appendix

In this appendix you will find the following information.

- The location of Siemens offices in the Federal Republic of Germany
- All European and non European branches and representatives of Siemens AG

Ägypten Siemens Technical Office <ul style="list-style-type: none"> • Cairo-Mohandessin Siemens Technical Office <ul style="list-style-type: none"> • Alexandria EGEMAC S.A.E. <ul style="list-style-type: none"> • Cairo-Mattaria 	Australien Siemens Ltd. <ul style="list-style-type: none"> • Adelaide • Brisbane • Melbourne • Perth • Sydney
Äthiopien Addis Electrical Engineering Ltd. <ul style="list-style-type: none"> • Addis Abeba 	Bahrain Transitec Gulf <ul style="list-style-type: none"> • Manama
Algérien Siemens Bureau d'Alger <ul style="list-style-type: none"> • Alger 	Bangladesh Siemens Bangladesh Ltd. <ul style="list-style-type: none"> • Dhaka
Angola TECNIDATA <ul style="list-style-type: none"> • Luanda 	Belgien Siemens S.A. <ul style="list-style-type: none"> • Bruxelles • Liège
Argentinien Siemens S.A. <ul style="list-style-type: none"> • Bahía Blanca • Buenos Aires • Còrdoba • Mendoza • Rosario 	Siemens N. V. <ul style="list-style-type: none"> • Antwerpen
	Bolivien Sociedad Comercial é Industrial Hansa Ltda. <ul style="list-style-type: none"> • La Paz

Bophuthatswana	Bundesrepublik Deutschland
Siemens Ltd. • Mafekeng	<ul style="list-style-type: none"> • Aachen • Augsburg • Bayreuth • Berlin • Bielefeld • Bonn • Braunschweig • Bremen • Chemnitz • Darmstadt • Dortmund • Dresden • Duisburg • Düsseldorf • Erfurt • Essen • Frankfurt a.M. • Freiburg
Bosnien-Herzegowina	
Generalexport Predstavništvo Sarajevo • Sarajevo	
Brasilien	
Siemens S.A. <ul style="list-style-type: none"> • Belém • Belo Horizonte • Brasilia • Campinas • Curitiba • Fortaleza • Pôrto Alegre • Recife • Rio de Janeiro • Salvador de Bahia • São Paulo • Vitória 	<ul style="list-style-type: none"> • Hamburg • Heilbronn • Karlsruhe • Kassel • Kempten/Allg. • Kiel • Koblenz • Köln • Konstanz
Brunei	
• Brunei Darussalam	
Bulgarien	
Siemens AG, Vertretung in Bulgarien • Sofia	<ul style="list-style-type: none"> • Laatzten • Leipzig • Lingen • Magdeburg • Mainz • Mannheim • München • Münster/Westf. • Nürnberg

<ul style="list-style-type: none"> • Osnabrück • Regensburg • Rostock • Saarbrücken • Siegen • Stuttgart • Ulm • Wetzlar • Wilhelmshaven • Wuppertal • Würzburg 	<p>Frankreich</p> <p>Siemens S.A.</p> <ul style="list-style-type: none"> • Haguenau • Lille, Seclin • Lyon, Caluire-et-Cuire • Marseille • Metz • Paris, Saint-Denis • Strasbourg • Toulouse
<p>Chile</p> <p>INGELSAC</p> <ul style="list-style-type: none"> • Santiago de Chile 	<p>Griechenland</p> <p>Siemens A.E.</p> <ul style="list-style-type: none"> • Athen, Amaroussio • Thessaloniki
<p>Costa Rica</p> <p>Siemens S.A.</p> <ul style="list-style-type: none"> • Panama • San José 	<p>Großbritannien</p> <p>Siemens plc</p> <ul style="list-style-type: none"> • Birmingham, Walsall • Bristol, Clevedon • Congleton • Edinburgh • Glasgow • Leeds • Liverpool • London, Sunbury-on-Thames • Manchester • Newcastle
<p>Cypern</p> <p>GEVO Ltd. oder Jolali Ltd.</p> <ul style="list-style-type: none"> • Nicosia 	<p>Guatemala</p> <p>Siemens S.A.</p> <ul style="list-style-type: none"> • Ciudad de Guatemala
<p>Dänemark</p> <p>Siemens A/S</p> <ul style="list-style-type: none"> • Koebenhavn, Ballerup 	<p>Honduras</p> <p>Representaciones Electroindustriales S de R.L. – Relectro</p> <ul style="list-style-type: none"> • Tegucigalpa
<p>Ecuador</p> <p>Siemens S.A.</p> <ul style="list-style-type: none"> • Quito 	<p>Hong Kong</p> <p>Siemens Ltd.</p> <ul style="list-style-type: none"> • Hong Kong
<p>Elfenbeinküste</p> <p>Siemens AG</p> <ul style="list-style-type: none"> • Abidjan 	
<p>El Salvador</p> <p>Siemens S.A.</p> <ul style="list-style-type: none"> • San Salvador 	
<p>Finnland</p> <p>Siemens Oy</p> <ul style="list-style-type: none"> • Espoo, Helsinki 	

Indien	Kanada
Siemens Limited <ul style="list-style-type: none"> • Ahmedabad • Bangalore • Bombay • Calcutta • Madras • New Delhi • Secúnderabad 	Siemens Electric Ltd. <ul style="list-style-type: none"> • Montreal, Québec • Toronto
Indonesien	Katar
P.T. Siemens Indonesia, P.T. Siemens Dian-Grana Elek- trika, Representative Siemens AG <ul style="list-style-type: none"> • Jakarta 	Trags Electrical Engineering and Air Conditioning Co. <ul style="list-style-type: none"> • Doha
Irak	Kolumbien
Samhiry Bros. Co. Limited oder Siemens AG (Iraq Branch) <ul style="list-style-type: none"> • Baghdad 	Siemens S.A. <ul style="list-style-type: none"> • Barranquilla • Bogotá • Cali • Medellín
Iran	Korea
Siemens S.S.K. <ul style="list-style-type: none"> • Teheran 	Siemens Ltd. <ul style="list-style-type: none"> • Changwon • Seoul • Ulsan
Irland	Kroatien
Siemens Ltd. <ul style="list-style-type: none"> • Dublin 	Siemens d. o. o. <ul style="list-style-type: none"> • Zagreb
Island	Kuba
Smith & Norland H/F <ul style="list-style-type: none"> • Reykjavik 	Respresentación Consult iva EUMEDA <ul style="list-style-type: none"> • La Habana
Italien	Kuwait
Siemens S.p.A. <ul style="list-style-type: none"> • Bari • Bologna • Brescia • Casoria • Firenze • Genova • Milano • Padova • Roma • Torino 	National & German Electrical and Electronic Services Co. (NGEECO) <ul style="list-style-type: none"> • Kuwait, Arabia
Japan	Libanon
Siemens K.K. <ul style="list-style-type: none"> • Tokyo 	Ets. F.A. Kettaneh S.A. <ul style="list-style-type: none"> • Beyrouth
	Libyen
	Siemens AG, Branch Libya <ul style="list-style-type: none"> • Tripoli
	Luxemburg
	Siemens S.A. <ul style="list-style-type: none"> • Luxembourg
	Malaysia
	Siemens Electrical Engineering Sdn. Bhd. <ul style="list-style-type: none"> • Kuala Lumpur

Malta	Norwegen
J. R. Darmanin & Co. Ltd. • Valletta	Siemens A/S • Bergen • Oslo • Stavanger • Trondheim
Marokko	Österreich
SETEL Société Electrotechnique et de Télécommunications S.A. • Casablanca	Siemens AG Österreich • Bregenz • Graz • Innsbruck • Linz • Salzburg • Wien
Mexiko	Oman
Siemens S.A. de CV • Culiacán • Gómez Palacio • Guadalajara • León • México, D.F. • Monterrey • Puebla	Waleed Associates • Muscat
Moçambique	Pakistan
Siemens Liaison Office • Maputo	Siemens Pakistan Engineering Co., Ltd. • Islamabad • Karachi • Lahore • Peshawar • Quetta
Namibia	Paraguay
Siemens (Pty.) Ltd. • Windhoek	Rieder & Cia. S.A.C.I. • Asunción
Nepal	Peru
Amatya Enterprises (Pvt.) Ltd. • Kathmandu	Siensa • Lima
Neuseeland	Philippinen
Siemens Ltd. • Auckland • Wellington	Maschinen & Technik Inc. (MATEC) • Manila
Nicaragua	Polen
Siemens S.A. • Managua	Siemens GmbH • Gdansk-Letnica • Katowice • Warszawa
Nigeria	
Electro Technologies Nigeria Ltd. (ELTEC) • Lagos	
Niederlande	
Siemens Nederland N.V. • Den Haag • Rijswijk	

Portugal	Simbabwe
Siemens S.A. <ul style="list-style-type: none"> • Albufeira • Coímbra • Lisboa, Amadora • Matosinhos • Porto 	Electro Technologies Corporation (Pvt.) Ltd. (ETC) <ul style="list-style-type: none"> • Harare
Rumänien	Singapur
Siemens birou de consultatii tehnice <ul style="list-style-type: none"> • Bucuresti 	Siemens (Pte.) Ltd. <ul style="list-style-type: none"> • Singapore
Rußland	Slowakische Republik
Siemens AG oder Mosmatic <ul style="list-style-type: none"> • Moskau Siemens AG <ul style="list-style-type: none"> • Ekaterinburg 	Siemens AG <ul style="list-style-type: none"> • Bratislava
Rwanda	Slowenien
Etablissement Rwandais <ul style="list-style-type: none"> • Kigali 	Siemens d. o. o. <ul style="list-style-type: none"> • Ljubljana
Sambia	Spanien
Electrical Maintenance Lusaka Ltd. <ul style="list-style-type: none"> • Lusaka 	Siemens S.A. <ul style="list-style-type: none"> • Barcelona • Bilbao • Gijón • Granada • La Coruña • Las Palmas de Gran Canaria • León • Madrid • Málaga • Murcia • Palma de Mallorca • Pamplona • Sevilla • Valencia • Valladolid • Vigo • Zaragoza
Saudi-Arabien	Sri Lanka
Arabia Electric Ltd. (Equipment) <ul style="list-style-type: none"> • Al-Khobar • Jeddah • Riyadh 	Dimo Limited <ul style="list-style-type: none"> • Colombo
Schweden	Sudan
Siemens AB <ul style="list-style-type: none"> • Göteborg • Jönköping • Malmö • Sundsvall • Upplands Väsby, Stockholm 	National Electrical & Commercial Company (NECC) <ul style="list-style-type: none"> • Khartoum
Schweiz	
Siemens-Albis AG <ul style="list-style-type: none"> • Basel • Bern • Zürich Siemens-Albis S.A. <ul style="list-style-type: none"> • Renens, Lausanne 	

Südafrika	Tunesien
Siemens Ltd. • Cape Town • Durban • Johannesburg • Middelburg • Newcastle • Port Elizabeth • Pretoria	Sitelec S.A. • Tunis
Swaziland	Ukraine
Siemens (Pty.) Ltd. • Mbabane	Siemens AG • Kiew
Syrien	Ungarn
Siemens AG, Branch (A.S.T.E.) • Damascus	Siemens Kft • Budapest
Taiwan	Uruguay
Siemens Ltd., TELEUNION Engineering Ltd. oder TAI Engineering Co., Ltd. • Taichung • Taipei	Conatel S.A. • Montevideo
Tanzania	Venezuela
Tanzania Electrical Services Ltd. • Dar-es-Salaam	Siemens S.A. • Caracas • Valencia
Thailand	Vereinigte Arabische Emirate
Berti Jucker Co. Ltd. • Bangkok	Electro Mechanical Co. oder Siemens Resident Engineers • Abu Dhabi Scientechnic oder Siemens Resident Engineers • Dubai
Tschechische Republik	Vereinigtes Staaten von Amerika
Siemens AG • Brno • Mladá Boleslav • Praha	Siemens Energy & Automation Inc. Automation Division • Alpharetta, Georgia Numeric Motion Control • Elk Grove Village, Illinois
Türkei	Vietnam
SIMKO • Adana • Ankara • Bursa • Istanbul • Izmir • Samsun	OAV Representative Office • Hanoi
	Volksrepublik China
	Siemens AG Representation • Beijing • Guangzhou • Shanghai

Yemen (Arab. Republik)	Zaire
Tihama Tractors & Engineering Co., Ltd. oder Siemens Resident Engineers <ul style="list-style-type: none">• Sanaa	SOFAMATEL S.P.R.L. <ul style="list-style-type: none">• Kinshasa

Glossary

A

Alarm message Draws attention to particularly urgent operating states; alarm messages have to be acknowledged for this reason.

Area pointer Required for enabling data transfer between the OP and the PLC. It contains details of the location and size of data areas in the PLC.

Arrival of a message The time at which a message is initiated by the PLC or OP.

Authorization input (AE) External access to superuser password level.

B

Blanking Clearance of the display and representation of operating readiness by means of a block in character size running across the screen.

C

Configuration Definition of system-specific basic settings, messages and screens using COM TEXT configuration software.

D

Departure of a message The time at which a message is withdrawn by the Programmable Logic PLC

Display function Function resulting in the contents of the display being changed – for example, "Display message level", "Display alarm buffer" and "Display process screen".

Download mode Operating mode of the OP in which data are transferred from the Programming Unit to the OP or vice versa.

Duration of display Time between the arrival of an event message and its departure.

E

Event message Draws attention to specific operating states in the machine or system connected to the PLC.

F

Fault time The time between the arrival and departure of an alarm message.

Flash memory Programmable memory which can be deleted quickly and then re-written.

Fields "Placeholders" in configured or permanent text, used to output and/or input certain values.

Forced printout Automatic printouts of alarm or event messages that are deleted upon a buffer overflow.

H

Hardcopy Output of display contents to an attached printer.

I

Information text Additional, configurable information about messages, screens, screen entries and selection fields.

L**Loop-through mode**

Operating mode of OP15. Includes normal operation and also permits communication between the PU or PC and the PLC through the second interface of the OP15. This operating mode is possible only when the interface to the PLC is established by means of the AS511 protocol.

M**Message level**

OP control level at which initiated messages are displayed.

Message logging

Configurable printout of alarm and event messages concurrently with output on display.

N**Normal mode**

OP operating mode in which messages are displayed and screens can be manipulated.

O**Output field**

Field for displaying an actual value.

P**Password
Password level**

To use a protected function, it is necessary to enter a Password identifying a given password level. A password level defines the permissions of an operator. The requisite password level is preset by means of configuration and can range from 1 (the lowest level) to 9 (the highest level).

PLC job

Initiation of a function by the PLC.

S

Screen	Form of display for associated process data, which can be shown together on the OP and modified individually.
Screen entry	Element of a screen; consists of text, variables and soft keys.
Screen level	Editing level of the OP at which screens can be viewed and manipulated.
Selection field	Field for setting values of parameters (one of several defined values can be selected).
Soft keys	Keys that can be assigned with different functions (depending on displayed screen entry).
Startup test	Check on the status of the central processing unit and memories each time the supply voltage is applied.
System message	Draws attention to internal conditions on the OP and the PLC.

Index

A

- Access, 6-1
- Acknowledge, alarm messages, 7-3
- Acknowledge key, 4-2
- Acknowledgment groups, 7-4
- Alarm buffer, 7-2
 - delete automatically , 7-12
 - view, 7-9
- Alarm message text, view, 7-8
- Alarm messages, 1-3, 7-2
 - acknowledge, 3-2, 7-3
 - delete, 7-12, A-1
 - display, 3-2
 - display text, A-1
 - forced printout, 7-13
 - maximum length, 2-1
 - maximum number , 2-1
 - number, A-1
 - overflow, A-1
 - print, A-1
 - suppress, 7-4
 - unacknowledged, 3-2
 - view, A-1
- Arrived message, 7-2
- Arrow keys, 4-3
- Assigning, terminal block, 15-3
- Attaching the OP, 14-1
- Authorization input, 6-1, 6-2, 15-3, C-2

B

- Backup battery, C-2
 - monitoring, 19-1
 - replacing, 20-1, 20-2
- Basic functions, 1-3
- Basic screen, 3-5
- Battery monitoring, 19-1
- BATTERY TEST, 19-2
- Blank, entering, 4-2
- Branch
 - in standard screens, 3-5
 - with soft keys, 11-1
- Brightness, 10-3

- Buffer overflow, 7-12, 7-13

C

- Cabinet setup, 15-2
- Cables, interference-proof, 15-2
- Cancel, 4-4
- Capacity of backup battery, C-2
- Change of operating level, 3-2
- Character, deleting, 4-2
- Character height, on display, 2-1
- Characters, number per line , 2-1
- Characters A-F, input, 4-8
- Chassis ground, 15-4
- Choice, of screens, 5-3
- Chronological, 7-15
- Cleaning, keyboard and display, 20-1
- Clock frequency, C-1
- CLOCK TEST, 19-2
- Combined I/O fields, 5-2
- Combined message display, 7-7
- Commissioning, 16-1, 16-2
- Communication methods, 2-3
- Configurable languages, 2-2
- Configuration, 1-1
 - download, 16-2, 16-3
 - testing, 16-5, 16-6
- Configuration computer, 16-2
- Configuration phase, 1-1
- Configuration software, 1-1
- Connecting, 15-5
 - configuration computer, 15-5
- Connection, attaching a printer, 18-1
- Connection configuration scheme, 15-5, 15-6, 18-1
- Connection elements
 - OP15, 17-4
 - OP5, 17-2
- Connection types, 15-6, 17-2, 17-4
- Continuous current, 15-4
- Contrast, 2-1, 4-2
- Control functions, 1-3
- CPU TEST, 19-2

Cross-jump destination, 5-1

D

Data record name, 8-3, 8-10

Data Records

Copying, Transferring, 8-8

Directory, Deleting, 8-11
setting up, Editing, 8-5

Data records, 1-4

Copying, 8-7

Printing, 8-3, 12-2

Storing, 8-6

Date, 10-3, 13-2, A-2

Decimals, 4-7

Degree of protection, C-1

Delete

alarm buffer, 7-12

alarm messages, A-1

event buffer, 7-13

event messages, A-1

system message buffer, 7-13

DELETE key (OP5/OP15), 4-2

Departed message, 7-2

Design, OP5, OP5/A2, 1-6

Device description

OP15, 17-3

OP5, 17-1

Dimensions, C-1

Direct adjustment, display contrast, 10-3

Direct message logging, 7-14

Directory, screens, 1-3, 5-3

Directory key, 4-2, 5-3

Display

adjusting contrast, 10-3

alarm message, 3-2

messages, 7-6

operands, 9-1

size, 2-1

technology, 2-1

type, C-1

Display first message, 10-2

Display functions, 1-3

Display last message, 10-2

Display priorities, 7-6, 7-7

Display priority, 1-4, 7-5

Display sequences, 7-7

DISPLAY TEST, 19-3

Displaying password list, 6-3

Download, 10-4

Download mode, 10-4, 16-2, 16-4

Driving LEDs, 11-2

E

Edit, screen, 5-4, A-1

Electrical Installation, 15-1

ENTER key, 4-2

Entry text, 5-2

EPROM, Firmware, C-1

EPROM TEST, 19-2

ESCAPE key, 4-2, 4-4

Evaluation of screen number, 13-1

Event buffer, 7-2

delete automatically, 7-13

view, 7-10

Event message text, view, 7-8

Event messages, 1-3, 7-2

delete, 7-12, A-1

display text, A-1

maximum length, 2-1

maximum number, 2-1

number, A-1

overflow, A-1

print, A-1

view, A-1

Events, 7-3

Extended character set, 4-8

External floppy disk station, 17-6

F

Field inputs, canceling, 4-4

Fields, 5-2

date, 5-2

I/O fields, 5-2

PLC actual value, 5-2

PLC setpoint, 5-2

time, 5-2

Firmware, 16-2

First value, 7-6

Flash memory, C-1, Glossary-2

FLASH TEST, 19-2

Flashing, 7-2

Floppy disk station

Connection, 17-6

Connection and setting elements, 17-7

Functions, 17-6

Printer operation, 17-6

Use, 17-6

FORCE VAR, 9-1, A-2

Forced printout, 7-13, 7-14

Front panel, 14-1

Full printout, 7-14

Function key, LED, 11-2

Function keyboard
 OP15, 1-8
 OP5, 1-6
Function keyboard image, 13-1
Function keys, 5-3, 11-1, C-2
 labeling, 17-5
 number, 2-2
Functionality, overview, 2-1
Functions
 calling, 3-6
 of OP, 1-3, 2-1

G

Glossary, Glossary-1
Grounding, 15-2
Grounding rail, 15-2

H

HARDCOPY key, 4-3
Hardware setup, interference-proof, 15-2
Hardware test, 19-1
HELP key, 4-3
Help LED, 4-5
Hide, system message, 4-4
Housing, C-1

I

I/O fields, 5-2
Incorrect input, canceling, 4-6
Information text, 1-4, 2-2, 4-5
Initial startup, 16-1, 16-2
Initialization, 16-4
Input
 canceling, 4-4
 left-justified, 4-7
 right-justified, 4-7
Input fields, 5-2
Input of alphanumeric values, 4-6
Input of numerical values, 4-6
Input of symbolic values, 4-6
Input, alphanumeric values, 4-8
Input, numerical values, 4-7
Input, symbolic values, 4-9
INSERT key (OP5/OP15), 4-2
Installation
 electrical, 15-1
 interference-proof, 15-2
 mechanical, 14-1

Interface configuration, D-1
Interface parameters, modify, 10-2
Interfaces
 OP15, 1-8
 OP5, 1-6
Interference signals, 15-2
Interference-proof installation, 15-2
Internal errors, A-1, A-11

K

Key, second function, 4-1
Key combination
 for Download mode, 16-3
 for hardware test, 19-1
Keyboard, 4-1, C-2
KEYBOARD TEST, 19-3
Keys
 acknowledge key, 4-2
 arrow keys, 4-3
 Contrast control, 4-2
 DELETE key (OP5/OP15), 4-2
 DIR, 5-3
 directory key, 4-2
 ENTER key, 4-2
 ESCAPE key, 4-2, 4-4
 HARDCOPY key, 4-3
 HELP key, 4-3
 INSERT key (OP5/OP15), 4-2
 numeric keys, 4-2
 SHIFT key, 4-1
 sign key, 4-2

L

Labeling of function keys, 17-5
Labeling strips, 17-5
Language, A-2
Language selection, 10-1
Languages, 1-5
Last value, 7-6
LCD
 OP15, 1-8
 OP5, 1-6
LED, 11-2
 acknowledgment, 4-2
 delete, 4-2
 Help, 4-3
 information text, 4-3
 insert, 4-2
 Number, C-2

- LED control, 13-1
- LED driving, 11-2
- Left-justified input, 4-7
- Limit-value check, 4-7
- Lines, number on display , 2-1
- Lock switch, 15-3
- Login, 6-2, A-2
 - automatic, 6-2
- Logout, 6-2, A-2
- Loop-through mode, 10-4, 15-7, 16-6
 - constraints, 15-7
 - particularities, 15-8

M

- Maintenance, 20-1
- Mechanical installation, 14-1
- Membrane keyboard, C-2
- Memories, C-1
- Message
 - arrived, 7-2
 - chronological, 7-15
 - departed, 7-2
 - display priority, 7-7
 - together, 7-15
- Message bit procedure, 7-2
- Message buffer, 7-2
 - print, 7-15
 - view, 7-9
- Message display, 10-2
 - separate, 7-7
 - together, 7-7
- Message handling, 7-1
- Message level, 3-1
- Message log, 7-14
- Message number, A-1
- Message priorities, 7-6
- Message text, 7-8
- Message, first, display, 7-6
- Message, last, display, 7-6
- Messages
 - delete, 7-12
 - displaying, 7-6
 - print, 7-14
 - scroll (message level), 7-8
- Mode
 - Download, 10-4
 - Loop-through, 10-4
 - Offline, 10-4
 - Online, 10-4
- Modes, 10-4

- Modify
 - interface parameters, 10-2
 - operands, 9-1
 - screen, 5-4
- Monitoring
 - battery, 19-1
 - voltage, 19-1
- Monitoring functions, 19-1
- Mounting cutout, 14-1, C-1
- Mounting dimensions
 - OP15, 17-3
 - OP5, 17-1

N

- Normal operation, 16-1
- Notes to operators, 7-2
- Number
 - alarm messages, A-1
 - event messages, A-1
- Numeric keys, 4-2

O

- Offline, 10-4, 16-5
- Offline mode, 10-4
- Online, 10-4
- Online mode, 10-4
- OP functions
 - miscellaneous, 1-3
 - overview, 2-1
- OP modes, 10-4, A-2
- OP15, 1-7
 - design, 1-7
 - function keyboard, 1-8
 - interfaces, 1-8
 - LCD , 1-8
 - soft keys, 1-8
 - system keyboard, 1-8
 - vacuum fluorescence display , 1-8
 - versions, 1-7
- OP5
 - design, 1-6
 - function keyboard, 1-6
 - interfaces, 1-6
 - LCD , 1-6
 - soft keys, 1-6
 - system keyboard, 1-6
 - versions, 1-6
- Operand list, 9-1

Operands, modify, 9-1
Operating level, forced change, 3-2
Operating level, changing, by key, 3-2
Operating levels, 3-1
Operating modes, A-2
Operator Guidance, process-dependent, 11-1
Order of deletion, alarm messages, 7-13
Output field, 5-2
Overflow
 alarm messages, A-1
 event messages, A-1
Overflow warning, 7-3, 7-13
Overheating, prevention, 14-1

P

Password
 change, 6-3
 edit, A-2
 format, 6-3
Password level, A-1
 change, 6-3
Password levels, 6-1
Password list, 6-3
Password management, 6-3, A-2
Password protection, 6-1
PC, 16-2
Pin assignment, D-1
PLC actual value, 5-2
PLC job, 5-3
PLC jobs, 13-1
PLC setpoint, 5-2
Power input, 15-4, C-2
Power supply, 15-4
Print
 alarm messages, A-1
 event messages, A-1
 message buffer, 7-15
 messages, 7-14
 screens, 5-4, A-1
Print functions, 15-7, 18-1
Printer
 attaching a printer, 18-1
 set parameters, A-2
 settings, 18-1
Printout, 1-4
Priorities, display, 7-7

Priority
 display priority, 7-6
 message priority, 1-4
Process control phase, 1-1
Process-dependent operator guidance, 11-1
Processor type, C-1
Programming unit, 16-2
ProTool/Lite, 1-1
PU, 16-2
PU functions, 9-1
 FORCE VAR, 9-1, A-2
 STATUS VAR, 9-1, A-2

R

RAM TEST, 19-2
Rated voltage, 15-4, C-2
Recipe directory, 8-3
Recipe title, 8-3
Recipes, 1-4, 2-2, 8-1
Remaining buffer space, 7-3
Repeat function, 4-3
Replacing labeling strips, 17-5
Restart, 16-1, 16-2
Right-justified input, 4-7

S

S5
 data formats, 9-3
 operand, 9-3
 ranges of values, 9-3
Scheduler times, 2-2
Schedulers, 12-1
 Activated, 12-2
 Changed, 12-2
 Deactivated, 12-2
 Functions, 12-2
Schedulers time, 12-1
Schedulers times, 12-2
Screen, Glossary-4
Screen entries, 5-1, 5-2
Screen hierarchy, 3-1, 11-2
Screen level, 3-1, Glossary-4
Screen number, 5-1
 evaluate, 13-1

- Screen segment, move, 3-5
- Screen title, 5-1
- Screen updating, 5-2
- Screening, 15-2
- Screens, 1-3, 5-1
 - choice, 5-3
 - choosing, 3-6
 - directory, 1-3
 - edit, A-1
 - editing, 5-4
 - maximum number, 2-2
 - print, A-1
 - printing, 5-4
- Screw type hooks, 14-1, 14-2
- Scrolling, in messages (message level), 7-8
- Self test, 16-4
- Setting bits, 11-2
- Setup guidelines, 15-2
- SHIFT key, 4-1
- Shift Lock position, 4-1
- Shorting plug, 19-2
- Sign key, 4-2
- SIMATIC S7, STATUS/FORCE VAR, 9-1
- Single display, 7-7
- Soft key, setting bits, 11-2
- Soft keys, 3-5, 5-2, 5-3, 11-1
 - number, 2-2
 - OP15, 1-8
 - OP5, 1-6
- Softkeys, C-2
- SPC TEST, 19-3
- Standard cables, 15-6
- Standard screens, 3-1, 3-3, 10-1
 - branching in screen hierarchy, 3-5
- Standby message, 7-3
- Start screen, 11-2
- Start-up Behavior, 16-4
- Status messages, 7-2
- STATUS VAR, 9-1, A-2
- Superuser, 6-1
- SUPPLEMENTARY FUNCTION TEST, 19-3
- Supply voltage, C-2
- Suppress, alarm messages, 7-4
- System keyboard
 - OP15, 1-8
 - OP5, 1-6
- System keyboard image, 13-2
- System keys, C-2
- System message, hide, 4-4

- System message buffer
 - delete, 7-13
 - display, A-2
 - view, 7-11
- System message buffer , 7-5
- System messages, 7-5
 - inhibit, 7-5
- System settings, 10-1
 - display messages, A-2
 - interface parameters, A-2
 - OP mode, A-2
 - printer parameters, A-2
 - select language, A-2
 - Set date and time, A-2

T

- Technical data, C-1
- Terminal block
 - assigning, 15-3
 - location, 17-2, 17-4
- Test
 - Battery, 19-2
 - clock, 19-2
 - CPU, 19-2
 - Display, 19-3
 - EPR0M, 19-2
 - Flash-Memory, 19-2
 - keyboard, 19-3
 - RAM, 19-2
 - SPC, 19-3
 - supplementary functions, 19-3
 - TTY/V.24, 19-2
- Test functions, 19-1
- Testing the configuration
 - in Offline mode, 16-5
 - with PLC, 16-6
- Text attributes, 18-2
- Threaded spindles, 14-2
- Time, 10-3, 13-2
 - set, A-2
- Title, screen, 5-1
- Together, 7-15
- Transfer screen, 8-8
- Transients, C-2
- TTY/V.24 test, 19-2

U

Useful depth, C-1

V

Vacuum fluorescence display, OP15, 1-8

Value, input, 4-6

Value, input, symbolic, 4-6

Values, entering numerical, 4-7

Values, input, numerical, 4-6

Values, input, alphanumeric, 4-6

Versions

OP15, 1-7, 17-3

OP5, 1-6, 17-1

Versions of device, 17-3

OP15, 17-3

OP5, 17-1

View

alarm buffer, 7-9

alarm message text, 7-8

alarm messages, A-1

event buffer, 7-10

event message text, 7-8

event messages, A-1

message buffer, 7-9

system message buffer, 7-11

Voltage monitoring, 19-1

Voltage range, 15-4

W

Watchdog, 19-3

Weight, C-1

Working memory, C-1

Y

Y cable, 18-1

www.rgbautomatyka.pl