

Universal current transducer - MCR-SL-CUC-400-I - 2308072

Technical data

General

Test voltage input/power supply	3.5 kV (50 Hz, 1 min.)
Noise emission	EN 61000-6-4
Noise immunity	EN 61000-6-2
Color	green
Housing material	Frianyl B63 V0 GV30
Conformance	CE-compliant
UL, USA/Canada	UL/C-UL listed UL 508

Standards and Regulations

Noise emission	EN 61000-6-4
Noise immunity	EN 61000-6-2
Conformance	CE-compliant
UL, USA/Canada	UL/C-UL listed UL 508

Conformance/approvals

Designation	CE
Identification	CE-compliant
Designation	UL, USA/Canada
Identification	UL/C-UL Listed UL 508

Environmental Product Compliance

China RoHS	Environmentally Friendly Use Period = 25;
	For details about hazardous substances go to tab "Downloads", Category "Manufacturer's declaration"

Drawings

Universal current transducer - MCR-SL-CUC-400-I - 2308072

Dimensional drawing

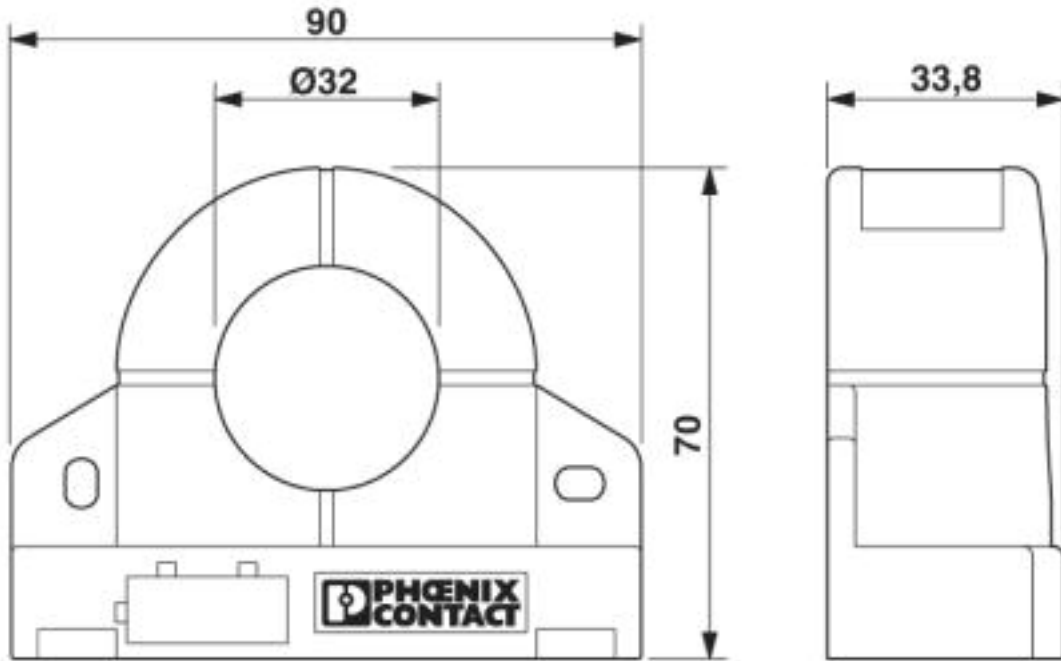

Circuit diagram

