

HD-3810E-1

OPERATION MANUAL



***580 SERIES CONTROLLER
TEACH PENDANT***

Hirata
World Leader in Production Technology

Hirata
World Leader in Production Technology

The information contained herein is the property of Hirata Corporation and shall not be reproduced in whole or in part without prior written approval of Hirata Corporation. The information contained herein is subject to change without notice and should not be construed as a commitment by Hirata Corporation.

Hirata Corporation assumes no responsibility for any errors or omissions in this document.

Warranty

All of Hirata's products which is passed our formal inspection test shall be guaranteed against faults due to the negligence of Hirata for either earlier period of one year or four thousand hours of operation from the day of shipment from Hirata Factory.

This warranty shall be applicable to the parts replacement and/or labor for repair in our factory and transportation cost shall not be applied.

We will charge the repair of faults caused by the following reasons:

- * Wrong usage which are prohibited in the instruction manual.
- * After the expiration of guarantee period.
- * Earthquake, fire, riot, violence, war and other force majeure.
- * Modification, repair or adjustment is performed by unauthorized person.

Contact your sales agent for individual warranty coverage.

580 Series Controller Teach Pendant
Operation Manual (HD-3810E-1)

Copyright 1998 by Hirata Corporation All right reserved.
First published in October 1998
First revision in June 1999
Printed in Japan
Hirata Corporation

Tokyo Head Quarters
3-9-20 Togoshi, Shinagawa, Tokyo 142-0041 JAPAN
Phone (03) 3786-1226
Facsimile (03) 3786-1264





Robotics Division
1016-6 Kusuno, Kumamoto 861-5511 JAPAN
Phone (096) 245-1333
Facsimile (096) 245-0816

Notations

1 Dangers, Warnings, Cautions, and Notes

There are four levels of special notations are used in this manual.

Table 1 Special Notation List

Notation	Description
 DANGER	If the actions indicated by a DANGER are not complied with, sever injury or death could result.
 WARINIG	If the actions indicated by a WARNING are not complied with, injury or major equipment damage could result.
 CAUTION	If the action specified by the CAUTION is not complied with, damage to your equipment could result.
 NOTE	A NOTE provides supplementary information, emphasizes a point or procedure, or gives a tip for easier operation.

2 Message, Menu, LED, and Keys

There are four more types of notations are used in this manual.







Table 2 The Other Types of Notation List

Notation	Description
“Message”	It describes the message on the Teach Pendant inside of “ ”.
「Menu」	It describes the menu on the Teach Pendant inside of 「 」.
『LED』	It describes the monitor LED on the Teach Pendant inside of 『 』 (e.g., the 『SHIFT』 LED)
	It describes keys on the Teach Pendant.

3 Key Operation

Following table describes notations for the key operation.

Table 3 Key Operation Notation List

Notation	Description
	It describes sigle key you need to press. (In this case, press the  key)
 + 	It describes 2 keys you need to press simultaneously. (In this case, press the  key while pressing the  key.)

CHAPTER 1 About This Manual and Notice

This manual is quick start guide manual for Hirata HNC-580 series robot controller. This controller is designed to control SCARA (Hirata AR series : horizontal multi-articulated type) and Cartesian manipulators.

The Hirata robot operating system is configured as in the following figure.

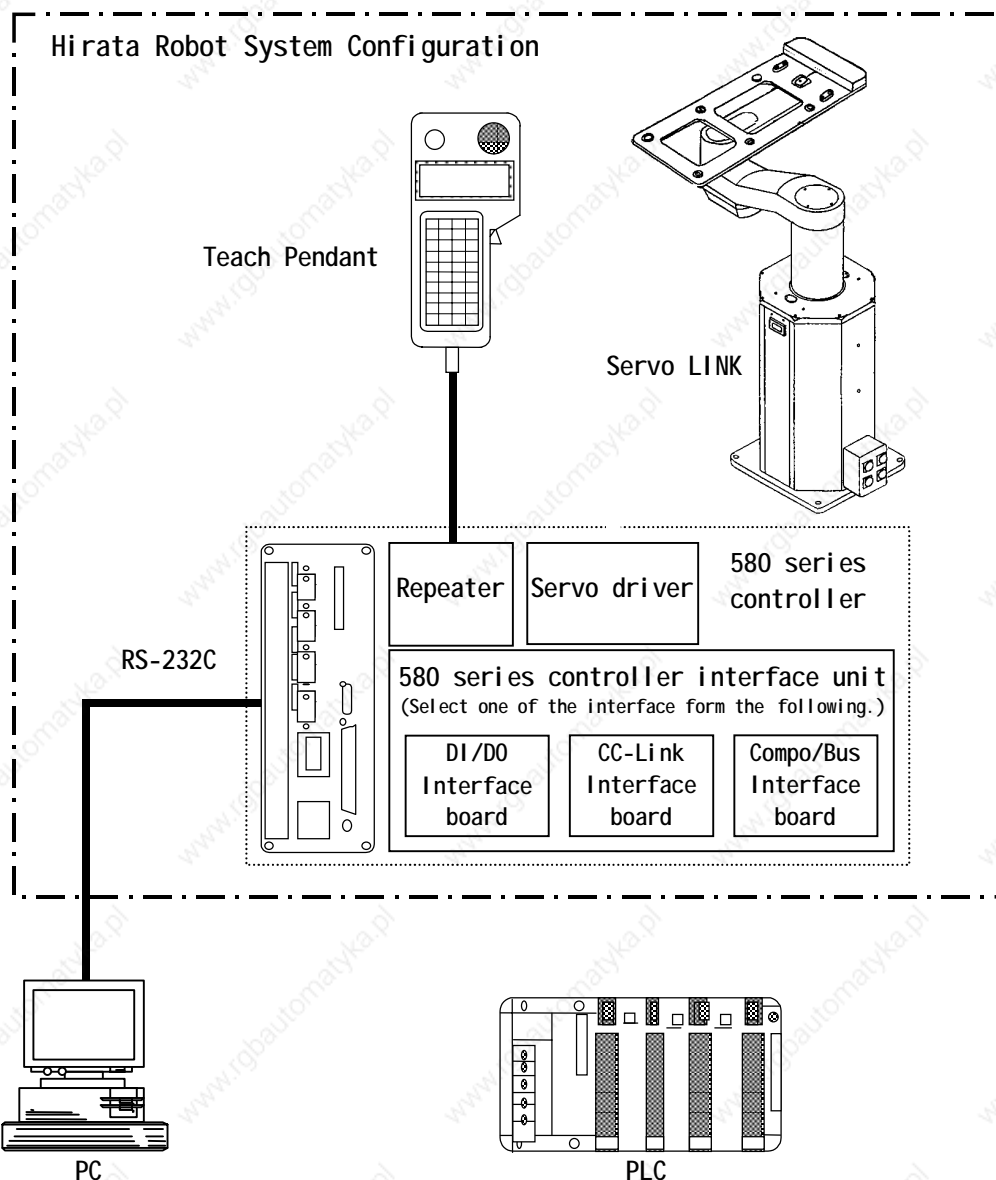

Fig. 1.1 Hirata Robot System Configuration

The basic outline for setting up the robot system is described in this chapter. It may differ depending on robot and controller type.

(1) External cables

Power cable, servo LINK cable, Motor line, etc.

(2) E.S. release

- Check if the Deadman switch is not pressed in TEACH or CHECK mode when the power is ON.
- Check if the E.S. switch on the Teach Pendant is pressed when the power is ON.
- Check if the E.S. connectors on the controller are opened.
- Check if the DC24 fuse is blown.

Refer to separate volume, "Robot Controller Users Guide, Emergency Stop (E.S.) Functions" for details.

(3) A-CAL

Refer to Chapter 3, "A-CAL (Automatic Calibration)" for details.

(4) Teaching

Before the robot starts automatic operation, it is required to pre-teach the operating positions.

The Hirata robot operating system can accept following methods to teach the robot position.

- Enter the coordinate manually via key pad on the Teach Pendant.
- MDI (Manual Data Input). Move the robot physically and store the position (hereinafter referred to as "Teaching").
- Off-line teaching. Data transfer via memory card or RS-232C.
- Data transfer via HR editor ¹.

After teaching positions to the robot, check to see that the robot moves to the taught position correctly. Then, automatic operation is performed by transmitting signals with external devices.

Using the Teach Pendant, the robot data, which called "system data", can be entered. Input and output operations can be performed.

Refer to Chapter 5, "TEACH Mode" for details.

¹: Refer to separated volume, "HR Editor Operation Manual."

(5) Check

- Set the conditions of robot operations using System Parameters. Speed, Acceleration/Deceleration, "PULL-UP" motion, "ARCH UP/DOWN" motion, etc.
Refer to Chapter 19, "Details of System Parameters" for details.
- Check the entered position data in CHECK mode.
Refer to Chapter 6, "CHECK Mode" for details.

(6) Automatic operation

Check the robot operations after checking the following items.
Refer to later chapter 7, "ON-LINE Mode" for details.

- AUTO Mode
I/O signal check
- ON-LINE Mode
Data transmission speed with host PC.
Station ID number for each robot.



NOTE

There are some differences in operating procedures depending upon the robot model or system configuration. Ask your system integrator for detailed specification. Hirata also offers robot control language HARL-U1 and HARL-III as add-ons to the standard operating system. Contact your distributor for details.



DANGER

- Verify all the cable connectors are properly and firmly connected.
- Confirm there is no operator or any obstacles in robot's working envelope.
- Unspecified usage of this robot may result severe injury or death. Do not install the robot in any other manner than the ones specified in this manual.
- Do not throw or drop the Teach Pendant.
- Do not use the entire system at higher than 40°C and high humidity. The surroundings must be no dust, no smoke, no combustion, and no corrosion.
- Do not stress the Teach Pendant cable connection. Hold the Pendant body when carrying.
- When servicing or teaching, no one should put the system into operation. It is suggested to prepare a sign stating not to activate the system.

CHAPTER 2 Connecting the Teach Pendant

2.1 Naming and Function of the Teach Pendant

2.1.1 Appearance of the Teach Pendant

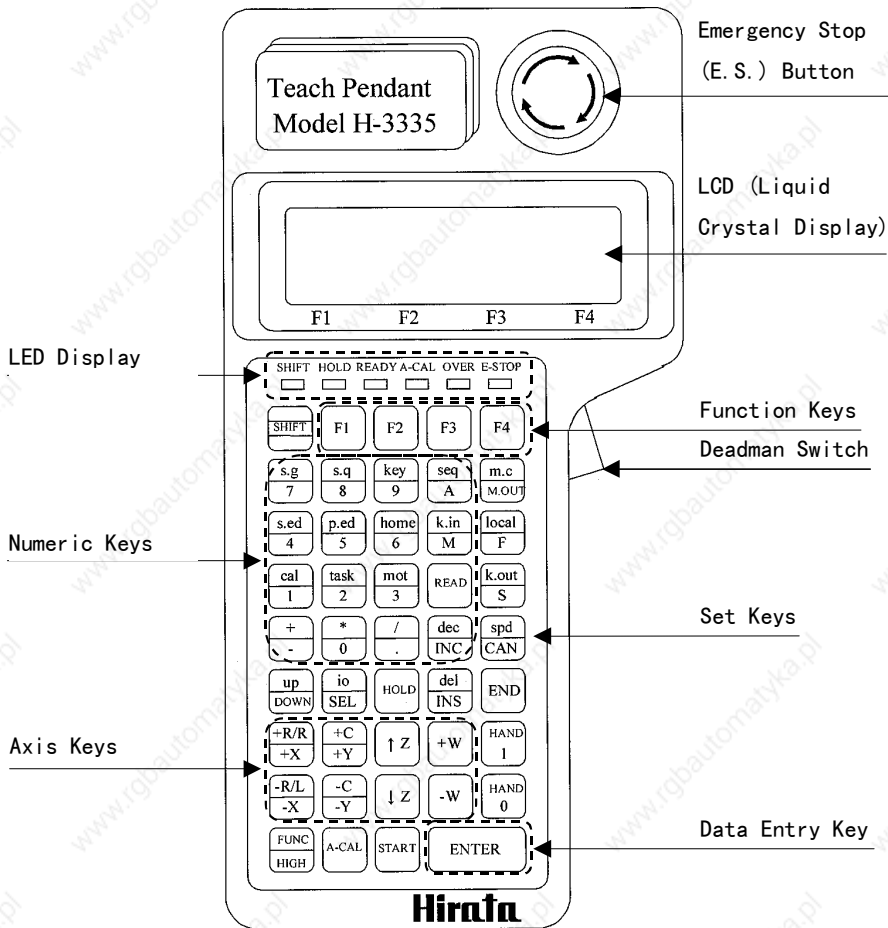

Fig. 2.1 Naming of the Teach Pendant

(1) Emergency Stop (E.S.) button

Emergency Stop button is equipped to the Teach-pendant for the purpose of stopping the robot immediately when an abnormal conditions occur. When this button is pressed, the servo amplifiers/drivers are disconnected electrically from the motors of each axis, and the indicator also lights. Rotate the button clockwise to release from the Emergency Stop status, 『E-STOP』 indicator will then go out after releasing the Emergency Stop status.





(2) Deadman switch

Keep pressing the Deadman-Switch when operating the robot in RO-TEACH, LI-TEACH, or CHECK mode. If this switch is released, the robot will be in Emergency Stop status and it will be stopped.



Release the Deadman switch if any error or abnormal occurrences are happened.

(3) Function keys

Changes the mode on the Teach Pendant. To change the mode, press the , , , or the  key during pressing the  key on the Teach Pendant. The controller is equipped with a MANUAL/AUTO mode selection key switch. Any conflict between the mode of the Teach Pendant and the controller MANUAL/AUTO selection causes the alert buzzer to sound and the conflicting key entry is ignored. Refer to 2.4, “Mode Select Operation” for details.

(4) Set keys

Modifies the position data or the like.

(5) Numeric keys

Inputs the numeric data.

(6) Axis keys

Moves the robot axis by pressing the axis key. The robot axis moves during this key is pressed. The axis moves at high speed by pressing the axis key with the  key.

(7) Data entry key

Confirms the entered data by pressing the data entry key, .

(8) LCD (Liquid Crystal Display)

Displays the data and message. Refer to 2.7, “LCD (Liquid Crystal Display)” for details.

(9) LED display

① 『SHIFT』

Every time the  key is pressed, the 『SHIFT』 LED will switch between ON and OFF. When the 『SHIFT』 LED is lit, the functions of the lower case letters on the pink are selected.

② 『HOLD』

The 『HOLD』 LED is lit if any axis is held (servo lock). There is a “*” mark next to the axis which is held.

(Example) Only Z-Axis is held

0 0 5 0	M 1 0	F 9 9	S 0 0	R 0
X	0 5 0 0 . 0 5	Y	0 0 8 0 . 0 0	
* Z	0 0 2 0 . 1 0	W	0 1 0 0 . 0 0	
LI-TEACH		RB1	[WORLD]	

In KEY-IN mode, the HOLD will be cleared; however, the only axes equipped with a brake is held by the brake instead. The 『HOLD』 LED becomes OFF.

③ 『READY』

Turns ON when the controller is ready for the automatic operation, and it satisfied the following conditions:

- Mode is in ON-LINE on the Teach Pendant.
- A-CAL is completed.
- No error is occurred.
- DI signal inputs the IN0 (SELECT signal).

Normally ON during the automatic operation. Check the conditions if the 『READY』 LED becomes OFF during the automatic operation.

④ 『A-CAL』

Turns ON if A-CAL is/has been completed.

⑤ 『OVER』

Turns ON when the OVERRUN (OVR) sensor is ON. “OVERRUN” is also displayed on the message line.

⑥ 『E-STOP』

Turns ON when an abnormal condition or an error occurs. “EMERGENCY STOP” is also displayed on the message line.

2.1.2 Specification of the Teach Pendant

Table 2.1 Specification of the Teach Pendant

Item	Specification
Type	H-3335
Size	107mm(W) 238mm(D) 40mm(H)
Cable length	4m(15m as option)
Weight	1kg (including 4m cable)
Environment	Operating temperature : 0 to 40 °C Storage temperature : -20 to 60°C
Modes	KEY-IN, TEACH, CHECK, ON-LINE
Display	LCD (20×4), LED
Motion stop	Using by Emergency Stop button (lock type), Deadman switch

2.2 Connecting the Teach Pendant to the Controller

Before using the robot, you need to go through following procedure. This chapter describes the step by step procedures to be used before starting the system:

- Physically connecting the Teach Pendant to the controller
- Configuring the Teach Pendant to the controller.

2.2.1 Physically Connecting the Teach Pendant to the Controller

- (1) Press the Remove switch ¹ on the controller or the repeater, and connect the Teach Pendant connector. This switch has to be pressed until the connection is completed.



WARNING

Make sure to keep pressing the Remove switch while connecting/disconnecting the Teach Pendant. This switch is directly connected to the power source circuit and will shut off the power if the switch is released during this operation. If the system shuts down, it is necessary to reboot the system. The sudden power shut down during robot operation may result in hardware damage. You can connect/disconnect the Teach Pendant while the power is ON; however, it is suggested to connect/disconnect the Teach Pendant after the power is OFF unless necessary. A dummy connector should be installed when the system runs without the Teach Pendant.

- (2) Remove the Dummy Connector. You need to release the lock bolts on the Dummy connector before removing. (When you disconnecting the Teach Pendant, release the lock bolts on the Teach Pendant connector same as the Dummy connector removal.
- (3) Connect the Teach Pendant and lock the bolts.

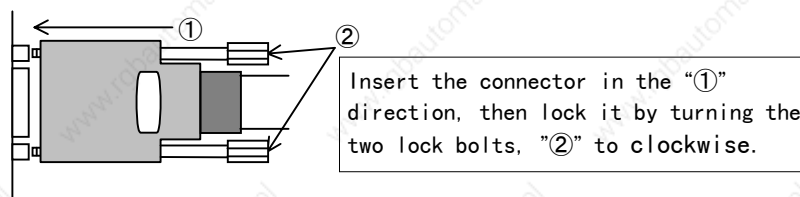

Fig. 2.2 Teach Pendant Connector Lock

- (4) Release the Remove switch after connecting the Teach Pendant is done. Make sure the E.S. button on the Teach Pendant is released and the cable between the controller and Teach Pendant is firmly connected.

¹: Refer to separate volume, "Robot Controller User's Guide."

- (5) You will see the following screen and the system is now ready to operate. If you can not get the screen below, repeat the procedure or reboot the system with the Teach Pendant attached.

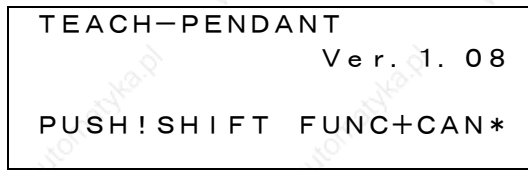

Fig. 2.3 Opening Screen



NOTE

Verify there is a “*” mark next to “CAN.” Without getting this mark, you have to repeat the procedure. Any operation will be ignored without this indication.

2.2.2 Configuring the Teach Pendant to the Controller.



- (1) Go through the procedure in previous sub-section to indicate the opening screen.



- (2) Press the  key to light the 『SHIFT』 LED.





NOTE

The  key is locked by software and every time the  key is pressed, the LED will switch between ON and OFF.

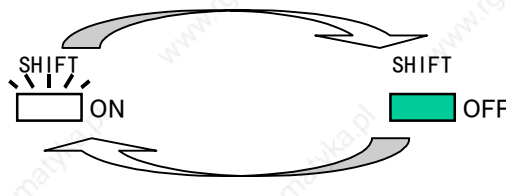
In this manual, the icon  indicates that you need to turn ON the 『SHIFT』 LED.



- (3) Press the  +  keys simultaneously to log-in to the system. You will see following screen when the log-in is successful.

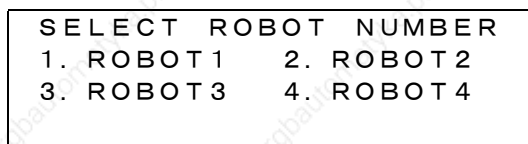

Fig. 2.4 Robot Number Selection Screen (Example)

2.3 Configuring the Robot Setup

Before operating the robot, it is required to connect the Teach Pendant to the controller and configure the robot setup.

2.3.1 Selecting the Robot

- (1) Go through the steps in previous section 2.2 and display Fig.2.4, Robot Selection Screen (Example).
- (2) Type the robot number to be configured. After making the selection, you are able to teach and control the selected robot. If you press any other key, the display will go back to the opening screen.



Key : ROBOT 1



Key : ROBOT 2



Key : ROBOT 3





Key : ROBOT 4

2.3.2 Switching the Robot Selection



Execute following step to change the robot selection.



- (1) Press the  key to light the 『SHIFT』 LED.
- (2) Press the  +  keys simultaneously.

Robot previously selected is now logged-out. You will be back to Fig.2.3, Opening Screen.



- (3) Press the  key to light 『SHIFT』 LED.
- (4) Press the  +  keys simultaneously.
- (5) Select new robot by using the steps in 2.3.1, “Selecting the Robot.”



The robot remains in the same mode and state as when you logged-out.

2.4 Mode Select Operation

Hirata system is provided with 4 modes. This section describes each function and mode selection tips.

Table 2.2 Mode Function

Mode	Function
KEY-IN	Entering the data using the numeric key and handling the memory card data.
TEACH	Manipulates the robot to teach positions
CHECK	Checking the stored robot positions by physically moving the robot
ON-LINE	Accepts PLC or PC commands to drive automatically.

The controller is equipped with a MANUAL/AUTO mode selection key switch ¹. Any conflict between the modes of the Teach Pendant and controller MANUAL/AUTO mode selection causes the alert buzzer to sound and the conflicting key entry is ignored. The table below indicates the conflict status between Teach Pendant and controller modes.

Table 2.3 Matching of Mode Selecting

Controller	Mode		Switching
	Controller	Teach Pendant	
MANUAL	KEY-IN	KEY-IN	OK
	TEACH	TEACH	OK
	CHECK	CHECK	OK
	ON-LINE	ON-LINE	NG
AUTO	KEY-IN	KEY-IN	NG
	TEACH	TEACH	NG
	CHECK	CHECK	NG
	ON-LINE	ON-LINE	OK



CAUTION

Mode selection on the controller and Teach Pendant

- Switching the mode on the controller from MANUAL to AUTO
Unless switching to ON-LINE mode on the Teach Pendant, you can switch to KEY-IN, TEACH or CHECK mode. Once you have entered ON-LINE mode or the system is rebooted, you can not go to these modes.
- Switching the mode on the controller from AUTO to MANUAL
You can change to another mode from ON-LINE. Once you reboot the system, mode will be in KEY-IN.

¹: Refer to the separate volume "Robot Controller User's Guide."

Changing the Mode Selection on the Teach Pendant





- While pressing the  key on the Teach Pendant, you will see the mode displayed. Each mode corresponds to the function key below the screen. Press the function, , , , or  key corresponds to the mode while the indication is ON.

Table 2.4 Matching of the Function Key and Mode

Function Key	F1	F2	F3	F4
Display	KEY	TCH	CHK	ONL
Mode	KEY-IN	TEACH	CHECK	ON-LINE

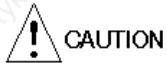

CAUTION

It is not allowed to change the mode except on the home screen. Also, it is not allowed to change while modifying the System Generation and System Parameter.

- TEACH mode has two different movements according to the coordinates system.
 - LI-TEACH (Linear Teach) mode
This mode enables you to manipulate and teach the robot. Robot moves A/B (or X/Y)-Axes linearly along the X-Y coordinate axes set by 「DISPLAY OFFSET」ⁱ in System Parameter menu.
 - RO-TEACH (Rotary Teach) mode
Same as above function. However, manipulates each axis individually by using axis keys.

TEACH mode selection procedure



- Press the  +  keys simultaneously.
- Enter the data corresponding the mode you need to go to and press the  key after changing the data. The change for the robot movement and coordinates system display will be valid immediately.

Table 2.5 Set Value for the Coordinates System Display

Set value	Coordinate system	TEACH mode
0	World coordinate	LI-TEACH
1	DISPLAY 1	LI-TEACH
2	DISPLAY 2	LI-TEACH
3	DISPLAY 3	LI-TEACH
4	TOOL 1	LI-TEACH
5	TOOL 2	LI-TEACH
6	TOOL 3	LI-TEACH
7	Degree	RO-TEACH
8	Degree/Servo off ⁱⁱ	RO-TEACH
9	Count	RO-TEACH

ⁱ : Specified by 「OFFSET」→「DISPLAY OFFSET1-3」→「DISP.**」 in System Parameter menu.

ⁱⁱ : HOLD function for all axes is cleared but the only axes equipped with a brake are held.

2.5 Emergency Stop (E. S.) Button



To stop the robot immediately when an abnormal condition occurs, the Teach Pendant is equipped with an Emergency Stop (E.S.) button. When this button is pressed, the power supply to the servo unit (servo driver and the motor for each axis) is cut off. The 『E-STOP』 indicator also lights. Rotate the button clockwise to release from the emergency stop status. The indicator will then go out after releasing the emergency stop status.

2.6 Basic Entry Procedure



This section describes the basic key entry procedure.

(1) Selecting the entry item

The data entry item can be selected by moving the cursor. Press the  key to choose the item to edit and enter the data. This key is the only key to move the cursor if there are no specific procedures described.

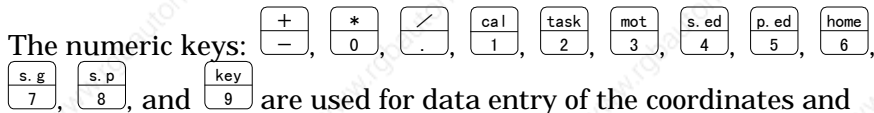

(2) Numeric data

The numeric keys:  are used for data entry of the coordinates and the system data. When pressing the numeric keys, the number corresponding to the keys will be displayed on the Teach Pendant.

However the  and  keys entry may be ignored when the data form is invalid.

● Example for data entry;

① Input the data.







② Press the  key. “ENTER OK ?” is displayed on the message line. Press the  key again to confirm the data, or press any other key to cancel the data.

③ The data input by numeric keys in step ① is automatically formatted in the following manner. If you enter the data for the coordinate (rectangular coordinate), the data is displayed as follows:







- +123456.789 → 4569.00 (Invalid data entry)
- +456.7 → 0456.70
- -12 → -0012.00

When the figure of the input data exceeds the allowable digits, the data will be displayed differently such as in first example. Also, if positive data is entered with a “+”, the “+” will not be displayed on the screen. It is not necessary to enter the “+” when you enter the positive data.





(3) ON/OFF entry

The data displayed, "ON" or "OFF", is the switch data. You can select "ON" or "OFF" using the  key or the numeric keys,  or . Using the  key, "ON" and "OFF" are switched between alternately. The  key corresponds to "OFF," and the  key to "ON." Press the  key twice to confirm the entered data.

(4) YES/NO entry

The data displayed, "YES" or "NO," is the switch data. You can select "YES" or "NO" using the  key or the numeric keys,  or . Using the  key, "YES" and "NO" is switched between alternately. The  key corresponds to "NO," and the  key to "YES." Press the  key twice to confirm the entered data.



(5) Character selection entry

When selecting a text item from a list, (e.g., 「TRANSFER RATE」ⁱ in System Generation menu or mode select in the position memory operation mode) the data can be selected with the  key or the numeric keys,  to . The  key is used when indexing through the list in order. For example, the data or 「TRANSFER RATE」 can be selected in the following order:

300→600→1200→2400→4800→9600→19200→38400

The numeric keys correspond as below;

0: 300/1: 600/.../5: 9600/6: 192000

When using numeric keys, a maximum of ten items,  to , can be selected.

Press the  key twice to confirm the entered data.

ⁱ: Specified by 「ORIGIN」→「SET-UP SYSTEM」→「TRANSFER RATE」 in System Generation menu.

2.7 LCD (Liquid Crystal Display)

Data and a message are displayed for each mode. The display consists of 80 characters (20 columns \times 4 lines)

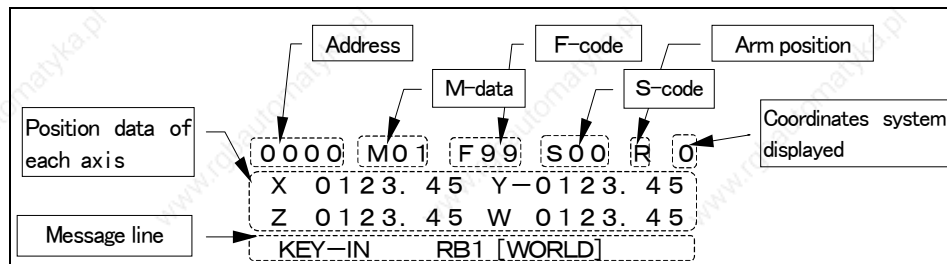

Fig. 2.5 Display when Operating the Robot with Four Axes

- (1) ■: cursor

The cursor indicates the position where data can be input by the numeric keys.

- (2) Address

The address stores the position data, which is from "0" to "maximum number", of the robot. The "maximum number" can be set by System Generation or system configuration.

- (3) M: M-data

M-data is to set the output pattern to the output ports and designate the robot motion pattern. Refer to 16.4.1, "List of M-Data Functions."

- (4) F: F-code

F-code is to set the speed of the robot at the each position. If F-code is set to 99, the robot moves at the speed data designated by the system data. Refer to 16.5, "F-Code."

- (5) S: S-code

S-code is used for expansion of the robot motion function. Refer to 16.4.2, "List of S-Code Functions."

(6) R or L: arm position

Designates whether the robot moves to the position with a right arm (R) or left arm (L) configuration using “R” or “L” key when operating SCARA (horizontal multi-articulated type) robot. In the operational area, there are positions where a SCARA robot can move either in a right arm (R) or left arm (L) position. So, designate the arm side, right (R) or left (L) arm for all positions when entering the position data with the numeric keys.

When using the Cartesian type robot, this display does not affect the operation.

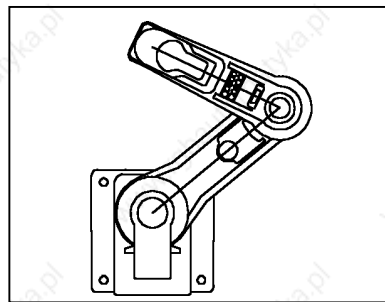
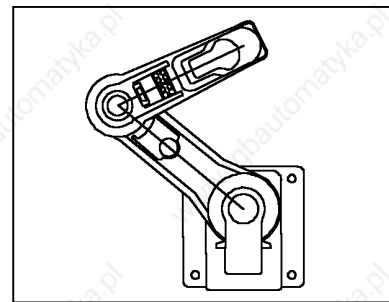

Fig. 2.6 Right Arm (R)

Fig. 2.7 Left Arm (L) ⁱ

(7) Coordinates system display (It ranges from 0 to 9)

Designate the coordinates system display which shows on the Teach Pendant currently. The set values from 0 to 9 correspond to the following TEACH mode.

Table 2.6 Set Value and Items of Coordinates System Displayed

Set value	Displayed item	TEACH mode
0	World	LI-TEACH
1	DISPLAY 1	LI-TEACH
2	DISPLAY 2	LI-TEACH
3	DISPLAY 3	LI-TEACH
4	TOOL 1	LI-TEACH
5	TOOL 2	LI-TEACH
6	TOOL 3	LI-TEACH
7	Degree	LI-TEACH
8	Degree/Servo off ⁱⁱ	RO-TEACH
9	Count	RO-TEACH

(8) “X”, “Y”, “Z”, “W”, “R”, “C”: Position data

Shows the axis data of the address designated. According to the mechanical configuration of the robot, a maximum of six axes' data can be displayed at one time.

ⁱ : Assumed as viewed from robot top.









ⁱⁱ : HOLD function for all axes is cleared, but the only axes equipped with a brake are held.

(9) Message line

Displays the message, general and error messages. Refer to Chapter 23, "Message" for details.

While pressing the  key in any mode except KEY-IN mode, the display shows the software version built-in the controller. For example, "OLD DATA V5.xx" means the software version 5.xx is used in the controller.



(10) Function

While pressing the  and the  to , , , , , , or  keys, the function mode is selected. It designates the mode which is currently displayed on the Teach Pendant. Refer to 2.9, "Function Mode" for details.

2.8 Special Keys

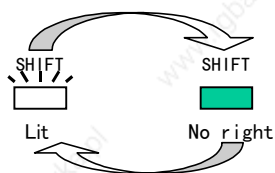

(1)  [SHIFT] key



When this key is pressed once, the 『SHIFT』 indicator turns from ON to OFF, or OFF to ON. When the indicator is lit, the functions of the letters on the pink are selected. For example, if you press the  key with the 『SHIFT』 indicator ON, [del] (delete) is selected, and the  key with the 『SHIFT』 indicator OFF, [INS] (insert) is selected.











NOTE

Besides the  key, there is another function selected by pressing the  key. When pressing the  key, the functions of the lower case letters on the blue two function keys are selected. Refer to 2.9, "Function Mode".



(2)  Cursor operation key

When "DOWN" is used, the cursor moves to right on the display. If there is no item to be input on the right side, the cursor moves to the next line. When "up" is used, the cursor moves to the left. If there are no items to be input, the cursor moves to the line above.



2.9 Function Mode

The mode selected by the  with blue colored key, such as the  to , , , , , , and  keys, is the function mode. This mode can be activated in any other mode. However, in order to display it, the display stage on the Teach Pendant must be in the home stage described in item (2) below.

In ON-LINE mode, the data is displayed but no data cannot be input.

- (1)  +  [cal] keys (calculation)

Calculates the robot individual characteristic values and the offset value or creates position data (palletizing software). Refer to Chapter 12 , “Automatic Creation of Position Data & Parameters” for details.

- (2)  +  [task] keys (task)

Changes the display on the Teach Pendant. There are thirteen screens. Every time pressing these keys, the display screen is switched in order. The first display is called “home screen.”



Table 2.7 Display Screens (task)

Screen No.	Name	Description
1	Home	Normal display
2	Positioning history 「POSITIONING HISTORY」	Displays nine of the history address in order. Refer to Chapter11, “Positioning Address History” for details.
3	Communication monitor 「RS232 MONITOR」	Input/output data communicated by RS232C. (Only for HIRATA maintenance)
4	Speed monitor 「SPEED MONITOR」	Speed for each axis. (Only for HIRATA maintenance)
5	Current monitor 「CURRENT MONITOR」	Current used by each axis. Current upper limits is 100%. (Only for HIRATA maintenance)
6	Servo status 「STATUS MONITOR」	Servo status of each axis (Only for HIRATA maintenance)
7	Servo alarm 「SERVO ALARM」	Contents of the servo alarm for each axis (Only for HIRATA maintenance)
8	System information 「SYSTEM MONITOR」	The system information. Refer to the following page for details.
9	Expanded interface 「EXINTERFACE MONITOR」	Expanded interface is displayed when specifying the I/O type (“CC-Link” or “CompoBus/D (DeviceNet)”) in system configuration. It will not be displayed unless the I/O type is specified. (Only for HIRATA maintenance)
10	Maintenance monitor 1 「GA1045 MONITOR」	(Only for HIRATA maintenance)

Screen No.	Name	Description
11	Alarm history [ALARM HISTORY]	Errors are stored to error history from 1 to F. Stores past 15 errors. The error history 1 is the latest error, and it will be sift up in the order when the error is occurred. Three errors are displayed on the screen at one time. Press the  key to scroll and display the following screen. (Only for HIRATA maintenance)
12	Servo communication error monitor [SERVO ERROR COUNT]	Monitors how many times an error is occurred for the each axis servo LINK communication. (Only for HIRATA maintenance)
13	Maintenance monitor 2 [AUTO EVENT]	(Only for HIRATA maintenance)



NOTE

The function mode, except that selected by [task] key ( + ) , is displayed on home the screen. Press the  key to return to home screen from all others.

Following figure shows the details of system information (Screen No.: 8) . There are four screens.

SYSTEM MONITOR	1/4
VERSION	5. 02. 007B
NC MODE	MANUAL
RB MODE	KEY-IN

Press the  key

SYSTEM MONITOR	2/4
SCALE	NORM
I/O TYPE	REMOTE 00
ID 00 00 00 00	00 00

Press the  key

SYSTEM MONITOR	3/4
VOLTAGE	OK
BATTERY	OK
MEM BATTERY	OK

Press the  key

SYSTEM MONITOR	4/4
HOUR METER	0000000H
RB TYPE	AR-K
EN OK OK OK	* * * *

Fig. 2.8 Display Switching (task)

Explanation of displayed items are as follows:

Table 2.8 System Monitor Display Items

Item	Meaning
VERSION	Controller Version
NC MODE	Controller Mode <ul style="list-style-type: none"> • MANUAL • AUTO
RB MODE	Robot Mode <ul style="list-style-type: none"> • AUTO • CHECK • TEACH • KEY-IN
SCALE	Scale Factor <ul style="list-style-type: none"> • NORM : Standard • SHORT : Short stroke • LONG : Long stroke • SUPER : Super long stroke
I/O TYPE	I/O type <ul style="list-style-type: none"> • REMOTE : Hirata remote I/O (With ID No.) • CC-Link : CC-Link • Dev-Net : DeviceNet • Option1 : Option 1 • Option2 : Option 2
ID	ID number for each axis
VOLTAGE	+5V voltage of CPU board <ul style="list-style-type: none"> • OK : Normal • NG : Abnormal (Lower than 4.3V)
BATTERY	Voltage of CPU board battery <ul style="list-style-type: none"> • OK : Normal • NG : Abnormal (Lower than 3.3V)
MEM BATTERY	Voltage of memory card battery <ul style="list-style-type: none"> • OK : Normal • NG : Abnormal (Lower than 2.4V) • * * : Not equipped
HOURL METER	Elapsed time after system set up
RB TYPE	Robot type
EN	The rest of encoder battery <ul style="list-style-type: none"> • OK : Normal • NG : Abnormal • * * : No axis

(3) $\begin{matrix} \text{FUNC} \\ \text{HIGH} \end{matrix} + \begin{matrix} \text{mot} \\ 3 \end{matrix}$ [mot] keys (motion)

Selects the aging mode. This function is used before shipping at the factory. Refer to 2.10, "Aging."

(4) $\begin{matrix} \text{FUNC} \\ \text{HIGH} \end{matrix} + \begin{matrix} \text{s. ed} \\ 4 \end{matrix}$ [s.ed] keys (sequence edit)

Edits the position data collectively. Refer to 8.5, "Editing Position Data in Blocks."

- (5)

FUNC
HIGH

 +

p. ed
5

 [p.ed] keys (position edit)

Edits the position data collectively. Same function as [s.ed] previously referred. Refer to 8.5, "Editing Position Data in Blocks."

- (6)

FUNC
HIGH

 +

home
6

 [home] keys (home mode)

Returns the display to the home mode from all other modes.

- (7)

FUNC
HIGH

 +

s. g
7

 [s.g] keys (System Generation)

Edits the System Generation data. Refer to Chapter 18, "Details of System Generation."

- (8)

FUNC
HIGH

 +

s. p
8

 [s.p] keys (System Parameter)

Edits System Parameter data. Refer to Chapter 19, "Details of System Parameters."

- (9)

FUNC
HIGH

 +

key
9

 [key] keys (KEY-IN)

Changes the mode to KEY-IN when the mode is ON-LINE. Refer to Chapter 4, "KEY-IN Mode."

- (10)

FUNC
HIGH

 +

io
SEL

 [io] keys (input/output)

Changes the display to I/O monitor. Refer to 9.1, "DI/DO Monitor."

- (11)

FUNC
HIGH

 +

m. c
M. OUT

 [m.c] keys (memory card)

Changes the display to memory card mode. Refer to Chapter 13, "Memory Card."

- (12)

FUNC
HIGH

 +

k. in
M

 [k.in] keys (key input macro)

Starts and ends the key input macro that stores keyed in.

- (13)

FUNC
HIGH

 +

k. out
S

 [k.out] keys (key output macro)

Executes the stored key-in data input with the key-in macro. An example of the key input/output macro is described in following page.

EXAMPLE

Set the Z-Axis data to "10."

- ① $\left[\begin{array}{|c|} \hline \text{FUNC} \\ \hline \text{HIGH} \\ \hline \end{array} \right] + \left[\begin{array}{|c|} \hline \text{k. in} \\ \hline \text{M} \\ \hline \end{array} \right]$: Starts key input
- ② $\left[\begin{array}{|c|} \hline \uparrow \text{Z} \\ \hline \end{array} \right] \rightarrow \left[\begin{array}{|c|} \hline \text{cal} \\ \hline 1 \\ \hline \end{array} \right], \left[\begin{array}{|c|} \hline * \\ \hline 0 \\ \hline \end{array} \right] \rightarrow \text{ENTER} \rightarrow \text{ENTER}$: sets "10" to the Z-Axis data
- ③ $\left[\begin{array}{|c|} \hline \text{FUNC} \\ \hline \text{HIGH} \\ \hline \end{array} \right] + \left[\begin{array}{|c|} \hline \text{k. in} \\ \hline \text{M} \\ \hline \end{array} \right]$: Ends key input
- ④ Set the address where the Z-Axis data of "10" is to be entered.
- ⑤ $\left[\begin{array}{|c|} \hline \text{FUNC} \\ \hline \text{HIGH} \\ \hline \end{array} \right] + \left[\begin{array}{|c|} \hline \text{k. out} \\ \hline \text{S} \\ \hline \end{array} \right]$: Executes key macro. The Z-Axis data of the set address should be "10."

This function is useful for repeating key operation.

(14) $\left[\begin{array}{|c|} \hline \text{FUNC} \\ \hline \text{HIGH} \\ \hline \end{array} \right] + \left[\begin{array}{|c|} \hline \text{local} \\ \hline \text{F} \\ \hline \end{array} \right]$ [local] keys (local)

Moves the cursor to the displayed coordinate's data. Refer to 2.7, "LCD (Liquid Crystal Display)."

(15) $\left[\begin{array}{|c|} \hline \text{FUNC} \\ \hline \text{HIGH} \\ \hline \end{array} \right] + \left[\begin{array}{|c|} \hline \text{seq} \\ \hline \text{A} \\ \hline \end{array} \right]$ [seq] keys (sequence)

Sets the mode to enter sequence data or input the particular data.

2. 10 Aging

The robot should be operated continuously in order to test the robot motion. The speed in aging mode is set by the System Parameter ¹, 「MOTION」→「AXIS SPEED」→「AXIS A,B(X,Y),W」→「AXIS Z」.

- (1) Execute A-CAL first if the A-CAL has not been completed.
- (2) Set the position data to be entered and put the END point (M-data=??) at the end of the position. Refer to 8.1, "Entering END Point (M-Data=??)" to set the END point.
- (3) Press the $\left[\begin{array}{|c|} \hline \text{FUNC} \\ \hline \text{HIGH} \\ \hline \end{array} \right] + \left[\begin{array}{|c|} \hline \text{F3} \\ \hline \end{array} \right]$ keys to change to CHECK mode.
- (4) Run the robot in CHECK mode to confirm the motion speed because the speed in aging mode is same as in AUTO mode. Then set the position from the first address to the end of the address with the END point in order.
- (5) Press the $\left[\begin{array}{|c|} \hline \text{FUNC} \\ \hline \text{HIGH} \\ \hline \end{array} \right] + \left[\begin{array}{|c|} \hline \text{mot} \\ \hline 3 \\ \hline \end{array} \right]$ keys. The displays shows;

Motion Set	
Motion =	[NORMAL]
Motion Address	0000
Aging Count	0000

Fig. 2.9 Aging Mode Display

¹: Press the $\left[\begin{array}{|c|} \hline \text{FUNC} \\ \hline \text{HIGH} \\ \hline \end{array} \right] + \left[\begin{array}{|c|} \hline \text{s. p} \\ \hline 8 \\ \hline \end{array} \right]$ keys to change.

(6) Input the data.

Press the  key to select the 「Motion」 data.

Input the all data following the method given below;



① Input the data.

② Press the  key to enter the input data. The message line displays the message “ENTER OK?” and a beep sounds.

③ Press the  key again to confirm the input data.

The meaning of each of the items on the display is:

- 「Motion」
Selects the motion in three types.
 - NORMAL
 - AGING
 - ADJUST (Currently not used.)
- 「Motion Address」
Sets the first address of the position data which you set in step (2) previously.
- 「Aging Count」
Inputs the times to repeat the aging motion. Set to “0” not to specify the repeat times.

(7) Press the  +  keys to change to AUTO mode and the message line will display “AGING.”



NOTE

The NC MODE (controller mode) is AUTO, the aging mode cannot be selected and the message “NC Mode Error!!” is displayed.

(8) Before aging the robot, confirm the safety around the operation area and be ready to push the E.S. button. Then press the  key to start aging.



DANGER

- Push the E.S. button to stop the robot operation when the robot works with noise or vibration.
- Aging speed can be set to the maximum speed by the System Generation.

(9) The robot starts aging.

(10) Change the mode from AUTO to any other to stop the aging.

CHAPTER 3 A-CAL (Automatic Calibration)

3.1 Basic Operation

It is necessary to perform A-CAL (Automatic calibration) and light the 『A-CAL』 LED on the Teach Pendant before the robot operation. The position of each axis is detected by counting the encoder pulse generated from the encoder which is connected each axis. The encoder and counter do not count the encoder pulse unless the controller has been connected to the power supply.

The robot must know the current position in physically and electronically. Generally, all the mechanism requires, so-called calibration, which is to match the coordinate data in the controller and physical robot position.

A-CAL automatically brings about the coincidence of the two origins.



NOTE

Once A-CAL is done after turning ON the power, it is not necessary to repeat the A-CAL procedure as long as the 『A-CAL』 LED remains ON.

The 580 series controller uses the ABS (Absolute) encoder to detect the position, so that the A-CAL is performed only once when the robot is installed. That is, it is not necessary to perform A-CAL again after the first A-CAL.

If the driver error “U” has occurred, set 「A-CAL CHEK」 in System Generation menu to “0” and perform A-CAL again to escape from this error. Refer to 3.2, “A-CAL Parameters” for details.

3.2 A-CAL Parameters

Followings are the data referred when the A-CAL is performed. Refer to Chapter 18, "Details of System Generation" and Chapter 19, "Details of System Parameters" for details.

Table 3.1 A-CAL Operation Data

Item	Meaning	Data
System Generation ⁱ → 「MAINTE」→ 「MAINTENANCE DATA」→ 「A-CAL CHECK」	Determine the A-CAL algorithm. 0: Set current position as origin position. 1: A-CAL the robot, but alert an operator with "A-CAL WARNING" when the origin is out of range. 2: Ignores the error when the origin is out of range. 16: Define the origin when the origin (ORG) sensor turns ON. 32: Define the origin when the origin (ORG) sensor and Z signal of motor turns ON.	You can set multiple conditions to A-CAL by adding the codes. <Example> "17" (=16+1) Sets the origin when the ORG sensor turns ON and warn the error when the origin is out of range and keep the operation. Combination of 1 and 2, and 16 and 32 is invalid.
System Generation → 「ORIGIN」→ 「AXIS DIRECTION」→ 「A-CAL SEQ」	Sets the axis order to be performed A-CAL; O O O O O O ↓ ↓ ↓ ↓ ↓ ↓ A B Z W R C Define the same number for the axis to be performed A-CAL simultaneously.	Setting range: "000000"–"666666" ·000000: No order is set (A-CAL is in standard order). ·666666: A-CAL is all axes simultaneously. Standard order: 221222 Performs A-CAL for Z-Axis first, and rest of axes A-CAL.
System Parameter ⁱⁱ → 「RESPONSE」→ 「RESPONSE」→ 「A-CAL SPEED」	Sets A-CAL speed by percentage of the maximum speed.	Setting range: "1"–"999" (0.1%–99.9%) Standard setting: 50 (50%)

ⁱ : Press the

FUNC	s. g
HIGH	7

 +

s. g	7
------	---

 keys.

ⁱⁱ : Press the

FUNC	s. p
HIGH	8

 +

s. p	8
------	---

 keys.

3.3 A-CAL Procedure







Press the  key to perform A-CAL in TEACH and CHECK mode. In the automatic operation, A-CAL is performed by the commands, such as SELECT signal in AUTO mode and A-CAL command in ON-LINE mode, from external devices. Refer to 2.4, "Mode Select Operation," about the robot modes. The following is the manual A-CAL procedure to be performed with the Teach Pendant.

- (1) Set the Teach Pendant to TEACH or CHECK mode. A-CAL can be performed in both modes by the same procedure.
- (2) Make sure not to release the Deadman switch during the following operation. Releasing the Deadman switch causes the system to go into Emergency Stop status.
- (3) Set the position data display by pulse.

① Press the  +  keys.

② Press the  key.

③ Press the  key

- (4) Press the  +  keys, then the following screen will appear as below. Select the axis to A-CAL by the , , ,  keys. Selected axes indicate "ON" at "a" part and will execute A-CAL. Normally, select all axes "ON" when performing A-CAL unless otherwise necessary.

"a" (A-CAL option selection)







A-CAL the axis : ON
Skip A-CAL : OFF







A	-	C	A	L	S	E	T	M	O	D	E		
X		ON	ON		Y		ON	ON					
Z		ON	ON		W		ON	ON					
P	u	s	h	A	-	C	A	L	K	e	y	!	!

"b" (A-CAL status)

A-CAL completed : ON
Incompleted : OFF

Fig. 3.1 A-CAL Axis Selection (4 Axes Robot)

- Press the  key to select X-Axis.
- Press the  key to select Y-Axis.
- Press the  key to select Z-Axis.
- Press the  key to select W-Axis.
- Press the  keys to select R-Axis.
- Press the  keys to select C-Axis.

- (5) Keep pressing the  key until the A-CAL completes.
-  (6) When A-CAL is completed successfully, “A-CAL COMPLETED” will be appeared on screen and a buzzer will sound. If A-CAL could not be completed for some reason, “A-CAL INCOMPLETE” will be appeared and a buzzer will sound. Repeat from step (2) in the case of A-CAL incomplete. Once A-CAL is done, the 『A-CAL』 LED lights.
- (7) Verify the A-CAL results. Take note of the current encoder pulse count on the screen.
- To display the pulse count;
- ① Press the  +  keys.
 - ② Press the  key.
 - ③ Press the  key.
- (8) Turn OFF the power.
- (9) Turn ON the power again.
- (10) Compare the current encoder pulse and recorded pulse at step (7). If the pulse difference is less than 100 pulse, A-CAL is done successfully. If the difference is exceeding 100 pulse, go back to step (2) above.



CAUTION

Releasing the  key before A-CAL complete, the robot stops the A-CAL operation and “A-CAL INCOMPLETE” is displayed and a buzzer will sound. Perform A-CAL operation again from step (2) above.

3.4 A-CAL Related Error

A-CAL is the most basic operation to confirm robot functionality. By performing A-CAL, it is confirmed whether or not the motor, encoder and sensor of each axis works and are controlled correctly. While A-CAL is being performed, error detection is executed at each stage of A-CAL. The error codes are shown below.

Table 3.2 A-CAL Error Code

Message	Meaning
* 0 Not Find	ORIGIN sensor did not respond.
* 1 Not Off	ORIGIN sensor does not back OFF.
* 2 Other On	OVERRUN sensor response during A-CAL.
* 4 Lower	A-CAL completed below the safety margin.
* 5 Upper	A-CAL complete above the safety margin
* 7 Error	Misc. unknown error.

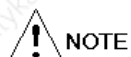

NOTE

“*” mark indicates the axis that caused the error.
A=A(X)-Axis, B=B(Y)-Axis Z=Z-Axis, W=W-Axis, R=R-Axis, C=C-Axis.

3.4.1 User Action for “*0 Not Find”

This error means missing ORIGIN sensor signal input. Take following steps to resolve the problem. Possibly, the sensor did not react or mechanically the robot did not move onto the sensor.







- (1) Retry A-CAL and monitor the robot motion. Verify there is no mechanical jam, slip or broken timing belt which causes mechanical failure. If you find a problem, take the necessary actions to correct it.
- (2) Move the robot to verify the sensor turns ON.
 - ① Go to RO-TEACH mode.
 - ② Press the minus (-) axis key to move the robot until the ORIGIN sensor reacts.
 -  key : X (A)-Axis moves toward ORIGIN sensor direction.
 -  key : Y(B)-Axis moves toward ORIGIN sensor direction.
 -  key : Z-Axis moves toward ORIGIN sensor direction.
 -  key : W-Axis moves toward ORIGIN sensor direction.
 -  keys : R-Axis moves toward ORIGIN sensor direction.
 -  keys : C-Axis moves toward ORIGIN sensor direction.
 - ③ Move the robot to confirm the ORIGIN sensor turns ON and the message “OVERRUN*****” should be displayed on the Teach Pendant. The “*****” part shows the sensor status of each axis by number in the order of “XYZWRC.”







Table 3.3 Description for the “***” Part**

Number	Meaning
0	The sensor is not ON.
1	The ORIGIN sensor is ON.
2	The OVERRUN sensor is ON.
3	The ORIGIN and limit sensors are ON.

- ④ Confirm the “1” is displayed on the “*****” part. For example, when the ORIGIN sensor of X-Axis is ON, the display shows “100000.” Check the sensor and replace it if necessary. If you get a message other than 1, the ORIGIN/OVERRUN sensor is defective or the sensor is not properly connected.

3.4.2 User Action for “* 1 Not Off”

This message indicates that the sensor did not turn OFF after the axis left from the sensing range. When you get this message, you should see the OVERRUN error when you turn the power ON.

- (1) Retry A-CAL and monitor the robot motion. Verify there is no mechanical jam, slip or broken timing belt which causes mechanical failure. If you find a problem, take necessary actions to correct it.
- (2) Move the robot to verify the sensor turns OFF.
 - ① Go to RO-TEACH mode.
 - ② Since the ORIGIN sensor turns ON, the message “OVERRUN *****” should be displayed on the Teach Pendant. Confirm the “1” is displayed on the “*****” part which shows the sensor status of each axis by number in the order of “XYZWRC.” For example, when the ORIGIN sensor of X-Axis is ON, the display shows “100000.”
 - ③ Press the plus (+) axis key move the robot until the ORIGIN sensor reacts.
 -  key : X (A)-Axis moves toward OVERRUN sensor direction.
 -  key : Y(B)-Axis moves toward OVERRUN sensor direction.
 -  key : Z-Axis moves toward OVERRUN sensor direction.
 -  key : W-Axis moves toward OVERRUN sensor direction.
 -  keys : R-Axis moves toward OVERRUN sensor direction.
 -  keys : C-Axis moves toward OVERRUN sensor direction.
 - ④ Verify the sensor turns OFF when the axis leaves the sensing area. The “OVERRUN *****” message should disappear. If the sensor still does not go OFF, replace the sensor.

















3.4.3 User Action for “*2 Other On”

This error message indicates that the OVERRUN sensor turned ON during A-CAL. This is caused by improper sensor connection.

- (1) Retry A-CAL and monitor the robot motion. Verify there is no mechanical jam, slip or broken timing belt which causes mechanical failure. If you find a problem, take necessary actions to correct it.
- (2) Verify the robot motion by using the following steps.

① Go to RO-TEACH mode.

② Press each key and to verify the each axis moves correctly.

-  key : X (A) -Axis moves toward OVERRUN sensor direction.
-  key : Y(B) -Axis moves toward OVERRUN sensor direction.
-  key : Z-Axis moves down toward OVERRUN sensor direction.
-  key : W-Axis moves toward OVERRUN sensor direction.
-  +  keys : R-Axis moves toward OVERRUN sensor direction.
-  +  keys : C-Axis moves toward OVERRUN sensor direction.
-  key : X (A) -Axis moves toward ORIGIN sensor direction.
-  key : Y (B) -Axis moves toward ORIGIN sensor direction.
-  key : Z-Axis moves up toward ORIGIN sensor direction.
-  key : W-Axis moves toward ORIGIN sensor direction.
-  +  keys : R-Axis moves toward ORIGIN sensor direction.
-  +  keys : C-Axis moves toward ORIGIN sensor direction.

③ Verify each sensor reacts correctly. Most likely, when you see this error, the ORIGIN/OVRRUN sensor is not properly connected.

3.4.4 User Action for “*4 Lower”

Sensor tab is adjusted lower than safety margin. To correct the position drift, it is recommended to adjust the sensor tab position.

This error indicates that A-CAL is completed when the encoder pulse count is less than 2,048. The position of the sensor and sensor tab should be set so that the ORIGIN sensor turns ON between 2,048~6,144 pulses.

3.4.5 User Action for “*5 Upper”

Sensor tab is adjusted lower than safety margin. To correct the position drift, it is recommended to adjust the sensor tab position.

This error indicates that A-CAL is completed when the encoder pulse count is greater than 6,144. The position of the sensor and sensor tab should be set so that the ORIGIN sensor turns ON between 2,048~6,144 pulses.





3.4.6 User Action for “OVERRUN ***”**

The OVERRUN sensor maybe disconnected. Check the sensor connection. However the “OVERRUN *****” error during the procedure above mentioned to recover from A-CAL error is a normal message.

CHAPTER 4 KEY-IN Mode

4.1 General

KEY-IN mode enables you to enter the position data with the numeric keys manually.

Set the controller mode to MANUAL and press the  +  keys to enter KEY-IN mode. Also, it is able to enter KEY-IN mode by pressing the  +  keys in AUTO mode.

In KEY-IN mode, the position data, which is stored in memory, is displayed and "KEY-IN" will appear on the message line.

Enter each data with the numeric keys at the place where the cursor "■" is located.

0	0	0	0	M	0	1	F	9	0	S	0	0	R	0		
X	0	1	2	3	.	4	5	Y	-	0	1	2	3	.	4	5
Z	0	1	2	3	.	4	5	W	0	1	2	3	.	4	5	
KEY-IN								RB1		[WORLD]						



Fig. 4.1 Display in KEY-IN Mode (Robot 1 with 4 Axes)

In KEY-IN mode, all axes are not in HOLD condition; however, only the motor equipped with a brake is held.



4.2 Basic Operation

The following is basic operation to enter the position data.



(1) Address

Press the  key, or the  key to position the cursor to the address data. Set the data with the numeric keys.



(2) M-data

Press the  key, or the  key to position the cursor to the M-data. Set the data with the numeric keys.



(3) F-code

Press the  key, or the  key to position the cursor to the F-code. Set the data with the numeric keys.



(4) S-code

Press the  key, or the  key to position the cursor to the S-code. Set the data with the numeric keys.

(5) Arm position

Press the  key to light up the 『SHIFT』 LED. Press the  key or the  key to set the arm position, “R” or “L.”













(6) Coordinates system display

Press the  +  keys or the  key to move the cursor to the position where the data is to be entered by the numeric keys.

(7) Position data

Move the cursor to the position where the axis data is to be entered.

① The robot with 4 axes (X,Y,Z,W)

- X-Axis : Press the  key and the  key, or press the  key to move the cursor.
- Y-Axis : Press the  key and the  key, or press the  key to move the cursor.
- Z-Axis : Press the  key and the  key, or press the  key to move the cursor.
- W-Axis : Press the  key and the  key, or press the  key to move the cursor.

② The robot with 6 axes (X,Y,Z,W,R,C)

Press the  key to move the cursor.

4.3 Basic Operation Example

The following is an example to enter new position data into address 50, M=10, F=99, R/L=L, X=500.05, Y=-80, Z=20.1, W=100

- (1) Press the + keys to set the Teach Pendant to KEY-IN mode.
- (2) The display shown in Fig.4.1, Display in KEY-IN Mode (Robot 1 with 4 Axes) will appear. However the displayed data indicates the stored data. Enter new data as follows.

- ① Set the Address to "50."

Press the key and enter , .

0050 M01 F90 S00 R 0

- ② Set the M-data to "10."

Press key and enter , .

0050 M10 F90 S00 R 0

- ③ Set the F-data to "99."

Press the key and enter twice.

0050 M10 F99 S00 R 0

- ④ Set the arm position to, "R" or "L."

Press the key and 『SHIFT』 LED is lit, and press the .

0050 M10 F99 S00 L 0

- ⑤ Set the X data to "500.05."

Press the key and 『SHIFT』 LED is lit. Press the key or the key and enter → → → → → .

X0500.05 Y0123.45

- ⑥ Set the Y data to "-80."

Press the key or the key and enter → → .

X0050.05 Y-0080.00

- ⑦ Set the Z data to "20.1."

Press the key or the key and enter → → → .

Z0020.10 W0123.45

- ⑧ Set the W data to "100."

Press the key or the key and enter → → .

Z0020.10 W0100.00

- (3) The following display appears using above procedure.









0050	M10	F99	S00	L 0
X	0500.	05	Y-0080.	00
Z	0020.	10	W 0100.	00
KEY-IN		RB1	[WORLD]	

Fig. 4.2 Data Setting Display (Robot 1 with 4 Axes)



CAUTION

When the coordinates system has been changed before pressing the  key to enter the data (ADD, R, M, F, X, Y, Z, W, R, C), all data changes except the coordinates system displayed will be canceled. Be sure to enter the data before changing the coordinates system (Coordinates System is the System Parameters selected on 「DISPLAY OFFSET 1-3」¹⁾.)

- (4) Press the  key to enter the input data. “ENTER OK ?” will appear on the message line and a buzzer will sound.
- (5) Press the  key again to confirm the input data.
- (6) After the confirmation, the next address data will appear on the display (For this example, address “51”).
- (7) There are two ways to check the data at address “50”. The Fig.4.2, Data Setting Display (Robot 1 with 4 Axes) will appear using either following procedures.
- Press the  key to light up the 『SHIFT』 LED, then press the  key to go back to previous address which data of address “50” is displayed.
 - Press the  key to move the cursor to the position where the address data is to be entered. Press the  →  keys. Press the  key and Fig.4.2, Data Setting Display (Robot 1 with 4 Axes) will appear.

¹⁾: System Parameter, 「OFFSET」→「DISPLAY OFFSET1-3」→「DISP. **」

4.4 Data Correction

- (1) To correct wrong data;

Move the cursor to the position where the correct data is to be input and entered.

- (2) To cancel all data before entering;

Press the  key and the display shows the data stored in the current address.

- (3) When you cancel the entry of all data and start from address "0000";

Press the  key

- (4) When you cancel the entry of data;

After "ENTER OK ?" appears on the display, press any key except the  key.

- (5) When an error message appears on the display;

Data cannot be entered. Press the  key then the error message disappears and the stored data is displayed. After confirming the error (Refer to Chapter 23, "Message"), enter the correct data.



CHAPTER 5 TEACH Mode

5.1 General

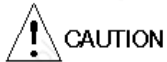

This mode enables you to manipulate the robot and perform teaching by hand or with the axis key ⁱ. The axis moves at high speed by pressing each axis key with the  key.



CAUTION





If you press the opposite direction keys (e.g.,  , ) at the same time, the axis does not move.

While operating the robot in TEACH mode, hold the Deadman switch. If you release the Deadman switch, the Emergency Stop function turns ON.

Set the controller mode to MANUAL and press the  +  keys to change TEACH mode. There are two modes for TEACH operation, LI-TEACH and RO-TEACH. The LI-TEACH is to manipulate the A,B (X,Y)-Axes linearly along the X-Y coordinates set by the system data. The RO-TEACH is to manipulate each axis independently. When the mode is changed to TEACH, either mode of LI-TEACH or RO-TEACH will be designated by the coordinate system displayed on the Teach Pendant. Refer to 2.4, "Mode Select Operation" for details.

5.2 Basic Operation

5.2.1 Operation with X-Y Coordinates in LI-TEACH Mode.



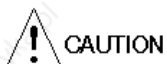





In LI-TEACH mode, the X (A) and Y (B)-Axes are controlled simultaneously and are linearly operated along the X-Y coordinates set at DISPLAY OFFSET ⁱⁱ. The X (A) and Y (B)-Axes moves in parallel with the X coordinate with the  or the  key and in parallel with the Y coordinate with the  or the  key. In linear operation, the W-Axis moves independently and keeps its orientation to the X-Y coordinates.



CAUTION



Unless the 『A-CAL』 LED is lit, you cannot operate the robot in LI-TEACH mode. "A-CAL INCOMPLETE" will appear on the display. Refer to Chapter 3, "A-CAL (Automatic Calibration)" to perform A-CAL.

ⁱ : The axis is specified by pressing the  ,  ,  ,  ,  ,  ,  , or the  key. Refer to Fig.2.1, "Naming and Function of the Teach Pendant."

ⁱⁱ : Specified by 「OFFSET」→「DISPLAY OFFSET1-3」→「DISP.**」 in System Parameter menu.

5.2.2 X (A) and Y (B)-Axes Operation in RO-TEACH Mode

In RO-TEACH mode, X (A)-Axis is operated by the $\begin{matrix} +R/R \\ +X \end{matrix}$ or the $\begin{matrix} -R/L \\ -X \end{matrix}$ key, and Y (B)-Axis is operated by the $\begin{matrix} -R/L \\ -X \end{matrix}$ or the $\begin{matrix} -C \\ -Y \end{matrix}$ key independently.

When operating the X (A) and Y (B)-Axes by each axis keys, The W-Axis rotates independently of the X (A) and Y (B)-Axes. The axes move in the opposite direction to the origin point with the “+” key. If you wish to change the moving direction, change the data of 「INCHING DIR.」 for each axis in System Generation menu, 「ORIGIN」→「AXIS DIRECTION」→「INCH DIR.」

Normally the robot moves as in following figure.

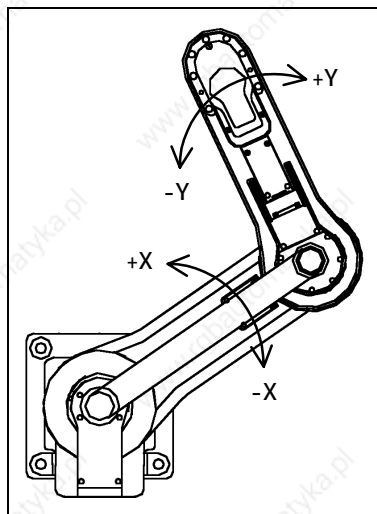

Fig. 5.1 Inching Direction

5.2.3 Z-Axis Operation

The Z-Axis is controlled in both LI-TEACH and RO-TEACH modes. The $\begin{matrix} \uparrow Z \end{matrix}$ key is to go up, the $\begin{matrix} \downarrow Z \end{matrix}$ key is to go down.

5.2.4 W-Axis Operation

The W-Axis is controlled in both LI-TEACH and RO-TEACH modes as well as Z-Axis. W-Axis moves counter clockwise with the $\begin{matrix} +W \end{matrix}$ key and clockwise with the $\begin{matrix} -W \end{matrix}$ key (as viewed from the robot's top).

In LI-TEACH mode, when W-Axis HOLD is ON, W-Axis will keep its orientation while A (X) and B (Y)-Axes move. In this case, W-Axis cannot be moved by the hand. W-Axis HOLD is useful when picking up work placed in the same direction with a gripper.

5.2.5 R-Axis Operation (Robot with 6 Axes)



The R-Axis is controlled in both LI-TEACH and RO-TEACH modes as well as Z-Axis. Press the key to light up the 『SHIFT』 LED, then the R-Axis moves counter clockwise with the key and clockwise with the key (as viewed from the robot's top).

5.2.6 C-Axis Operation (Robot with 6 Axes)



The C-Axis is controlled in both LI-TEACH and RO-TEACH modes as well as Z-Axis. Press the key to light up the 『SHIFT』 LED, then the C-Axis moves counter clockwise with the key and clockwise with the key.

5.2.7 HOLD Operation

Currently this function is not used in this system. HOLD is normally ON.

5.2.8 TEACH Mode Operation in Display

```

0050 M10 F99 S00 R 0
X 0500.05 Y 0080.00
Z 0020.10 W 0100.00
LI-TEACH RB1 [WORLD]

```

Fig. 5.2 LI-TEACH Mode (Robot 1 with 4 Axes)

In TEACH mode, the position data line shows the current position of each axis. The figure above shows the LI-TEACH mode display. In RO-TEACH mode, the message line shows "RO-TEACH."

Address, M-data, F-code and coordinates system display are entered with the numeric keys. The following are the methods to move to each item and input data.

- (1) Address

Press the key or the key to move the cursor to the position where the data is to be entered with the numeric keys.



- (2) M-data

Press the key or the key to move the cursor to the position where the data is to be entered with the numeric keys.



- (3) F-code

Press the key or the key to move the cursor to the position where the data is to be entered with the numeric keys.

(4) S-code



Press the  key or the  key to move the cursor to the position where the data is to be entered with the numeric keys.

(5) Coordinates system display

Press the  +  keys or the  key to move the cursor to the position where the data is to be entered with the numeric keys.



5.2.9 Motion Speed in TEACH Mode

When you operate each axes using the axis keys on the Teach Pendant, the axis moves at high speed by pressing each axis key with the  key.

To set the speed in TEACH mode, change the System Parameter ⁱ, 「RESPONSE」→「RESPONSE」→「INCHING SPEED」 or pressing the  +  keys. When operating the axis with only the axis keys, the axes move at the speed set by the 「INCHING SPEED」.



5.3 Speed Data Setting in TEACH Mode

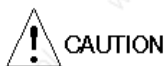

- (1) Press the  key in TEACH mode to light up the 『SHIFT』 LED, then press the  key to set the 「INCHING SPEED」 ⁱⁱ in System Parameter menu.
- (2) Enter the speed data.
- (3) Press the  key to return to the TEACH mode.



- Entering the speed data sets the speed for all axes. Setting the speed data for one axis is not possible.
- The maximum speed in TEACH mode is 250 mm/sec.

ⁱ : Press the  +  keys.

ⁱⁱ : System Parameter, 「RESPONSE」→「RESPONSE」→「INCHING SPEED」





5.4 Basic Operation Procedure

Following are the basic operation procedures in TEACH mode.





WARNING

This mode enables the robot to move. Misoperation may cause injury and interference with other devices. Intensive care is required when operating the robot.

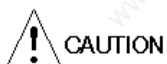
- (1) Press the  +  keys to change to TEACH mode. RO-TEACH mode or LI-TEACH mode is set by the coordinates system display on the Teach Pendant (Refer to 2.4, "Mode Select Operation.")
- (2) When using the Teach Pendant with a Deadman switch, keep pressing the Deadman switch while operating in TEACH mode. If the Deadman switch is released, the system goes in to Emergency Stop status.
- (3) Perform A-CAL if it has not performed. (The 『A-CAL』 LED is lit if A-CAL has done.)
- (4) Set the position address where the data is to be stored.
- (5) Press the  key to confirm the previously stored F-code, M-data, S-code, and coordinate system.
- (6) Change the M-data if necessary.
- (7) Change the F-code if necessary.
- (8) Change the S-code if necessary.
- (9) Change the coordinate system if necessary.
- (10) To teach the position to the robot, manipulate the robot to the position manually or by pressing the axis keys on the Teach Pendant.
- (11) After moving the robot to the position to be entered, press the  key. "ENTER OK ?" appears on the message line and a buzzer sounds.
- (12) After confirming the data is correct, press the  key again to enter the data.
- (13) After entering the data, the next data is displayed at the address, M-data and F-code. The position data shows the current position of the robot.



CAUTION

- When you check the stored data in TEACH mode, press the  key after setting the address with the numeric keys. While the  key is being pressed, the stored position data is displayed and "OLD DATA Vx.xx" is displayed on the message line. (Vx.xx means the version of the built-in software.)

A-CAL



- If you press the  key before completion of the A-CAL operation (when the A-CAL indicator is OFF) in step (10), "A-CAL INCOMPLETE !!" is displayed on the message line and the data cannot be entered. Perform A-CAL referring to Chapter 3, "A-CAL (Automatic Calibration)."

CHAPTER 6 CHECK Mode

6.1 General

CHECK mode enables you to check the position data, which has been entered in the KEY-IN or TEACH mode, by physically moving the robot.

Change the controller mode to MANUAL and press the  +  keys to change to CHECK mode.

It is highly recommended to check the position data in CHECK mode before automatic operation for the safety and to prevent the misprogramming or malfunction of the robot.

While operating the robot in CHECK mode, hold a Deadman switch. If you release the Deadman switch, the system goes into Emergency Stop status.

6.2 Functions

6.2.1 Positioning Method

There are two methods, Point to Point (PTP) and Continuous Pass Control (CPC) movements. You can select the positioning method by the M-data in CHECK mode.

M=0	: No positioning
M= 1-79	: PTP movement
M=80-89	: CPC movement
M=90-99	: PTP movement

Also, S-code affects the robot positioning method. Refer to Chapter 16, "Robot Operation."

6.2.2 Speed Setting

The speed can be set at 10 different levels, from 0 to 9. "0" is the minimum speed and "9" is the maximum speed. At maximum speed "9" in CHECK mode, the robot moves at 250mm/sec for safety.

6.2.3 Auto Pull-Up Function

If the Z-Axis is at a position lower than the pull up value in the System Parameter ⁱ, 「MOTION」→「MOTION」→「PULL-UP」 (Refer to 19.1.1, "MOTION"), the Z-Axis will move upwards until the "pull-up" distance is reached. If the axis is at a position higher than the "pull-up" distance, the Z-Axis will not move.

This function prevents the robot from interfering with work and other devices. Note that the auto pull-up function is not valid at certain M-data or S-code positions. Refer to Chapter 16, "Robot Operation" for details.

ⁱ: Press the  +  keys.

6.2.4 Display in CHECK Mode

In CHECK mode, the position data shows the current position of each axis in same manner in TEACH mode.

0050	M10	F99	S00	R0
X	0500.	05	Y	0080.00
Z	0020.	10	W	0100.00
CHECK	RB1	[WORLD]		

Fig. 6.1 Display in CHECK Mode (Robot 1 with 4 Axes)

6.3 Speed Setting in CHECK Mode



- Press the key in CHECK mode to light up the 『SHIFT』 LED. Then press the key and the display shows “CHECK SPEED DATA?> *” on the message line (“*” shows the value of speed data, 0 to 9).

- Set the speed with the numeric keys, 0 to 9.

- Press the key and message line shows “ENTER OK?” Press the key again to enter the data. If you want to cancel the data, press the key and enter the correct data.



- Entering the speed data sets the speed for all axes. Setting the speed data for one axis is not possible. Speed designation in CHECK mode affects the motion speed regardless of the speed designated in the System Parameter.
- In CHECK mode, the robot moves at the designated speed. Although, the maximum speed in TEACH mode is 250mm/sec for the CPC motion, and for the other motions, 1/4 speed of the maximum speed of the robot is used.

6.4 Basic Operation Procedure

The following are the basic operation procedures in CHECK mode.



CHECK mode moves the robot semi-automatically. Misoperation may cause injury and interference with other devices. Before operating the robot, make sure that all personnel and obstructions are outside the maximum reach of the robot. Do not enter into the operational area during operation of the robot.

- Press the + keys to change to CHECK mode.
- Keep pressing the Deadman switch while operating in TEACH mode.







(3) Perform A-CAL. It is not necessary to perform A-CAL if it is completed or the 『A-CAL』 LED is OFF.

(4) Set the speed in CHECK mode.

(5) Enter the address which you wish to confirm the position.

Enter the address with the numeric keys and press the  key.

(6) After setting the address, press the  key. While pressing the  key, the robot moves to the position which is specified by the address. If the  key is released or an error occurred, the message line shows “INCOMPLETE” and the robot stops.

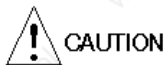

After the positioning is done successfully, “COMPLETED” appears on the message line and a buzzer sounds. To continue the positioning to the next address, release the  key and keep pressing the  key again until the positioning is done.

When the 『SHIFT』 LED is lit during the CPC or the Pass PTP motion, the positioning is completed every time an arc or a straight line ends. Release and press the  key to position to the next address (Refer to 16.3.1, “Notes on CPC Operation”).





A-CAL



- In CHECK mode, normally the current position data of the robot is displayed. To check the stored position data, press the  key after setting the address data with the numeric keys. While the  key is being pressed, the stored position data is displayed and “OLD DATA Vx.xx” is displayed on the message line (Vx.xx means the version of the built-in software.).
- If you press the  key before completion of the A-CAL operation (when the 『A-CAL』 LED is OFF), “A-CAL INCOMPLETE !!” is displayed on the message line and the data cannot be entered. Perform A-CAL referring to Chapter 3, “A-CAL (Automatic Calibration).”
- The positioning method of the robot is affected by M-data or S-code. Refer to 16.4.1, “List of M-Data Functions” and 16.4.2, “List of S-Code Functions” for details.

CHAPTER 7 ON-LINE Mode

The robot is controlled by communication with external devices in this mode. The robot performs automatic operation.

Change the controller mode to AUTO and press the  +  keys to enter ON-LINE mode.

The automatic operation is performed in two modes:

- AUTO
- ON-LINE

AUTO mode should be selected when communicating with the external PLC through the parallel I/O. ON-LINE mode should be selected when communicating through the serial I/O (RS-232C).

AUTO or ON-LINE mode can be selected by System Generation ¹ 「ORIGIN」→「SET-UP SYSTEM」→「AUTO/ON-LINE」. If AUTO mode is selected, the message line shows “AUTO.”

0050	M10	F99	S00	R 0
X	0500.	05	Y	0080.00
Z	0020.	10	W	0100.00
AUTO		RB1		[WORLD]

Fig. 7.1 Display in AUTO Mode (The Robot 1 with 4 Axes)

In ON-LINE mode, the display shows “ON-LINE ” on the message line at “AUTO,” and the address and the position data show the stored positioning data as following figure shows.

0050	M10	F99	S00	R 0
X	0500.	05	Y	0080.00
Z	0020.	10	W	0100.00
ON-LINE		RB1		[WORLD]

Fig. 7.2 Display in ON-LINE Mode (The Robot 1 with 4 Axes)

¹: Press the  +  keys.

7.1 AUTO Mode

In AUTO mode, the HNC controller controls automatic robot operation by exchanging signals with an external PLC and has 16 ports for DI and DO. Their assignment is fixed.

There are two ways for positioning. The sequential access performs positioning the robot in the order of stored position address, and the random access performs at random by selected position addresses.



CAUTION

- The speed in AUTO mode is set by System Parameter and F-code.
- When using more than a 1,000 points of address positions, set extended AUTO mode (Refer to 7.2, "Extended AUTO Mode").

7.1.1 DI Signals

The following table describes the DI signal allocation and description for each signal.

Table 7.1 DI Signal Allocation (Standard)

No.	Signal	Function
IN0	SELECT	A-CAL request
IN1	START	Positioning start
IN2	NEXT	Positioning to next address
IN3	HOLD	Not used. (Normally servo lock ON)
IN4	POS/INCH	Select signal from IN6 to IN15 ON : Positioning address signal OFF : Manual operation signal in INCH mode
IN5	STOP	ON : Stop of operation
IN6	ADDRESS 8 [256]/axis	Selecting at "IN4" • Position address designation in binary (in []) at PTP movement. • Signal to manipulate axis at INCHING. IN6: Select signal IN8 to IN11 ON : R and C-Axes OFF : X and Y-Axes IN7 ON : High-speed inching
IN7	ADDRESS 9 [512]/high speed	
IN8	ADDRESS 0 [1] /+X(+R)	
IN9	ADDRESS 1 [2] /-X(-R)	
IN10	ADDRESS 2 [4] /+Y(+C)	
IN11	ADDRESS 3 [8] /-Y(-C)	
IN12	ADDRESS 4 [16] /↑Z	
IN13	ADDRESS 5 [32] /↓Z	
IN14	ADDRESS 6 [64] /+W	
IN15	ADDRESS 7 [128]/-W	

- (1) SELECT (IN0) : A-CAL request signal ()

This signal requests the signal "Ready for starting operation" that goes to the controller from an external device, such as PLC. Except in AUTO mode, the HNC will not respond to this signal. After receiving the SELECT signal, the POS/INCH signal (IN4) is confirmed.

- When POS/INCH is ON (Positioning mode)
The robot performs the A-CAL operation if A-CAL has not already been completed. Then, READY and PCA signals turn ON and inform that it is in positioning mode to PLC.

When the AUTO mode is changed to another mode, the READY signal will be turned OFF. If this signal is turned OFF during the PTP operation, the READY signal will be turned OFF and the robot stops.

- When POS/INCH is OFF (Inching mode)

The controller turns the READY signal ON to inform that it is in inching mode to PLC.

If A-CAL has been completed, the robot can be operated with the inching motion in both LI-TEACH or RO-TEACH mode. If not, the inching motion can be performed in RO-TEACH mode only.

- (2) START (IN1) : Positioning start signal ()

This signal's purpose is to start positioning. It comes from the PLC and goes to the robot controller. Unless the POS/INCH signal is ON (Positioning mode), the controller ignores this signal.

While both the READY and the PCA signals are ON, the position address signals (ADDRESS 0~9) are read. This START signal is turned ON and the robot moves to the position of the specified address. The address which has M-data = "0" is ignored and the address which has M-data = "??" (End point) the robot's ends positioning.

When this START signal is turned ON, the robot moves to the position of the specified address after turning OFF the PCA signal.

Positioning to specified addresses is called "**Random access.**"

- (3) NEXT (IN2) : Next positioning start signal ()

This signal's purpose is to start next positioning. Unless the POS/INCH signal is ON (Positioning mode), the controller ignores this signal.

If the next address has M-data = "0," it is ignored and the next address is read. If M-data is "??" (End point), the robot ends positioning.

Next positioning start can be also performed using the START signal (IN1). However, if you use the NEXT signal, you do not need to designate the position address every positioning. Once the position address to start is selected by the PLC, the robot can perform positioning by switching the NEXT signal from ON to OFF. This operation is called "**Sequential access.**"

When the robot is stopped by E.S. or by power shutdown during automatic operation with the NEXT signal, the current address which was interrupted will be held. After the E.S. is released or the power is supplied, the robot resumes the motion from the held address or the next address by receiving the NEXT signal. The System Parameter, 「ORIGIN」→「SET-UP SYSTEM」→「STORE ADDRESS」 is to select whether the robot resumes the positioning to the interrupted address, or moves to the next address. (Normally it is set to 0)

(4) HOLD (IN3) : Servo lock signal

This is for the servo lock signal. While the robot is outputting a PCA signal, this signal locks (ON) or frees (OFF) the robot. When the PCA (servo lock) signal is OFF, the only axes equipped with a brake will be held by a brake instead.

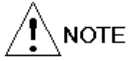

NOTE

Set the servo lock signal to ON normally in any mode of the robot unless setting the signal to OFF is required.

(5) POS/INCH (IN4) : POS/INCHING select signal

This signal's purpose is to select the positioning (ON) or the inching (OFF) operation.

- Positioning : The robot moves to a specified position address by the PTP or CPC movement.
- Inching : Each axis moves.

(6) STOP (IN5): Stop signal of operation

This signal's purpose to stop the robot operation. While the robot performs positioning and this signal turns ON, the robot stops the operation and the PCA signal turns ON. While the STOP signal is ON, the message line on the Teach Pendant shows "STOP ON."

After turning OFF the STOP signal, turns ON the START (IN1) or the NEXT (IN2) signal. The robot operation is restarted by inputting the START or the NEXT signal. If the SELECT signal is turned OFF when the STOP signal is ON, set the SELECT signal ON after turning OFF the STOP signal.

This signal can work as an INTERLOCK (pause) signal which continues the motion right after setting OFF the STOP signal in positioning. The usage of the STOP signal can be selected by the System Generation, 「ORIGIN」→「SET-UP SYSTEM」→「STOP」.

(7) ADDRESS 0 to ADDRESS 9 (IN6 to IN15) : Position address signal

These signals specify the position addresses to be positioned when POS/INCH signal(IN4) is ON (Positioning mode), and also, when the POS/INCH signal is OFF (Inching mode). The signals are used as a inching signal same as the axis key function on the Teach Pendant.

Table 7.2 Position Address Signals (Normal)

No.	Positioning mode (START)	Inching mode
IN6	ADDRESS 8 [256]	Axis
IN7	ADDRESS 9 [512]	High-Speed
IN8	ADDRESS 0 [1]	+X (+R)
IN9	ADDRESS 1 [2]	-X (-R)
IN10	ADDRESS 2 [4]	+Y (+C)
IN11	ADDRESS 3 [8]	-Y (-C)
IN12	ADDRESS 4 [16]	↑ Z
IN13	ADDRESS 5 [32]	↓ Z
IN14	ADDRESS 6 [64]	+W
IN15	ADDRESS 7 [128]	-W

- In Positioning mode

These signals are accepted during the rising edge of the START signal. These signals are evaluated as binary numbers.

EXAMPLE

When you want to specify ADDRESS 10, set to ON IN9 and IN11. Then, set the START (IN1) signal ON as following.

Table 7.3 Position Address Setting Example

IN	8	9	10	11	12	13	14	15	6	7
Value	1	2	4	8	16	32	64	128	256	512
Set	0	1	0	1	0	0	0	0	0	0

2+8=10
(Address 10)

Set 1: ON
0: OFF

**NOTE**

In this method, you can designate 1,024 addresses, 0 to 1,023 with 10 DI signals, but only 1,000 position addresses, 0 to 999, are stored in the robot controller. When designating addresses of more than 999, a position address error occurs. Also, when an address more than the address restricted by the System Generation, 「LIMIT」→「ADDRESS MAX」→「ADDRESS MAX」 is designated, a position address error occurs. When using the addresses more than 1,000, set Extended AUTO mode. (Refer to 7.2, "Extended AUTO Mode" for details.)

- In Inching mode

During the INCHING operation (IN4: OFF), +X, -X, +Y, -Y, +Z, -Z, +W, -W (IN8~IN15) on Table 7.2, Position Address Signals, are assigned to axis keys on the Teach Pendant. When IN6 is ON, the input for the X-Axis becomes the input for the R-Axis and input for Y-Axis becomes the input for C-Axis.

When IN7 is OFF, the inching speed is low and the speed set by the System Parameter, 「RESPONSE」→「RESPONSE」→「INCHING SPEED」. When it is ON, the axes move at high speed which is dependent on the robot type. The maximum speed of inching mode is 250mm/sec.

Table 7.4 Inching Speed Setting

IN7	Inching speed
OFF	Low-SPEED
ON	High-SPEED

For example, If IN7 is set to OFF and the INCHING mode is selected (IN4: OFF) while in the automatic operation, the PCA signal turns OFF. If IN8 is set to ON, X-Axis moves in the +X direction at low speed. When IN6 is ON, X-Axis stops and R-Axis moves in the +R direction at low speed.

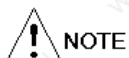
**NOTE**

If the robot performs positioning using the START/NEXT signal in condition at the servo lock signal is OFF, it will take maximum 300msec before starting positioning (because it performs brake release without regarding the motor is equipped with brake or not.)

The following table shows the setting of the inching axes, each setting (IN8-IN15) and IN6.

Table 7.5 Inching Axes Setting

IN6	IN8	IN9	IN10	IN11	IN12	IN13	IN14	IN15
OFF	+X	-X	+Y	-Y	+Z	-Z	+W	-W
ON	+R	-R	+C	-C	+Z	-Z	+W	-W

7.1.2 DO Signals

The allocation of the DO signals to the connector pins is given in following table.

Table 7.6 DO Signals

DO No.	Signal	Function
OUT0	READY	Ready for automatic operation
OUT1	ERROR	Error indication
OUT2	PCA	Positioning completion acknowledgement
OUT3	AUTO	AUTO mode indication
OUT4	BP·AREA	Pass PTP output or base area position output
OUT5	ZONE	Z-Axis zone output
OUT6	CPOUT /C	CPC movement output
OUT7	A-CAL /R	A-CAL completion
OUT8	MOUT0 (1) /W	Output signals assigned by M-data or error code displayed in binary code ().
OUT9	MOUT1 (2) /Z	
OUT10	MOUT2 (4) /Y	
OUT11	MOUT3 (8) /X	
OUT12	MOUT4 (10) /	
OUT13	MOUT5 (20) /	
OUT14	MOUT6 (40) /	
OUT15	MOUT7 (80) /	

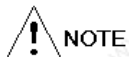

NOTE

The code after "/" in OUT6-OUT25 shows the axis in error. Make sure that the CPOUT signal and the A-CAL signal are invalid when an error occurs.

(1) READY (OUT0) : Ready for automatic operation

This signal indicates that the controller is ready for communication with external device and can control the robot with the START or NEXT signal input. Therefore, this signal cannot be turned ON while the mode is other than in AUTO, or when the E.S. button has been pressed. When the controller receives the SELECT signal, and if the A-CAL operation has been completed, this signal will be turned ON. If not, the A-CAL operation will be performed and then it will be turned ON.

(2) ERROR (OUT1) : Error indication signal

When the controller detects a fault and stops operation, this signal is turned ON. While this signal is ON, the display on the Teach Pendant indicates an error message and an error code is output to one of the MOUT signals. The error codes and their functions are shown in following table. The error is reset on the falling edge of the SELECT signal.

Table 7.7 Error Code (OUT6-15)

Error code (Hexadecimal)	Error message	Function
0 *	POS ERROR	Positioning is not completed
1 0	EMERGENCY STOP.	Emergency Stop status
2 *	AcalErr0	ORIGIN sensor does not turn ON
2 *	AcalErr1	ORIGIN sensor does not turn OFF
2 *	AcalErr2	OVERRUN sensor turns ON
2 *	AcalErr3	Counter does not reset
2 *	AcalErr4	Counter reset is short
2 *	AcalErr5	Counter reset is over
2 *	AcalErr6	Counter is minus
3 0	ADDRESS_ERROR	Address error
4 *	AREA_ERROR	Area error
5 *	OVERRUN	Overrun
6 3	SYSTEM_DATA_ERROR	System data error
6 4	POSITION_DATA_ERROR	Position data error
6 7	SERVO_DATA_ERROR	Servo parameter error
7 0	CPU_LOW_BATTERY	The battery on the CPU board is low (Axis is not defined)
7 *	ENC_BATTERY	Encoder battery is low (Axis is defined)
9 6	POSITIONING_ERROR	Positioning error
A 0	DRIVER_NOT_ONLINE	Amplifier/Driver is not responding (Axis is not defined)
A *	DRIVER_ERROR	Amplifier/Driver error (Axis is defined)
B 0	SERVO_ON_ERROR	Unable to servo lock.

"*" is assigned to the axis distinction of 6 bits (OUT6-11). Refer to Table 7.8.

EXAMPLE

When the axis is defined, the upper part of the error code corresponds with M-data output and the lower part shows the status of each axis on the message line.

"AREA ERROR 101000" shows X(A) and Z-Axes are out of the permissible area. The error code is output as follows;

Table 7.8 Error Code Axes Definition

	Error code				Error axis code					
					A	B	Z	W	R	C
OUT	15	14	13	12	11	10	9	8	7	6
Output	0	1	0	0	1	0	1	0	0	0

Area error (0x4*)

0: OFF 1: ON



NOTE

When an error occurs, the A-CAL signal (OUT7) and the CPOUT signal (OUT6) are invalid as they are assigned to the error bits for R and C-Axes.

An error code is output to the MOUT signals (OUT6-OUT15) with error indication signal (ERROR: OUT1). The format to output is the same as M-data output from the MOUT signals. The error codes in the Table 7.7, Error code (OUT6~15), without “*” are output to the MOUT signals (OUT8-15). When an error occurs, except for the ones above, error codes are not output to the MOUT signals, but the ERROR detection signal (OUT1) is output.



WARNING

An EMERGENCY STOP (E.S.) error is not reset by SELECT (IN0) signal OFF like other errors. When E.S. status is released, the robot is reset automatically and will be in the initial status of AUTO mode. The SELECT signal should be kept OFF until E.S. status is reset.

(3) PCA (OUT2) : Positioning completion acknowledgement signal

This signal means that the robot is ready to move upon receiving the START or the NEXT signal. Therefore, when the robot has been properly positioned and the START or the NEXT signal is OFF, the PCA signal is turned ON. When the START or the NEXT signal is turned ON, PCA is turned OFF and the robot starts positioning.

When the READY signal is turned ON, PCA is turned ON immediately; when READY is turned OFF, PCA is also turned OFF. This means that unless READY is ON, PCA cannot be turned ON.

(4) AUTO (OUT3) : AUTO mode signal

This signal is ON while the mode is in AUTO mode. When the mode is set to one other than AUTO, the signal is turned OFF.

(5) BP (OUT4) : Base position signal (Base Position)

This signal is output during Pass PTP (Refer to 16.2, “Pass PTP Operation.”) and also during the output of A, B (X, Y) area output signals and the base position output signal. (Refer to 19.4.1, “Expansion A, 「Base Pos Addr *」” and 19.4.2, “Expansion B, 「AREA AX」, and 「AREA BY」” for details.)

(6) ZONE (OUT5) : Z-Axis zone output

When the Z-Axis moves past the position set by the System Parameter, 「RESPONSE」→「RESPONSE」→「SAFE. ZONE」, this signal is ON. When moving down, the signal is OFF.

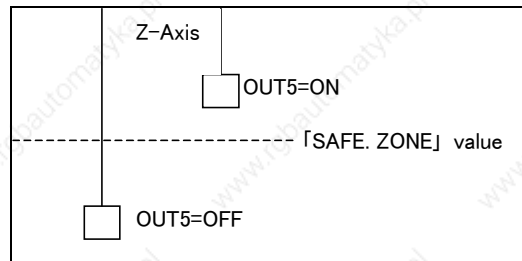

Fig. 7.3 「SAFE. ZONE」



NOTE

- The ZONE signal cannot be output if A-CAL is not completed.
- This signal can be output in any mode except for KEY-IN mode.
- When using Z-Axis auto pull-up function, set the value of the safety zone by the System Parameter, 「RESPONSE」→「RESPONSE」→「SAFE. ZONE」 larger than the value of PULL-UP, 「MOTION」→「MOTION」→「PULL-UP」. If the value of SAFETY ZONE is the same as the value of PULL-UP, ZONE OUTPUT will switch repeated (i.e., between ON and OFF) or will be unable to turn ON.

(7) CPOUT (OUT6) : Output at CPC operation

When operating in CPC operation, this signal is used. Refer to 16.3, “CPC Operation” for details.

When an error occurs (OUT2: ON) during automatic operation, the CPOUT signal output is canceled. This signal will be valid again after the error recovery.

(8) A-CAL (OUT7) : A-CAL completion

If A-CAL of the robot is completed, this signal is ON. The meaning and function of this signal are the same as the 『A-CAL』 LED on the Teach Pendant.

When an error occurs (OUT2: ON) during automatic operation, the A-CAL signal output is canceled. This signal will be valid again after the error recovery.

(9) MOUT0-MOUT7 (OUT8-OUT15) : M-data output signal

The MOUT signals are related to the M-data, which is the output pattern to the output port of the robot driver, as shown in Table 7.9.

Table 7.9 M-data Output Signal



M-data	OUT8	OUT9	OUT10	OUT11	OUT12	OUT13	OUT14	OUT15
	MOUT0	MOUT1	MOUT2	MOUT3	MOUT4	MOUT5	MOUT6	MOUT7
0								
1	ON							
2		ON						
3	ON	ON						
4			ON					
5	ON		ON					
6		ON	ON					
7	ON	ON	ON					
8				ON				
9	ON			ON				
10					ON			
20						ON		
30					ON	ON		
40							ON	
50					ON		ON	
60						ON	ON	
70					ON	ON	ON	
80								ON
90					ON			ON

- M-data can be set from 0 to 99 and output in the combinations above (BCD). The following is an example of combination of M-data that is greater than M-data=11. For example, M-data=15 means the combination of M-data=10 and M-data=5 is output. The blanks in the table mean OFF.
- When M-data=0, no positioning occurs and no signals are output, the program advance to the next address (JUMP function).
- At the END POINT (M-data=?), all of the MOUT signals are ON.
- M-data will be output at the start of operation. At the position selected during the Pass PTP and the CPC operations, the M-data of the position is output.

7.1.3 Random Access

This method enables you to move the robot to the specified address by switching the START signal ON and then OFF.

In the following description, signal exchange with PLC is assumed. For the meaning of the individual signals, refer to 7.1.1, "DI signals" and 7.1.2, "DO signals" for details.

- (1) Press the  +  keys to change to AUTO mode.
- (2) Turn ON the SELECT signal (IN0) and POS/INCH signal (IN4) with the PLC. If 『A-CAL』 LED on the Teach Pendant is not lit, the robot will perform A-CAL.
- (3) The controller receives the SELECT signal and turns ON the READY and PCA signals.
- (4) As PCA is turned ON, the signals for the desired position, ADDRESS 0-9, and the START signal are output by the PLC.
- (5) The controller turns OFF the PCA signal, positions the robot to the specified address, outputs the MOUT signal corresponding to the M-data, and turns ON the PCA signal again after A-CAL completion.
- (6) Thereafter, steps (4) and (5) are repeated.
- (7) When END is detected at the M-data end (M-data=??) address, all the MOUT signals and the PCA signal are output.
- (8) When the PLC receives this END signal, it outputs the ADDRESS 0-9 specified in step (4) and the START signal. Then repeats steps (4) to (7)

The following timing chart is the exchange signals with PLC.

● Timing chart for normal positioning (Random access)

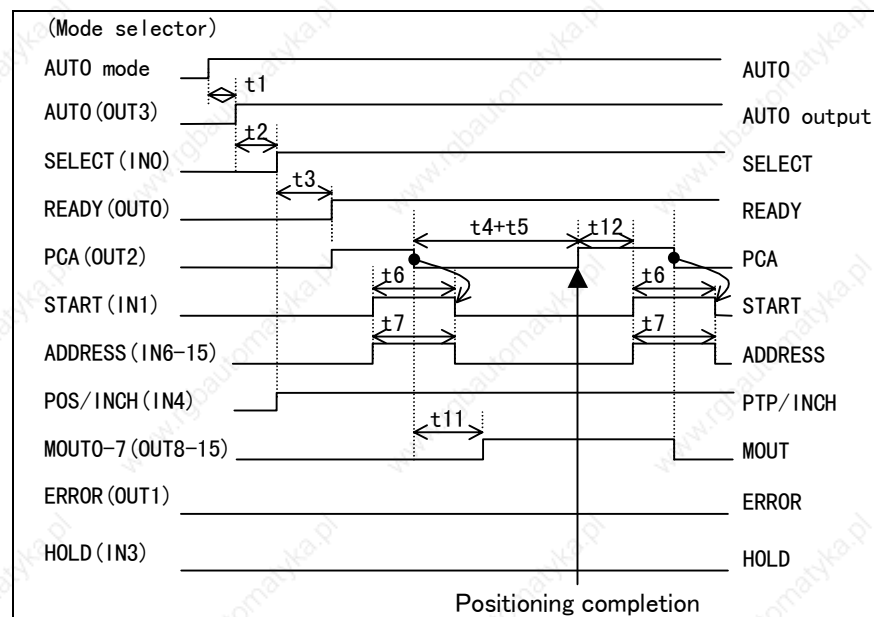

Fig. 7.4 Random Access

● Positioning timing chart involving ERROR

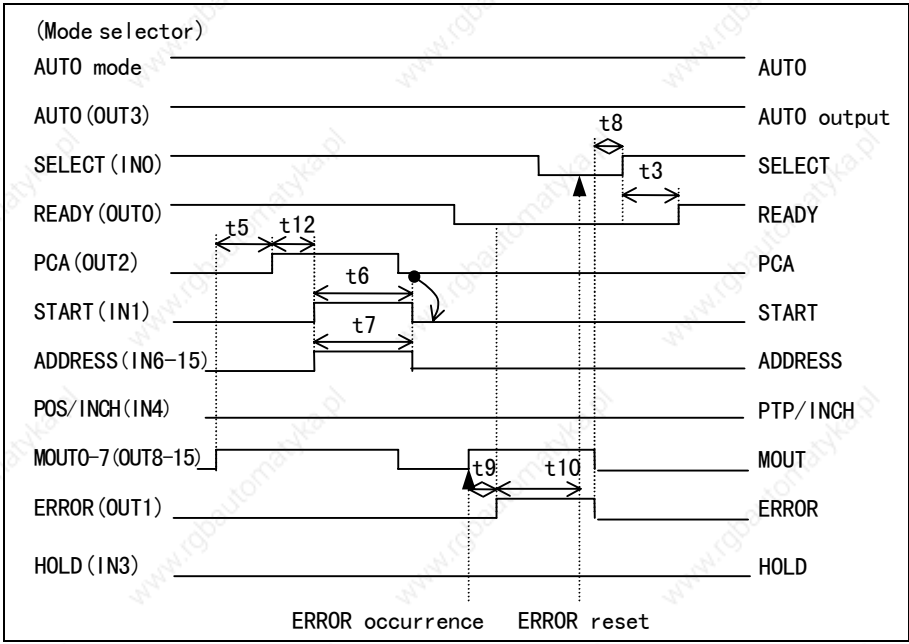

Fig. 7.5 ERROR Occurrence

● Timing chart when positioning data has END

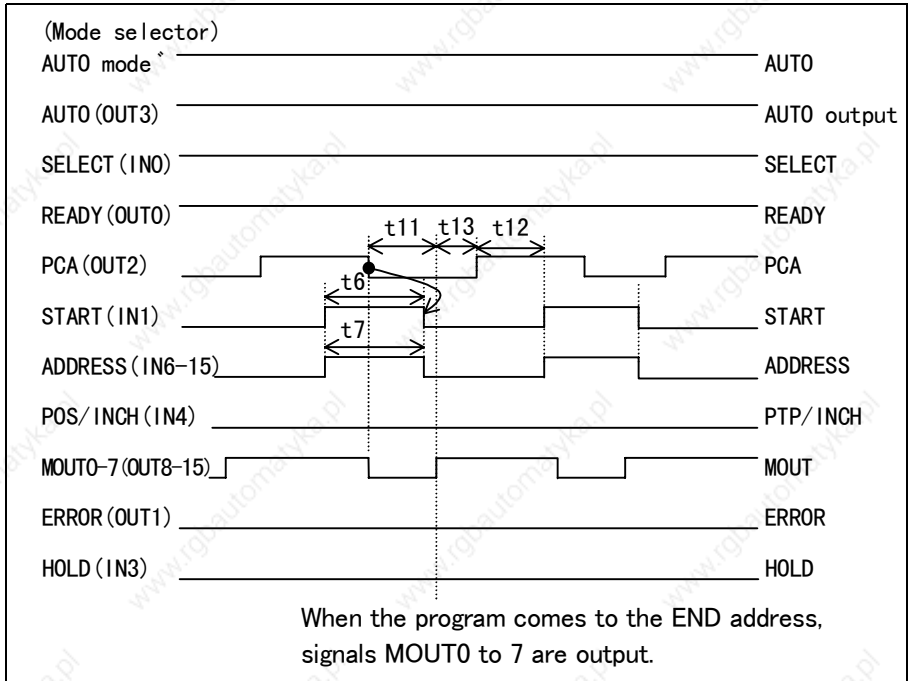

Fig. 7.6 END Address

- t_1 : 1.3sec minimum 3.6 seconds after POWER is turned ON.
- t_2 : 300msec Time to accept the SELECT signal after AUTO output is turned ON.
- t_3 : 300msec + α Time from the rising edge of SELECT signal to output of READY signal (α is the A-CAL time.)

- t4: Positioning time Traveling time from current point to next point (only if the next position is the same as current position, t4: \approx 70msec.)
- t5: 64msec Time for positioning confirmation until the robot has positioned within the accuracy.
- t6: PCA→OFF Required time to accept the START signal (10 msec minimum.)
- t7: PCA→OFF Required time to accept the ADDRESS signal (25 msec minimum.)
- t8: 140msec Time to accept the SELECT signal after ERROR reset.
- t9: 10msec. Time to output ERROR ON after outputting ERROR.
- t10: 45msec Time to confirm SELECT OFF after outputting ERROR.
- t11: 40msec Time to output MOUT after PCA OFF.
- t12: 30msec Time to accept STAR signal after PCA ON.
- t13: 10msec Time to output PCA after MOUT at END point.



NOTE

If the robot performs positioning using the START/NEXT signal in condition at the servo lock signal is OFF, it will take maximum 300msec before starting positioning (because it performs brake release without regarding the motor is equipped with brake or not.)

7.1.4 Sequential Access

With this method, the START signal is first output to determine program start address, then the NEXT signal is used to execute successive positioning points until returning to the initial starting address at the END signal. Therefore, only starting address need be specified.

This method is valid when using standard DI/DO interface. In extended AUTO mode, the NEXT signal is not assigned.

The application is almost the same as Random Access method. The difference is, the Sequential Access method is not required to specify the positioning address each time if the order of addresses input in TEACH or KEY-IN mode and the order of actual operation are almost same. Only first starting address need to be specified.

The controller automatically selects the next address after receiving the NEXT signals.

● Timing chart for ordinary positioning (Sequential access)

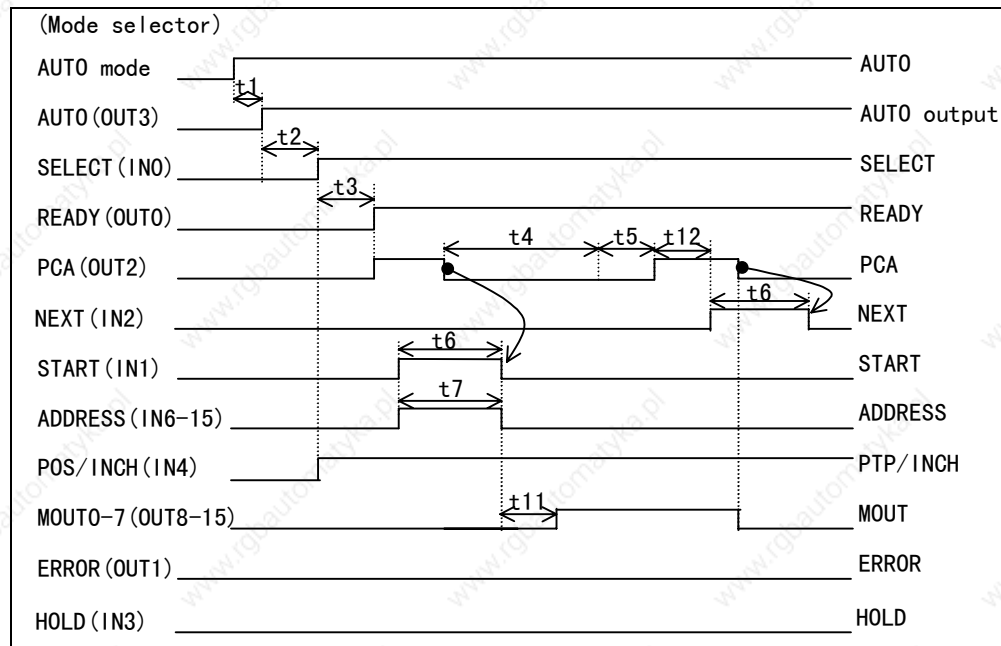

Fig. 7.7 Sequential Access

The time delays (t) are the same as for the Random Access method.

The chart for cases involving ERROR and END are the same as for the Random Access method.

● Error occurrence while positioning

When an error occurs while positioning, the ERROR signal is output to PLC or an error message is displayed on the message line on the Teach Pendant. (Refer to Chapter 23, "Message.")

To recover from the error;

- ① Confirm the type of error referring to the error message.
- ② Turn OFF the SELECT signal after confirming the error. The ERROR signal turns OFF and performs error recovery.
- ③ Turns ON the SELECT signal again after error recovery.



- The time to turn the SELECT signal ON after it is turned OFF, during PTP operation, is 0.5 second.
- Set the START and the NEXT signals to OFF when accepting the SELECT signal or outputting the MOUT and the PCA signals.
- If the Random Access method is used, ADDRESS must be fixed when the START signal is ON.
- If the MOUT signal output cannot be read correctly when the PCA signal and the ERROR signal are ON, read it after delaying one scan of the PLC after the PCA and ERROR signal inputs or use a timer.
- While the ERROR signal is being output, it is confirming the SELECT signal is ON. Therefore, do not turn OFF the SELECT signal during time "t10" when resetting the error by SELECT OFF.
- It is recommended not to output a signal by using a timer (Especially, START, NEXT, and ADDRESS signals) because each I/O signal is based

on "hand shake" (i.e., an exchange of information) between the HNC controller and the PLC.

- EMERGENCY STOP (E.S.) error is not reset by SELECT OFF. When E.S. state is released, the robot is reset automatically and will be in the initial status of AUTO mode. Turn OFF the SELECT signal until the E.S. state is released.

7.1.5 Operational Flowchart

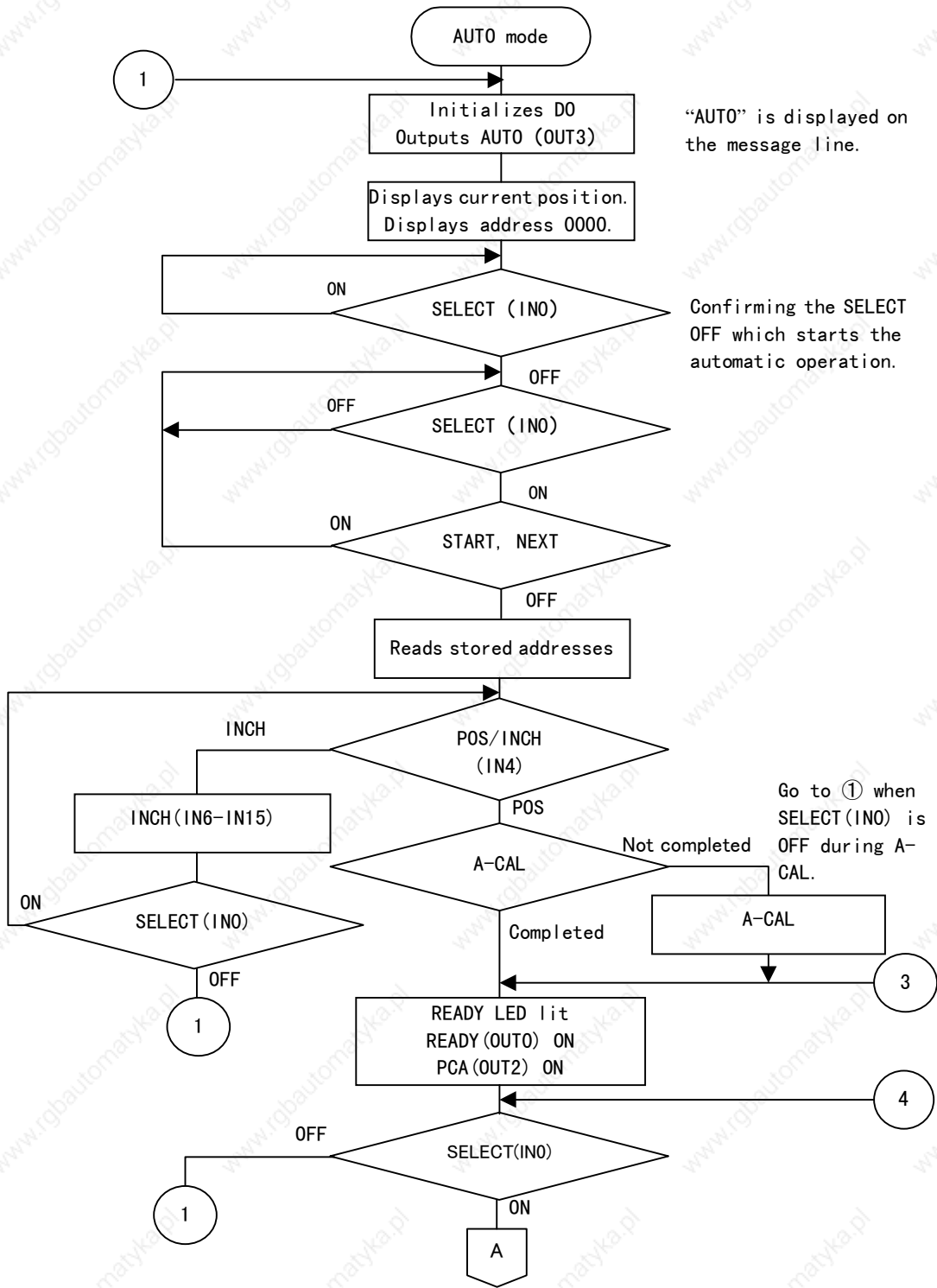

Fig. 7.8 Automatic Operation①

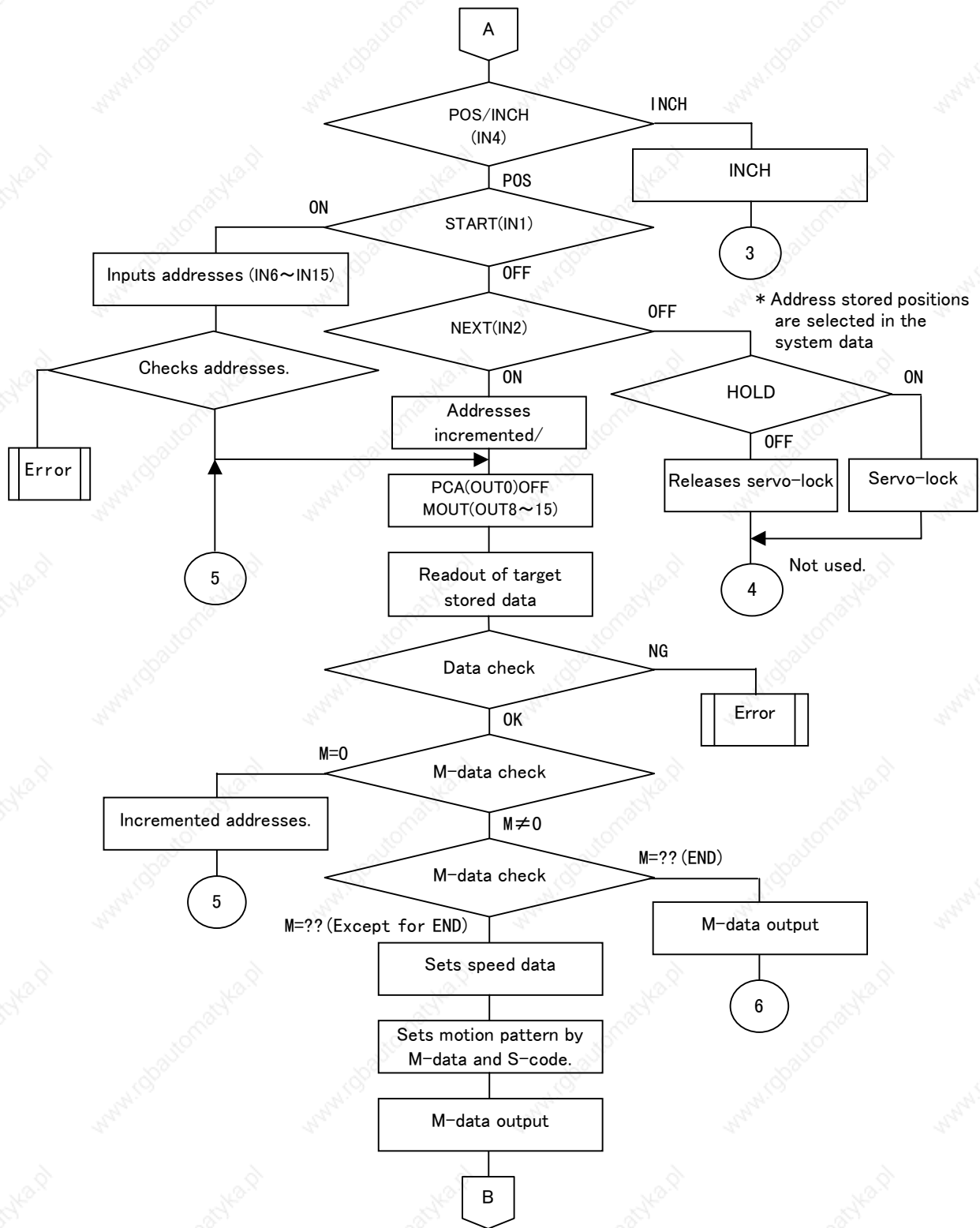

Fig. 7.9 Automatic Operation②

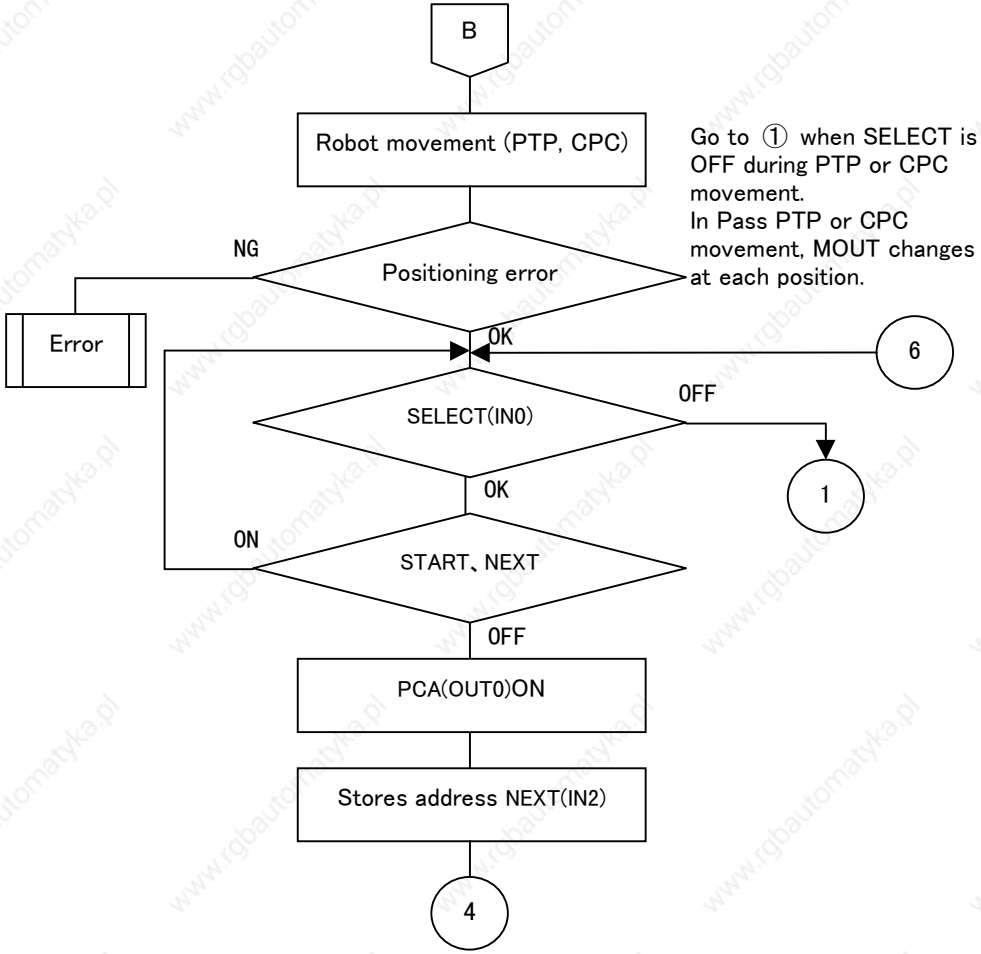

Fig. 7.10 Automatic operation③

7.1.6 Positioning Data Load From Memory Card in Auto Mode

When the position memories stored in the controller are not sufficient for your application, the data stored in the optional memory card can be downloaded to the controller using the DI signal in AUTO mode.

When downloading the stored memory, specify the file name using the address designation input ports AUTO(IN 6 -IN15). Thus, when saving the position data to the memory card, the file name must be 0 to 1023.

The position data in the memory card are automatically downloaded to the same position addresses as when the data was saved to the memory card. So you cannot designate the position addresses to be loaded from the memory card to the controller.

Hand-shake with DI/DO signals when loading the data from the memory card is as in the following figure.

OUT6 signal means that the controller is in the memory card download mode. When this signal turns OFF, it means the data download has completed.

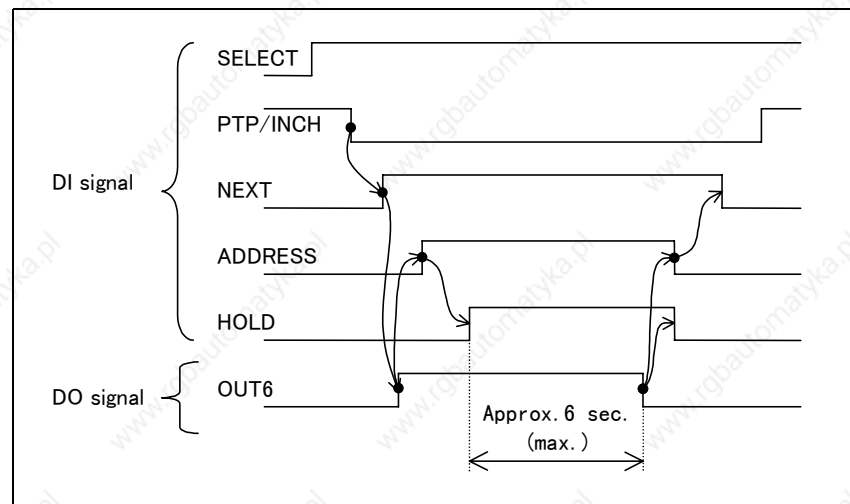

Fig. 7.11 Timing Chart for Data Loading from the Memory Card



CAUTION

- When setting the POS/INCH signal to OFF, the address designation data must be 0.
- After setting the NEXT signal to ON, wait until OUT6 turns ON. Then, designate the file name by ADDRESS input and turn HOLD to ON.
- After OUT6 turns OFF, set the HOLD and ADDRESS signals to OFF. Then, set the NEXT signal to OFF. For normal automatic operation, turn the POS/INCH signal to ON and turn to POS mode.

7.2 Extended AUTO Mode

To enter extended AUTO mode, set the data by System Generation, 「ORIGIN」→「SET-UP SYSTEM」→「AUTO/ON-LINE」 to “EXT AUTO.”

This mode is almost same as the AUTO mode except that the assignment of DI signals. The assignment of DI signals in extended AUTO mode is shown below.

This mode can be used the maximum 4000 addresses.

Table 7.10 Assignment of DI Signals (Extension)

No.	Signal	Function
IN0	SELECT	Ready for automatic operation
IN1	START	Positioning start
IN2	POS/INCH	Select signal from IN4 to IN15 ON : Positioning address signal OFF : Manual operation signal in INCH mode
IN3	STOP	ON : Stop of operation
IN4	ADDRESS 0 [1] /+X	Selecting at “IN2” • Position address designation in binary (in []) at PTP movement. • Signal to manipulate axis at INCHING.
IN5	ADDRESS 1 [2] /-X	
IN6	ADDRESS 2 [4] /+Y	
IN7	ADDRESS 3 [8] /-Y	
IN8	ADDRESS 4 [16] /↑Z	
IN9	ADDRESS 5 [32] /↓Z	
IN10	ADDRESS 6 [64] /+W	
IN11	ADDRESS 7 [128] /-W	
IN12	ADDRESS 8 [256] /+R	
IN13	ADDRESS 9 [512] /-R	
IN14	ADDRESS 10 [1024] /+C	
IN15	ADDRESS 11 [2148] /-C	

Table 7.11 Position Address Signals (Extension)

No.	POS (START)	INCHING
IN4	ADDRESS 0 [1]	+X
IN5	ADDRESS 1 [2]	-X
IN6	ADDRESS 2 [4]	+Y
IN7	ADDRESS 3 [8]	-Y
IN8	ADDRESS 4 [16]	↑Z
IN9	ADDRESS 5 [32]	↓Z
IN10	ADDRESS 6 [64]	+W
IN11	ADDRESS 7 [128]	-W
IN12	ADDRESS 8 [256]	+R
IN13	ADDRESS 9 [512]	-C
IN14	ADDRESS 10 [1024]	+C
IN15	ADDRESS 11 [2048]	-C

When you want to specify ADDRESS 10, set IN5 and IN7 signals ON and then set the START signal ON.

Table 7.12 Specifying Address (Extension)

IN	4	5	6	7	8	9	10	11	12	13	14	15
Value	1	2	4	8	16	32	64	128	256	512	1024	2048
Input	0	1	0	1	0	0	0	0	0	0	0	0

2+8=10
(ADDRESS 10)

Input 1: ON
0: OFF

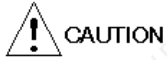

The function of downloading the position data from the memory card is not supported in extended AUTO mode

7.3 ON-LINE Mode

ON-LINE mode enables a robot to perform automatic operation by using a host computer and HAC (Hirata Assembly cell Controller) via RS232C interface.







In this mode, communication with external devices is available with our communication software. Refer to the separate instruction manual, HRCS-RIV for details.

In this mode, robot speed is set by the System Parameter, F-code, and the MOVE command.

CHAPTER 8 Data Editing

8.1 Entering END Point (M-Data=??)

After creating position data in KEY-IN or TEACH mode, an END point (M-data=??) should be specified. The END point (M-data=??) indicates the end of position data, and should be specified at the end of the position data. In automatic operation mode or CHECK mode, positioning to the END point (M-data=??) will not be performed.

- (1) Set the Teach Pendant to KEY-IN mode ( + ) or TEACH mode ( + ).
- (2) Display the address data for which an END point (M-data=??) will be specified.
- (3) Press the  key. The message "END WRITE OK?" will be displayed on the message line and a buzzer sounds.
- (4) Confirm that the address to be set is correct. Then, press the  key, the END point (M-data=??) will be set.

If you have specified a wrong address, press any key other than the  key to cancel the END point setting operation.

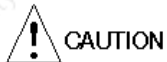





CAUTION

- The "END point" used in this chapter means a point where a series of robot movements is to be ended. The addresses following the one for which an END point is specified can be used as regular addresses.
- The M-data display section of an address for which an END point has been specified, "??" is displayed. This "??" is common for all the mode displays. To unset an END point, specify numerical values for the M-data display section of an address for which the END point has been set. When numerical values are assigned, the M-data will be treated as normal position data.
- When you are setting an END point, the data for X, Y, Z, W, R, and C are also checked. Therefore, if the data for X, Y, Z, W, R, and C are not correct, the END point cannot be specified.

8.2 Inserting Position Data

After creating position data in KEY-IN mode or TEACH mode and if you want to insert the position data, perform the following steps. Note that newly inserted position data influences the data which have already been taught. Therefore, care should be taken before inserting.



- (1) Set the Teach Pendant in KEY-IN mode ( + ) or TEACH mode ( + ).
- (2) Display the address data where the new data will be inserted. For example, when you want to insert new data between addresses 50 and 51, display "51."
- (3) After specify the data to be inserted, press the  key. At this time, the 『SHIFT』 LED remains unlit. The message "INSERT OK?" appears on the message line and a buzzer sounds.

SHIFT



CAUTION

When the  key is pressed with A-CAL not completed in TEACH mode, "A-CAL INCOMPLETE" appears on the message line and the data insertion will not be accepted.

- (4) Confirm that the address and data to be inserted are correct. If it is correct, press the  key to insert the data. To cancel the data inserting operation, press any key other than the  key.



WARNING

When the program controlling automatic operation of the robots is installed on the PLC, inserting position data will cause error in automatic operation. Data insertion changes the sequence of position data as in following table. Therefore, when data has been inserted, the program on the PLC must be modified accordingly.



CAUTION

Use precaution before inserting data. When data has been inserted, the data located after the limit address specified by 「LIMIT」→「ADDRESS MAX」→「ADDRESS MAX」 in the System Generation mode are eliminated.









Table 8.1 Position Data Insertion

Before		After	
Address	Data	Address	Data
4 9	M ₀ F ₀ X ₀ Y ₀ Z ₀ W ₀	4 9	M ₀ F ₀ X ₀ Y ₀ Z ₀ W ₀
5 0	M ₁ F ₁ X ₁ Y ₁ Z ₁ W ₁	5 0	M ₁ F ₁ X ₁ Y ₁ Z ₁ W ₁
5 1	M ₂ F ₂ X ₂ Y ₂ Z ₂ W ₂	5 1	Position data inserted
5 2	M ₃ F ₃ X ₃ Y ₃ Z ₃ W ₃	5 2	M ₂ F ₂ X ₂ Y ₂ Z ₂ W ₂
5 3	M ₄ F ₄ X ₄ Y ₄ Z ₄ W ₄	5 3	M ₃ F ₃ X ₃ Y ₃ Z ₃ W ₃

* The position data includes the data for S-code and LOCAL code.

8.3 Deleting Position Data

If you want to delete certain position data after creating position data in KEY-IN or TEACH mode, perform the following steps. Note that deletion of position data influences the data that have already been taught. Therefore, care should be taken before deleting.

- (1) Set the Teach Pendant to KEY-IN mode ( + ) or TEACH mode ( + ).
- (2) Display the address where the position data will be deleted.
- (3) Press the  key to blink the 『SHIFT』 LED. Press the  key. Then, the message “DELETE OK?” appears on the message line and a buzzer sounds.
- (4) Confirm that the correct address and data are to be deleted. After the confirmation, press the  key to delete the data. The current data will be deleted, and the data in the next address will be displayed. To cancel the data deleting operation, press any key other than the  key.



WARNING

When the program controlling automatic operation of the robots is installed on the PLC, deleting position data will cause error in automatic operation. Data deletion changes the order of position data as in following table. Therefore, when data has been deleted, the sequencer program must be modified accordingly.

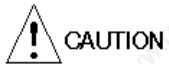

CAUTION

When data in an address has been deleted, the data in the last address specified by 「LIMIT」→「ADDRESS MAX」→「ADDRESS MAX」 in the System Generation mode will be copied into the address immediately before the last address. Data in each of the addresses following the address where the data have been deleted will be decremented one. Also, the last address is initialized.

Table 8. 2 Position Data Deletion

	Before		After	
	Address	Data	Address	Data
	4 9	M ₀ F ₀ X ₀ Y ₀ Z ₀ W ₀	4 9	M ₀ F ₀ X ₀ Y ₀ Z ₀ W ₀
	5 0	M ₁ F ₁ X ₁ Y ₁ Z ₁ W ₁	5 0	M ₁ F ₁ X ₁ Y ₁ Z ₁ W ₁
Data Deletion→	5 1	M ₂ F ₂ X ₂ Y ₂ Z ₂ W ₂	5 1	M ₃ F ₃ X ₃ Y ₃ Z ₃ W ₃
	5 2	M ₃ F ₃ X ₃ Y ₃ Z ₃ W ₃	5 2	M ₄ F ₄ X ₄ Y ₄ Z ₄ W ₄

*The position data includes the data for S-code and LOCAL code.

8.4 Copying Position Data

To copy position data into other addresses, perform the steps described below.

- (1) Set the Teach Pendant to KEY-IN mode ($\text{FUNC HIGH} + \text{F1}$).
- (2) Enter the source address, and press the READ key.
- (3) Enter the destination address, and press the ENTER key twice.

8.5 Editing Position Data in Blocks

Press the $\text{FUNC HIGH} + \text{p. ed 5}$ keys. This activates the block operation mode for position memory. The position data blocks that can be edited in this mode are those in address 0 up to the address which is specified by 「LIMIT」→「ADDRESS MAX」→「ADDRESS MAX」 in the System Generation mode. The details are as described below.

8.5.1 Basic Operation

The starting screen of this mode is illustrated below. Immediately after the activation of this mode, the shaded portion is displayed. To display the items following the “MODE COMMAND” in sequence, press the UP/DOWN key to scroll.

```





POSITION COMMAND
START ADDRESS  0000
END ADDRESS    0000
SET ADDRESS    0000
MODE COMMAND  [MOVE]
Push END Key !!
  
```

Fig. 8. 1 Position Data Block Edition

- (1) Enter the desired address in the space next to each of the “START ADDRESS,” “END ADDRESS,” and “SET ADDRESS.” And press the ENTER key twice to specify and set the data block. The entry items are described in following table.

Table 8. 3 Description of Entry Items for Position Data Block Edition

Entry Item	Description
START ADDRESS	Specifies the starting address of a block.
END ADDRESS	Specifies the ending address of a block.
SET ADDRESS	Specifies the address for the block.
MODE COMMAND	Specifies the operation contents.

- (2) There are five commands available as the 「MODE COMMAND」. And each command can be selected by the  key or one of the  through  numeric keys.
- ① MOVE : Moves a block.
 - ② INS : Inserts a block.
 - ③ DEL : Deletes a block.
 - ④ SET : Sets a block.
 - ⑤ INIT : Initializes a block
- (3) Press the  key. The message “Position * * * * OK?” appears.
- (4) To execute the selected command, press the  key.
- When “* * * * Completed!!” is displayed on the screen, the command has been executed.



NOTE

The “* * * *” shown above indicates a selected command.

8.5.2 Moving Position Data Block (MOVE)

With this command, data located in the 「START ADDRESS」 through 「END ADDRESS」 are moved to the 「SET ADDRESS」. This MOVE command is different from the INS command because the data originally located in the destination address specified as 「SET ADDRESS」 will be overridden and replaced with the block moved.

For example, when position data addressed 10 through 14 are moved to the specified address 30, the result of this data moving is as shown in the table below.

In this case, 100 is allotted for the addresses specified by 「LIMIT」→「ADDRESS MAX」→「ADDRESS MAX」 in the System Generation mode.

Table 8. 4 Moving Position Data Block

Before			After	
Address	Data		Address	Data
9	Data 9		29	Data 29
10	Data 10	} Moving the data	30	Data 10
11	Data 11		31	Data 11
12	Data 12		32	Data 12
13	Data 13		33	Data 13
14	Data 14		34	Data 14
15	Data 15		35	Data 35
.	.		.	.
.	.		.	.
.	.		.	.
98	Data 98		98	Data 98
99	Data 99		99	Data 99
100	Data 100		100	Data 100

8.5.3 Inserting Position Data Block (INS)

Data located in the 「START ADDRESS」 through 「END ADDRESS」 are inserted to the 「SET ADDRESS」 with this command. The data originally located in the 「SET ADDRESS」 and the following ones will be entirely shifted, and newly addressed with a larger number by the increase (the number of addresses inserted). The data pushed out of the address range set by 「LIMIT」→「ADDRESS MAX」→「ADDRESS MAX」 in the System Generation mode becomes invalid.

For example, when position data addressed 10 through 14 are inserted to the specified address 30, the result of this data insertion is as shown in the table below. In this case, 100 is the allotted number of addresses specified by 「LIMIT」→「ADDRESS MAX」→「ADDRESS MAX」 in the System Generation mode. Therefore, the data previously addressed 96 through 100 will be pushed out of the range and become invalid.

Table 8. 5 Position Data Block Insertion

Before			After	
Address	Data		Address	Data
9	Data 9		29	Data 29
10	Data 10	} Data insertion	30	Data 10
11	Data 11		31	Data 11
12	Data 12		32	Data 12
13	Data 13		33	Data 13
14	Data 14		34	Data 14
15	Data 15		35	Data 30
.	.		.	.
96	Data 96	} These data is pushed out if 100 is allocated at the 「ADDRESS MAX」.	.	.
97	Data 97		.	.
98	Data 98		98	Data 93
99	Data 99		99	Data 94
100	Data 100		100	Data 95



CAUTION

When a block addressed by a larger number than that of the 「SET ADDRESS」 is inserted, it may take you several seconds to complete the insertion depending on the data size. If you do not need the data located in the destination addresses, use MOVE command. (Refer to 8.5.2, “Moving Position Data Block (MOVE)”) for a faster operation. Also, note that each address following the inserted block will become larger than its previous address number by the number of addresses inserted, when a block is inserted from downstream.

8.5.4 Deleting Position Data Block (DEL)

Use this command to delete a position data block located in the 「START ADDRESS」 through 「END ADDRESS」.

For example, when position data address 10 through 14 are deleted, the result of this data deletion is as shown in the table below. Here, 100 is the allotted number of addresses specified by 「LIMIT」→「ADDRESS MAX」→「ADDRESS MAX」 in the System Generation mode. Therefore, Addresses 96 through 100 are initialized.

Table 8. 6 Position Data Block Deletion

Before			After	
Address	Data		Address	Data
9	Data 9	Data block deletion	9	Data 9
10	Data 10		10	Data 15
11	Data 11		11	Data 16
12	Data 12		12	Data 17
13	Data 13		13	Data 18
14	Data 14	14	Data 19	
15	Data 15		15	Data 20
.	.		.	.
96	Data 96		96	Initialized data
97	Data 97		97	Initialized data
98	Data 98		98	Initialized data
99	Data 99		99	Initialized data
100	Data 100		100	Initialized data

8.5.5 Setting Position Data Block (SET)

Use this command to set data specified by 「SET ADDRESS」 into addresses specified by 「START ADDRESS」 through 「END ADDRESS」.

For instance, when the data address 98 is set to addresses 10 through 14, the result of this data setting becomes as shown in the table below. Here, 100 is the allotted number of addresses specified by 「LIMIT」→「ADDRESS MAX」→「ADDRESS MAX」 in the System Generation mode. The data addressed 10 through 14 are overridden respectively by the data located in address 98.

Table 8. 7 Position Data Block Setting

Before			After	
Address	Data		Address	Data
9	Data 9	The data of address 98 setting.	9	Data 9
10	Data 10		10	Data 98
11	Data 11		11	Data 98
12	Data 12		12	Data 98
13	Data 13		13	Data 98
14	Data 14	14	Data 98	
15	Data 15		15	Data 15
.	.		.	.
.	.		.	.
.	.		.	.
98	Data 98		98	Data 98
99	Data 99		99	Data 99
100	Data 100		100	Data 100

8.5.6 Initializing Position Data Block (INIT)



When this command is executed, the data specified by 「START ADDRESS」 through 「END ADDRESS」 are initialized.

0010	M??	F99	S00	L 0
X	0000.00	Y	0000.00	
Z	0000.00	W	0000.00	
R	0000.00	C	0000.00	

Fig. 8. 2 Position Data Initialization (The Robot has 6-Axes)

CHAPTER 9 INPUT/OUTPUT Operations

9.1 DI/DO Monitor

Pressing the  +  keys activates DI/DO monitor mode and the following display appears on the screen. In this mode, digital outputs (DO) in the line on which the cursor is placed can be turned ON/OFF with the numeric keys.

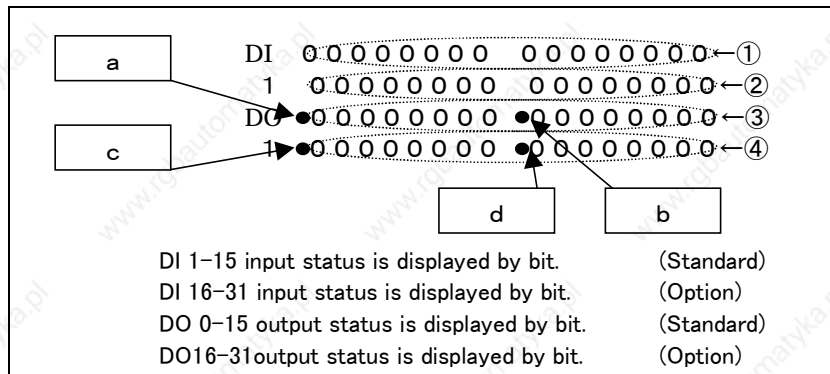









Fig. 9.1 DI/DO Monitor Mode

- Press the  key to move the cursor "■" to the desired line. The cursor can be moved among the four positions indicated as "a", "b", "c", and "d" in the figure above.
- Turn ON/OFF the desired output.

Each of the numeric keys,  through , corresponds to each of the eight bits in the line on which the cursor "■" is currently placed.

By pressing the corresponding numeric key, the output turns ON or OFF. That is, pressing a corresponding numeric key turns "0" to "1" or "1" to "0." The bit number 0 indicates that the output status is OFF, and 1 indicates the status is ON.

	0 1 2 3 4 5 6 7	← Numeric key 0-7
	0 0 0 0 0 0 0 0	← DO 0-7
	0 0 0 0 0 0 0 0	← DO 8-15
	0 0 0 0 0 0 0 0	← DO 16-23 (Option)
	0 0 0 0 0 0 0 0	← DO 24-31 (Option)

- To exit this mode, press the  key.

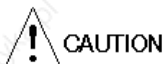

Most of the digital outputs (DO) can be output in each mode; however, in AUTO mode, BP outputs, ZONE outputs, A-CAL outputs, and AUTO outputs cannot be operated because they are controlled by the system.

9.2 Manually Outputting M-Data Signals

In KEY-IN, TEACH, or CHECK mode, the controller gives to its output signals the outputs corresponding to the values set as M-data. When output signals of the controller are used, you can check the operations of other components through operation of the output signals in CHECK mode or during teaching. For M-data, refer to "16.4.1, List of M-Data Functions."

In this section, steps to manually output M-data are described.

- (1) Select KEY-IN, TEACH, or CHECK mode by the Teach Pendant.
- (2) Move the cursor to the position for M-data.
- (3) Press the keys corresponding to the value of M-data to be output.

For example, press the key and then, the key to set the M-data to 10.

- (4) Press the key. The output conforming to the M-data value, displayed immediately before the key was pressed, will be given to the output signal of the controller.



CAUTION

- If you press the key before pressing the key, the position data, the address of which is currently displayed, will be entered and set. When you have pressed the key by mistake, the confirming message "ENTER OK?" appears on the message line. Press any key other than the key to cancel the position data setting operation.
- The output operation will be retained until the next output is given. If the mode is switched into ON-LINE, or the power supply is interrupted, all the outputs will be turned OFF.

CHAPTER 10 HOLD Function

Currently this function is not used for this system.

Normally, all axes are held in TEACH and CHECK mode. However, when the coordinates system display is set to "8", the HOLD function will be cancelled and only the axes equipped with a brake are held. Also, in KEY-IN mode, the HOLD function will be cancelled and only the axes equipped with a brake are held by the brake.

CHAPTER 11 Positioning Address History

The controller saves the addresses of the data determined during positioning in automatic operation. The controller saves such addresses at the time when the START or NEXT signal enters the leading edge. At the same time, the controller saves whether the positioning data has been successfully addressed or not.

The display changes each time the $\boxed{\text{FUNC HIGH}} + \boxed{\text{task 2}}$ keys are pressed. Press these two keys until the following display appears on the screen (Refer to (2)

$\boxed{\text{FUNC HIGH}} + \boxed{\text{task 2}}$ [task] keys in 2.9 “Function Mode”).

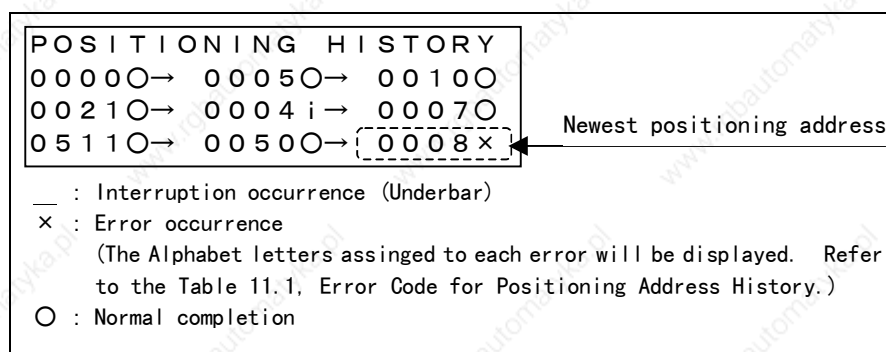

Fig. 11.1 Positioning Address History

In the figure above, Positioning Address History, the latest positioning address saved is “0008” while the oldest one is “0000.” When a new position is used, the address of this new position is displayed in the space where “0008” is currently displayed. The rest of the addresses are shifted up and the history is updated. The controller can save up to 9 positioning addresses including the most current one, clearing the oldest one.

“×” in the figure is indicated next to “0008” as an error code. Actually, an alphabet letter, instead of “×,” is displayed to indicate an error. The description of error codes is given below.



Table 11.1 Error Code for Positioning Address History

Error Code	Description
A	Positioning is not completed.
B	Emergency Stop is activated.
C	A-CAL does not complete normally.
D	Address value is outside the limit. M-data error No sensor found Free curve interpolation data error
E	Position data is outside the limit.
F	Overrun
G	System generation data destroyed. Position data destroyed Servo parameter destroyed
H	CPU board battery low Memory card battery low Encoder battery low CPU

Error Code	Description
J	Travel distance too short Conflict in M-data Position data destroyed Final positioning not possible Motor not responding to speed command Over-speed
K	Driver error detected
L	Servo amplifier/driver is unable to servo lock
i	Interlock input (This is not an error message, but indicated as a notice.)

CHAPTER 12 Automatic Creation of Position Data & Parameters

In this chapter, steps for automatic creation of position data and parameters are described.

Press the  +  keys simultaneously, the shaded section of the following figure is displayed on the screen. To display the 「7. CONFIG MODE」 on the screen, press the  key to scroll up.

ROBOT CALCULATE MODE	
1. CALC.	2. OFFSET
3. MEMORY	4. DISP
5. SERVO	5. BP/ZONE
7. CONFIG MODE	

Fig. 12.1 Robot Calculate Mode

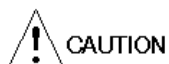

CAUTION

When this function is used, be sure to set the coordinates system display to "0 (world coordinates)" before selecting mode ⁱ.

12.1 CALCULATE Mode

Press the  key to select 「1. CALC.」 on the Robot Calculate Mode screen shown in the above figure. The display changes as shown below. Select the desired item to be calculated by pressing the numeric key.

CALCULATE MODE	
1. AR TYPE	2. MB TYPE
3. PALLET	4. PATTERN

Fig. 12.2 Calculate Mode

ⁱ: Refer to 2.4, "Mode Select Operation."

12. 1. 1 AR-TYPE

This item is used to calculate intrinsic values of SCARA type (a horizontal multi-articulated) robot. The initial angle and arm length can be automatically calculated.

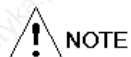

NOTE

Currently this item is not used for this system.

Generally, the initial angle and arm length are set before shipping at the factory. However, if it is required to reset the data such as changing the robot ORIGIN sensor position or the data lost, following steps for the automatic operation are recommended.

- (1) Set the coordinates system display to "0 (world coordinates)." (Refer to 2.4, "Mode Select Operation" for details.)
- (2) Teach following three positions.
 - P1 : Point where the taught position A with right arm position, R¹.
 - P2 : Point where the taught position B with left arm position, L.
 - P3 : Certain point from P1 such as using by fixture to measure the distance.



CAUTION

The addresses for P1, P2, and P3 must be consecutive. Always teach P1-P2-P3 in this order.

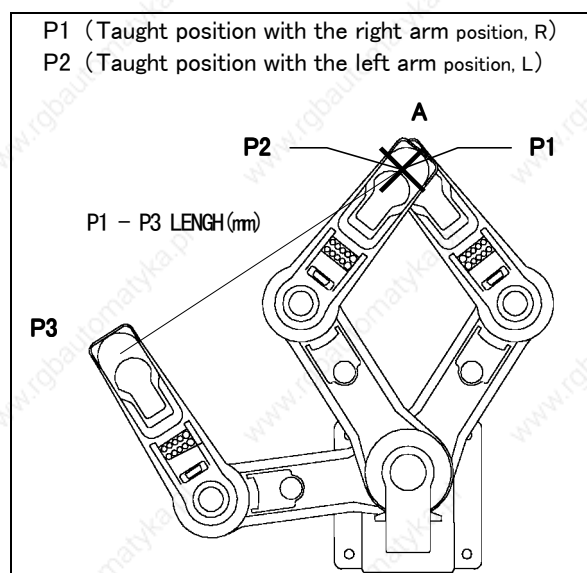







Fig. 12.3 SCARA (Horizontal Multi-Articulated) Robot

- (3) Select a mode other than AUTO mode for the robot.

¹: Refer to 2.7, "LCD Display (Liquid Crystal Display)."

- (4) Press the  +  keys simultaneously. Select 「1. CALC.」 on the screen by pressing the  key when the screen display is as shown in Fig.12.1, Robot Calculate Mode.
- (5) Select 「1.AR TYPE」 on the screen when the screen display is as shown in Fig.12.2, Calculate Mode.
- (6) Pressing the  key 「1.AR TYPE」 displays the shaded section of the illustration below. To display following items under the shaded section on the screen, press the  key to scroll.

INITIAL CALC.	[AR]
TEACH ADDRESS	0000
P1-P3 LENGTH	000.00
INITIAL A	0000.000
INITIAL B	0000.000
LENGTH A	0000.000
LENGTH B	0000.000
Push End Key !!	

Fig. 12.4 AR TYPE

The following items are for System Generation data display. Changing the data on the screen will be ignored. Refer to 18.4.1, “AR TYPE ADJUST” for details.

- 「INITIAL A」
Displays the System Generation, 「ADJUST」→「AR TYPE ADJUST」→「INITIAL A」.
- 「INITIAL B」
Displays the System Generation, 「ADJUST」→「AR TYPE ADJUST」→「INITIAL B」.
After the automatic calculation, the calculated value for 「INITIAL B」 is rewritten and displayed on the screen.
- 「LENGTH A」
Displays the System Generation, 「ADJUST」→「AR TYPE ADJUST」→「LENGTH A」.
After the automatic calculation, the calculated value for 「LENGTH A」 is rewritten and displayed on the screen.
- 「LENGTH B」
Displays the System Generation, 「ADJUST」→「AR TYPE ADJUST」→「LENGTH B」.
After the automatic calculation, the calculated value for 「LENGTH B」 is automatically rewritten and displayed on the screen.

(7) Enter the data. The steps for each data entry are the same as follows:

① Enter the data.

② Press the  key if the data is correct. "ENTER OK?" appears on the message line and a buzzer sounds.

(8) Press the  key again to confirm the data.

Following are the details for setting items.

- 「TEACH ADDRESS」

Designates the position data address which is taught position P1.

- 「P1-P3 LENGTH」

Designates the measured distance between P1 and P3.

(9) Press the  key. Then, "Calculate OK ?" appears on the message line.

(10) Press the  key to execute the calculation. "COMPLETED !!" appears after the calculation is completed.

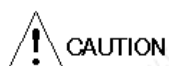

CAUTION

- Record the value of the System Generation which is the display in Fig.12.4, AR TYPE before executing automatic operation. Replace to the recorded value if the data becomes abnormal.
- Once teaching position is done, replacing the fixed value of the robot cause misoperation.

12. 1. 2 MB-TYPE

Currently this function is not used for the system.

12. 1. 3 PALLET

This item is used to calculate position data by teaching three points on a pallet (palletizing). The steps to create position data are as follows:

(1) Set the coordinates to "0 (world coordinates)." Refer to 2.4, "Mode Select Operation" for details.

(2) Teach three points on a pallet or box regularly used, or the equivalent.

P1-P2 : X coordinate

P1-P3 : Y coordinate

It is recommended that the direction of W-Axis at P1, P2, and P3 be the same as much as practical to improve the accuracy. When such a box is large, divide the area of the box surface to teach to obtain better accuracy in automatic calculation of position data.

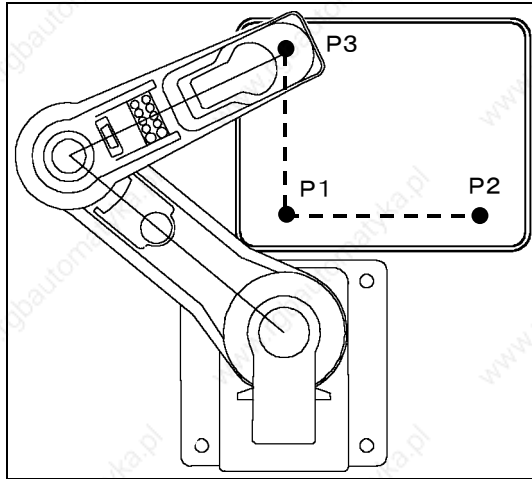

Fig. 12.5 Teaching Example (Viewed from Robot Top)

- (3) Select a mode other than AUTO for the robot.
- (4) Press the

FUNC
HIGH

 +

cal
1

 keys to display Fig.12.1, Robot Calculate Mode screen. Select 「1.CALC.」 on the screen by pressing the

cal
1

 key.
- (5) Select 「3. PALLET」 on the screen when the screen display is as shown in Fig.12.2, Calculate Mode.
- (6) Pressing the

mot
3

 key 「3. PALLET」 displays the shaded section of the illustration below. To display the 「UPPER M DATA」 and the following items on the screen, press the

up
DOWN

 key to scroll.

PALETTIZE CALC MODE	
TEACH ADDRESS	0000
OPEN ADDRESS	0000
LOWER M DATA	00
UPPER M DATA	00
Z UPPER DATA	000.00
X WORK NUMBER	000
Y WORK NUMBER	000
WORK STEP 1-2	0
ORDER 0-7	0
PATTERN 0-15	00
ADDR STEP 0-255	000
Push End Key !!	

Fig. 12.6 PALLET

(7) Specify data. Input method is the same for all the items.

To input,

- ① Enter a value to be set.
- ② Confirm that the specified value is correct and press the key. The confirming message "ENTER OK?" appears on the message line and a buzzer sounds.
- ③ Confirm again that the value to be set is correct. Then press the key for the second time. The data setting has been completed.

The entry items are described below.

- 「TEACH ADDRESS」
Specify the position data address corresponding to the P1 that has been taught.
- 「OPEN ADDRESS」
Specify the address from which the development of the position data is started for the palletizing operation.
- 「LOWER M DATA」
The value entered for this item is used as M-data when the position data are developed. When data of two positions, upper and lower, (with Z UPPER POSITION other than 0) are to be developed, specify and set a value as M-data for the lower position here. The value must be 1 or greater. Also, refer to Fig.12.7, Z UPPER DATA= 0 and Fig.12.8, Z UPPER DATA≠0.
- 「UPPER M DATA」
When data of two positions, upper and lower, (with Z UPPER POSITION other than 0) are to be developed, specify and set a value as M-data for the upper position here. The value must be 1 or greater. However, when the Z UPPER POSITION is 0, the entered value is ignored. Also, refer to Fig.12.8, Z UPPER DATA≠0.
- 「Z UPPER DATA」
Where 2 positions on Z-Axis per point on X-Y coordinate are required, specify and set the value of the upper position on Z-Axis. When there is no Z-Axis, or when only one position on Z-Axis per point on X-Y coordinate is required, always input 0.

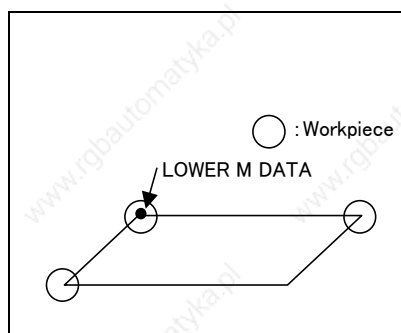

Fig. 12. 7 Z UPPER DATA = 0

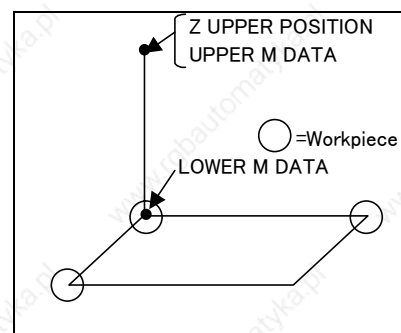

Fig. 12. 8 Z UPPER DATA ≠ 0

- 「X WORK NUMBER」
Specify the number of rows between P1 and P2 (on X-Axis). Refer to example① in Fig.12.9 and example② in Fig.12.10.
- 「Y WORK NUMBER」
Specify the number of lines between P1 and P3 (on Y-Axis). Refer to example① in Fig.12.9 and example② in Fig.12.10.
- 「WORK STEP 1-2」
Specify the method to create addresses for palletizing. The valid value is either “1” or “2.” If a value other than 1 and 2 is specified, the system will calculate in the same way as method “1.” When you input “1,” the position data will be created (calculated) based on the matrix (grid) illustrated in example① in Fig.12.9.

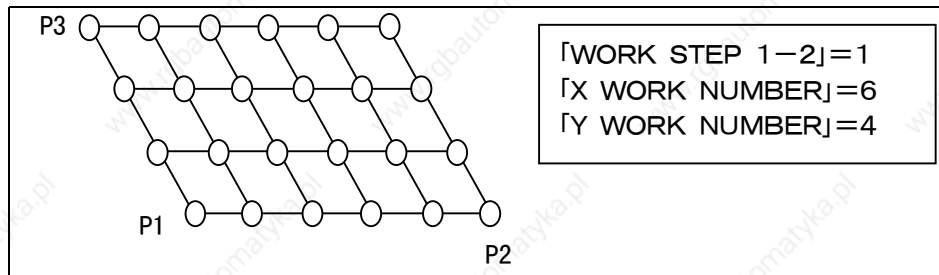

Fig. 12. 9 Example①

When “2” is specified, the position data will be calculated based on a shifted pattern as illustrated in example② in Fig.12.10, where every second rows and lines of the matrix are used. (You can select a shifting pattern by specifying a value for 「WORK PATTERN」.) Specifying 「X WORK NUMBER」=5, it is considered as five rows between P1 and P2 (on X-Axis) exist and the exceeding rows more than the specified number “5” will be ignored and will not be counted.

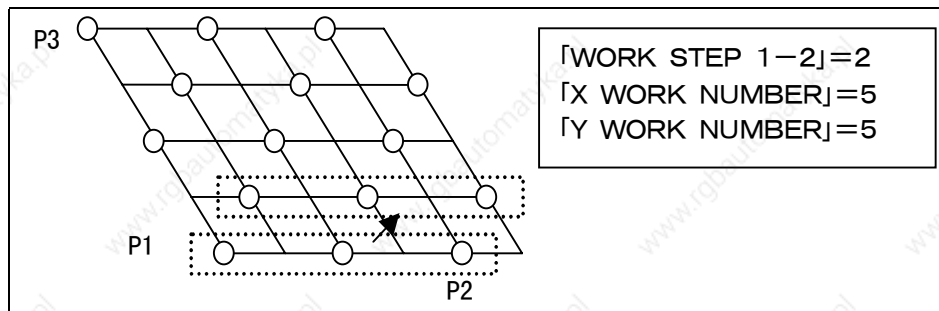

Fig. 12. 10 Example②

• 「ORDER 0-7」

When developing position data, specify the sequence of work positioning to be executed. You can select one to be executed from the 8 orders illustrated in Fig.12.11, 「ORDER 0-7」 below. P1, P2, and P3 are the teaching points.

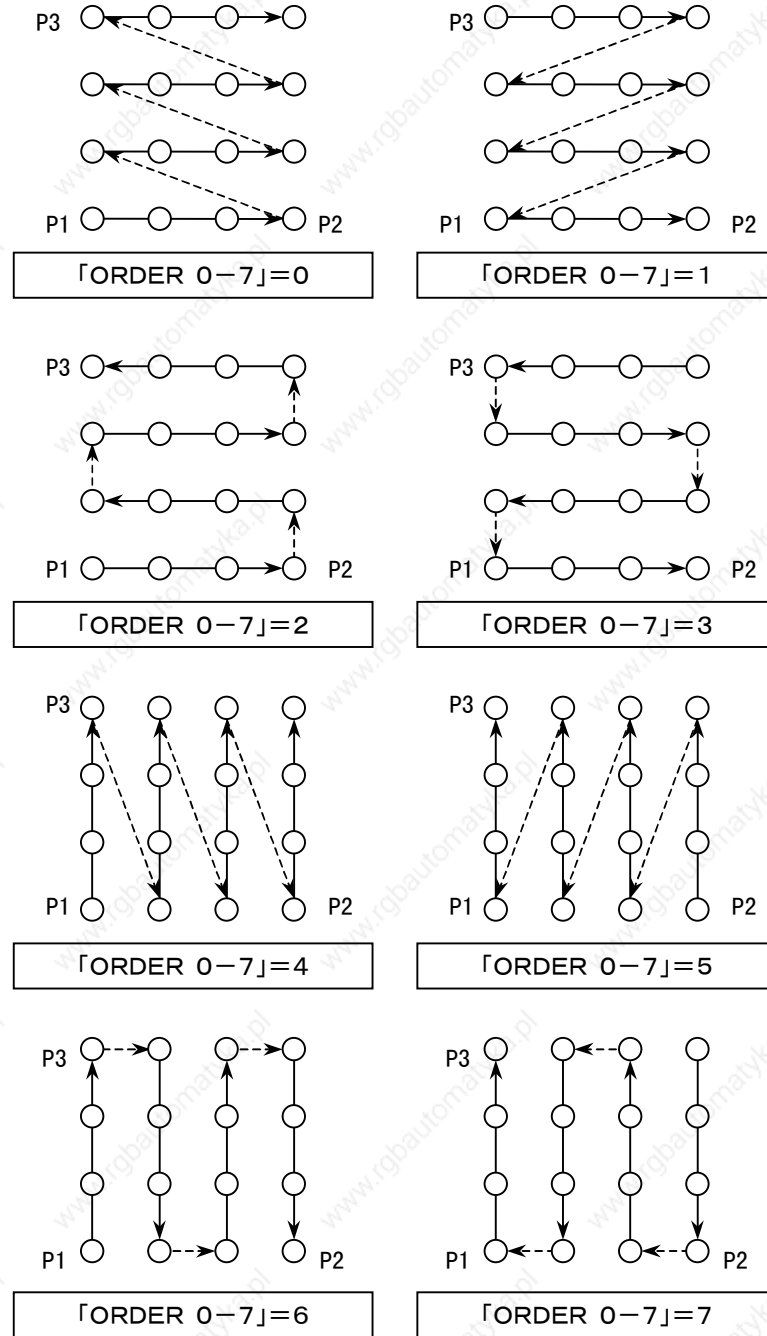

Fig. 12.11 「ORDER 0-7」

● 「PATTERN 0-15」

When "2" is specified for 「WORK STEP 1-2」, specify a shifting pattern of the matrix. This item is valid only when "2" is specified for 「WORK STEP 1-2」. Each parallelogram drawn with a solid line indicates the matrix formed based on the actual points P1, P2 and P3 specified by teaching. Each parallelogram drawn with a dotted line indicates the shifted matrix pattern formed based on the points adjacent to the actual points. Refer to Fig.12.12 and Fig.12.13. Select one of the 16 patterns and input the number.

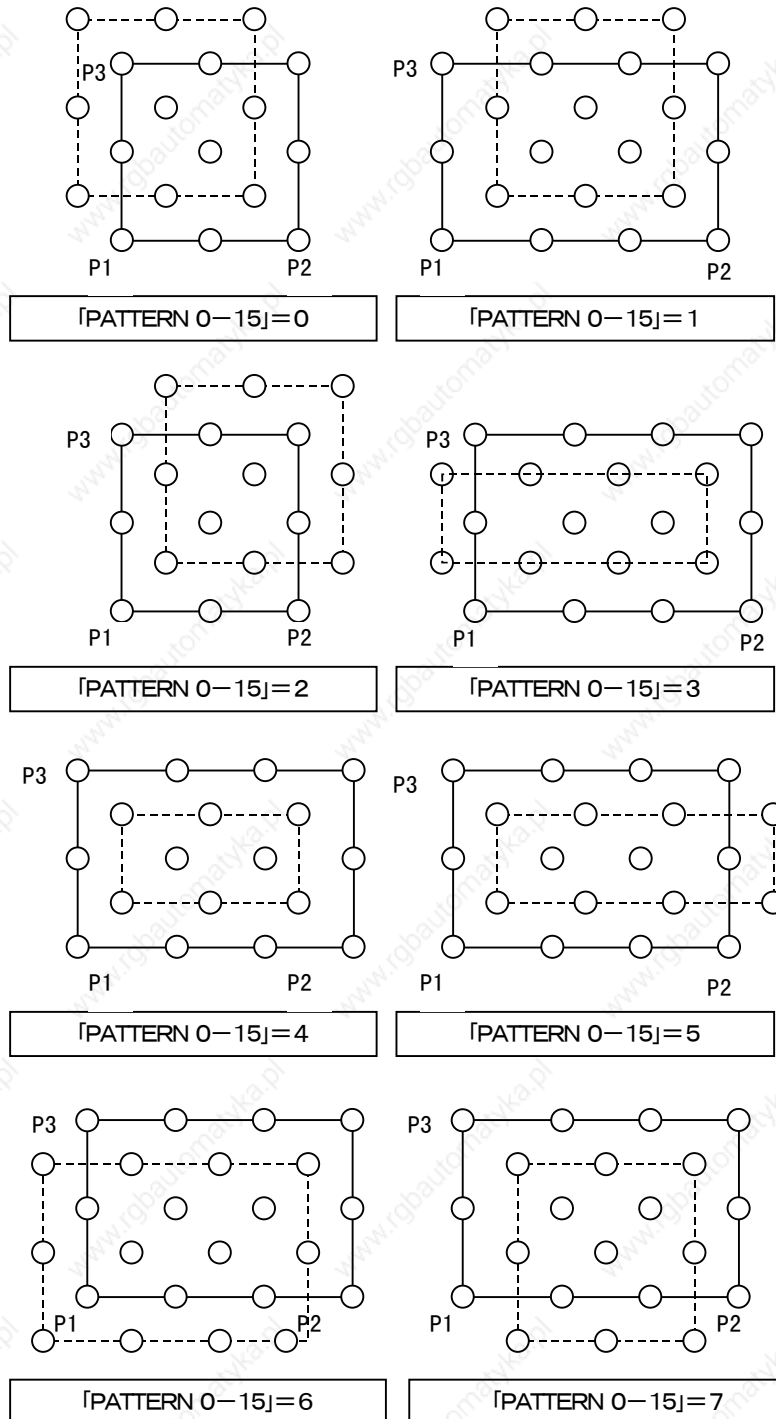

Fig. 12.12 「PATTERN 0-15」 ①

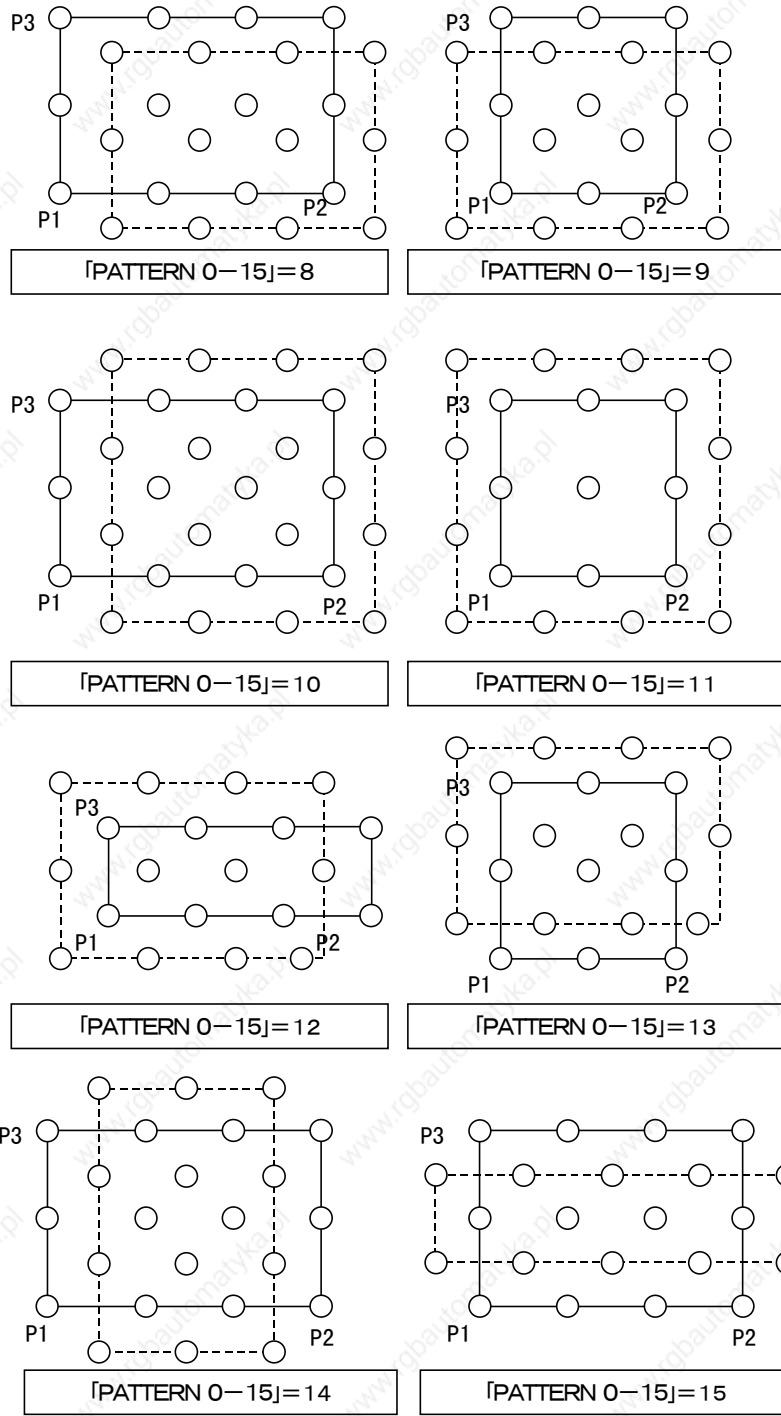



Fig. 12.13 $\lceil \text{PATTERN } 0-15 \rceil$ ②

- 「ADDR STEP 0-255」

The number of steps to be skipped for developing position data addresses should be specified. If you input “0” for this item when “0” is specified for 「Z UPPER DATA」 explained above, the system automatically sets your input to “1.” And if you input “0” or “1” for this item when 「Z UPPER DATA」 setting is other than “0,” the system automatically sets to “2.”

- (8) When you press the  key, “Calculate OK?” appears on the message line.
- (9) To execute the calculation, press the  key. When the calculation has been completed, “COMPLETED!!” is displayed.

12.1.4 PATTERN

When there is a certain rule among a block of position data, the rule of the block (pattern) can be applied to create patterned blocks of data, by teaching the series of movements corresponding to the pattern to the robot system.

EXAMPLE





A movement pattern where the Z-Axis position data increases 20mm per block is given below.

Address	X	Y	Z	W	M	F	S
900	100	150	10	60	2	99	0
901	110	160	15	60	3	99	0
902	110	180	15	60	4	99	0
903	120	180	20	80	5	99	0

This pattern, when started from address 10 with the +20mm increment (or displacement) in Z-Axis position data for every additional block, can be developed as follows:



Address	X	Y	Z	W	M	F	S
010	100	150	10	60	2	99	0
011	110	160	15	60	3	99	0
012	110	180	15	60	4	99	0
013	120	180	20	80	5	99	0
014	100	150	30	60	2	99	0
015	110	160	35	60	3	99	0
016	110	180	35	60	4	99	0
017	120	180	40	80	5	99	0
018	100	150	50	60	2	99	0
019	110	160	55	60	3	99	0
020	110	180	55	60	4	99	0
021	120	180	60	80	5	99	0
022	100	150	70	60	2	99	0
023	110	160	75	60	3	99	0
024	110	180	75	60	4	99	0
025	120	180	80	80	5	99	0

The steps for developing these patterned data blocks are described below.

- (1) Set the coordinates to “0 (world coordinates).” Refer to “2.4 Mode Select Operation.”
- (2) Teach to the robot system the original basic series of movements. At this time, teach the position from which the robot starts the operation.
- (3) Select a mode other than AUTO for the robot.
- (4) Press the  +  keys to display Fig. 12.1, Robot Calculate Mode screen. Select 「1.CALC.」 by pressing the  key.
- (5) When the screen display is as shown in Fig. 12.2, Calculate Mode screen, select 「4. PATTERN」.
- (6) Pressing the  key 「4. PATTERN」 displays the shaded section of the illustration below. To display the 「WORK NUMBER」 and the following items on the screen, press the  key to scroll.

PATTERN CALC MODE		
START ADDRESS		0000
END ADDRESS		0000
OPEN ADDRESS		0000
WORK NUMBER		000
MODE SELECT		000
X OFSSET	0000.	000
Y OFSSET	0000.	000
Z OFSSET	0000.	000
W OFSSET	0000.	000
Push END Key !!		

Fig. 12. 14 PATTERN

- (7) Input data. Inputting method is the same for all the items.
To input,
 - ④ Enter the value to be set.
 - ⑤ Confirm that the data to be set is correct and press the  key. The confirming message “ENTER OK?” appears on the message line and a buzzer sound.
 - ⑥ Confirm again that the value to be set is correct. Then press the  key for the second time. The data setting has been completed.

The entry items are described below.

- 「START ADDRESS」
Specify the first address of the block the pattern of which will be developed. In the case of the example on the previous page, the address is 900.

- 「END ADDRESS」
Specify the last address of the block the pattern of which will be developed. In the case of the example on previous page, the address is 903.
- 「OPEN ADDRESS」
Specify the first address at which the pattern is opened and developed. In the case of the example on previous page, the address is 10.
- 「WORK NUMBER」
Specify the number of times the pattern is repeated. In the case of the example on previous page, the number is 4.
- 「MODE SELECT」
Select a value to select the system parameter used for display offset. Currently only "DISPLAY OFFSET 1" is available.
1: DISPLAY OFFSET 1
2: DISPLAY OFFSET 2
3: DISPLAY OFFSET 3
When a value other than those given above is specified, the system will use the data for "DISPLAY OFFSET 1" as the offset data.
- 「X OFFSET」
You can specify an offset value (increment or displacement) on the X-coordinate. Specify the value when the pattern has such regular increment/difference along the X-Axis. In the case of the example on previous page, the value is 0.
- 「Y OFFSET」
You can specify an offset value (increment or displacement) on the Y-coordinate. Specify the value when the pattern has such regular increment/difference along the Y-Axis. In the case of the example on previous page, the value is 0.
- 「Z OFFSET」
You can specify an offset value (increment or displacement) on the Z-coordinate. Specify the value when the pattern has such regular increment/difference along the Z-Axis. In the case of the example on previous page, the value is 20.
- 「W OFFSET」
You can specify an offset value (increment or displacement) on the W-coordinate. Specify the value when the pattern has such regular increment/difference along the W-Axis. In the case of the example on previous page, the value is 0.

(8) Press the key. "Calculate OK?" appears on the message line.

(9) To execute the calculation, press the key. When the calculation has been completed, "COMPLETED!!" is displayed.

12.2 Offset (OFFSET)

Currently this function is not used for the system.

12.3 Memory Data (MEMORY)

Currently this function is not used for the system.

12.4 DISPLAY OFFSET Automatic Calculation

Automatically calculates the value for 「DISP.X*」, 「DISP.Y*」, 「DISP.W*」, and 「DISP.R*」 of the System Parameter, 「OFFSET」→「DISPLAY OFFSET*」 group. The value for 「DISP.Z*」 is not calculated.



NOTE

Currently this function is not used for the system.

- (1) Set the coordinates to “0 (world coordinates).” Refer to 2.4, “Mode Select Operation.”

- (2) Teach following two points to the robot.

P1 : Origin point on the display.

P2 : The point which P1 move toward to P2 direction on X coordinates.



NOTE

The addresses for P1 and P2 must be serial. Always teach P1-P2 in this order.

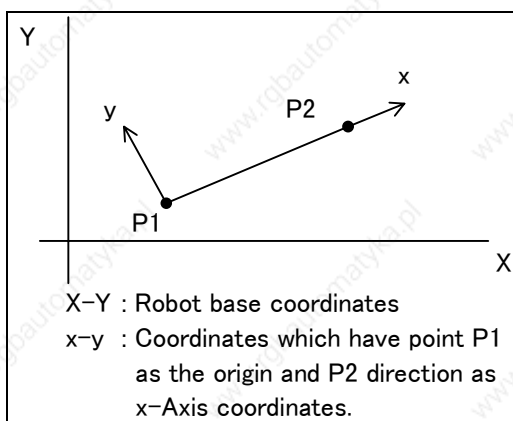





Fig. 12.15 DISPLAY OFFSET



- (3) Select a mode other than AUTO for the robot.

- (4) Press the  +  keys to display Fig.12.1, Robot Calculate Mode screen. Select 「4. DISP」 by pressing the  key, and display shows as following figure.

DISP. OFF.	CALC. MODE
1. DISPLAY 1	
2. DISPLAY 2	
3. DISPLAY 3	

Fig. 12. 16 DISP

- (5) Select the item which you wish to calculate from the DISPLAY OFFSET group.

-  : 1. DISPLAY 1
 : 2. DISPLAY 2
 : 3. DISPLAY 3

- (6) Displays the shaded section of the illustration below. To display the 「DISPLAY Y1」 and the following items on the screen, press the  key to scroll.

DISP. OFF. 1	CALC. MODE
TEACH ADDRESS	0000
MODE SELECT	000
DISPLAY X1	0000.00
DISPLAY Y1	0000.00
DISPLAY Z1	0000.00
DISPLAY W1	0000.00
DISPLAY R1	0000.00
Push END Key !!	

Fig. 12. 17 DISPLAY



Following items are for System Parameter data display. Changing the data on the screen will be ignored. Refer to 19.3, "OFFSET" for details.

- 「DISPLAY X1」
 Displays the System Parameter, 「OFFSET」→「DISPLAY OFFSET1」→「DISP.X1」. After the automatic calculation, the calculated value for 「DISPLAY X1」 is rewritten and displayed on the screen.
- 「DISPLAY Y1」
 Displays the System Parameter, 「OFFSET」→「DISPLAY OFFSET1」→「DISP.Y1」. After the automatic calculation, the calculated value for 「DISPLAY Y1」 is rewritten and displayed on the screen.

- 「DISPLAY Z1」
Displays the System Parameter, 「OFFSET」→「DISPLAY OFFSET1」→「DISP.Z1」.
- 「DISPLAY W1」
Displays the System Parameter, 「OFFSET」→「DISPLAY OFFSET1」→「DISP.W1」. After the automatic calculation, the calculated value for 「DISPLAY W1」 is rewritten and displayed on the screen.
- 「DISPLAY R1」
Displays the System Parameter 「OFFSET」→「DISPLAY OFFSET1」→「DISP.R1」. After the automatic operation, the calculated value for 「DISPLAY R1」 is rewritten and displayed on the screen.



(7) Input data. Inputting method is the same for all the items.

To input,

- ① Enter the value to be set.
- ② Confirm that the data to be set is correct and press the  key. The confirming message “ENTER OK?” appears on the message line and a buzzer sound.
- ③ Confirm again that the value to be set is correct. Then press the  key for the second time. The data setting has been completed.



The entry items are described below.

- 「TEACH ADDRESS」
Specify the position data address for taught position P1.
- 「MODE SELECT」
Not used. Specify “0” for this value.

- (8) Press the  key. “Calculate OK?” appears on the message line.
- (9) To execute the calculation, press the  key. When the calculation has been completed, “COMPLETED!” is displayed.

12.5 Setting Servo Parameters (SERVO)

Servo parameters are properly adjusted before shipment according to the unit to be controlled. However, if the motor emits abnormal noise or hunting occurs during positioning operation after the shipment, readjust the parameters. The steps to readjust the parameters are as follows:







- (1) Set the coordinates to “0 (world coordinates).” Refer to 2.4, “Mode Select Operation.”
- (2) Press the  +  keys to set the Teach Pendant in KEY-IN mode.

- (3) Pressing the  key 「5. SERVO」 displays the following on the screen:

SERVO PARAM. TUNE			
1. A	PARAM	2. B	PARAM
3. Z	PARAM	4. W	PARAM
5. R	PARAM	6. C	PARAM

Fig. 12. 18 SERVO

- (4) Press the numeric key corresponding to the parameter you want to adjust.

	: "A PARAM": A (X)-Axis		: "B PARAM": B (Y)-Axis
	: "Z PARAM": Z-Axis		: "W PARAM": W-Axis
	: "R PARAM": R-Axis		: "C PARAM": C-Axis

If the operation above is attempted in a mode other than KEY-IN, the message "Mode Error" appears and the input will be ignored.

- (5) Then, the shaded portion of the illustration below appears on the screen. To display the 「Sync. Time」 and the following items on the screen, press the  key to scroll. Here, A (X)-Axis screen is described as an example.

A (X)	SERVO	PARAMETER	
Motor Code			072
Enc. Pulse			012
Enc. Type			001
Sync. Time			002
Func 0			000
Kp	(rad/s)		025
Kff	(%)		000
Kvp	(Hz)		0100
Tvi	(msec)		0020
TPCM	(msec)		000
FLPF	(Hz)		990
ICMLPF	(Hz)		450
ICMBEF	(Hz)		990
OVFDAT	(pulse)		00256
In Pos	(pulse)		00016
SILIM			120
Alarm			0000
Cpu Ver.			04110
Amp Code			004
Expansion 5			00000
Expansion 4			00000
Expansion 3			00000
Expansion 2			00000
Expansion 1			00000

Fig. 12. 19 SERVO PARAMETER

(6) Input data. Inputting method is the same for all the items.

To input,

- ① Enter the value to be set.
- ② Confirm that the data to be set is correct and press the key. The confirming message “ENTER OK?” appears on the message line and a buzzer sound.
- ③ Confirm again that the value to be set is correct. Then press the key for the second time. The data setting has been completed

The entry items and the outlined description are given below. For details, refer to separated volume, “Robot Controller User’s Guide” of the controlling devices you are using.

Table 12.1 SERVO Parameters

Parameter	Standard Value	Description	Replacement
Motor Code		Motor code (Refer to APPENDIX D “Motor Code.”)	No allowed basically
Enc. Pulse	012	Sensor division number code	Not allowed
Enc. Type	001	Sensor type code	Not allowed
Sync. Time	002	Synchronous frame cycle	Not allowed
Func0	000	Servo amplifier/driver function select bit	Allowed
Kp (rad/s)	025	Position loop gain	Allowed
Kff (%)	000	Feed forward gain	Allowed
Kvp (Hz)	0100	Speed loop proportional gain	Allowed
Tvi (msec)	0020	Speed loop integration constant	Allowed
TPCM (msec)	0000	Position command low-pass filter constant	Allowed
FLPF (Hz)	990	Feed forward pass filter	Allowed
ICMLPF (Hz)	450	Current command low-pass filter	Allowed
ICMBEF (Hz)	990	Current command notch filter	Allowed
OVFDAT (pulse)	00256	Position deviation over setting value	Allowed
In Pos (pulse)	00012	In-position setting value	Allowed
SILIM	120	Sequence current limit	Allowed
Alarm		Not used	Not allowed
Cpu Ver.		CPU version	Not allowed
Amp Code		Amplifier capacity code	Not allowed
IILMF (%)	00000	Normal revolution current limit	Allowed
IILMR (%)	00000	Reversed revolution current limit	Allowed
Expansion3	00000	Not used	Allowed
Expansion2	00000	Not used	Allowed
Expansion1	00000	Not used	Allowed

(7) Press the key. The message “Servo Tune OK?” appears.



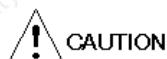

(8) To execute the calculation, press the key. When the calculation has been completed, “COMPLETED!!” is displayed.



When initializing the system data, it also initialize the servo parameters. (Refer to Chapter 21, “Initializing System Data.”)

12.6 Expanded Zone Assignment (BP/ZONE)









The data specified here are valid only when an expanded interface ⁱ is used. The data are used to assign outputs to the remote register of the expanded interface. Total maximum eight points are added for the A, B (X, Y)-Axes area output ⁱⁱ and the base position output ⁱⁱⁱ.

- (1) Set the coordinate to “0 (world coordinates)” (Refer to 2.4, “Mode Select Operation.”)
- (2) Select a mode other than AUTO.
- (3) Press the  +  keys to display Fig.12.1, Robot Calculate Mode screen. Select 「6. BP/ZONE」 on the screen when the screen display is as shown in Fig.12.1. Pressing the  key 「6. BP/ZONE」 displays the shaded section of the illustration below. To display the 「7. ZONE 7.....」 and the following items on the screen, press the  key to scroll.

EXT.	ZONE / BP	ASSIGN
1.	ZONE 1	2. ZONE 2
3.	ZONE 3	4. ZONE 4
5.	ZONE 5	6. ZONE 6
7.	ZONE 7	8. ZONE 8
9.	INITIALIZE	

Fig. 12. 20 BP/SERVO



- (4) Press the numeric key corresponding to the function you wish to use.

 : ZONE 1	 : ZONE 2
 : ZONE 3	 : ZONE 4
 : ZONE 5	 : ZONE 6
 : ZONE 7	 : ZONE 8
 : INITIALIZE	

ⁱ : This function becomes valid when you specify either “CC-Link” or “Device-Net” as the I/O type in the system configuration mode. The expanded interface allows reading and writing of position data and system data. For details, refer to the operation manuals of the individual interfaces.

ⁱⁱ : Refer to the System Parameter, 「SET-UP」→「EXPANSION A」→「Base Pos Addr*」.

ⁱⁱⁱ : Refer to the System Parameter, 「SET-UP」→「EXPANSION B」→「AREA AX」, 「AREA BY」.



- (5) When one of the numeric keys  to  is pressed, the shaded portion of the illustration below appears. To display the 「LOWER (ZONE)」 and the following items on the screen, press the  key to scroll. Here, the case of 「ZONE 1」 is described as an example.

EXT. ZONE/BP 1	
OUT TYPE [NOT USE]	
AXIS (ZONE) [A(X)]	
UPPER (ZONE) 0000.000	
LOWER (ZONE) 0000.000	
BS ADDR (BP) 0000	
BS PULSE (BP) 0000	
Push END Key !!	

Fig. 12. 21 EXT ZONE/BP1



- (6) When 「EXT. ZONE/BP1」 is displayed, specify ZONE data for desired items.

For 「OUT TYPE」 and 「AXIS (ZONE)」, press the  key to select the value. For other items, steps for data input is following.

- ① Enter the value to be set.
- ② Confirm that the data to be set is correct and press the  key. The confirming message 「ENTER OK?」 appears on the message line with a buzzer sound
- ③ Confirm again that the value to be set is correct. Then press the  key for the second time. The data setting has been completed.

The entry items are described below.

- 「OUT TYPE」
Specifies the type of output signal using ZONE/BP. Select one of the following:
BASE POS : Outputs base position signal.
ZONE : Outputs ZONE signal.
NOT USE : Not used
- 「AXIS (ZONE)」
Use this item when the ZONE signal is selected in the above step. Specify the output axis.
- 「UPPER (ZONE)」
Use this item when the ZONE signal is used. Specify the upper limit value.
- 「LOWER (ZONE)」
Use this item when the ZONE signal is used in the above step. Specify the lower limit value.
- 「BS ADDR (BP)」
Use this item when the BASE POS signal is used.
- 「BS PULSE (BP)」
Use this item when the BASE POS signal is used.

- (7) When you press the  key ([9. INITIALIZE]) on the Fig.12.20, BP/SERVO screen, “ZONE/BP INIT OK?” appears on the message line. To initialize all of the data set for the above items, press the  key. For each of the following items, “0” is written.

12.7 Error Messages in Automatic Calculate Mode



Table 12.2 Error Messages in Automatic Calculation Mode (Robot Calculate)

Error Message	Possible Cause	Action to Take
P1-P2 Length Error	Distance between P1 and P2 is too short.	Teach again.
P1-P3 Length Error	Distance between P1 and P3 is too short.	Teach again.
R-Offset Data Error	Rotary-offset value has been abnormal.	Teach again.
Initial Data Error	Initial data is abnormal.	Initialize again.
Teaching Data Error	Teaching data is abnormal.	Teach again.
Address Error	Address is abnormal.	-
Mode Error	The selected mode is not KEY-IN, TEACH, nor CHECK mode.	Change the mode.
Axis Not Used	The setting for the axis, for which calculation is made, is “NOT USED.”	Specify the proper value.
Incompleted!!	Normal calculation is not possible.	Check if the set data and teaching points are appropriate. Then, specify correct data or teach again.

CHAPTER 13 Memory Card

As a medium to store information in the controller, an optional memory card can be used. This chapter explains how to use memory cards and the commands.

13.1 Selecting the Function

To select the memory card function, press the  +  keys. The display as shown below appears on the screen.

```

MEMORY CARD
1. ALL-LOAD 3. EDIT
2. ALL-SAVE 4. UTIL
5. VERIFY
  
```

Fig. 13.1 Memory Card

13.2 Basic Operation

- (1) To select an item, use the numeric key corresponding to the item.
- (2) Characters in the [] can be changed by using the  key or numeric keys.
- (3) File names are seven-digit numbers. Use these seven-digit numbers to specify or display file names.
- (4) Command execution with no memory card inserted in the controller causes an error.



CAUTION

Files on a memory card are managed in a similar way as those on floppy discs used for personal computers. Therefore, be sure to format a NEW memory card prior to use.

13.3 File Name List

When saving information, you have to specify a name for the file using numbers to save it under the name. The valid range of file names under which you can save your files is 0000001 to 9999999.

However, 1234500 up to 1234599 are reserved for the system to use in the ALL-LOAD mode or ALL-SAVE mode.

The file name allocation is as shown below.

Table 13.1 File Name Allocation

File Name	Allocation			
	Area	Description		
0000001	}	File area for users		
:				
1234499				
1234500	}	Not used.		
:				
1234509				
1234510			Robot 1 position data	
1234511			Robot 1 system data (SG, SP)	
1234512			Robot 1 servo parameter	
1234513			}	Not used.
:				
1234519				
1234520			Robot 2 position data	
1234521	Robot 2 system data (SG, SP)			
1234522	Robot 2 servo parameter			
1234523	}	Not used.		
:			System reserved	
1234529			file area	
1234530	Robot 3 position data			
1234531	Robot 3 system data (SG, SP)			
1234532	Robot 3 servo parameter			
1234533	}	Not used.		
:				
1234539				
1234540	Robot 4 position data			
1234541	Robot 4 system data (SG, SP)			
1234542	Robot 4 servo parameter			
1234543	}	Not used.		
:				
1234599				
1234600	}	File area for users		
:				
:				
:				
9999999				

13.4 ALL-LOAD Mode (MEMCARD → ROBOT)

In this mode, the system loads all the system data, servo parameters, and position data from 0 to 999 (for standard model) to the robot controller.

Use this mode to load data, which have been saved on the memory card by using the ALL-SAVE mode (refer to 13.5, “ALL-SAVE Mode (ROBOT→MEMCARD)” below), to the robot controller. The files to be loaded are 1234500 to 1234599. If the files saved in the ALL-SAVE mode are of wrong type, or there are missed files, an error is caused.

- (1) When the screen display is as shown in Fig.13.1, Memory Card

screen, select the  key 「1. ALL-LOAD」. The display changes as follows and a buzzer sounds.

```
LOAD MEMORY CARD
MEMCARD >> ROBOT

ALL-LOAD OK ?
```

Fig. 13.2 ALL-LOAD

- (2) Then, press the  key to start the loading operation. When the all the data have been normally loaded, “COMPLETED!!” is displayed and the screen goes back to the Memory Card screen shown in Fig.13.1.

13.5 ALL-SAVE Mode (ROBOT → MEMCARD)

In this mode, all the system data, servo parameters, and position data from 0 to 999 (as standard) are saved.

The information retained in the robot controller is saved onto the memory card. The pieces of the information are saved in the respective locations reserved for the system as described in the previous section 13.3, “File Name List.”

- (1) When the screen display is as shown in Fig.13.1, Memory Card

screen, select the  key 「2. ALL-SAVE」. The display changes as shown below and a buzzer sounds.

```
SAVE MEMORY CARD
ROBOT >> MEMCARD

ALL-SAVE OK ?
```

Fig. 13.3 ALL-SAVE

- (2) Then, press the  key to start saving. When all the data have been normally saved, “COMPLETED!!” is displayed and the screen goes back to the Memory Card screen as shown in Fig.13.1.

13.6 EDIT Mode

In this mode, reading, writing, or deleting files saved on the memory card is possible.

When the screen display is as shown in Fig.13.1, Memory Card screen, select the  key 「3. EDIT」. The display changes as shown below.

```

FILE EDIT
1. FILE  2. LOAD  3. SAVE
4. COPY  5. DEL   6. DUMP
7. FIND
    
```

Fig. 13.4 EDIT

13.6.1 FILE Command







With this command, files that are currently saved on the memory card are displayed. Press the  「1. FILE」 key. The display changes as shown below.

```

FILES
FILES TYPE
      [Position Data]
Push END Key !!
    
```

Fig. 13.5 FILE

- (1) Use the  key or the numeric key to select the desired type of files.

 : Position Data	 : System Data
 : Memory Data	 : ALL
 : Servo Param	 : Option Data



NOTE

Optional functions and sequences vary depending on the model. When such optional functions and/or sequences are added, additional file types are included accordingly.

- (2) “Files Type OK?” is displayed with a buzzer sound. Then, press the  key. The names of the files that have been saved are displayed.

1	2	3	4	5	6	0	P o s	0	0	2	4	0	0	4
1	2	3	4	5	6	1	S y s	0	0	0	0	8	3	6

File name File type File size

Fig. 13.6 Memory Card Display

The file types are described below.

- Pos : Position data
 - Sys : System data (data for the System Generation and the System Parameter)
 - Srvo : Servo parameters
 - Opt : Optional data
 - Main : Main program *)
 - Sub : Sub-program *)
 - Hand : Hand program *)
 - Time : Timer data *)
- *) when HARL-U1¹ is used

- (3) When there are many files following those currently on display, press any key to display the rest of the files in sequence page by page.
- (4) When all the files have been displayed, "COMPLETED!!" appears and the screen goes back to the FILE screen shown in Fig. 13.5.

13.6.2 LOAD Command



With this command, specified files are loaded to the controller.

When the screen display is as shown in Fig.13.4, EDIT screen, select the

 key 「2. LOAD」. The display changes as shown below.

FILE	LOAD								
FILE	NAME		1	2	3	4	5	6	1
START	ADDR		0	0	0	0	0	0	0
Push	END	Key	!!						

Fig. 13.7 FILE LOAD

- (1) Specify a file name in the space for FILE NAME.
 - ① Enter the file name in the space next to FILE NAME.
 - ② Confirm that the entered file name (specified data) is correct. Then, press the  key. The message "ENTER OK?" is displayed with a buzzer sound.
 - ③ Confirm again that the file name (specified data) is correct. Then press the  key again to set the data.

¹: A simplified robot control programming language developed by our company. For more information, refer to separated volume, "HARL-U1 Operation Manual."

(2) Specify a value for 「START ADDRESS」 for loading the file. However, the loading steps are different depending on the file type. When a file is saved, the file type is determined.

- Pos: When the file is a position data file

Specify addresses of the robot, to which the position data of the saved file is to be loaded. The steps to specify the start address are the same as those for 「FILE NAME」. When the start address specified for 「START ADDR」 is within the address range¹ assigned to the robot, the position data are loaded to the specified addresses of the robot.

When the number of position data to be loaded is more than the number of the specified addresses of the robot, the position data are loaded up to the maximum address limit assigned to the robot.

When an address outside the address range is specified for 「START ADDR」, the position data are loaded to addresses saved on the memory card. The addresses saved on the memory card can be displayed with DUMP command. (Refer to 13.6.6, “DUMP Command.”)

- Sys: When the file is a system data file

All the system data are loaded.

This operation is skipped because specifying the range is not required.

- Mem: When the file is a memory data file

Currently this function is not used for this system.

- Srvo: When the file is a servo parameter file

Servo parameters are loaded.

This operation is skipped because specifying the range is not required.

- Opt: When the file is an optional data file

Currently this function is not supported.



(3) Press the key. The message “File Load OK?” appears. To execute the LOAD command, press the key.

When the loading has been successfully completed, “COMPLETED!” is displayed. Then, the screen goes back to the screen shown in Fig. 13.7, FILE LOAD.

¹: Specified by the System Generation, 「LIMIT」→「ADDRESS MAX」→「ADDRESS MAX」.

13. 6. 3 SAVE Command

Use this command to save a specified information onto the memory card.

When the screen display is as shown in Fig.13.4, EDIT screen, select the  key 「3. SAVE」. The shaded portion of the illustration shown below appears. To display the 「STOP ADDR」 and the following items on the screen, press the  key to scroll.

FILE	SAVE	
TYPE	[Position Data]	
FILE NAME		1 2 3 4 5 6 1
START ADDR		0 0 0 0 0 0 0
STOP ADDR		0 0 0 0 0 0 0
Push END Key		!!

Fig. 13. 8 FILE SAVE

- (1) Specify the type (「TYPE」) of the file to be saved by using the  key or numeric keys.



: Position Data



: System Data



: Memory Data



: Servo Param





: Option Data





NOTE

When optional functions and/or sequences are added, such additional file types are included accordingly.



- (2) Specify a file name in the space for 「FILE NAME」.

- ① Enter the file name in the space next to 「FILE NAME」. However, do not use 1234500 to 1234599, as they are the reserved file names for the system.
- ② Confirm that the entered file name (specified data) is correct. Then, press the  key. The message “ENTER OK?” is displayed on the message line with a buzzer sound.
- ③ Confirm again that the file name (specified data) is correct. Then press the  key again to set the data.

- (3) Specify the range of the file to be saved. However, the steps to save the range are different depending on the file type.
- Pos: When the file is a position data file
Specify an address in the space for 「START ADDR」 from which saving process starts, and a stop address for 「STOP ADDR」 at which the saving process ends.
The steps to specify for 「START ADDRESS」 and 「STOP ADDRESS」 are the same as those for 「FILE NAME」.
The start address, where the first data to be saved are located, will be written in the position data file as the 4-byte header of the file, leading the position data.
 - Sys: When the file is a system data file
All the system data are saved.
No need to specify the range. This operation is skipped because specifying the range is not required.
 - Mem: When the file is a memory data file
Currently this function is not used for this system.
 - Srvo: When the file is a servo parameter file
Servo parameters are saved.
No need to specify the range. This operation is skipped because specifying the value is not required.
 - Opt: When the file is an optional data file
Currently this function is not used for this system.
- (4) Press the  key. The message “File Save OK?” appears. To execute the SAVE command, press the  key. When the saving has been successfully completed, “COMPLETED!!” is displayed. Then, the screen goes back to the screen shown in Fig.13.8, FILE SAVE.

13.6.4 COPY Command

With this command, a file on the memory card can be copied and stored as another file on the memory card. When the screen display is as shown in

Fig.13.4, EDIT screen, select the  key  key 「4. COPY」. The display changes as shown below.

FILE COPY	
SOURCE NAME	0000000
DEST. NAME	0000000
Push END Key !!	

Fig. 13.9 FILE COPY

- (1) Specify the name of a file to be copied in the space for 「SOURCE NAME」.
 - ① Enter the file name.
 - ② Confirm that the entered file name (specified data) is correct.
Then, press the key. The message “ENTER OK?” is displayed on the message line with a buzzer sound.
 - ③ Confirm again that the file name (specified data) is correct.
Then press the key again to set the data.
- (2) Enter a name for the duplicate file in the space for 「DEST. NAME」. The steps to specify the name are the same as those for 「FILE NAME」. The type of the destination file is always the same as that of the source file.
- (3) Press the key. The message “File Copy OK?” appears. To execute the COPY command, press the key. When the copying has been successfully completed, “COMPLETED!!” is displayed. Then, the screen goes back to the screen shown in Fig.13.9, FILE COPY.

13. 6. 5 DELETE Command

This command deletes a specified file. Select the key 「5. DEL」 on the EDIT screen, shown in Fig.13.4. The following display appears:

```

FILE DELETE
FILE NAME      0000000
Push END Key !!
  
```

Fig. 13. 10 FILE DELETE

- (1) Specify the file name in the space next to 「FILE NAME」.
 - ① Enter the file name.
 - ② Confirm that the entered file name (specified data) is correct.
Then, press the key. The message “ENTER OK?” is displayed on the message line with a buzzer sound.
 - ③ Confirm again that the file name (specified data) is correct.
Then press key again to set the data.
- (2) Press the key. The message “File Delete OK?” appears. To execute the DELETE command, press the key. When the deleting has been successfully completed, “COMPLETED!!” is displayed. Then, the screen goes back to the screen shown in Fig.13.10, FILE DELETE.

13. 6. 6 DUMP Command

With this command, you can see the HEX code list (in hexadecimal digit) of the file that is saved on the memory card. A position data file has a 4-byte header that indicates the start address of the file. The DUMP command allows you to check the address from which the file has been saved.

Select the  key 「6. DUMP」 on the EDIT screen, shown in Fig.13.4. The following display appears:

FILE	DUMP	
FILE	NAME	0000000
Push END Key !!		

Fig. 13. 11 FILE DUMP



(1) Specify a file name in the space next to 「FILE NAME」.

- ① Enter the file name.
- ② Confirm that the entered file name (specified data) is correct.

Then, press the  key. The message “ENTER OK?” is displayed on the message line with a buzzer sound.

- ③ Confirm again that the file name (specified data) is correct.

Then press the  key again to set the data.

(2) Press the  key. The message “File Dump OK?” appears. Press the  key, then the HEX codes of the file are displayed as shown below.

00	00	00	00	00	00	27
10	00	00	00	00	00	00
00	00	00	00	00	00	01
63	00	00	00	00	28	73

Fig. 13. 12 HEX Code Display

- (3) Press any key to display the following pages in sequence.
- (4) When all the pages have been displayed, “COMPLETED!!” appears. Then, the screen goes back to the screen shown in Fig.13.11 FILE DUMP.





13.6.7 FIND Command

To check if a specified file exists on the memory card, use this command. This command helps you easily locate a certain file among many files.

Select the  key 「7. FIND」 on the EDIT screen, shown in Fig.13.4. The following display appears:

FILE	FIND								
FILE	NAME		1	2	3	4	5	6	0
Push END Key !!									

Fig. 13.13 FILE FIND

- (1) Specify a file name in the space next to 「FILE NAME」.
 - ① Enter the file name.
 - ② Confirm that the entered file name (specified data) is correct.
Then, press the  key. The message “ENTER OK?” is displayed on the message line with a buzzer sound.
 - ③ Confirm again that the file name (specified data) is correct.
Then press the  key again to set the data.
- (2) Press the  key. The message “File Find OK?” appears. Press the  key, then the information of the file, the name, size and type are displayed.

FILE	INFOMATION								
1	2	3	4	5	6	0	POS	0	0
2	4	0	0	4					

Fig. 13.14 File Information

- (3) Pressing any key brings the screen back to the Fig.13.13, FILE FIND screen after displaying the message “COMPLETED!!”

13.7 Card Utility Mode (UTIL)

On the Memory Card screen shown in Fig.13.1, select the  key 「4. UTIL」. The display changes as follows:

CARD UTILITY	
1. INFO	2. CHECK
3. BACKUP	4. SORT
5. FORMAT	

Fig. 13.15 UTILITY

13.7.1 INFO Command

This command displays the current status of the memory card. Select the  key 「1. INFO」 on the UTILITY screen, shown in Fig.13.15. The display shown in the next page appears.

CARD SIZE	006536
FREE AREA	0038912
FILE SIZE	0000039
FREE FILE	0000037

CARD SIZE : Total card size (byte)

FREE AREA : Left of data area (byte)

FILE SIZE : Total file number which is possible to save

FREE FILE : Left of file number which is possible to save

Fig. 13.16 INFO

Pressing any key brings the screen back to the Fig.13.15, UTILITY screen after displaying the message “COMPLETED!!”

13.7.2 CHECK Command

With this command, data on the memory card can be checked.

Select the  key 「2. CHECK」 on the UTILITY screen, shown in Fig.13.15. The message “MEMCARD CHECK OK?” appears.

Press the  key to execute the following tests:

- 「FORMAT TEST」

The system checks if the characters “HIRATA-1” are included at the starting section of the card.

- 「FAT ⁱ TEST」

The system checks whether the contents of the two FATs (the original FAT and the backup FAT) are identical.

- 「BCC ⁱⁱ TEST」

The system checks the BCC in each file.

When all the check tests have been completed normally, the screen goes back to the Fig.13.15, UTILITY screen after displaying the message “COMPLETED!!”

If any error is detected, the error message is displayed and is retained until a key is pressed.

13.7.3 BACKUP Command

Currently, this command is not available.

13.7.4 SORT Command

Use this command to re-arrange the file names on the memory card in numerical order. This sorting helps you find files more easily using FILE command described in 13.6.1, when there are many files.

Select the  key 「4. SORT」 on the UTILITY screen, shown in Fig.13.15. The message “FILE SORT OK?” appears.

Press the  key to execute the SORT command.

When the sorting has been completed normally, the screen goes back to the Fig.13.15 UTILITY screen after displaying the message “COMPLETED!!”

ⁱ : FAT stands for “File Allocation Table.” This table shows at which sectors in the medium files are stored.

ⁱⁱ : BCC stands for “Block Check Character.” This checking character is used to verify data in each file for correct configuration.

13.7.5 FORMAT Command

With this command, the memory card is formatted and the number of files to be held is changed depending on the storage capacity of the card.

Storage capacity

64 KB : 39 files (Total points: 2000)

128 KB : 80 files (Total points: 4000)

256 KB : 160 files (Total points: 8000)





Each value shown in () is the maximum points to be held assuming that only position data files are saved.

The value varies depending on the storage capacity of the memory card. Also, the value decreases when system data files and/or servo parameters are stored on the card.

Select the  key 「5. FORMAT」 on the UTILITY screen, shown in Fig.13.15. The display changes as shown below.

MEM.	CARD	FORMAT
VOLUME		[64KB]
PUSH END KEY !!		

Fig. 13.17 FORMAT

- (1) Select and enter a value in the space next to 「VOLUME」 by using the  key. Every time the  key is pressed, the value shown changes; 64 KB, 128 KB, 256 KB in this sequence.
- (2) Press the  key. “CARD FORMAT OK?” appears. To execute formatting, press the  key. It takes approximately 20 seconds to format a 250 KB memory card.
- (3) When the formatting has been completed normally, the screen goes back to the Fig.13.15, UTILITY screen after displaying the message “COMPLETED!!”





13.8 VERIFY MODE (VERIFY)

In this mode, data stored on the memory card and those stored in the robot controller are compared for verification. On the Memory Card screen

shown in Fig.13.1, select the  key [5. VERIFY]. The display changes as follows.

MEM. CARD VERIFY
FILE NAME 0000000
PUSH END KEY !!

Fig. 13.18 VERIFY

- (1) Specify a file name.
 - ① Enter a file name.
 - ② Confirm that the entered file name (specified data) is correct. Then, press the  key. The message “ENTER OK?” is displayed on the message line with a buzzer sound.
 - ③ Confirm again that the file name (specified data) is correct. Then press the  key again to set the data.
- (2) Press the  key. “CARD VERIFY OK?” appears on the message line.
- (3) To execute verification, press the  key. When the both contents are identical, “COMPLETED!!” is displayed. When they are not identical, “VERIFY ERROR!!” is displayed.

13.9 Error Message

Table 13.2 Memory Card Error Messages

Error Message	Possible Cause
	Recovery Action
BCC WRITE ERROR !!	Error occurred during writing the check character in the file. Try again to write. When the error repeats, the memory card itself has been damaged. Use another card.
CARD BCC ERROR	The system area in the memory card is destroyed. Execute the FORMAT command in UTILITY mode. Refer to 13.7.5, “FORMAT Command.”
CARD FULL !!	You attempted to save more information than the card storage capacity. Delete unnecessary files and save again.
CARD NOT READY !!	No memory card in place. Insert a memory card properly.
DATA CHECK ERROR !!	Either the independent check character or data in the file are destroyed. Try again to write. When the error repeats, the memory card itself has been damaged. Use another card.

Error Message	Possible Cause
	Recovery Action
DUPLICATE FILE NAME	The same file name is specified as the SOURCE and DESTINATION when copying.
	Change the DESTINATION file name to a different one from the SOURCE file name. Refer to 13.6.4, "COPY Command."
FAT WRITE ERROR !!	FAT cannot be written in.
	Try again to write. When the error repeats, the memory card itself has been damaged. Use another card.
FILE BAD ALLOCATION	FAT has been destroyed.
	Execute the FORMAT command in UTILITY mode. Refer to 13.7.5, "FORMAT Command."
FILE ID ERROR !!	The check characters verifying the file information do not match.
	Delete the file using the DELETE command. Refer to 13.6.5, "DELETE Command."
	Delete unnecessary files and try again.
FILE ID FULL !!	You attempted to store more files than the defined number of files. Refer to 13.7.5, "FORMAT Command."
	Delete unnecessary files and try again.
FILE ID WRITE ERROR	The check character to verify the file information cannot be written in.
	Try again to write. When the error repeats, the memory card itself has been damaged. Use another card.
FILE NOT CLOSE	You attempted to execute the UTILITY command with files opened.
	Close all the files that are opened.
FILE NOT FOUND !!	The specified file cannot be found.
	Check for the correct file name.
FORMAT ERROR !!	The memory card is not initialized.
	Execute the FORMAT command in UTILITY mode. Refer to 13.7.5, "FORMAT Command."
NOT ENOUGH MEMORY	This is an error code for extended memory.
	Currently not used.
UNDEFINED ERROR !!	An unexpected error has occurred.
	Re-try the operation. When the error repeats, contact your distributor.
WRITE PROTECT !!	You attempted to write with the write-protect switch turned ON.
	Check the information stored on the card. If editable, turn OFF the write-protect switch.
VERIFY ERROR !!	The system has failed to compare the file information for verification. The memory card may have been damaged.
	Replace the card with a new one.
Other Special Errors	These errors rarely occur as long as operations are normal.
FILE ALREADY OPEN	You have opened again the file that had been already opened.
FILE CAN NOT OPEN	You attempted to access a file that was not opened.
FILE HANDLE FULL	Too many files have been opened.

13.10 Memory Card Specifications

The valid period in terms of data storage for 128 KB memory cards is 2.5 years, and 4 years for 64 KB memory cards, respectively.

Table 13.3 Memory Card Specifications

Specification	Direct Bus connection type
Outer Dimensions	86 × 54 × 3.3mm
Connector	Two-piece type with 68 pins; 5000-time connecting/disconnecting assured
Number of Terminals	68 poles
Memory Size	RAM 64KB/128KB/256KB
Battery Life	4 years
Power Supply	VCC 5V ± 5% GND 0V
Others	Interface LSI incorporated Replaceable lithium battery (BR2325) Write-protect switch Preventive mechanism against reverse insertion Specifications conforming to JEIDA Ver. 4

CHAPTER 14 W-Axis Sensor Stop

This is the positioning function to stop W-Axis when the input signal is turned ON.

Currently this function is not used for this system.

CHAPTER 15 Operation Method for Vision in AUTO Mode

Currently this function is not used for this system.

CHAPTER 16 Robot Operation

The robot operations can be categorized into three types as shown below.

- PTP operation
- Pass PTP operation
- CPC operation

Each of these operations can be determined by M-data, S-code, F-code and system data ⁱ of each position.

This chapter describes the operations and the methods to execute such operations, and the required parameters.

16.1 PTP Operation

PTP is the acronym for “Point To Point.” With PTP operation, a robot moves between two given points in the minimum required time. For this operation, routes between the teaching points cannot be specified. Normally this operation is applied to jobs like Pick & Place. PTP operations performed by our robots are explained below.

16.1.1 Gate Motion

When a robot automatically raises its height along the Z-Axis upon moving from the point A where it is currently positioned, to a destination point B, the motion is called the gate motion. To set this gate motion, M-data of the destination point B should be specified so that the PTP operation is executed with the M-data. Also, the Z-Axis moves up to a level specified by 「MOTION」→「MOTION」→「PULL-UP」 in System Parameter menu ⁱⁱ. Below is the description of the gate motion.



- When the levels at both points A and B are lower than the level (value) specified for 「PULL-UP」 (Example 1)

First, the Z-Axis rises to the value specified for 「PULL-UP」, then shifts horizontally, and finally the Z-Axis lowers. The way in which actual robot moves is $A \rightarrow A' \rightarrow B' \rightarrow B$.

- When the level at destination point B is higher than the level (value) specified for 「PULL-UP」 (Example 2)

First, the Z-Axis rises to the level (value) specified for 「PULL-UP」, then the robot moves to the destination. The way in which robot actually moves is $A \rightarrow A' \rightarrow B$.

ⁱ : Refer to Chapter 17, “System Data.”

ⁱⁱ : Press the  +  keys to go to this screen menu.

- When the level at current point A is higher than the level (value) specified for 「PULL-UP」 (Example 3)

First, the Z-Axis moves to the destination and to the level (value) specified for 「PULL-UP」 at the destination, then the Z-Axis lowers. The way in which actual robot moves is $A \rightarrow B' \rightarrow B$.

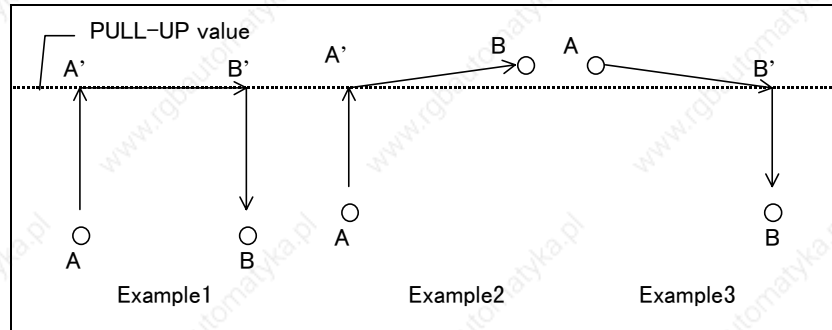

Fig. 16.1 Gate Motion Examples

16.1.2 Arch Motion

In the gate motion described above, the robot first rises along the Z-Axis before moving from point A to point B. By contrast, in arch motion, the robot can move horizontally while raising its Z-Axis and can lower its Z-Axis while moving horizontally.

To set the arch motion, first specify PTP operation for M-data of the destination point B so that the PTP operation is executed with the M-data. Then, the value of a level should be specified for 「PULL-UP」 for the Z-Axis that moves horizontally, by selecting 「MOTION」→「MOTION」→「PULL-UP」 in System Parameter menu¹. Then, specify a level, at which horizontal traveling starts during rising of Z-Axis, by entering a value other than 0 in 「ARCH UP」, and another level, at which Z-Axis starts lowering during horizontal travel, by entering a value other than 0 in 「ARCH DOWN」, respectively in the same menu group.



The description of the arch motion is as follows.

- When the levels at both points A and B are lower than the level (value) specified for 「PULL-UP」 (Example 1)

First, the Z-Axis rises to the value specified for 「ARCH UP」, then rises up to a value specified for 「PULL-UP」 horizontally shifting, keeps moving horizontally, lowers to a value specified for 「PULL-UP」 horizontally shifting and finally the Z-Axis lowers.

- When the level of destination point B is higher than the level (value) specified for 「PULL-UP」 (Example 2)

First, the Z-Axis rises to the level (value) specified for 「ARCH UP」, then further rises to reach the destination level while moving horizontally.

¹: Press the  +  keys to go to this screen menu.

- When the level of current point A is higher than the level (value) specified for 「PULL-UP」 (Example 3)

First, the Z-Axis lowers to the level (value) specified for 「ARCH DOWN」 while moving horizontally, then lowers.

「ARCH DOWN」 operation is designed to prohibit the Z-Axis from completely lowering before starting to move horizontally. Therefore, in some cases downward curves as specified may not be obtained.

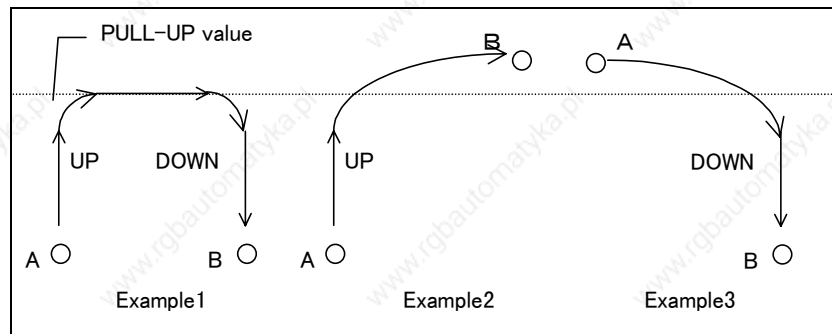

Fig. 16.2 Arch Motion Example

16.1.3 Insertion Motion/Slow-Up Motion

The insertion motion can be used to decelerate the motion speed of the Z-Axis prior to positioning when only the Z-Axis is moved from current point A to a target point B. With this motion, smooth operation is possible in inserting a work. To set this function, specify a value in the fifties (50-59) as the M-data of the target point B, and specify the distance and speed of inserting by entering a value in 「INS DIS.」 and 「INS SPEED」 respectively by selecting 「MOTION」→「MOTION」→「INS DIS.」 and 「INS SPEED」 in System Parameter group menu.

The slow-up motion allows Z-Axis to rise smoothly at the start of rising when only Z-Axis moves from current point A to a target point B. To set this function, specify a value in the forties (40-49) as the M-data of the target point B, and specify the distance, at which the rising speed becomes slower, and the speed. To do so, enter a value in 「UP DIS.」 and 「UP SPEED」 respectively by selecting 「MOTION」→「MOTION」→「UP DIS.」 and 「UP SPEED」 in System Parameter group menu.

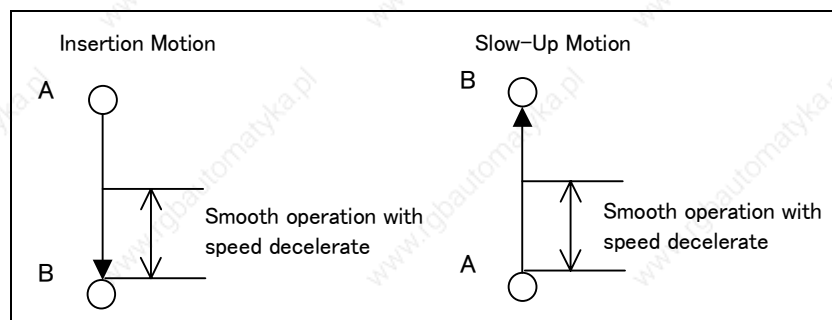
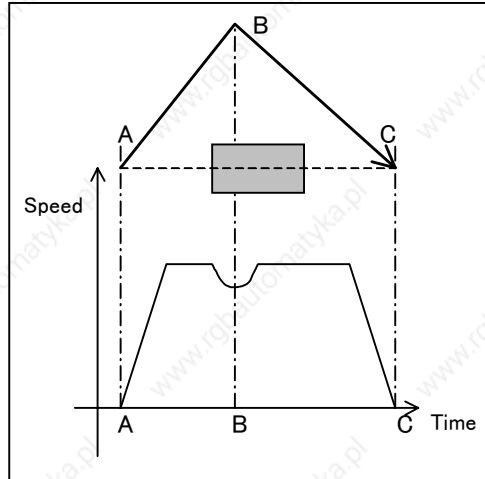

Fig. 16.3 Insertion Motion/Slow-up Motion

When the insertion motion and/or slow-up motion is used in combination with the gate motion or arch motion, specify the System Parameters, specify PTP operation for the M-data of the destination and set the S-code to 93.

16.2 Pass PTP Operation

When the M-data is a value in the thirties and the pass operation is used, the robot moves to the position but no positioning is performed there, and then moves to the next position address for positioning. This operation is used in cases where there is an interfering object between points A and C so that a refuge point B is passed to move to the destination C.



The pass operation allows motions in three-dimensional space. Also, this operation allows such motions even if a robot arm position is reversed when using SCARA (horizontal multi-articulated type) robot. With this operation, the four axes start or stop at the same time. When this operation is used, the gate motion and arch motion are ignored and insertion motion and slow-up motion cannot be performed.

Fig. 16.4 Pass Operation

16.2.1 Accuracy of Passing Point

The accuracy of passing the point (how close to the teaching point when passing the point) can be specified by a number in unit's place (0-9) of a M-data value in the thirties (30-39). The accuracy has a certain relationship with the specified speed (F-code, the speed, and acceleration in system data).

The smaller the number in unit's place, the closer to the teaching point the robot passes. The larger the number becomes, the farther from the teaching point but the higher the speed at the passing point becomes.

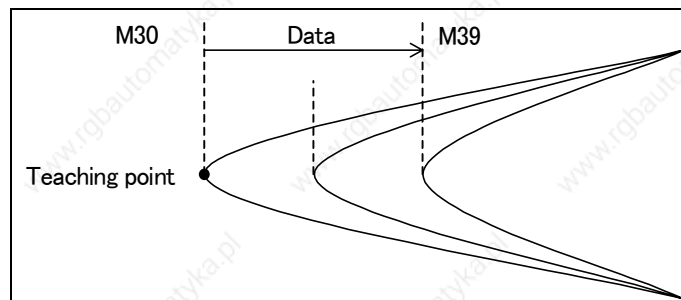

Fig. 16.5 Accuracy of Point Passing

16.2.2 Speed of Pass PTP Operation

The speed of pass PTP operation varies depending on the distance between the teaching points.

- Where the distance between the teaching points for the pass PTP is long:

The distance where the passing takes place is determined by the accuracy of passing (the number in unit's place of an M-data value in thirties), and then the speed is determined accordingly.

The F-code determines speed except for the speed when the teaching point is passed.

- Where the distance between the teaching points for the pass PTP is short:

The accuracy of the passing and the motion speed are determined depending on the distance. Therefore, speed settings such as F-codes may be ignored.

The speed calculated in terms of the accuracy of point passing may have the priority over the speed defined by F-code. In this case, the speed cannot be lowered however small the F-code may be.

When a lower speed is absolutely necessary, make longer the distance to the first teaching point.

16.2.3 Output Signals during Pass PTP Operation

During pass PTP operation, several signals are outputⁱ. The output signals are described below.

- (1) Select 「ORIGIN」 in System Generation menuⁱⁱ to select 「SET-UP SYSTEM」→「I/O ASSIGNMENT」. Specifying 0 for 「I/O ASSIGNMENT」 allows the OUT4 (BP·AREA) signal to be used as the pass PTP operation output.
- (2) During the pass operation, M-data (30-39) are output as the OUT8 - OUT15 (MOUT) signals.

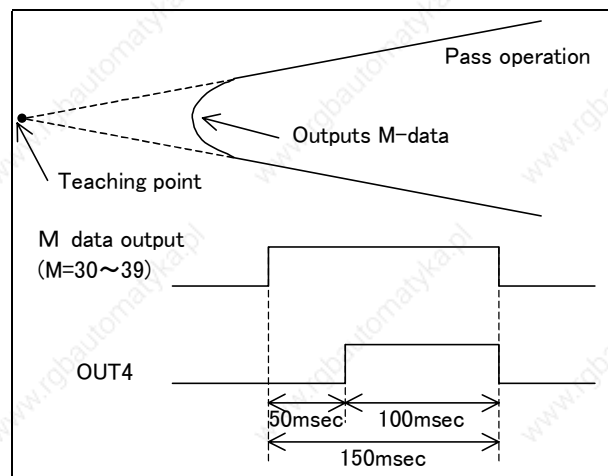

Fig. 16.6 Output Timing

ⁱ : Refer to 7.1.2, "DO Signals."

ⁱⁱ : Press the **FUNC** **HIGH** + **s.g** **7** keys to go to this screen menu.

16.2.4 Relationship between M-Data and Teaching Points

The illustration below shows how the robot motions change depending on the M-data for teaching points.

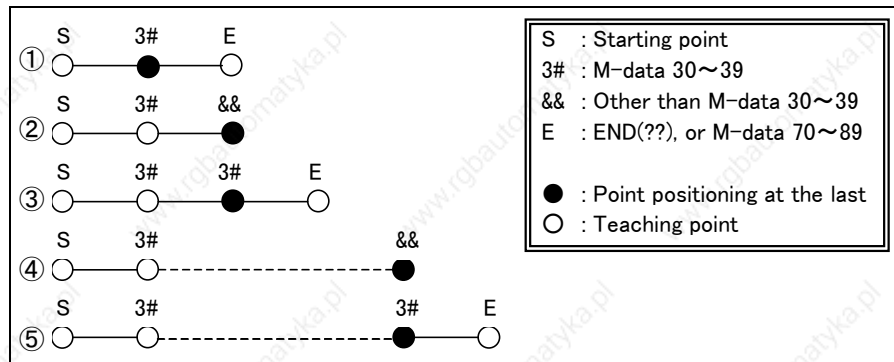

Fig. 16.7 M-Data and Teaching Points

In the cases of ①, ③, or ⑤, positioning is performed at a point immediately before the END point.

In the cases of ② or ④, positioning takes place at a point whose M-data value is other than 30-39.

Specify addresses for pass PTP operation as shown below.

START address < 3# < 3# < ... < END address

Address numbers in this range should be serial and continuous.

Also, note that the pass PTP operation will not take place between the address specified by selecting 「LIMIT」→「ADDRESS MAX」→「ADDRESS MAX」 in System Generation menu ⁱ and address 0.

ⁱ: Press the **FUNC** **HIGH** + **s.g** **7** keys to go to this screen menu.

16.3 CPC Operation

CPC operation is to control the routes of motions taking place along a straight line, circle, arc, or a free curve formed by smoothly connecting given teaching points.

CPC operation can be grouped into two as shown below.

- Linear interpolation : M= 82-89
- Circular interpolation : M= a combination of 80 and 81

16.3.1 Notes on CPC Operation

(1) CPC operation cannot be executed continuously between the address specified by selecting 「LIMIT」→「ADDRESS MAX」→「ADDRESS MAX」 in System Generation menu ¹ and address 0.

SHIFT



(2) CPC operation in CHECK mode is as described below.

- With 「SHIFT」 LED not illuminated.

CPC operation can continue in a range where M-data values are in the eighties (80-89).



- With 「SHIFT」 LED illuminated

Positioning is completed every time an arc or a straight line ends. Therefore, it is possible to check if the teaching points are correct and appropriate.

(3) When the serial communication with RS-232C is used, the CPC operation is specified through the communication and the CPC operation is executed only when the M-data values are in the eighties (80-89).



(4) For a SCARA (horizontal multi-articulated) robot, the positioning accuracy may be affected when the arms on A-Axis and B-Axis are in such positions that the two arms are in one straight line. Also, in such a case, vibration may be caused.

(5) F-codes are supported in each position so that acceleration/deceleration in the middle of CPC operation is possible. Also, linear motion speed and circular motion speed can be specified individually by changing F-codes.

(6) When an arc is not formed with the points taught for interpolation, a motion for an interpolated straight line is given instead.

(7) Limitation on specifying speed 1

When only W-Axis is interpolated, as the angular speed for the motion will be determined by internal operations (calculation), the speed cannot be specified externally

¹: Press the  +  keys to go to this screen menu.

(8) Limitation on specifying speed 2

When several motions take place continuously, some operation time is required to prepare for the following movement. The time required is 0.07 seconds when a linear motion follows, and 0.19 seconds to prepare for a circular motion.

Each required time can be converted into a distance as follows on the condition that the moving speed is 200mm/s;

- When the following motion is linear : $200 \times 0.07 = 14$ (mm)
- When the following motion is circular : $200 \times 0.19 = 38$ (mm)

This means the above distances are necessary as the operation time for respective cases. Because of this, when the distance taught is short, the system decelerates the speed accordingly with the distance.

If the distance to be moved before a circular motion is 20mm, the maximum speed allowed will be,

- $20 \text{ (mm)} / 0.19 \text{ (s)} = 105.3 \text{ (mm/s)}$

Therefore, the speed will not exceed the above value.

- (9) When 16 is specified for 「CPC SELECT」 by selecting 「MAINTENANCE」→「MAINTENANCE DATA」 in this sequence from the System Generation menu ¹, acceleration/deceleration does not take place at the teaching points on the route of the continuous CPC operations.

16.3.2 Linear Interpolation

For a linear interpolation, the movement takes place on a straight line between the two points specified by teaching.

16.3.3 Circular Interpolation

For a circular interpolation, the route is determined by three points specified through teaching. A circle is formed on the plane determined by the three such points.

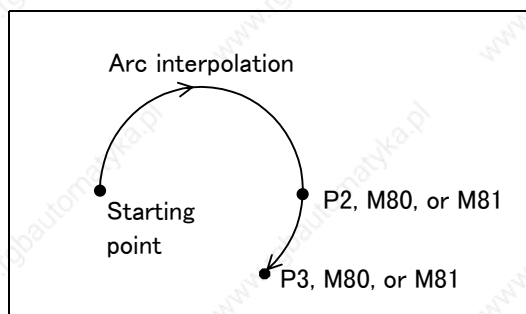



Fig. 16.8 Interpolation for an Arc

¹: Press the  +  keys to go to this screen menu.

When the M-data value for the point P3 is other than 80 and 81, even when the value of M-data for the point P2 is either 80 or 81, the system interpolates the two points to form a straight line, not an arc.



To hold the W-Axis in a certain pose, the same identical data must be specified for W-Axis.

16.3.4 CPC Operation Speed

The tip speed of a motion in CPC operation can be specified in the unit of “mm/sec” by selecting from the System Generation menu ¹ 「MOTION」→「CPC CONSTANT」→「CPC SPEED」. The maximum speed differs depending on the robot type. Even if a value greater than the maximum speed is set, the robot will operate at its rated maximum speed.

$$\text{Tip speed of motion (mm/sec)} = \text{「CPC SPEED」} \times \frac{(1 + \text{F-code})}{100}$$

In addition, the speed at each position located in a linear motion of CPC operation can be changed by using F-code.

16.3.5 D0 Output Specifications during CPC Operation

OUT6 can be turned ON/OFF freely by M-data used during linear interpolation. By using this signal, you can specify ON/OFF timing as required, for example, for seal application.

- (1) M-data value that turns ON the OUT6 signal: 82, 83, 86, 87

When the robot starts to move toward the position for which one of the above value is specified, the OUT6 turns ON.

- (2) M-data value that turns OFF the OUT6 signal: 84, 85, 88, 89

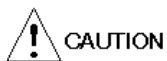

When the robot starts to move toward the position for which one of the above value is specified, the OUT6 turns OFF.



With M-data value set to either 80 or 81, the current output condition is maintained. OUT6 is turned OFF when CPC operation is interrupted.

How to use M-data is explained below using an example where the robot applies seals based on the pattern in the following illustration:

Seal application starts from P1 and ends at P30. When the robot starts its motion from P1 toward P2, the operation to apply seal is turned ON by the signal, and when the robot starts its motion from P29 toward P30 the seal applying operation is turned OFF.

¹: Press the  +  keys to go to this screen menu.

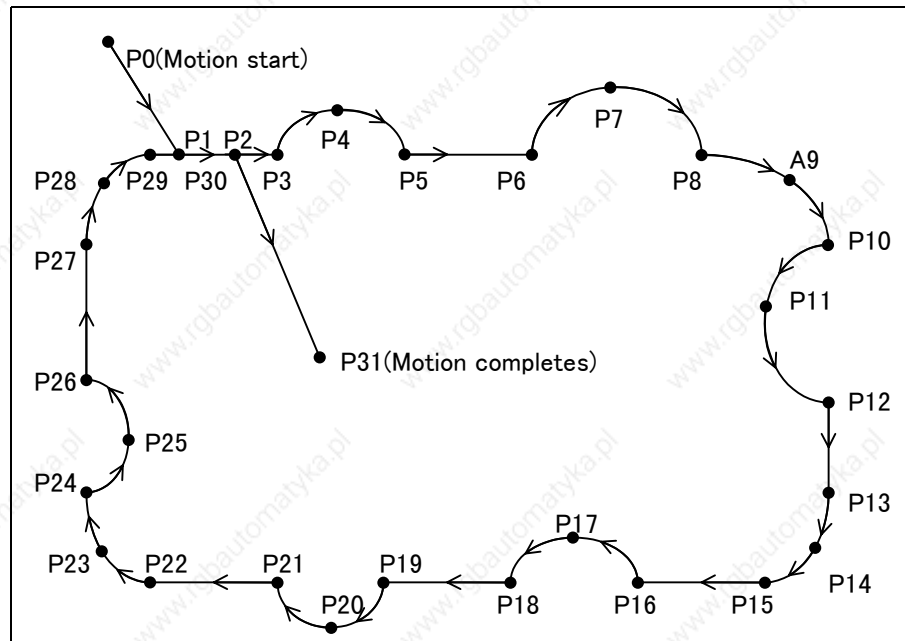
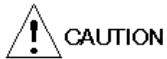

Fig. 16.9 Example of Robot Operation



For the P1 and P30 in the above illustration, the same point should be specified.

Table 16.1 Position Program

Point	Address	M	Operation	Point	Address	M	Operation
P0	0	02	PTP	P17	17	81	Arc
P1	1	04		P18	18	81	
P2	2	82	Linear	P19	19	86	Linear
P3	3	86	Linear	P20	20	81	Arc
P4	4	81	Arc	P21	21	81	Linear
P5	5	81	Linear	P22	22	86	
P6	6	86	Linear	P23	23	81	Arc
P7	7	81	Arc	P24	24	81	Arc
P8	8	81	Arc	P25	25	81	
P9	9	81	Arc	P26	26	81	Linear
P10	10	81	Arc	P27	27	86	
P11	11	81	Arc	P28	28	81	Arc
P12	12	81	Linear	P29	29	81	
P13	13	86	Arc	P30	30	88	Linear
P14	14	81	Linear	P31	31	08	
P15	15	81	Linear	P32	END		PTP
P16	16	86		P33			

16.4 Functions of M-Data and S-Code

16.4.1 List of M-Data Functions

There are three types of robot operations (PTP operation, pass PTP operation and CPC operation). Normally, each motion is specified by the M-data as shown below.

Table 16.2 List of M-Data Function

M-Data	Function
0	No operation
1-29	PTP operation
30-39	PTP pass operation
40-49	PTP slow-up
50-59	PTP insertion operation
60-79	PTP operation
80-81	CPC arc interpolation
82-89	CPC linear interpolation
90-99	PTP operation



When M-data value is 0 (M-data= 0), the system automatically increments the address until M-data value becomes other than 0, and the given address does not operate.

16.4.2 List of S-Code Functions

Normally, S-codes are used to expand the functions of M-data. The contents of expanded functions are described below.

Table 16.3 List of S-code Functions

S-code	Function	Note
98	Moves only A, B, and Z-Axes.	-
97	Prohibits PULL-UP.	-
95	Enables insertion motion.	-
94	Enables slow-up motion.	-
93	Enables insertion motion/ slow-up motion	-
90	Verifies once for positioning.	-
29	Moves only Y-Axis.	-
28	Moves only X-Axis.	-
26	Moves data by offsetting.	Position to be moved to = current position + position data
25	Moves only Z-Axis relatively.	Position where Z-Axis is moved to = Z-Axis current position + value specified for 「Z MD OF.」 ¹ by selecting 「SET-UP」→「EXPANSION B」→「Z MD OF.」
24	Moves only Z-Axis relatively.	Position where Z-Axis is moved to = Z-Axis current position - value specified for 「Z MD OF.」 by selecting 「SET-UP」→「EXPANSION B」→「Z MD OF.」
23	Moves only Z-Axis relatively.	Position where Z-Axis is moved to = Z-Axis current position + Z-Axis data
22	Moves only Z-Axis relatively.	Position where Z-Axis is moved to =

¹: Specified by the System Parameter menu (the  +  keys), 「SET-UP」→「EXPANSION B」→「Z MD OF.」

S-code	Function	Note
		Z-Axis current position – Z Axis data
21	Moves only Z-Axis.	-
20	Moves only A, B, and W-Axes.	-
18	Moves only W-Axis.	-
17	Moves only W-Axis relatively.	Position where W-Axis is moved to = W-Axis current position + W-Axis data

When using S-codes 1 through 89, you have to specify 2 for 「INCHING SELECT」 by selecting from System Generation menu ⁱ 「ORIGIN」→「SET-UP SYSTEM」→「INCHING SELECT」 (「INCHING SELECT」=2). When a value has already been set for the 「INCHING SELECT」, add 2 to the value.

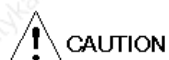

CAUTION

When S-code setting is 26, 23, or 33, position data may not be specified depending on the 「AREA LIMIT」 ⁱⁱ setting. Also, negative values (-) may not be accepted.

16. 4. 3 Changes in M-Data and S-Code Functions Depending on System Generation Setting

The contents of the M-data and S-code functions change depending on the setting of the 「M DATA」 reached from System Generation menu 「ORIGIN」→「SET-UP SYSTEM」.

- (1) When 「M DATA」 setting is 0-7

M-data specifies functions while S-codes are used to expand the functions.

- (2) When 「M DATA」 setting is 8

M-data is used as the MOUT signal so that it does not specify functions. Instead, S-codes succeed the functions of M-data. However, in this case, M = 00 “JUMP” and M = ?? “END” function as they normally do.

ⁱ : Press the  +  keys to go to this screen menu.

ⁱⁱ : Refer to 「AREA LIMIT」 group reached from 「LIMIT」 in System Generation menu.

Below are the tables listing the modified functions of M-data and S-codes depending on the setting of 「M DATA」 in the System Generation.

Table 16. 4 「M DATA」 and M-data

M DATA M-data	0-7	8
0	No operation	M-data is used as the MOUT signal so that it does not specify functions.
1-29	PTP operation	
30-39	PTP pass operation	
40-49	PTP slow-up	
50-59	PTP insertion operation	
60-79	PTP operation	
80-81	CPC semi-circle interpolation	
82-89	CPC linear interpolation	
90-99	PTP operation	

Table 16.5 S-codes with 「M DATA」=0-7

M DATA S-code	0-7
98	Moves only A, B, and Z-Axes.
97	Prohibits PULL-UP motion.
95	Enables slow-down motion.
94	Enables slow-up motion.
93	Enables slow-up motion /slow-down motion.
91	Verifies for positioning once.
29	Moves only Y-Axis.
28	Moves only X-Axis.
26	Moves data by offsetting.
25	Moves only Z-Axis relatively.
24	Moves only Z-Axis relatively.
23	Moves only Z-Axis relatively.
22	Moves only Z-Axis relatively.
21	Moves only Z-Axis.
20	Moves only A, B, and W-Axes.
18	Moves only W-Axis.
17	Moves only W-Axis relatively.

Table 16.6 S-codes with 「M DATA」=8

M DATA S-code	8
90-99	Allows PTP operation.
82-89	Enables CPC linear interpolation.
80-81	Enables CPC circular interpolation.
60-79	Allows PTP operation.
50-59	Enables PTP insertion motion.
40-49	Enables PTP slow-up.
30-39	Enables pass PTP operation.
1-29	Allows PTP operation.
0	Disables any operation.



CAUTION

PTP allows gate motions and/or arch motions. When PTP is specified for a certain group of axes to move them simultaneously ¹, neither gate motions nor arch motions are allowed.

¹: Typical with S-code 98 or 20, PTP operation is allowed for only axes defined by the code.

16.5 F-Code



The F-code specifies the positioning speed in each motion of robot. It is the ratio (percentage) specified for the speed setting items of 「MOTION」 group in System Parameter menu ¹. The valid range is 00-99. The actual speed is described in the following equation.

$$\text{Actual speed} = \text{value set as system data} \times (\text{F-code} + 1)/100$$

For speed values, the system parameters are referred. The items referenced are below.

- During PTP operation;
「MOTION」→「AXIS SPEED」→「SPEED A,B(X,Y), W」, 「SPEED Z」
- During CPC operation;
「MOTION」→「AXIS SPEED」→「SPEED A,B(X,Y), W」→「CPC SPEED」

To enter an F-code, select either KEY-IN or TEACH mode. Pressing the  key moves the cursor to the first character of the F-code, allowing you to enter a value.

¹: Press the  +  keys to go to this screen menu.

CHAPTER 17 System Data

17.1 Outline

System data are semi-fixed data required to operate robots, specifically they are the data intrinsic to robots used and data to optimize the robots accordingly with the system. It is not necessary to modify the data after the robots are incorporated into the system. However, incorrect or inappropriate values cause malfunctioning or failure of the robots. Therefore, before starting robot operation, always be sure to specify correct data and record such set values.

There are two categories in system data. One is called System Generation (SG), the items of which varies depending on the model of the robot main unit and the type of controller. Check and identify the model of the robot main units and the type of the controller that you use to specify correct values as the System Generation data. Another is called System Parameters (SP), which may be changed to modify the robot operation or motions after the robots have been incorporated into the system.

The data in each category are divided into groups, as shown below, based on their functional use. To specify or check data, select necessary items listed in each group.

(1) System Generation (SG)

- LIMIT : Limits areas.
- MAINTE : Used for maintenance purposes.
- ORIGIN : Sets the system up.
- ADJUST : Specifies intrinsic values of mechanical components; such values for adjustments.
- CAPABILITY : Contains specification data and rated values of mechanical components.

(2) System Parameters (SP)

- MOTION : Determines operation and motion.
- RESPONSE : Specifies various data of axes to be moved.
- OFFSET : Specifies offset values of position data to be displayed.
- SET-UP : Expands the system.
- REMOTE : Controls the ON-LINE mode.

17.2 Configuration of System Data

The configuration of system data is shown below.

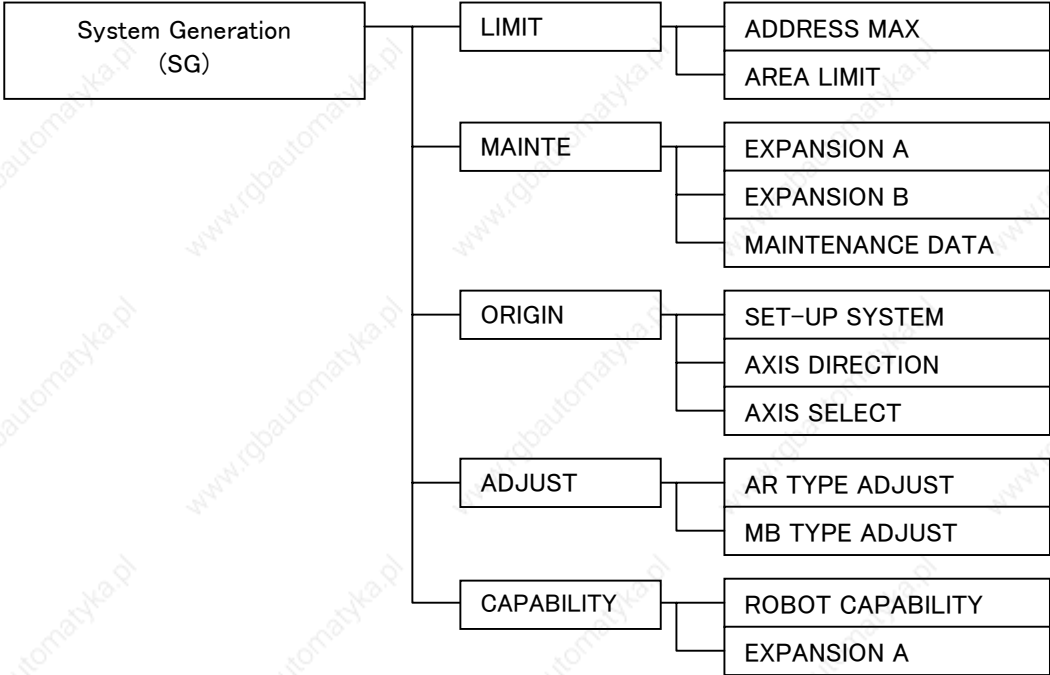

Fig. 17.1 System Generation (SG)

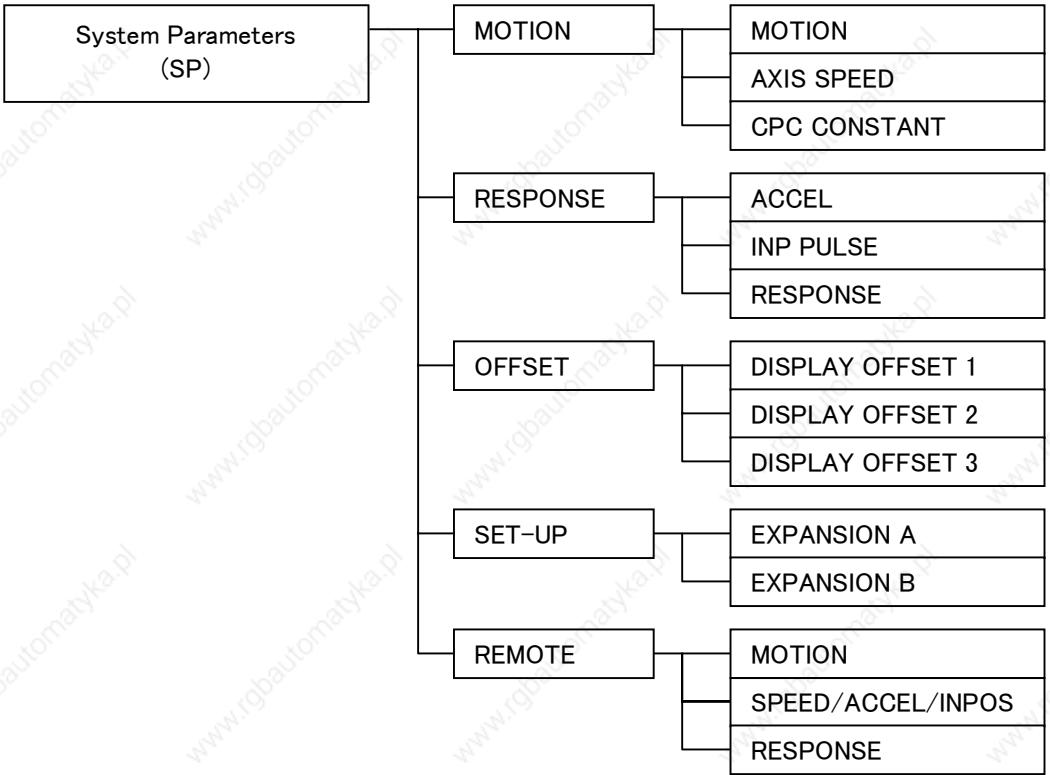

Fig. 17.2 System Parameters (SP)

17.3 Setting/Changing Data

Before attempting to specify values, read Chapter 18, “Details of System Generation” and Chapter 19, “Details of System Parameters” thoroughly.

Whenever a system data error occurs, be sure to perform “default copying (copying default values)” onto the system data first, and then specify the values and data to be set again. When these activities have been completed, turn ON the power again.

The following operations can be used in any mode:

17.3.1 Procedure for System Data Entry

- (1) Specify either System Generation or System Parameter.

When the data are of System Generation group, press the  +  keys.

When the data are of System Parameter group, press the  +  keys.



SYSTEM GENERATION	
1. LIMIT	2. MAINT E.
3. ORIGIN	4. ADJUST
5. CAPABILITY	

Fig. 17.3 System Generation Menu

- (2) Select the desired group to be edited by pressing the corresponding numeric key.

EXAMPLE

The steps to change the value specified for 「STOP」 in 「SET-UP SYSTEM」, by selecting 「ORIGIN」 from the System Generation menu, are described as an example. The current value “STOP” will be changed to “PAUSE” in this example.

- (1) Press the  +  keys to display System Generation menu.
- (2) Press the  key when System Generation menu is on display. The display changes as illustrated below.

ORIGIN GROUP	
1. SET-UP SYSTEM	
2. AXIS DIRECTION	
3. AXIS SELECT	

Fig. 17.4 ORIGIN Group Menu

- (3) Press the  key 「1. SET-UP SYSTEM」. The display changes as follows.

```

ORIGIN-SET UP
TRANSFER RATE [9600]
ON-LINE SELECT      0
STOP SEL  [ STATUS]

```

Fig. 17.5 SET-UP DATA Screen①

- (4) The cursor is placed on the first entry place of 「TRANSFER RATE」 space. The item 「STOP」 is not displayed. Press  key to scroll the screen to move the cursor to the entry space of 「STOP」.



```

TRANSFER RATE [9600]
ONLINE SELECT      0
STOP SEL  [ STATUS]
STOP      [ STOP]



```

Fig. 17.6 SET-UP DATA Screen②

- (5) Change the value.

Press the either  or  key to select “PAUSE” to change from the value “STOP.”

- (6) Set the value.

- ① Press the  key. The message, “ENTER OK?” appears on the screen with a buzzer sound.
- ② Confirm the data entered is the correct value.
- ③ After the confirmation, press the  key again.
- ④ When you wish to cancel this data entry operation, press any key other than the  key.



- (7) The screen scrolls back and the following display appears:

```

ONLINE SELECT      0
STOP SEL  [ STATUS]
STOP      [ PAUSE]
STORE ADDRESS [CURR]

```







Fig. 17.7 「ORIGIN」 Screen

- (8) Press the  key to go back to the ORIGIN Group Menu as in Fig. 17.4.
- (9) Press the  key again to go back to the System Generation menu as in Fig. 17.3.



NOTE

When changing system data on a data screen, use the Teach Pendant as described below.

- Press the  key on the data screen. The cursor moves to the first data on the data screen.
- Press the  key to move the cursor down to the data on the line immediately below the current line. To move the cursor up to the data on the line immediately above the current line, press the  key to illuminate 『SHIFT』 LED, and then press the  key.
- When the  key is pressed before the data setting operation after the data has been changed, the previous data is displayed instead of the newly specified data.
- If the  key is pressed in the middle of data entry operation, the entry operation is skipped and the screen goes back to the group menu screen.

17.3.2 Changing Data

There are two ways to change data.

- When values are numerical numbers, press the desired numeric keys to change data.
- When values are in character forms, select the desired character form.

A value in a character form such as “STOP” can be selected by

pressing the  key to switch to the value. Also, as numbers are assigned to character-form values, you can select a character-form value by pressing the corresponding numeric key.

17.3.3 Number of Items on Display



The screen can display only four lines. But some group menus hold more items than can be displayed on the screen at one time. In such a case,

press the  key to scroll the screen to display the items in the following pages in sequence. After the last item in the group is displayed, “... bottom ...” appears in the line below. This “... bottom ...” indicates the end of the group menu.

17.3.4 Screen Transition

In System Generation menu, there are five group menus and 12 data screens. The System Parameter menu holds five group menus and 15 data screens.

When a group menu is displayed in either System Generation or System

Parameter menu, pressing the  +  keys changes the group menus in cycle. With 『SHIFT』 LED not illuminated, the group menus are displayed in numerical order. With 『SHIFT』 LED illuminated, they are displayed in the reversed numerical order.

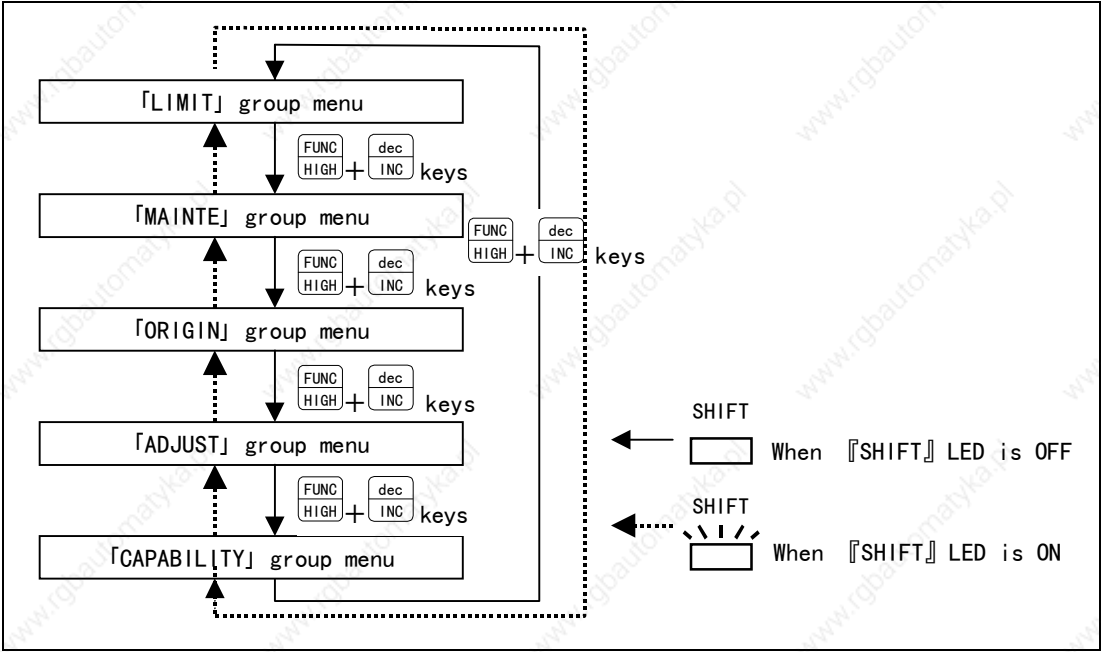

Fig. 17.8 Group Menu Cycle in System Generation

In the same way, when a data screen is displayed, pressing the $\left[\begin{matrix} \text{FUNC} \\ \text{HIGH} \end{matrix} \right] + \left[\begin{matrix} \text{dec} \\ \text{INC} \end{matrix} \right]$ keys changes data screens in sequence.

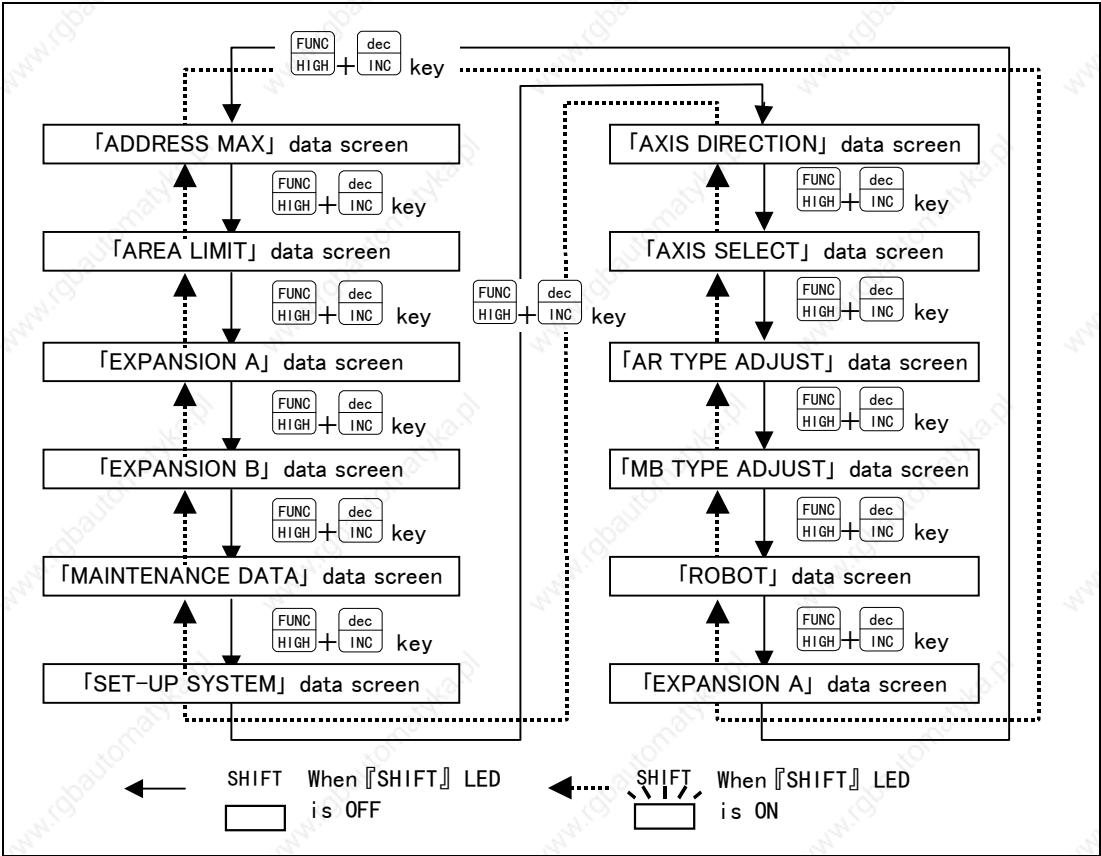

Fig. 17.7 Data Screen Cycle in System Parameter

17.3.5 Setting Default Values for System Data

Refer to Chapter 21, "Initializing System Data."

CHAPTER 18 Details of System Generation

The details of System Generation, which comprises a part of system data, are described.

18.1 LIMIT Group

Data in LIMIT group are used to limit the position data and the working areas of programs to provide safety measures.

18.1.1 ADDRESS MAX

(1) 「ADDRESS MAX」

- Number of entry digits : 4
- Valid range : 0 to 9999
- Minimum unit : 1
- Standard setting : 999

Specifies the maximum number of position addresses that the program uses. The valid setting range is the value set for 「MAX POSITION」¹ in the system configuration. However, when only a small number of positions are required in an actual application, the maximum number of position addresses can be limited. With this limitation, when an address number greater than the specified value is entered or input externally, “ADDRESS ERROR” is displayed on the message line indicating the error has resulted.

18.1.2 AREA LIMIT

Data in this group limit the working area of each axis. Input the either angle or stroke value depending on the unit type.

(1) 「UPPER LMT A」

(2) 「LOWER LMT A」

- Number of entry digits : 7
- Valid range : -7999.999 to 7999.999
- Minimum unit : ± 0.001
- Standard setting : 「UPPER LMT A」 : 1000
「LOWER LMT A」 : 0

As a safety measure, the software limits the maximum and minimum working areas of A-Axis (X-Axis).

¹: Refer to 20.4, “Assigning Motors to Robot Axes.”

- ① For SCARA (horizontal multi-articulated) robot:

The value indicates an angle of B-Axis, with its origin at the time of A-CAL as the reference. The relationship among the data is as shown below.

$$0 \leq \text{LOWER LMT B} < \text{UPPER LMT B} \leq \text{maximum working area of B-Axis}$$

The maximum working area of A-Axis is the operating area mechanically limited and varies depending on the unit type. (e.g., AR-C270's maximum working area of A-Axis = 205°)

EXAMPLE

When the working area of A Axis is limited with the following settings:

$$\lceil \text{UPPER LMT A} \rceil = 200^\circ$$

$$\lceil \text{LOWER LMT A} \rceil = 130^\circ$$

if you attempt to specify, in KEY-IN or TEACH mode, a position outside the shaded area in the illustration for A-Axis, "AREA ERROR" is displayed indicating the error.

When area limiting is not required, set as follows:

$$\lceil \text{UPPER LMT A} \rceil = \text{the maximum working area of A-Axis}$$

$$\lceil \text{LOWER LMT A} \rceil = 0$$

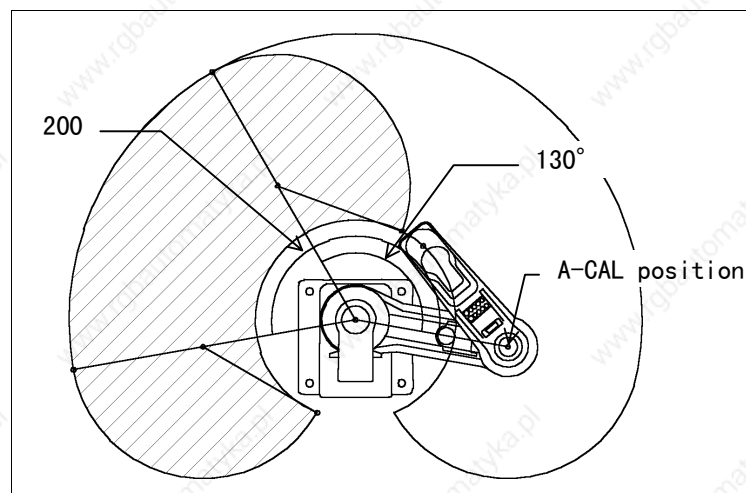

Fig. 18.1 Area Limitation for A-Axis

- ② For Cartesian robot:

Sets the operating stroke value of X-Axis for $\lceil \text{UPPER LMT A} \rceil$.

When area limiting is not required, set as follows:

$$\lceil \text{UPPER LMT A} \rceil = \text{the distance of operating stroke of X-Axis}$$

$$\lceil \text{LOWER LMT A} \rceil = 0$$

- (3) 「UPPER LMT B」
- (4) 「LOWER LMT B」
- Number of entry digits : 7
 - Valid range : -7999.999 to 7999.999
 - Minimum unit : ± 0.001
 - Standard setting : 「UPPER LMT B」: 1000
「LOWER LMT B」: 0

As a safety measure, the software limits the maximum and minimum working areas of B-Axis (Y-Axis).

- ① For SCARA(horizontal multi-articulated) robot:
The value indicates an angle of B-Axis, with its origin at the time of A-CAL as the reference. The relationship among the data is as shown below.

$$0 \leq \text{LOWER LMT B} < \text{UPPEER LMT B} \leq \text{maximum working area of B-Axis}$$

The maximum working area of B-Axis is the operating area mechanically limited and varies depending on the unit type. (e.g., AR-C270's maximum working area of B-Axis = 285°)

If you attempt to specify, in KEY-IN or TEACH mode, a position outside the shaded area in the illustration for B-Axis, "AREA ERROR" is displayed indicating the error.

EXAMPLE

Below is the example diagram where the working areas of A and B-Axes are limited with the following settings:

- 「UPPER LMT A」= 200°
「LOWER LMT A」= 130°
「UPPER LMT B」= 270°
「LOWER LMT B」= 20°

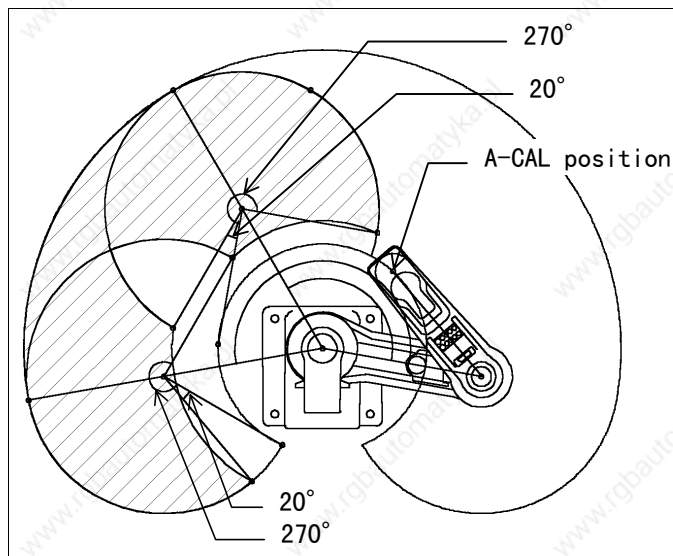

Fig. 18.2 Area Limitation for B-Axis

When area limiting is not required, set as follows:

- 「UPPER LMT B」= the maximum working area of B-Axis
「LOWER LMT B」= 0

② For Cartesian robot:

Sets the operating stroke value of the Y-Axis for 「UPPER LMT B」.

When area limiting is not required, set as follows:

「UPPER LMT B」= the stroke of Y-Axis

「LOWER LMT B」= 0

(5) 「UPPER LMT Z」

(6) 「LOWER LMT Z」

- Number of entry digits : 7
- Valid range : -7999.999 to 7999.999
- Minimum unit : ± 0.001
- Standard setting : 「UPPER LMT Z」: 400
「LOWER LMT Z」: 0

The maximum working stroke of Z-Axis is limited.

If you attempt to specify, in KEY-IN or TEACH mode, a position outside the limited area for Z-Axis, an error is caused.

For example, when 100mm stroke of Z-Axis suffices the required work even though the Z-Axis has 150mm stroke, set as follows taking safety into account:

「UPPER LMT Z」= 100

When area limiting is not required, set as follows:

「UPPER LMT Z」= the stroke of Z-Axis

「LOWER LMT Z」= 0

(7) 「UPPER LMT W」

(8) 「LOWER LMT W」

- Number of entry digits : 7
- Valid range : -7999.999 to 7999.999
- Minimum unit : ± 0.001
- Standard setting : 「UPPER LMT W」: 720
「LOWER LMT W」: 0

The maximum working area of W-Axis is limited.

If you attempt to specify a Z-Axis value outside the limited area (for W-Axis) in KEY-IN or TEACH mode, an error is caused.

When the W-Axis is the rotation Axis, an angle should be entered, while a length in “mm” should be entered when the axis is linear.

- (9) 「UPPER LMT R」
- (10) 「LOWER LMT R」
- Number of entry digits : 7
 - Valid range : -7999.999 to 7999.999
 - Minimum unit : ± 0.001
 - Standard setting : 「UPPER LMT R」: 720
「LOWER LMT R」: 0

The maximum working area of R-Axis is limited.

If you attempt to specify a Z-Axis value outside the limited area (for R-Axis) in KEY-IN or TEACH mode, an error is caused.

- (11) 「UPPER LMT C」
- (12) 「LOWER LMT C」
- Number of entry digits : 7
 - Valid range : -7999.999 to 7999.999
 - Minimum unit : ± 0.001
 - Standard setting : 「UPPER LMT C」: 720
「LOWER LMT C」: 0

The maximum working area of C-Axis is limited.

If you attempt to specify a Z-Axis value outside the limited area (for C-Axis) in KEY-IN or TEACH mode, an error is caused.

18.2 MAINTENANCE

Data in this group sets data used for maintenance. Unless otherwise required, enter "0" (default value) for each item.

18.2.1 EXPANSION A

Currently not used」.

- (1) 「CPC GAIN Z」
- (2) 「CPC GAIN W」
- (3) 「DOWN CNT」.
- (4) 「PRIV.FLAG」

18.2.2 EXPANSION B

Currently not used.

- (1) 「INITIAL W」
- (2) 「LENGTH W」
- (3) 「AXIS UP/DOWN」
- (4) 「ANGLE REV.」

18.2.3 MAINTENANCE DATA

Data in this group sets data used for maintenance. Unless otherwise required, enter “0” (default value) for each item.

- (1) 「CPC SELECT」
Not used.
- (2) 「CPC LOOP TIME」
Not used.
- (3) 「CPC SP1」
Not used.
- (4) 「CPC SP2」
Not used.
- (5) 「A-CAL CHECK」
 - Number of entry digits : 3
 - Minimum unit : 1
 - Standard setting : 0

Determines the A-CAL operation.

- Values
- 0 : Defines the current position as the robot origin.
 - 1 : Defines errors caused while the robot origin is outside the limited area as warning (displaying “WARNING” on screen) to continue the operation process.
 - 2 : Ignores errors caused when the robot origin is outside the limited area.
 - 16 : Defines the robot origin when the ORIGIN (ORG) sensor turns ON.
 - 32 : Defines the robot origin when the ORIGIN (ORG) sensor turns ON and Z signal of motor turns ON.

To select more than one of the processes above, enter the total of the values selected. However, it is not possible to select the combination of 1 and 2, or 16 and 32.

(6) 「POS ERROR SEL」

Currently not supported.

Specifies whether or not positioning error ¹ is detected.

Values 0 : Detects.

1 : Does not detect. (displaying “WARNING”)

(7) 「AB SLOWDOWN TIM」

Currently not supported.

Manually sets timing to slow-down for A, B, and W-Axes. With 0 setting, the system automatically controls.

(8) 「SERVO TYPE」

Currently not in use.

(9) 「EMP SELECT」 (Encoder Monitor Program SELECT)

- Number of entry digits : 3
- Minimum unit : 1
- Standard value : 0

Sets whether the “DRIVER ERROR” detection is valid or invalid, and whether the detected encoder battery alarm is valid or invalid.

Values 0 : Tests all the axes.

1 : Tests A (X)-Axis.

2 : Tests B (Y) -Axis.

3 : Tests Z-Axis.

8 : Tests W-Axis.

16 : Tests R-Axis.

32 : Tests C-Axis.

128 : Invalidates the detected encoder battery alarm.

To specify so that a certain axis will not be tested, enter a total excluding the value corresponding to that axis.

Currently, “DRIVER ERROR” detection is not supported.

(10) 「HOLD POWER SAVE」

Currently not supported.

Sets a time interval to switch from HOLD to braking. (for special models with additional specifications only)

¹: Occurs when positioning cannot be performed due to hunting or external pressure.

(11) 「Z SLOWDOWN TIM」

Currently not supported.

Manually sets timing to slow-down for Z-Axis. With 0 setting, the system automatically controls.

(12) 「STATION NO」

- Number of entry digits : 3
- Valid range : 0 to 999
- Minimum unit : 1
- Standard value : Robot No. ("1" for ROBOT 1)

Set a value when station No. should be specified for communication.

(13) 「SENSOR STOP SEL」

Currently not supported.

Changes the input logic of the W-Axis sensor when the sensor stops.

(14) 「SENSOR COUNT」

Currently not supported.

Changes the input detection amplitude of the W-Axis sensor when the sensor stops.

(15) 「PTP Z IN DATA」

Currently not in use.

(16) 「POSITIONING CNT」

Currently not in use.

18.3 ORIGIN

In the ORIGIN group, you enter and set values and data mechanically intrinsic to robots. Failing to enter correct data for the items in this group results in irregular functioning in CPC operation and inaccuracy in data based on values on coordinates.

Also, this group contains data that determine, upon application, the basic combinations of robots and motions.

18.3.1 SET-UP SYSTEM

(1) 「TRANSFER RATE」

- Standard value : 9600 [bps]

Select the data transfer speed for RS-232C (selecting a character-form value).

When the value has been changed, turn OFF the power supply for controller power and then turn it ON again.

Select a value from the following:

- 300 • 600
- 1200 • 2400
- 4800 • 9600
- 19200 • 38400

(2) 「ON-LINE SELECT」

- Number of entry digit: 1
- Minimum unit: 1
- Standard value: 0

Values 0 : Standard

1 : Not in use.

2 : Uses the vision.

4 : Cancels the function of sequential speed accelerationⁱ to allow operation at the specified speed from the start.

To use more than one of the above, enter the total of the values selected. For instance, to use vision and sequential speed-up, enter 6. To use speed-up function alone, enter 4.

(3) 「STOP SELECT」

- Standard value : STATUS

Selects a way for detecting STOP signal (IN5) when it is input. (selecting a character-form value)

Values STATUS : Detects the signal by status

RISING : Detects only the rising.

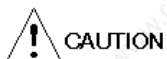

When "RISING" is selected for the above item, "STOP" must be selected for the next item.

ⁱ: For the first three points, operation is carried out at a lower speed in standard condition. (first point: 20% of the speed; second point: 40%; third point: 60%; fourth point: 100%)

(4) 「STOP」

- Standard value : STOP

Selects a function of the STOP signal (IN5). (selecting a character-form value)

Values STOP : Stops when STOP signal turns ON and restarts with START or NEXT signal input after STOP signal (IN5) turns OFF.

PAUSE: Pauses while STOP signal (IN5) is ON.

(5) 「STORE ADDRESS」

- Standard value : NEXT

Selects an address to which the system returns upon recovery from power interruption. (Selecting a character-form value)

Valid for AUTO mode of automatic operation. When power is shut down during robot operation, for example, due to power failure, either the address where the system was operating the moment when the power was cut, or the next address is selected according to the setting after the power supply is recovered.

Values NEXT : Selects the address next to the address where power was interrupted.

CURR : Selects the address where power was interrupted.

(6) 「I/O ASSIGNMENT」

- Number of entry digit : 1
- Minimum unit : 1
- Standard value : 0

Selects whether to use DI/DO as standard or as defined I/O. To use this function, turn OFF the power after setting the value and turn ON the power again.

Values 0: Standard

1: Uses in ON-LINE mode all of the OUT 0-OUT 15 in the same way as that in AUTO mode (outputting MOUT).

2: A and B area output

4: Base position output

8: Outputs to an axis at the base position.

(7) 「INCHING SELECT」

- Number of entry digit : 1
- Minimum unit : 1
- Standard value : 0

Values 0 :

- 1 : Validates limitations on inching. When overrun or area limit is input during inching, the inching operation is stopped.
- 2 : Uses special functions such as offsetting by a S-code (S-code: 1-89).
- 4 : Carries out linear inching¹ during inching in AUTO mode. (Invalidated when expanded interfaces are used.)

(8) 「M DATA」

- Number of entry digits : 2
- Valid range : 0 to 99
- Minimum unit : 1
- Standard value : 0

Sets definitions of use for M-data. For details, refer to 16.4.3, "Changes in M-data and S-code Functions Depending on System Generation Setting."

Values 0 : Sets the insertion motion, starting X, Y, and W-Axes simultaneously where M-data are in the fifties (M=50-59).

- 8 : Does not allow M-data to change operations/motions. Allows only S-codes to change operations/motions.

(9) 「AUTO/ON-LINE」

Specifies the mode to be used when ON-LINE operation is activated. (selecting a character-form value)

- Standard value : ON-LINE

Values ON-LINE : Uses ON-LINE mode.

AUTO : Uses AUTO mode.

EXT AUTO : Uses extended AUTO mode. Select this value when 1000 or more position addresses are used.

Note that with "EXT AUTO," DI/DO assignment changes. (Refer to 7.2, "Extended AUTO Mode.")

¹: Normally axes are inched individually. When the linear inching is specified, inching operation takes place on X-Y coordinates. Refer to 5.2.1, "Operation with X-Y Coordinates in LI-TEACH Mode."

(10) 「EMERGENCY STOP」

- Standard value: KEEP

The value is currently invalid. Normally the A-CAL is constantly retained. Select either character-form value for A-CAL for

emergency stops. Press the  key to select.

Values KEEP : Retains the A-CAL.

RESET : Resets the A-CAL.

18.3.2 AXIS DIRECTION

(1) 「A-CAL SEQ」

- Number of entry digits : 6
- Minimum unit : 111111
- Standard value : 221222

Specifies an order in which A-CAL is performed for the axes. Each digit corresponds to an axis as shown below.

```

O O O O O O
↓ ↓ ↓ ↓ ↓ ↓
A B Z W R C

```

Enter the same value for axes for which A-CAL is performed at the same time.

- (2) 「A-CAL DIR. A」 : A-CAL direction for A-Axis (X-Axis).
- (3) 「A-CAL DIR. B」 : A-CAL direction for B-Axis (Y-Axis).
- (4) 「A-CAL DIR. Z」 : A-CAL direction for Z-Axis.
- (5) 「A-CAL DIR. W」 : A-CAL direction for W-Axis.
- (6) 「A-CAL DIR. R」 : A-CAL direction for R-Axis.
- (7) 「A-CAL DIR. C」 : A-CAL direction for C-Axis.

- Standard value for the above : PLUS

Each item above changes the direction of A-CAL. (selecting a character-form value)

Values PLUS : Normal direction

MINUS : Reversed direction

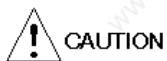

Be sure to record the data specified for the above items after the robot installation.

- (8) 「INCHI DIR. A」 : Inching direction for A-Axis (X-Axis)
- (9) 「INCHI DIR. B」 : Inching direction for B-Axis (Y-Axis)
- (10) 「INCHI DIR. Z」 : Inching direction for Z-Axis
- (11) 「INCHI DIR. W」 : Inching direction for W-Axis
- (12) 「INCHI DIR. R」 : Inching direction for R-Axis
- (13) 「INCHI DIR. C」 : Inching direction for C-Axis

- Standard value for the above : PLUS

Each item above changes the direction of inching. (selecting a character-form value)

Values PLUS : Normal direction

MINUS : Reversed direction

18.3.3 AXIS SELECT

- (1) 「A AXIS TYPE」: A-Axis (X-Axis)
- (2) 「B AXIS TYPE」: B-Axis (Y-Axis)
- (3) 「Z AXIS TYPE」: Z-Axis
- (4) 「W AXIS TYPE」: W-Axis
- (5) 「R AXIS TYPE」: R-Axis
- (6) 「C AXIS TYPE」: C-Axis

- Standard value : USED

Specifies the status of the each axis, whether it is to be used or not.
(selecting a character-form value)

Values NOT USED : Sets the non-use condition.

USED : Sets the use condition.



Be sure to record the data specified for the above items after the robot installation.

- (7) 「A AXIS SEL」: Selects A-Axis (X-Axis).
- (8) 「B AXIS SEL」: Selects B-Axis (Y-Axis).
- (9) 「Z AXIS SEL」: Selects Z-Axis.
- (10) 「W AXIS SEL」: Selects W-Axis.
- (11) 「R AXIS SEL」: Selects R-Axis.
- (12) 「C AXIS SEL」: Selects C-Axis.

- Standard value : USED

Each of the above values is currently invalid. Currently the axis is held even if the setting is NOT HOLD. Select either character-form value for the axis.

Values NOT HOLD : Normal

HOLD : Constantly holds the axis.



CAUTION

Be sure to record the data specified for the above items after the robot installation.

18.4 ADJUST

The items in this group are used to set the values of the robot main unit.

18.4.1 AR TYPE ADJUST

- (1) 「INITIAL A」
- (2) 「INITIAL B」
- (3) 「INITIAL Z」
- (4) 「INITIAL W」
- (5) 「INITIAL R」
- (6) 「INITIAL C」

- Number of entry digits : 7
- Valid range : -7999.999 to 7999.999
- Minimum unit : ± 0.001

Specifies the initial value of the robot. Normally, the position where A-CAL is performed is specified as the origin. When you wish to move the origin from the originally given position to another position, specify a value necessary for correction

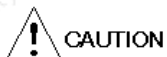

CAUTION

Be sure to record the data specified for the above items after the robot installation.

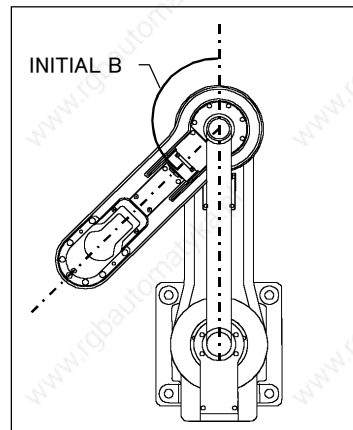

Fig. 18.3 INITIAL A

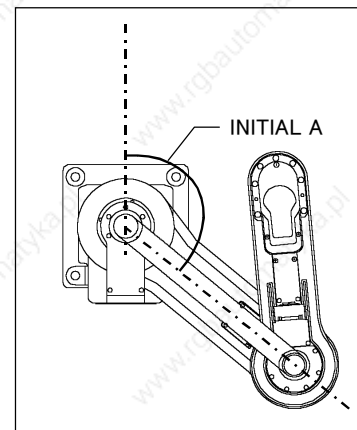

Fig. 18.4 INITIAL B

(7) 「LENGTH A」

(8) 「LENGTH B」

(9) 「LENGTH Z」

(10) 「LENGTH W」

(11) 「LENGTH R」

(12) 「LENGTH C」

- Number of entry digits : 7
- Valid range : 0 to 9999.999
- Minimum unit : 0.001

Specifies the arm length for each axis. Used for SCARA (horizontal multi-articulated) robot only. The SCARA robot converts quantities of rotation (in pulse) for A and B-Axes into quantities on X-Y coordinates, determining the position on the coordinates based on the arm lengths from the base point to the tip. Therefore, if the set values of initial data and the arm lengths are not correct, accuracy of the arm positioning in linear motions (arm operation in TEACH mode and CPC operation in automatic operation) becomes lower.

The length of the first arm is constant for the model, but the length of the second arm varies depending on the design of the tool used at the tip. Special attention should be paid to the data to be set for the above.

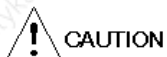

CAUTION

Be sure to record the data specified for the above items after the robot installation.

(13) 「AXIS COMBINATION」

Not in use.

18.4.2 MB TYPE ADJUST

Currently not supported.

18.5 CAPABILITY

Use this group when checking the specifications of the robot main unit or memory data intrinsic to the robot.

18.5.1 ROBOT CAPABILITY

Displays the individual settings for the encoders. You cannot change the data here.

- (1) 「ENC. PULSE A」: Encoder pulse for A-Axis (X-Axis)
- (2) 「ENC. PULSE B」: Encoder pulse for B-Axis (Y-Axis)
- (3) 「ENC. PULSE Z」: Encoder pulse for Z-Axis
- (4) 「ENC. PULSE W」: Encoder pulse for W-Axis
- (5) 「ENC. PULSE R」: Encoder pulse for R-Axis
- (6) 「ENC. PULSE C」: Encoder pulse for C-Axis
 - Number of entry digits : 7
 - Minimum unit : 1

Displays the encoder pulse set for each axis.

- (7) 「LEAD/GEAR A」: Lead/gear setting for A-Axis (X-Axis)
- (8) 「LEAD/GEAR B」: Lead/gear setting for B-Axis (Y-Axis)
- (9) 「LEAD/GEAR Z」: Lead/gear setting for Z-Axis
- (10) 「LEAD/GEAR W」: Lead/gear setting for W-Axis
- (11) 「LEAD/GEAR R」: Lead/gear setting for R-Axis
- (12) 「LEAD/GEAR C」: Lead/gear setting for C-Axis
 - Number of entry digits : 6
 - Minimum unit : 0.001

Displays the lead or gear ratio set for each axis.

- (13) 「MOTER REV. A」: Maximum motor revolution speed for A-Axis (X-Axis)
- (14) 「MOTER REV. B」: Maximum motor revolution speed for B-Axis (Y-Axis)
- (15) 「MOTER REV. Z」: Maximum motor revolution speed for Z-Axis
- (16) 「MOTER REV. W」: Maximum motor revolution speed for W-Axis
- (17) 「MOTER REV. R」: Maximum motor revolution speed for R-Axis
- (18) 「MOTER REV. C」: Maximum motor revolution speed for C-Axis
 - Number of entry digits : 4
 - Minimum unit : 1

Displays the maximum motor revolution speed set for each axis.

18.5.2 EXPANSION A

The following data are system data for expansion to be specified when applicable data items are added. Therefore, specify "0" for the following items unless our company requests otherwise.

(1) 「EXPANSION 0」

(2) 「EXPANSION 1」

(3) 「EXPANSION 2」

(4) 「EXPANSION 3」

(5) 「EXPANSION 4」

(6) 「EXPANSION 5」

(7) 「EXPANSION 6」

(8) 「EXPANSION 7」

Not used.

(9) 「CPC INTEG GAIN」

Not used.

(10) 「FV TIME 0」

(11) 「FV TIME 1」

(12) 「FV TIME 2」

Not used.

CHAPTER 19 Details of System Parameters

19.1 MOTION

The items in this group set conditions of robot operations and motions.

19.1.1 MOTION

(1) 「PULL-UP」

- Number of entry digits : 7
- Valid range : 5 up to the value of the maximum working area of Z-Axis
- Minimum unit : 0.001
- Standard value : 10

With 「PULL-UP」 setting, Z-Axis is automatically moved in PTP operation.

In PTP operation, when moving from a point to another, both of which are at a lower level than the setting of 「PULL-UP」, the robot will not move horizontally at that level. The robot automatically raises the Z-Axis to the set value (automatic pull-up), then moves horizontally, then lowers the Z-Axis for positioning. This item specifies the distance from the Z-Axis origin to the level at the point where horizontal move is started. The value is specified in “mm.”

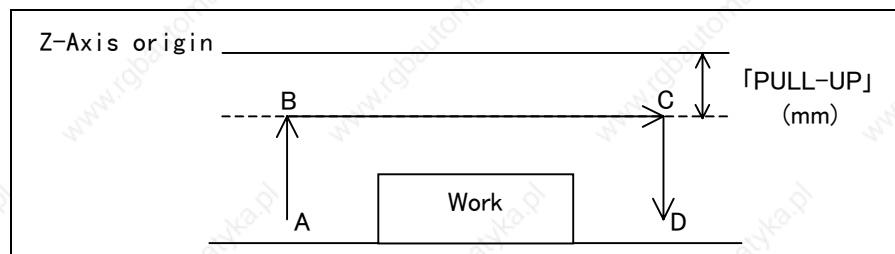

Fig. 19.1 PULL-UP Motion

For example, in the figure above, if the robot moves horizontally from point A to point D, it will interfere with the work. When a 「PULL-UP」 value is set so that the Z-Axis reaches to point B (level B), the robot starts horizontal move from that level via point C to point D for positioning. However, when moving between two points which are exactly on the same position on X-Y coordinates but different in height on Z coordinate, the PULL-UP motion is not performed.

Specify a value for 「PULL-UP」 according to the robot used so that the ORIGIN (ORG) sensor does not turn ON due to the setting during the PULL-UP motion.

(2) 「ARCH UP」

- Number of entry digits : 7
- Valid range : 0 up to the value of the maximum working area of Z-Axis
- Minimum unit : 0.001
- Standard value : 0

In PTP operation, the robot starts horizontal shift after the Z-Axis is raised, and lowers Z-Axis after the horizontal shift is finished. When automatic PULL-UP is activated, this gate motion is executed to avoid interference of work with the robot moving horizontally.

「ARCH UP」 allows the robot to move horizontally while the Z-Axis is rising, under a 「PULL-UP」 setting. Because of this, the tact time for the ARCH-UP motion is shorter than for the regular PULL-UP (gate) motion above. However, if an incorrect value is set, the robot may interfere with the work. Therefore, use care to set a correct value.

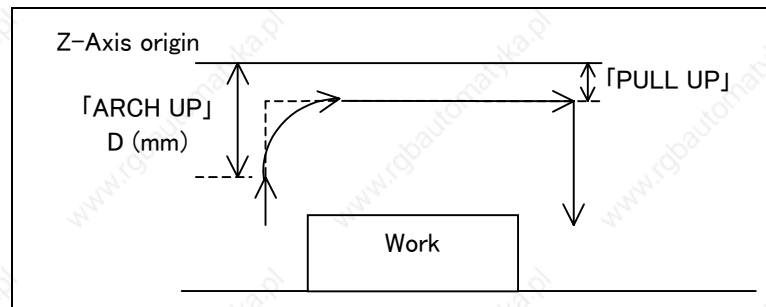

Fig. 19.2 ARCH UP

A value specified for 「ARCH UP」 is a distance from the Z-Axis origin. When setting for ARCH UP motion, check and confirm the difference between the value set for 「ARCH UP」 and that for 「PULL-UP」. Specifically, confirm that by what mm the ARCH UP level should be lower than the PULL-UP level. For example, as illustrated above, specify a value D (mm) that allows Z-Axis to start horizontal shift without interference with the work.

(3) 「ARCH DOWN」

- Number of entry digits : 7
- Valid range : 0 up to the value of the maximum working area of Z-Axis
- Minimum unit : 0.001
- Standard value : 0

In PTP operation, the robot starts horizontal shift after the Z-Axis is raised, and lowers Z-Axis after the horizontal shift is finished. When automatic PULL-UP is activated, this gate motion is executed to avoid interference of work with the robot moving horizontally.

「ARCH DOWN」 allows the robot to lower the Z-Axis while moving horizontally, under a 「PULL-UP」 setting. Because of this, the tact time for the arch down motion is shorter than for the regular PULL-UP (gate) motion above. However, if an incorrect value is set, the robot may interfere with the work. Therefore, use care to set a correct value.

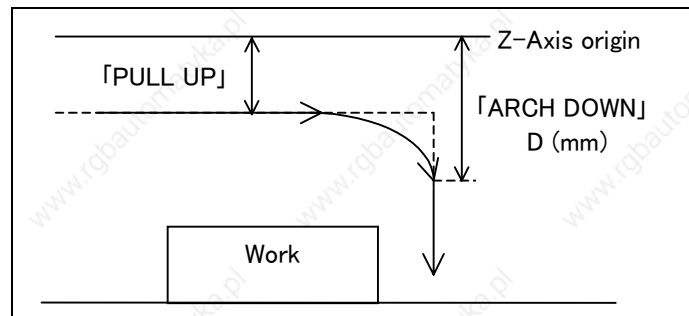

Fig. 19.3 ARCH DOWN

A value specified for 「ARCH DOWN」 is a distance from the Z-Axis origin. When setting for ARCH DOWN motion, confirm the difference between the value set for 「ARCH DOWN」 and that for 「PULL-UP」. Specifically, confirm that by what mm the ARCH DOWN level is lower than the PULL-UP level. For example, as illustrated above, specify a value D (mm) that allows Z-Axis to start lowering while horizontal move without interference with the work.

(4) 「INS DIS.」

- Number of entry digits : 7
- Valid range : 0 up to the value of the maximum working area of Z-Axis
- Minimum unit : 0.001
- Standard value : 20

Sets the distance for which the PTP insertion motion is performed. The robot starts deceleration at the level (value) which is obtained by taking the set value from the level (value) of the target point to which the Z-Axis lowers.

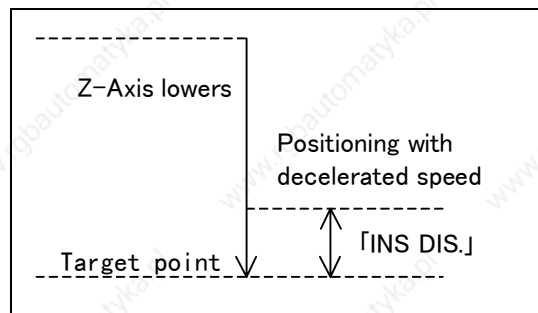

Fig. 19.4 INS DIS.

(5) 「INS SPEED」 (Inserting speed)

- Number of entry digits : 3
- Valid range : 0 to 99
- Minimum unit : 1
- Standard value : 20

Sets inserting speed for PTP insertion motion. The maximum speed of each axis varies depending on the robot type. The maximum speed is scaled into 100 levels (0: minimum speed-99: maximum speed). The inserting speed can be specified by selecting a value (0-99) which functions as a ratio to the maximum speed.

The robot moves the distance specified in (4) above at a decelerated speed. The area S2 represents the distance where the insertion motion 「INS DIS.」 takes place.

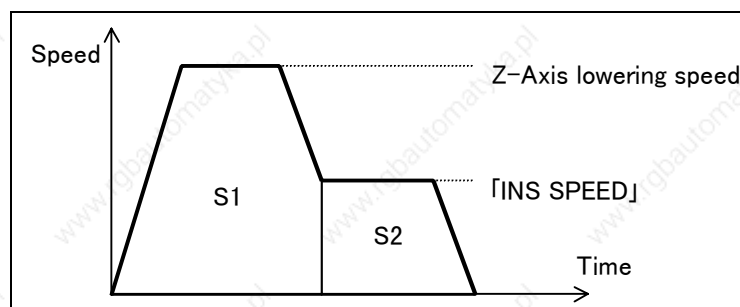
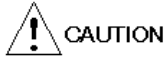

Fig. 19.5 INS SPEED



CAUTION

When the speed of Z-Axis immediately before moving into the distance set for 「INS DIS.」 is set lower than the 「INS SPEED」, the lower speed will control. For example, if Z-Axis is lowering at 50 and the speed set for 「INS SPEED」 is 100, the axis does not change speed to that as represented in dotted line in the diagram below, but moves as illustrated in straight line. The area S2 represents the distance 「INS DIS.」 where the insertion motion takes place.

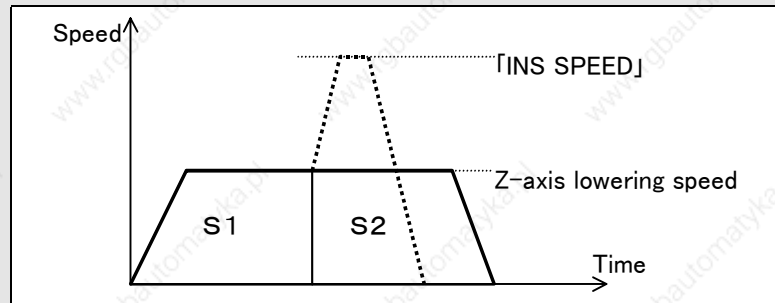

Fig. 19.6 Notes for 「INS SPEED」 Setting Value

(6) 「UP DIS.」 (distance of moving up)

- Number of entry digits : 7
- Valid range : 0 up to the value of the maximum working area of Z-Axis
- Minimum unit : 0.001
- Standard value : 20

Sets the distance for which the PTP slow-up motion is performed.

The distance where the Z-Axis moves at a slower speed is specified when Z-Axis starts moving up.

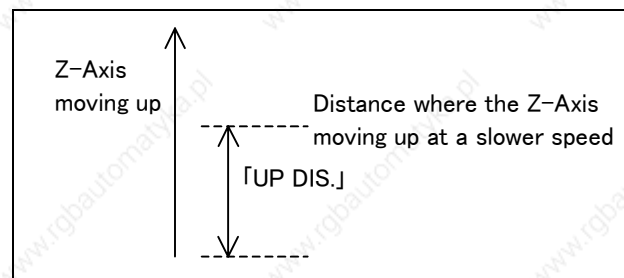

Fig. 19.7 UP DIS.

(7) 「UP SPEED」

- Number of entry digits : 3
- Valid range : 0 to 99
- Minimum unit : 1
- Standard value : 20

Sets the speed of moving-up for PTP slow-up motion.

The robot moves the distance specified in (6) 「UP DIS.」 above at a speed specified in this step. The area S1 represents the distance of moving up, 「UP DIS.」, where the slow-up motion takes place.

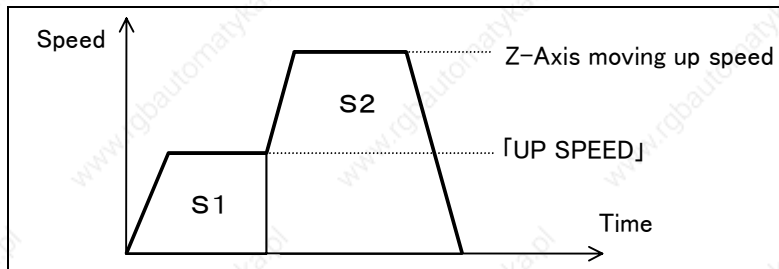

Fig. 19.8 UP SPEED

! NOTE

When the speed of Z-Axis immediately after moving out of the distance set for 「UP DIS.」 is set lower than the 「UP SPEED」, the lower speed will control. For example, if Z-Axis is moving up at 50 and the speed set for 「UP SPEED」 is 100, the axis does not change speed to that as illustrated in dotted line in the diagram below, but moves as shown in straight line. The area S1 represents the distance 「UP DIS.」 where the slow-up motion takes place.

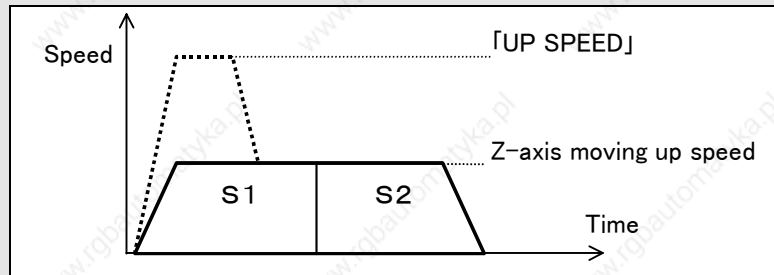

Fig. 19.9 Notes for 「UP SPEED」 Setting Value

(8) 「Z NEXT PULL」

Currently not used.

19. 1. 2 AXIS SPEED

- (1) 「SPEED A, B (X, Y) W」 (Speed of axes, A, B (X, Y) W)
- (2) 「SPEED Z」 (Speed of Z-Axis)

- Number of entry digits : 3
- Valid range : 0 to 100
- Minimum unit : 1
- Standard value : 100

For automatic operation, specify the operating speed of each axis except for that in CPC operation.

The maximum speed of each axis differs depending on the robot type. The maximum speed is scaled into 100 levels (0: Minimum speed to 100: Maximum speed). The speed can be specified by selecting a value (0-100) which functions as a ratio to the maximum speed. The value specified in this step sets the speed of every positioning.

The speed in CPC operation should be specified for 「CPC SPEED」 described in the following section.

- (3) 「SPEED B」 (B-Axis speed for expansion)
- (4) 「SPEED W」 (W-Axis speed for expansion)
- (5) 「EXPANSION 2」 (R-Axis speed for expansion)
- (6) 「EXPANSION 1」 (C-Axis speed for expansion)

- Number of entry digits : 3
- Valid range : 0 to 100
- Minimum unit : 1
- Standard value : 100

Use the above items to specify a speed for each of the axes as expanded functions. In this case, 「SPEED A, B (X, Y), W」 functions as the setting for the speed of A-Axis (X-Axis). For automatic operation, specify the operating speed of each axis except for that in CPC operation. The maximum speed of each axis differs depending on the robot type. The maximum speed is scaled into 100 levels (0: Minimum speed to 100: Maximum speed). The speed can be specified by selecting a value (0-100) which functions as a ratio to the maximum speed.

19. 1. 3 CPC CONSTANT

(1) 「CPC SPEED」

- Number of entry digits : 3
- Valid range : 0 to 999
- Minimum unit : 1
- Standard value : 100

Sets speed for interpolation (CPC operation). The scale unit for this item is 1 mm/sec.

The tip speed depends on the setting of 「CPC SPEED」 and the F-code specified for the start of the CPC operation.

$$\text{Tip speed (mm/sec)} = \text{「CPC SPEED」} \times \frac{1 + \text{F-code}}{100} \text{ (mm/sec)}$$

The maximum speed differs depending on the robot type. Even if a value greater than the maximum speed specific to the robot is set, the robot will operate at its rated maximum speed.

(2) 「CPC F.F. GAIN」

Currently not used.

(3) 「SPLINE SPEED」

Currently not used.

(4) 「CPC CONSTANT」

- Number of entry digits : 3
- Valid range : 0 to 100
- Minimum unit : 1
- Standard value : 0

Sets the smoothness at the passing point in continuous CPC operation. The setting range is between 0-100%. The curve is most smooth with the setting 0, and the most steep with the setting 100.

(5) 「CPC ACCEL/DECEL」 (CPC acceleration/deceleration)

- Number of entry digits : 3
- Valid range : 0 to 100
- Minimum unit : 1
- Standard value : 80

Sets the acceleration/deceleration of the speed during CPC operation.

19.2 RESPONSE

19.2.1 ACCEL

The accelerating/decelerating time is determined by the robot type, and set by configuration. (Refer to 20.4, Assigning Motors to Robot Axes.) The accelerating/decelerating time set in the configuration is treated as the minimum time required. Items in this group set the ratio of (number of times of) such time required to complete the acceleration/deceleration.

(1) 「ACCEL SELECT」

- Standard value : AUTO

Currently the above value is not used. The setting is constantly MANUAL.

Selects either to set acceleration/deceleration with the settings of the following (2)「ACCEL A」 to (7)「ACCEL C」, or to set the optimized acceleration/deceleration using the weight of work in addition to the settings of (2) to (7). (selecting a character-form value)

AUTO : Automatically creates to set an accelerating/decelerating time.

Optimizes the acceleration/deceleration by using the values of (2)「ACCEL A」 to (7)「ACCEL C」 and the setting of 「PTP WEIGHT」 reached by selecting 「RESPONSE」→「RESPONSE」 in System Parameter menu. Allows smooth acceleration/deceleration for carrying heavy works.

MANUAL : Requires specifying values for (2)「ACCEL A」 to (7)「ACCEL C」.

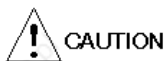

CAUTION

AUTO is quite effective for SCARA (horizontal multi-articulated) robots. However, for Cartesian robots, acceleration varies due to the simplified calculation value of 「PTP WEIGHT」. Therefore, to obtain a shorter tact time, change values for the following items of acceleration data with the 「PTP WEIGHT」 set to 0.

- (2) 「ACCEL A」
 - (3) 「ACCEL B」
 - (4) 「ACCEL Z」
 - (5) 「ACCEL W」
 - (6) 「ACCEL R」
 - (7) 「ACCEL C」
- Number of entry digits : 3
 - Valid range : 0 to 100
 - Minimum unit : 1
 - Standard value : 80

Each of the above is to slow-down acceleration/deceleration of the axis. In standard condition, always set between 70-100. The smaller the value becomes, the more gradual the acceleration becomes.

Table 19.1 Set Value and Acceleration/Deceleration Time (Minimum Time:1)

「ACCEL」 value	Acceleration/Deceleration time
100	1
90	10/9
80	10/8
70	10/7
60	10/6
50	10/5
40	10/4
30	10/3
20	10/2
10	10/1

The optimum values of 「ACCEL」 for various robot with working load are given below.

Table 19.2 Optimum ACCEL Value and Working load

「ACCEL」 value	AR-C270	AR-C350	MB
80	With 2kg working load	With 2kg working load	With standard working load
70			
60		With 4kg working load	

19.2.2 AXIS INP PULSE

This group is not used. In the past, the group was used to specify positioning accuracy, which now is specified by servo parameters. Refer to 12.5, "Setting Servo Parameters (SERVO)," and the user's guide of the controlled units used.

- (1) 「INP PULSE A, B」
- (2) 「PULSE B」
- (3) 「INP PULSE Z」
- (4) 「INP PULSE W」
- (5) 「EXPANSION 2」
- (6) 「EXPANSION 1」

19.2.3 RESPONSE

- (1) 「SAFE. ZONE」

- Number of entry digits : 7
- Valid range : 0 up to the value of the maximum working area of Z-Axis
- Minimum unit : 0.001
- Standard value : 10

Outputs to turn ON OUT5 when Z-Axis moves up to a higher level than the setting of this item (when the level value becomes smaller than the setting). Used for determining robot refuge. The unit is mm (millimeter).

The conditions of the output (OUT5) are:

- ① AUTO is selected for 「AUTO/ON-LINE」 reached by selecting 「ORIGIN」→「SET-UP SYSTEM」 in System Generation menu, OUT5 is output either in TEACH, CHECK, or AUTO mode.
- ② When ON-LINE is selected for 「AUTO/ON-LINE」 reached by selecting 「ORIGIN」→「SET-UP SYSTEM」 in System Generation menu, and only when 1 is set for 「I/O ASSIGNMENT」 reached by selecting 「ORIGIN」→「SET-UP SYSTEM」 in System Generation menu, OUT5 is automatically output.

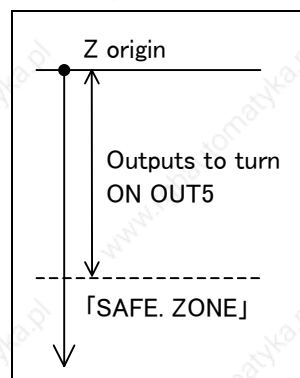
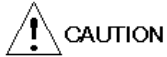

Fig. 19.10 SAFE.ZONE



CAUTION

- The setting becomes invalid when A-CAL has not been completed. With A-CAL incomplete, output of OUT5 is always OFF.
- In KEY-IN mode, OUT5 will not change.
- When PULL-UP function of Z-Axis is used, specify for 「SAFE. ZONE」 a value greater than the setting of 「PULL-UP」¹. If the same value as 「PULL-UP」 is set for 「SAFE. ZONE」, output of OUT5 may keep switching ON and OFF or may not turn ON.

(2) 「A-CAL SPEED」

- Number of entry digits : 3
- Valid range : 1 to 999
- Minimum unit : 1
- Standard value : 50

Sets speed during A-CAL.

The maximum speed of each axis varies depending on the robot type. The maximum speed is scaled into 1000 levels (0.1% to 99.9 %), and the speed can be set between the above range. However, for ensuring safety, the robot will not operate at 250mm/sec or greater.

(3) 「INCHING SPEED」

- Number of entry digits : 3
- Valid range : 1 to 999
- Minimum unit : 1
- Standard value : 2

Sets inching speed.

The maximum speed of each axis varies depending on the robot type. The maximum speed is scaled into 1000 levels (0.1% to 99.9 %), and the speed can be set between the above range. However, for ensuring safety, the robot will not operate at 250mm/sec or greater.

(4) 「PTP WEIGHT」

- Number of entry digits : 7
- Valid range : 0 up to the value of the maximum transportation weight
- Minimum unit : 0.001
- Standard value : 2

Specifies the total weight of tip tool and a work (kg). By using this value, the system automatically optimizes the acceleration/deceleration during PTP operation and pass PTP operation. The optimization is constantly carried out during pass PTP operation. For PTP operation, acceleration/deceleration is optimized when AUTO is set for 「ACCEL SELECT」 reached by selecting 「RESPONSE」→「ACCEL」 in System Generation menu.

¹: Specified by the System Parameter, 「MOTION」→「MOTION」→「PULL-UP」.

- (5) 「EXPANSION 1」
Not used.
- (6) 「COMPLAINCE」
Not used.
- (7) 「DD INDEX GAIN」
Not used.
- (8) 「PTP CONST AB」
Not used.
- (9) 「PTP CONST Z」
Not used.
- (10) 「PTP CONST W」
Not used.

19.3 OFFSET

「DISPLAY OFFSET」 specifies the origin of each coordinate for the purpose of displaying. Since each 「DISPLAY OFFSET*」, reached by selecting 「OFFSET」 in System Parameter menu, is an offset used for display only, the actual robot position will not be changed even when offset values are changed.

By using offset settings, you can:

- Establishes a relationship between the robot and the work based on the coordinate and make position data entry easier in KEY-IN mode.
- Moves the robot parallel with the coordinate concerned in LI-TEACH mode to make teaching easier.
- Sets for 「AREA LIMIT」¹ easily by specifying a coordinate system.

Three kinds of coordinate systems are available. (Refer to 2.7, “LCD (Liquid Crystal Display.”)

“To display offset” means to switch the display of the robot-specific world coordinate system to that of the coordinate system of work (transferred data). The world coordinate system is converted into the work coordinate system in the following way:

The origin of the world coordinate system is moved by (Δx , Δy) on the X-Y plane, and the position becomes the origin of the work coordinate system, as illustrated below. And then, the coordinate system is rotated by ΔR around the origin. As for the Z and W-Axes, the coordinate origin is located where Δz is subtracted, and where the coordinate is rotated in the opposite direction by Δw respectively.

¹: 「LIMIT」→「AREA LIMIT」 in System Generation menu.

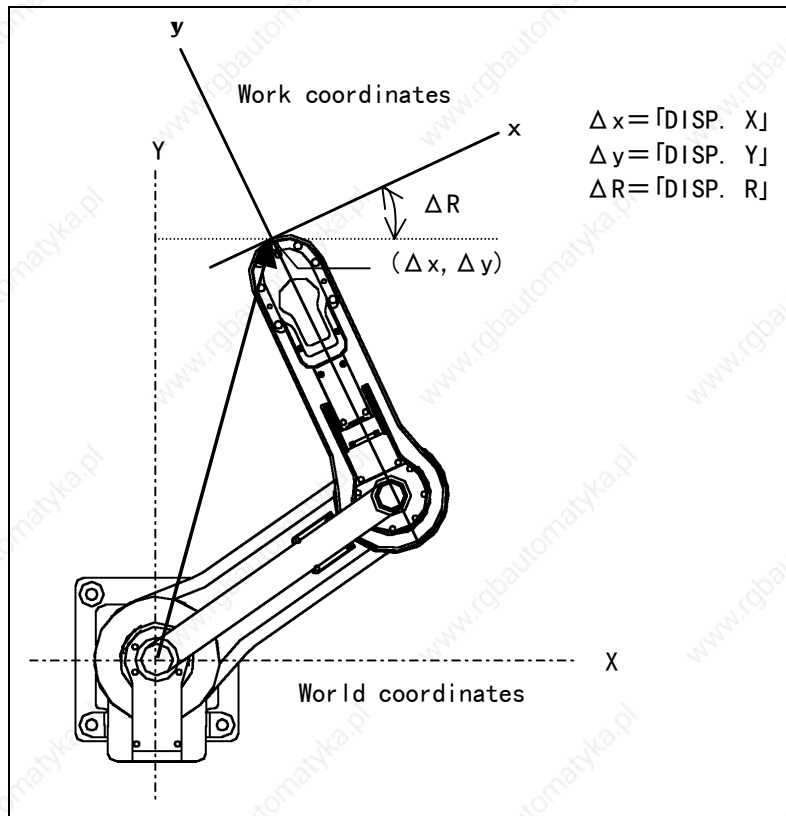

Fig. 19.11 「OFFSET」

- (1) 「DISP. X1」 (Display X1)
- (2) 「DISP. Y1」 (Display Y1)
- (3) 「DISP. R1」 (Display R1)
- (4) 「DISP. X2」 (Display X2)
- (5) 「DISP. Y2」 (Display Y2)
- (6) 「DISP. R2」 (Display R2)
- (7) 「DISP. X3」 (Display X3)
- (8) 「DISP. Y3」 (Display Y3)
- (9) 「DISP. R3」 (Display R3)

- Number of entry digits : 7
- Valid range : X-Axis: -7999.999 to 7999.999
Y-Axis: -7999.999 to 7999.999
R-Axis: -180.000 to 180.000
- Minimum unit : ± 0.001
- Standard setting : 0

Sets the origin of the X-Y coordinates to be displayed.

「DISP. X*」 is for offsetting X-Axis for display and 「DISP. Y*」 is for offsetting Y-Axis for display, each specified in “mm,” while “DISP. R*” is for offsetting by rotating the coordinate for display specified in degree (angle).

Since each 「DISPLAY OFFSET」 is an offset used for display only, the actual robot position will not be changed even when offset values are changed. Specify values in the following example for 「DISPLAY OFFSET 1」:

- ① Enter 0 for 「DISP. X1」, 「DISP. Y1」 and 「DISP. R1」 respectively.
- ② After A-CAL is completed, move the robot in TEACH mode to the position which will be the origin of the new X-Y coordinate to be displayed.
- ③ Read off the X and Y values of the position. Enter the values for 「DISP. X1」 and 「DISP. Y1」 respectively.
- ④ When you wish to rotate the X-Y coordinate, calculate the value to be set for 「DISP. R1」 by using the two positions (X1, Y1) and (X2, Y2) on the line which will become the new X-coordinate.

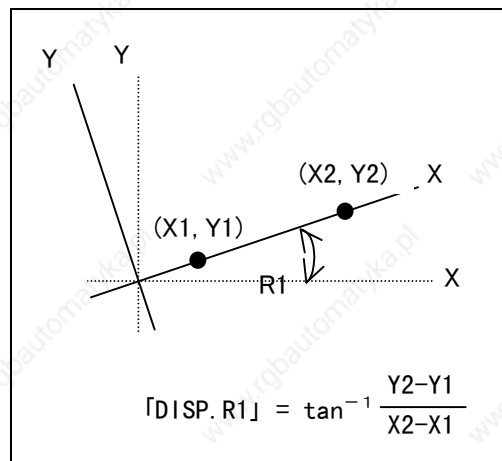

Fig. 19.12 Calculating 「DISP. R1」

(10) 「DISP. Z1」 (Display Z1)

(11) 「DISP. Z2」 (Display Z2)

(12) 「DISP. Z3」 (Display Z3)

- Number of entry digits : 7
- Valid range : Z-Axis -7999.999 to 7999.999
- Minimum unit : ±0.001
- Standard setting : 0

Sets the origin of the Z coordinate to be displayed.

「DISP. Z*」 is for offsetting Z-Axis for display, specified in “mm.” Since each 「DISPLAY OFFSET」 is an offset used for display purpose only, the actual robot position will not be changed even when offset values are changed.

(13) 「DISP. W1」 (Display W1)

(14) 「DISP. W2」 (Display W2)

(15) 「DISP. W3」 (Display W3)

- Number of entry digits : 7
- Valid range : W-Axis -540.000 to 540.000
- Minimum unit : ± 0.001
- Standard setting : 0

Offset value of W-Axis from X-Y coordinate.

A value for W-Axis is an angle displayed based on the X-Y coordinates. After an X-Y coordinate system is specified by display offsetting, the operating direction of the W-Axis and the display will be constant on the X-Y coordinate system.

「DISP. W*」 is for setting the origin on W-Axis for the setting coordinate. Since each 「DISPLAY OFFSET」 is an offset used for display purpose only, the actual robot position will not be changed even when offset values are changed.

Specify values in the following example for 「DISPLAY OFFSET 1」:

- ① Enter system data for 「DISP. X1」, 「DISP. Y1」 and 「DISP. R1」 respectively to specify the X-Y coordinate system.
- ② Enter 0 for 「DISP. W1」.
- ③ After A-CAL is completed, rotate the robot in TEACH mode to the position where the origin of the new coordinate will be set.
- ④ Read off the W1 value of the position. Enter the value for 「DISP. W1」.

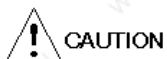

CAUTION

Since 「DISP. W1」 is an offset value for the display purpose only, the mechanical working area will not be changed. Because of this, if the work coordinate system is newly changed, entering data of W-Axis may not be accepted even though the values are identical with those of the former coordinate system, "AREA ERROR" being caused.

(16) 「TOOL X1」

(17) 「TOOL Y1」

(18) 「TOOL Z1」

(19) 「TOOL X2」

(20) 「TOOL Y2」

(21) 「TOOL Z2」

(22) 「TOOL X3」

(23) 「TOOL Y3」

(24) 「TOOL Z3」

Currently not supported.

Specify data to switch display referenced with a coordinate system with the origin at the tool's working center.

Three types are available, allowing three different displays for the three tools. These items are used in combination with the 「DISP. * *」 items described before.

19.4 SET-UP

「SET-UP」 contains data areas for expansion. There are two groups, 「EXPANSION A」 and 「EXPANSION B」.

19.4.1 EXPANSION A

Used for expansion.

(1) 「Pass PTP Select」

Currently not supported.

Switches from pass PTP operation, in which the robot does not stop at the passing position, to continuous pass PTP operation, in which regular PTP operation is continued without communication with external units when M-data values in the thirties (30-39) are used.

Values 0 : Specifies pass PTP operation where robot does not stop at the passing position.
1 : Enables continuous PTP operation without communication with external devices. Stops the robot temporarily at the passing position.

(2) 「Base Pos Addr1」 (Base Position Address 1)

(3) 「Base Pos Addr2」 (Base Position Address 2)

(4) 「Base Pos Addr3」 (Base Position Address 3)

(5) 「Base Pos Addr4」 (Base Position Address 4)

- Number of entry digits : 3
- Valid range : 0 to the value specified for 「ADDRESS MAX」ⁱ
- Minimum unit : 1
- Standard setting : 0

Specifies the address for the reference base position of the robot (Robot origin).

ⁱ: 「LIMIT」→「ADDRESS MAX」→「ADDRESS MAX」 in System Generation menu.

With 「I/O ASSIGNMENT」 set to 4, by selecting 「ORIGIN」→「SET-UP SYSTEM」→「I/O ASSIGNMENT」 in System Generation menu, and when the robot is positioned at one of the addresses specified for the items above, OUT4 is output. You can specify four points. OUT4 turns ON when the robot positions at one of the four points specified.

By using this output, interlock system can be established to give permission of start to the externally controlled units. To give some allowance in stopping position, set a value for the next item 「Base Pos Pulse」.

(6) 「Base Pos Pulse」 (Base Position Pulse)

- Number of entry digits : 5
- Valid range : 0 to 99999
- Minimum unit : 1
- Standard setting : 0

Specifies the allowable variation range(\pm number of pulses), where OUT4 turns ON, for the address specified for 「Base Pos Addr」 above. Specify a value that is a number of pulses.

(7) 「Safety select」

Specifies reference base position for 「ARCH UP」ⁱ and 「SAFE. ZONE」ⁱⁱ settings. Currently the setting for this item is fixed to 0.

- Values 0 : Specifies the origin of Z-Axis as the reference position, validating absolute values of 「ARCH UP」 and 「SAFE. ZONE」.
- 1 : Specifies the position currently located as the reference, turning OUT5 signal (ZONE output) ON when Z-Axis rises by a value specified for 「SAFE. ZONE」.
- 2 : Specifies the position currently located as the reference, starting to move A and B-Axes (X and Y-Axes) when Z-Axis rises by a value specified for 「ARCH UP」.

19. 4. 2 EXPANSION B

(1) 「SENS. OFF」 (Sensor Offset)

Currently not supported. Specifies an offset upon stop of W-Axis sensor.

(2) 「SENS. SKIP」 (Sensor Skip)

Currently not supported. Specifies an area where W-Axis sensor is ignored upon stop of W-Axis sensor.

ⁱ : 「MOTION」→「MOTION」→「ARCH UP」 in System Parameter menu

ⁱⁱ : 「RESPONSE」→「RESPONSE」→「SAFE. ZONE」 in System Parameter menu

② Cartesian robot

With each setting below, OUT4 is output when the tip is at a position in a shaded area.

Example 1: 「AREA AX」= 100 mm 「AREA BY」= 150 mm

Example 2: 「AREA AX」= -100 mm 「AREA BY」= 150 mm

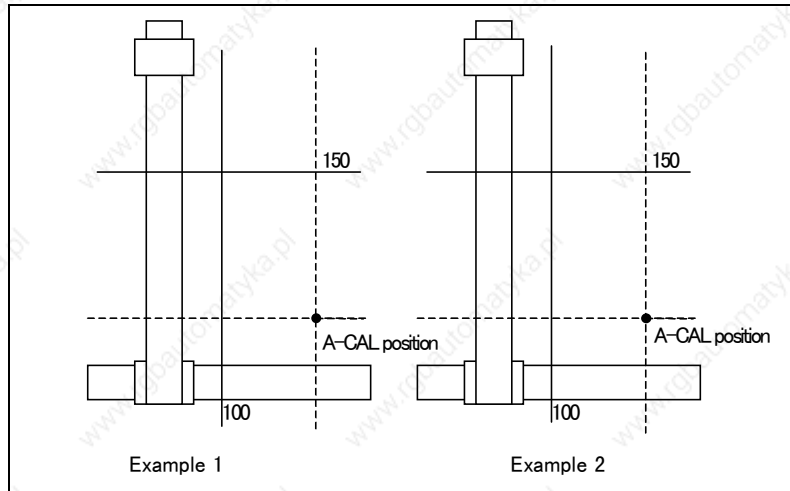
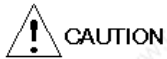

Fig. 19.14 Valid Areas of Cartesian Robot



- The output is OFF when A-CAL is Incompleted.
- This function is valid in any mode other than KEY-IN and ON-LINE modes.
- The output turns ON when both Area Outputs A(X) and B(Y) are satisfied.

(5) 「Z MD OF.」 (Z Middle Offset)

Currently not supported. When S-code setting is either 24 or 25, the Z-Axis is relatively positioned with the value specified here.

(6) 「Z2 PL-UP」

Currently not supported. This item is for the second Z-Axis when the robot uses two Z-Axes. Specifies a value for 「PULL-UP」¹ for the second Z-Axis.

(7) 「EXPANSION 14」

Currently not supported.

¹: 「MOTION」→「MOTION」→「PULL-UP」 in System Parameter menu

19.5 REMOTE

The groups in REMOTE display data set by S command (SAVE) of the HRCS-RIVⁱ. You cannot enter data for items in these groups.

Data that can be displayed are those in 「MOTION」 and 「RESPONSE」 groups. For details, refer to each group.

19.5.1 MOTION

- (1) 「PULL-UP」
- (2) 「ARCH UP」
- (3) 「ARCH DOWN」
- (4) 「INS DIS. 」
- (5) 「INS SPEED」
- (6) 「UP DIS. 」
- (7) 「UP SPEED」

19.5.2 SPEED/ACCEL/INPOS

- (1) 「SPEED A,B(X,Y)W」
- (2) 「SPEED B」
- (3) 「SPEED Z」
- (4) 「SPEED W」
- (5) 「EXPANSION 1」
- (6) 「EXPANSION 2」
- (7) 「ACCEL A,B(X,Y)W」
- (8) 「ACCEL ABW(PASS)」
- (9) 「ACCEL Z」
- (10) 「ACCEL Z(PASS)」
- (11) 「EXPANSION 3」
- (12) 「EXPANSION 4」
- (13) 「INP PULSE A,B」
- (14) 「INP PULSE B」
- (15) 「INP PULSE Z」
- (16) 「INP PULSE W」
- (17) 「EXPANSION 5」
- (18) 「EXPANSION 6」

ⁱ : HRCS-RIV: Communication protocol of our company. Used to control robot with RS-232C from the higher computer (PC, or the like). For details, refer to separate volume, "HRCS-RIV Operation Manual."

19.5.3 REMOTE MOTION

- (1) 「CPC SPEED」
- (2) 「CPC F.F.GAIN」
- (3) 「SPLINE SPEED」
- (4) 「A-CAL SPEED」
- (5) 「INCHING SPEED」
- (6) 「EXPANSION 1」
- (7) 「PTP WEIGHT」
- (8) 「EXPANSION 2」
- (9) 「LOCAL COORDINATE」
- (10) 「W AXIS ACCEL」
- (11) 「W AXIS DECEL」
- (12) 「OPTION DATA 1」
- (13) 「OPTION DATA 2」
- (14) 「OPTION DATA 3」
- (15) 「EXPANSION 3」
- (16) 「EXPANSION 4」

CHAPTER 20 System Configuration

Controllers of HNC-580 series can control more than one robot. However, this requires work to configure the system to conform to the application (system configuration).

When the Teach Pendant shows the following display, the system area is destroyed. Pressing any key automatically starts the system configuration. In cases other than this, take the steps described below to start the system configuration.

System Area Destroy.

Push Any Key to
Start Configuration.

Fig. 20.1 Display Indicating System Area Destruction

With the system area destroyed, the controller may not be able to recognize the Teach Pendant. In such a case, you have to clear all the memories.

20.1 Memory All Clear

Set to ON the DIP switches 1-7 (in Fig. 20.2) in CPU board inside the controller, then turn ON the power. Without any operation, turn OFF the power after 10 seconds.

This process initializes all the memories inside the controller. You only have to perform this operation once when the CPU board is installed for the first time and without being energized. After this, no additional memory clearing will be necessary.

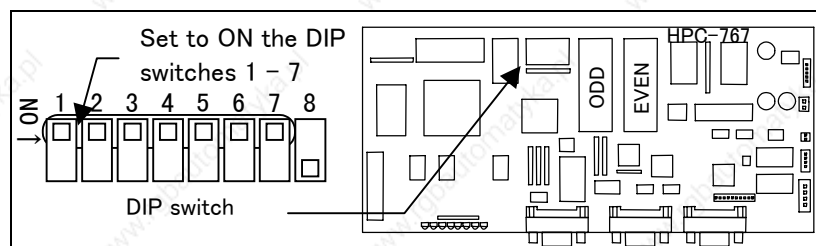
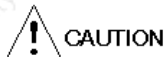

Fig. 20.2 Location of DIP Switch on CPU Board



Normally this operation is unnecessary. If you perform this, all the data stored will be cleared.

20.2 Starting Configuration

- (1) Set the DIP switch 1 (in Fig. 20.3) to OFF and turn ON the power. This brings the condition ready for configuring the system.

At this time, you cannot perform any regular operations at all. The only way to exit this condition is, to turn OFF the power, set the DIP switch 1 to ON and then to turn ON the power again.

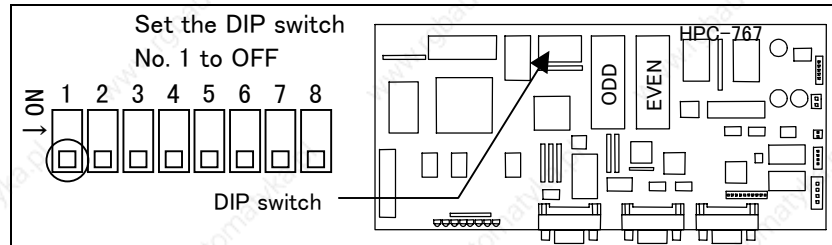
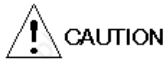

Fig. 20.3 Location of the DIP Switch of System Configuration



CAUTION

When system configuration is executed, system data and position data are cleared. System configuration should be done before setting-up the system.

- (2) Carry out the steps in 2.2, “Connecting the Teach Pendant to the Controller” to display the opening screen.



Fig. 20.4 Opening Screen

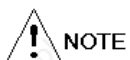

NOTE

Confirm that “*” is blinking at the left side bottom on the screen. If the “*” is not blinking, the controller will not recognize the following operations.



- (3) Press the  key on the Teach Pendant to illuminate 『SHIFT』 LED.



- (4) Press the  +  keys. The shaded portion of the illustration below appears. To display 「4. INITIALIZE」 on screen, press the  key to scroll.



Fig. 20.5 System Configuration

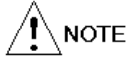

To set data, the following two ways are available:

「1. AUTO SETTING」 : Sets data when you select a robot type/model from the preset robot list given by the controller.

「2. MANUAL SETTING」: Allows you to set each value manually one by one from motor setting, when you use a robot type not listed in the preset list. Refer to “20.3 Registering motors for axes.”





「3. OPTION DATA」 is valid only when optional specifications are included. Normally do not use this item.

- (5) Press the  key 「1. AUTO SETTING」. The AUTO SETTING Example screen in Fig. 20.6 appears with the connectable robot types.

```
AUTO CONFIG SETTING
1. ROBOT 1  2. ROBOT 2
3. ROBOT 3  4. ROBOT 4
```

Fig. 20.6 Auto Setting Example



- (6) Select a desired robot. The numeric keys correspond to the robots as follows:

	key: ROBOT 1		key: ROBOT 2
	key: ROBOT 3		key: ROBOT 4

Below shows the case of selecting 「1. ROBOT 1」.

```
R/B 1 AUTO SETTING
TYPE
[GR-1800 2 (X, Y) ]
Enter = [END] Key
```

Fig. 20.7 Auto Setting for ROBOT 1

- (7) Press the  key. The message, “ENTER OK?” appears. Pressing the  key automatically sets the parameters preset for each robot type. You can select a type from the following:

- GR-1800 2 (X,Y)
- GR-1800 3 (X,Y,Z)
- GR-1800 4 (X,Y,Z,W)

20.3 Registering Motors for Axes

Register motors used for each axis by specifying in motor/driver configuration mode. Up to 16 motors can be registered. The items to be specified are listed in the table below.

Table 20.1 Motor Amplifier/Driver Configuration Setting Items

Item	Keys for Entry
	Description
MOTOR NO.	<div style="display: flex; align-items: center; gap: 10px;"> <div style="border: 1px solid black; padding: 2px;">dec INC</div> key: Up, <div style="border: 1px solid black; padding: 2px;">SHIFT</div> → <div style="border: 1px solid black; padding: 2px;">dec INC</div> key: Down </div> <p>Selects 01 up to 16. Each number represents the number of the servo amplifier/driver. (The servo amplifier/driver and the motor are paired.)</p>
MOTOR TYPE	<div style="border: 1px solid black; padding: 2px;">io SEL</div> key
MOTOR REV.	<p>Numeric keys: <div style="border: 1px solid black; padding: 2px;">*</div><div style="border: 1px solid black; padding: 2px;">0</div> up to <div style="border: 1px solid black; padding: 2px;">key</div><div style="border: 1px solid black; padding: 2px;">9</div> key</p> <p>Specifies the maximum operating speed of motor.</p>
ENCPULSE	<p>Numeric keys: <div style="border: 1px solid black; padding: 2px;">*</div><div style="border: 1px solid black; padding: 2px;">0</div> up to <div style="border: 1px solid black; padding: 2px;">key</div><div style="border: 1px solid black; padding: 2px;">9</div> key</p> <p>Specifies a number of pulses per motor revolution. Standard setting is 2048.</p>
LEAD	<p>Numeric keys: <div style="border: 1px solid black; padding: 2px;">*</div><div style="border: 1px solid black; padding: 2px;">0</div> up to <div style="border: 1px solid black; padding: 2px;">key</div><div style="border: 1px solid black; padding: 2px;">9</div> key</p> <p>Specifies a value of lead in "mm" per motor revolution for linear type, and specifies gear ratio for rotary type.</p>
OVERRUN	<div style="border: 1px solid black; padding: 2px;">io SEL</div> key
ORIGIN	<div style="border: 1px solid black; padding: 2px;">io SEL</div> key
AXIS TYPE	<div style="border: 1px solid black; padding: 2px;">io SEL</div> key
AXIS REV.	<div style="border: 1px solid black; padding: 2px;">io SEL</div> key
MOTOR CODE	<p>Numeric keys: <div style="border: 1px solid black; padding: 2px;">*</div><div style="border: 1px solid black; padding: 2px;">0</div> up to <div style="border: 1px solid black; padding: 2px;">key</div><div style="border: 1px solid black; padding: 2px;">9</div> key</p> <p>Specifies a motor code in decimal notation. (For codes, refer to A00EBDUX D, "Motor Code.")</p>
EXPAND 2	For expansion
EXPAND 1	For expansion



How to specify data and register motors manually are described below.

- (1) With the System Configuration screen displayed as in Fig.20.5, press the  key 「2. MANUAL SETTING」. The screen display changes as shown below.

```

MANUAL SETTING
1. MOTOR/DRIVER
2. ROBOT CONFIG
  
```







Fig. 20.8 Manual Setting

- (2) Press the  key 「1. MOTOR/DRIVER」. The shaded portion of the illustration below appears. To display 「ENC. PULSE」 and the following pages in sequence, press the  key to scroll the screen.

```

MOTOR/DRIVER CONFIG
MOTOR NO          01
MOTOR TYPE [ABS.  ]
MOTOR REV.        3600
ENC. PULSE        02048
LEAD              010.000
OVERRUN          [NOT USED]
ORIGIN           [NOT USED]
AXIS TYPE        [LINEAR ]
AXIS REV.        [NORMAL ]
MOTOR CODE       049
EXPAND 2         000
EXPAND 1         000
Enter = [END] Key
  
```

Fig. 20.9 Motor Driver Configuration

- (3) Specify a value for each item, referring to the Table 20.1, Motor Amplifier/Driver Configuration Setting Items.
- ① Enter a value for each item and press the  key. The message, “ENTER OK?” appears.
 - ② To set the value, press the  key again.
- (4) After setting for all the items, press the  key. The message, “SAVE CONFIG OK?” is displayed. When everything is OK, press the  key. If you do not wish to save the settings, press the  key to cancel this process.
- (5) When the setting is completed, “COMPLETED” appears. When entered data are incorrect, the data will not be set with an error message on display. Refer to Table 20.3, Configuration Error Message List
- (6) When the setting has been successfully completed, press the  key to go back to the Manual Setting screen, Fig.20.8.

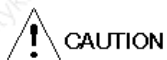



CAUTION

Be sure to press the  key after entering values for the items. Failing to do so will invalidate the values entered.

20.4 Assigning Motors to Robot Axes

In this section, motors registered in 20.3, “Registering Motors for Axes” are assigned to individual axes of the robot to be used in robot configuration mode. The items to set are given below.

Table 20.2 Robot Configuration Setting Items

Item	Keys for Entry		
	Description		
R/B TYPE	 key		
		Select the robot type. For any Cartesian robot, select [MB-ZWR]. ·AR ·AR-K ·AR-V ·MB ·MB-ZW ·MB-ZWR ·NOT USED	
A (X) AXIS NO.	Numeric keys	Enters the motor No. for A-Axis (X-Axis for Cartesian type). *)	
B (Y) AXIS NO.	Numeric keys	Enters the motor No. for B-Axis (Y-Axis for Cartesian type). *)	
Z AXIS NO.	Numeric keys	Enters the motor No. for Z-Axis. *)	
W AXIS NO.	Numeric keys	Enters the motor No. for W-Axis. *)	
R AXIS NO.	Numeric keys	Enters the motor No. for R-Axis. *)	
C AXIS NO.	Numeric keys	Enters the motor No. for C-Axis. *)	
ACCEL A	Used for calculation of 「ACCEL」 group, by selecting 「RESPONSE」→ 「ACCEL」 in System Parameter menu.	Numeric keys Enters accelerating/decelerating time for A-Axis.	
ACCEL B		Numeric keys Enters accelerating/decelerating time for B-Axis.	
ACCEL Z		Numeric keys Enters accelerating/decelerating time for Z-Axis.	
ACCEL W		Numeric keys Enters accelerating/decelerating time for W-Axis.	
ACCEL R		Numeric keys Enters accelerating/decelerating time for R-Axis.	
ACCEL C		Numeric keys	Enters accelerating/decelerating time for C-Axis.
I/O TYPE	 key		
		Select the I/O type for REMOTE I/O. ·CC Link ·OPTION1 ·OPTION2 ·OPTION3 ·HIRATA ·DeviceNet (CompoBus/D)	
REMOTE I/O ID	Numeric keys	Select the ID for using the REMOTE I/O product of HIRATA.	
MAX POSITION	Numeric keys	Enters the maximum number of position data by the 1000. (The maximum setting is 4000; 8000 for all the robots) When 1000 is set, the valid address range is from 0 to 999.	
SCALE FACTOR	 key		
		Select a robot's operation range type (stroke). · NORM: <10m · SHORT: <1m · LONG: >10m to <100m · SUPER: ≥100m	

*) Enter “00” for an axis not to be used.

How to specify data and assigning motors are described below.



- (1) With the Manual Setting screen displayed as in Fig. 20.8, press the  key 「2. ROBOT CONFIG」. The screen display changes as shown below.



Fig. 20.10 Selection of Robots on ROBOT CONFIGURATION Screen

- (2) Select a desired robot for which you are going to set values. The numeric keys correspond to the robots as follows:

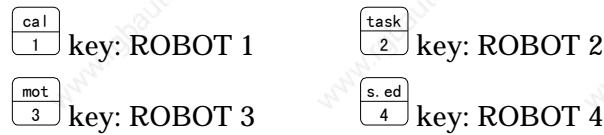

- (3) Press the  key 「1. ROBOT 1」. The shaded portion of the illustration below appears. To display 「Z AXIS NO.」 and the following screen in sequence, press the  to scroll the screen.

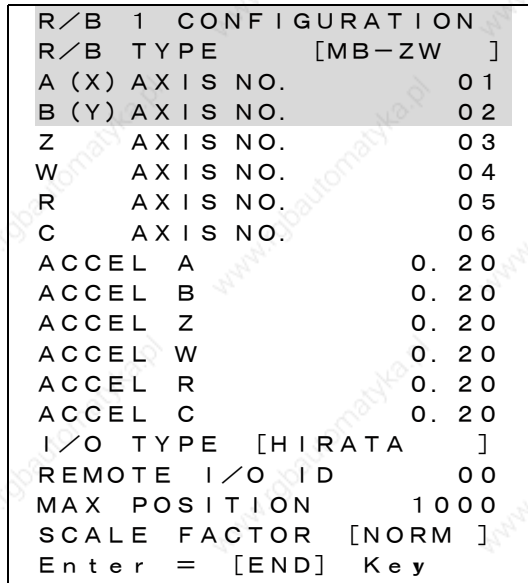







Fig. 20.11 Robot Configuration

- (4) Specify a value for each item, referring to the Table 20.2, Robot Configuration Setting Items.

- ① Enter a value for each item and press the  key. The message, "ENTER OK?" appears.
- ② To set the value, press the  key again.

- (5) After setting for all the items, press the  key. The message, "SAVE CONFIG OK?" is displayed. When everything is OK, press the  key. If you do not wish to save the settings, press the  key to cancel this process.
- (6) When the data setting is completed, "COMPLETED" appears. When entered data are, the data will not be set with an error message on display. Refer to Table 20.3, Configuration Error Message List.
- (7) Press  key to go back to the Manual Setting screen, Fig. 20.8.
- (8) When all the settings have been completed, execute as described later in 20.7, "Ending Configuration," to start the system again.



CAUTION

Be sure to press the  key after entering values for the items. Failing to do so will invalidate the values entered.

Below is the Configuration Error Message List.

Table 20.3 Configuration Error Message List



Message	Description	Corrective Action
INCOMPLETE	Operation is canceled in the middle.	Complete the operation.
ADDRESS ERROR	Improper address setting	Correct the 「MAX POSITION」 setting.
ADDRESS OVER FLOW	The total number of addresses robots use has exceeded the maximum number.	Correct the 「MAX POSITION」 setting.
ALREADY USED A AXIS	Other robot already uses the motor specified for A-Axis.	Correct the 「A(X) AXIS NO.」 setting.
ALREADY USED B AXIS	Other robot already uses the motor specified for B-Axis.	Correct the 「B(Y) AXIS NO.」 setting.
ALREADY USED Z AXIS	Other robot already uses the motor specified for Z-Axis.	Correct the 「Z AXIS NO.」 setting.
ALREADY USED W AXIS	Other robot already uses the motor specified for W-Axis.	Correct the 「W AXIS NO.」 setting.
ALREADY USED R AXIS	Other robot already uses the motor specified for R-Axis.	Correct the 「R AXIS NO.」 setting.
ALREADY USED C AXIS	Other robot already uses the motor specified for C-Axis.	Correct the 「C AXIS NO.」 setting.
NO REGISTRY A AXIS	The motor specified for A-Axis has not been registered.	Set the motor No. for 「MOTOR NO.」 Then, set for 「A(X) AXIS NO.」
NO REGISTRY B AXIS	The motor specified for B-Axis has not been registered.	Set the motor No. for 「MOTOR NO.」 Then, set for 「B(Y) AXIS NO.」
NO REGISTRY Z AXIS	The motor specified for Z-Axis has not been registered.	Set the motor No. for 「MOTOR NO.」 Then, set for 「Z AXIS NO.」
NO REGISTRY W AXIS	The motor specified for W-Axis has not been registered.	Set the motor No. for 「MOTOR NO.」 Then, set for 「W AXIS NO.」
NO REGISTRY R AXIS	The motor specified for R-Axis has not been registered.	Set the motor No. for 「MOTOR NO.」 Then, set for 「R AXIS NO.」

Message	Description	Corrective Action
NO REGISTRY C AXIS	The motor specified for C-Axis has not been registered.	Set the motor No. for 「MOTOR NO.」 Then, set for 「C AXIS NO.」
DATA ERROR [REV.]	The number of revolutions is incorrect.	Correct the 「MOTOR REV.」 setting.
DATA ERROR [PULSE]	The number of pulses is incorrect.	Correct the 「ENCULSE」 setting.
DATA ERROR [LEAD]	The lead value is incorrect.	Correct the 「LEAD」 setting.
DATA ERROR [CODE]	The motor code is incorrect.	Correct the 「MOTOR CODE」 setting.
ROBOT TYPE ERROR	The robot type is incorrect.	Correct the 「R/B TYPE」 setting.
INVALID AXIS NUM	Motor has not been assigned to the axis, or motor that can be assigned is not found.	Assign motors by specifying motor code for 「A(X) AXIS NO.」 up to 「C AXIS NO.」
ACCEL/DECEL ERROR	No accelerating/decelerating time has been set.	Set for all the items starting from 「ACCEL A」 to 「ACCEL Z」.

20.5 Data for Optional Specifications

When the System Configuration screen as shown in Fig. 20.5 is retrieved, pressing the  key 「3. OPTION」 displays the data setting items for optional specifications. Normally, you do not have to use this group.

20.6 Initializing the Configuration

When the System Configuration screen as shown in Fig.20.5 is retrieved, pressing the  key 「4. INITIALIZE」 displays “INITIALIZE OK?” on the message line. To initialize the system configuration, press the  key.



This initializing operation clears the entire system configuration. Never carry out this operation after the system set-up, unless data are destroyed.

20.7 Ending Configuration

Steps for ending configuration are described below.

- (1) Turn OFF the power.
- (2) Set to ON the DIP switch 1 on CPU board (shown in Fig. 20.3) in the controller.
- (3) After 10 seconds, turn ON the power again.
- (4) The screen display returns to Opening Screen, as shown in Fig. 20.4.





20.8 Checking the Settings

You can start system configuration without changing the DIP switch setting. The procedure for checking the system configuration data is given below.

- (1) Carry out the steps in 2.2, “Connecting the Teach Pendant to the Controller” and retrieve the screen as illustrated below for selecting a robot number.



SELECT ROBOT NUMBER	
1. ROBOT 1	2. ROBOT 2
3. ROBOT 3	4. ROBOT 4

Fig. 20.12 Screen for Selecting Robot Number

- (2) Select ROBOT 1.
- (3) Press the  +  keys to set KEY-IN mode for the Teach Pendant.
- (4) Press the  +  keys simultaneously. The shaded portion of the illustration, Fig.20.13, Robot Calculation Mode, appears on the screen. To display 「7. CONFIG MODE」, press the  key to scroll the screen.

ROBOT CALCULATE MODE	
1. CALC.	2. OFFSET
3. MEMORY	4. DISP
5. SERVO	5. BP/ZONE
7. CONFIG MODE	

Fig. 20.13 Robot Calculation Mode

- (5) Pressing the  key 「7. CONFIG MODE」 displays “CHANGE OK?” on the message line. Then, press the  key.
- (6) When “Reboot Controller.” appears on the message line, turn OFF the power on the controller. Thirty seconds after this, turn ON the power again.
- (7) The system configuration mode is entered. Start the operation from the step (2) in 20.2, “Starting Configuration.”
- (8) Check the contents of the system configuration settings.
- (9) Turn OFF the power. After thirty seconds, turn ON the power again to exit the system configuration mode.

CHAPTER 21 Initializing System Data

21.1 Outline

System data are semi-fixed data required to operate robots, specifically they are the data intrinsic to robots used and data to optimize the robots accordingly with the system. It is not necessary to modify the data after the robots are incorporated into the system. However, incorrect or inappropriate values cause malfunctioning or failure of the robots.

Initialize system data only when:

- System data are destroyed due to running out of battery power.
- System configuration is executed.





CAUTION





Before starting robot operation, always be sure to specify correct data and record such set values. Initializing system data also initializes servo parameters at the same time and the default value will be set automatically to the system data.

21.2 Setting Default Values to the System

Setting default values to the system is described below.

- (1) Press the  +  keys to set the Teach Pendant in KEY-IN mode.



- (2) Press the  key to illuminate 『SHIFT』 LED.
- (3) Press the  key while pressing the  key.
- (4) “DEFAULT COPY OK?” appears on the message line. To execute copying the default values onto the system, press the  key. If you do not wish to copy the default values, press any key other than the  key.



CAUTION

After copying default values onto the system, be sure to set the system data supplied upon delivery of the system. Or, when system data list attached to the controller is available, set such data.

Inside the robot memory, position data are stored as values on X-Y coordinates. When the robot performs positioning, the system converts values on X-Y coordinates into pulses allotted to axes, based on initial data (「INITIAL A」-「INITIAL C」) and arm lengths (「LENGTH A」-「LENGTH C」) in 「AR TYPE ADJUST」 reached from 「ADJUST」 in System Generation menu.

For this reason, if such initial data and/or arm lengths are changed after teaching, the original positions cannot be reproduced.

For the following items, default copying (copying of the default values) will not be executed if the current value of each item is within a permissible variation range of the default value. However, it is necessary to check the following data after executing the default copy.

Initial data: default value	: $\pm 90^\circ$ (varies depending on the robot type)
Arm length: default value	: $\pm 90\text{mm}$ (varies depending on the robot type)
Direction of A-CAL ⁱ	: 0 (PLUS) or 1 (MINUS)
AXIS TYPE ⁱⁱ	: 0 (NOT USED) or 1 (USED)
AXIS SELECT ⁱⁱⁱ	: 0 (NOT HOLD) or 1 (HOLD)

When "SYSTEM DATA ERROR" occurs, be sure to copy the default values on to the system first and then to edit the data. Also, after data editing, turn ON the power again.

21.3 Setting for SCARA (Horizontal Multi-Articulated) Robot

In cases of a SCARA robot, the steps described below should be performed after initializing the system data.

- (1) Set for the 「A-CAL DIR. A」 to 「A-CAL DIR. B」 so that the counterclockwise direction corresponds to the "+" (PLUS) direction of A-CAL when A, B and W-Axes of the SCARA robot are displayed in angle. 「A-CAL DIR. A」 to 「A-CAL DIR. B」 can be reached by selecting 「ORIGIN」→「AXIS DIRECTION」 in System Generation menu.
- (2) The pose for A-CAL is as illustrated below. When the arm interferes, A-CAL should be performed axis by axis.

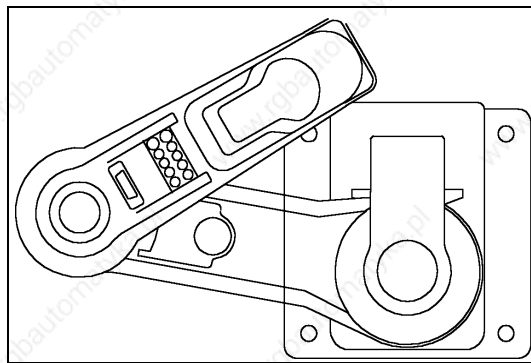

Fig. 21.1 Pose for A-CAL

ⁱ : 「ORIGIN」→「AXIS DIRECTION」→「A-CAL DIR. A」→「A-CAL DIR. C」 in System Generation menu
ⁱⁱ : 「ORIGIN」→「AXIS SELECT」→「A AXIS TYPE」→「C AXIS TYPE」 in System Generation menu
ⁱⁱⁱ : 「ORIGIN」→「AXIS SELECT」→「A AXIS SEL」→「C AXIS SEL」 in System Generation menu

- (3) Set for the 「INITIAL A」 to 「INITIAL B」 so that the respective values of A, B and W-Axes become 0 when the robot poses as shown below. 「INITIAL A」 to 「INITIAL B」 can be reached by selecting 「ORIGIN」→「AXIS DIRECTION」 in System Generation menu.

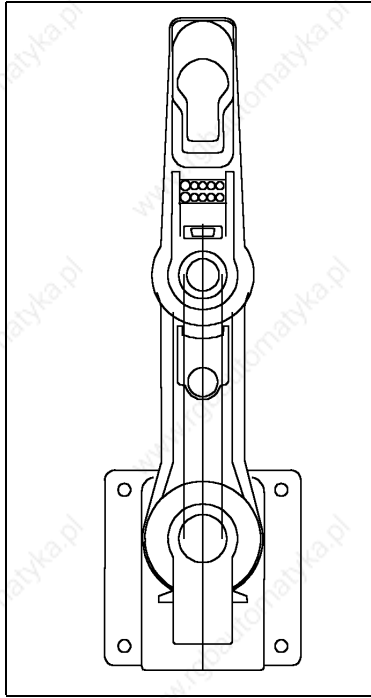

Fig. 21.2 Pose for Setting 「INITIAL A」-「INITIAL C」

Table 21.1 Case of AR-ZL850

Example

	A	B	Z	W
「INITIAL A」-「INITIAL C」	-110	-155	0	0
「LENGTH A」-「LENGTH C」	850	650	0	0
「UPPER LMT A」-「UPPER LMT C」	110	155	3000	360
「LOWER LMT A」-「LOWER LMT C」	-110	-155	0	0

CHAPTER 22 Initializing Position Data

Initialize position data of the robot when:

Steps for initializing robot position data are described below.

- Position data are destroyed.
- System configuration is executed and system data is initialized.

- (1) Press the  +  keys to block operation mode for position memory.

The applicable position addresses are between address 0 and the maximum address number specified by 「LIMIT」→「ADDRESS MAX」→「ADDRESS MAX」 in System Generation menu.

The shaded portion of the opening screen in Fig.22.1 appears. To display 「MODE COMMAND」 and the following items in sequence,

press the  key to scroll the screen.



POSITION COMMAND			
START ADDRESS			0000
END ADDRESS			0000
SET ADDRESS			0000
MODE COMMAND		[MOVE]	
Push END Key !!			



Fig. 22.1 Block Operation Mode

- (2) Specify 0 in the space next to 「START ADDRESS」 and specify in the space next to 「END ADDRESS」 the value set for 「LIMIT」→「ADDRESS MAX」→「ADDRESS MAX」 in System Generation menu. It is not necessary to specify any value for 「SET ADDRESS」.

Enter for respective items and press the  key twice after each entry to set the data.

- (3) Specify "INIT" for 「MODE COMMAND」.

Press the  key until "INIT" is displayed in the space. Press the  key twice to set the value.

- (4) Press the  key. Then, "Position INIT Ok?" is displayed.
- (5) To execute the INIT command, press the  key.
- (6) When "INIT Completed!!" appears, the command has been executed.
- (7) Initialized position data are shown below.

0010	M??	F99	S00	L 0
X	0000.00	Y	0000.00	
Z	0000.00	W	0000.00	
R	0000.00	C	0000.00	





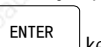

Fig. 21.1 Initialized Data (of 6-Axis Specification)

CHAPTER 23 Message

The following tables are the messages displayed on the message line on the Teach Pendant. Also, error messages are displayed. Refer to these messages for trouble-shooting.

23.1 General Message

Table 23.1 General Message

Message	Mode	Description
A-CAL COMPLETE	TEACH CHECK	A-CAL completed normally. 『A-CAL』 LED light up.
A-CAL INCOMPLETE	TEACH CHECK AGING	A-CAL incomplete. Error is occurred during A-CAL execution. Intend to perform the aging before A-CAL completion.
A-CAL OK?	TEACH CHECK	The  key is pressed to perform A-CAL.
AXIS SELECT OFF	TEACH CHECK	No axis is selected for A-CAL.
CHECK SPEED DATA >	CHECK	Sets the speed of the robot in CHECK mode.
COMPLETE	CHECK	Positioning complete normally.
COMPLETED !!		Completes memory card transaction.
DEFAULT COPY OK?	KEY-IN	Copies the system data default value in KEY-IN mode.
DELETE OK?	KEY-IN CHECK	The  +  keys are pressed.
END POINT	CHECK	Intend to perform the positioning to END point in CHECK mode.
END WRITE OK?	KEY-IN TEACH	The  key is pressed.
ENTER OK?	KEY-IN TEACH CHECK	The  key is pressed. Press the  key again for data input.
INCOMPLETE	CHECK	The  key is pressed in the middle of positioning. Error is occurred during positioning.
INSERT OK?	KEY-IN TEACH	The  key is pressed.

23.2 Warning Message

Table 23.2 Warning Message

Message	Mode	Description
A-CAL WARNING !!	TEACH CHECK	A-CAL is not executed correctly. "A-CAL ERR.-----" error occurrence. System data 「A-CAL CHECK」 ⁱ is set to "1."
AGING ABORT	AGING	Agging is interrupted.
AGING STOP(Start)	AGING	Agging is completed for the agging count.
ENC BATTERY WARNING!	TEACH CHECK ON-LINE	Encoder battery voltage becomes low.
POSITIONING WARNING	TEACH CHECK ON-LINE	"POS ERROR *****" error occurrence. System data 「POS ERROR SELECT」 ⁱⁱ is set to "1."
STOP ON	TEACH CHECK ON-LINE	DI STOP signal is ON. Prohibit the axis operation.
SYS BATTERY WARNING!	TEACH CHECK ON-LINE	System battery voltage on the CPU board becomes low.

ⁱ : System Generation, 「MAINTENANCE」→「MAINTENANCE DATA」→「A-CAL CHECK」

ⁱⁱ : System Generation, 「MAINTENANCE」→「MAINTENANCE DATA」→「POS. ERROR SEL」

23.3 Error Message

Table 23.3 Error Message

Error Message	Mode	Description	Corrective Action
A-CAL INCOMPLETE	TEACH CHECK ON-LINE	A-CAL is not executed normally.	Refer to Chapter 3, "A-CAL (Automatic Calibration)."
ACAL ERR *0 Not Find ACAL ERR *1 Not Off ACAL ERR *2 Other On ACAL ERR *3 Not Zero ACAL ERR *4 Lower ACAL ERR *5 Upper ACAL ERR *6 Minus ACAL ERR *7 Error	TEACH CHECK ON-LINE	CAL is not executed normally. "*" is correspond the each axis. A···X(A)-Axis B···Y(B)-Axis Z···Z-Axis, W···W-Axis R···R-Axis, C···C-Axis	Refer to Ch3.4, "A-CAL Related Error."
ACCEL/DECEL ERROR (System configuration error)		No accelerating/decelerating time has been set.	Set for all the items starting from 「ACCEL A」 to 「ACCEL Z」.
ADDRESS ERROR (System configuration error)		Improper address setting	Correct the 「MAX POSITION」 setting.
ADDRESS ERROR	TEACH CHECK ON-LINE	The value for the input or motion address is out of range in the system data, 「ADDRESS MAX」 ¹ .	Set the large value for 「ADDRESS MAX」. Correct the designated address.
ADDRESS OVER FLOW (System configuration error)		The total number of addresses robots use has exceeded the maximum number.	Correct the 「MAX POSITION」 setting.
ALREADY USED A AXIS (System configuration error)		Other robot already uses the motor specified for A-Axis.	Correct the 「A(X)AXIS NO.」 setting.
ALREADY USED B AXIS (System configuration error)		Other robot already uses the motor specified for B-Axis.	Correct the 「B(Y)AXIS NO.」 setting.
ALREADY USED C AXIS (System configuration error)		Other robot already uses the motor specified for C-Axis.	Correct the 「C AXIS NO.」 setting.
ALREADY USED R AXIS (System configuration error)		Other robot already uses the motor specified for R-Axis.	Correct the 「R AXIS NO.」 setting.
ALREADY USED W AXIS (System configuration error)		Other robot already uses the motor specified for W-Axis.	Correct the 「W AXIS NO.」 setting.
ALREADY USED Z AXIS (System configuration error)		Other robot already uses the motor specified for Z-Axis.	Correct the 「Z AXIS NO.」 setting.
AREA ERROR ***** "*****" is designates as X(A), Y(B), Z, W, R,C-Axis status in the sequence.	KEY-IN TEACH CHECK ON-LINE	The designated value is out of the operational area of the robot. "*" is one of the numbers from 0-3. 0···Normal, 1···Over the lower limit 2···Over the upper limit 3···Over the both limit	Check the value of the System Generation, 「LIMIT」→「AREA LIMIT」 and input the value which is inside of the operational area.
Address Error (Automatic calculation error)	KEY-IN	Address is abnormal.	-
Axis Not Used (Automatic calculation error)	KEY-IN	The setting for the axis, for which calculation is made, is "NOT USED."	Specify the proper value.
BCC WRITE ERROR !! (Memory card abnormal)	KEY-IN TEACH CHECK	Error is occurred during writing the check character in the file.	Try again to write. When the error repeats, the memory card itself has been damaged. Use another card.
CARD BCC ERROR (Memory card abnormal)	KEY-IN TEACH CHECK	The system area in the memory card is destroyed.	Execute the FORMAT command in UTILITY mode. Refer to 13.7.5, "FORMAT Command."
CARD FULL !! (Memory card abnormal)	KEY-IN TEACH CHECK	You attempted to save more information than the card storage capacity	Delete unnecessary files and save again.
CARD NOT READY !! (Memory card abnormal)	KEY-IN TEACH CHECK	No memory card in place.	Insert a memory card properly.

¹: System Generation, 「LIMIT」→「ADDRESS MAX」→「ADDRESS MAX」

Error Message	Mode	Description	Corrective Action
CPU LOW BATTERY	CHECK ON-LINE	Battery voltage on the CPU board becomes low.	Replace the battery. Battery type: H-3339
DATA CHECK ERROR !! (Memory card abnormal)	KEY-IN TEACH CHECK	Either the independent check character or data in the file are destroyed.	Try again to write. When the error repeats, the memory card itself has been damaged. Use another card.
DATA ERROR [CODE] (System configuration error)		The motor code is incorrect.	Correct the 「MOTOR CODE」 setting.
DATA ERROR [LEAD] (System configuration error)		The lead value is incorrect.	Correct the 「LEAD」 setting.
DATA ERROR [PULSE] (System configuration error)		The number of pulses is incorrect.	Correct the 「ENC PULSE」 setting.
DATA ERROR [REV.] (System configuration error)		The number of revolutions is incorrect.	Correct the 「MOTOR REV.」 setting.
DRIVER ERR.***** ***** is designates as X(A), Y(B), Z, W, R, C-Axis status in the sequence.	TEACH CHECK ON-LINE	Error is occurred in the servo amplifier/driver. ** is one of the numbers 0 and 1. 0...Normal, 1...Error occurrence	Check the servo amplifier/driver.
DRIVER NOT ONLINE	TEACH CHECK ON-LINE	Servo amplifier/driver disconnection	Check the cable connection.
DRIVER TIME OUT	TEACH CHECK ON-LINE	Servo amplifier/driver disconnection	Check the cable connection.
DUPLICATE FILE NAME (Memory card abnormal)	TEACH CHECK	The same file name is specified as the SOURCE and DESTINATION when copying.	Change the DESTINATION file name to a different one from the SOURCE file name. Refer to 13.6.4, "COPY Command."
EMERGENCY STOP	TEACH CHECK ON-LINE	Inputted Emergency Stop signal	Release Emergency Stop status.
ENC BATTERY***** ***** is designates as X(A), Y(B), Z, W, R, C-Axis status in the sequence.	CHECK TEACH ON-LINE	Encoder battery voltage becomes low. ** is one of the numbers 0 and 1. 0...Normal, 1...Error occurrence	Replace the battery. Battery type: R086-12-38
FAT WRITE ERROR !! (Memory card abnormal)	KEY-IN TEACH CHECK	FAT cannot be written in.	Try again to write. When the error repeats, the memory card itself has been damaged. Use another card.
FILE ALREADY OPEN (Memory card abnormal)	KEY-IN TEACH CHECK	You have opened again the file that had already opened.	-
FILE BAD ALLOCATION (Memory card abnormal)	KEY-IN TEACH CHECK	FAT has been destroyed.	Execute FORMAT command in UTILITY mode. Refer to Ch13.7.5, "FORMAT Command."
FILE CAN NOT OPEN (Memory card abnormal)	KEY-IN TEACH CHECK	You attempted to access a file that was not opened.	-
FILE HANDLE FULL !! (Memory card abnormal)	KEY-IN TEACH CHECK	Too many files have been opened.	-
FILE ID ERROR !! (Memory card abnormal)	KEY-IN TEACH CHECK	The check characters verifying the file information do not match.	Delete the file using DELETE command. Refer to 13.6.5, "DELETE Command." Delete unnecessary files and try again.
FILE ID FULL !! (Memory card abnormal)	KEY-IN TEACH CHECK	You attempted to store more files than the defined number of files. Refer to 13.7.5, "FORMAT Command."	Delete unnecessary files and try again.
FILE ID WRITE ERROR (Memory card abnormal)	KEY-IN TEACH CHECK	The check character to verify the file information cannot be written in.	Try again to write. When the error repeats, the memory card itself has been damaged. Use another card.
FILE NOT CLOSED (Memory card abnormal)	KEY-IN TEACH CHECK	You attempted to execute UTILITY command with files opened.	Close all the files that are opened.

Error Message	Mode	Description	Corrective Action
FILE NOT FOUND !! (Memory card abnormal)	KEY-IN TEACH CHECK	The specified file cannot be found.	Check for the correct file name.
FORMAT ERROR !! (Memory card abnormal)	KEY-IN TEACH CHECK	The memory card is not initialized.	Execute FORMAT command in UTILITY mode. Refer to 13.7.5, "FORMAT Command."
INCOMPLETE (System configuration error)	-	Operation is canceled in the middle.	Complete the operation.
INVALID AXIS NUM (System configuration error)	-	Motor has not been assigned to the axis, or motor that can be assigned is not found.	Assign motors by specifying motor code for 「A(X) AXIS NO.」 up to 「Z AXIS NO.」
Incompleted!! (Automatic calculation error)	KEY-IN	Normal calculation is not possible.	Check if the set data and teaching positions are appropriate. Then, specify correct data or teach again.
Initial Data Error (Automatic calculation error)	KEY-IN	Initial data is abnormal	Initialize again.
Mode Error (Automatic calculation error)	KEY-IN	The selected mode is not KEY-IN, TEACH, CHECK mode.	Change the mode.
NO REGISTRY A AXIS (System configuration error)		The motor specified for A-Axis has not been registered.	Set the motor No. for 「MOTOR NO.」 Then, set for 「A(X)AXIS NO.」
NO REGISTRY B AXIS (System configuration error)		The motor specified for B-Axis has not been registered.	Set the motor No. for 「MOTOR NO.」 Then, set for 「B(Y)AXIS NO.」
NO REGISTRY C AXIS (System configuration error)		The motor specified for C-Axis has not been registered.	Set the motor No. for 「MOTOR NO.」 Then, set for 「C AXIS NO.」
NO REGISTRY R AXIS (System configuration error)		The motor specified for R-Axis has not been registered.	Set the motor No. for 「MOTOR NO.」 Then, set for 「R AXIS NO.」
NO REGISTRY W AXIS (System configuration error)		The motor specified for W-Axis has not been registered.	Set the motor No. for 「MOTOR NO.」 Then, set for 「W AXIS NO.」
NO REGISTRY Z AXIS (System configuration error)		The motor specified for Z-Axis has not been registered.	Set the motor No. for 「MOTOR NO.」 Then, set for 「Z AXIS NO.」
OVERRUN ***** ***** is designates as X(A), Y(B), Z, W, R,C- Axis status in the sequence.	TEACH CHECK ON-LINE	The robot is in overrun area. ** is one of the numbers from 0-3. 0...Normal, 1...ORIGIN sensor side 2...OVERRUN sensor side 3...ORIGIN/OVERRUN sensor Each number describes the sensor is ON.	Move the robot to inside of the operation area, and check the position data.
P1-P2 Length Error (Automatic calculation error)	KEY-IN	Distance between P1 and P2 is too short.	Teach again.
P1-P3 Length Error (Automatic calculation error)	KEY-IN	Distance between P1 and P3 is too short.	Teach again.
POS ERROR ***** ***** is designates as X(A), Y(B), Z, W, R, C-Axis status in the sequence.	CHECK ON-LINE	Positioning is not completed even the robot reached at the target position. Excessive load Excessive acceleration/deceleration Improper adjustment for the servo amplifier/driver. "d" is one of the numbers 0 and 1. 0...Normal, 1...Error occurrence	Adjust the servo parameters. Check if any external pressure (Pneumatic hose, cable) is exist.
POSITION DATA ERROR (Memory card abnormal)	ON-LINE	Reading data from the memory card is failed during automatic operation.	Check the designated data is stored to the memory card correctly.
POSITIONING ERROR	CHECK ON-LINE	Positioning is not able to performed. Designated speed and acceleration/deceleration at the last position is exceeding. Servo gain is small.	Adjust servo parameter. Slow down the acceleration/deceleration. Slow down the designated speed (F-code) at the last position.
R-Offset Data Error (Automatic calculation error)	KEY-IN	Rotary-offset value has been abnormal.	Teach again.
ROBOT TYPE ERROR (System configuration error)		The robot type is incorrect.	Correct the 「R/B TYPE」 setting.

Error Message	Mode	Description	Corrective Action
SERVO DATA ERROR	TEACH CHECK ON-LINE	Servo Parameters are abnormal or not be entered.	Copy the default value of system data. Enter the correct value to the Servo Parameters.
SERVO ON ERROR	TEACH CHECK ON-LINE	Unable to be in servo lock condition	Check the power for the servo amplifier/driver control.
STATUS ERROR	TEACH CHECK ON-LINE	Internal processing error Error which is not supported is occurred.	Cancel with the  key. Then, contact your distributor.
SYSTEM DATA ERROR	TEACH CHECK ON-LINE	The system data is not correct or not entered.	Copy the default value of the system data. The, enter the required value of the system data. Refer to 17.3.5, "Setting Default Values for System Data."
SYSTEM ERROR	TEACH CHECK ON-LINE	Internal processing error	Contact your distributor.
Teaching Data Error (Automatic calculation error)	KEY-IN	Teaching data is abnormal.	Teach again.
UNDEFINED ERROR !! (Memory card abnormal)	KEY-IN TEACH CHECK	An unexpected error has occurred.	Re-try the operation. When the error repeats, contact your distributor.
VERIFY ERROR !! (Memory card abnormal)	KEY-IN TEACH CHECK	The system failed to compare the file information for verification. The memory card may be damaged.	Replace the card with a new one.
WRITE PROTECT !! (Memory card abnormal)	KEY-IN TEACH CHECK	You attempted to write with the write-protect switch turned ON.	Check the information stored on the card. If editable, turn OFF the write-protect switch.

CHAPTER 24 System Generation

24.1 LIMIT group

24.1.1 ADDRESS MAX

Parameter	Description	Digit	Minimum unit	Standard value	Note	Set value
ADDRESS MAX	Maximum position address value	4	1	999	0 to 9999	

24.1.2 AREA LIMIT

Parameter	Description	Digit	Minimum unit	Standard value	Note	Set value
UPPER LMT A	X(A)-Axis maximum area	7	± 0.001	1000	-7999.999 to 7999.999	
LOWER LMT A	X(A)-Axis minimum area	7	± 0.001	0	-7999.999 to 7999.999	
UPPER LMT B	Y(B)-Axis maximum area	7	± 0.001	1000	-7999.999 to 7999.999	
LOWER LMT B	Y(B)-Axis minimum area	7	± 0.001	0	-7999.999 to 7999.999	
UPPER LMT Z	Z-Axis maximum area	7	± 0.001	400	-7999.999 to 7999.999	
LOWER LMT Z	Z-Axis minimum area	7	± 0.001	0	-7999.999 to 7999.999	
UPPER LMT W	W-Axis maximum area	7	± 0.001	720	-7999.999 to 7999.999	
LOWER LMT W	W-Axis minimum area	7	± 0.001	0	-7999.999 to 7999.999	
UPPER LMT R	R-Axis maximum area	7	± 0.001	720	-7999.999 to 7999.999	
LOWER LMT R	R-Axis minimum area	7	± 0.001	0	-7999.999 to 7999.999	
UPPER LMT C	C-Axis maximum area	7	± 0.001	720	-7999.999 to 7999.999	
LOWER LMT C	C-Axis minimum area	7	± 0.001	0	-7999.999 to 7999.999	

24.2 MAINTENANCE Group

24.2.1 EXPANSION A

Parameter	Description	Digit	Minimum unit	Standard value	Note	Set value
CPC GAIN Z	Not used.	7	± 1	0	Not used.	
CPC GAIN W	Not used.	7	± 1	0	Not used.	
DOWN CNT.	Not used.	7	± 1	0	Not used.	
PRIV. FLAG	Not used.	7	± 1	0	Not used.	

24.2.2 EXPANSION B

Parameter	Description	Digit	Minimum unit	Standard value	Note	Set value
INITIAL W	Not used.	6	± 0.001	0	Not used.	
LENGTH W	Not used.	6	± 0.001	0	Not used.	
AXIS UP/DOWN	Not used.	6	± 0.001	0	Not used.	
ANGLE REV.	Not used.	6	± 0.001	0	Not used.	

24.2.3 MAINTENANCE DATA

Parameter	Description	Digit	Minimum unit	Standard value	Note	Set value
CPC SELECT	Not used.	3	1	0	Not used.	
CPC LOOP TIME	Not used.	3	1	0	Not used.	
CPC SP1	Not used.	3	1	0	Not used.	
CPC SP2	Not used.	3	1	0	Not used.	
A-CAL CHECK	A-CAL designation	3	1	0		
POS.ERROR SEL	Positioning error detect selection	3	1	0	Not supported	
AB SLOWDOWN TIM	Timing for A, B, W-Axes slow down	3	1	0	Not supported	
SERVO TYPE	Not used.	3	1	0	Not used.	
EMP SELECT	(Encoder Monitor Program Select) Driver error detect and encoder battery alarm detect selection	3	1	0		
HOLD POWER SAVE	Time interval setting from HOLD to braking	3	1	0	Not supported	
Z SLOWDOWN TIM	Timing for Z-Axis slow down	3	1	0	Not supported	
STATION NO	Station No. setting	3	1	0		
SENSOR STOP SEL	W-Axis sensor stop input logic	3	1	0	Not supported	
SENSOR COUNT	W-Axis sensor stop input detection amplitude	3	1	0	Not supported	
PTP Z IN DATA	Not used.	3	1	0	Not used.	
POSITIONING CNT	Not used.	3	1	0	Not used.	

24.3 ORIGIN Group

24.3.1 SET-UP SYSTEM

Parameter	Description	Digit	Minimum unit	Standard value	Note	Set value
TRANSFER RATE	Data transfer speed for RS-232C			9600	Character-form value	
ON-LINE SELECT	Function selection	1	1	0		
STOP SELECT	STOP signal detect method			STATUS	Character-form value	
STOP	STOP signal function			STOP	Character-form value	
STORE ADDRESS	Address setting at recovery			NEXT	Character-form value	
I/O ASSIGNMENT	I/O assignment	1	1	0		
INCHING SELECT	Inching selection	1	1	0		
M DATA	M-data usage definition	2	1	0	0 to 99	
AUTO/ON-LINE	Mode selection			ON-LINE	Character-form value	
EMERGENCY STOP	A-CAL selection at E.S			KEEP	Character-form value	

24.3.2 AXIS DIRECTION

Parameter	Description	Digit	Minimum unit	Standard value	Note	Set value
A-CAL SEQ.	A-CAL sequence	6	111111	221222		
A-CAL DIR.A	A(X)-Axis A-CAL direction			PLUS	Character-form value	
A-CAL DIR.B	B(Y)-Axis A-CAL direction			PLUS	Character-form value	
A-CAL DIR.Z	Z-Axis A-CAL direction			PLUS	Character-form value	
A-CAL DIR.W	W-Axis A-CAL direction			PLUS	Character-form value	
A-CAL DIR.R	R-Axis A-CAL direction			PLUS	Character-form value	
A-CAL DIR.C	C-Axis A-CAL direction			PLUS	Character-form value	
INCH DIR.A	A(X)-Axis inching direction			PLUS	Character-form value	
INCH DIR.B	B(Y)-Axis inching direction			PLUS	Character-form value	
INCH DIR.Z	Z-Axis inching direction			PLUS	Character-form value	
INCH DIR.W	W-Axis inching direction			PLUS	Character-form value	
INCH DIR.R	R-Axis inching direction			PLUS	Character-form value	
INCH DIR.C	C-Axis inching direction			PLUS	Character-form value	

24.3.3 AXIS SELECT

Parameter	Description	Digit	Minimum unit	Standard value	Note	Set value
A AXIS TYPE	A-Axis selection			USED	Character-form value	
A AXIS SEL	A-Axis hold (servo lock) selection			HOLD	Character-form value	
B AXIS TYPE	B-Axis selection			USED	Character-form value	
B AXIS SEL	B-Axis hold (servo lock) selection			HOLD	Character-form value	
Z AXIS TYPE	Z-Axis selection			USED	Character-form value	
Z AXIS SEL	Z-Axis hold (servo lock) selection			HOLD	Character-form value	
W AXIS TYPE	W-Axis selection			USED	Character-form value	
W AXIS SEL	W-Axis hold (servo lock) selection			HOLD	Character-form value	
R AXIS TYPE	R-Axis selection			USED	Character-form value	
R AXIS SEL	R-Axis hold (servo lock) selection			HOLD	Character-form value	
C AXIS TYPE	C-Axis selection			USED	Character-form value	
C AXIS SEL	C-Axis hold (servo lock) selection			HOLD	Character-form value	

24.4 ADJUST Group

24.4.1 AR TYPE ADJUST

Parameter	Description	Digit	Minimum unit	Standard value	Note	Set value
INITIAL A	A-Axis initial value	7	± 0.001	0	-7999.999 to 7999.999	
INITIAL B	B -Axis initial value	7	± 0.001	0	-7999.999 to 7999.999	
INITIAL Z	Z -Axis initial value	7	± 0.001	0	-7999.999 to 7999.999	
INITIAL W	W -Axis initial value	7	± 0.001	0	-7999.999 to 7999.999	
INITIAL R	R -Axis initial value	7	± 0.001	0	-7999.999 to 7999.999	
INITIAL C	C -Axis initial value	7	± 0.001	0	-7999.999 to 7999.999	
LENGTH A	A-Axis arm length	7	0.001	0	0 to 9999.999	
LENGTH B	B-Axis arm length	7	0.001	0	0 to 9999.999	
LENGTH Z	Z-Axis arm length	7	0.001	0	0 to 9999.999	
LENGTH W	W-Axis arm length	7	0.001	0	0 to 9999.999	
LENGTH R	R-Axis arm length	7	0.001	0	0 to 9999.999	
LENGTH C	C-Axis arm length	7	0.001	0	0 to 9999.999	
AXIS COMBINATION	Axis combination (0-2)	1	1	0	Not used.	

24.4.2 MB TYPE ADJUST

Parameter	Description	Digit	Minimum unit	Standard value	Note	Set value
Y INITIAL	Y-Axis initial angle	7	± 0.001	145	Not supported.	
MB COMBINATION	Axis combination	1	1	0	Not supported.	

24.5 CAPABILITY Group

24.5.1 ROBOT CAPABILITY

Parameter	Description	Digit	Minimum unit	Standard value	Note	Set value
ENC.PULSE A	A-Axis encoder pulse	7	1		Display only.	
ENC.PULSE B	B-Axis encoder pulse	7	1		Display only.	
ENC.PULSE Z	Z-Axis encoder pulse	7	1		Display only.	
ENC.PULSE W	W-Axis encoder pulse	7	1		Display only.	
ENC.PULSE R	R-Axis encoder pulse	7	1		Display only.	
ENC.PULSE C	C-Axis encoder pulse	7	1		Display only.	
LEAD/GEAR A	A-Axis lead/gear ratio	6	0.001		Display only.	
LEAD/GEAR B	B-Axis lead/gear ratio	6	0.001		Display only.	
LEAD/GEAR Z	Z-Axis lead/gear ratio	6	0.001		Display only.	
LEAD/GEAR W	W-Axis lead/gear ratio	6	0.001		Display only.	
LEAD/GEAR R	R-Axis lead/gear ratio	6	0.001		Display only.	
LEAD/GEAR C	C-Axis lead/gear ratio	6	0.001		Display only.	
MOTOR REV. A	A-Axis max. motor revolution	4	1		Display only.	
MOTOR REV. B	B-Axis max. motor revolution	4	1		Display only.	
MOTOR REV. Z	Z-Axis max. motor revolution	4	1		Display only.	
MOTOR REV. W	W-Axis max. motor revolution	4	1		Display only.	
MOTOR REV. R	R-Axis max. motor revolution	4	1		Display only.	
MOTOR REV. C	C-Axis max. motor revolution	4	1		Display only.	

24.5.2 EXPANSION A

Parameter	Description	Digit	Minimum unit	Standard value	Note	Set value
EXPANSION 0	Future expansion0				Display only.	
EXPANSION 1	Future expansion1				Display only.	
EXPANSION 2	Future expansion2				Display only.	
EXPANSION 3	Future expansion3				Display only.	
EXPANSION 4	Future expansion4				Display only.	
EXPANSION 5	Future expansion5				Display only.	
EXPANSION 6	Future expansion6				Display only.	
EXPANSION 7	Future expansion7				Display only.	
CPC INTEG GAIN	Not used.				Display only.	
FV TIME 0	Not used.				Display only.	
FV TIME 1	Not used.				Display only.	
FV TIME 2	Not used.				Display only.	

CHAPTER 25 System Parameters

25.1 MOTION Group

25.1.1 MOTION

Parameter	Description	Digit	Minimum unit	Standard value	Note	Set value
PULL-UP	Z-Axis PULL-UP distance at PTP	7	0.001	10	5 to Z-Axis max. working area	
ARCH UP	Z-Axis ARCH UP distance at PTP	7	0.001	0	0 to Z-Axis max. working area	
ARCH DOWN	Z-Axis ARCH DOWN distance at PTP	7	0.001	0	0 to Z-Axis max. working area	
INS DIS.	Z-Axis insert distance at PTP	7	0.001	20	0 to Z-Axis max. working area	
INS SPEED	Z-Axis insert speed at PTP	3	1	20	0 to 99	
UP DIS.	Z-Axis moving up distance at PTP	7	0.001	20	0 to Z-Axis max. working area	
UP SPEED	Z-Axis moving up speed at PTP	3	1	20	0 to 99	
Z NXT PL	Z-Axis next PULL UP	7	0.001	0	Not used.	

25.1.2 AXIS SPEED

Parameter	Description	Digit	Minimum unit	Standard value	Note	Set value
SPEED A, B (X, Y) W	A, B (X, Y), W-Axes speed	3	1	100	0 to 100	
SPEED B	B-Axis speed for expansion	3	1	100	0 to 100	
SPEED Z	Z-Axis speed	3	1	100	0 to 100	
SPEED W	W-Axis speed for expansion	3	1	100	0 to 100	
EXPANSION 2	R-Axis speed for expansion	3	1	100	0 to 100	
EXPANSION 1	C-Axis speed for expansion	3	1	100	0 to 100	

25.1.3 CPC CONSTANT

Parameter	Description	Digit	Minimum unit	Standard value	Note	Set value
CPC SPEED	CPC (interpolation) speed setting	3	1	100	0 to 999	
CPC F.F.GAIN	Not used.	3	1	100	Not used.	
SPLINE SPEED	Not used.	3	1	100	Not used.	
CPC CONSTANT	Passing motion smoothness at CPC	3	1	0	0 to 100	
CPC ACCEL/DECEL	Acceleration/Deceleration speed at CPC	3	1	80	0 to 100	

25.2 RESPONSE

25.2.1 ACCEL

Parameter	Description	Digit	Minimum Value	Standard value	Note	Set value
ACCEL SELECT	Acceleration/Deceleration selection			AUTO	Character-form value	
ACCEL A	A-Axis acceleration/deceleration slow down	3	1	80	0 to 100	
ACCEL B	B-Axis acceleration/deceleration slow down	3	1	80	0 to 100	
ACCEL Z	Z-Axis acceleration/deceleration slow down	3	1	80	0 to 100	
ACCEL W	W-Axis acceleration/deceleration slow down	3	1	80	0 to 100	
ACCEL R	R-Axis acceleration/deceleration slow down	3	1	80	0 to 100	
ACCEL C	C-Axis acceleration/deceleration slow down	3	1	80	0 to 100	

25.2.2 AXIS INP PULSE

Parameter	Description	Digit	Minimum unit	Standard value	Note	Set value
INP PULSE A, B	Not used.	3	1 pulse	6	Not used.	
PULSE B	Not used.	3	1 pulse	6	Not used.	
INP PULSE Z	Not used.	3	1 pulse	6	Not used.	
INP PULSE W	Not used.	3	1 pulse	6	Not used.	
EXPANSION 2	Not used.	3	1 pulse	6	Not used.	
EXPANSION 1	Not used.	3	1 pulse	6	Not used.	

25.2.3 RESPONSE

Parameter	Description	Digit	Minimum unit	Standard value	Note	Set value
SAFE.ZONE	Safety zone setting	7	0.001	10	0 to Z-Axis max. working area	
A-CAL SPEED	A-CAL speed	3	1	50	1 to 999	
INCHING SPEED	Inching speed	3	1	50	1 to 999	
PTP WEIGHT	Total work weight	7	0.001	2	0 to max. work weight	
EXPANSION 1	Expansion1	7	0.001	0	Future expansion	
COMPLIANCE	Not used.	3	1	0	Not used.	
DD INDEX GAIN	Not used.	3	1	0	Not used.	
PTP CONST AB	Not used.	3	1	0	Not used.	
PTP CONST Z	Not used.	3	1	0	Not used.	
PTP CONST W	Not used.	3	1	0	Not used.	
EXPANSION 2	Not used.	3	1	0	Future expansion	
EXPANSION 3	Not used.	3	1	0	Future expansion	

25.3 OFFSET

25.3.1 DISPLAY OFFSET1

Parameter	Description	Digit	Minimum unit	Standard value	Note	Set value
DISP.X1	X-Axis displayed OFFSET1	7	± 0.001	0	-7999.999 to 7999.999	
DISP.Y1	Y-Axis displayed OFFSET1	7	± 0.001	0	-7999.999 to 7999.999	
DISP.Z1	Z-Axis displayed OFFSET1	7	± 0.001	0	-7999.999 to 7999.999	
DISP.W1	W-Axis displayed OFFSET1	7	± 0.001	0	-540.000 to 540.000	
DISP.R1	R-Axis (coordinates rotated) displayed OFFSET1	7	± 0.001	0	-180.000 to 180.000	
TOOL X1	X-Axis coordinates for tip tool1	7	± 0.001	0	Not supported.	
TOOL Y1	Y-Axis coordinates for tip tool1	7	± 0.001	0	Not supported.	
TOOL Z1	Z-Axis coordinates for tip tool1	7	± 0.001	0	Not supported.	

25.3.2 DISPLAY OFFSET2

Parameter	Description	Digit	Minimum unit	Standard value	Note	Set value
DISP.X2	X -Axis displayed OFFSET2	7	± 0.001	0	-7999.999 to 7999.999	
DISP.Y2	Y -Axis displayed OFFSET2	7	± 0.001	0	-7999.999 to 7999.999	
DISP.Z2	Z -Axis displayed OFFSET2	7	± 0.001	0	-7999.999 to 7999.999	
DISP.W2	W -Axis displayed OFFSET2	7	± 0.001	0	-540.000 to 540.000	
DISP.R2	R-Axis (coordinates rotated) displayed OFFSET2	7	± 0.001	0	-180.000 to 180.000	
TOOL X2	X-Axis coordinates for tip tool2	7	± 0.001	0	Not supported.	
TOOL Y2	Y-Axis coordinates for tip tool2	7	± 0.001	0	Not supported.	
TOOL Z2	Z-Axis coordinates for tip tool2	7	± 0.001	0	Not supported.	

25.3.3 DISPLAY OFFSET3

Parameter	Description	Digit	Minimum unit	Standard value	Note	Set value
DISP.X3	X -Axis displayed OFFSET3	7	± 0.001	0	-7999.999 to 7999.999	
DISP.Y3	Y -Axis displayed OFFSET3	7	± 0.001	0	-7999.999 to 7999.999	
DISP.Z3	Z -Axis displayed OFFSET3	7	± 0.001	0	-7999.999 to 7999.999	
DISP.W3	W -Axis displayed OFFSET3	7	± 0.001	0	-540.000 to 540.000	
DISP.R3	R-Axis (coordinates rotated) displayed OFFSET3	7	± 0.001	0	-180.000 to 180.000	
TOOL X3	X-Axis coordinates for tip tool3	7	± 0.001	0	Not supported.	
TOOL Y3	Y-Axis coordinates for tip tool3	7	± 0.001	0	Not supported.	
TOOL Z3	Z-Axis coordinates for tip tool3	7	± 0.001	0	Not supported.	

25.4 SET-UP

25.4.1 EXPANSION A

Parameter	Description	Digit	Minimum unit	Standard value	Note	Set value
Pass PTP Select	Pass PTP selection	3	1	0	Not supported.	
Base Pos Addr1	Base position address1	3	1	0	0 to 「ADDRESS MAX」	
Base Pos Addr2	Base position address2	3	1	0	0 to 「ADDRESS MAX」	
Base Pos Addr3	Base position address3	3	1	0	0 to 「ADDRESS MAX」	
Base Pos Addr4	Base position address4	3	1	0	0 to 「ADDRESS MAX」	
Base Pos Pulse	Base position pulse	5	1	0	0 to 99999	
Safety select	「ARCH UP」, 「SAFE. ZONE」 base position	3	1	0	Fixed value: 0	

25.4.2 EXPANSION B

Parameter	Description	Digit	Minimum unit	Standard value	Note	Set value
SENS.OFF	W-Axis sensor OFFSET	7	± 0.001	0	Not supported.	
SENS.SKP	W-Axis sensor OFF area	7	± 0.001	0	Not supported.	
AREA AX	A(X)-Axis area output	7	± 0.001	0	SCARA robot : -360 to 360, Cartesian robot : -7999.999 to 7999.999	
AREA BY	B(Y)-Axis area output	7	± 0.001	0	SCARA robot : -360 to 360, Cartesian robot : -7999.999 to 7999.999	
Z MD OF.	Z-Axis middle OFFSET	7	± 0.001	0	Not supported.	
Z2 PL-UP	2 nd Z-Axis Pull-Up	7	± 0.001	0	Not supported.	
EXPANSION14	Not used.	7	± 0.001	0	Future expansion	

25.5 REMOTE

25.5.1 MOTION

Parameter	Description	Digit	Minimum unit	Standard value	Note	Set value
PULL-UP	(Displayed data) Z-Axis PULL-UP distance at PTP				Display only	
ARCH UP	(Displayed data) Z-Axis ARCH UP distance at PTP				Display only	
ARCH DOWN	(Displayed data) Z-Axis ARCH DOWN distance at PTP				Display only	
INS DIS.	(Displayed data) Z-Axis insert distance at PTP				Display only	
INS SPEED	(Displayed data) Z-Axis insert speed at PTP				Display only	
UP DIS.	(Displayed data) Z-Axis moving up distance at PTP				Display only	
UP SPEED	(Displayed data) Z-Axis moving up speed at PTP				Display only	

25.5.2 SPEED/ACCEL/INPOS

Parameter	Description	Digit	Minimum unit	Standard value	Note	Set value
SPEED A, B (X, Y) W	(Displayed data) A, B (X, Y), W-Axes speed				Display only	
SPEED B	(Displayed data) B-Axis speed for expansion				Display only	
SPEED Z	(Displayed data) Z-Axis speed				Display only	
SPEED W	(Displayed data) W-Axis speed for expansion				Display only	
EXPANSION 2	(Displayed data) R-Axis speed for expansion				Display only	
EXPANSION 1	(Displayed data) C-Axis speed for expansion				Display only	
ACCEL A, B (X, Y) W	(Displayed data) A, B (X, Y), W-Axis acceleration/deceleration slow down				Display only	
ACCEL A, B, W (PASS)	(Displayed data) A, B (X, Y), W-Axis acceleration/deceleration slow down at PASS PTP				Display only	
ACCEL Z	(Displayed data) Z-Axis acceleration/deceleration slow down				Display only	
ACCEL Z(PASS)	(Displayed data) Z-Axis acceleration/deceleration slow down at PASS PTP				Display only	
EXPANSION 3	(Displayed data) R-Axis acceleration/deceleration slow down				Display only	
EXPANSION 4	(Displayed data) C-Axis acceleration/deceleration slow down				Display only	
INP PULSE A B	(Displayed data) A, B-Axis In-position pulse				Display only	
INP PULSE B	(Displayed data) A-Axis In-position pulse for expansion				Display only	
INP PULSE Z	(Displayed data) Z-Axis In-position pulse				Display only	
INP PULSE W	(Displayed data) W-Axis In-position pulse				Display only	
EXPANSION 5	(Displayed data) R-Axis In-position pulse				Display only	
EXPANSION 6	(Displayed data) C-Axis In-position pulse				Display only	

25.5.3 RESPONSE

Parameter	Description	Digit	Minimum unit	Standard value	Note	Set value
CPC SPEED	(Displayed data) CPC (interpolation) speed setting				Display only	
CPC F.F.GAIN	(Displayed data) F.F. gain				Display only	
SPLINE SPEED	(Displayed data) Spline speed				Display only	
A-CAL SPEED	(Displayed data) A-CAL speed				Display only	
INCHING SPEED	(Displayed data) Inching speed				Display only	
EXPANSION 1	(Displayed data) A-CAL sequence				Display only	
PTP WEIGHT	(Displayed data) Total work weight				Display only	
EXPANSION 2	(Displayed data) For expansion				Display only	
LOCAL CODINATE	Not used.				Display only	
W AXIS ACCEL	(Displayed data) W-Axis acceleration				Display only	
W AXIS DECEL	(Displayed data) W-Axis deceleration				Display only	
OPTION DATA 1	Option data 1				Display only	
OPTION DATA 2	Option data 2				Display only	
OPTION DATA 3	Option data 3				Display only	
EXPANSION 3	Future expansion				Display only	
EXPANSION 4	Future expansion				Display only	

Appendix

Appendix A I/O Allocation

The following table describes the DI/DO signal allocation and description for each signal during the automatic operation in AUTO mode.

Table A.1 Assignment of DI Signals in AUTO Mode (Standard)

No.	Signal	Function
IN0	SELECT	A-CAL request
IN1	START	Positioning start
IN2	NEXT	Positioning to next address
IN3	HOLD	Not used. (Normally servo lock ON)
IN4	POS/INCH	Select signal from IN6 to IN15 ON : Positioning address signal OFF : Manual operation signal in INCH mode
IN5	STOP	ON : Stop of operation
IN6	ADDRESS 8 [256]/axis	Selecting at "IN4" • Position address designation in binary (in []) at PTP movement. • Signal to manipulate axis at INCHING. IN6: Select signal IN8 to IN11 ON : R and C-Axes OFF : X and Y-Axes IN7 ON : High-speed inching
IN7	ADDRESS 9 [512]/high speed	
IN8	ADDRESS 0 [1] /+X(+R)	
IN9	ADDRESS 1 [2] /-X(-R)	
IN10	ADDRESS 2 [4] /+Y(+C)	
IN11	ADDRESS 3 [8] /-Y(-C)	
IN12	ADDRESS 4 [16] /↑ Z	
IN13	ADDRESS 5 [32] /↓ Z	
IN14	ADDRESS 6 [64] /+W	
IN15	ADDRESS 7 [128] /-W	

Table A.2 Assignment of DO Signals in AUTO Mode (Standard)

DO No.	Signal	Function
OUT0	READY	Ready for automatic operation
OUT1	ERROR	Error indication
OUT2	PCA	Positioning completion acknowledgement
OUT3	AUTO	AUTO mode indication
OUT4	BP·AREA	Pass PTP output or base area position output
OUT5	ZONE	Z-Axis zone output
OUT6	CPOUT /C	CPC movement output
OUT7	A-CAL /R	A-CAL completion
OUT8	MOUT0(1) /W	Output signals assigned by M-data or error code displayed in binary code ().
OUT9	MOUT1(2) /Z	
OUT10	MOUT2(4) /Y	
OUT11	MOUT3(8) /X	
OUT12	MOUT4(10) /	
OUT13	MOUT5(20) /	
OUT14	MOUT6(40) /	
OUT15	MOUT7(80) /	

The MOUT signals are related to the M-data, which is the output pattern to the output port of the robot driver. M-data can be set from 0 to 99 and output in the combinations below (BCD ¹). The first digit is described by the MOUT 0-3 signal and the MOUT 4-7 signal for the second digit.

For example, M-data=15 means the combination of M-data=10 and M-data=5 is output. The blanks in the table mean OFF.

At the END POINT (M-data=?), all of the MOUT signals are ON.

Table A.3 M-Data Output

M-data \ MOUT	0	1	2	3	4	5	6	7
0								
1	ON							
2		ON						
3	ON	ON						
4			ON					
5	ON		ON					
6		ON	ON					
7	ON	ON	ON					
8				ON				
9	ON			ON				
10					ON			
20						ON		
30					ON	ON		
40							ON	
50					ON		ON	
60						ON	ON	
70					ON	ON	ON	
80								ON
90					ON			ON
?? (END POINT)		ON	ON	ON	ON	ON	ON	ON

¹: BCD (Binary-Coded Decimal Notation)

Appendix B Extended AUTO Mode I/O Assignment

To enter extended AUTO mode, set the data by System Generation, 「ORIGIN」→「SET-UP SYSTEM」→「AUTO/ON-LINE」 to “EXT AUTO.” This mode is almost same as the AUTO mode except that the assignment of DI signals. The assignment of DI signals in extended AUTO mode is shown below.

DO signals are same as the signals, which are standard, in AUTO mode.

Table A.4 Assignment of DI Signals in AUTO Mode (Extension)

No.	Signal	Function
IN0	SELECT	Ready for automatic operation
IN1	START	Positioning start
IN2	POS/INCH	Select signal from IN4 to IN15 ON : Positioning address signal OFF : Manual operation signal in INCH mode
IN3	STOP	ON : Stop of operation
IN4	ADDRESS 0[1] /+X	Selecting at “IN2” <ul style="list-style-type: none"> Position address designation in binary (in []) at PTP movement. Signal to manipulate axis at INCHING.
IN5	ADDRESS 1[2] /-X	
IN6	ADDRESS 2[4] /+Y	
IN7	ADDRESS 3[8] /-Y	
IN8	ADDRESS 4[16] /↑ Z	
IN9	ADDRESS 5[32] /↓ Z	
IN10	ADDRESS 6[64] /+W	
IN11	ADDRESS 7[128] /-W	
IN12	ADDRESS 8[256] /+R	
IN13	ADDRESS 9[512] /-R	
IN14	ADDRESS 10[1024] /+C	
IN15	ADDRESS 11[2148] /-C	

Table A.5 Assignment of DO Signals in AUTO Mode (Extension=Standard)

DO No.	Signal	Function
OUT0	READY	Ready for automatic operation
OUT1	ERROR	Error indication
OUT2	PCA	Positioning completion acknowledgement
OUT3	AUTO	AUTO mode indication
OUT4	BP·AREA	Pass PTP output or base area position output
OUT5	ZONE	Z-Axis zone output
OUT6	CPOUT /C	CPC movement output
OUT7	A-CAL /R	A-CAL completion
OUT8	MOUT0(1) /W	Output signals assigned by M-data or error code displayed in binary code ().
OUT9	MOUT1(2) /Z	
OUT10	MOUT2(4) /Y	
OUT11	MOUT3(8) /X	
OUT12	MOUT4(10) /	
OUT13	MOUT5(20) /	
OUT14	MOUT6(40) /	
OUT15	MOUT7(80) /	

Appendix C Error Code

When an error occurs in the controller during automatic operation, error message are displayed on the Teach Pendant (Refer to 23.3, “Error Message.”) and the error codes below are outputs to external devices simultaneously.

Table A.6 Error Code to the External Devices

Error Message	Description	Output Code	
		AUTO Mode	ON-LINE Mode
A-CAL ERR *0 Not Find A-CAL ERR *1 Not Off A-CAL ERR *2 Other On A-CAL ERR *3 Not Zero A-CAL ERR *4 Lower A-CAL ERR *5 Upper A-CAL ERR *6 Minus A-CAL ERR *7 Error	A-CAL is not executed normally.	2#	20
ADDRESS ERROR	The value for the input or motion address is out of range in the system data, 「ADDRESS MAX」 ¹ .	30	30
AREA ERROR *****	The designated value is out of the operational area of the robot.	4#	40
CPU LOW BATTERY	Battery voltage on the CPU board becomes low.	70	70
DRIVER ERROR *****	Error is occurred in the servo amplifier/driver.	A#	A#
DRIVER NOT ONLINE	Servo amplifier/driver disconnection	A0	A0
DRIVER TIME OUT	Servo amplifier/driver disconnection	A0	A0
ENC BATTERY *****	Encoder battery voltage becomes low.	7#	7#
EMERGENCY STOP	Inputted Emergency Stop signal.	10	10
OVERRUN *****	The robot is in overrun area.	5#	5#
POS.ERROR *****	Positioning is not completed even the robot reached at the target position. Excessive load Excessive acceleration/deceleration Improper adjustment for the servo amplifier/driver.	0#	09
POSITION DATA ERROR	Reading data from the memory card is failed during automatic operation.	64	64
POSITIONING ERROR	Positioning is not able to performed.	96	96
SERVO DATA ERROR	Servo parameters are abnormal or not be entered.	67	67
SERVO ON ERROR	Unable to be in servo lock condition	B0	B0
STATUS ERROR	Internal processing error. Error which is not supported is occurred. Contact your distributor.	16	16
SYSTEM DATA ERROR	System data is corrupted.	63	63
SYSTEM ERROR	Internal processing error.	68	68

#:Axis ***** : Axis status

¹: System Generation, 「LIMIT」→「ADDRESS MAX」→「ADDRESS MAX」

Appendix D Motor Code

Preprogrammed motor code parameters set to system configuration are shown below.

Table A.7 Motor Code Table

Motor Code Decimal	Amp	Motor Part #	Motor Power	Max.Rev. (rpm)	Motor Code Decimal	Amp	Motor Part #	Motor Power	Max.Rev. (rpm)	
32	15A	65ZBM001D	30	4500	96	50A	65ZBM030D	750	4500	
33		65ZBM002D	50	4500	97		65ZBM040D	1000	4500	
34		65ZBM003D	100	4500	98		68ZBM065H	1200	3000	
35		65ZBM007D	180	4500	99		68ZBM090H	1600	3000	
36		65ZBM010D	300	4500	100		P50B08075D	750	4500	
37		68ZBM025H	480	3000	101		P50B08100D	1000	4500	
38		P50B03003D	30	4500	102		61BM090B	1400	2000	
39		P50B04006D	60	4500	103		61BM120B	2000	2000	
40		P50B04010D	100	4500	104		P80B18120H	1200	3000	
41		P50B05005D	50	4500	105		P60B13100H	1000	3000	
42		P50B05010D	100	4500	106		P60B13150H	1500	3000	
43		P50B05020D	200	4500						
44		P50B07010D	100	4500						
45		P50B07020D	200	4500	128		100A	68ZBM140H	2500	3000
46		P50B07030D	300	4500	129			68ZBM220R	3600	2500
47		P30B04003D	30	4500	130			61BM220B	3300	2000
48		P30B04005D	50	4500	131			61BM330B	4500	2000
49		P30B04010D	100	4500	132			P80B22250H	2500	3000
50		P30B06020D	200	4500	133			P80B22350R	3500	2500
51		P30B06010D			134			P60B13200H	2000	3000
					135			P60B18200H	2000	3000
64	30A	65ZBM014D	400	4500		150A				
65		65ZBM020D	500	4500						
66		65ZBM030H	750	3000						
67		65ZBM040H	1000	3000	160		68ZBM330R	4500	2500	
68		68ZBM035H	660	3000	161		61BM470M	5200	1500	
69		P50B07040D	400	4500	162		P80B22350H	3500	3000	
70		P50B08040D	400	4500	163		P80B22450R	4500	2500	
71		P50B08050D	500	4500	164		P60B15300H	3000	3000	
72		P50B08075H	750	3000	165		P60B18350H	3500	3000	
73		P50B08100H	1000	3000	166		P60B18450R	4500	2500	
74		P30B06040D	400	4500	167		P60B22550M	5500	1500	
75		P30B08075D	750	4500	168		P60B22700S	7000	1000	
76		61BM030B	500	2000	169		P60B18550R	5500	2500	
77		61BM060B	1000	2000	170		P60B22700M	7000	1500	
78		P80B15075H	750	3000						
79	P60B13050H	500	3000							

Appendix E Data Backup and Data Load

Table A. 8 Back Up and Data Load

Data	Stored Location	Backup	Default Value Setting	Data Load
System Data (System Generation, System Parameters)	RAM	Memory card	Refer to Chapter 21, "Initializing System Data."	Download from the memory card.
Servo Parameters	RAM	Memory card	Refer to Chapter 21, "Initializing System Data."	Download from the memory card.
Position data	RAM	Memory card	Refer to Chapter 22, "Initializing Position Data."	Download from the memory card.
Configuration	EE-PROM	None	None	Replace EE-PROM.