

Dimensions

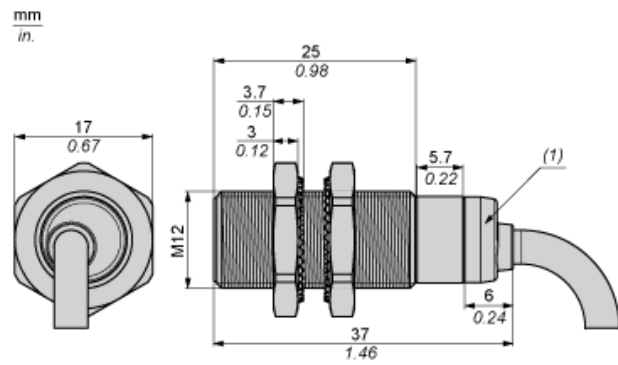

(1) LED

Minimum Mounting Distances

Side by side



e (1) \geq 8 mm/0.31 in.

Face to face



e (2) \geq 8 mm/1.89 in.

Facing a metal object



e (3) \geq 2 mm/0.47 in.