

Intelligent Power Module (R-Series)

Maximum Ratings and Characteristics

Absolute Maximum Ratings (T_c=25°C)

Items	Symbols	Ratings		Units
		Min.	Max.	
DC Bus Voltage	V _{DC}	0	450	V
DC Bus Voltage (surge)	V _{DC(Surge)}	0	500	
DC Bus Voltage (short operating)	V _{SC}	200	400	
Collector-Emitter Voltage	V _{CES}	0	600	
Inverter Collector	Continuous	I _C	150	A
	1ms	I _{CP}	300	
	Duty=58.8%	-I _C	150	
Collector Power Dissipation One Transistor	P _C		595	W
Voltage of Power Supply for Driver	V _{CC} *1	0	20	V
Input Signal Voltage	V _{IN} *2	0	V _Z	V
Input Signal Current	I _{IN}		1	mA
Alarm Signal Voltage	V _{ALM} *3	0	V _{CC}	V
Alarm Signal Current	I _{ALM} *4		15	mA
Junction Temperature	T _J		150	°C
Operating Temperature	T _{OP}	-20	100	
Storage Temperature	T _{stg}	-40	125	
Isolation Voltage A.C. 1min.	V _{iso}		2500	
Screw Torque	Mounting *1		3.5	Nm
	Terminals *1		3.5	

Note: *1: Recommendable Value; 2.5 - 3.0 Nm (M5)

Outline Drawing

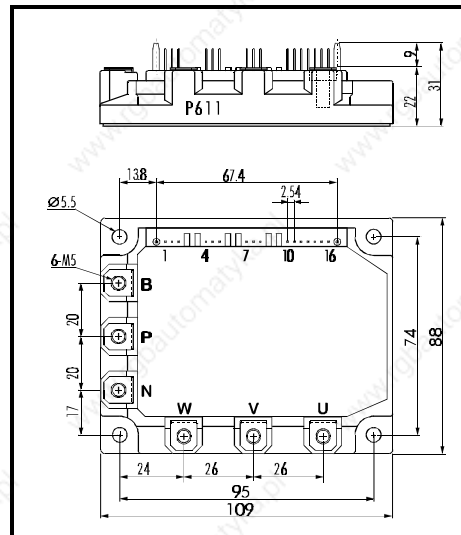

Fig. 1

Electrical Characteristics of Power Circuit (at T_J=25°C, V_{CC}=15V)

Items	Symbols	Conditions	Min.	Typ.	Max.	Units
INV	Collector Current At Off Signal Input	I _{CES}	V _{CE} =600V, Input Terminal Open		1.0	mA
	Collector-Emitter Saturation Voltage	V _{CE(Sat)}	I _C =150A		2.8	V
	Forward Voltage of FWD	V _F	-I _C =150A		3.0	V

Electrical Characteristics of Control Circuit (at T_J=25°C, V_{CC}=15V)

Items	Symbols	Conditions	Min.	Typ.	Max.	Units
Current of P-Line Side Driver (One Unit)	I _{CCP}	f _{SW} =0~15kHz, T _C =-20~100°C	3		18	mA
Current of N-Line Side Driver (Three Units)	I _{CCN}	f _{SW} =0~15kHz, T _C =-20~100°C	10		65	
Input Signal Threshold Voltage	V _{IN(th)}	On	1.00	1.35	1.70	V
		Off	1.25	1.60	1.95	
Input Zener Voltage	V _Z	R _{IN} =20kΩ		8.0		
Over Heating Protection Temperature Level	T _{COH}	V _{DC} =0V, I _C =0A, Case Temp.	110		125	°C
Hysteresis	T _{CH}			20		
IGBT Chips Over Heating Protec. Temp. Level	T _{IOH}	Surface of IGBT Chip	150			
Hysteresis	T _{IH}			20		
Inverter Collector Current Protection Level	I _{OC}	T _J =125°C	225			A
Over Current Detecting Time	t _{DOC}	T _J =25°C		10		μs
Alarm Signal Hold Time	t _{ALM}		1.5	2		ms
Limiting Resistor for Alarm	R _{ALM}		1425	1500	1575	Ω
Under Voltage Protection Level	V _{UV}		11.0		12.5	V
Hysteresis	V _H		0.2			

Dynamic Characteristics (at T_C=T_J=125°C, V_{CC}=15V)

Items	Symbols	Conditions	Min.	Typ.	Max.	Units
Switching Time	t _{ON}	I _C =150A, V _{DC} =300V	0.3			μs
	t _{OFF}				3.6	
	t _{RR}	I _F =150A, V _{DC} =300V			0.4	

Thermal Characteristics

Items	Symbols	Conditions	Min.	Typ.	Max.	Units
Thermal Resistance	R _{th(l-c)}	Inverter IGBT			0.21	°C/W
	R _{th(l-c)}	Diode			0.47	
	R _{th(c-f)}	With Thermal Compound		0.05		

■ Equivalent Circuit

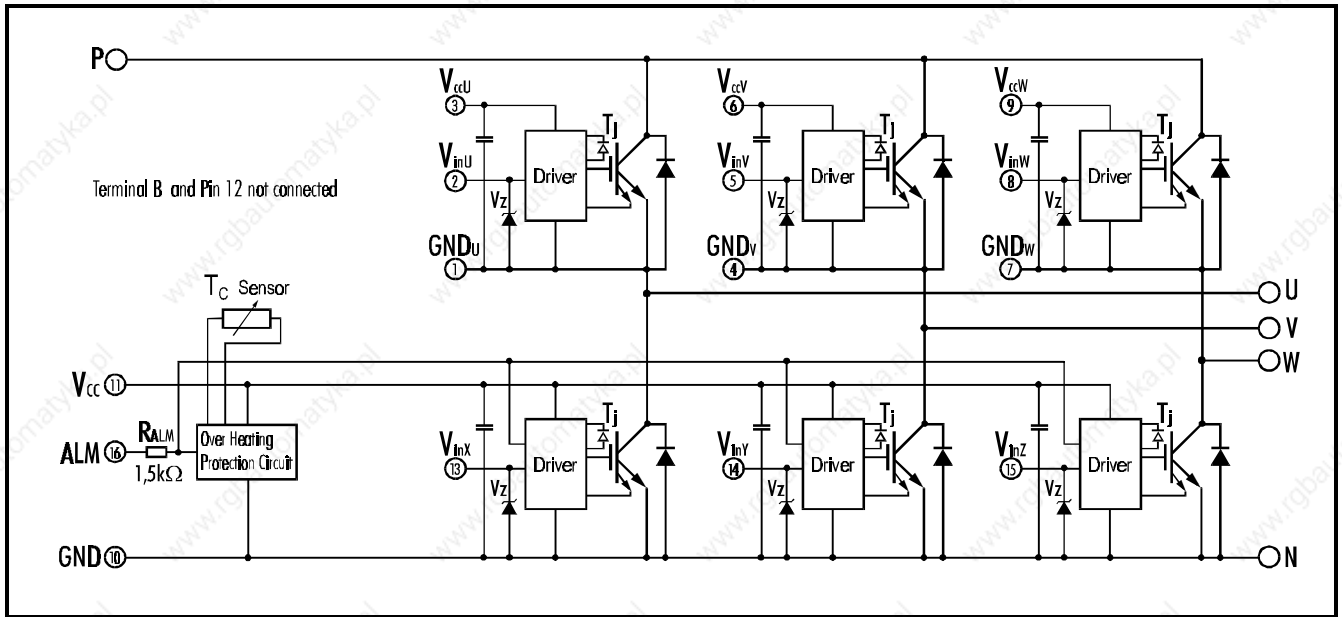

Drivers include following functions

- Short circuit protection circuit
- Amplifier for driver
- Undervoltage protection circuit
- Overcurrent protection circuit
- IGBT Chip overheating protection

Control Circuit

Power Supply Current vs. Switching Frequency

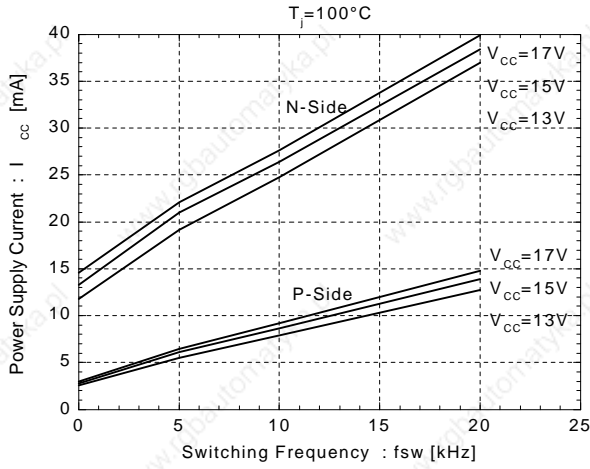

Input Signal Threshold Voltage vs. Power Supply Voltage

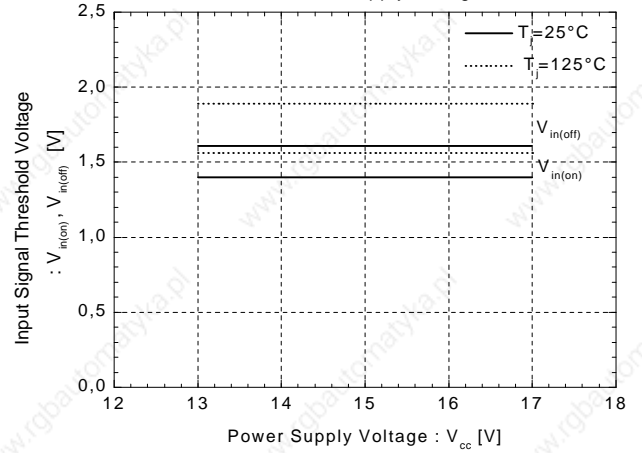

Under Voltage vs. Junction Temperature

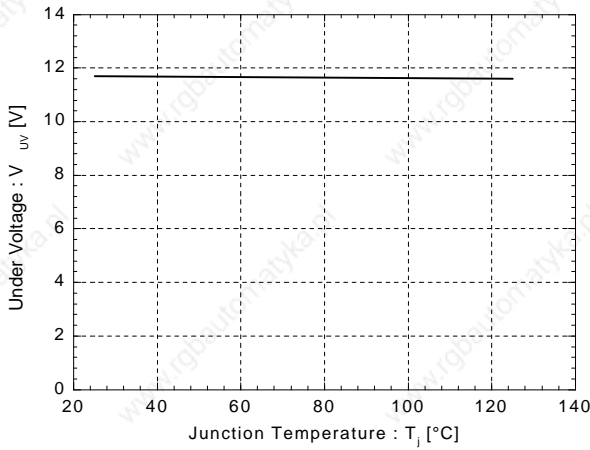

Under Voltage Hysteresis vs. Junction Temperature

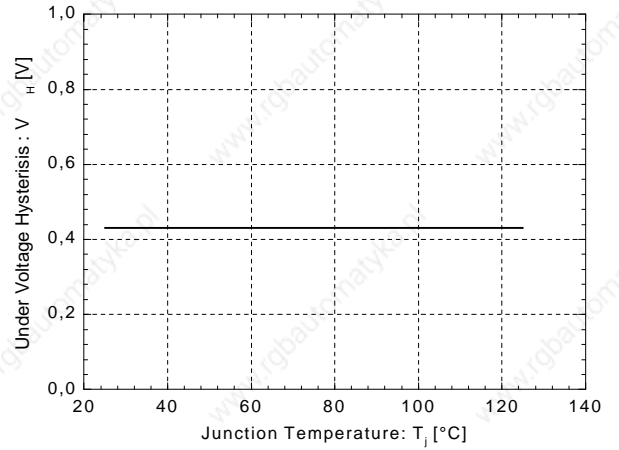

Alarm Hold Time vs. Power Supply Voltage

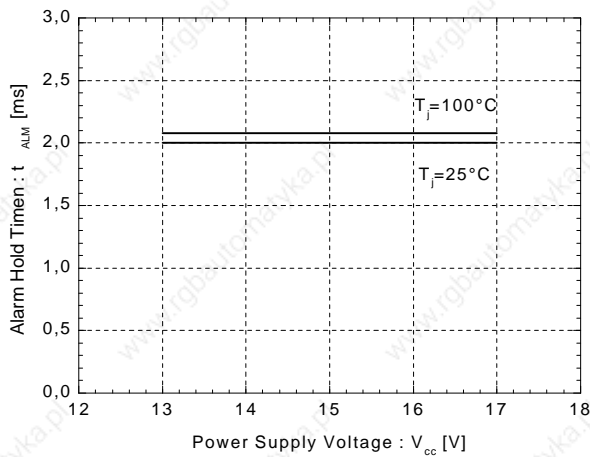

Over Heating Characteristics

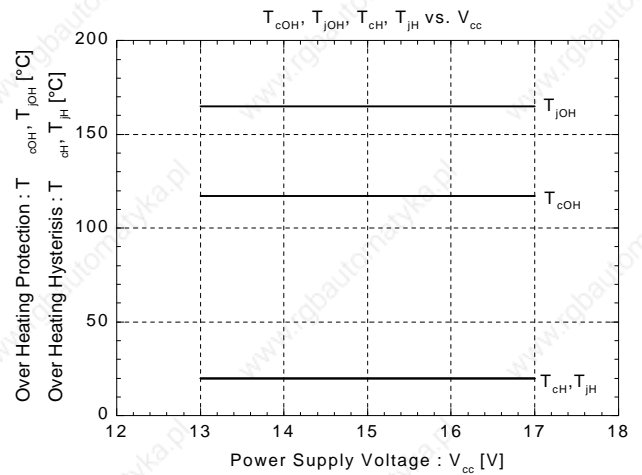

Inverter

Collector Current vs. Collector-Emitter Voltage

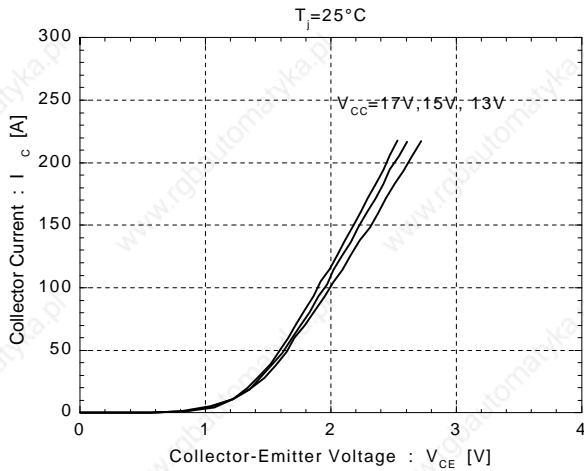

Collector Current vs. Collector-Emitter Voltage

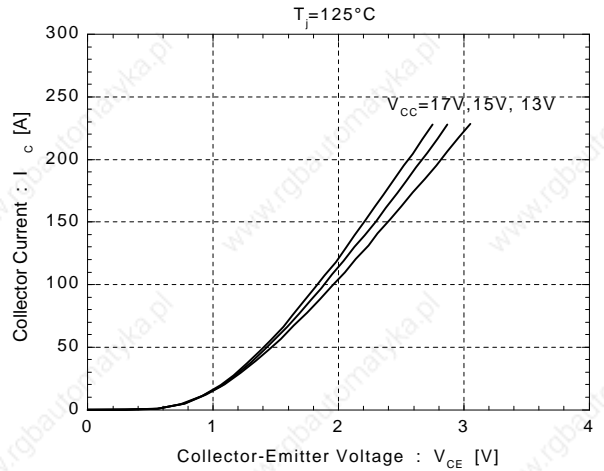

Switching Time vs. Collector Current

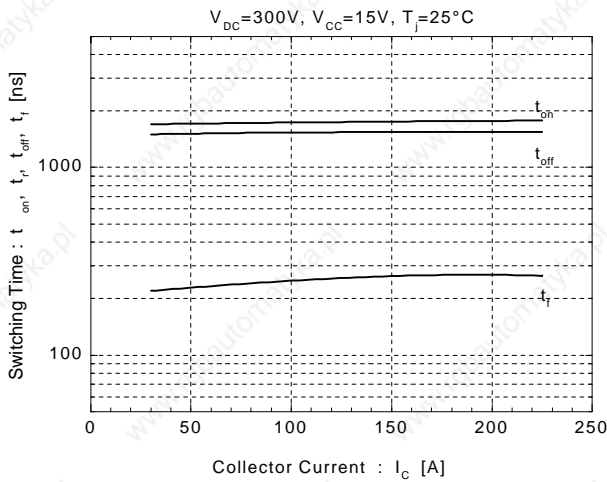

Switching Time vs. Collector Current

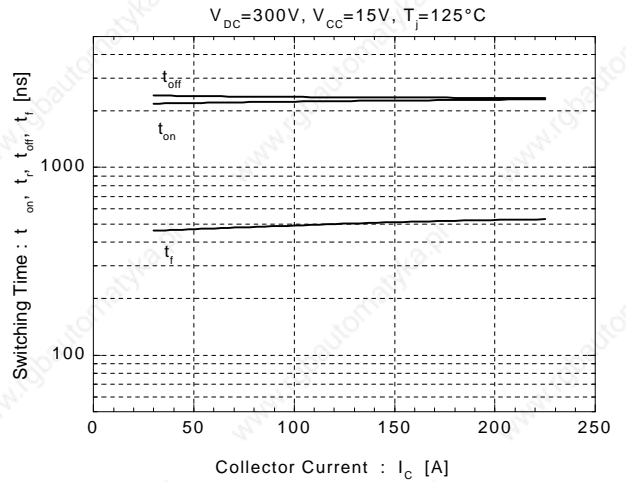

Forward Voltage vs. Forward Current

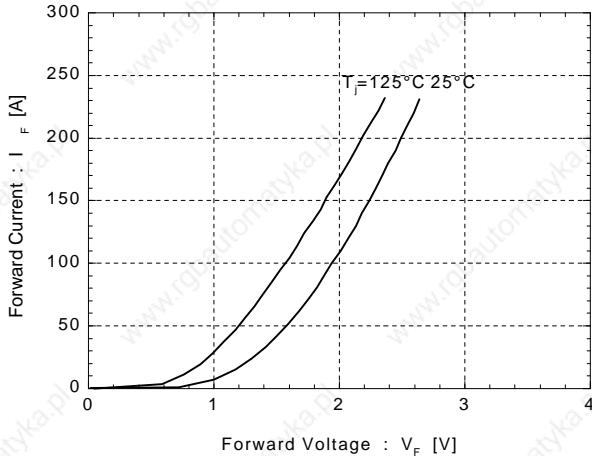

Reverse Recovery Characteristics

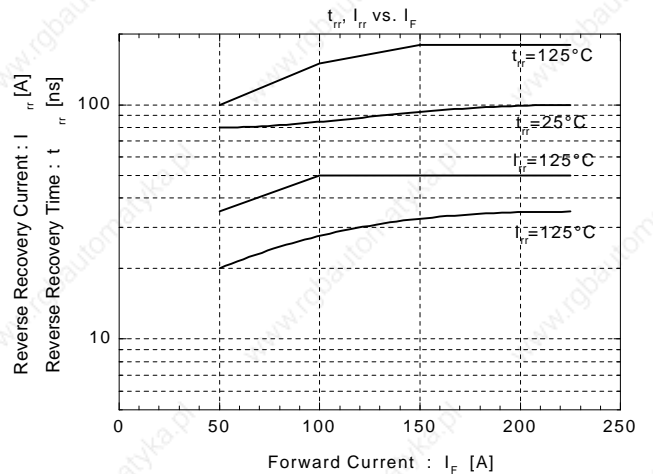

Transient Thermal Resistance

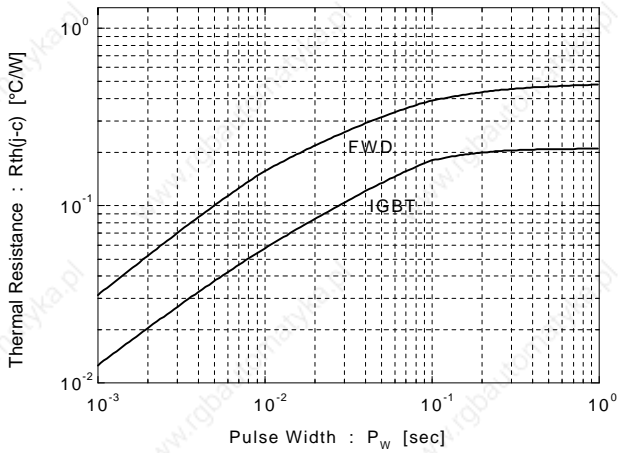

Reverse Biased Safe Operating Area

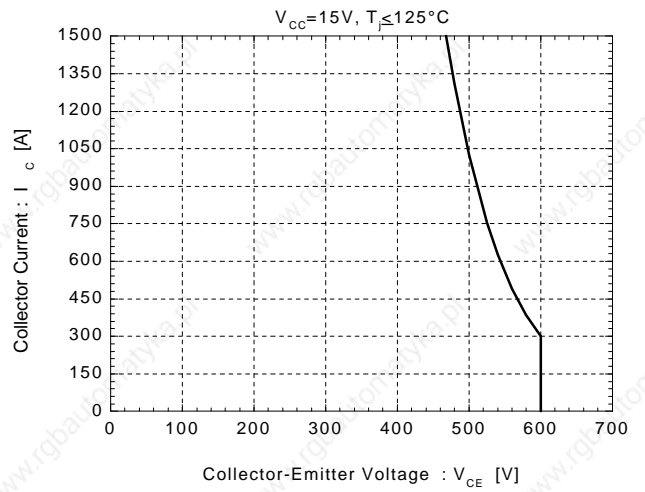

Power Derating For IGBT
(per device)

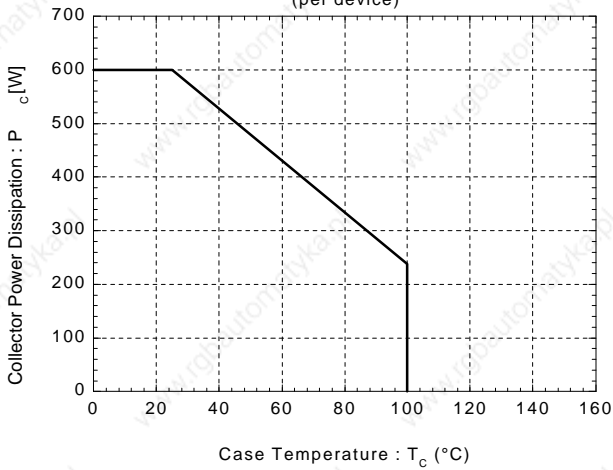

Power Derating For FWD
(per device)

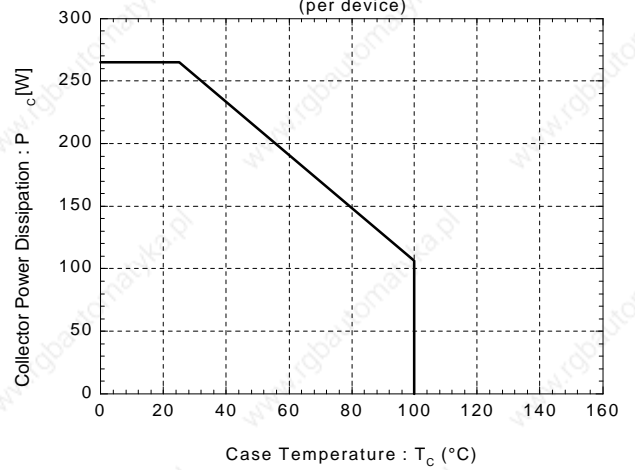

Switching Loss vs. Collector Current

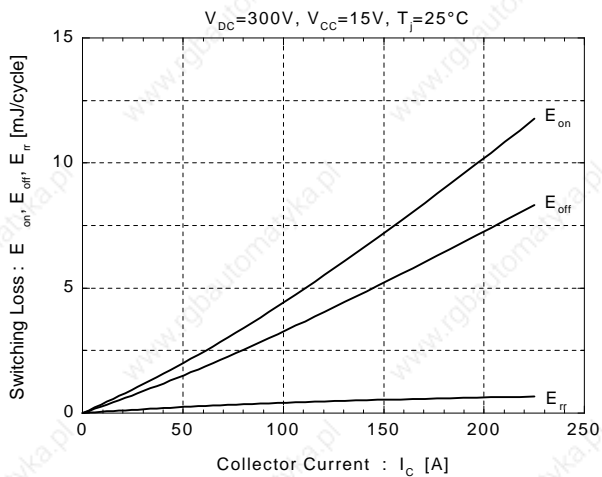

Switching Loss vs. Collector Current

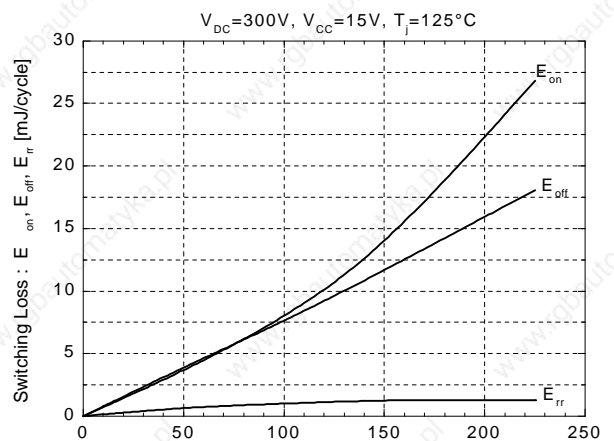

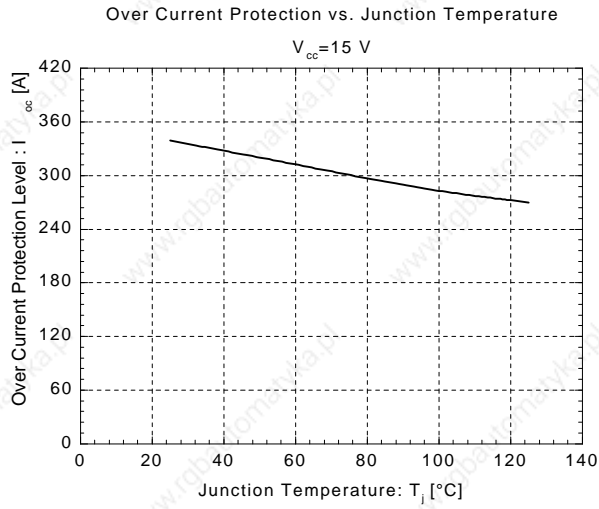

■ Outline Drawing

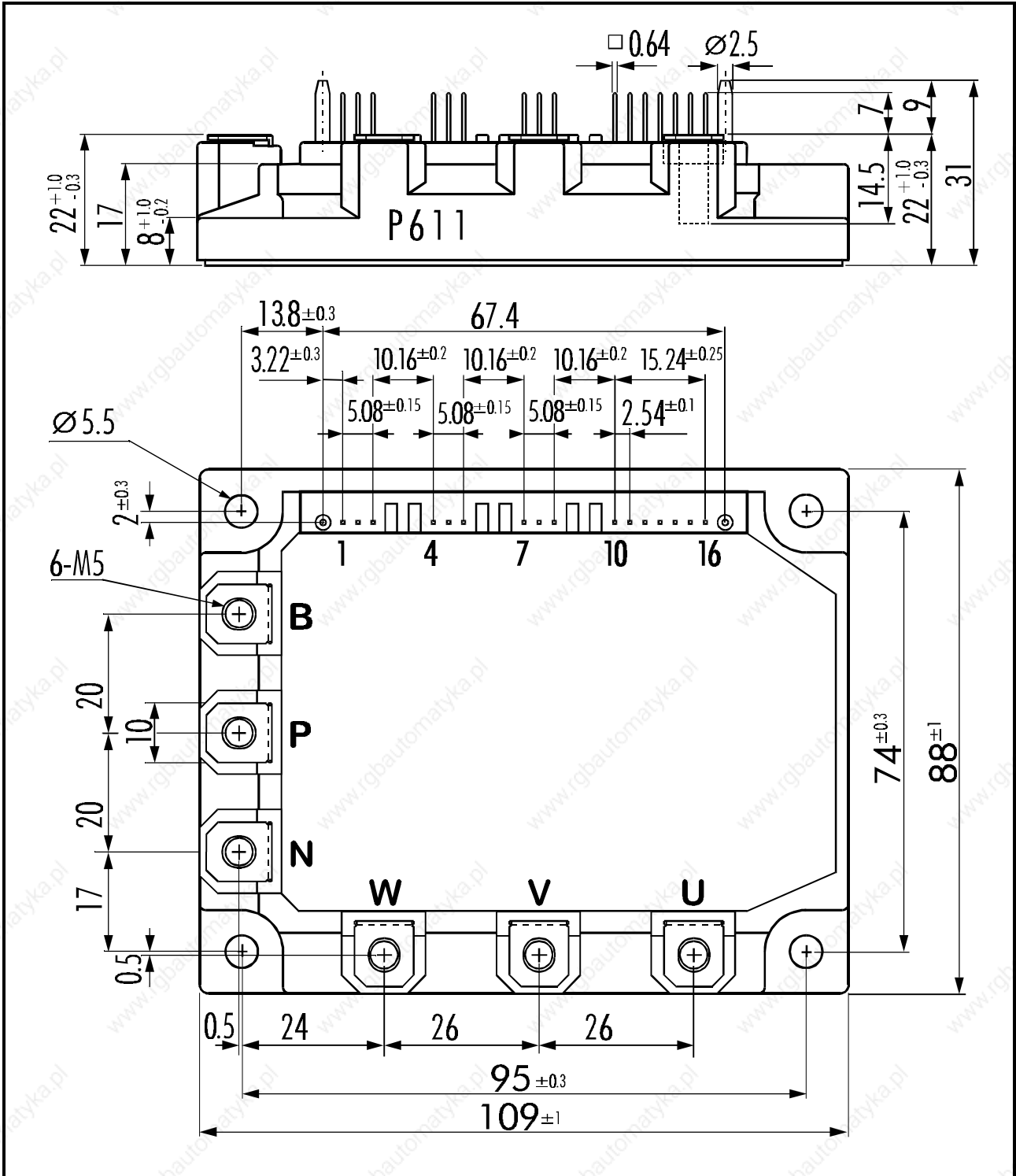

Weight: 440g

This datasheet has been download from:

www.datasheetcatalog.com

Datasheets for electronics components.