





Contents

Panorama 16/2, 16/3

Ordering Details

A9 ... A 110 3-pole Contactors, a.c. Coil 16/4
 A 145 ... AF 750 3-pole Contactors, a.c. Coil 16/5
 Accessories for A9 ... A 110 3-pole Contactors 16/6
 Accessories for A 145 ... AF 750 3-pole Contactors 16/8
 TA.. Thermal O/L Relays for A9 ... A 110 Contactors 16/12
 TA.. Thermal O/L Relays and E... Electronic O/L Relays for A 145 ... AF750 Contactors 16/13

A9 ... A 75 4-pole Contactors, a.c. Coil 16/14
 EK 110 ... EK 1000 4-pole Contactors, a.c. Coil 16/15
 Accessories for A.. 4-pole Contactors 16/16
 Accessories for EK.. 4-pole Contactors 16/17

N.. Contactor Relays, a.c. Coil 16/18
 Accessories for N.. Contactor Relays 16/19

DLA Starters, a.c. Coil 16/20
 YKA., YDA.. Open Type Star-Delta Starters, a.c. Coil 16/22
 VOA., VNA.. Open Type Reversing Contactors, a.c. Coil 16/24
 VOA.-40Z Open Type Changeover Contactors, a.c. Coil 16/26

Contact Sets - Coils 16/28

Technical Data

Motor Rating and Rated Current 16/29
 Technical Data, A9 ... A 110 3-pole Contactors 16/30
 Technical Data, A 145 ... AF 750 3-pole Contactors 16/31
 Technical Data, A9 ... A 75 4-pole Contactors 16/32
 Technical Data, EK 110 ... EK 1000 4-pole Contactors 16/33
 Coil Voltages and Codes 16/34

Conversion Tables from B.. / EH.. Series to A.. Series 16/36

Dimensions and Wiring Diagrams 16/38 ... 16/55



Power rating AC-3, 400 V

Types

Order code (State coil voltage)

Rated current AC-3, 400 V
415 V
690 V

Rated current AC-1, 40 °C

3-pole



	4kW	5.5kW	7.5kW	11kW	15kW	18.5kW	22kW	30kW	37kW
	A9	A12	A16	A26	A30	A40	A50	A63	A75
A 9-30-10	9	12	17	26	32	37	50	65	75
A 12-30-10	9	12	17	26	32	37	50	65	75
A 16-30-10	7	9	10	17	21	25	35	43	46
A	25	27	30	45	55	60	100	115	125

O/L relays

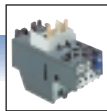

TA 25 DU	0.4 ... 0.63	2.2...3.1	7.5...11	TA 42 DU	TA 75 DU
0.10...0.16	0.63...1.0	2.8...4.0	10...14	22...32	29...42
0.16...0.25	1.0 ...1.4	3.5...5.0	13...19	29...42	36...52
0.25...0.4	1.3 ...1.8	4.5...6.5	18...25		45...63
	1.7 ...2.4	6.0...8.5	24...32		60...80

Auxiliary contacts

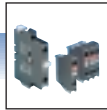

Front mounting 1 NO CA 5-10 1 NC CA 5-01
Side mounting 1 NO + 1 NC CAL 5-11

Timers



Pneumatic direct 0.1 ... 40 s TP 40 DA 10 ... 180 s TP 180 DA
Pneumatic inverse 0.1 ... 40 s TP 40 IA 10 ... 180 s TP 180 IA

Interlocks

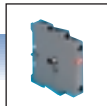

Mechanical / electrical VE 5-1

Mechanical /

Surge suppressors



RV 5/50
24 ... 50 V

RV 5/133
50 ... 133 V

RV 5/250
110 ... 250 V



Rated current AC-1, 40 °C

Types

Order code (State coil voltage)

4-pole



	25 A	30 A	45 A	70 A	100 A
	A9	A16	A26	A45	A50
A9-40-00					
A16-40-00					
A26-40-00					
A45-40-00					
A50-40-00					



45kW	55kW
A95	A110
A 95-30-00	A 110-30-00
96	110
96	110
65	82
145	160

3-pole



A
A
A
A

75kW	90kW
A145	A185
A 145-30-11	A 185-30-11
145	185
145	185
120	170
250	275

110kW	140kW	160kW
A210	A260	A300
A 210-30-11	A 260-30-11	A 300-30-11
210	260	300
210	260	300
210	220	280
350	400	500

200kW	250kW
AF400	AF460
AF 400-30-11	AF 460-30-11
400	460
400	460
350	400
600	700

315kW	400kW
AF580	AF750
AF 580-30-11	AF 750-30-11
580	750
580	700
500	650
800	1050

TA 80 DU	TA 110 DU
60...80	65...90
	80...110



TA 200 DU	130 ... 175
	150 ... 200
E 200 DU	65 ... 200

TA 450 DU	165 ... 235
	220 ... 310
E 320 DU	105 ... 320

E 500 DU	170 ... 500
----------	-------------

E 800 DU	270 ... 800
----------	-------------

Side mounting 1 NO + 1 NC CAL 5-11, CAL 5-11B

Electronic TE5S

Electronic TE5S

(Interpose an N contactor relay for AF 580, AF750)

electrical VE 5-2

Mechanical VM 300H

Mechanical VM 750H

RV 5/440
250 ... 440 V



RV 5-2/50	RV 5-2/133	RV 5-2/250	RV 5-2/440
24 ... 50 V	50 ... 133 V	110 ... 250 V	250 ... 440 V

The built-in coil interface eliminates the need of extra surge suppressors on these sizes



125 A

A75

A75-40-00

4-pole



200 A	250 A
EK110	EK150
EK110-40-11	EK150-40-11

300 A	350 A
EK175	EK210
EK175-40-11	EK210-40-11

550 A	800 A	1000 A
EK370	EK550	EK1000
EK370-40-11	EK550-40-11	EK1000-40-11



A 3-pole Contactors - a.c. Coil

Ordering Details



A 9-30-10



A 26-30-10



A 50-30-00



A 95-30-00

Rated operational current AC-3 380 V 400 V 415 V A	AC-1 $\theta \leq 40^\circ\text{C}$ A	Aux. contacts fitted		Type	Order code	Weight kg	Pack ^{ing} 1 piece
		1 st stack	2 nd stack				
9	25	1	-	A 9-30-10	1SBL 14 1001 R□□10	0.340	
		-	1	A 9-30-01	1SBL 14 1001 R□□01		
		-	2	A 9-30-22	1SBL 14 1001 R□□22		
		1	2	A 9-30-32	1SBL 14 1001 R□□32		
12	27	1	-	A 12-30-10	1SBL 16 1001 R□□10	0.340	
		-	1	A 12-30-01	1SBL 16 1001 R□□01		
		-	2	A 12-30-22	1SBL 16 1001 R□□22		
		1	2	A 12-30-32	1SBL 16 1001 R□□32		
17	30	1	-	A 16-30-10	1SBL 18 1001 R□□10	0.340	
		-	1	A 16-30-01	1SBL 18 1001 R□□01		
		-	2	A 16-30-22	1SBL 18 1001 R□□22		
		1	2	A 16-30-32	1SBL 18 1001 R□□32		
26	45	1	-	A 26-30-10	1SBL 24 1001 R□□10	0.600	
		-	1	A 26-30-01	1SBL 24 1001 R□□01		
		-	2	A 26-30-22	1SBL 24 1001 R□□22		
		1	2	A 26-30-32	1SBL 24 1001 R□□32		
32	55	1	-	A 30-30-10	1SBL 28 1001 R□□10	0.710	
		-	1	A 30-30-01	1SBL 28 1001 R□□01		
		1	2	A 30-30-32	1SBL 28 1001 R□□32		
37	60	1	-	A 40-30-10	1SBL 32 1001 R□□10	0.710	
		-	1	A 40-30-01	1SBL 32 1001 R□□01		
		1	2	A 40-30-32	1SBL 32 1001 R□□32		
50	100	-	-	A 50-30-00	1SBL 35 1001 R□□00	1.160	
		1	1	A 50-30-11	1SBL 35 1001 R□□11		
		-	2	A 50-30-22	1SBL 35 1001 R□□22		
65	115	-	-	A 63-30-00	1SBL 37 1001 R□□00	1.160	
		1	1	A 63-30-11	1SBL 37 1001 R□□11		
		-	2	A 63-30-22	1SBL 37 1001 R□□22		
75	125	-	-	A 75-30-00	1SBL 41 1001 R□□00	1.160	
		1	1	A 75-30-11	1SBL 41 1001 R□□11		
		-	2	A 75-30-22	1SBL 41 1001 R□□22		
96	145	-	-	A 95-30-00	1SFL 43 1001 R□□00	2.000	
		1	1	A 95-30-11	1SFL 43 1001 R□□11		
		-	2	A 95-30-22	1SFL 43 1001 R□□22		
110	160	-	-	A 110-30-00	1SFL 45 1001 R□□00	2.000	
		1	1	A 110-30-11	1SFL 45 1001 R□□11		
		-	2	A 110-30-22	1SFL 45 1001 R□□22		

Coil voltages and codes A 9 ... A 110

Voltage (V) 50 Hz : □□	Voltage (V) 60 Hz : □□	Voltage code : □ □
24	24	□ 1
48	48	□ 3
110	110	□ 4
220 ... 230	230...240	□ 0
230 ... 240	240...260	□ 8
380 ... 400	400...415	□ 5
400 ... 415	415...440	□ 6

Other voltages : page 16/34.

>> Accessories page 16/6
>> Thermal O/L relays page 16/12

>> Technical data page 16/30
>> Dimensions pages 16/38 ... 16/40

A/AF 3-pole Contactors - a.c. Coil

Ordering Details

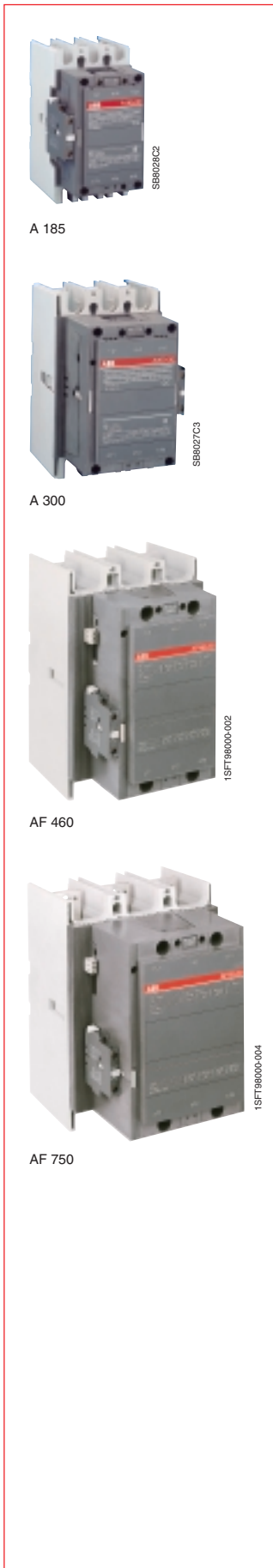

Rated operational current AC-3 380 V 400 V 415 V A	AC-1 $\theta \leq 40^\circ\text{C}$ A	Auxiliary contacts fitted 	Type	Order code	Weight kg	Pack ^{ing} 1 piece
145	250	1 1 2 2	A 145-30-11 <input type="checkbox"/> <input type="checkbox"/>	1SFL 47 1001 R <input type="checkbox"/> <input type="checkbox"/> 11	3.500	
			A 145-30-22 <input type="checkbox"/> <input type="checkbox"/>	1SFL 47 1001 R <input type="checkbox"/> <input type="checkbox"/> 22		
185	275	1 1 2 2	A 185-30-11 <input type="checkbox"/> <input type="checkbox"/>	1SFL 49 1001 R <input type="checkbox"/> <input type="checkbox"/> 11	3.500	
			A 185-30-22 <input type="checkbox"/> <input type="checkbox"/>	1SFL 49 1001 R <input type="checkbox"/> <input type="checkbox"/> 22		
210	350	1 1 2 2	A 210-30-11 <input type="checkbox"/> <input type="checkbox"/>	1SFL 51 1001 R <input type="checkbox"/> <input type="checkbox"/> 11	6.100	
			A 210-30-22 <input type="checkbox"/> <input type="checkbox"/>	1SFL 51 1001 R <input type="checkbox"/> <input type="checkbox"/> 22		
260	400	1 1 2 2	A 260-30-11 <input type="checkbox"/> <input type="checkbox"/>	1SFL 53 1001 R <input type="checkbox"/> <input type="checkbox"/> 11	6.100	
			A 260-30-22 <input type="checkbox"/> <input type="checkbox"/>	1SFL 53 1001 R <input type="checkbox"/> <input type="checkbox"/> 22		
305	500	1 1 2 2	A 300-30-11 <input type="checkbox"/> <input type="checkbox"/>	1SFL 55 1001 R <input type="checkbox"/> <input type="checkbox"/> 11	6.100	
			A 300-30-22 <input type="checkbox"/> <input type="checkbox"/>	1SFL 55 1001 R <input type="checkbox"/> <input type="checkbox"/> 22		
400	600	1 1 2 2	AF 400-30-11 <input type="checkbox"/> <input type="checkbox"/>	1SFL 57 7001 R <input type="checkbox"/> <input type="checkbox"/> 11	12.000	
			AF 400-30-22 <input type="checkbox"/> <input type="checkbox"/>	1SFL 57 7001 R <input type="checkbox"/> <input type="checkbox"/> 22		
460	700	1 1 2 2	AF 460-30-11 <input type="checkbox"/> <input type="checkbox"/>	1SFL 59 7001 R <input type="checkbox"/> <input type="checkbox"/> 11	12.000	
			AF 460-30-22 <input type="checkbox"/> <input type="checkbox"/>	1SFL 59 7001 R <input type="checkbox"/> <input type="checkbox"/> 22		
580	800	1 1 2 2	AF 580-30-11 <input type="checkbox"/> <input type="checkbox"/>	1SFL 61 7001 R <input type="checkbox"/> <input type="checkbox"/> 11	15.000	
			AF 580-30-22 <input type="checkbox"/> <input type="checkbox"/>	1SFL 61 7001 R <input type="checkbox"/> <input type="checkbox"/> 22		
750	1050	1 1 2 2	AF 750-30-11 <input type="checkbox"/> <input type="checkbox"/>	1SFL 63 7001 R <input type="checkbox"/> <input type="checkbox"/> 11	15.000	
			AF 750-30-22 <input type="checkbox"/> <input type="checkbox"/>	1SFL 63 7001 R <input type="checkbox"/> <input type="checkbox"/> 22		

Coil voltages and codes A 145 ... A 300

Voltage (V) 50 Hz : <input type="checkbox"/> <input type="checkbox"/>	Voltage (V) 60 Hz : <input type="checkbox"/> <input type="checkbox"/>	Voltage code : <input type="checkbox"/> <input type="checkbox"/>
24	24	<input type="checkbox"/> 8 <input type="checkbox"/> 1
48	48	<input type="checkbox"/> 8 <input type="checkbox"/> 3
110	110	<input type="checkbox"/> 8 <input type="checkbox"/> 4
220 ... 230	230...240	<input type="checkbox"/> 8 <input type="checkbox"/> 6
230 ... 240	240...260	<input type="checkbox"/> 8 <input type="checkbox"/> 8
380 ... 400	400...415	<input type="checkbox"/> 8 <input type="checkbox"/> 5
400 ... 415	480	<input type="checkbox"/> 5 <input type="checkbox"/> 1

Other voltages : page 16/34.

Coil voltages and codes AF 400 ... AF 750

Voltage (V) 50...60 Hz : <input type="checkbox"/> <input type="checkbox"/>	Voltage (V) DC <input type="checkbox"/> <input type="checkbox"/>	Voltage code : <input type="checkbox"/> <input type="checkbox"/>
-	24 ... 60	<input type="checkbox"/> 6 <input type="checkbox"/> 8
48...130	48...130 ¹⁾	<input type="checkbox"/> 6 <input type="checkbox"/> 9
100...250	100...250	<input type="checkbox"/> 7 <input type="checkbox"/> 6
200...500	200...500 ¹⁾	<input type="checkbox"/> 7 <input type="checkbox"/> 1

1) Available after 2001

>> Accessories page 16/8 >> Technical data page 16/31
 >> Thermal O/L relays page 16/13 >> Dimensions pages 16/40 ... 16/44

Accessories for A9 ... A110 3-pole Contactors

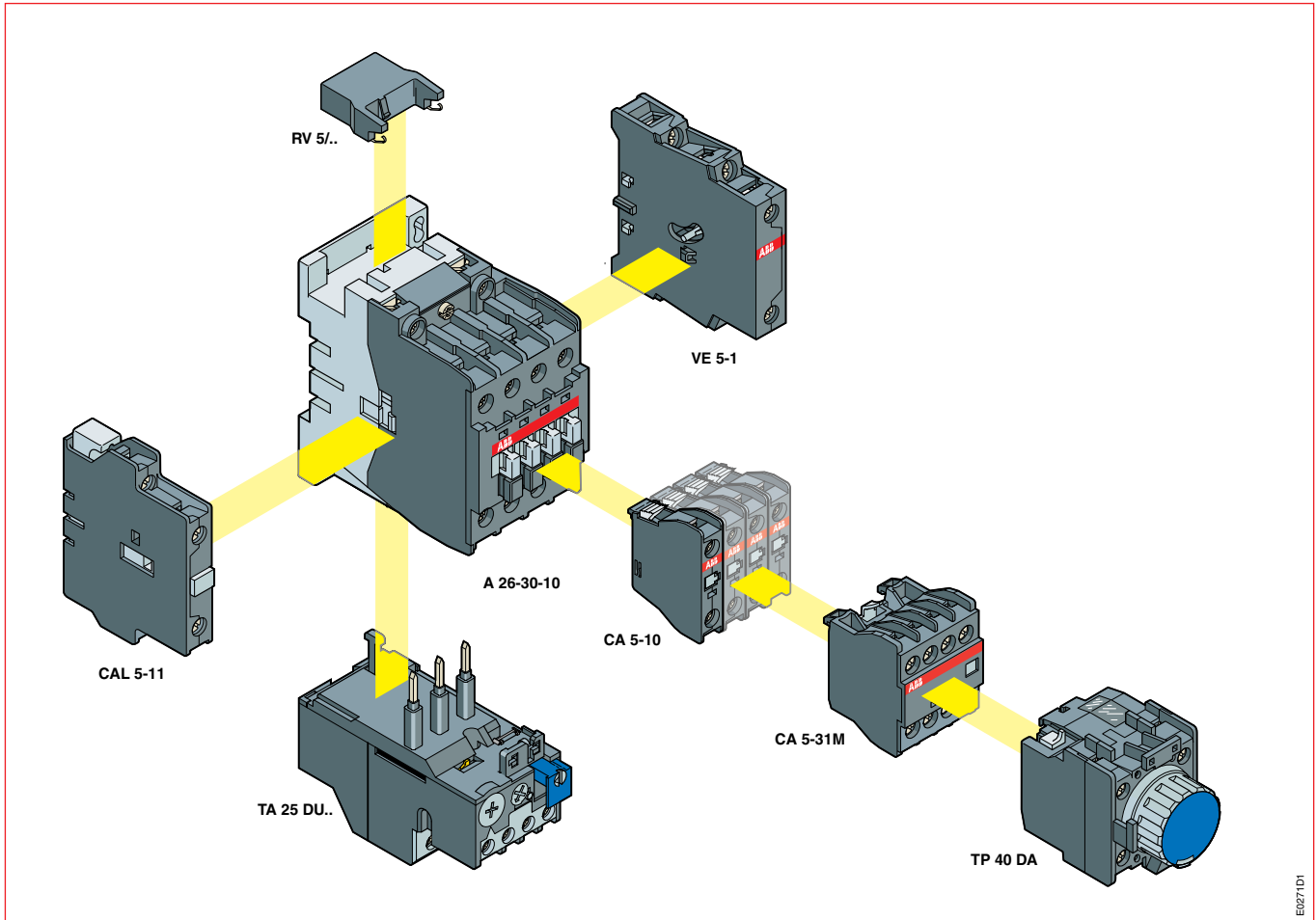

E0271D1

Types

		A9	A12	A16	A26	A30	A40	A50	A63	A75	A95	A110	
Thermal O/L relays		TA 25 DU	0.4 ...0.63 0.63 ...1.0 1.0 ...1.4 1.6 ...2.5 2.5 ...0.4	2.2...3.1 2.8...4.0 3.5...5.0 4.5...6.5 6.0...8.5	7.5...11 10 ...14 13 ...19 18 ...25 24 ...32	TA 42 DU	22...32 29...42	TA 75 DU	29...42 36...52 45...63 60...80		TA 80 DU	60...80 65...90 80...110	
Auxiliary contacts		Front mounting 1 NO CA 5-10 1 NC CA 5-01 Side mounting 1 NO + 1 NC CAL 5-11											
Timers		Pneumatic direct 0.1 ... 40 s TP 40 DA 10 ... 180 s TP 180 DA				Pneumatic inverse 0.1 ... 40 s TP 40 IA 10 ... 180 s TP 180 IA				Electronic TE5S			
Interlocks		Mechanical / electrical VE 5-1						Mechanical / electrical VE 5-2					
Surge suppressors		24 ... 50 V ~ RV 5/50		50 ... 133 V ~ RV 5/133			110 ... 250 V ~ RV 5/250			250 ... 440 V ~ RV 5/440			

Accessories for A9 ... A 110 3-pole Contactors

Ordering Details

Auxiliary Contact Blocks

Positioning	Mounting on :	Contacts	Type	Order code	Pack ^{ing} piece	Weight kg
Front face	A 9...A 40	1 -	CA 5-10	1SBN 01 0010 R1010	10	0.014
		- 1	CA 5-01	1SBN 01 0010 R1001	10	0.014
		3 1	CA 5-31 M	1SBN 01 0040 R1131	2	0.060
		2 2	CA 5-22 M	1SBN 01 0040 R1122	2	0.060
Side	A 9...A 110	1 1	CAL 5-11	1SBN 01 0020 R1011	2	0.050

Pneumatic Timers

Mounting on :	Timing range :	Contacts	Type	Order code	Pack ^{ing} piece	Weight kg
A 9...A 75	Direct 0.1...40s	1 1	TP 40 DA	1SBN 02 0300 R1000	1	0.070
	Direct 10...180s	1 1	TP 180 DA	1SBN 02 0300 R1001	1	0.070
	Inverse 0.1...40s	1 1	TP 40 IA	1SBN 02 0301 R1000	1	0.070
	Inverse 10...180s	1 1	TP 180 IA	1SBN 02 0301 R1001	1	0.070

Electronic Timers for star-delta starters (dwelling time 50 ms)

Mounting :	Timing range :	Supply voltage	Type	Order code	Pack ^{ing} piece	Weight kg
Independent	0.8...8 s or 6...60 s	{ 24 a.c. / d.c. 110 ... 120 a.c. 220 ... 240 a.c. 380 ... 440 a.c.	TE5S-24	1SBN 02 0010 R1001	1	0.080
			TE5S-120	1SBN 02 0010 R1002	1	0.080
			TE5S-240	1SBN 02 0010 R1003	1	0.080
			TE5S-440	1SBN 02 0010 R1004	1	0.080

Interlocks

Feature	Mounting on :	Contacts	Type	Order code	Pack ^{ing} piece	Weight kg
Mech. / elec.	A 9...A 40	- 2	VE 5-1	1SBN 03 0110 R1000	1	0.076
	A 50...A 110	- 2	VE 5-2	1SBN 03 0210 R1000	1	0.146
Mechanical	A 9...A 40	- -	VM 5-1	1SBN 03 0100 R1000	1	0.066

Note : Use type VE 5-2 for mechanical and electrical interlocking between contactors A40 and A50.

Surge Suppressors

Feature	Mounting on :	Voltage range	Type	Order code	Pack ^{ing} piece	Weight kg
Varistor	A 9... A 110	24...50 V ~	RV 5/50	1SBN 05 0010 R1000	2	0.015
		50...133 V ~	RV 5/133	1SBN 05 0010 R1001	2	0.015
		110...250 V ~	RV 5/250	1SBN 05 0010 R1002	2	0.015
		250...440 V ~	RV 5/440	1SBN 05 0010 R1003	2	0.015
RC	A 9...A 40	24...50 V ≐	RC 5-1/50	1SBN 05 0100 R1000	2	0.012
		50...133 V ≐	RC 5-1/133	1SBN 05 0100 R1001	2	0.012
		110...250 V ≐	RC 5-1/250	1SBN 05 0100 R1002	2	0.012
		250...440 V ≐	RC 5-1/440	1SBN 05 0100 R1003	2	0.012
RC	A 50...A 110	24...50 V ≐	RC 5-2/50	1SBN 05 0200 R1000	2	0.015
		50...133 V ≐	RC 5-2/133	1SBN 05 0200 R1001	2	0.015
		110...250 V ≐	RC 5-2/250	1SBN 05 0200 R1002	2	0.015
		250...440 V ≐	RC 5-2/440	1SBN 05 0200 R1003	2	0.015

Auxiliary Lead Terminals

Feature	Mounting on :	Type	Order code	Pack ^{ing} piece	Weight kg
Clip-on	A 50...A 75	LK 75-L	1SBN 07 3552 R1003	2	0.006
	A 95...A 110	LK 110	1SBN 07 4352 R1000	2	0.010

Function Marker

Feature	Mounting on :	Type	Order code	Pack ^{ing} box	Weight kg
50 pcs in a box	A 9...A 110	BA 5-50	1SBN 11 0000 R1000	1	0.017

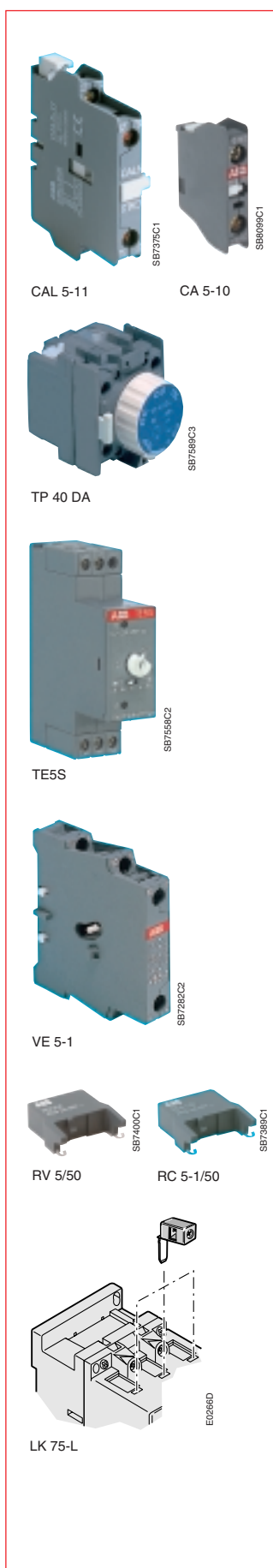

>> Thermal O/L relays page 16/12 >> Dimensions pages 16/38 ... 16/40

Accessories for A 145 ... AF 750 3-pole Contactors

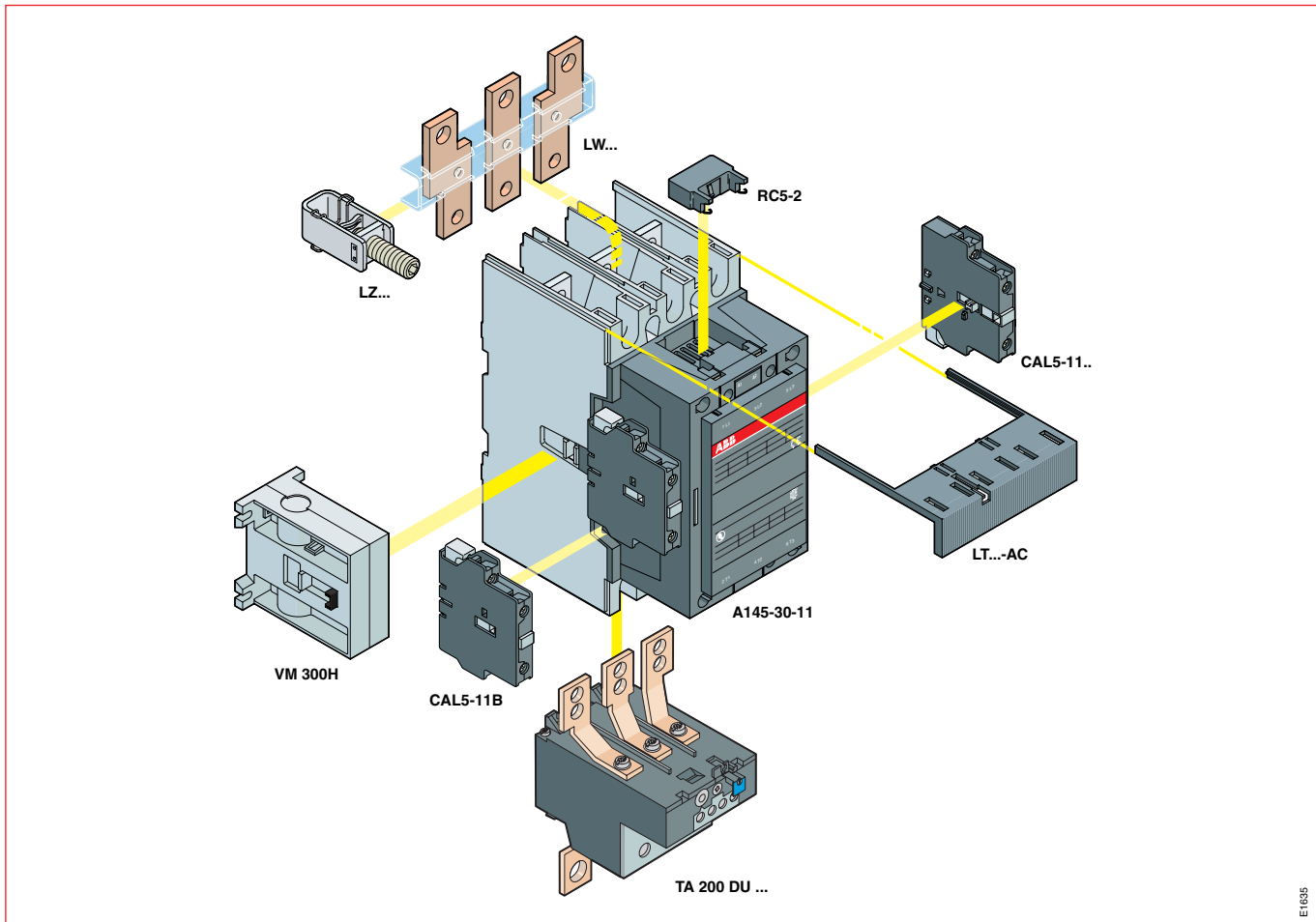

E1635

Types

	A 145	A 185	A 210	A 260	A 300	AF 400	AF 460	AF 580	AF 750
--	--------------	--------------	--------------	--------------	--------------	---------------	---------------	---------------	---------------

Thermal O/L relays
Electronic O/L relays



	TA 200 DU 66...200 E 200 DU 65...200	TA 450 DU 130...310 E 320 DU 105...320	- E 500 DU 170...500	- E 800 DU 270...800
--	-----------------------------------------	-------------------------------------------	-------------------------	-------------------------

Auxiliary contacts

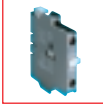

	Side mounting	1 NO + 1 NC 1 NO + 1 NC	CAL 5-11 (first block) CAL 5-11B (second block)
--	---------------	----------------------------	----------------------------------------------------

Timers



	Electronic TE5S (Interpose an N contactor relay for AF 580, AF 750)		
--	-------------------------------------------------------------------------------	--	--

Interlocks

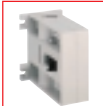

	Mechanical VM 300H	Mechanical VM 300/460H	Mechanical VM 750H
--	-----------------------	---------------------------	-----------------------

Surge suppressors



	24 ... 50 V 50 ... 133 V 110 ... 250 V 250 ... 440 V	RC 5-2/50 RC 5-2/133 RC 5-2/250 RC 5-2/440	A 95...A 300 A 145...A 300 A 145...A 300 A 145...A 300	The built-in coil interface eliminates the need of extra surge suppressors on these sizes
--	---------------------------------------------------------------	-----------------------------------------------------	-----------------------------------------------------------------	-------------------------------------------------------------------------------------------

Accessories for A 145 ... AF 750 3-pole Contactors

Ordering Details

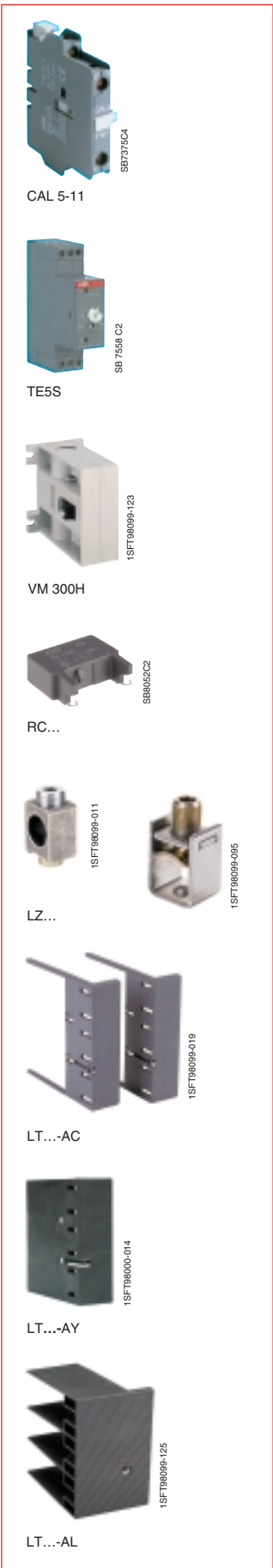

Auxiliary Contact Blocks

Positioning	Mounting on :	Contacts	Type	Order code	Packing piece	Weight kg
Side	A 145 ... AF 750	1 1	CAL 5-11	1SBN 01 0020 R1011	1	0.050
		1 1	CAL 5-11B	1SBN 01 0420 R3311	1	0.050

Electronic Timers for star-delta starters (dwelling time 50 ms)

Mounting :	Timing range :	Supply Voltage	Type	Order code	Packing piece	Weight kg
Independent	Direct 0.8 ... 8 s or 6 ... 60 s	24 a.c. / d.c.	TE5S-24	1SBN 02 0010 R1001	1	0.080
		110 ... 120 a.c.	TE5S-120	1SBN 02 0010 R1002	1	0.080
		220 ... 240 a.c.	TE5S-240	1SBN 02 0010 R1003	1	0.080
		380 ... 440 a.c.	TE5S-440	1SBN 02 0010 R1004	1	0.080

Interlocks for two horizontal mounted contactors

Feature	Left Contactor	Right Contactor	Type	Order code	Packing piece	Weight kg
Mechanical	A 95...A 300	A 145...A 300	VM 300H	1SFN 03 4700 R1000	1	0.150
	A 210...A 300	AF 400...AF 460	VM 300/460H	1SFN 03 5100 R1000	1	0.150
	AF 400...AF 750	AF 400...AF 750	VM 750H	1SFN 03 5700 R1000	1	0.200

Surge Suppressors

Feature	Mounting on :	Voltage range	Type	Order code	Packing piece	Weight kg
RC	A 145...A300	24 ... 50 V ~	RC 5-2/50	1SBN 05 0200 R1000	1	0.015
		50 ... 133 V ~	RC 5-2/133	1SBN 05 0200 R1001	1	0.015
		110 ... 250 V ~	RC 5-2/250	1SBN 05 0200 R1002	1	0.015
		250 ... 440 V ~	RC 5-2/440	1SBN 05 0200 R1003	1	0.015

Connectors

Cables	Mounting on :	cable cross section :	Type	Order code	Packing pieces	Weight kg
Single, Cu	A 145...A 185	6 ... 185 mm ²	LZ 185-1C/185	1SDA 02 3354 R0001	3	0.200
	A 210...A 460	16 ... 240 mm ²	LZ 460-1C/240	1SDA 02 3368 R0001	3	0.400
Single Al & Cu	A 145...A 185	35 ... 95 mm ²	LZ 185-1A/95	1SDA 02 3356 R0001	3	0.100
	A 145...A 185	25 ... 150 mm ²	LZ 185-1A/150	1SDA 02 3357 R0001	3	0.100
	A 210...A 300	120 ... 240 mm ²	LZ 300-1A/240	1SDA 02 3370 R0001	3	0.200
Double, Cu	A 145...A185	2x(50 ... 120)mm ²	LZ 185-2C/120	1SFN 07 4709 R1000	3	0.300
Double Al & Cu	A 210...A 300	2x(95 ... 120)mm ²	LZ 300-2A/120	1SDA 02 5766 R0001	3	0.400

Shrouds (terminal protection acc. to VDE0106, part 100)

Suitable for contactor with :	Mounting on :	Type	Order code	Packing pieces	Weight kg
Cable connectors	A 145...A 185	LT 185-AC	1SFN 12 4701 R1000	2	0.100
Cable lugs	A 145...A 185	LT 185-AL	1SFN 12 4703 R1000	2	0.100
For shorting bar LY and between A 145/185 and TA 200 DU	A 145...A 185	LT 185-AY	1SFN 12 4704 R1000	2	0.100
Cable connectors	A 210...A 300	LT 300-AC	1SFN 12 5101 R1000	2	0.100
Cable lugs	A 210...A 300	LT 300-AL	1SFN 12 5103 R1000	2	0.100
For Shorting bar LY 300	A 210...A 300	LT 300-AY	1SFN 12 5104 R1000	2	0.150
Cable connectors	AF 400...AF 460	LT 460-AC	1SFN 12 5701 R1000	2	0.150
Cable lugs	AF 400...AF 460	LT 460-AL	1SFN 12 5703 R1000	2	0.800
Cable connectors	AF 580...AF 750	LT 750-AC	1SFN 12 6101 R1000	2	0.150
Cable lugs	AF 580...AF 750	LT 750-AL	1SFN 12 6103 R1000	2	0.850

>> Thermal and Electronic O/L relays page 16/13 >> Dimensions page 16/40 ... 16/44

Accessories for A 145 ... AF 750 3-pole Contactors

Ordering Details

Connection bars for reversing contactors

For Contactor :	Type	Order code	Pack ^{ing} piece	Weight kg
A 145...A 185	BEM 185-30	1SFN 08 4701 R1000	1	0.900
A 210...A 300	BEM 300-30	1SFN 08 5101 R1000	1	1.100
AF 400...AF 460	BEM 460-30	1SFN 08 5701 R1000	1	4.400
AF 580...AF 750	BEM 750-30	1SFN 08 6101 R1000	1	7.300

Connection phase to phase for 3-pole contactor pairs

For Contactor :	Type	Order code	Pack ^{ing} piece	Weight kg
A 145...A 185	BES 185-30	1SFN 08 4704 R1000	1	0.500
A 210...A 300	BES 300-30	1SFN 08 5104 R1000	1	1.000
AF 400...AF 460	BES 460-30	1SFN 08 5704 R1000	1	2.200
AF 580...AF 750	BES 750-30	1SFN 08 6104 R1000	1	3.700

Connection bars for star-delta starters

Contactors Line and Delta	Star	Type	Order code	Pack ^{ing} piece	Weight kg
A 145	A 110	BED 145A	1SFN 08 4703 R1000	1	1.300
A 185	A 145	BED 185	1SFN 08 4903 R1000	1	1.100
A 210	A 185	BED 210	1SFN 08 5103 R1000	1	1.500
A 260... A 300	A 210...A 260	BED 300	1SFN 08 5303 R1000	1	2.100
AF 400/AF 460	A 300/A 260	BED 400	1SFN 08 5503 R1000	1	3.500
AF 460	AF 400	BED 460	1SFN 08 5703 R1000	1	4.700
AF 580	AF 460/AF 400	BED 580	1SFN 08 5903 R1000	1	6.300
AF 750	AF 580	BED 750	1SFN 08 6103 R1000	1	7.700



BEM...

1SFN08000-008



BES...

1SFN08000-009



BED...

1SFN08000-006

Accessories for A 145 ... AF 750 3-pole Contactors

Ordering Details

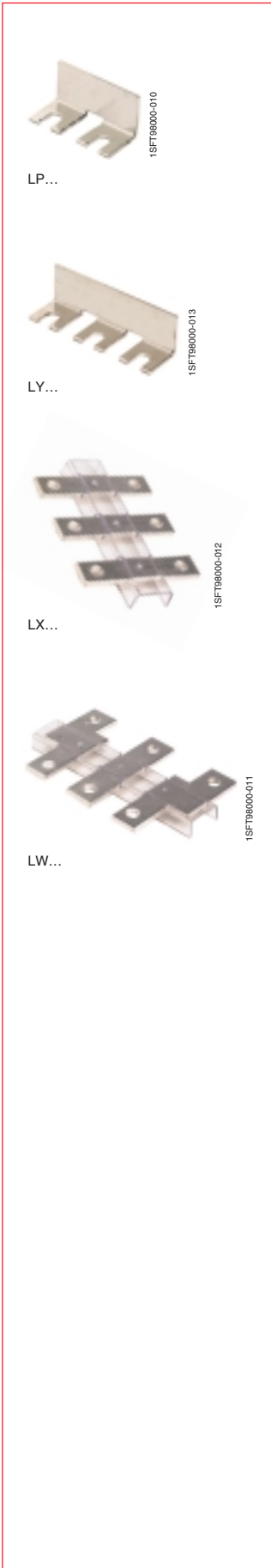

Connection strip 2-pole

For Contactor	Type	Order code	Pack ^{ing} pieces	Weight kg
A 145...A 185	LP 185	1SFN 07 4712 R1000	2	0.300
A 210...A 300	LP 300	1SFN 07 5112 R1000	2	0.400
AF 400...AF 460	LP 460	1SFN 07 5712 R1000	2	0.500
AF 580...AF 750	LP 750	1SFN 07 6112 R1000	2	0.600

Connection strip 3-pole

For Contactor	Type	Order code	Pack ^{ing} piece	Weight kg
A 145...A 185	LY185	1SFN 07 4703 R1000	1	0.200
A 210...A 300	LY 300	1SFN 07 5103 R1000	1	0.300
AF 400...AF 460	LY 460	1SFN 07 5703 R1000	1	0.300
AF 580...AF 750	LY 750	1SFN 07 6103 R1000	1	0.450

Terminal extensions

For Contactor	Type	Order code	Pack ^{ing} piece	Weight kg
A 145...A 185	LX 185	1SFN 07 4710 R1000	1	0.250
A 210...A 300	LX 300	1SFN 07 5110 R1000	1	0.350
AF 400...AF 460	LX 460	1SFN 07 5710 R1000	1	0.500
AF 580...AF 750	LX 750	1SFN 07 6110 R1000	1	0.850

Terminal enlargements, 3-pole

For Contactor	Type	Order code	Pack ^{ing} piece	Weight kg
A 145...A 185	LW 185	1SFN 07 4707 R1000	1	0.250
A 210...A 300	LW 300	1SFN 07 5107 R1000	1	0.400

Thermal O/L Relays for A9 ... A 110 Contactors

Ordering Details

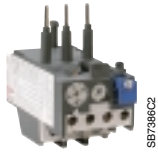

TA 25 DU

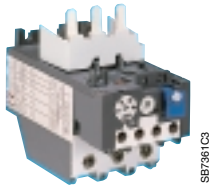

TA 42 DU

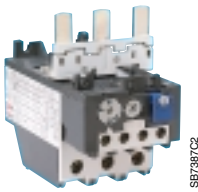

TA 75 DU

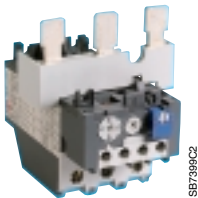

TA 80 DU

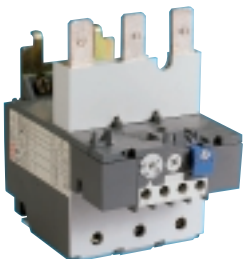

TA 110 DU

A9 A12 A16	A26 A30 A40	A50 A63 A75	A95 A110
TA 25 DU ..	TA 42 DU ..	TA 75 DU ..	TA 80 DU ..
			TA 110 DU ..

Thermal O/L Relays, Class 10A

For contactor :	Setting range A	Type	Order code	Pack ^{ing} piece	Weight kg
A 9 ... A 40	0.1 ... 0.16	TA 25 DU 0.16	1SAZ 21 1201 R1005	1	0.150
	0.16 ... 0.25	TA 25 DU 0.25	1SAZ 21 1201 R1009	1	0.150
	0.25 ... 0.4	TA 25 DU 0.4	1SAZ 21 1201 R1013	1	0.150
	0.4 ... 0.63	TA 25 DU 0.63	1SAZ 21 1201 R1017	1	0.150
	0.63 ... 1.0	TA 25 DU 1.0	1SAZ 21 1201 R1021	1	0.150
	1.0 ... 1.4	TA 25 DU 1.4	1SAZ 21 1201 R1023	1	0.150
	1.3 ... 1.8	TA 25 DU 1.8	1SAZ 21 1201 R1025	1	0.150
	1.7 ... 2.4	TA 25 DU 2.4	1SAZ 21 1201 R1028	1	0.150
	2.2 ... 3.1	TA 25 DU 3.1	1SAZ 21 1201 R1031	1	0.150
	2.8 ... 4.0	TA 25 DU 4.0	1SAZ 21 1201 R1033	1	0.150
	3.5 ... 5.0	TA 25 DU 5.0	1SAZ 21 1201 R1035	1	0.150
	4.5 ... 6.5	TA 25 DU 6.5	1SAZ 21 1201 R1038	1	0.150
	6.0 ... 8.5	TA 25 DU 8.5	1SAZ 21 1201 R1040	1	0.150
	7.5 ... 11	TA 25 DU 11	1SAZ 21 1201 R1043	1	0.150
	10 ... 14	TA 25 DU 14	1SAZ 21 1201 R1045	1	0.150
	13 ... 19	TA 25 DU 19	1SAZ 21 1201 R1047	1	0.150
	18 ... 25	TA 25 DU 25	1SAZ 21 1201 R1051	1	0.150
	24 ... 32	TA 25 DU 32	1SAZ 21 1201 R1053	1	0.170
A 30 ... A 40	18 ... 25	TA 42 DU 25	1SAZ 31 1201 R1001	1	0.330
	22 ... 32	TA 42 DU 32	1SAZ 31 1201 R1002	1	0.330
	29 ... 42	TA 42 DU 42	1SAZ 31 1201 R1003	1	0.330
A 50 ... A 75	18 ... 25	TA 75 DU 25	1SAZ 32 1201 R1001	1	0.330
	22 ... 32	TA 75 DU 32	1SAZ 32 1201 R1002	1	0.330
	29 ... 42	TA 75 DU 42	1SAZ 32 1201 R1003	1	0.330
	36 ... 52	TA 75 DU 52	1SAZ 32 1201 R1004	1	0.330
	45 ... 63	TA 75 DU 63	1SAZ 32 1201 R1005	1	0.330
	60 ... 80	TA 75 DU 80	1SAZ 32 1201 R1006	1	0.330
A 95 ... A 110	29 ... 42	TA 80 DU 42	1SAZ 33 1201 R1003	1	0.360
	36 ... 52	TA 80 DU 52	1SAZ 33 1201 R1004	1	0.360
	45 ... 63	TA 80 DU 63	1SAZ 33 1201 R1005	1	0.360
	60 ... 80	TA 80 DU 80	1SAZ 33 1201 R1006	1	0.360
	65 ... 90	TA 110 DU 90	1SAZ 41 1201 R1001	1	0.750
	80 ... 110	TA 110 DU 110	1SAZ 41 1201 R1002	1	0.750

Separate Mounting Kit

For O/L relays :	Type	Order code	Pack ^{ing} piece	Weight kg
TA 25 DU ≤ 25	DB 25/25 A	1SAZ 20 1108 R0001	1	0.050
TA 25 DU 32	DB 25/32 A	1SAZ 20 1108 R0002	1	0.075
TA 42 DU, TA 75 DU, TA 80 DU	DB 80	1SAZ 30 1110 R0001	1	0.170
TA 110 DU	DB 200	1SAZ 40 1110 R0001	1	0.230

>> Dimensions page 16/38 ... 16/40

Thermal O/L Relays and Electronic O/L Relays for A 145 ... AF 750 Contactors

Ordering Details

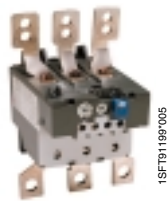

TA 200 DU



TA 450 DU

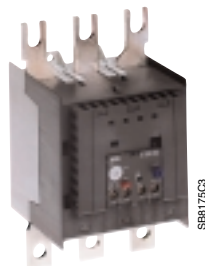

E 320 DU



E 500 DU

A 145, A 185

A 210, A 260, A 300

AF 400, AF 460

AF 580, AF 750

TA 200 DU ...
E 200 DU ...

TA 450 DU ...
E 320 DU ...

—
E 500 DU ...

—
E 800 DU ...

Thermal O/L Relays, Class 10A

For contactor :	Setting range A	Type	Order code	Pack ^{ing} piece	Weight kg
A 145...A 185	66 ... 90	TA 200 DU 90	1SAZ 42 1201 R1001	1	0.750
	80 ... 110	TA 200 DU 110	1SAZ 42 1201 R1002	1	0.750
	100 ... 135	TA 200 DU 135	1SAZ 42 1201 R1003	1	0.750
	110 ... 150	TA 200 DU 150	1SAZ 42 1201 R1004	1	0.750
	130 ... 175	TA 200 DU 175	1SAZ 42 1201 R1005	1	0.750
A 210...A 300	150 ... 200	TA 200 DU 200	1SAZ 42 1201 R1006	1	0.750
	130 ... 185	TA 450 DU 185	1SAZ 51 1201 R1001	1	1.500
	165 ... 235	TA 450 DU 235	1SAZ 51 1201 R1002	1	1.500
	220 ... 310	TA 450 DU 310	1SAZ 51 1201 R1003	1	1.500

Electronic overload relays, Adjustable Class 10, 20 and 30

For contactor :	Setting range A	Type	Order code	Pack ^{ing} piece	Weight kg
A 145...A185	65 ... 200	E 200 DU	1SAX 51 1001 R0001	1	0.780
A 210...A 300	105 ... 320	E 320 DU	1SAX 61 1001 R0002	1	0.840
AF 400...AF 460	170 ... 500	E 500 DU	1SAX 71 1001 R0001	1	1.180
AF 580...AF 750	270 ... 800	E 800 DU	1SAX 81 1001 R0001	1	4.240

Kit for Mounting on the Contactors

For O/L relays :	On contactor :	Type	Order code	Pack ^{ing} piece	Weight kg
TA 450 DU/SU	A 145...A 185	DT 450/A 185	1SAZ 50 1901 R1001	1	0.500
	A 210...A 300	DT 450/A 300	1SAZ 50 1902 R1001	1	0.750
E 500 DU	AF 400...AF 460	DT 450/A 460	1SAX 50 1901 R0001	1	0.900
E 800 DU	AF 580...AF 780	DT 750/A 750	1SAX 60 1901 R0001	1	1.000

Separate Mounting Kit

For O/L relays :	Type	Order code	Pack ^{ing} piece	Weight kg
TA 200 DU	DB 200	1SAZ 40 1110 R0001	1	0.230

Terminal shrouds for TA 200 DU thermal O/L relay

Fitting	Type	Order code	Pack ^{ing} piece	Weight kg
Load side	LT 200/A 185	1SAZ 40 1901 R1001	1	0.070
Between TA200DU and A145...A185	LT 185-AY	1SFN 12 4704 R1000	1	0.100

>> Dimensions page 16/40 ... 16/44

A 4-pole Contactors - a.c. Coil

Ordering Details



A 9-40-00

SB7314C2



A 45-40-00

SB6087C3



A 9-22-00

SB7397C2

Rated operational current AC-1 $\theta \leq 40\text{ }^\circ\text{C}$ A	Auxiliary contacts fitted 	Type State coil voltage: <input type="checkbox"/>	Order code coil voltage code see table below : <input type="checkbox"/>	Weight kg Pack ^{ing} 1 piece
------------------------------------------------------------------------------------------------	-------------------------------	---------------------------------------------------------	-------------------------------------------------------------------------------	------------------------------------------------

4-pole Contactors - 4 NO Main Poles

25	- -	A 9-40-00 <input type="checkbox"/>	1SBL 14 1201 R <input type="checkbox"/> <input type="checkbox"/> 00	0.340
30	- -	A 16-40-00 <input type="checkbox"/>	1SBL 18 1201 R <input type="checkbox"/> <input type="checkbox"/> 00	0.340
45	- -	A 26-40-00 <input type="checkbox"/>	1SBL 24 1201 R <input type="checkbox"/> <input type="checkbox"/> 00	0.610
70	- -	A 45-40-00 <input type="checkbox"/>	1SBL 33 1201 R <input type="checkbox"/> <input type="checkbox"/> 00	1.390
100	- -	A 50-40-00 <input type="checkbox"/>	1SBL 35 1201 R <input type="checkbox"/> <input type="checkbox"/> 00	1.390
125	- -	A 75-40-00 <input type="checkbox"/>	1SBL 41 1201 R <input type="checkbox"/> <input type="checkbox"/> 00	1.390

4-pole Contactors - 2 NO + 2 NC Main Poles

25	- -	A 9-22-00 <input type="checkbox"/>	1SBL 14 1501 R <input type="checkbox"/> <input type="checkbox"/> 00	0.340
30	- -	A 16-22-00 <input type="checkbox"/>	1SBL 18 1501 R <input type="checkbox"/> <input type="checkbox"/> 00	0.340
45	- -	A 26-22-00 <input type="checkbox"/>	1SBL 24 1501 R <input type="checkbox"/> <input type="checkbox"/> 00	0.610
70	- -	A 45-22-00 <input type="checkbox"/>	1SBL 33 1501 R <input type="checkbox"/> <input type="checkbox"/> 00	1.400
125	- -	A 75-22-00 <input type="checkbox"/>	1SBL 41 1501 R <input type="checkbox"/> <input type="checkbox"/> 00	1.400

Coil voltages and codes A9 ... A75

Voltage (V) 50 Hz : <input type="checkbox"/>	Voltage (V) 60 Hz : <input type="checkbox"/>	Voltage code : <input type="checkbox"/> <input type="checkbox"/>
24	24	<input type="checkbox"/> <input type="checkbox"/> 1
48	48	<input type="checkbox"/> <input type="checkbox"/> 3
110	110	<input type="checkbox"/> <input type="checkbox"/> 4
220 ... 230	230...240	<input type="checkbox"/> <input type="checkbox"/> 0
230 ... 240	240...260	<input type="checkbox"/> <input type="checkbox"/> 8
380 ... 400	400...415	<input type="checkbox"/> <input type="checkbox"/> 5
400 ... 415	415...440	<input type="checkbox"/> <input type="checkbox"/> 6

Other voltages : page 16/34

>> Accessories page 16/16 >> Dimensions page 16/45 >> Technical data page 16/32

EK 4-pole Contactors - a.c. Coil

Ordering Details



EK 110-40-11

SB7240C3

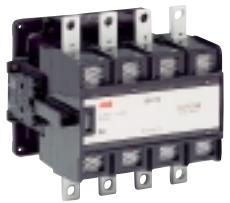

EK 175-40-11

SB7241C2



EK 370-40-11

SB7243C2



EK 1000-40-11

1SFT198099-089

Rated operational current AC-1 $\theta \leq 40^\circ\text{C}$ A	Auxiliary contacts fitted 	Type State coil voltage: <input type="checkbox"/> <input type="checkbox"/>	Order code coil voltage code see table below: <input type="checkbox"/> <input type="checkbox"/>	Weight
				kg
200	1 1	EK 110-40-11 <input type="checkbox"/>	SK 824 440 - <input type="checkbox"/> <input type="checkbox"/>	4.300
	2 2	EK 110-40-22 <input type="checkbox"/>	SK 824 450 - <input type="checkbox"/> <input type="checkbox"/>	4.350
250	1 1	EK 150-40-11 <input type="checkbox"/>	SK 824 441 - <input type="checkbox"/> <input type="checkbox"/>	4.350
	2 2	EK 150-40-22 <input type="checkbox"/>	SK 824 451 - <input type="checkbox"/> <input type="checkbox"/>	4.400
300	1 1	EK 175-40-11 <input type="checkbox"/>	SK 825 440 - <input type="checkbox"/> <input type="checkbox"/>	6.600
	2 2	EK 175-40-22 <input type="checkbox"/>	SK 825 448 - <input type="checkbox"/> <input type="checkbox"/>	6.650
350	1 1	EK 210-40-11 <input type="checkbox"/>	SK 825 441 - <input type="checkbox"/> <input type="checkbox"/>	6.600
	2 2	EK 210-40-22 <input type="checkbox"/>	SK 825 451 - <input type="checkbox"/> <input type="checkbox"/>	6.650
550	1 1	EK 370-40-11 <input type="checkbox"/>	SK 827 040 - <input type="checkbox"/> <input type="checkbox"/>	17.200
	2 2	EK 370-40-22 <input type="checkbox"/>	SK 827 042 - <input type="checkbox"/> <input type="checkbox"/>	17.200
800	1 1	EK 550-40-11 <input type="checkbox"/>	SK 827 041 - <input type="checkbox"/> <input type="checkbox"/>	17.200
	2 2	EK 550-40-22 <input type="checkbox"/>	SK 827 043 - <input type="checkbox"/> <input type="checkbox"/>	17.200
1000	1 1	EK 1000-40-11 <input type="checkbox"/>	SK 827 044 - <input type="checkbox"/> <input type="checkbox"/>	17.500
	2 2	EK 1000-40-22 <input type="checkbox"/>	SK 827 045 - <input type="checkbox"/> <input type="checkbox"/>	17.500

Coil voltages and codes EK 110 ... EK 1000

Voltage (V) 50 Hz : <input type="checkbox"/> <input type="checkbox"/>	Voltage (V) 60 Hz : <input type="checkbox"/> <input type="checkbox"/>	Voltage code : <input type="checkbox"/> <input type="checkbox"/>
48	-	<input type="checkbox"/> A <input type="checkbox"/> D
-	110	<input type="checkbox"/> A <input type="checkbox"/> E
110	120	<input type="checkbox"/> A <input type="checkbox"/> F
220 ... 230	-	<input type="checkbox"/> A <input type="checkbox"/> L
230 ... 240	-	<input type="checkbox"/> A <input type="checkbox"/> M
-	380	<input type="checkbox"/> A <input type="checkbox"/> N
380 ... 400	440	<input type="checkbox"/> A <input type="checkbox"/> P
400 ... 415	-	<input type="checkbox"/> A <input type="checkbox"/> R

Other voltages : page 16/35.

Accessories for A 4-pole Contactors

Ordering Details

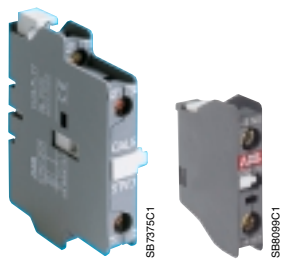

CAL 5-11 SB7075AC1
CA 5-10 SB8099AC1



TP 40 DA SB7598AC3



VE 5-1 SB7282AC2

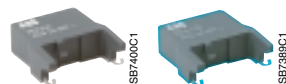

RV 5/50 SB7400C1
RC 5-1/50 SB7385C1

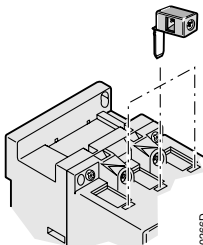

LK 75-L E0286D

Auxiliary Contact Blocks

Positioning	Mounting on :	Contacts	Type	Order code	Pack ^{ing}	Weight
					pieces	kg
Front	A 9...A 75	1 -	CA 5-10	1SBN 01 0010 R1010	10	0.014
		- 1	CA 5-01	1SBN 01 0010 R1001	10	0.014
		4 -	CA 5-40 E	1SBN 01 0040 R1040	2	0.060
		2 2	CA 5-22 E	1SBN 01 0040 R1022	2	0.060
Side	A 9...A 75	1 1	CAL 5-11	1SBN 01 0020 R1011	2	0.050

Pneumatic Timers

Mounting on :	Timing range :	Contacts	Type	Order code	Pack ^{ing}	Weight
					piece	kg
A 9 ... A 75	Direct 0.1...40s	1 1	TP 40 DA	1SBN 02 0300 R1000	1	0.070
	Direct 10 ...180s	1 1	TP 180 DA	1SBN 02 0300 R1001	1	0.070
	Inverse 0.1...40s	1 1	TP 40 IA	1SBN 02 0301 R1000	1	0.070
	Inverse 10 ...180s	1 1	TP 180 IA	1SBN 02 0301 R1001	1	0.070

Interlocks

Feature	Mounting on :	Contacts	Type	Order code	Pack ^{ing}	Weight
					piece	kg
Mech. / elec.	A 9...A 26	2	VE 5-1	1SBN 03 0110 R1000	1	0.076
	A 45...A 75	2	VE 5-2	1SBN 03 0210 R1000	1	0.146
Mechanical	A 9 ...A 26	-	VM 5-1	1SBN 03 0100 R1000	1	0.066

Surge Suppressors

Feature	Mounting on :	Voltage range	Type	Order code	Pack ^{ing}	Weight
					pieces	kg
Varistor	A 9...A 75	24...50 V ~	RV 5/50	1SBN 05 0010 R1000	2	0.015
		50...133 V ~	RV 5/133	1SBN 05 0010 R1001	2	0.015
		110...250 V ~	RV 5/250	1SBN 05 0010 R1002	2	0.015
		250...440 V ~	RV 5/440	1SBN 05 0010 R1003	2	0.015
RC	A 9...A 26	24...50 V ≐	RC 5-1/50	1SBN 05 0100 R1000	2	0.012
		50...133 V ≐	RC 5-1/133	1SBN 05 0100 R1001	2	0.012
		110...250 V ≐	RC 5-1/250	1SBN 05 0100 R1002	2	0.012
		250...440 V ≐	RC 5-1/440	1SBN 05 0100 R1003	2	0.012
RC	A 45...A 75	24...50 V ≐	RC 5-2/50	1SBN 05 0200 R1000	2	0.015
		50...133 V ≐	RC 5-2/133	1SBN 05 0200 R1001	2	0.015
		110...250 V ≐	RC 5-2/250	1SBN 05 0200 R1002	2	0.015
		250...440 V ≐	RC 5-2/440	1SBN 05 0200 R1003	2	0.015

Auxiliary Lead Terminals

Feature	Mounting on :	Type	Order code	Pack ^{ing}	Weight
				pieces	kg
Clip-on	A 45...A 75	LK 75-L	1SBN 07 3552 R1003	2	0.006

Function Marker

Feature	Mounting on :	Type	Order code	Pack ^{ing}	Weight
				box	kg
50 pcs in a box	A 9...A 75	BA 5-50	1SBN 11 0000 R1000	1	0.017

>> Dimensions page 16/45

Accessories for EK 4-pole Contactors

Ordering Details

Auxiliary Contact Blocks



CAL 16-11 B



VH 145



RC-EH 300/48

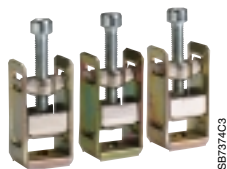

OXFB



TC

TCD

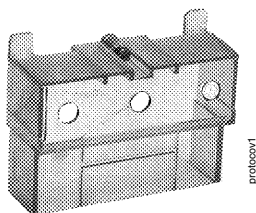

LT 210 ...

Positioning	Mounting on :	Contacts		Type	Order code	Pack ^{ing} piece	Weight kg
		1	1				
Side	EK 110...EK 1000	1	1	CAL 16-11 B	SK 829 002-B	1	0.050
		1	1	CAL 16-11 C	SK 829 002-C	1	0.050
		1	1	CAL 16-11 D	SK 829 002-D	1	0.050

Interlocks for two horizontal mounted contactors

Feature	Mounting on :	Contacts		Type	Order code	Pack ^{ing} piece	Weight kg
		2	2				
Mech./elec.	EK 110, EK 150	2		VH 145	SK 829 071-A	1	0.130
	EK 175, EK 210	2		VH 300	SK 829 071-B	1	0.130
Mechanical	EK 370, EK 550 EK 1000	-		VH 800	SK 829 070-F	1	6.000

Note : For interlocking between two contactors of a different size, please consult us.

Surge Suppressors

Feature	Mounting on :	Voltage range	Type	Order code	Pack ^{ing} piece	Weight kg
110...415 V ~	RC-EH 300/415	SK 829 007-B	1	0.015		
EK 370...EK 1000	48...110 V ~	RC-EH 800/110	SK 829 007-C	1	0.015	
	220...600 V ~	RC-EH 800/600	SK 829 007-D	1	0.015	

Connectors

Cables	Mounting on :	cable cross section :	Type	Order code	Pack ^{ing} pieces	Weight kg
25...185 mm ²	OXFB 185	SK 175 0007	3	0.070		
70...300 mm ²	OXFB 300	SK 175 0009	3	0.130		
Single, Al & Cu	EK 110 EK 150...EK 210 EK 370, EK 550	10...70 mm ²	TC 70-15	SK 173 001-AB	3	0.040
		35...120 mm ²	TC 120-20	SK 173 001-AC	3	0.080
		70...300 mm ²	TC 300-25	SK 173 001-AD	3	0.160
Double, Al & Cu	EK 370, EK 550	2x(35...185)mm ²	TCD 185-25	SK 173 001-BD	3	0.250

Shrouds (terminal protection VDE 106, part 100)

Suitable for contactor with :	Mounting on :	Type	Order code	Pack ^{ing} piece	Weight kg
cable lugs or	EK 110, EK 150 EK 175, EK 210	LT 150-EK	SK 178 001-HB	1	0.139
		LT 210-EK	SK 178 001-KB	1	0.152
cable clamps	EK 370, EK 550 EK 1000	LT 550-EK	SK 178 001-LB	1	0.190
		LT 1000-EK	SK 178 001-MB	1	0.200

>> Dimensions page 16/46

N Contactor Relays – a.c. Coil

Ordering Details

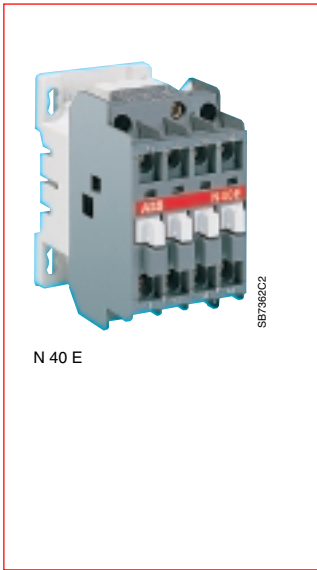

Auxiliary contacts fitted	Type	Order code	Weight kg
	State coil voltage: <input type="text"/>	coil voltage code see table below: <input type="text"/>	Pack ^{ing} 1 piece
4 -	N 40 E <input type="text"/>	1SBH 14 1001 R <input type="text"/> 40	0.340
2 2	N 22 E <input type="text"/>	1SBH 14 1001 R <input type="text"/> 22	0.340
3 1	N 31 E <input type="text"/>	1SBH 14 1001 R <input type="text"/> 31	0.340

Coil voltages and codes

Voltage (V) 50 Hz : <input type="text"/>	Voltage (V) 60 Hz : <input type="text"/>	Voltage code : <input type="text"/>
24	24	<input type="text"/> 1
48	48	<input type="text"/> 3
110	110	<input type="text"/> 4
220 ... 230	230...240	<input type="text"/> 0
230 ... 240	240...260	<input type="text"/> 8
380 ... 400	400...415	<input type="text"/> 5
400 ... 415	415...440	<input type="text"/> 6

Other voltages : page 16/34.

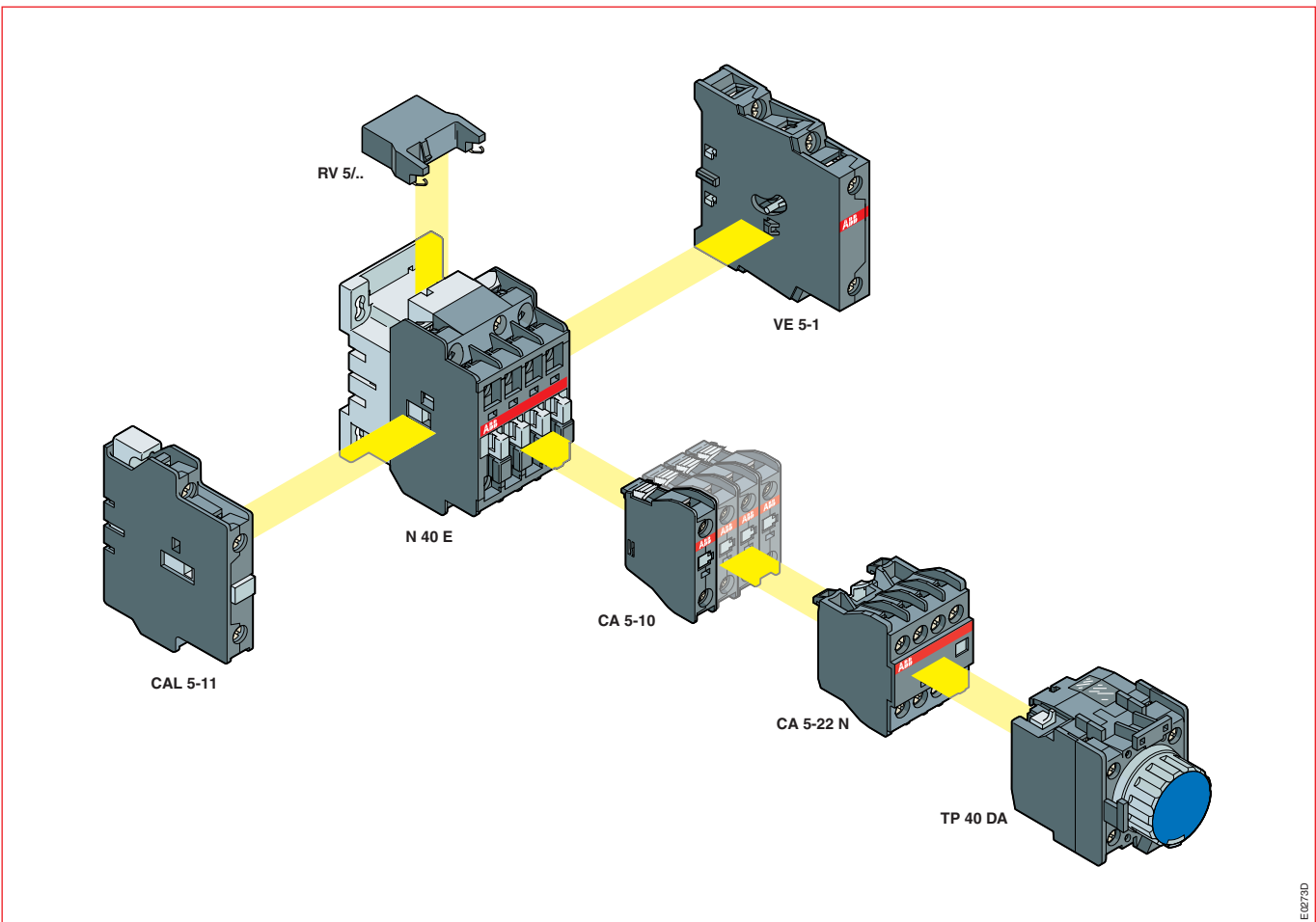

Accessories for N Contactor Relays

Ordering Details

Auxiliary Contact Blocks

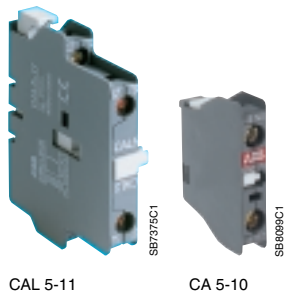

Positioning	Contacts 	Type	Order code	Pack ^{ing}	Weight
				pieces	kg
Front face	1 -	CA 5-10	1SBN 01 0010 R1010	10	0.014
	- 1	CA 5-01	1SBN 01 0010 R1001	10	0.014
	4 -	CA 5-40 N	1SBN 01 0040 R1240	2	0.060
	2 2	CA 5-22 N	1SBN 01 0040 R1222	2	0.060
	- 4	CA 5-04 N	1SBN 01 0040 R1204	2	0.060
Side	1 1	CAL 5-11	1SBN 01 0020 R1011	2	0.050

Pneumatic Timers

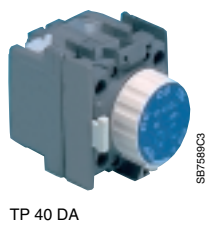

Timing range :	Contacts 	Type	Order code	Pack ^{ing}	Weight
				piece	kg
Direct 0.1...40s	1 1	TP 40 DA	1SBN 02 0300 R1000	1	0.070
Direct 10...180s	1 1	TP 180 DA	1SBN 02 0300 R1001	1	0.070
Inverse 0.1...40s	1 1	TP 40 IA	1SBN 02 0301 R1000	1	0.070
Inverse 10...180s	1 1	TP 180 IA	1SBN 02 0301 R1001	1	0.070

Interlocks



Feature	Contacts 	Type	Order code	Pack ^{ing}	Weight
				piece	kg
Mech. / elec.	2	VE 5-1	1SBN 03 0110 R1000	1	0.076
Mechanical	-	VM 5-1	1SBN 03 0100 R1000	1	0.066

Surge Suppressors

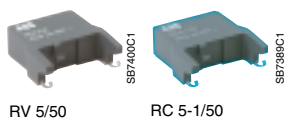

Feature	Voltage range	Type	Order code	Pack ^{ing}	Weight
				pieces	kg
Varistor	24 ... 50 V ~	RV 5/50	1SBN 05 0010 R1000	2	0.015
	50 ... 133 V ~	RV 5/133	1SBN 05 0010 R1001	2	0.015
	110 ... 250 V ~	RV 5/250	1SBN 05 0010 R1002	2	0.015
	250 ... 440 V ~	RV 5/440	1SBN 05 0010 R1003	2	0.015
RC	24 ... 50 V ≐	RC 5-1/50	1SBN 05 0100 R1000	2	0.012
	50 ... 133 V ≐	RC 5-1/133	1SBN 05 0100 R1001	2	0.012
	110 ... 250 V ≐	RC 5-1/250	1SBN 05 0100 R1002	2	0.012
	250 ... 440 V ≐	RC 5-1/440	1SBN 05 0100 R1003	2	0.012

Function Marker

Feature	Mounting on contactor relays :	Type	Order code	Pack ^{ing}	Weight
				box	kg
50 pcs in a box	N	BA 5-50	1SBN 11 0000 R1000	1	0.017

>> Dimensions page 16/47

DLA Starters

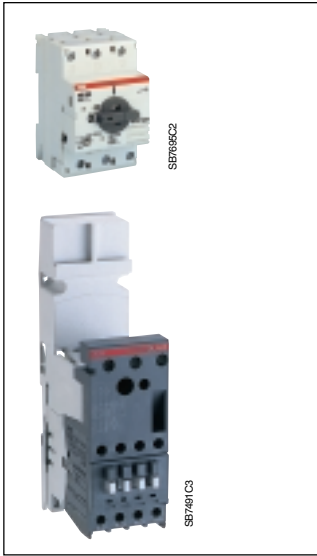

General information

The construction of DLA starters is based on ABB "A" series contactors. The mounting plate, comprising a built-in A contactor, is designed to integrate an ABB manual motor starter type MS 325.

Starters can be easily made with protection against overloads and short-circuits (type I or II co-ordination).

The technical characteristics of these devices are identical to those of A contactors.

The advantages in utilization are as follow:

- Simplified implementation:

- DLA starters clip onto 35 x 15 mm exclusively top hat rail (EN 50022).
- direct mounting of manual motor starter MS 325.
- contactor coil terminals accessible on lower side.

- High performance has a result of the combination of the MS 325 manual motor starter with high breaking capacity (up to 50 kA), and a latest-generation contactor ensuring high electrical durability.

- Accessory types:

- on manual motor starter: set of supply bars, rotating control, padlock holder, auxiliary contact, undervoltage coil, etc.
- On D.O.L. starter: please consult us.

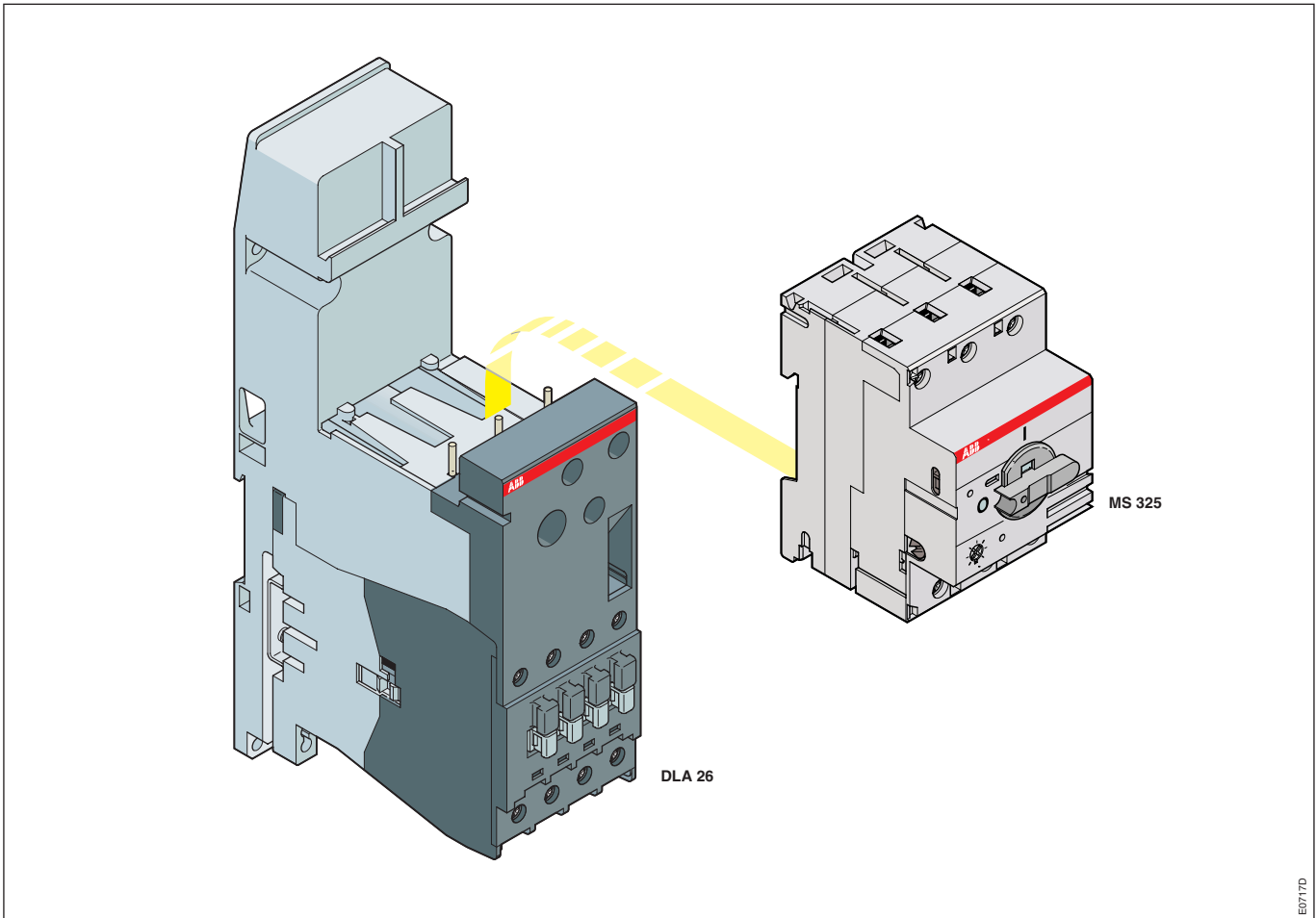

DLA Starters

Orderings details

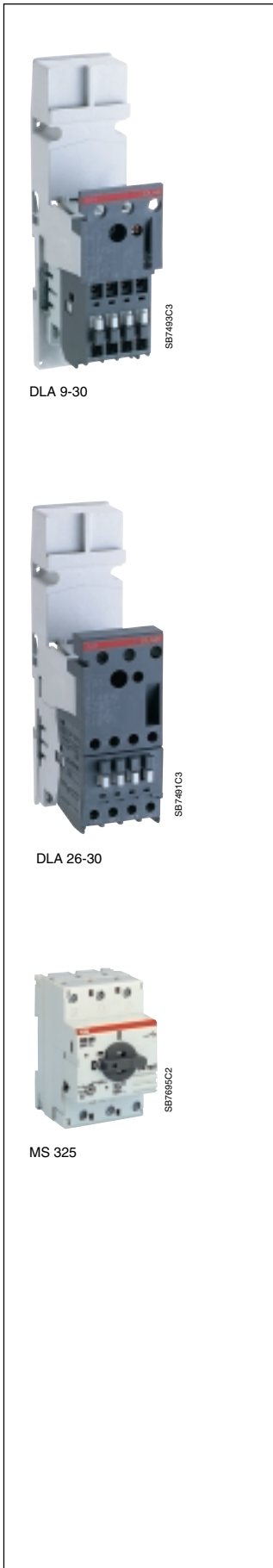

DLA Starters

Rated operational current	AC-3	AC-1	Mounted auxiliary contacts	Type	Order code (1)	Weight kg
380 V						
400 V	415 V	$\theta \leq 40^\circ\text{C}$		Coil voltage in clear text: <input type="text"/>	to be completed with coil voltage code: <input type="checkbox"/> <input type="checkbox"/>	Pack ^{ing} 1 piece
A	A	A				
9	9	25	1 -	DLA 9-30 <input type="text"/>	1SBK 14 0403 R <input type="checkbox"/> <input type="checkbox"/> 00	0.650
12	12	27	1 -	DLA 12-30 <input type="text"/>	1SBK 16 0403 R <input type="checkbox"/> <input type="checkbox"/> 00	0.650
17	17	30	1 -	DLA 16-30 <input type="text"/>	1SBK 18 0403 R <input type="checkbox"/> <input type="checkbox"/> 00	0.650
26	26	45	1 -	DLA 26-30 <input type="text"/>	1SBK 24 0403 R <input type="checkbox"/> <input type="checkbox"/> 00	0.930

(1) MS 325 must be ordered separately.

MS 325 Manual Motor Starter

Setting range	Type	Order code	Weight kg
A			Pack ^{ing} 1 piece
0.1 ... 0.16	MS 325-0.16	1SAM 15 0000 R0001	0.347
0.16 ... 0.25	MS 325-0.25	1SAM 15 0000 R0002	0.347
0.23 ... 0.4	MS 325-0.4	1SAM 15 0000 R0003	0.347
0.4 ... 0.63	MS 325-0.63	1SAM 15 0000 R0004	0.347
0.63 ... 1.0	MS 325-1.0	1SAM 15 0000 R0005	0.347
1.0 ... 1.6	MS 325-1.6	1SAM 15 0000 R0006	0.347
1.6 ... 2.5	MS 325-2.5	1SAM 15 0000 R0007	0.347
2.5 ... 4.0	MS 325-4.0	1SAM 15 0000 R0008	0.347
4.0 ... 6.3	MS 325-6.3	1SAM 15 0000 R0009	0.347
6.3 ... 9.0	MS 325-9.0	1SAM 15 0000 R0010	0.347
9.0 ... 12.5	MS 325-12.5	1SAM 15 0000 R0011	0.347
12.5 ... 16.0	MS 325-16.0	1SAM 15 0000 R0012	0.347
16.0 ... 20.0	MS 325-20.0	1SAM 15 0000 R0013	0.347
20.0 ... 25.0	MS 325-25.0	1SAM 15 0000 R0014	0.347

Coil voltages and codes DLA 9 ... DLA 26

Voltage (V)	Voltage code :
50 Hz : <input type="text"/>	<input type="checkbox"/> <input type="checkbox"/>
24	<input type="checkbox"/> <input type="checkbox"/>
48	<input type="checkbox"/> <input type="checkbox"/>
110	<input type="checkbox"/> <input type="checkbox"/>
220 ... 230	<input type="checkbox"/> <input type="checkbox"/>
230 ... 240	<input type="checkbox"/> <input type="checkbox"/>
380 ... 400	<input type="checkbox"/> <input type="checkbox"/>
400 ... 415	<input type="checkbox"/> <input type="checkbox"/>

Other voltages : page 16/34.

- >> Technical data (same as for the contactor) page 16/30
- >> Accessories for MS 325 Manual Motor Starter section 2
- >> Dimensions 16/48

Open Type Star-Delta Starters – a.c. Coil

YKA 9-30 ... YDA 110-30

Ordering Details

Star-Delta starters, factory-assembled. Thermal O/L relay to be ordered separately (1).

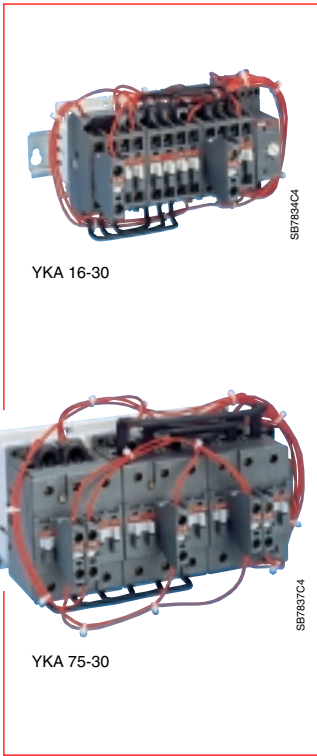

Rated operational current AC-3		Type	Order code	Weight
380 V	415 V	State coil	to be completed with	Packing
400 V	A	voltage: <input type="checkbox"/>	coil voltage code : <input type="checkbox"/>	1 piece
15.5	14	YKA 9-30 <input type="checkbox"/>	1SBK 14 2301 R8 <input type="checkbox"/> 00	1.610
22	21	YKA 12-30 <input type="checkbox"/>	1SBK 16 2301 R8 <input type="checkbox"/> 00	1.610
30	28	YKA 16-30 <input type="checkbox"/>	1SBK 18 2301 R8 <input type="checkbox"/> 00	1.610
44	40	YKA 26-30 <input type="checkbox"/>	1SBK 24 2301 R8 <input type="checkbox"/> 00	2.120
50	47	YKA 30-30 <input type="checkbox"/>	1SBK 28 2301 R8 <input type="checkbox"/> 00	3.125
72	66	YKA 40-30 <input type="checkbox"/>	1SBK 32 2301 R8 <input type="checkbox"/> 00	3.135
85	80	YKA 50-30 <input type="checkbox"/>	1SBK 35 2301 R8 <input type="checkbox"/> 00	4.130
105	96	YKA 63-30 <input type="checkbox"/>	1SBK 37 2301 R8 <input type="checkbox"/> 00	4.135
119	126	YKA 75-30 <input type="checkbox"/>	1SBK 41 2301 R8 <input type="checkbox"/> 00	4.480
140	135	YDA 95-30 <input type="checkbox"/>	1SFK 43 2302 R8 <input type="checkbox"/> 00	7.000
170	182	YDA 110-30 <input type="checkbox"/>	1SFK 45 2302 R8 <input type="checkbox"/> 00	7.000

(1) The setting current value is : motor rated current I_n x 0.58.

Coil voltages and codes

Voltage (V) 50 Hz : <input type="checkbox"/>	Voltage (V) 60 Hz : <input type="checkbox"/>	Coil voltage code : <input type="checkbox"/>
24	24	<input type="checkbox"/> 1
110	110...120	<input type="checkbox"/> 4
220 ... 230	230...240	<input type="checkbox"/> 0
380 ... 400	400...415	<input type="checkbox"/> 5

Other Versions:

- starter control circuit is suitable for separate supply. For direct supply version, please consult us.
- starter c/w mechanical interlocking, please consult us.

Starters in kit form

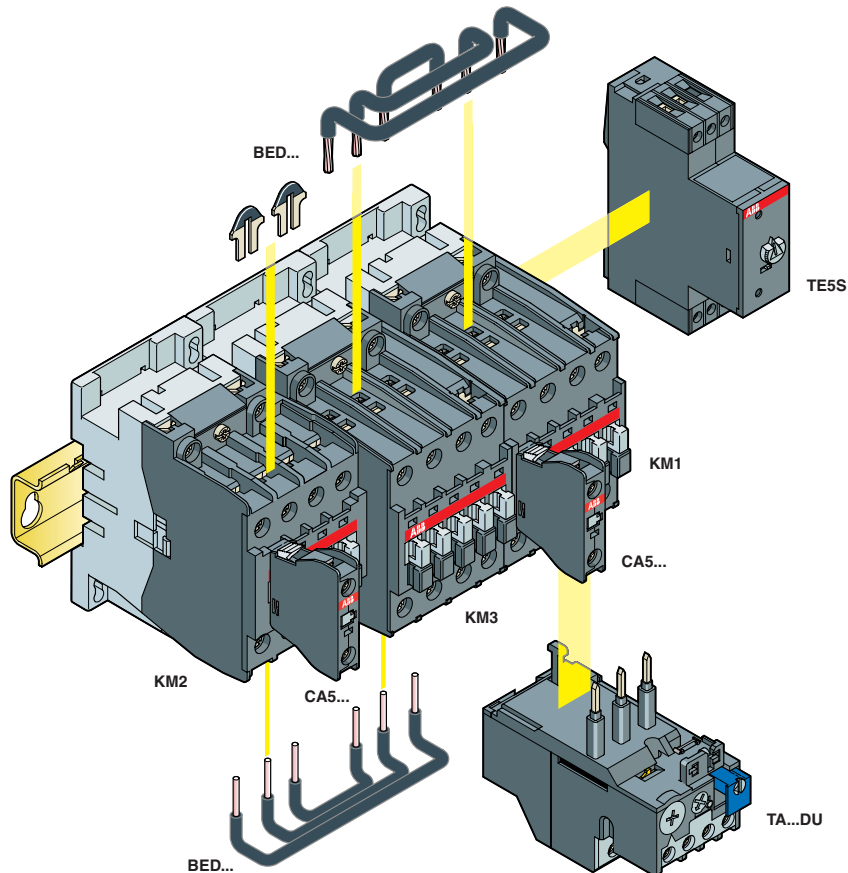

>> Contactor technical data page 16/30
 >> Accessories page 16/6

>> Thermal O/L relays page 16/12
 >> Dimensions and wiring diagrams page 16/49 ... 16/51, 16/53

Open Type Star-Delta Starters – a.c. Coil YKA 9-30 ... YDA 110-30

Ordering details

Components for Star-Delta Starters, in kit form

Rated operational current AC-3 380 V 400 V 415 V A A	Line Contactor		Star Contactor \wedge	Delta Contactor Δ	Thermal O/L relay (1) FR1	Required accessories (see table below).
	KM1	Type, state coil voltage: <input type="checkbox"/>	KM2	KM3	Type Order code	Reference letters
15.5 14	A 9-30-10 <input type="checkbox"/>	<input type="checkbox"/>	A 9-30-01 <input type="checkbox"/>	A 9-30-01 <input type="checkbox"/>	TA 25 DU 11	A
	1SBL 14 1001 R8 <input type="checkbox"/>	10	1SBL 14 1001 R8 <input type="checkbox"/>	1SBL 14 1001 R8 <input type="checkbox"/>	1SAZ 21 1201 R1043	
22 21	A 12-30-10 <input type="checkbox"/>	<input type="checkbox"/>	A 9-30-01 <input type="checkbox"/>	A 12-30-01 <input type="checkbox"/>	TA 25 DU 14	A
	1SBL 16 1001 R8 <input type="checkbox"/>	10	1SBL 14 1001 R8 <input type="checkbox"/>	1SBL 16 1001 R8 <input type="checkbox"/>	1SAZ 21 1201 R1045	
30 28	A 16-30-10 <input type="checkbox"/>	<input type="checkbox"/>	A 12-30-01 <input type="checkbox"/>	A 16-30-01 <input type="checkbox"/>	TA 25 DU 19	A
	1SBL 18 1001 R8 <input type="checkbox"/>	10	1SBL 16 1001 R8 <input type="checkbox"/>	1SBL 18 1001 R8 <input type="checkbox"/>	1SAZ 21 1201 R1047	
44 40	A 26-30-10 <input type="checkbox"/>	<input type="checkbox"/>	A 16-30-01 <input type="checkbox"/>	A 26-30-01 <input type="checkbox"/>	TA 25 DU 25	B
	1SBL 24 1001 R8 <input type="checkbox"/>	10	1SBL 18 1001 R8 <input type="checkbox"/>	1SBL 24 1001 R8 <input type="checkbox"/>	1SAZ 21 1201 R1051	
50 47	A 30-30-10 <input type="checkbox"/>	<input type="checkbox"/>	A 26-30-01 <input type="checkbox"/>	A 30-30-01 <input type="checkbox"/>	TA 25 DU 32	C
	1SBL 28 1001 R8 <input type="checkbox"/>	10	1SBL 24 1001 R8 <input type="checkbox"/>	1SBL 28 1001 R8 <input type="checkbox"/>	1SAZ 21 1201 R1053	
72 66	A 40-30-10 <input type="checkbox"/>	<input type="checkbox"/>	A 26-30-01 <input type="checkbox"/>	A 40-30-01 <input type="checkbox"/>	TA 42 DU 42	C
	1SBL 32 1001 R8 <input type="checkbox"/>	10	1SBL 24 1001 R8 <input type="checkbox"/>	1SBL 32 1001 R8 <input type="checkbox"/>	1SAZ 31 1201 R1003	
85 80	A 50-30-00 <input type="checkbox"/>	<input type="checkbox"/>	A 30-30-01 <input type="checkbox"/>	A 50-30-00 <input type="checkbox"/>	TA 75 DU 52	D
	1SBL 35 1001 R8 <input type="checkbox"/>	00	1SBL 28 1001 R8 <input type="checkbox"/>	1SBL 35 1001 R8 <input type="checkbox"/>	1SAZ 32 1201 R1004	
105 96	A 63-30-00 <input type="checkbox"/>	<input type="checkbox"/>	A 40-30-01 <input type="checkbox"/>	A 63-30-00 <input type="checkbox"/>	TA 75 DU 63	D
	1SBL 37 1001 R8 <input type="checkbox"/>	00	1SBL 32 1001 R8 <input type="checkbox"/>	1SBL 37 1001 R8 <input type="checkbox"/>	1SAZ 32 1201 R1005	
119 –	A 75-30-00 <input type="checkbox"/>	<input type="checkbox"/>	A 50-30-00 <input type="checkbox"/>	A 75-30-00 <input type="checkbox"/>	TA 75 DU 80	E
– 126	1SBL 41 1001 R8 <input type="checkbox"/>	00	1SBL 35 1001 R8 <input type="checkbox"/>	1SBL 41 1001 R8 <input type="checkbox"/>	1SAZ 32 1201 R1006	
140 –	A 95-30-00 <input type="checkbox"/>	<input type="checkbox"/>	A 75-30-00 <input type="checkbox"/>	A 95-30-00 <input type="checkbox"/>	TA 110 DU 90	F
– 135	1SFL 43 1001 R8 <input type="checkbox"/>	00	1SFL 41 1001 R8 <input type="checkbox"/>	1SFL 43 1001 R8 <input type="checkbox"/>	1SAZ 41 1201 R1001	
170 –	A 110-30-00 <input type="checkbox"/>	<input type="checkbox"/>	A 95-30-00 <input type="checkbox"/>	A 110-30-00 <input type="checkbox"/>	TA 110 DU 110	G
– 182	1SFL 45 1001 R8 <input type="checkbox"/>	00	1SFL 43 1001 R8 <input type="checkbox"/>	1SFL 45 1001 R8 <input type="checkbox"/>	1SAZ 41 1201 R1002	

(1) The setting current value is : motor rated current I_n x 0.58.

Required accessories

Ref. letter	Connection set Type Order code	KM1 Aux. contacts Type Order code	KM2 Aux. Contacts Type Order code	KM3 Aux. Contacts Type Order code	Timer Type Order code	Plate Type Order code
A	BED 16.1 1SBN 08 1403 R1001					
B	BED 26.1 1SBN 08 2403 R1001	CA 5-10 1SBN 01 0010 R1010	CA 5-10 1SBN 01 0010 R1010	–		–
C	BED 40.1 1SBN 08 2803 R1001					
D	BED 50.1 1SBN 08 3503 R1001	2 x CA 5-10 1SBN 01 0010 R1010	CA 5-10 1SBN 01 0010 R1010	CA 5-01 1SBN 01 0010 R1001		–
E	BED 75.1 1SBN 08 4103 R1001		1 x CA 5-10			–
F	BED 95 1 SFN 08 4303 R1000	2 x CA 5-10 1SBN 01 0010 R1010	1SBN 01 0010 R1010 1 x CA 5-01	CA 5-01 1SBN 01 0010 R1001		PN110-41 1 SFN 09 4303 R1000
G	BED 110 1 SFN 08 4503 R1000		1SBN 01 0010 R1001			PN110-41 1 SFN 09 4303 R1000

According to the control voltage (50/60Hz)

24 V	TE5S-24 1SBN 02 0010R1001
110...120 V	TE5S-120 1SBN 02 0010R1002
220...240 V	TE5S-240 1SBN 02 0010R1003
380...440 V	TE5S-440 1SBN 02 0010R1004

Other Version:

- starter c/w mechanical interlocking, please consult us.

>> Contactor technical data page 16/30	>> Thermal O/L relays page 16/12
>> Accessories page 16/6	>> Dimensions and wiring diagrams page 16/49 ... 16/51, 16/53

Open Type Reversing Contactors – a.c. Coil VOA 9-30M ... VNA 110-30M

Ordering Details

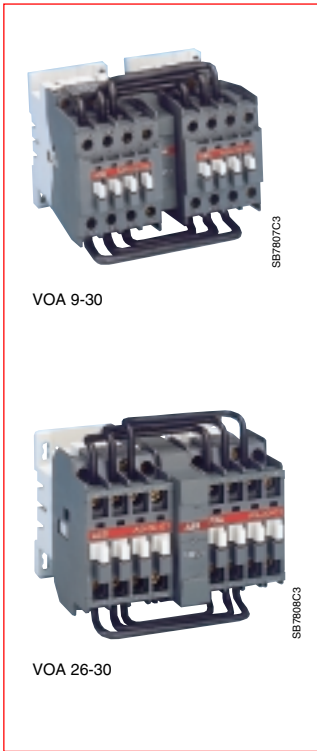

Reversing Contactors, factory-assembled, c/w mechanical interlocking and power connections.

Rated operational current AC-3 380 V 400 V 415 V A	Type	Order code	Weight kg
	State coil voltage: <input type="text"/>	to be completed with coil voltage code: <input type="checkbox"/>	Pack ^{ing} 1 piece
9	VOA 9-30 <input type="text"/>	1SBK 14 1600 R8 <input type="checkbox"/> 00	0.940
12	VOA 12-30M <input type="text"/>	1SBK 16 1600 R8 <input type="checkbox"/> 00	0.940
17	VOA 16-30M <input type="text"/>	1SBK 18 1600 R8 <input type="checkbox"/> 00	0.940
26	VOA 26-30M <input type="text"/>	1SBK 24 1600 R8 <input type="checkbox"/> 00	1.470
32	VOA 30-30M <input type="text"/>	1SBK 28 1600 R8 <input type="checkbox"/> 00	1.710
37	VOA 40-30M <input type="text"/>	1SBK 32 1600 R8 <input type="checkbox"/> 00	1.720
96	VNA 95-30M <input type="text"/>	1SFK 43 1702 R8 <input type="checkbox"/> 00	6.800
110	VNA 110-30M <input type="text"/>	1SFK 45 1702 R8 <input type="checkbox"/> 00	6.800

The hold-in function, if necessary, will be carried out with the help of CA 5-10 type N.O. auxiliary contacts (1 on each contactor) to be supplied separately (see page 16/25).

Coil voltages and codes

Voltage (V) 50 Hz : <input type="text"/>	Voltage (V) 60 Hz : <input type="text"/>	Coil voltage code : <input type="checkbox"/>
24	24	<input type="checkbox"/> 1
48	48	<input type="checkbox"/> 3
110	110...120	<input type="checkbox"/> 4
220 ... 230	230...240	<input type="checkbox"/> 0
380 ... 400	400...415	<input type="checkbox"/> 5

The control circuit is to be wired when putting the reversing contactor into service.

Reversing contactors, in kit form

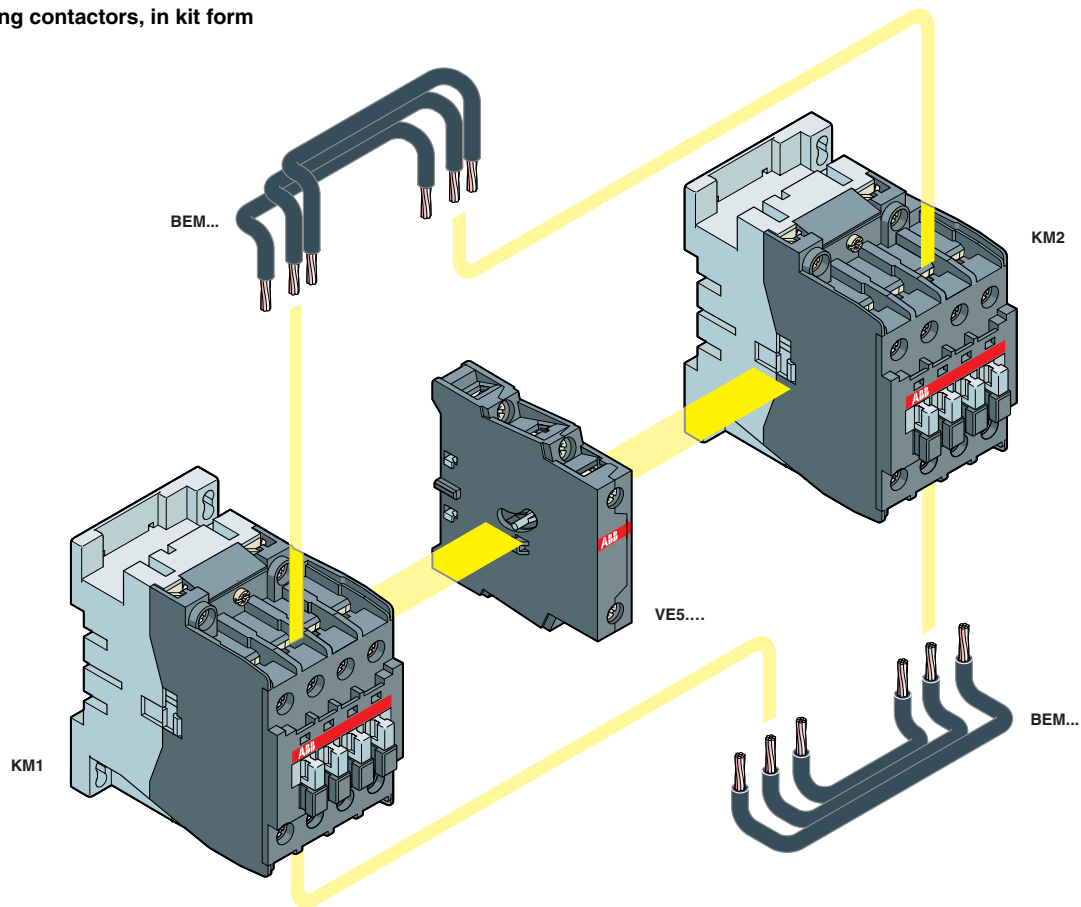

E1112D

Open Type Reversing Contactors – a.c. Coil VOA 9-30M ... VNA 110-30M

Ordering Details

Components for Reversing Contactors, in kit form

Rated operational current AC-3 380 V 400 V 415 V A	KM1 + KM2 contactors (1)	Interlocking	Connection set
	Type, state coil voltage: [] Order code, to be completed with coil voltage code: []	Type Order code	Type Order code
9	2 x A 9-30-10 [] 1SBL 14 1001 R8 [] 10	1 x VE 5-1 1SBN 03 0110 R1000	1 x BEM 16-30 1SBN 08 1401 R1000
12	2 x A 12-30-10 [] 1SBL 16 1001 R8 [] 10		
17	2 x A 16-30-10 [] 1SBL 18 1001 R8 [] 10		1 x BEM 26-30 1SBN 08 2401 R1000
26	2 x A 26-30-10 [] 1SBL 24 1001 R8 [] 10		
32	2 x A 30-30-10 [] 1SBL 28 1001 R8 [] 10	1 x VE 5-2 1SBN 03 0210 R1000	1 x BEM 40-30 1SBN 08 2801 R1000
37	2 x A 40-30-10 [] 1SBL 32 1001 R8 [] 10		1 x BEM 110-30 1SFN 08 4301 R1000
96	2 x A 95-30-00 [] 1SFL 43 1001 R8 [] 00		
110	2 x A 110-30-00 [] 1SFL 45 1001 R8 [] 00		

(1) On each A9 ... A40 contactor, one N.O. built-in auxiliary contact is available for the hold-in function.

Auxiliary Contact Blocks

Positioning	Contacts 	Type	Order code	Pack ^{ing}	Weight
				pieces	kg
Front	1 -	CA 5-10	1SBN 01 0010 R1010	10	0.014
	- 1	CA 5-01	1SBN 01 0010 R1001	10	0.014
	3 1	CA 5-31M	1SBN 01 0040 R1131	2	0.060
	2 2	CA 5-22M	1SBN 01 0040 R1122	2	0.060
Side	1 1	CAL 5-11	1SBN 01 0020 R1011	2	0.050



Function Markers

Description	Type	Order code	Pack ^{ing} box	Weight kg
Box of 50 pieces	BA 5-50	1SBN 11 0000 R1000	1	0.090

VOA.-40Z Changeover Contactors – a.c. Coil

Ordering Details

Changeover Contactors, factory-assembled, c/w mechanical interlocking.
Power connection set to be ordered separately (see table below).

Rated operational current AC-1 $\theta \leq 40^\circ\text{C}$ A	Mounted aux. contacts	Type	Order code	Weight kg	Packing
	 	state coil voltage: <input type="text"/>	to be completed with coil voltage code: <input type="checkbox"/>		1 piece
70	– –	VOA 45-40Z <input type="text"/>	1SBK 33 1900 R8 <input type="checkbox"/> 00	3.020	
100	– –	VOA 50-40Z <input type="text"/>	1SBK 35 1900 R8 <input type="checkbox"/> 00	3.020	
125	– –	VOA 75-40Z <input type="text"/>	1SBK 41 1900 R8 <input type="checkbox"/> 00	3.020	

Connection Set

Connection utilization	Type	Order code	Weight kg	Packing
Coupling for the downstream terminals	BES 75-40	1SBN 08 3302 R1000	0.400	1 set

Coil voltages and codes

Voltage (V) 50 Hz : <input type="text"/>	Voltage (V) 60 Hz : <input type="text"/>	Coil voltage code : <input type="checkbox"/>
24	24	<input type="checkbox"/> 1
48	48	<input type="checkbox"/> 3
110	110...120	<input type="checkbox"/> 4
220 ... 230	230...240	<input type="checkbox"/> 0
380 ... 400	400...415	<input type="checkbox"/> 5

The control circuit is to be wired when putting the changeover contactor into service.

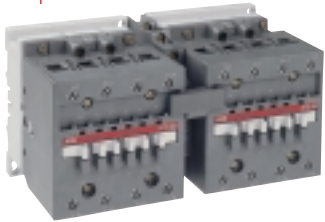

SB8104C4

VOA 50-40Z

Changeover contactors, in kit form

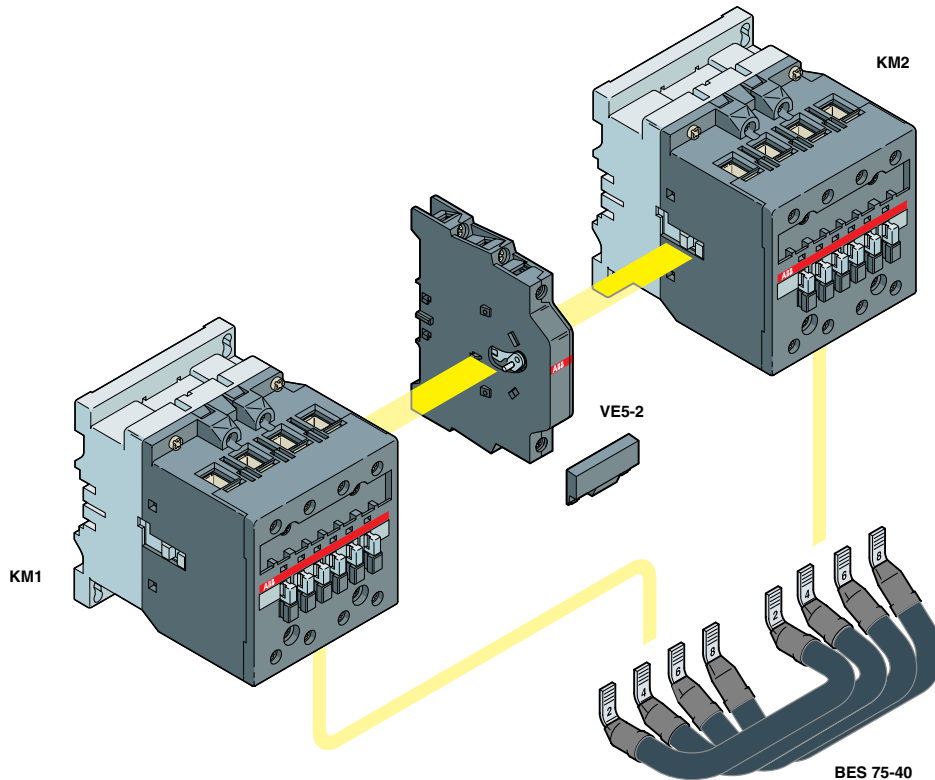

E1106D2

Changeover Contactors – a.c. Coil

Ordering Details

Components for Changeover Contactors, in kit form

Rated operational current AC-1 $\theta \leq 40\text{ }^\circ\text{C}$ A	KM1 + KM2 Contactors	Interlocking	Connection set
	Type, state coil voltage: <input type="checkbox"/> Order code, to be completed with coil voltage code: <input type="checkbox"/>	Type Order code	Type Order code
70	2 x A 45-40-00 <input type="checkbox"/> 1SBL 33 1201 R8 <input type="checkbox"/> 00	1 x VE 5-2 1SBN 03 0210 R1000	1 x BES 75-40 1SBN 08 3302 R1000
100	2 x A 50-40-00 <input type="checkbox"/> 1SBL 35 1201 R8 <input type="checkbox"/> 00		
125	2 x A 75-40-00 <input type="checkbox"/> 1SBL 41 1201 R8 <input type="checkbox"/> 00		

Auxiliary Contacts Blocks

Positioning	Contacts 	Type	Order code	Pack ^{ing}	Weight
				pieces	kg
Front	1 -	CA 5-10	1SBN 01 0010 R1010	10	0.014
	- 1	CA 5-01	1SBN 01 0010 R1001	10	0.014
	4 -	CA 5-40E	1SBN 01 0040 R1040	2	0.060
	2 2	CA 5-22E	1SBN 01 0040 R1022	2	0.060
Side	1 1	CAL 5-11	1SBN 01 0020 R1011	2	0.050

Function Markers

Description	Type	Order code	Pack ^{ing} box	Weight kg
Box of 50 pieces	BA 5-50	1SBN 11 0000 R1000	1	0.090

Auxiliary Lead Terminals

Connection	Type	Order code	Pack ^{ing} pieces	Weight kg
Right/left	LK 75-L	1SBN 07 3552 R1003	2	0.006
Front	LK 75-F	1SBN 07 3552 R1002	2	0.006

Contact Sets - Coils

Ordering Details

Contact Sets

For contactor :	Type	Order code	Pack ^{ing} set	Weight kg
3 -pole	A 50	ZL 50	1SBN 16 3503 R1000	1 0.115
	A 63	ZL 63	1SBN 16 3703 R1000	1 0.130
	A 75	ZL 75	1SBN 16 4103 R1000	1 0.145
	A 95	ZL 95	1SFN 16 4303 R1000	1 0.190
	A 110	ZL 110	1SFN 16 4503 R1000	1 0.190
	A 145	ZL 145	1SFN 16 4703 R1000	1 0.380
	A 185	ZL 185	1SFN 16 4903 R1000	1 0.380
	A 210	ZL 210	1SFN 16 5103 R1000	1 0.670
	A 260	ZL 260	1SFN 16 5303 R1000	1 0.670
	A 300	ZL 300	1SFN 16 5503 R1000	1 0.670
4 -pole	AF 400	ZL 400	1SFN 16 5703 R1000	1 1.320
	AF 460	ZL 460	1SFN 16 5903 R1000	1 1.320
	AF 580	ZL 580	1SFN 16 6103 R1000	1 1.840
	AF 750	ZL 750	1SFN 16 6303 R1000	1 1.840
	A 45	ZLT 45	1SBN 16 3304 R1000	1 0.150
	A 50	ZLT 50	1SBN 16 3504 R1000	1 0.150
	A 75	ZLT 75	1SBN 16 4104 R1000	1 0.160
	EK 110	KZK 110	SK 824 204-A	1 0.450
	EK 150	KZK 150	SK 824 204-B	1 0.450
	EK 175	KZK 175	SK 825 204-A	1 0.700
EK 210	KZK 210	SK 825 204-B	1 0.700	
EK 370	KZK 370	SK 827 204-A	1 2.400	
EK 550	KZK 550	SK 827 204-B	1 2.400	
EK 1000	KZK 1000	SK 827 204-F	1 2.400	

Coils

For contactor :	Type	Order code	Pack ^{ing} piece	Weight kg
	State coil voltage: <input type="text"/>	coil voltage code see table below: <input type="checkbox"/> <input type="checkbox"/>		
3 -pole	A 9 ... A 16	ZA 16 <input type="text"/>	1SBN 15 1410 R <input type="text"/> <input type="text"/> 06	1 0.093
	A 26 ... A 40	ZA 40 <input type="text"/>	1SBN 15 2410 R <input type="text"/> <input type="text"/> 06	1 0.148
	A 50 ... A 75	ZA 75 <input type="text"/>	1SBN 15 3510 R <input type="text"/> <input type="text"/> 06	1 0.166
	A 95 ... A 110	ZA 110 <input type="text"/>	1SFN 15 4310 R <input type="text"/> <input type="text"/> 06	1 0.195
	A 145 ... A 185	ZA 185 <input type="text"/>	1SFN 15 4710 R <input type="text"/> <input type="text"/> 06	1 0.180
	A 210 ... A 300	ZA 300 <input type="text"/>	1SFN 15 5110 R <input type="text"/> <input type="text"/> 06	1 0.410
4 -pole	AF 400 ... AF 460	ZAF 460 <input type="text"/>	1SFN 15 5770 R <input type="text"/> <input type="text"/> 06	1 0.525
	AF 580 ... AF 750	ZAF 750 <input type="text"/>	1SFN 15 6170 R <input type="text"/> <input type="text"/> 06	1 1.335
	A 9 ... A 16	ZA 16 <input type="text"/>	1SBN 15 1410 R <input type="text"/> <input type="text"/> 06	1 0.093
	A 26	ZA 40 <input type="text"/>	1SBN 15 2410 R <input type="text"/> <input type="text"/> 06	1 0.148
	A 45 ... A 75	ZA 75 <input type="text"/>	1SBN 15 3510 R <input type="text"/> <input type="text"/> 06	1 0.166
	EK 110 ... EK 150	KH 210 <input type="text"/>	SK 825 400 - <input type="checkbox"/> <input type="checkbox"/>	1 0.360
EK 175 ... EK 210	KH 300 <input type="text"/>	SK 826 400 - <input type="checkbox"/> <input type="checkbox"/>	1 0.440	
EK 370 ... EK 1000	KH 800 <input type="text"/>	SK 828 100 - <input type="checkbox"/> <input type="checkbox"/>	1 0.950	
Cont. relay	N	ZA 16 <input type="text"/>	1 SBN 15 1410 R <input type="text"/> <input type="text"/> 06	1 0.093

Coil voltages and codes A, N

Voltage (V) 50 Hz : <input type="text"/>	Voltage (V) 60 Hz : <input type="text"/>	Voltage code : <input type="checkbox"/> <input type="checkbox"/>
24	24	<input type="checkbox"/> <input type="checkbox"/>
48	48	<input type="checkbox"/> <input type="checkbox"/>
110	110	<input type="checkbox"/> <input type="checkbox"/>
220 ... 230	230...240	<input type="checkbox"/> <input type="checkbox"/>
230 ... 240	240...260	<input type="checkbox"/> <input type="checkbox"/>
380 ... 400	400...415	<input type="checkbox"/> <input type="checkbox"/>
400 ... 415	415...440	<input type="checkbox"/> <input type="checkbox"/>

Other voltages : page 16/34.

Coil voltages and codes AF 400 ... AF 750

Voltage (V) 50 Hz : <input type="text"/>	Voltage (V) 60 Hz : <input type="text"/>	Voltage code : <input type="checkbox"/> <input type="checkbox"/>
-	24 ... 60	<input type="checkbox"/> <input type="checkbox"/>
48 ... 130	48 ... 130 ¹⁾	<input type="checkbox"/> <input type="checkbox"/>
100 ... 250	100 ... 250	<input type="checkbox"/> <input type="checkbox"/>
200 ... 500	200 ... 500 ¹⁾	<input type="checkbox"/> <input type="checkbox"/>

1) Available after 2001

Coil voltages and codes EK

Voltage (V) 50 Hz : <input type="text"/>	Voltage (V) 60 Hz : <input type="text"/>	Voltage code : <input type="checkbox"/> <input type="checkbox"/>
48	-	<input type="checkbox"/> <input type="checkbox"/>
-	110	<input type="checkbox"/> <input type="checkbox"/>
110	120	<input type="checkbox"/> <input type="checkbox"/>
220 ... 230	-	<input type="checkbox"/> <input type="checkbox"/>
230 ... 240	-	<input type="checkbox"/> <input type="checkbox"/>
-	380	<input type="checkbox"/> <input type="checkbox"/>
380 ... 400	440	<input type="checkbox"/> <input type="checkbox"/>
400 ... 415	-	<input type="checkbox"/> <input type="checkbox"/>

Other voltages : page 16/35.

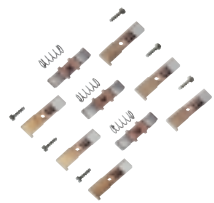

ZL 50

SB 8540 C3



ZL ...

1SFT98099-007



KZ 370

SB 7382 C3



ZA 16

SB 7380 C2



ZA 185

1SFT98099-010

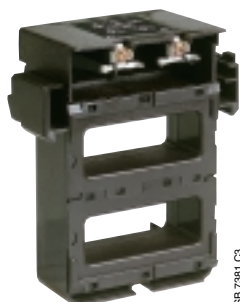

KH 300

SB 7381 C3

Motor Rating and Rated Current

The currents shown in the table below are those given for standard three phase squirrel-cage motors. 1500 r.p.m. 50 Hz. Values quoted are for guidance only, they can vary depending on the number of poles and design.

Motor rating kW	PS = hp	Motor rated current at :		380 V 380-400 V A	415 V A	440 V A	500 V A	600 V A	660-690 V A
		220-230 V A	240 V A						
0.06	1/12	0.38	0.35	0.22	0.20	0.19	0.16	0.12	–
0.09	1/8	0.55	0.50	0.33	0.30	0.28	0.24	0.21	–
0.12	1/6	0.76	0.68	0.42	0.40	0.37	0.33	0.27	–
0.18	1/4	1.1	1	0.64	0.60	0.55	0.46	0.40	–
0.25	1/3	1.4	1.38	0.88	0.85	0.76	0.59	0.56	–
0.37	1/2	2.1	1.93	1.22	1.15	1.06	0.85	0.77	0.7
0.55	3/4	2.7	2.3	1.5	1.40	1.25	1.20	1.02	0.9
0.75	1	3.3	3.1	2	2	1.67	1.48	1.22	1.1
1.1	1.5	4.9	4.1	2.6	2.5	2.26	2.1	1.66	1.5
1.5	2	6.2	5.6	3.5	3.5	3.03	2.6	2.22	2
2.2	3	8.7	7.9	5	5	4.31	3.8	3.16	2.9
2.5	3.4	9.8	8.9	5.7	5.5	4.9	4.3	3.59	3.3
3	4	11.6	10.6	6.6	6.5	5.8	5.1	4.25	3.5
3.7	5	14.2	13	8.2	7.5	7.1	6.2	5.2	4.4
4	5.5	15.3	14	8.5	8.4	7.6	6.5	5.6	4.9
5	6.8	18.9	17.2	10.5	10	9.4	8.1	6.9	6
5.5	7.5	20.6	18.9	11.5	11	10.3	8.9	7.5	6.7
6.5	8.8	23.7	21.8	13.8	12.5	12	10.4	8.7	8.1
7.5	10	27.4	24.8	15.5	14	13.5	11.9	9.9	9
8	11	28.8	26.4	16.7	15.4	14.4	12.7	10.6	9.7
9	12.5	32	29.3	18.3	17	15.8	13.9	11.6	10.6
11	15	39.2	35.3	22	21	19.3	16.7	14.1	13
12.5	17	43.8	40.2	25	23	21.9	19	16.1	15
15	20	52.6	48.2	30	28	26.3	22.5	19.3	17.5
18.5	25	64.9	58.7	37	35	32	28.5	23.5	21
20	27	69.3	63.4	40	37	34.6	30.6	25.4	23
22	30	75.2	68	44	40	37.1	33	27.2	25
25	34	84.4	77.2	50	47	42.1	38	30.9	28
30	40	101	92.7	60	55	50.1	44	37.1	33
37	50	124	114	72	66	61.9	54	45.4	42
40	54	134	123	79	72	67	60	49.1	44
45	60	150	136	85	80	73.9	64.5	54.2	49
51	70	168	154	97	90	83.8	73.7	61.4	56
55	75	181	166	105	96	90.3	79	66.2	60
59	80	194	178	112	105	96.9	85.3	71.1	66
75	100	245	226	140	135	123	106	90.3	82
80	110	260	241	147	138	131	112	96.3	86
90	125	292	268	170	165	146	128	107	98
100	136	325	297	188	182	162	143	119	107
110	150	358	327	205	200	178	156	131	118
129	175	420	384	242	230	209	184	153	135
132	180	425	393	245	242	214	186	157	140
140	190	449	416	260	250	227	200	167	145
147	200	472	432	273	260	236	207	173	152
160	220	502	471	295	280	256	220	188	170
180	245	578	530	333	320	289	254	212	190
184	250	590	541	340	325	295	259	217	200
200	270	626	589	370	340	321	278	235	215
220	300	700	647	408	385	353	310	260	235
250	340	803	736	460	425	401	353	295	268
257	350	826	756	475	450	412	363	302	280
295	400	948	868	546	500	473	416	348	320
315	430	990	927	580	535	505	445	370	337
355	480	1080	1010	636	580	549	483	405	366
400	545	1250	1130	710	650	611	538	450	410
450	610	1410	1270	800	740	688	608	508	460
475	645	1490	1340	850	780	730	645	540	485
500	680	1570	1420	890	830	770	680	565	510
560	760	1750	1580	1000	920	860	760	630	570
600	810	–	–	1080	990	920	810	680	610
670	910	–	–	1200	1100	1030	910	760	680

Technical Data

A 3-pole Contactors

A 3-pole Contactors

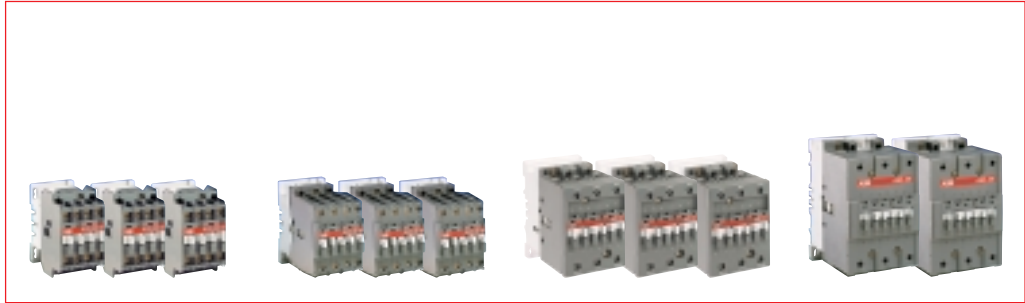

Types

A 9	A 12	A 16	A 26	A 30	A 40	A 50	A 63	A 75	A 95	A 110
------------	-------------	-------------	-------------	-------------	-------------	-------------	-------------	-------------	-------------	--------------

Rated operational current I_e / AC-3

220-230-240 V	A	9	12	17	26	33	40	53	65	75	96	110
380-400 V	A	9	12	17	26	32	37	50	65	75	96	110
415 V	A	9	12	17	26	32	37	50	65	72	96	110
440 V	A	9	12	16	26	32	37	45	65	70	93	100
500 V	A	9	12	14	22	28	33	45	55	65	80	100
690 V	A	7	9	10	17	21	25	35	43	46	65	82
1000 V	A	-	-	-	-	-	-	23	25	28	30	30

Rated operational current I_e / AC-1

$\theta \leq 40^\circ\text{C}$	A	25	27	30	45	55	60	100	115	125	145	160
$\theta \leq 55^\circ\text{C}$	A	22	25	27	40	55	60	85	95	105	135	145
$\theta \leq 70^\circ\text{C}$	A	18	20	23	32	39	42	70	80	85	115	130
with connecting cross-section	mm²	2.5	4	4	6	10	16	35	50	50	50	70
Max. back-up fuse gG (gl)	A	25	32	32	50	63	63	100	125	160	160	200

Fixing

See fixing details and dimensions page 16/38 ... 16/40

Connecting terminals

Cable clamp	Cable clamp	Double cable connector	Single cable connector	Single cable connector
-------------	-------------	------------------------	------------------------	------------------------

Connecting capacity

Main conductors (poles)

Rigid solid ($\leq 4 \text{ mm}^2$) or rigid stranded ($\geq 6 \text{ mm}^2$)	1 x mm²	1 ... 4	1.5 ... 6	2.5 ... 16	6 ... 50	10 ... 95
	2 x mm²	1 ... 4	1.5 ... 6	2.5 ... 16	6 ... 25	6 ... 35
Flexible without cable end	1 x mm²	0.75 ... 2.5	1 ... 4	2.5 ... 10	6 ... 35	10 ... 70
	2 x mm²	0.75 ... 2.5	1 ... 4	2.5 ... 10	6 ... 16	6 ... 35
Bars or lugs : max. width	mm \leq	8	10	-	-	-
hole \varnothing	mm $>$	3.7	4.2	-	-	-

Auxiliary conductors

Rigid solid	1 x mm²	1 ... 4	1 ... 4	1 ... 4	1 ... 4
	2 x mm²	1 ... 4	1 ... 4	1 ... 4	1 ... 4
Flexible without cable end	1 x mm²	0.75 ... 2.5	0.75 ... 2.5	0.75 ... 2.5	1 ... 2.5
	2 x mm²	0.75 ... 2.5	0.75 ... 2.5	0.75 ... 2.5	0.75 ... 2.5

Degree of protection of terminals

All terminals IP 20	All terminals IP 20	Main terminals IP 10	Auxiliary terminals IP 20
---------------------	---------------------	----------------------	---------------------------

Coil consumption

50 Hz pull-in	VA	70	120	180	350
50 Hz holding	VA/W	8/2	12/3	18/5.5	22/6.5

Built-in or Add-on Auxiliary Contacts

Rated operational current I_e / AC-15

24 ... 127 V : 6 A
220 ... 240 V : 4 A
380 ... 440 V : 3 A

Max. back-up fuse gG (gl)

10 A

Min. switching capacity

17 V / 5 mA

>> Dimensions page 16/38 ... 16/40

Technical Data

A, AF 3-pole Contactors

A, AF 3-pole Contactors



Types

A 145 A 185

A 210 A 260 A 300

AF 400 AF 460

AF 580 AF 750

Rated operational current I_e / AC-3

220-230-240 V	A	145	185	210	260	305	400	460	580	750
380-400 V	A	145	185	210	260	305	400	460	580	750
for air temperature around the contactor :										
415 V	A	145	185	210	260	300	400	460	580	750
440 V	A	145	185	210	240	280	370	460	580	750
$\theta \leq 55^\circ\text{C}$										
500 V	A	145	170	210	240	280	370	460	580	750
690 V	A	120	170	210	220	280	370	400	500	650
-	-	-	-	-	-	-	-	-	-	-

Rated operational current I_e / AC-1

for air temperature around the contactor :										
$\theta \leq 40^\circ\text{C}$	A	250	275	350	400	500	600	700	800	1050
$\theta \leq 55^\circ\text{C}$	A	230	250	300	350	400	500	600	700	800
$\theta \leq 70^\circ\text{C}$	A	180	180	240	290	325	400	480	580	720
with connecting cross-section	mm²	120	150	185	240	300	2 x 185	2 x 240	2 x 240	2 x 80 x 5

Max. back-up fuse gG (gl)	A	315	355	400	500	500	630	800	1000	1000
----------------------------------	----------	-----	-----	-----	-----	-----	-----	-----	------	------

Fixing

See fixing details and dimensions page 16/40 ... 16/44

Connecting terminals

Flat type c/w screws and bolts

Connecting capacity

Main conductors (poles)

Rigid with connector :

- single for Cu cable	mm²	6 ... 185	16 ... 240	240	300
- single for Al/Cu cable	mm²	25 ... 150	25 ... 240	240	300
- double for Al/Cu cable	mm²	-	2 x (95 ... 120)	2 x 240	3 x 185

Bars or lugs :

max. width	mm \leq	24	32	46	52
hole \varnothing	mm $>$	8	10	10/2 x 6	12/2 x 6

Auxiliary conductors

Rigid solid	1 x mm²	1 ... 4
	2 x mm²	1 ... 4
Flexible without cable end	1 x mm²	0.75 ... 2.5
	2 x mm²	0.75 ... 2.5

Degree of protection of terminals

Main terminals IP 00 - Auxiliary terminals IP 20

Coil consumption

50 Hz pull-in	VA	550	1350	810	450
50 Hz holding	VA/W	35/11	60/16	-/4.5	-/4.5

Add-on Auxiliary Contacts

Rated operational current I_e / AC-15

24 ... 127 V : 6 A
220 ... 240 V : 4 A
380 ... 440 V : 3 A

Max. back-up fuse gG (gl)	A	10 A
----------------------------------	----------	------

Min. switching capacity	17 V / 5 mA
--------------------------------	-------------

>> Dimensions page 16/40 ... 16/44

Technical Data

A 4-pole Contactors

A 4-pole Contactors

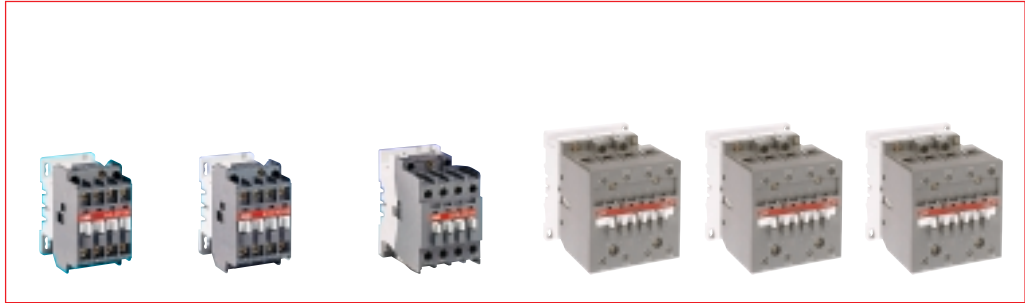

Types

A 9	A 16	A 26	A 45	A 50	A 75
------------	-------------	-------------	-------------	-------------	-------------

Rated operational current I_e / AC-1								
for air temperature around the contactor :	$\theta \leq 40^\circ\text{C}$	A	25	30	45	70	100	125
	$\theta \leq 55^\circ\text{C}$	A	22	27	40	60	85	105
	$\theta \leq 70^\circ\text{C}$	A	18	23	32	50	70	85
with connecting cross-section	mm ²		2.5	4	6	25	35	50
Max. back-up fuse gG (gl)	A		25	32	50	80	100	160
Fixing	See fixing details and dimensions page 16/45							
Connecting terminals	Cable clamp		Cable clamp			Single cable connector		
Connecting capacity								
Main conductors (poles)								
Rigid solid ($\leq 4\text{ mm}^2$) or rigid stranded ($\geq 6\text{ mm}^2$)	1 x mm ²	1 ... 4	1.5 ... 6	6 ... 50				
	2 x mm ²	1 ... 4	1.5 ... 6	6 ... 25				
Flexible without cable end	1 x mm ²	0.75 ... 2.5	1 ... 4	6 ... 35				
	2 x mm ²	0.75 ... 2.5	1 ... 4	6 ... 16				
Bars or lugs : max. width hole \varnothing	mm \leq	8	10	-				
	mm $>$	3.7	4.2	-				
Auxiliary conductors								
Rigid solid	1 x mm ²	1 ... 4	1 ... 4	1 ... 4				
	2 x mm ²	1 ... 4	1 ... 4	1 ... 4				
Flexible without cable end	1 x mm ²	0.75 ... 2.5	0.75 ... 2.5	1 ... 2.5				
	2 x mm ²	0.75 ... 2.5	0.75 ... 2.5	0.75 ... 2.5				
Degree of protection of terminals	All terminals IP 20		All terminals IP 20		Main terminals IP 10 Auxiliary terminals IP 20			
Coil consumption								
50 Hz pull-in	VA	70	120	180				
50 Hz holding	VA/W	8/2	12/3	18/5.5				

Add-on Auxiliary Contacts

Rated operational current I_e / AC-15	24 ... 127 V : 6 A 220 ... 240 V : 4 A 380 ... 440 V : 3 A
Max. back-up fuse gG (gl)	10 A
Min. switching capacity	17 V / 5 mA

Technical Data

EK 4-pole Contactors

EK 4-pole Contactors

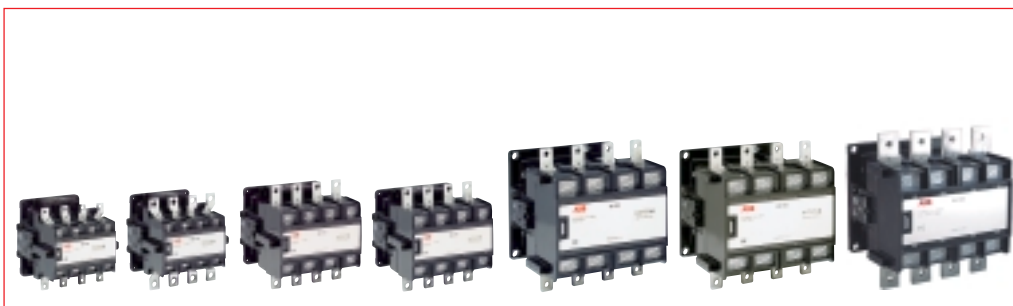

Types

EK 110 **EK 150** **EK 175** **EK 210** **EK 370** **EK 550** **EK 1000**

Rated operational current I_e / AC-1

	$\theta \leq 40\text{ }^{\circ}\text{C}$	A	200	250	300	350	550	800	1000
for air temperature	$\theta \leq 55\text{ }^{\circ}\text{C}$	A	180	230	270	310	470	650	800
around the contactor :	$\theta \leq 70\text{ }^{\circ}\text{C}$	A	155	200	215	250	400	575	720
with connecting cross-section	mm ²		95	150	185	240	2 x 185	2 x 240	2 x 300
Max. back-up fuse gG (gl)	A		250	250	355	355	630	800	1000

Fixing

See fixing details and dimensions page 16/46

Connecting terminals

Flat type c/w screws and bolts

Connecting capacity

Main conductors (poles)

Rigid with connector :

- single for Cu cable	mm ²	25 ... 120	25 ... 185	25 ... 185	70 ... 300
- single for Al/Cu cable	mm ²	10 ... 70	35 ... 120	35 ... 120	70 ... 300
- double for Al/Cu cable	mm ²	-	-	-	35 ... 185

Bars or lugs :

max. width	mm ≤	30	30	33	55
hole Ø	mm >	6	10	10	10

Auxiliary conductors

Rigid solid	1 x mm ²	0.5 ... 2.5		0.5 ... 2.5	0.5 ... 2.5
	2 x mm ²	0.5 ... 2.5		0.5 ... 2.5	0.5 ... 2.5
Flexible without cable end	1 x mm ²	0.5 ... 2.5		0.5 ... 2.5	0.5 ... 2.5
	2 x mm ²	0.5 ... 2.5		0.5 ... 2.5	0.5 ... 2.5

Degree of protection of terminals

Main terminals IP 00 - Auxiliary terminals IP 20

Coil consumption

50 Hz pull-in	VA	800	1100	3500
50 Hz holding	VA/W	44/15	52/18	125/56

Add-on Auxiliary Contacts

Rated operational current I_e / AC-15

24 ... 127 V : 6 A
220 ... 240 V : 6 A
380 ... 440 V : 4 A

Max. back-up fuse gG (gl)

10 A

Min. switching capacity

0.25 VA / 12 V or 0.25 VA / 5 mA

Coil Voltages and Codes

A9 ... A300 Contactors, N Contactors Relays

V (50 Hz)	V (60 Hz)	Code □ □
24	24	8 1
26	28	1 6
28	32	1 7
42	42	8 2
48	48	8 3
60	60	7 3
100	100 ... 110	7 4 (2)
110	110 ... 120	8 4
110 ... 115	115 ... 127(3)	8 9
120	140	2 9
125 ... 127	150	3 0
175	208	3 4
190	220	3 6
200	200 ... 220	7 5 (2)
220 ... 230	230 ... 240	8 0
230 ... 240	240 ... 260	8 8
230 ... 240	277	4 2
230/400 (1)	–	6 2
–	230/400 (1)	6 3
380 ... 400	400 ... 415	8 5
400 ... 415	415 ... 440	8 6
440	500	5 3
500	600	5 5
550	–	5 6
660 ... 690	–	5 8

(1) Only for A9 ... A16, N

(2) Not for A 145 ... A 300

(3) A 145 ... A 300 at 60 Hz 115 V only

AF 400 ... AF 750 Contactors

V (50 ... 60 Hz)	V (DC)	Code □ □
–	24 ... 60	6 8
48 ... 130	48 ... 130 (1)	6 9
100 ... 250	100 ... 250	7 0
200 ... 500	200 ... 500 (1)	7 1

(1) Available after 2001

Coil Voltages and Codes

EK 110 ... EK 210 Contactors

V (50 Hz)	V (60 Hz)	Code □ □
–	24	A A
24	–	A B
–	48	A C
48	–	A D
–	110	A E
110	120	A F
–	–	– –
–	–	– –
127	–	A G
–	208	A Z
190	220	A H
–	240	A K
220 ... 230	–	A L
–	–	– –
–	–	– –
230 ... 240	–	A M
–	380	A N
380 ... 400	440	A P
–	–	– –
–	–	– –
400 ... 415	–	A R
–	480	A S
440	–	A T
500	–	A U
–	600	A V

EK 370 ... EK 1000 Contactors

V (50 Hz)	V (60 Hz)	Code □ □
–	–	– –
–	–	– –
–	–	– –
48	–	A D
–	110	A E
110	120	A F
110	110 ... 120	E F
110 ... 115	115 ... 127	E G
127	–	A G
–	208	A Z
190	220	A H
–	240	A K
220 ... 230	240	A L
220	220 ... 240	E L
220 ... 230	230 ... 255	E M
230 ... 240	–	A M
–	380	A N
380 ... 400	440	A P
380	380 ... 415	E P
380 ... 400	400 ... 440	E R
400 ... 415	–	A R
–	480	A S
440	–	A T
500	–	A U
–	600	A V

Conversion Tables

B/EH Series - A Series

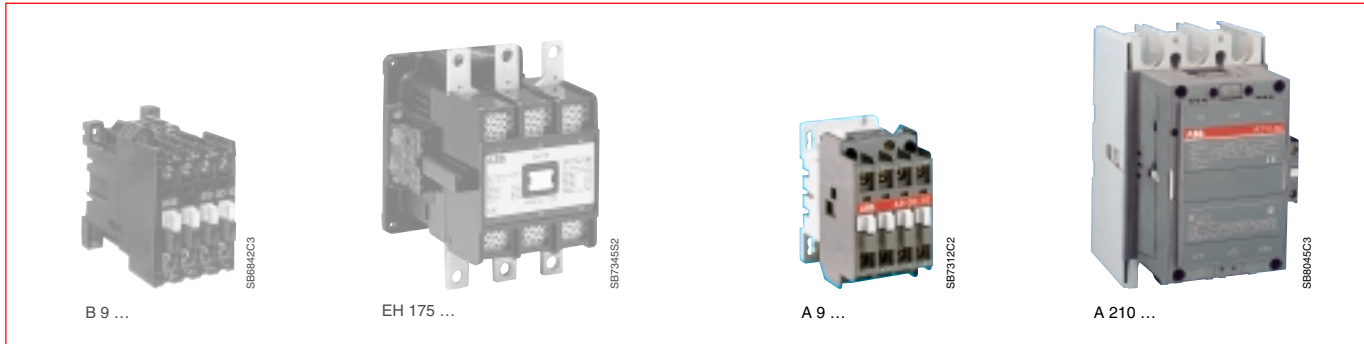

B/EH Series, 3-pole Contactors

A Series, 3-pole Contactors

Motor rating AC-3	Contactor type	Rated operational current		Thermal O/L relay type	Contactor type	Rated operational current		Thermal O/L relay type
		AC-3 380 V 400 V A	AC-1 $\theta \leq 40\text{ }^\circ\text{C}$ A			AC-3 380 V 400 V A	AC-1 $\theta \leq 40\text{ }^\circ\text{C}$ A	
4	B 9-30-10	9	22	T 25 DU ..	A 9-30-10	9	25	TA 25 DU ..
	B 9-30-01	9	22	T 25 DU ..	A 9-30-01	9	25	TA 25 DU ..
	B 9-30-22	9	22	T 25 DU ..	A 9-30-22	9	25	TA 25 DU ..
	B 9-30-32	9	22	T 25 DU ..	A 9-30-32	9	25	TA 25 DU ..
5.5	B 12-30-10	12	24	T 25 DU ..	A 12-30-10	12	27	TA 25 DU ..
	B 12-30-01	12	24	T 25 DU ..	A 12-30-01	12	27	TA 25 DU ..
	B 12-30-22	12	24	T 25 DU ..	A 12-30-22	12	27	TA 25 DU ..
	B 12-30-32	12	24	T 25 DU ..	A 12-30-32	12	27	TA 25 DU ..
7.5	B 16-30-10	16	28	T 25 DU ..	A 16-30-10	17	30	TA 25 DU ..
	B 16-30-01	16	28	T 25 DU ..	A 16-30-01	17	30	TA 25 DU ..
	B 16-30-22	16	28	T 25 DU ..	A 16-30-22	17	30	TA 25 DU ..
	B 16-30-32	16	28	T 25 DU ..	A 16-30-32	17	30	TA 25 DU ..
11	B 25-30-10	25	45	T 25 DU ..	A 26-30-10	26	45	TA 25 DU ..
	B 25-30-01	25	45	T 25 DU ..	A 26-30-01	26	45	TA 25 DU ..
	B 25-30-32	25	45	T 25 DU ..	A 26-30-32	26	45	TA 25 DU ..
15	B 30-30-00	30	55	T 25 DU ..	A 30-30-10	32	55	TA 25 DU ..
	-	-	-	-	A 30-30-01	32	55	TA 25 DU ..
	B 30-30-22	30	55	T 25 DU ..	A 30-30-32	32	55	TA 25 DU ..
18.5	B 40-30-00	37	70	T 75 DU ..	A 40-30-10	37	60	TA 42 DU ..
	B 40-30-11	37	70	T 75 DU ..	A 40-30-01	37	60	TA 42 DU ..
	B 40-30-22	37	70	T 75 DU ..	A 40-30-32	37	60	TA 42 DU ..
22	B 50-30-00	50	100	T 75 DU ..	A 50-30-00	50	100	TA 75 DU ..
	B 50-30-11	50	100	T 75 DU ..	A 50-30-11	50	100	TA 75 DU ..
	B 50-30-22	50	100	T 75 DU ..	A 50-30-22	50	100	TA 75 DU ..
30	B 63-30-00	65	115	T 75 DU ..	A 63-30-00	65	115	TA 75 DU ..
	B 63-30-11	65	115	T 75 DU ..	A 63-30-11	65	115	TA 75 DU ..
	B 63-30-22	65	115	T 75 DU ..	A 63-30-22	65	115	TA 75 DU ..
37	B 75-30-00	75	125	T 75 DU ..	A 75-30-00	75	125	TA 75 DU ..
	B 75-30-11	75	125	T 75 DU ..	A 75-30-11	75	125	TA 75 DU ..
	B 75-30-22	75	125	T 75 DU ..	A 75-30-22	75	125	TA 75 DU ..
40	-	-	-	-	A 95-30-00	96	145	TA 110 DU ..
	EH 80-30-11	80	145	T 80 DU ..	A 95-30-11	96	145	TA 110 DU ..
45	-	-	-	-	A 95-30-00	96	145	TA 110 DU ..
	EH 90-30-11	96	160	T 100 DU ..	A 95-30-11	96	145	TA 110 DU ..
	EH 90-30-22	96	160	T 100 DU ..	A 95-30-22	96	145	TA 110 DU ..
55	EH 100-30-11	120	200	T 135 DU ..	A 110-30-11	110	160	TA 110 DU ..
	-	-	-	-	A 110-30-00	110	160	TA 110 DU ..
	EH 100-30-22	120	200	T 135 DU ..	A 110-30-22	110	160	TA 110 DU ..
75	EH 145-30-11	145	230	T 200 DU ..	A 145-30-11	145	250	E 200 DU ..
	EH 145-30-22	145	230	T 200 DU ..	A 145-30-22	145	250	E 200 DU ..
90	EH 175-30-11	185	260	T 200 DU ..	A 185-30-11	185	275	E 200 DU ..
	EH 175-30-22	185	260	T 200 DU ..	A 185-30-22	185	275	E 200 DU ..
110	EH 210-30-11	210	300	T 450 DU ..	A 210-30-11	210	350	E 320 DU ..
	EH 210-30-22	210	300	T 450 DU ..	A 210-30-22	210	350	E 320 DU ..

B/EH Series, 3-pole Contactors (cont.)

A Series, 3-pole Contactors (cont.)

Motor rating AC-3 380 V / 400 V kW	Contactor type	Rated operational current		Thermal O/L relay type	Contactor type	Rated operational current		Thermal O/L relay type
		AC-3 380 V 400 V A	AC-1 $\theta \leq 40\text{ }^{\circ}\text{C}$ A			AC-3 380 V 400 V A	AC-1 $\theta \leq 40\text{ }^{\circ}\text{C}$ A	
140	EH 260-30-11	260	400	TA 450 DU ..	A 260-30-11	260	400	E 320 DU ..
	EH 260-30-22	260	400	TA 450 DU ..	A 260-30-22	260	400	E 320 DU ..
160	EH 300-30-11	305	445	TA 450 DU ..	A 300-30-11	305	500	E 320 DU ..
	EH 300-30-22	305	445	TA 450 DU ..	A 300-30-22	305	500	E 320 DU ..
200	EH 370-30-11	400	550	TA 450 DU ..	AF 400-30-11	400	600	E 500 DU ..
	EH 370-30-22	400	550	TA 450 DU ..	AF 400-30-22	400	600	E 500 DU ..
250	-	-	-	-	AF 460-30-11	460	700	E 500 DU ..
	-	-	-	-	AF 460-30-22	460	700	E 500 DU ..
280	EH 550-30-11	550	800	TA 900 DU ..	-	-	-	-
	EH 550-30-22	550	800	TA 900 DU ..	-	-	-	-
315	-	-	-	-	AF 580-30-11	580	800	E 800 DU ..
	-	-	-	-	AF 580-30-22	580	800	E 800 DU ..
370	EH 700-30-11	700	1000	TA 900 DU ..	-	-	-	-
	EH 700-30-22	700	1000	TA 900 DU ..	-	-	-	-
400	EH 800-30-11	750	1000	TA 900 DU ..	AF 750-30-11	750	1050	E 900 DU ..
	EH 800-30-22	750	1000	TA 900 DU ..	AF 750-30-22	750	1050	E 900 DU ..

B/EK Series, 4-pole Contactors - 4 NO

A/EK Series, 4-pole Contactors - 4 NO

-	Contactor type	Rated operational current AC-1 $\theta \leq 40\text{ }^{\circ}\text{C}$ A	Contactor type	Rated operational current AC-1 $\theta \leq 40\text{ }^{\circ}\text{C}$ A
	B 9-40-00	22	A 9-40-00	25
	B 12-40-00	24	A 9-40-00	25
	B 16-40-00	28	A 16-40-00	30
	B 25-40-00	45	A 26-40-00	45
	-	-	A 45-40-00	70
	B 40-40-00	80	A 50-40-00	100
	B 50-40-00	125	A 75-40-00	125
	EK 100-40-11	200	EK 110-40-11	200
	-	-	EK 110-40-22	200
	EK 145-40-11	250	EK 150-40-11	250
	-	-	EK 150-40-22	250
	EK 160-40-11	300	EK 175-40-11	300
	-	-	EK 175-40-22	300
	EK 200-40-11	350	EK 210-40-11	350
	-	-	EK 210-40-22	350
	EK 370-40-11	550	EK 370-40-11	550
	-	-	EK 370-40-22	550
	EK 550-40-11	800	EK 550-40-11	800
	-	-	EK 550-40-22	800
	-	-	EK 1000-40-11	1000
	-	-	EK 1000-40-11	1000

B Series, 4-pole Contactors - 2 NO + 2 NC

A Series, 4-pole Contactors - 2 NO + 2 NC

-	Contactor type	Rated operational current AC-1 $\theta \leq 40\text{ }^{\circ}\text{C}$ A	Contactor type	Rated operational current AC-1 $\theta \leq 40\text{ }^{\circ}\text{C}$ A
	B 9-22-00	22	A 9-22-00	25
	B 12-22-00	24	A 9-22-00	25
	B 16-22-00	28	A 16-22-00	30
	B 25-22-00	45	A 26-22-00	45
	-	-	A 45-22-00	70
	-	-	A 75-22-00	125

A .. 3-pole Contactors

Dimensions (in mm)

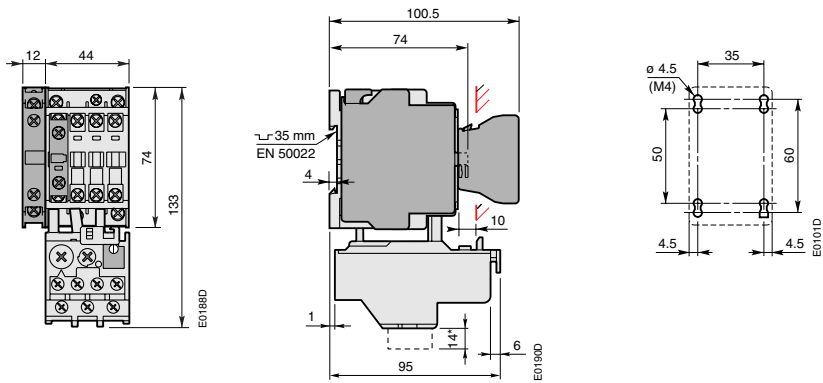

A 9, A 12, A 16 + CA5 + CAL5 + TA25

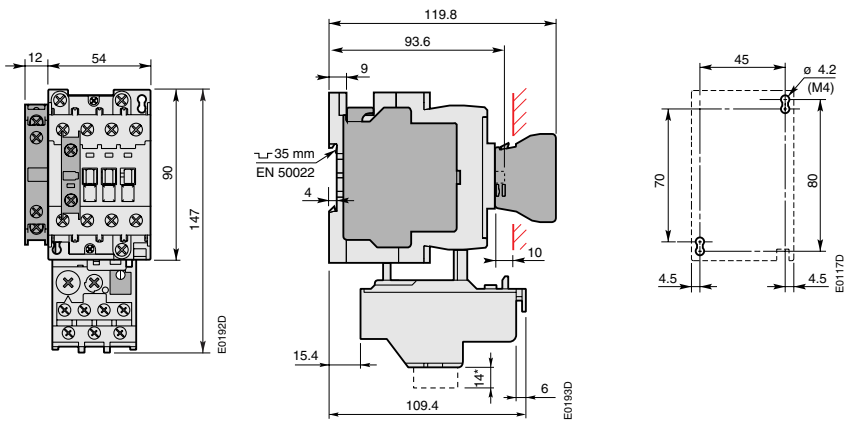

A 26 + CA5 + CAL5 + TA25

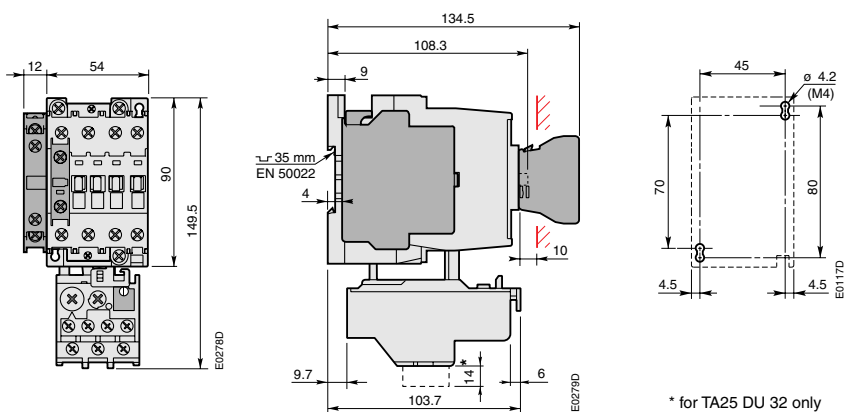

* for TA25 DU 32 only

A 30 + CA5 + CAL5 + TA25

Detailed dimension drawings on Autocad DWG / DXF formats available on request

A .. 3-pole Contactors

Dimensions (in mm)

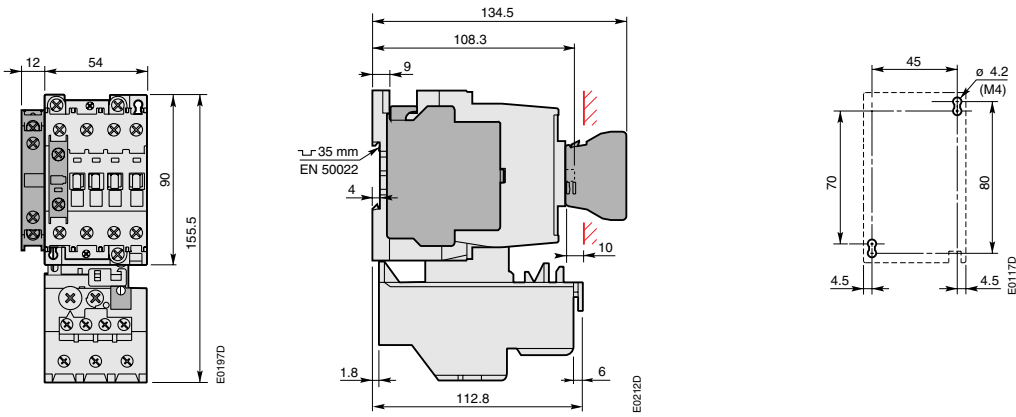

A 40 + CA5 + CAL5 + TA42

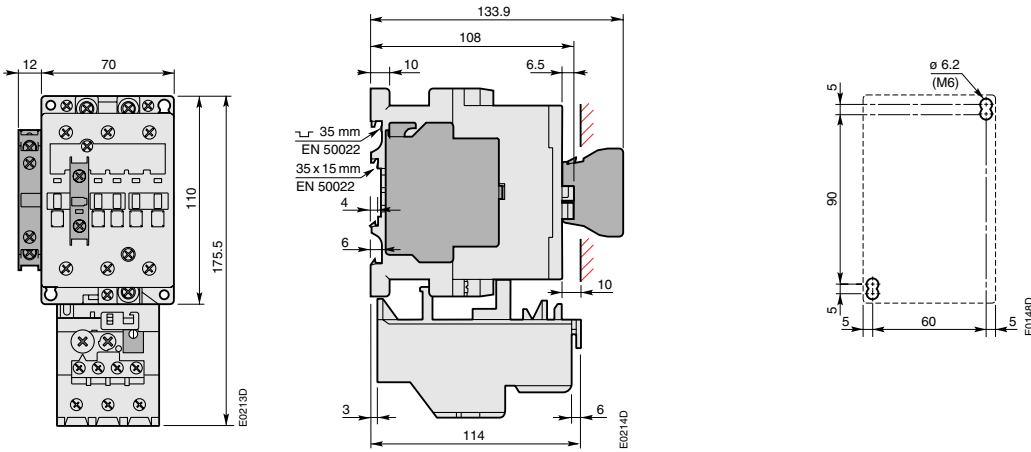

A 50, A 63, A 75 + CA5 + CAL5 + TA75

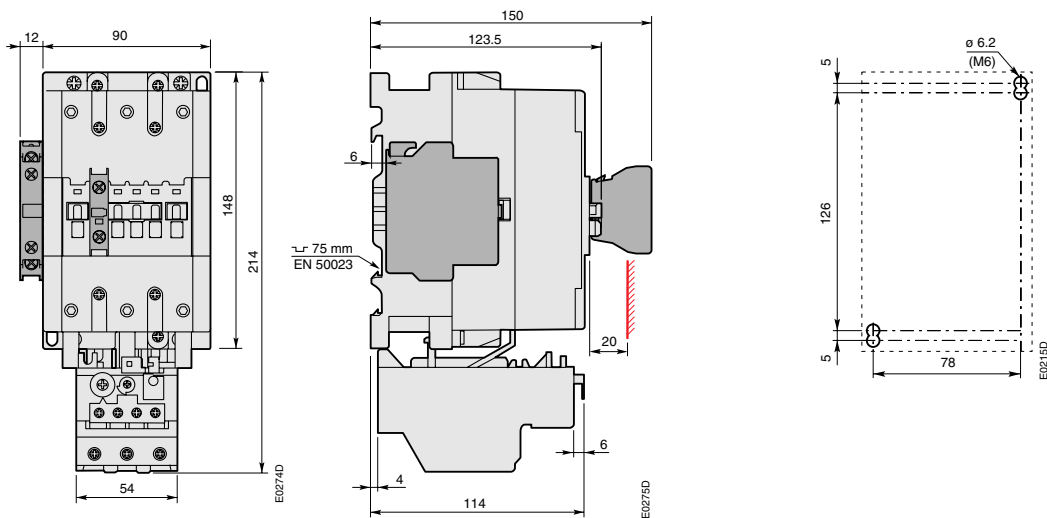

A 95, A 110 + CA5 + CAL5 + TA80

Detailed dimension drawings on Autocad DWG / DXF formats available on request

A .. 3-pole Contactors

Dimensions (in mm)

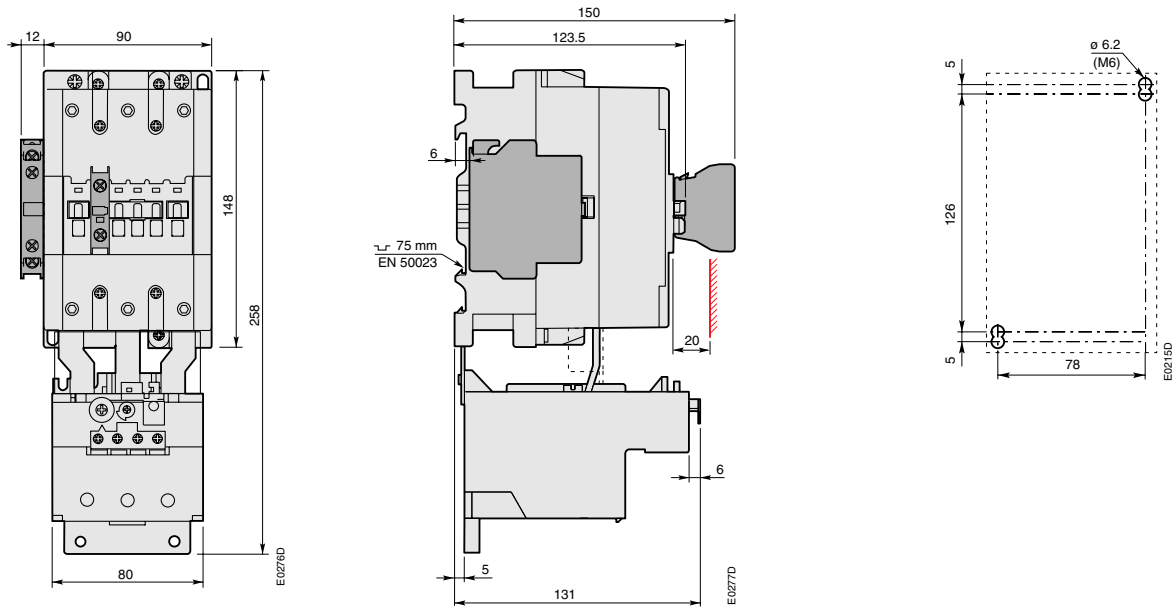

A 95, A 110 + CA5 + CAL5 + TA110

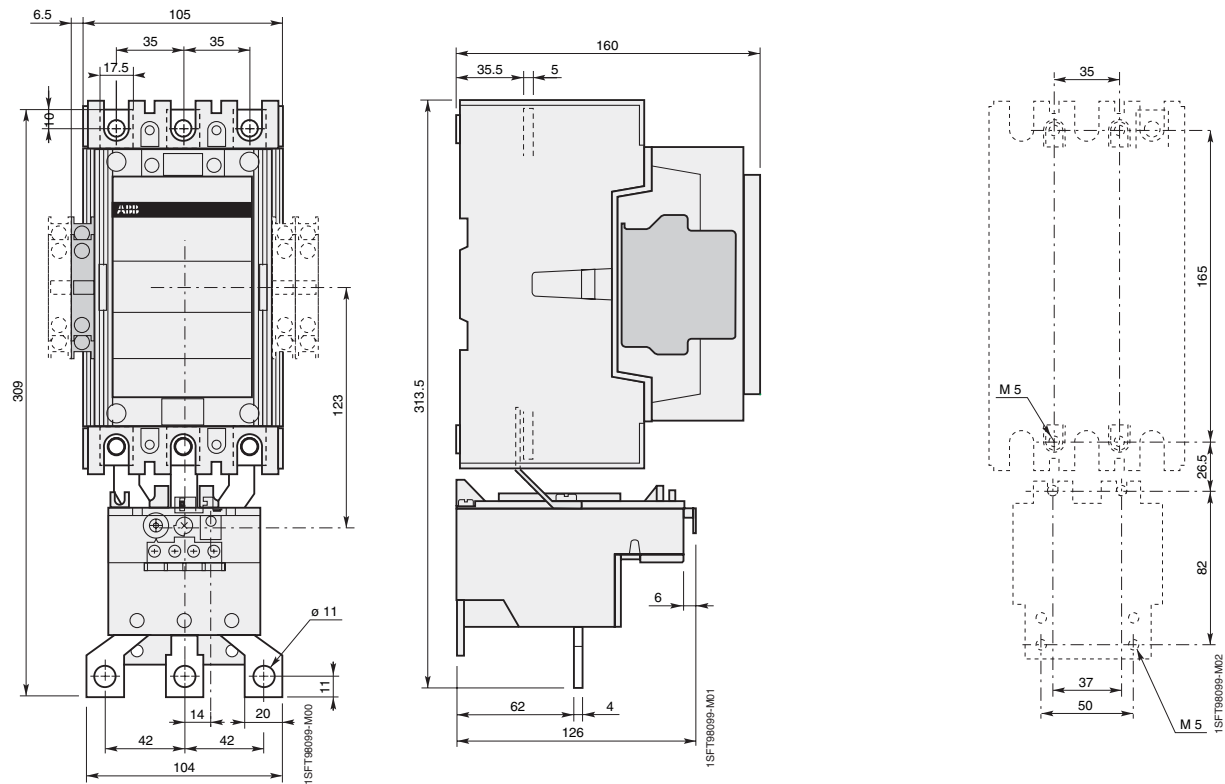

A 145 ... A 185 + CAL5 + TA200

Detailed dimension drawings on Autocad DWG / DXF formats available on request

A .. 3-pole Contactors

Dimensions (in mm)

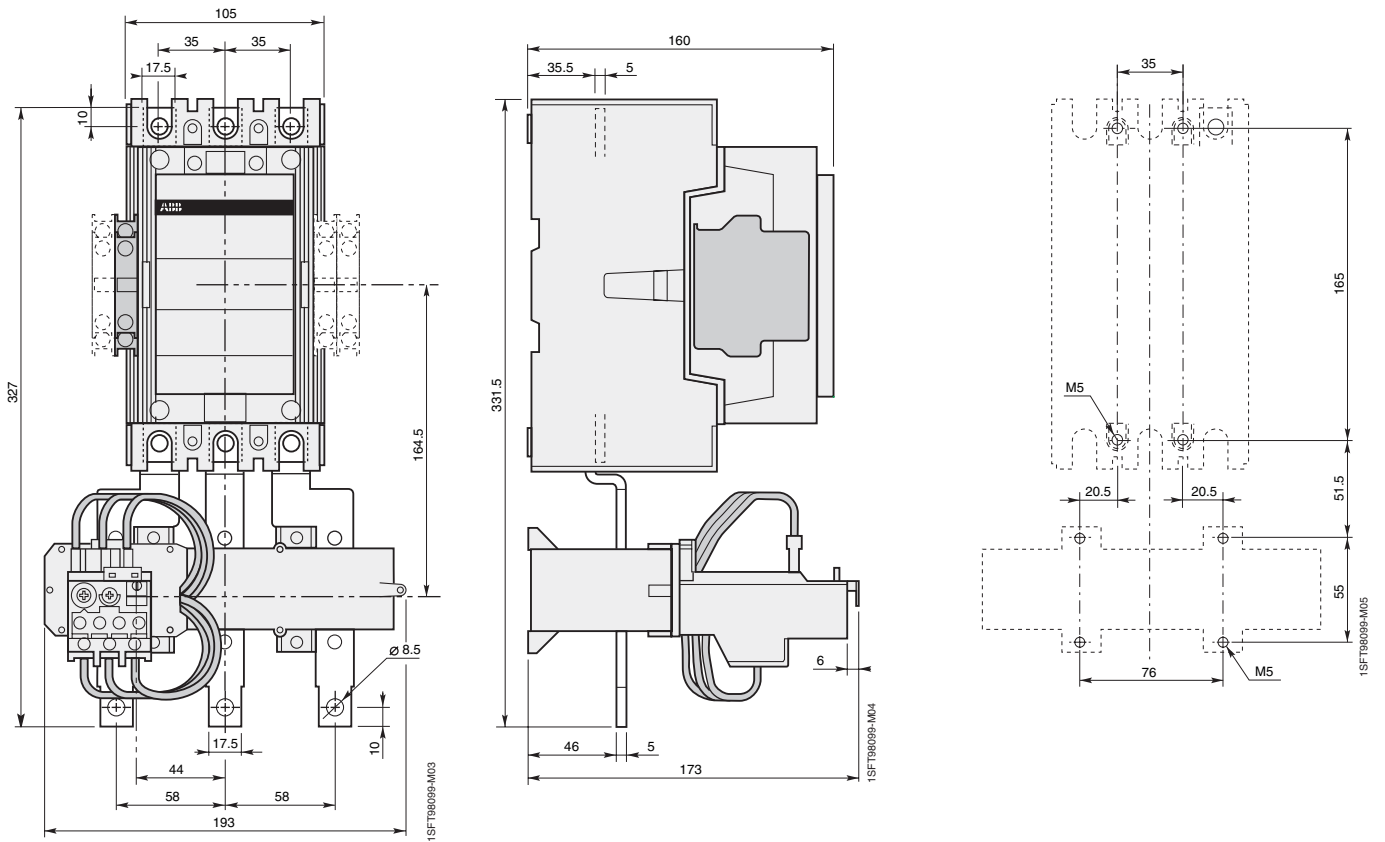

A 145 ... A 185 + CAL5 + TA450 SU

Detailed dimension drawings on Autocad DWG / DXF formats available on request

A .. 3-pole Contactors

Dimensions (in mm)

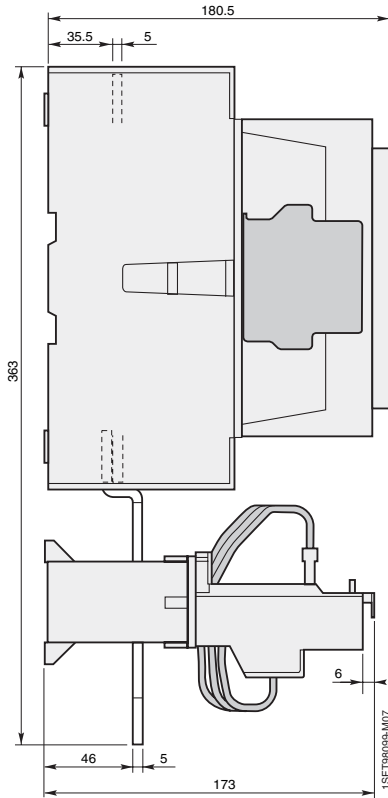
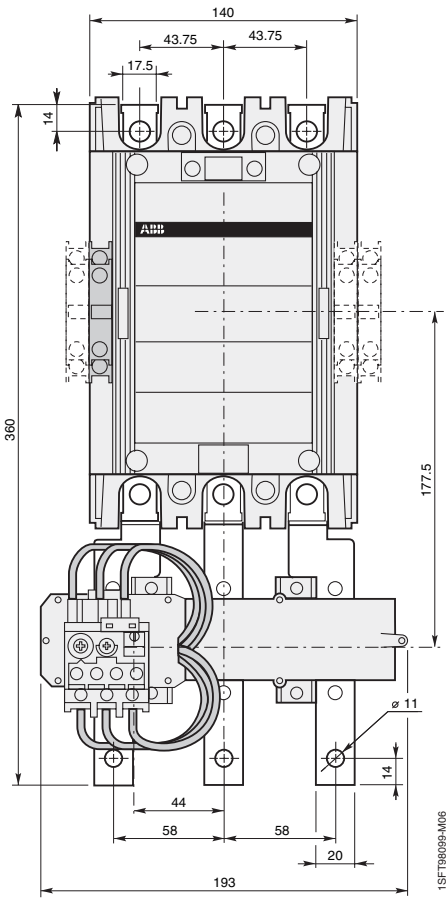

A 210 ... A 300 + CAL5 + TA450 DU/SUA

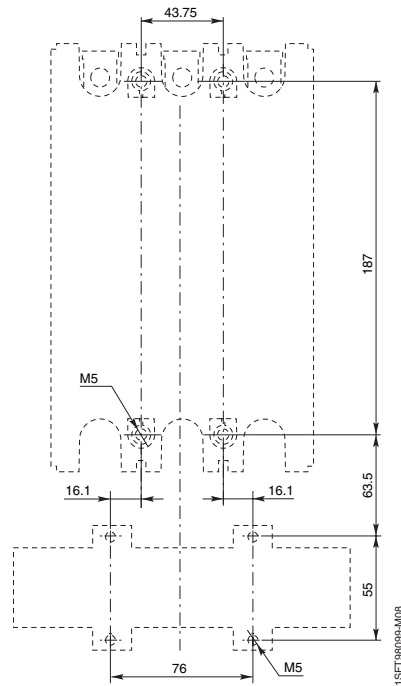

Detailed dimension drawings on Autocad DWG / DXF formats available on request

A .. 3-pole Contactors

Dimensions (in mm)

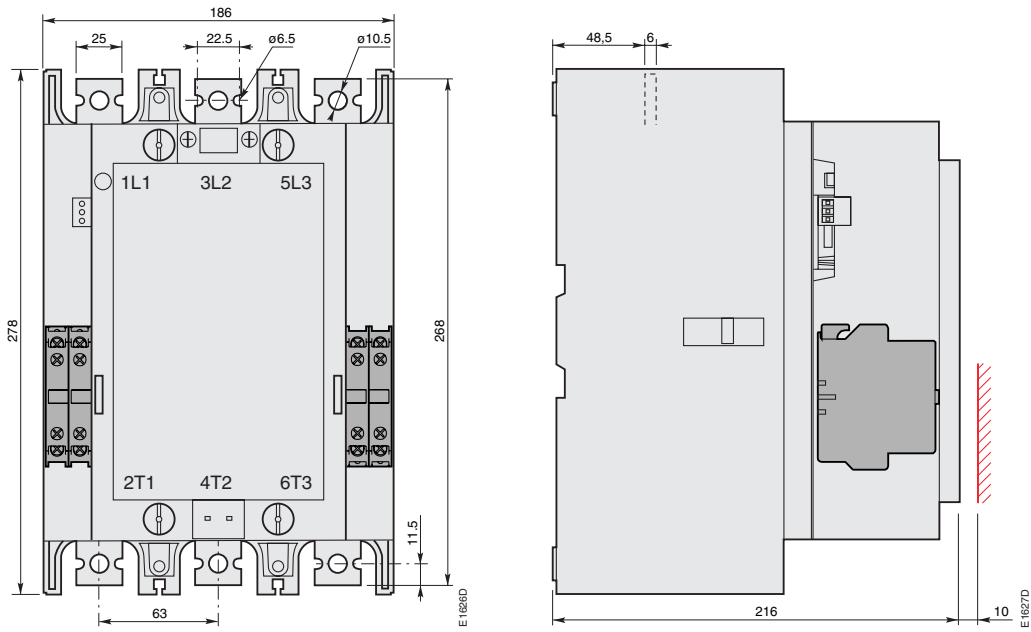

AF 400, AF 460 c/w 4 x CAL5

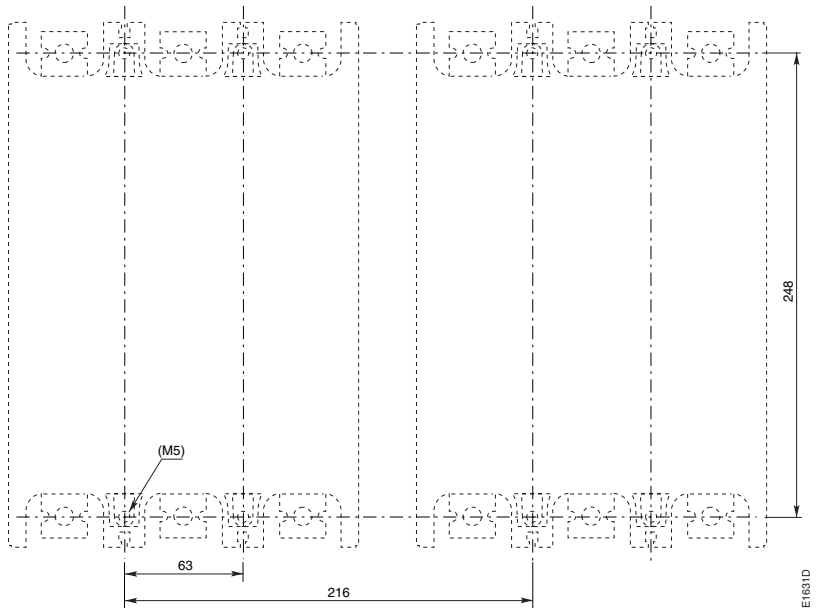

Detailed dimension drawings on Autocad DWG / DXF formats available on request

A .. 3-pole Contactors

Dimensions (in mm)

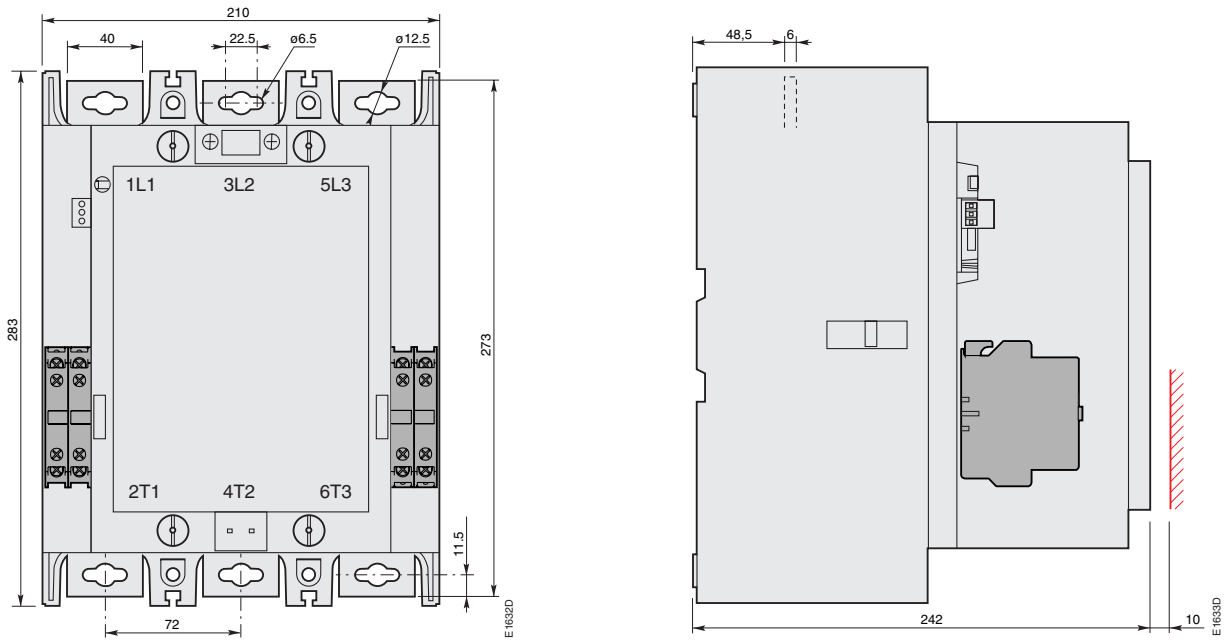

AF 580, AF 750 c/w 4 x CAL5

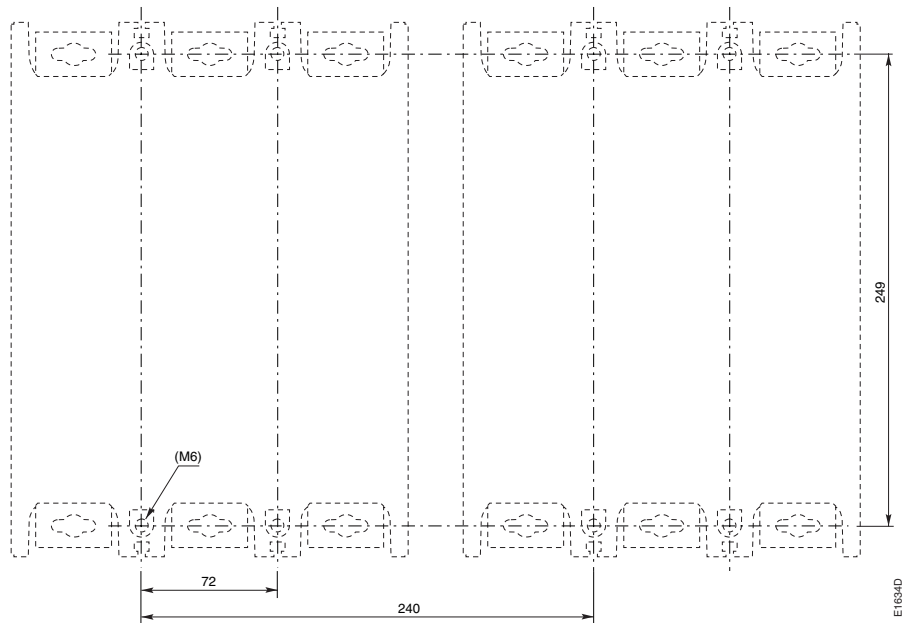

A .. 4-pole Contactors

Dimensions (in mm)

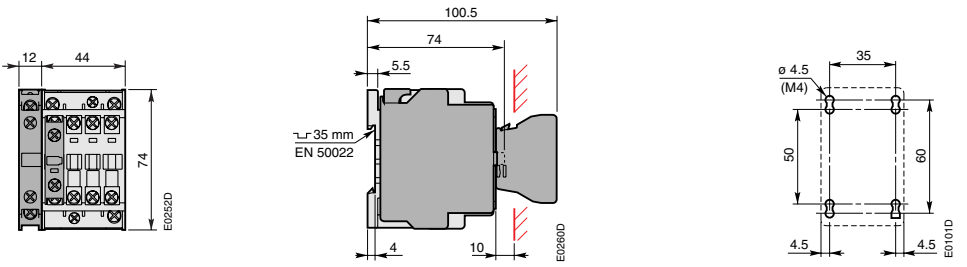

A 9, A 12, A 16 + CA5 + CAL5

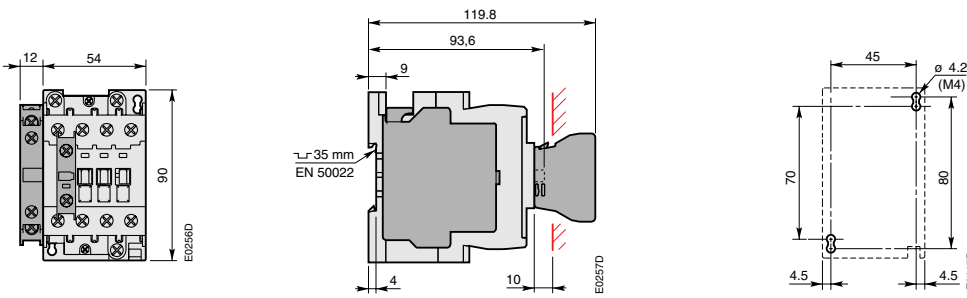

A 26 + CA5 + CAL5

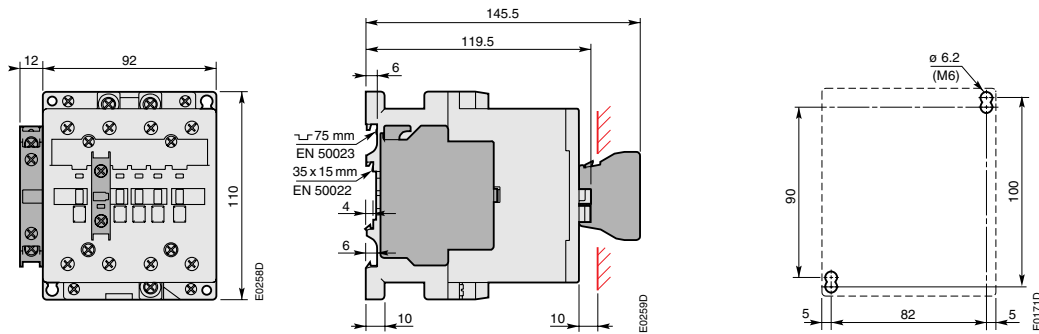

A 45, A 50, A 75 + CA5 + CAL5

Detailed dimension drawings on Autocad DWG / DXF formats available on request

EK .. 4-pole Contactors

Dimensions (in mm)

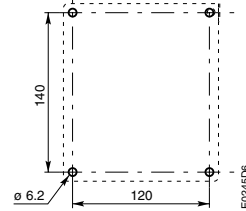
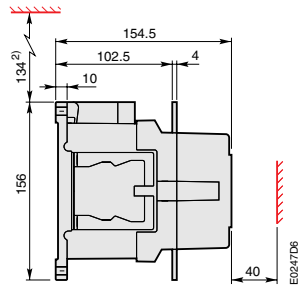
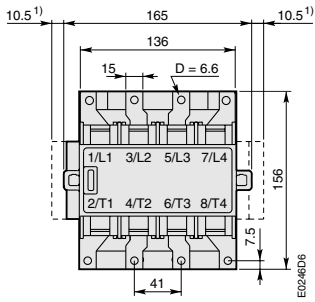

EK 110

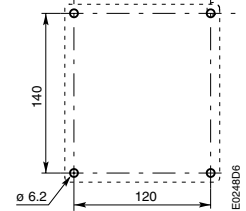
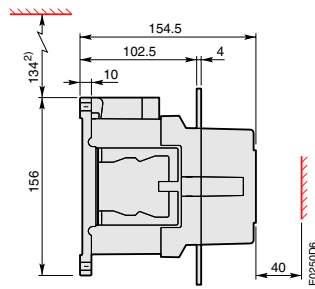
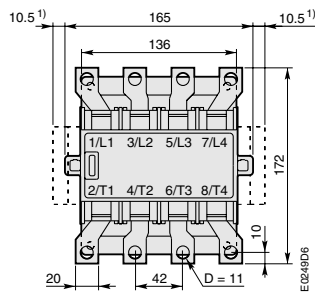

EK 150

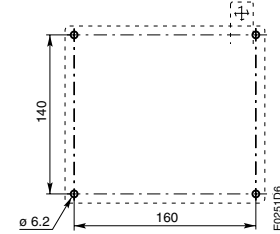
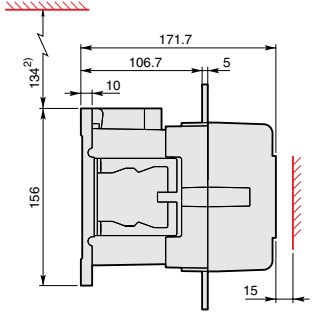
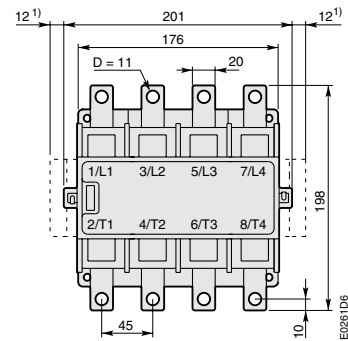

EK 175, EK 210

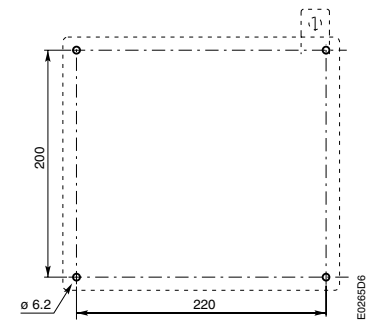
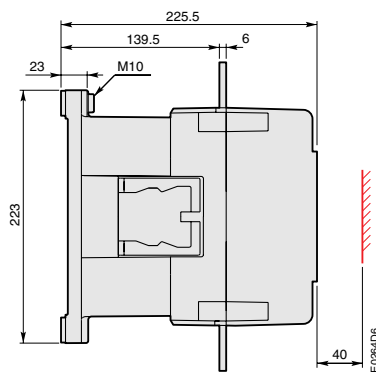
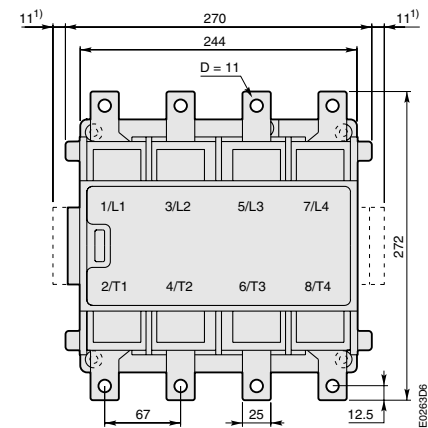

EK 370, EK 550, EK 1000

1) Dimensions for extra auxiliary contact block
 2) Minimum distance to remove coil
 Detailed dimension drawings on Autocad DWG / DXF formats available on request

N .. Contactors Relays

Dimensions (in mm)

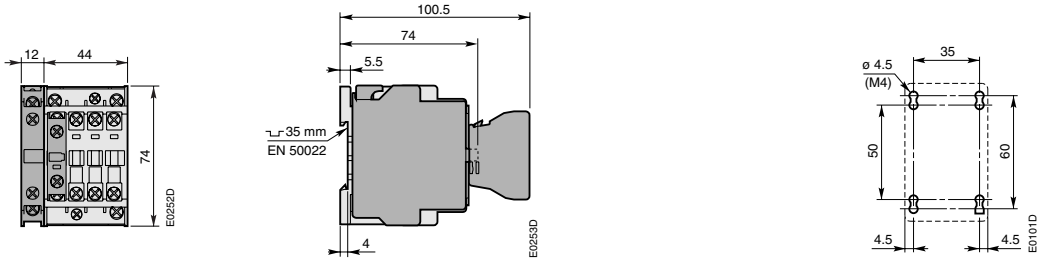

N + CA5 + CAL5

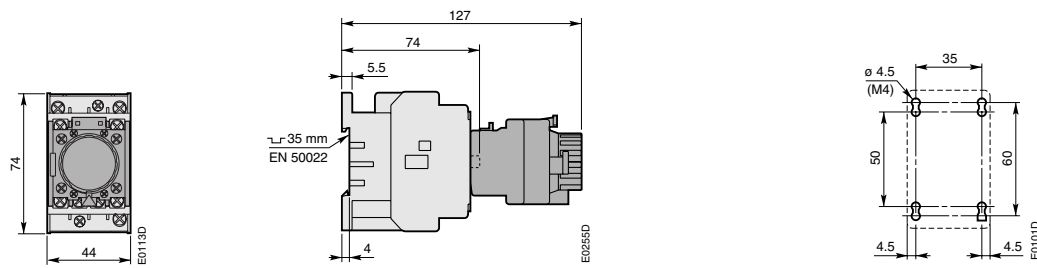

N + TP.. A

Detailed dimension drawings on Autocad DWG / DXF formats available on request

DLA Starters

Wiring diagrams

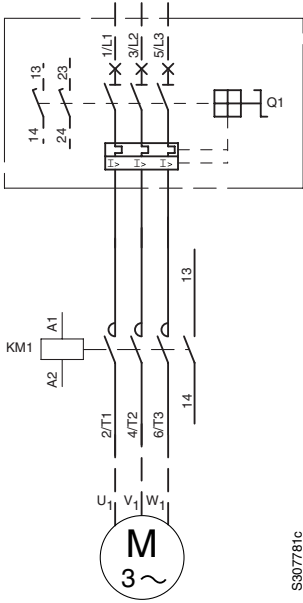

Power circuit

Dimensions (in mm)

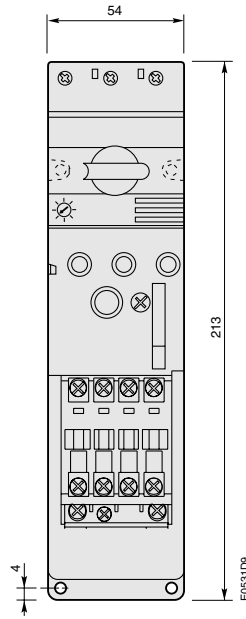

DLA 9 ... DLA 16

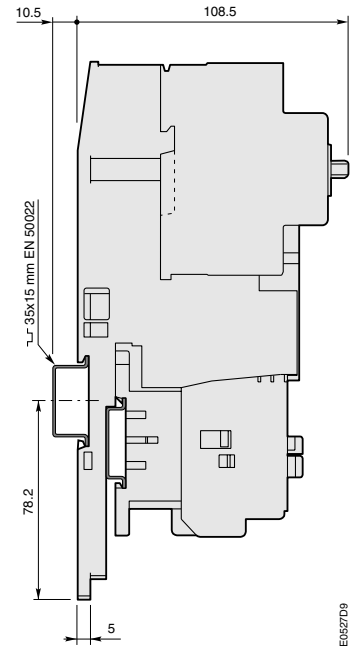

Drilling diagram

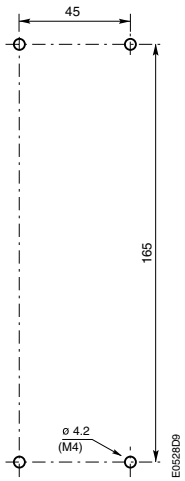

DLA 9 ... DLA 26

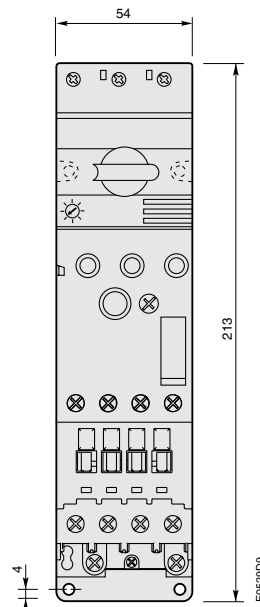

DLA 26

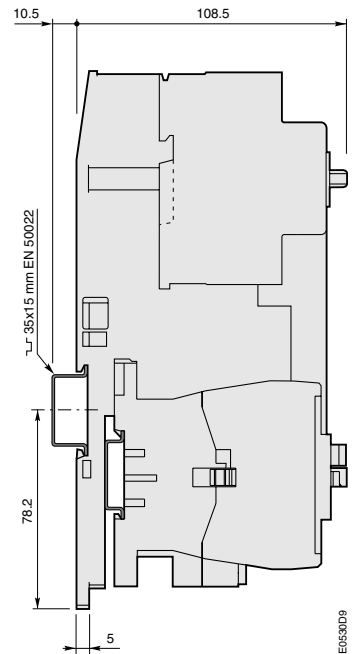

Dimensions (in mm)

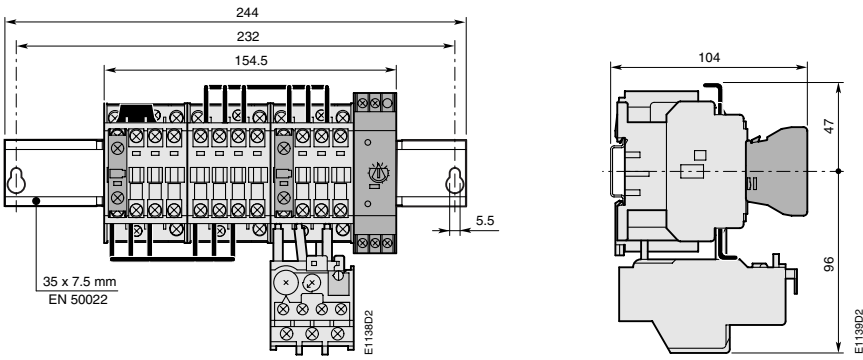

YKA 9-30 ... YKA 16-30 + TA25

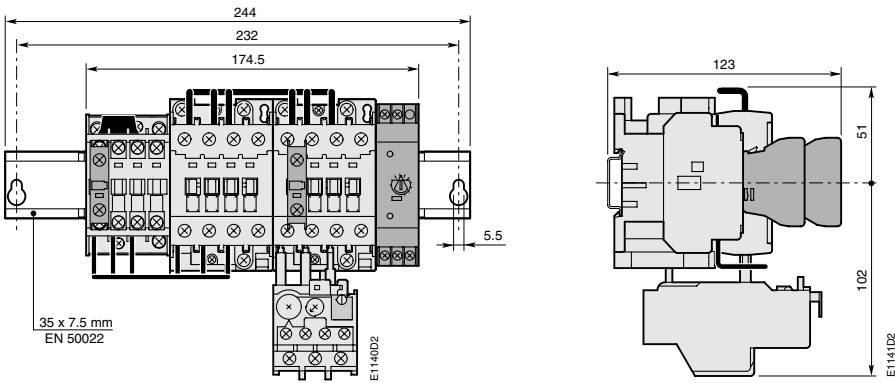

YKA 26-30 + TA25

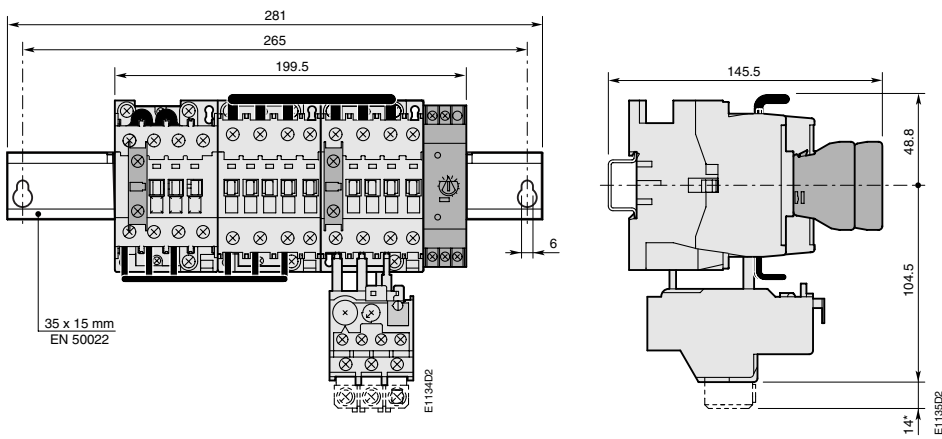

YKA 30-30 + TA25

* for TA25 DU 32 only

Detailed dimension drawings on Autocad DWG / DXF formats available on request

YKA .. -30 Star-Delta Starters

Dimensions (in mm)

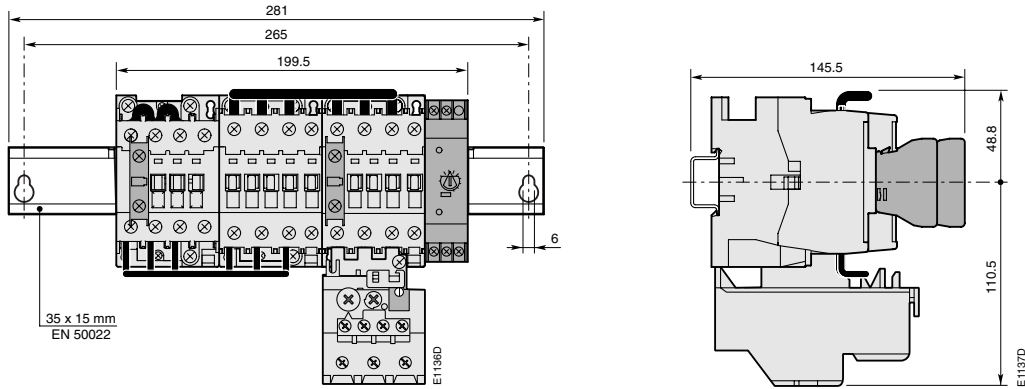

YKA 40-30 + TA42

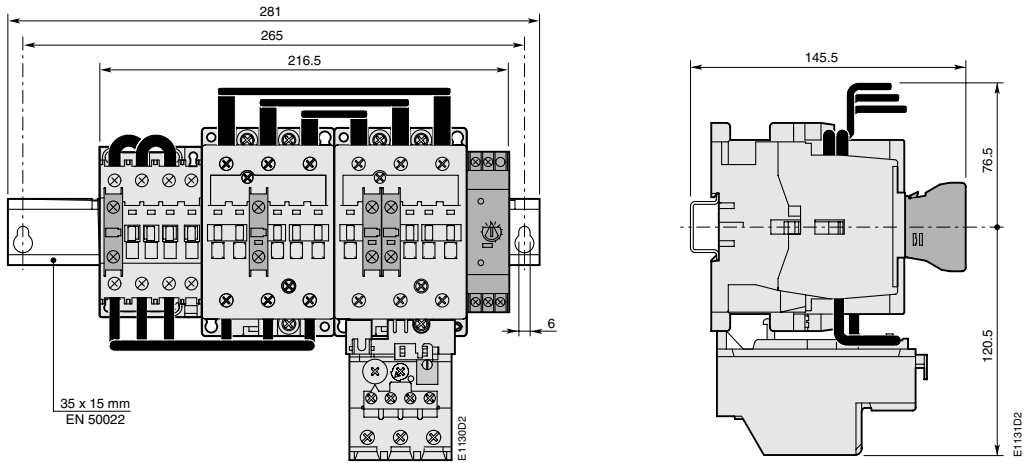

YKA 50-30 + TA75, YKA 63-30 + TA75

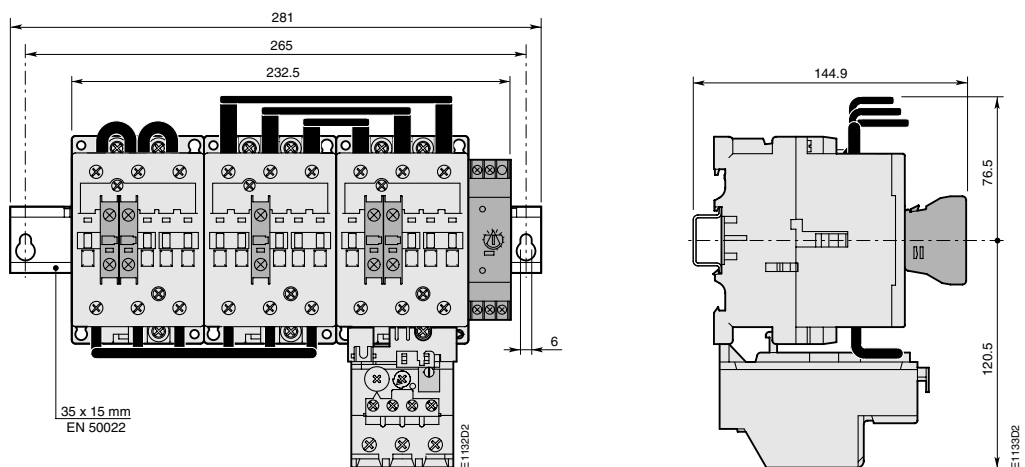

YKA 75-30 + TA75

Detailed dimension drawings on Autocad DWG / DXF formats available on request

YDA .. -30 Star-Delta Starters

Dimensions (in mm)

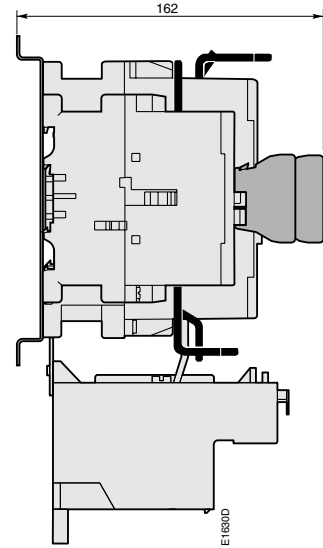
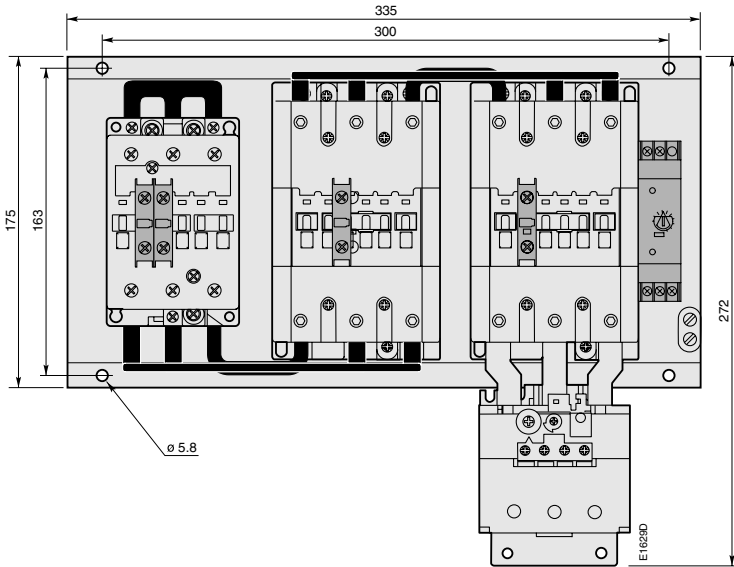

YDA 95-30 + TA110

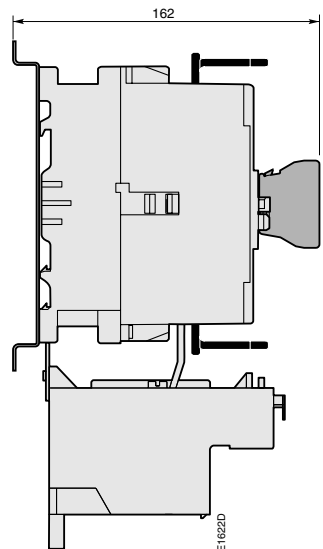
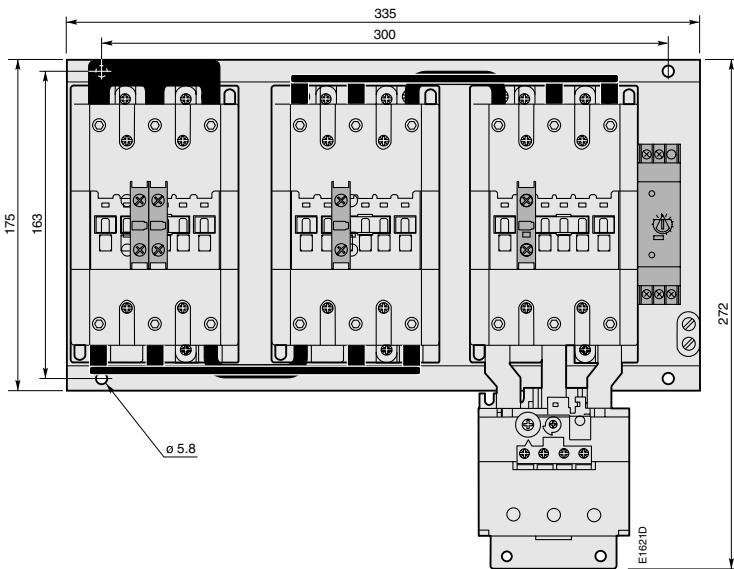

YDA 110-30 + TA110

Detailed dimension drawings on Autocad DWG / DXF formats available on request

VOA .. -30M Reversing Contactors VNA .. -30M Reversing Contactors VOA .. -40Z Changeover Contactors

Dimensions (in mm)

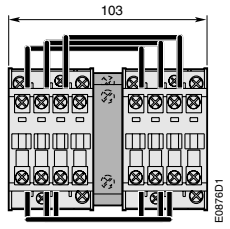

VOA 9-30M ... VOA 16-30M

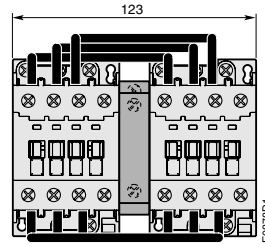
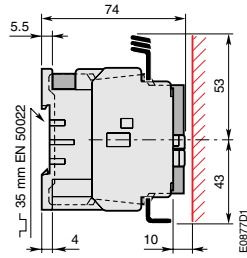

VOA 26-30M

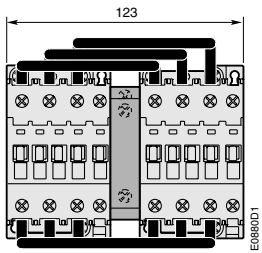
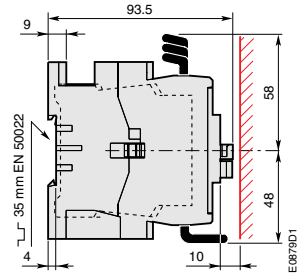

VOA 30-30M, VOA 40-30M

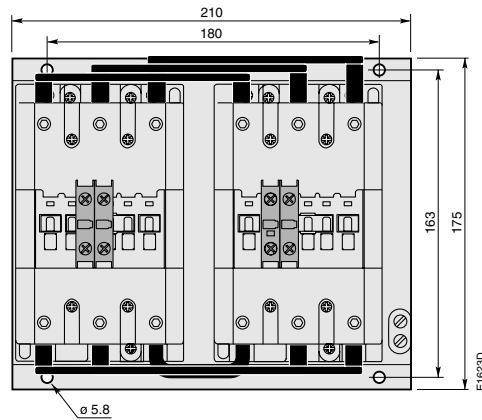
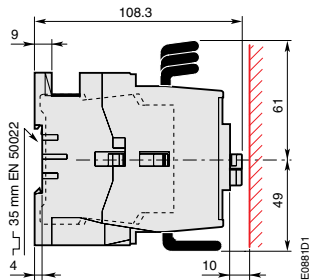

VNA 95-30M, VNA 110-30M

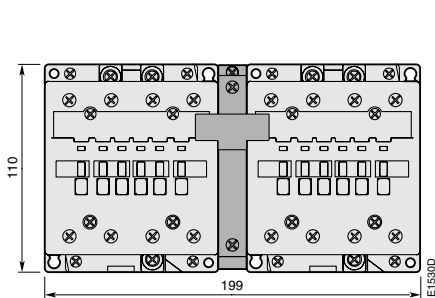
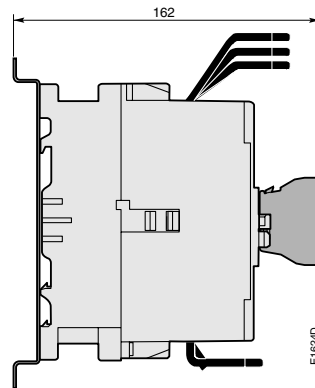

VOA 45-40Z ... VOA 75-40Z

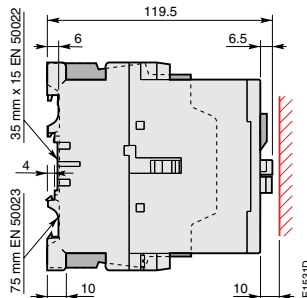

Detailed dimension drawings on Autocad DWG / DXF formats available on request

YKA ..-30, YDA ..-30 Star-Delta Starters Open Type Version

Wiring diagrams

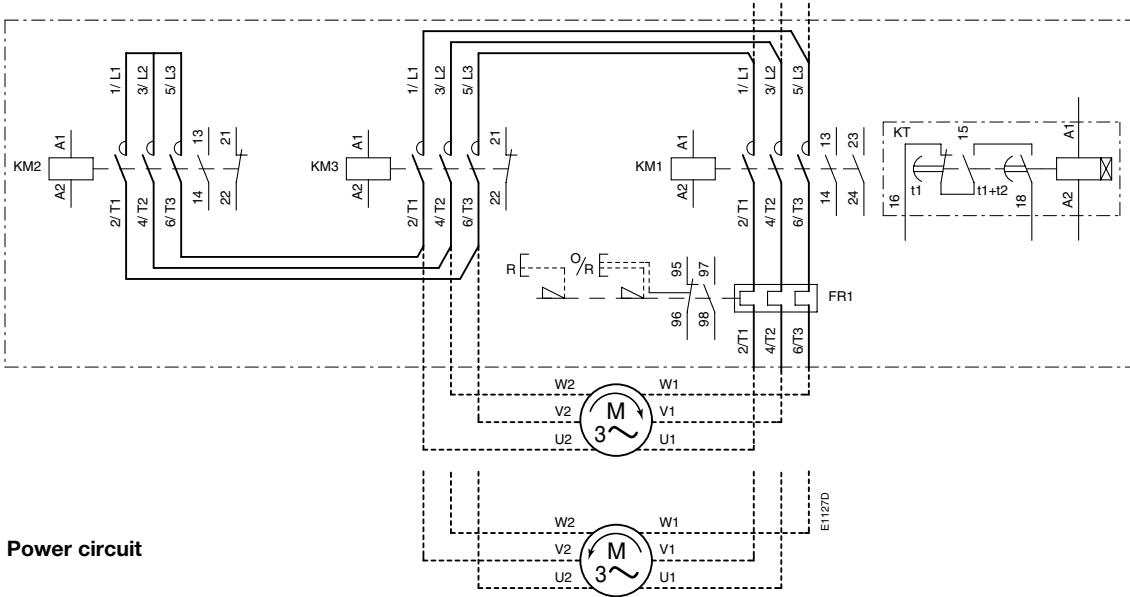

Power circuit

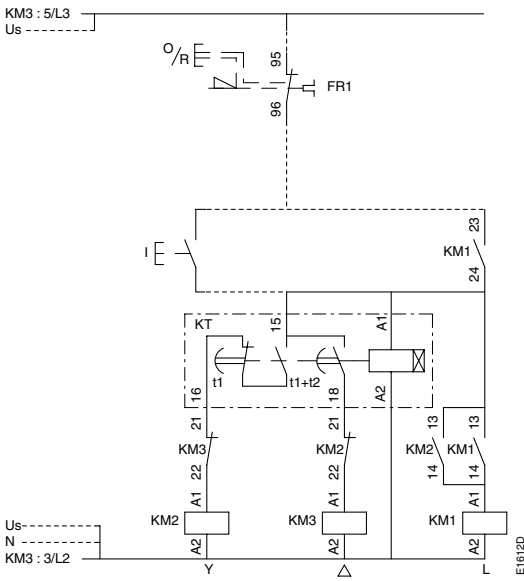

Local control

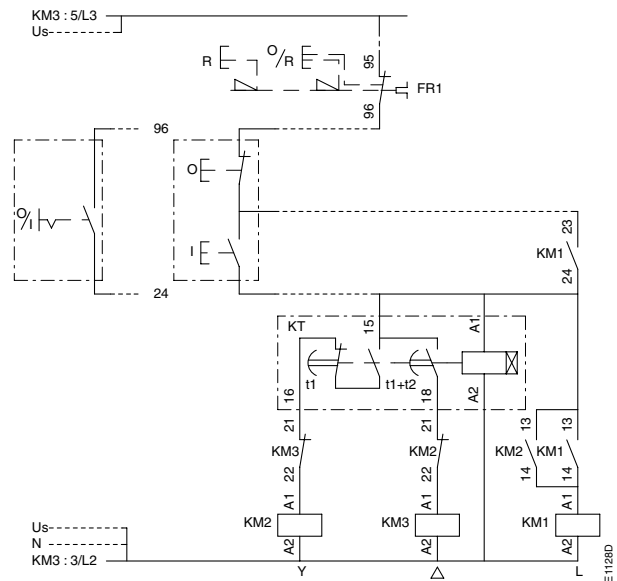

Remote control

VOA ..-30M Reversing Contactors

Wiring diagrams

VOA 9-30M ... VOA 40-30M reversing contactors, factory-assembled version

With VM5-1 mechanical interlocking, electrical interlocking by built-in auxiliary contacts.

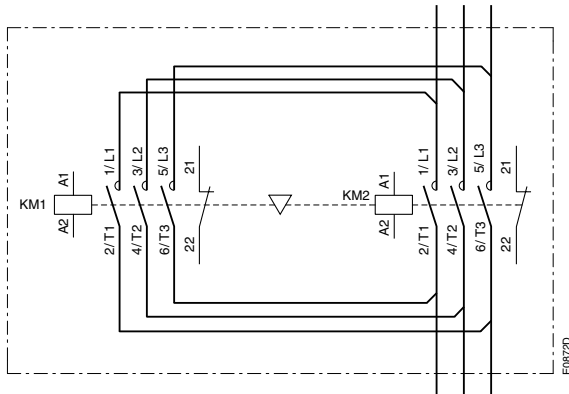

Power circuit

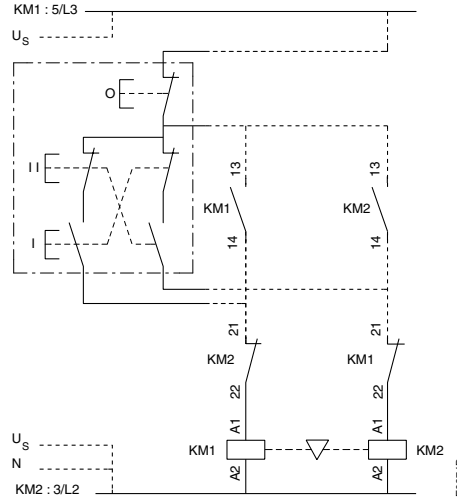

Remote control

For the hold-in contacts (13-14) of the KM1 and KM2 contactors, supply separately 2 x CA 5-10 type N.O. auxiliary contacts (see page 16/25).

VOA 9-30M ... VOA 40-30M reversing contactors, kit form version

with VE 5-1 mechanical and electrical interlocking.

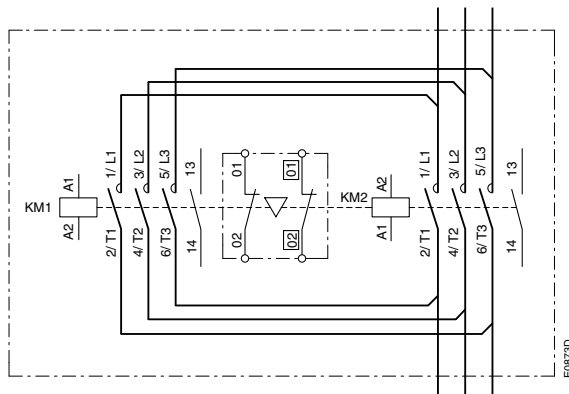

Power circuit

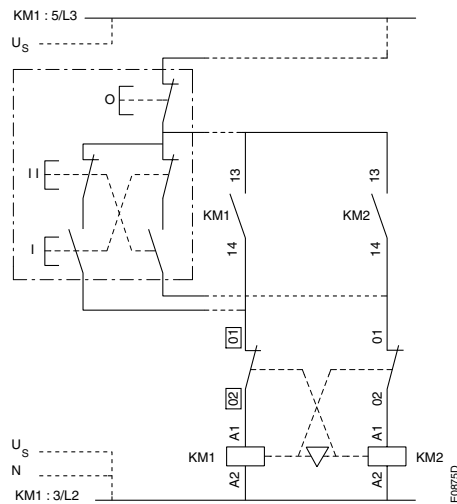

Remote control

N.O. auxiliary contacts (13-14) built into the KM1 and KM2 contactors, are available for the hold-in function of the KM1 and KM2 contactors.

VNA ..-30M Reversing Contactors VOA ..-40Z Changeover Contactors

Wiring diagrams

VNA 95-30M ... VNA 110-30M reversing contactors, factory-assembled or kit form version
With VE5-2 mechanical and electrical interlocking.

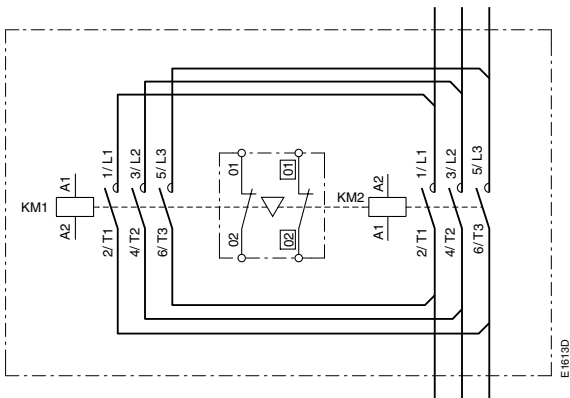

Power circuit

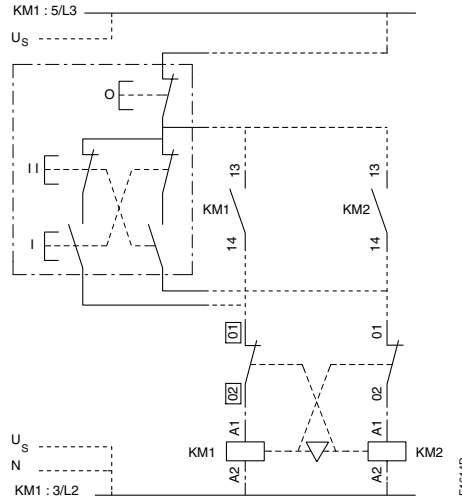

Remote control

For the hold-in contacts (13-14) of the KM1 and KM2 contactors, supply separately 2 x CA 5-10 type N.O. auxiliary contacts (see page 16/25).

VOA 45-40Z ... VOA 75-40Z changeover contactors, factory-assembled or kit form version
with VE 5-1 mechanical and electrical interlocking.

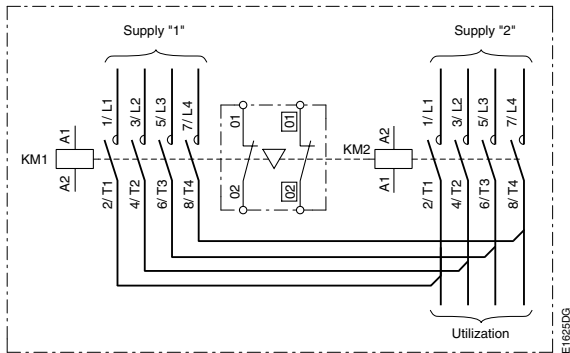

Power circuit