

BASIC CHARACTERISTICS ($T_{amb} = 25\text{ }^{\circ}\text{C}$, unless otherwise specified)							
PARAMETER	TEST CONDITION	PART	SYMBOL	MIN.	TYP.	MAX.	UNIT
INPUT (EMITTER)							
Forward voltage	$I_F = 60\text{ mA}$		V_F		1.25	1.6	V
Junction capacitance	$V_R = 0\text{ V}$, $f = 1\text{ MHz}$		C_j		50		pF
OUTPUT (DETECTOR)							
Collector emitter voltage	$I_C = 1\text{ mA}$		V_{CEO}	70			V
Emitter collector voltage	$I_E = 10\text{ }\mu\text{A}$		V_{ECO}	7			V
Collector dark current	$V_{CE} = 25\text{ V}$, $I_F = 0\text{ A}$, $E = 0\text{ lx}$		I_{CEO}			100	nA
SWITCHING CHARACTERISTICS							
Turn-on time	$I_C = 2\text{ mA}$, $V_S = 5\text{ V}$, $R_L = 100\text{ }\Omega$ (see figure 2)		t_{on}		10		μs
Turn-off time	$I_C = 2\text{ mA}$, $V_S = 5\text{ V}$, $R_L = 100\text{ }\Omega$ (see figure 2)		t_{off}		8		μs

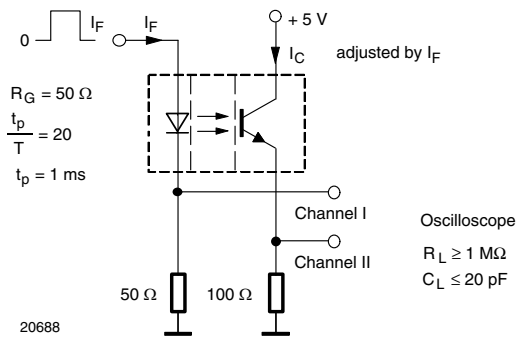
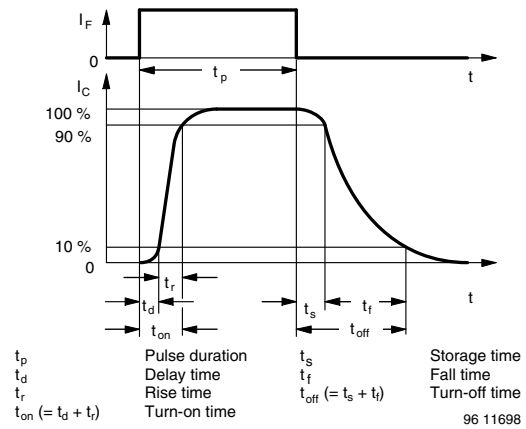

 Fig. 2 - Test Circuit for t_{on} and t_{off}


Fig. 3 - Switching Times

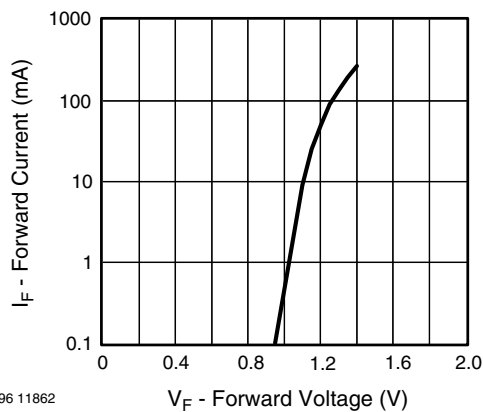
BASIC CHARACTERISTICS ($T_{amb} = 25\text{ }^{\circ}\text{C}$, unless otherwise specified)


Fig. 4 - Forward Current vs. Forward Voltage

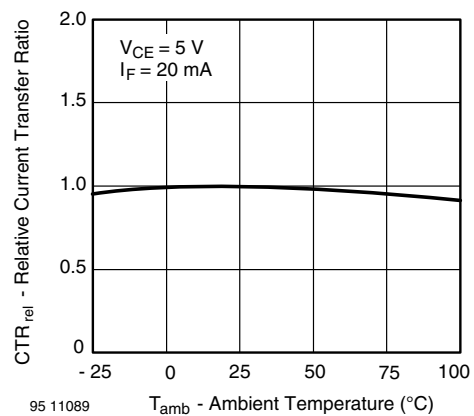


Fig. 5 - Relative Current Transfer Ratio vs. Ambient Temperature

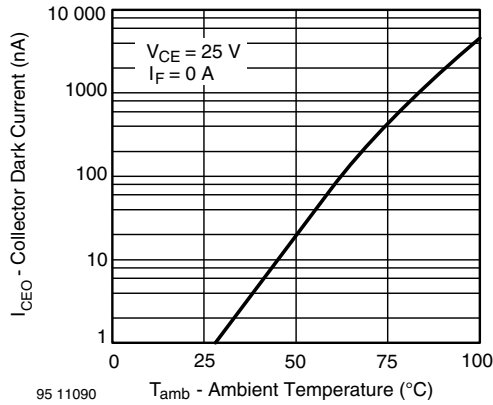


Fig. 6 - Collector Dark Current vs. Ambient Temperature

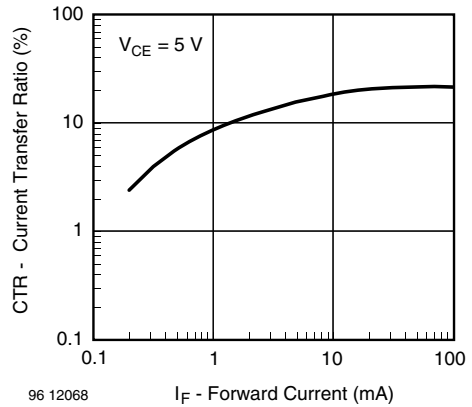


Fig. 9 - Current Transfer Ratio vs. Forward Current

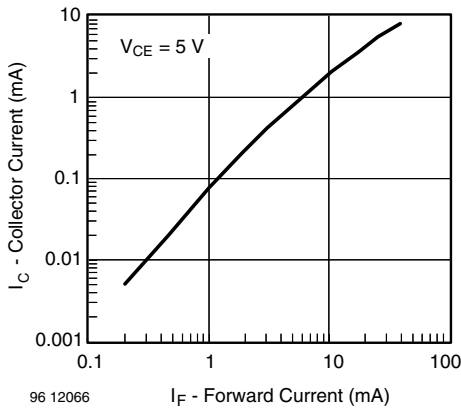


Fig. 7 - Collector Current vs. Forward Current

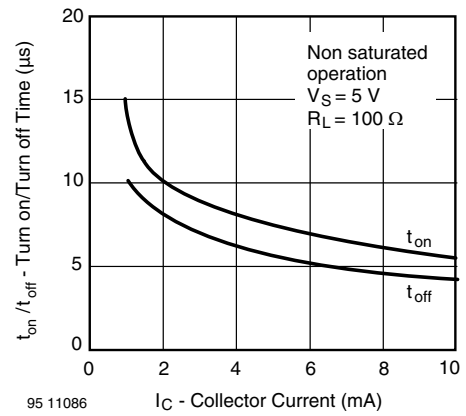


Fig. 10 - Turn-off/Turn-on Time vs. Collector Current

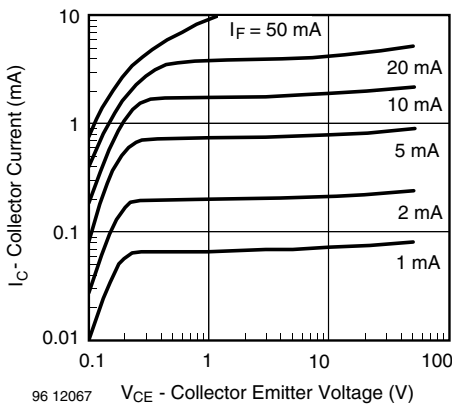


Fig. 8 - Collector Current vs. Collector Emitter Voltage

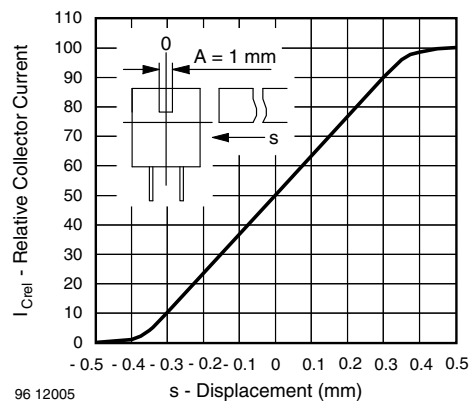


Fig. 11 - Relative Collector Current vs. Displacement