

216SP Series, 5x20 mm, Fast Acting Fuse



Description

5x20mm fast acting ceramic body cartridge fuse Designed to IEC specification









Features

- Designed to International (IEC) Standards for use globally
- High breaking capacity
- Meets the IEC 60127-2, Sheet 1 specification for Fast-Acting fuses
- RoHS compliant and lead-free

Applications

Used as supplementary protection in appliance or utilization equipment to provide individual protection for components or internal circuits.

Agency Approvals

Agency		Ampere Range
	NBK080205-E10480B NBK250702-E10480F	1A – 5A 6.3A – 10A
	CQC10012049970	1A – 10A
	SU05001-11001A SU05001-11002A	1A – 2.5A 3.15A – 6.3A
	E10480	1A – 10A
	29862	1A – 10A
	40013834	1 – 6.3A
	J50248090	8A/10A
	N/A	1A – 10A

Electrical Characteristics for Series

% of Ampere Rating	Ampere Rating	Opening Time
210%	1A – 4A	30 minutes, Maximum
	5A – 6.3A	30 minutes, Maximum
	8A – 10A	30 minutes, Maximum
275%	1A – 4A	0.01 sec., Min.; 2 sec. Max.
	5A – 6.3A	0.01 sec., Min.; 3 sec. Max.
	8A – 10A	0.04 sec., Min.; 20 sec. Max.
400%	1A – 4A	.003 sec., Min.; 0.3 sec. Max.
	5A – 6.3A	.003 sec., Min.; 0.3 sec. Max.
	8A – 10A	.01 sec., Min.; 1.0 sec. Max.
1000%	1A – 4A	.02 seconds, Maximum
	5A – 6.3A	.02 seconds, Maximum
	8A – 10A	.03 sec.onds, Maximum

Electrical Characteristic Specifications by Item

Amp Code	Amp Rating	Voltage Rating	Interrupting Rating	Nominal Resistance Cold Ohms (Ohms)	Nominal Melting I ² t (A ² sec)	Maximum Voltage Drop at Rated Current (mV)	Maximum Power Dissipation at 1.5I _n (W)	Agency Approvals									
																	
001	1	250	1500 A @ 250 VAC	0.2370	0.18000	1000	2.5	x	x	x	x	x	x	x	x	x	
01.6	1.6	250		0.1112	1.00500	600	4	x	x	x	x	x	x	x	x	x	x
002	2	250		0.0764	1.87000	500	4	x	x	x	x	x	x	x	x	x	x
02.5	2.5	250		0.0584	3.67200	400	4	x	x	x	x	x	x	x	x	x	x
3.15	3.15	250		0.0368	6.70000	350	4	x	x	x	x	x	x	x	x	x	x
004	4	250		0.0247	14.99500	300	4	x	x	x	x	x	x	x	x	x	x
005	5	250		0.0183	27.46000	250	4	x	x	x	x	x	x	x	x	x	x
06.3	6.3	250		0.0137	56.43000	200	4	x	x	x	x	x	x	x	x	x	x
008	8	250		0.0123	64.31500	200	4	x	x		x	x		x	x	x	x
010	10	250		0.0079	154.34000	200	4	x	x		x	x		x	x	x	x

I²t test at 10x rated current

Temperature Re-rating Curve

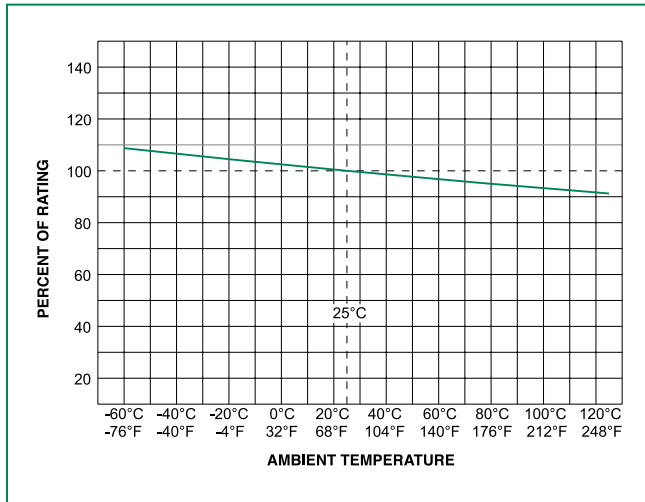

Note:
Rerating depicted in this curve is in addition to the standard derating of 25% for continuous operation.

Average Time Current Curves

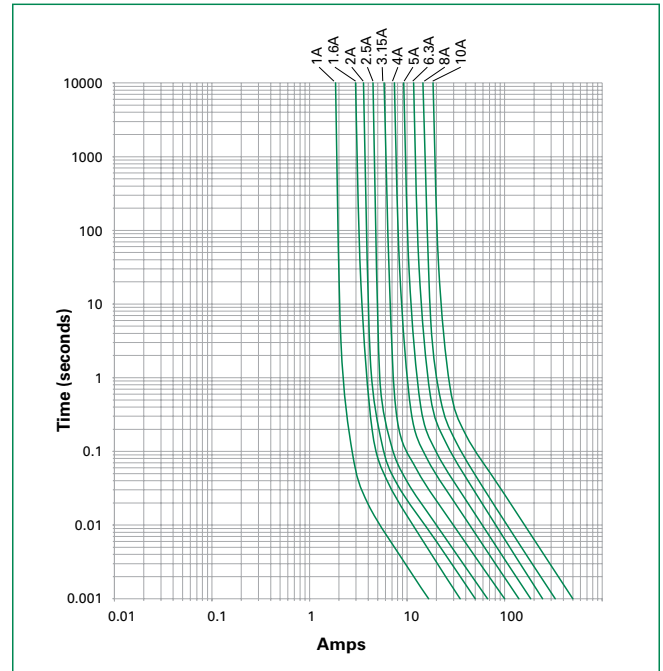

Soldering Parameters - Wave Soldering

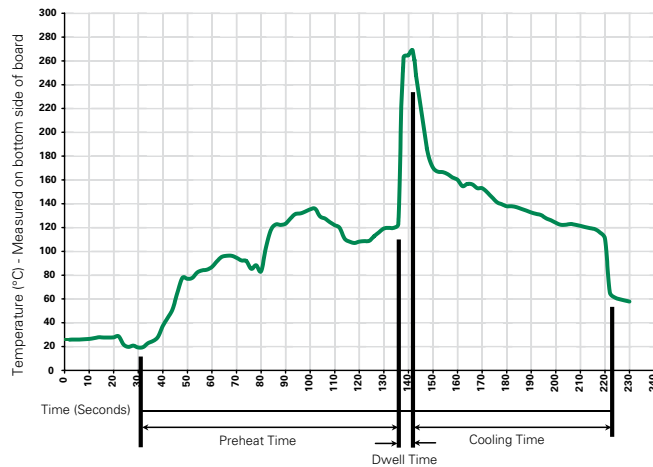

Recommended Process Parameters:

Wave Parameter	Lead-Free Recommendation
Preheat: (Depends on Flux Activation Temperature) (Typical Industry Recommendation)	
Temperature Minimum:	100°C
Temperature Maximum:	150°C
Preheat Time:	60-180 seconds
Solder Pot Temperature:	260°C Maximum
Solder Dwell Time:	2-5 seconds

Recommended Hand-Solder Parameters:

Solder Iron Temperature: 350°C +/- 5°C
Heating Time: 5 seconds max.

Note: These devices are not recommended for IR or Convection Reflow process.

Different values of A and B available, please contact the Littelfuse sales representative in your region:

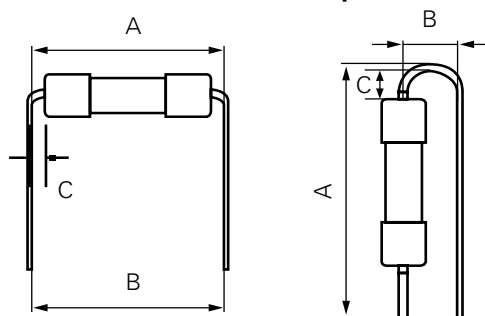

For the pigtailed fuse, please follow the recommendations below for axial lead forming and mounting into PCB:

Lead forming:

The distance C between cap flat surface and axial lead shall be greater than 1.0 mm.

PCB mounting:

According to the standard of IPC-A-610, the distance between PCB and fuse cap is recommended to be a minimum of 1.5 mm.

Product Characteristics

Materials	Body: Ceramic Cap: Nickel-plated Brass Leads: Tin-plated Copper
Terminal Strength	MIL-STD-202, Method 211, Test Condition A
Solderability	MIL-STD-202 Method 208
Product Marking	Cap 1: Brand logo, current and voltage ratings Cap 2: Agency approval marks

Operating Temperature	-55°C to +125°C
Thermal Shock	MIL-STD-202, Method 107, Test Condition B (5 cycles, -65°C to +125°C)
Vibration	MIL-STD-202, Method 201
Humidity	MIL-STD-202, Method 103, Test Condition A (High RH (95%) and elevated temp (40°C) for 240 hours)
Salt Spray	MIL-STD-202, Method 101, Test Condition B

Dimensions

All dimensions in mm

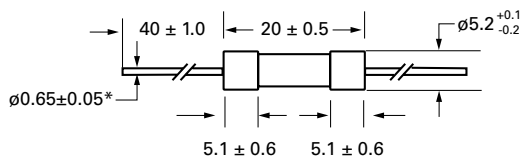

Notes:

* Ratings 8A and 10A have 0.8 ± 0.05 diameter lead.

Part Numbering System

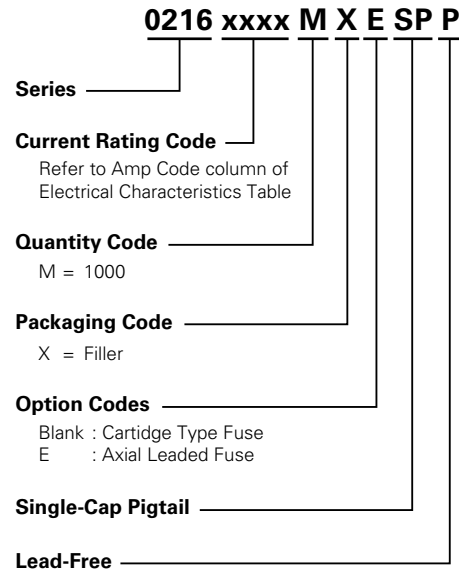

Packaging

Packaging Option	Packaging Specification	Quantity	Packaging Code	Reel Size
216SP Series				
Bulk	N/A	1000	MXE	N/A

Additional Information



Datasheet



Resources



Samples