

Dimensions

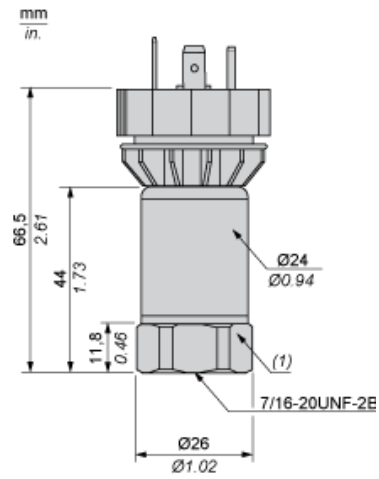

(1) SW24 tightening torque  $\leq 10$  N.m / 221 lb-in

---

Wiring Diagram

---

2-Wire Technique (4-20 mA)

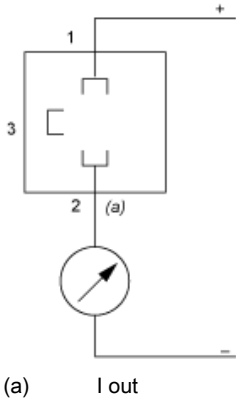

(a) I out