

# MAC Servo Drives with servo drive modules

Applications manual





Title: **MAC servo drives  
with TDM and KDS servo drive modules**

Type of documentation: Applications manual

Document No.: 120-0001-B301-02

Date: Sept. 1999

Replacement for: 9.552.268.4-01

This documentation is used for:

- The definition of the range of applications
- Assembly and installation
- Commissioning and fault clearance

Copyright: „Unless expressly agreed, transmission and reproduction of this document, exploitation and communication of its contents are not allowed. Contraventions are liable to actions for damages. All rights to patents and registered designs reserved. (DIN 34-1)

We reserve the right to make changes to the contents of the document and the availability of the products.

**Documentation overview: „MAC servo drives“**

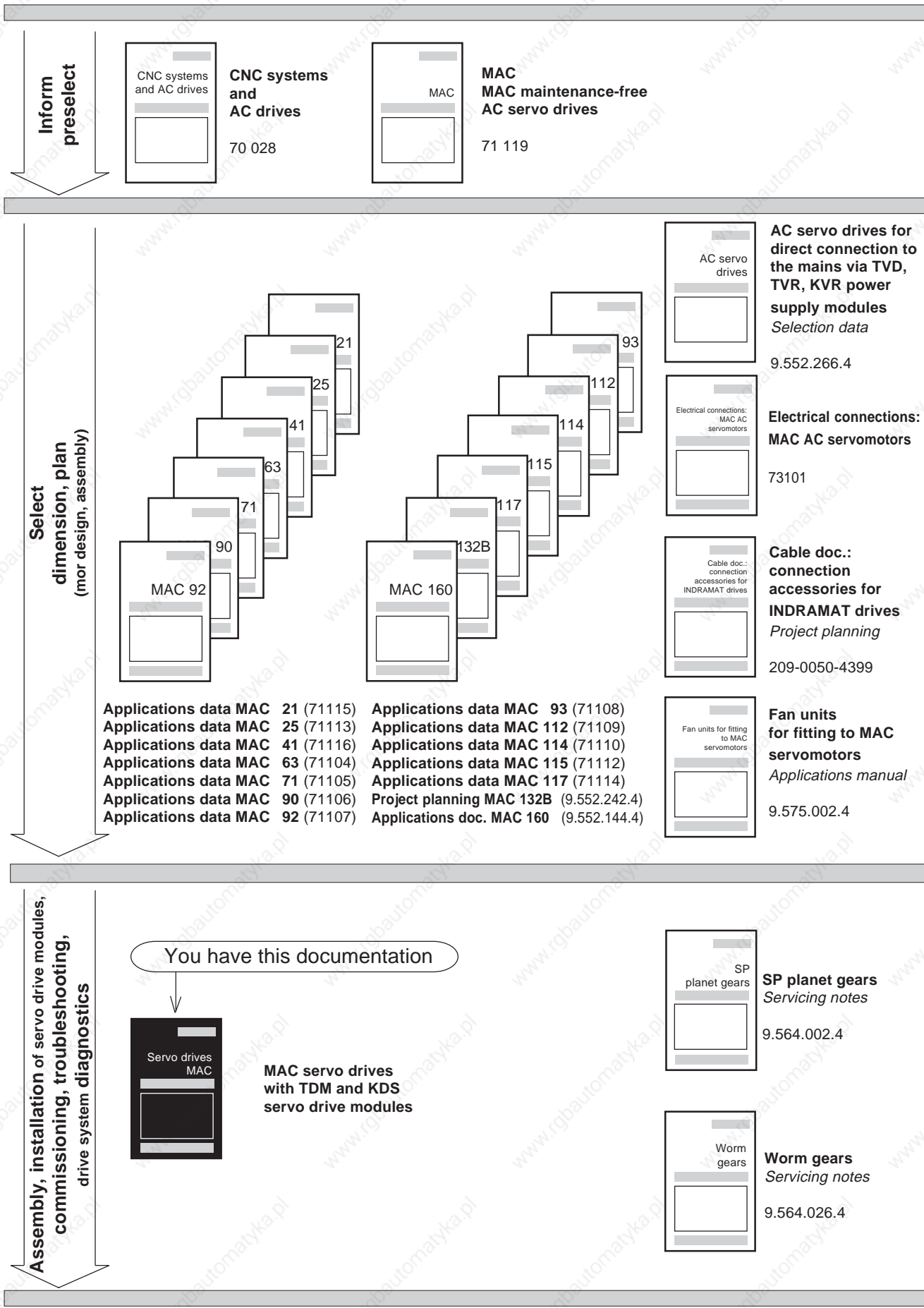
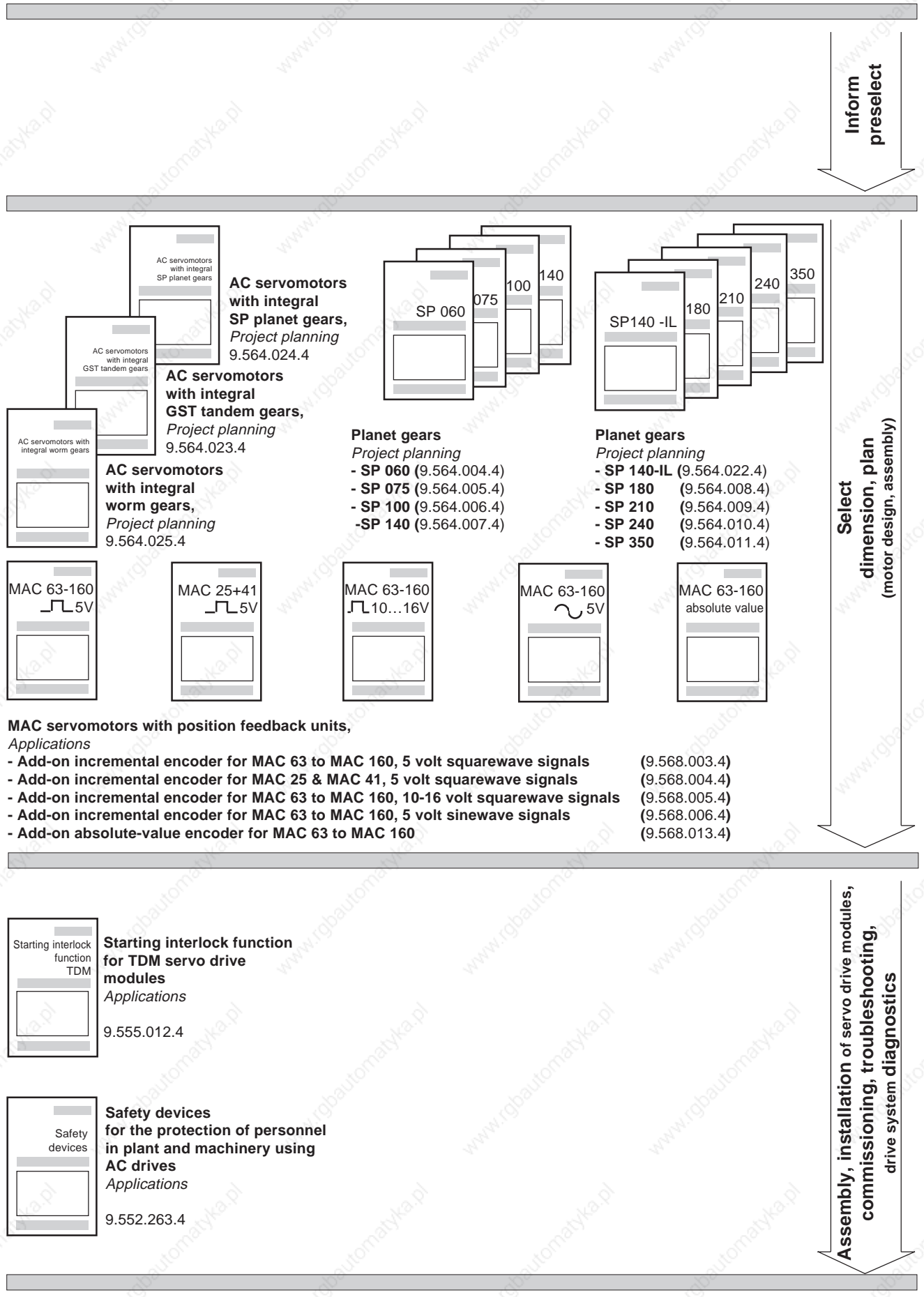

Fig.: Documentation overview: „MAC servo drives“





# Contents

<b>1. Mode of operation of the MAC drive</b>	<b>11</b>
1.1 Field of application .....	11
1.2 Construction of the servo drive system .....	12
1.3 Operation of the servo drive system .....	15
1.4 MAC servomotor .....	17
<b>2. Functions for the user</b>	<b>18</b>
2.1 Speed-controlled drive with speed set-point input .....	18
2.2 Available torque M(max), M(KB), M(dN) .....	20
2.3 Torque reduction via Ired input .....	22
2.4 Torque-controlled drive (tandem drive, master-slave drive) .....	23
2.5 Emergency-stop function .....	23
<b>3. Handling the MOD programming module</b>	<b>37</b>
3.1 Determining type of servo drive and motor .....	37
3.2 Input weighting and speed set-point smoothing (matching to NC) .....	37
3.3 Rating plates, labels and circuit diagrams .....	38
<b>4. User inputs/output</b>	<b>52</b>
<b>5. Connections and installation</b>	<b>54</b>
5.1 Protection of personnel and equipment .....	54
5.2 Assembly .....	54
5.2.1 Preferred arrangement of modular units in the control cabinet .....	54
5.2.2 Front view with accessories .....	55
5.2.3 KDS servo drive module cold running technology .....	62
5.2.4 Power reduction for increased temperature and installation altitude .....	63
5.2.5 Dimensional drawing and installation dimensions of servo drive modules .....	64
5.3 Connecting up and wiring the servo drive module .....	76
5.3.1 Mains connections .....	76
5.3.2 Connection accessories as supplied .....	76
5.3.3 Power connections .....	76
5.3.4 Motor power cables .....	77
5.3.5 Evaluation of the motor thermostat contact .....	77
5.3.6 Motor feedback cables .....	79
5.3.7 Position feedback units .....	80

5.3.8	Signal cables .....	80
5.4	Earthing connections .....	81
5.5	Interference suppression measures .....	81
5.5.1	Interference sources in the control cabinet .....	81
5.5.2	Use of radio equipment .....	81
5.5.3	Radio interference suppression .....	82
5.6	Connection and wiring diagrams .....	82
<b>6.</b>	<b>Commissioning</b> .....	<b>96</b>
6.1	Protection of personnel and machinery .....	96
6.1.1	Safety of personnel .....	96
6.1.2	Protection of equipment and machinery .....	98
6.2	Tools and equipment required for commissioning .....	101
6.3	Checks with the equipment switched off .....	102
6.3.1	Mains supply requirements .....	102
6.3.2	Installed drive components .....	102
6.3.3	Instructions for replacing the MOD programming module .....	102
6.3.4	Wiring and conductor cross-sections .....	103
6.3.5	Terminals and connecting points .....	104
6.4	Power-up sequence (overview) .....	106
6.5	Checks with the control voltage applied .....	108
6.6	Checks after the power infeed has been connected .....	110
6.7	Check after the drive has been connected .....	111
6.8	Matching to the NC .....	113
6.9	Checking the drive configuration .....	115
<b>7.</b>	<b>Troubleshooting and diagnostics</b> .....	<b>119</b>
7.1	Construction of the monitoring system in the modules (Fig. 71) .....	119
7.2	Effective troubleshooting .....	121
7.2.1	Possible causes of malfunctions, general .....	121
7.2.2	Fault messages at the terminal strips .....	121
7.3	LED diagnostic displays .....	125
7.3.1	Diagnostic displays on the power supply modules .....	125
7.3.2	Diagnostic displays on the drive modules .....	132
7.4	General faults and possible remedial measures .....	138
<b>8.</b>	<b>Notes on equipment replacement</b> .....	<b>140</b>
<b>9.</b>	<b>Summary of diagnostic displays on modules</b> .....	<b>142</b>



<b>10. Summary of data</b>	<b>154</b>
10.1 Important motor data .....	154
10.2 Important data on servo drive modules .....	157
<b>11. Equipment fuses in the individual modules</b>	<b>158</b>
<b>12. Technical data of servo drive modules</b>	<b>159</b>
<b>13. Type designations of drive components (type codes)</b>	<b>173</b>
<b>14. Overview of the most important standards applicable to INDRAMAT drive components</b>	<b>179</b>
<b>15. List of key words</b>	<b>180</b>



## 1. Mode of operation of the MAC drive

### 1.1. Applications

The MAC drive is especially designed for high-accuracy servo applications in NC machine tools for metal machining and wood working, transfer lines, automation systems, as well as in production machines in the automotive industry.

It is usually operated as a variable-speed drive in the position control loop of an NC. In this case a speed set-point is fed to the drive from the NC.

The MAC servo drive has the following application-specific functions:

- High short-time acceleration moments
- Torque reduction via I(red) input, which can be used for example when running up to a fixed stop, for reducing the load on the mechanical system coupled to the motor under specific operating conditions, for operating with controlled torque to load moving mechanical devices.
- Torque-controlled drive for master/slave operation of two motors that are solidly coupled together.
- Reversal of direction of rotation for same set-point polarity.
- Set-point input via a differential input or two summing inputs with zero voltage reference.
- Externally-adjustable drift offset via potentiometer.
- Equipment „ready“ state can be output via potential-free relay contact.
- Rapid and clear diagnostics and easy troubleshooting via the front panel diagnostics and status lamps.
- All adjustment parameters are set on the MOD programming module, so that the user of the servo drive does not need to carry out time-consuming adjustments and calibration procedures. Matching of the controller to the motor type by the user is therefore generally unnecessary since the control parameters are already optimized in the factory for the usual existing coupled masses.

## 1.2 Construction of the servo drive system

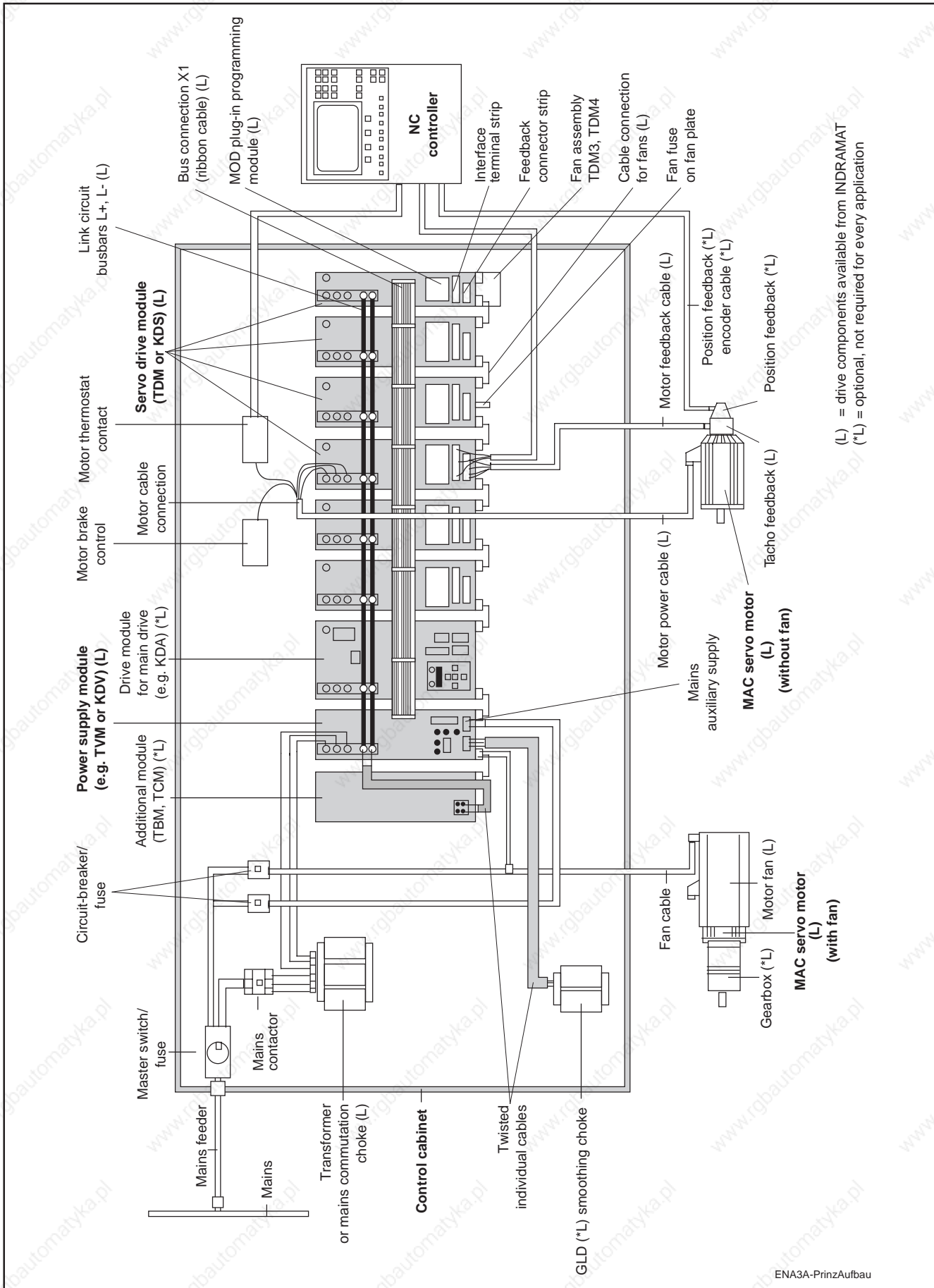

Fig. 1: Basic construction of the modular drive system with components marked.

## 1. Mode of operation of the MAC drive

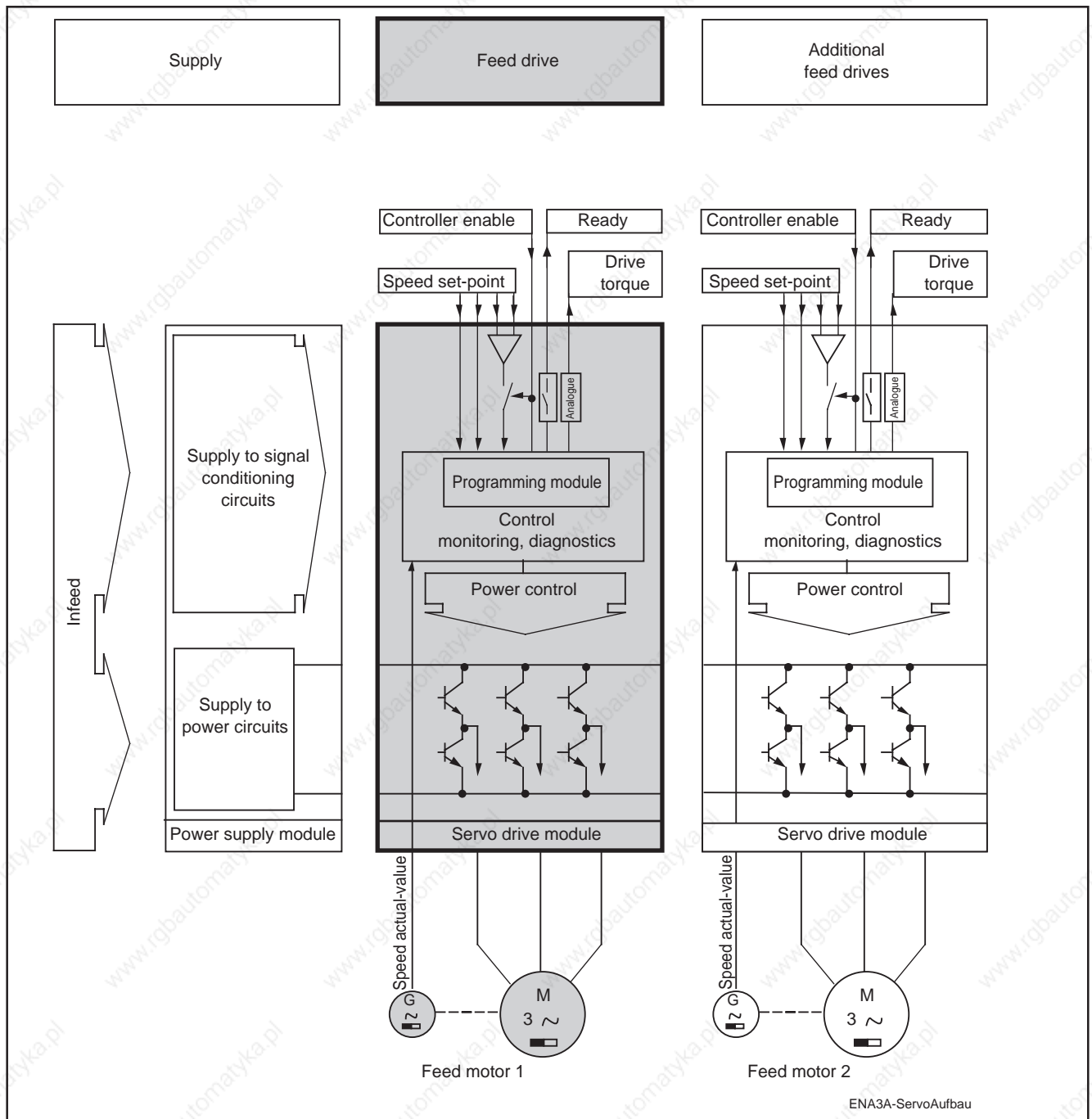

Fig. 2: modular construction

The three-phase servo drive system consists of

- the mains input components (master switch, contactor, transformer or commutation inductor, power supply module, smoothing chokes, additional capacitances),
- the servo drive module (control unit)
- the motor cable and
- the MAC servo motor.

The power supply module is able to supply several different types of servo drive units and a main drive if required.

## 1. Mode of operation of the MAC drive

For special applications the performance of the drive system can be further extended by additional modules (additional bleeder, TBM, additional capacitors, CZ or TCM). Further details of these can be obtained from the documentation covering the power supply modules.

The specific characteristics of the various servo drive modules and supply modules are summarized in the following table:

Servo drive module	Characteristics
TDM 1	Standard servo drive module for MAC 71 to MAC 160 motors
TDM 2	Obsolescent special unit for MAC 63 to MAC 93 motors
TDM 3	Standard servo drive module for MAC 63 to MAC 112B motors
TDM 4	Servo drive module for MAC 21, MAC 25, MAC 41 motors (feedback electronics built into drive module instead of motor)
TDM 6	Servo drive module for low-noise applications and with interface for temperature monitor, brake and starting interlock for MAC 63 to MAC 93 motors
TDM 7	Servo drive module for low-noise applications and with interface for temperature monitor, brake and starting interlock for MAC 21, MAC 25, MAC 41 motors (feedback electronics built into drive module instead of motor)
KDS 1	Servo drive module using cold-running technology for MAC 90 to MAC 160 motors (due to built-on external heat exchanger no heat losses occur in the control cabinet).

Fig. 3: Summary of the various servo drive modules

Power supply module	Characteristics
TVM 1	Power supply unit for connection of up to approximately 4 servo drives of up to an average mechanical output of 4.1 kW.
TVM 2	Standard power supply unit for connection of up to approximately 6 servo drives of up to an average mechanical output of 4.1 kW.
TVD 1	Power supply unit for direct connection to 3 x 380-460 volt mains, with built-in power contactor.
KDV 1	Power supply unit using cold-running technology (due to external heatsink, no heat losses occur in the control cabinet) for one main drive and 6 servo drives with an average mechanical output of 28 kW.
KDV 2	As KDV 1, but no series resistors required in the mains input for power-up. Controlled braking, especially of an associated asynchronous main drive is possible. Workpiece and tool can run free.
KDV 3	As KDV 2, but also has energy recovery for machines with large load masses and short machining cycles.
KDV 4	As KDV 3, but with direct mains connection to 380-460 volt supplies, and controlled link circuit voltage.

Fig. 4: Summary of the various power supply modules

### 1.3. Operation of the servo drive system

The power supply module generates the DC link circuit voltage from the AC input voltage. From this the servo drive module generates a three-phase system that is controlled according to amplitude, frequency and phase. This is applied to the MAC servo motor according to the current rotor position and the desired speed.

The relationship between the controlled three-phase system and the controlled operating states of the servo motor is established according to the following criteria:

#### Torque:

The current amplitude of the three-phase system in the stator of the servo motor determines the resulting torque via the field of the permanent-magnet-excited rotor. It results from the system deviation of the speed controller.

#### Speed:

The frequency of the three-phase system determines the speed of the servo motor. The rotor's position and frequency is derived from the signals of the rotor position encoder (BLC signals), depending on the required synchronism between the position of the magnetic field of the rotor and the position of the stator current.

# 1. Mode of operation of the MAC drive

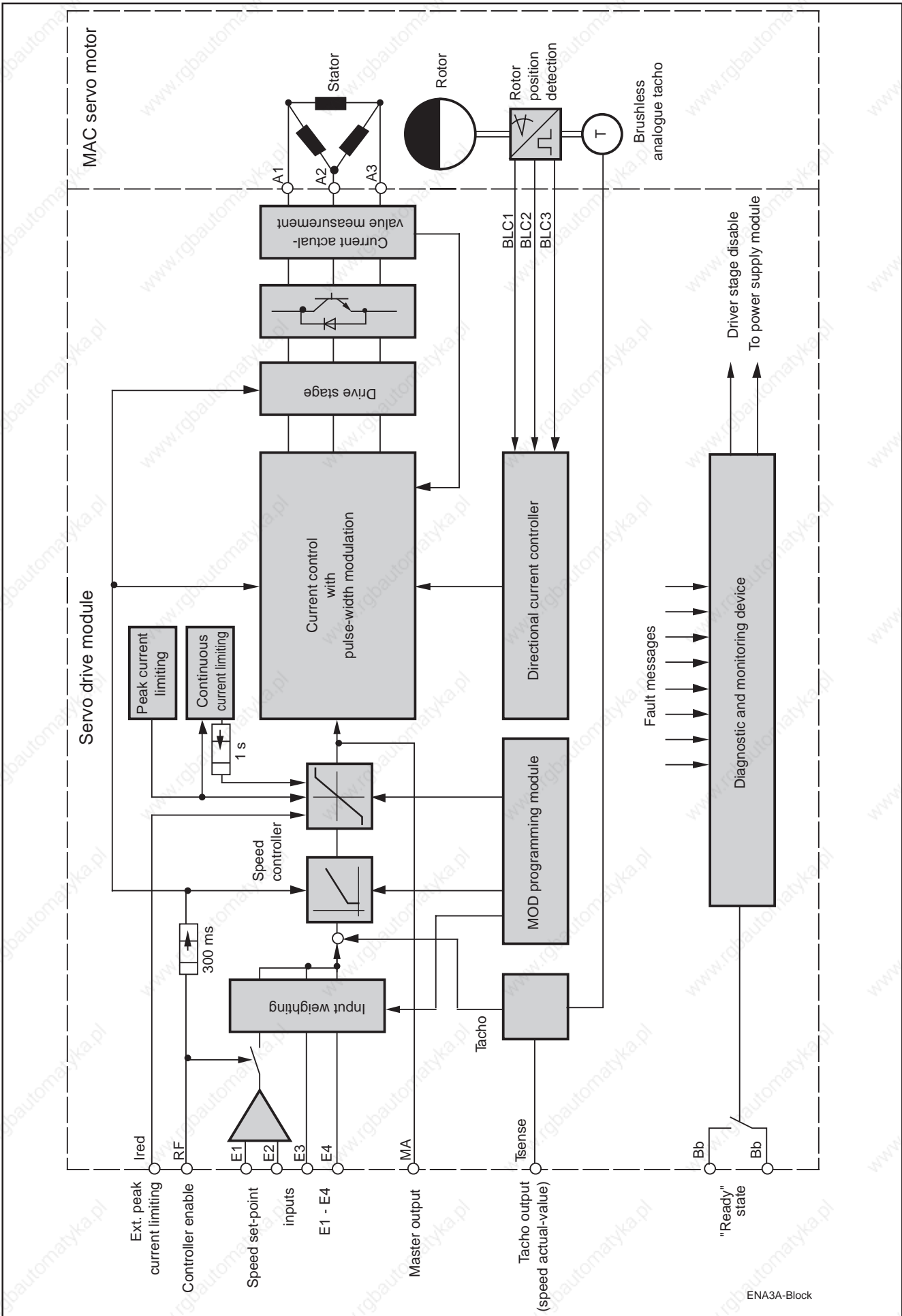

Fig. 5: Block diagram of servo drive module signal conditioning circuits



**Direction of torque:**

The phase relationship between the three-phase system and the magnetic field of the rotor determines the direction of the torque and is derived from the polarity of the system deviation of the speed controller.

**Control circuit signal conditioning:**

The speed controller compares the speed set-point and actual-value and from them generates the current set-point that is fed to the directional current controller via a limiter circuit (see Fig. 5).

Depending on the rotor position (signalled via the BLC signals from the rotor position encoder), the direction of the current for the three stator windings is controlled so that the resulting current flow in the stator is at its most favourable in relation to the magnetic flux of the rotor. This relationship ensures that the torque is proportional to the motor current. The motor current is controlled by a current controller. This is linked to the directional current controller in order to control the current in the three phases so as to obtain a three-phase system having controlled amplitude, frequency and phase.

The output signals of the current controller are timed in the pulse-width modulation stage and amplified via potential-free driver stages. The amplified signals used for driving the three-phase bridge constructed from six power transistors.

**1.4. MAC servo motor**

The MAC three-phase servo motor is a permanently-excited synchronous motor that is made up of the following main sub-assemblies:

- three-phase stator
- permanently-excited rotor
- optional electrically-released brake
- optional separate axial fan for surface ventilation

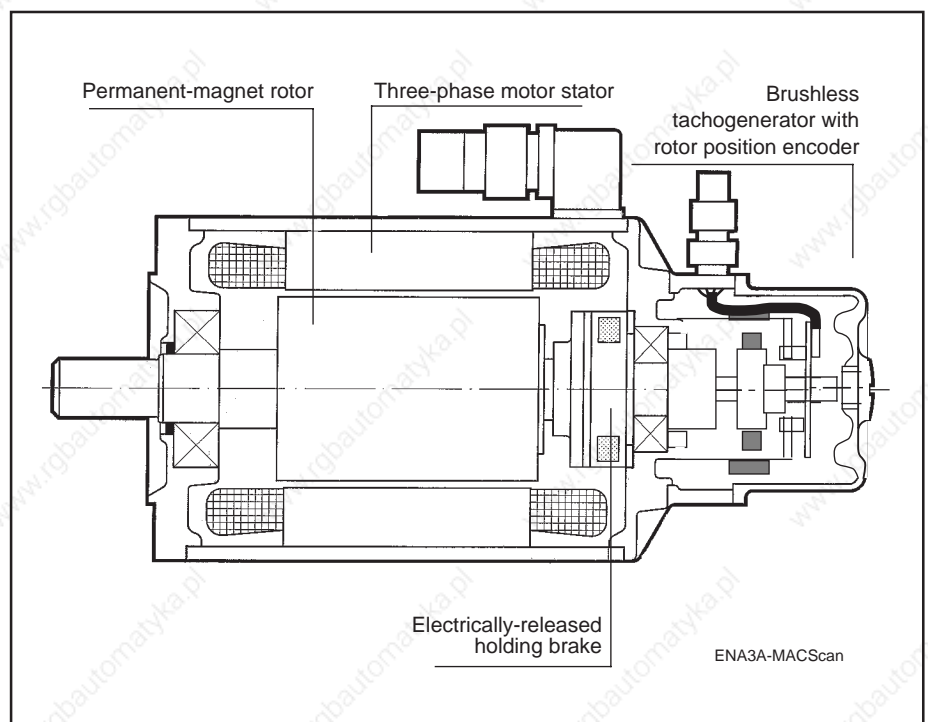

Fig. 6: MAC servo motor

## 2. Functions for the user

The user features listed in section 1.1 are described in detail here.

### 2.1. Speed-controlled drive with speed set-point input

After the mains voltage has been applied and the drive amplifiers signal that they are „ready“, the servo drive can be run at controlled speed by

- injecting the controller enabling signal at the RF input and
- applying an analogue set-point voltage, that is proportional to the motor speed, across the inputs
  - E1 and E2 or
  - E3 and 0 VM or
  - E4 and 0 VM.

The following settings are possible: (see basic circuit diagram of the servo drive module in Fig. 8).

Input E1-E2 is a differential input, inputs E3 and E4 are summing inputs that are referred to 0 VM.

The speed weighting (input sensitivity) has already been set in the factory on the MOD programming module. Two facilities are provided:

#### 1. Fixed setting by resistors soldered in place on the programming module

MOD 1 for TDM 1,  
MOD 5 for TDM 2,  
MOD 13 for TDM 3,  
MOD 17 for TDM 4,  
MOD 19 for TDM 6,  
MOD 21 for TDM 7,  
MOD 3 for KDS 1.

In each case

R8 refers to differential input E1-E2  
R9 refers to summing input E3-0VM  
R10 refers to summing input E4-0VM

#### 2. Input weighting adjustable via potentiometers P1, P2, P3 on programming module

MOD 2 for TDM 1,  
MOD 6 for TDM 2,  
MOD 14 for TDM 3,  
MOD 18 for TDM 4,  
MOD 20 for TDM 6,  
MOD 22 for TDM 7,  
MOD 4 for KDS 1.

The potentiometers are located on the programming module.

In each case

P1 and R8 refer to differential input E1-E2  
P2 and R9 refer to summing input E3-0VM  
P3 and R10 refer to summing input E4-0VM

The resistor and potentiometer values are incorporated into the MOD programming module according to the input weighting required by the user.

The last three digits of the programming module type designation specify the input weighting (see Section 3.2).

If no user data are available, the MOD programming module is given the input weighting of 10 volts per max. speed value (no adjustment potentiometer).

If necessary, the values R for R8, R9, R10 in MOD 1, MOD 3, MOD 5, MOD 13, MOD 17, MOD 19, MOD 21, and R8+P1, R9+P2, R10+P3 in

$$R = \frac{UE}{n} \cdot \frac{1}{Cw} \cdot 9230 - 5 \quad \text{in KOhm}$$

Where

R is the resistance value in kOhms

UE is the analogue input voltage in volts at E1-E2, E3-0V<sub>M</sub> or E4-0V<sub>M</sub> at the speed n used in the formula

n is the speed in rpm

Cw is the tacho voltage in volts at 1000 rpm, depending on motor type in use and shown in the table in Section 10.1

Example for Cw = 3 V/ 1000 rpm:

$$R = \frac{9.5}{3000} \cdot \frac{1}{3} \cdot 9230 - 5 = 4.74 \text{ KOhm}$$

### Set-point smoothing

MOD 2, MOD 4, MOD 6, MOD 14, MOD 18, MOD 20, MOD 22 can be calculated:

The speed set-point output by the NC can be smoothed if the staircase function becomes noticeably disturbed. It should be noted that excessive smoothing can reduce the dynamic response of the position control and thus slow the reaction time.

Set-point smoothing can be implemented only by using the differential input E1-E2. Smoothing is provided by soldering a capacitor C5 onto the MOD programming module (up to a maximum of 3uF is possible, corresponding to a smoothing time-constant of approximately 5 to 7 ms).

### Polarity of the speed set-point, reversal of the direction of rotation

With the motor rotating **clockwise**, as viewed from the output shaft, the direction of rotation is as follows:

- Differential input E1-E2: voltage at E1 is positive with respect to E2
- Summing inputs E3, E4: voltage at E3 or E4 is negative with respect to 0V<sub>M</sub>
- Tacho measuring signal at T(sense): voltage is positive with respect to 0V<sub>M</sub>

The following facilities are provided if another direction of rotation is desired:

- Interchange the connections at differential input E1-E2, if this is used,
- Reverse the direction of all inputs by linking terminals X6/9 and X6/10 at the control amplifier.

Reversing the direction of rotation by interchanging motor connections is not possible and causes the drive to malfunction.

**Drift compensation**

The speed controller has an extremely low temperature drift. The zero drift can be corrected on the „ZERO ADJ“ potentiometer at the bottom right of the front panel (front view in Figs. 35 to 40 in Section 5.2.2).

The drift should always be checked at initial operation and after replacing the servo drive module:

If the axis moves with a zero speed set-point, the rotary motion of the axis should be set to zero by means of the „ZERO ADJ“ potentiometer on the front panel when the control cabinet has reached its final temperature.

**2.2. Available torque**

$M_{(max)}$ ,  $M_{(KB)}$ ,  $M_{(dN)}$

The following torque values are available:

- $M_{(max)}$ : acceleration torque
- $M_{(KB)}$ : short-time torque for (short-time) machining
- $M_{(dN)}$ : continuous motor torque for 100% cyclic duration factor

The values for the existing drive amplifier/motor combination can be obtained from the selection list in the „MAC xxx servomotor“ documentation.

The torque values  $M(max)$  and  $M(KB)$  are permanently set on the MOD programming module via the maximum current and the continuous current and can be read from the „Current“ line on the rating plate. The following applies:

$$\frac{M_{(max)}}{M_{(KB)}} = \frac{\text{peak Current}}{\text{cont Current}}$$

The interval during which maximum torque is available depends on the difference between maximum and short-time duty torque. The time  $t_1$  that is generally available for acceleration cycles can be read from Fig. 7.

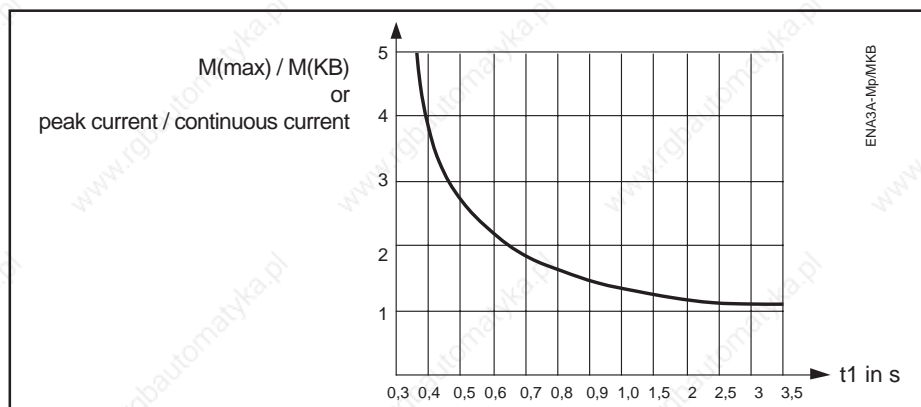

Fig. 7: Time available for acceleration cycles in relation to the peak torque/short-time duty torque ratio (in the standard version).

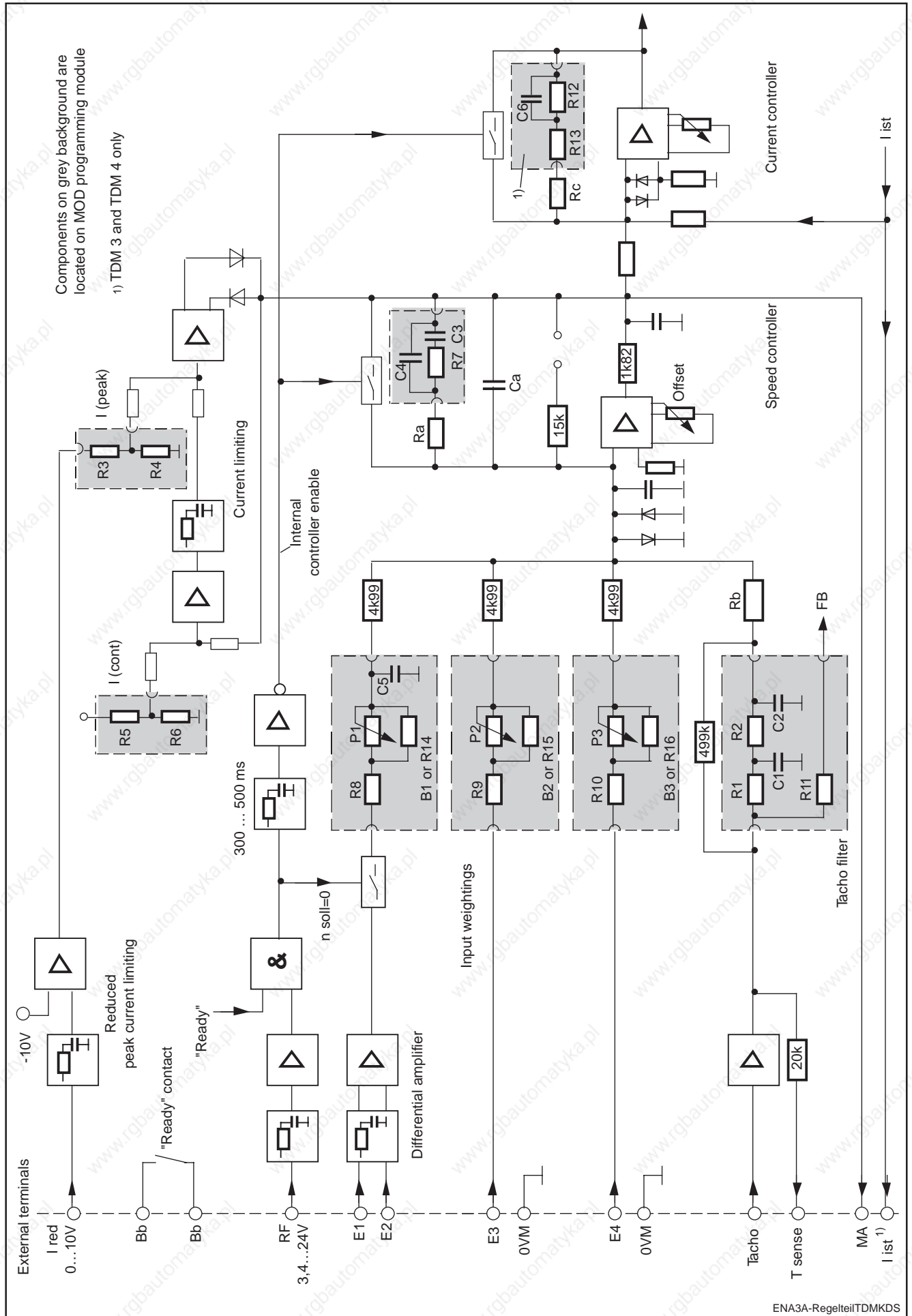

Fig. 8: Block diagram of servo drive module

### 2.3. Torque reduction via Ired input

If the peak torque of the drive has to be reduced for individual operating conditions on the machine, the maximum torque can be limited externally by the user via the Ired analogue input. In this case an analogue voltage is applied to the Ired input. The value of the voltage Ured depends on the desired reduction factor  $k = \text{reduced torque to maximum torque}$ :

$$U_{red} = 10 \text{ volts} \cdot (1 - k)$$

The value of the reduced motor current Ired can be obtained from the graphs in Figs. 9 and 10. The torque can be calculated from the current torque constant km of the motor in use, which can be obtained from the table in Section 10.1:

$$M = k_m \cdot I_{red}$$

The smallest adjustable torque is limited to a minimum value. The associated minimum adjustable motor current can be obtained from the table in Section 10.2.

If no analogue voltage is available for the Ired input, for a reduced torque value a resistor R(ex) can be connected between the Ired terminal and the +15 VM terminal via a relay contact. The value of this in kilohms is:

$$R(ex) = \frac{150}{1 - k} - 100 \text{ in kOhm}$$

Where:  
reduction factor  $k = \text{desired reduced torque to maximum torque}$ .

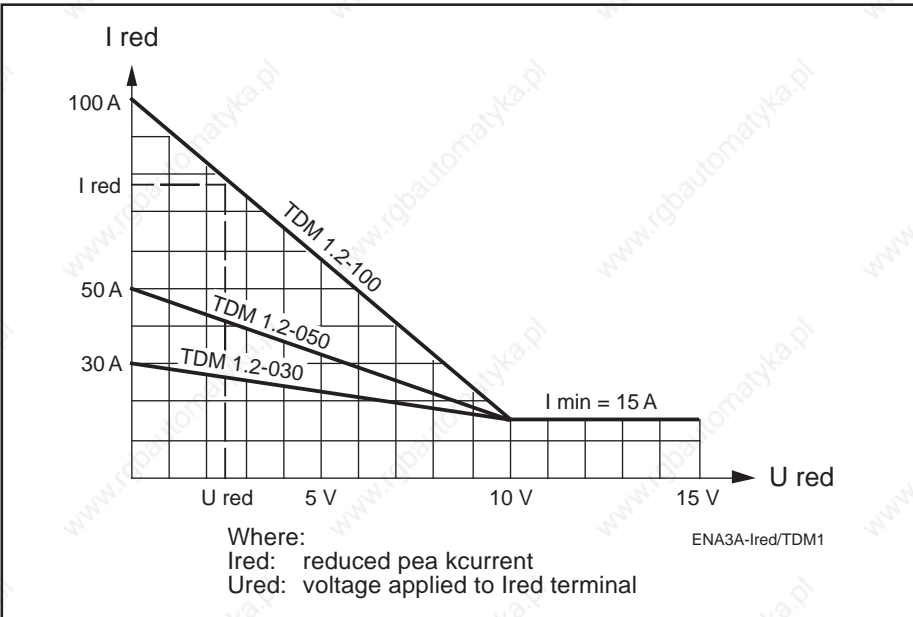

Fig. 9: External torque limiting for TDM 1

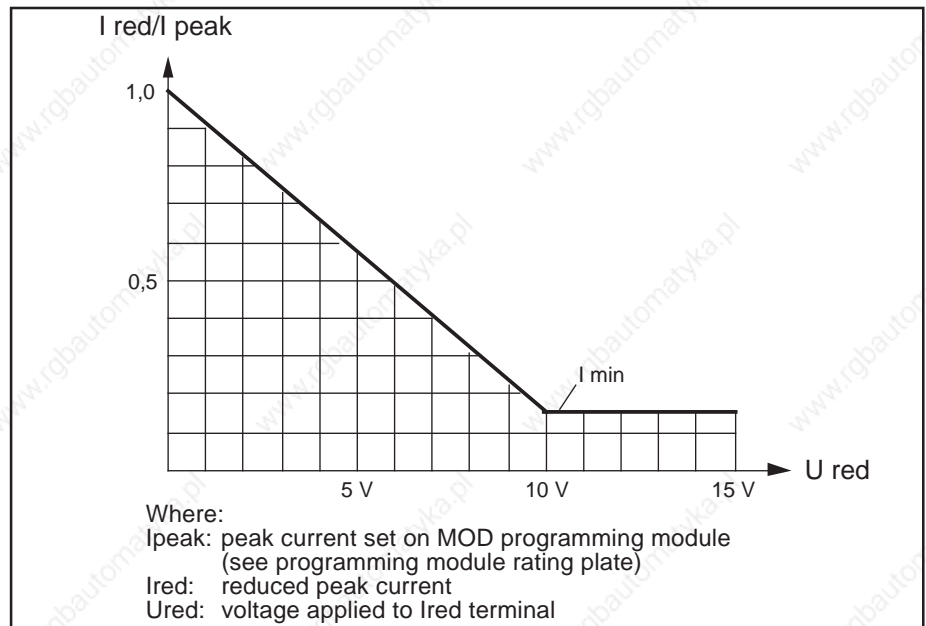

Fig. 10: External torque limiting for TDM 2 and TDM 1.2/SO 100, TDM 3, TDM 4, TDM 6, TDM 7, KDS 1.

#### 2.4. Torque-controlled drive (tandem drive, master-slave drive)

The servo drive can also be operated as a torque-controlled drive.

In the master-slave drive or tandem drive the speed controller of the master drive determines the speed of the slave drive. In such an operating mode the torque set-point is transferred to the set-point input of the slave drive from the speed-controlled master drive.

It should be noted that the motor shafts of the master and slave drives must be mechanically coupled together without backlash to prevent the slave drive accelerating without load torque when torque is applied. This coupling must be as rigid and as torsionally stiff as possible to prevent oscillations in the mechanical system.

Connections between the master drive and the slave drive are shown in Figs. 12 to 16. The MOD programming module should be specially configured for the slave drive.

#### 2.5. Emergency-stop function

A malfunction in the system or servo drive cannot be eliminated in an emergency-stop situation. It is therefore necessary in this case to isolate the power section of the drive from the mains supply via the mains contactor in order to stop the servo drive safely (by opening the emergency-stop circuit).

Until the servo drive is stopped it must always be assumed that faulty and dangerous drive movement can occur, the extent of which depends on the type of fault and the operating state of the drive at the time it occurs.

A higher-level safety measure must be provided to ensure that the drive disconnected via the emergency-stop circuit in the event of a general malfunction.



**For this reason, danger to personnel resulting from a malfunction must be eliminated by high-level protection at system level.**

## 2. Functions for the user

In order to render the electrical shutdown of the drive as independent of the controller as possible, after the external controller enabling signal has been removed the drive modules's set-point, which is injected at the E1-E2 input is set to zero internally, so that the drive can brake. The motor is then only free of torque after about 300 ms (see Fig. 11).

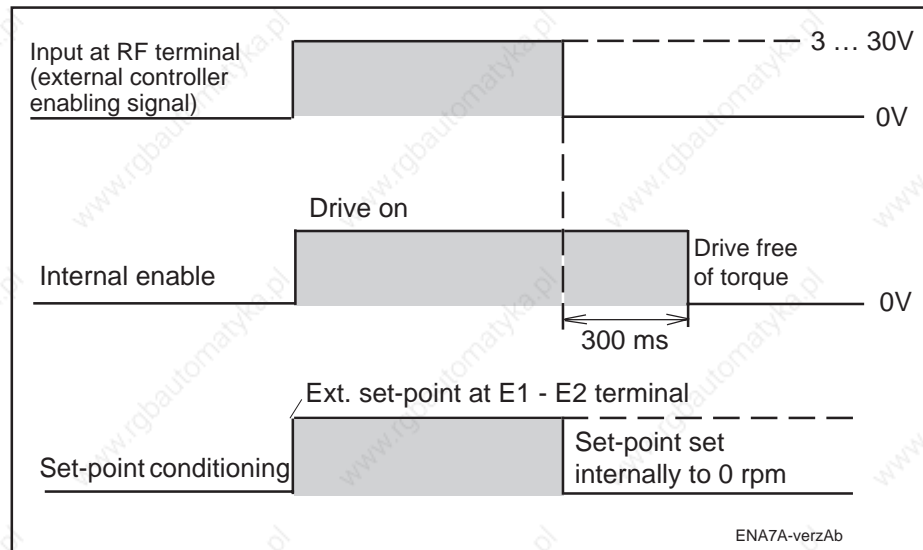

Fig. 11: Delayed disconnection of motor controller after the external controller enabling signal is removed.



## 2. Functions for the user

---

## 2. Functions for the user

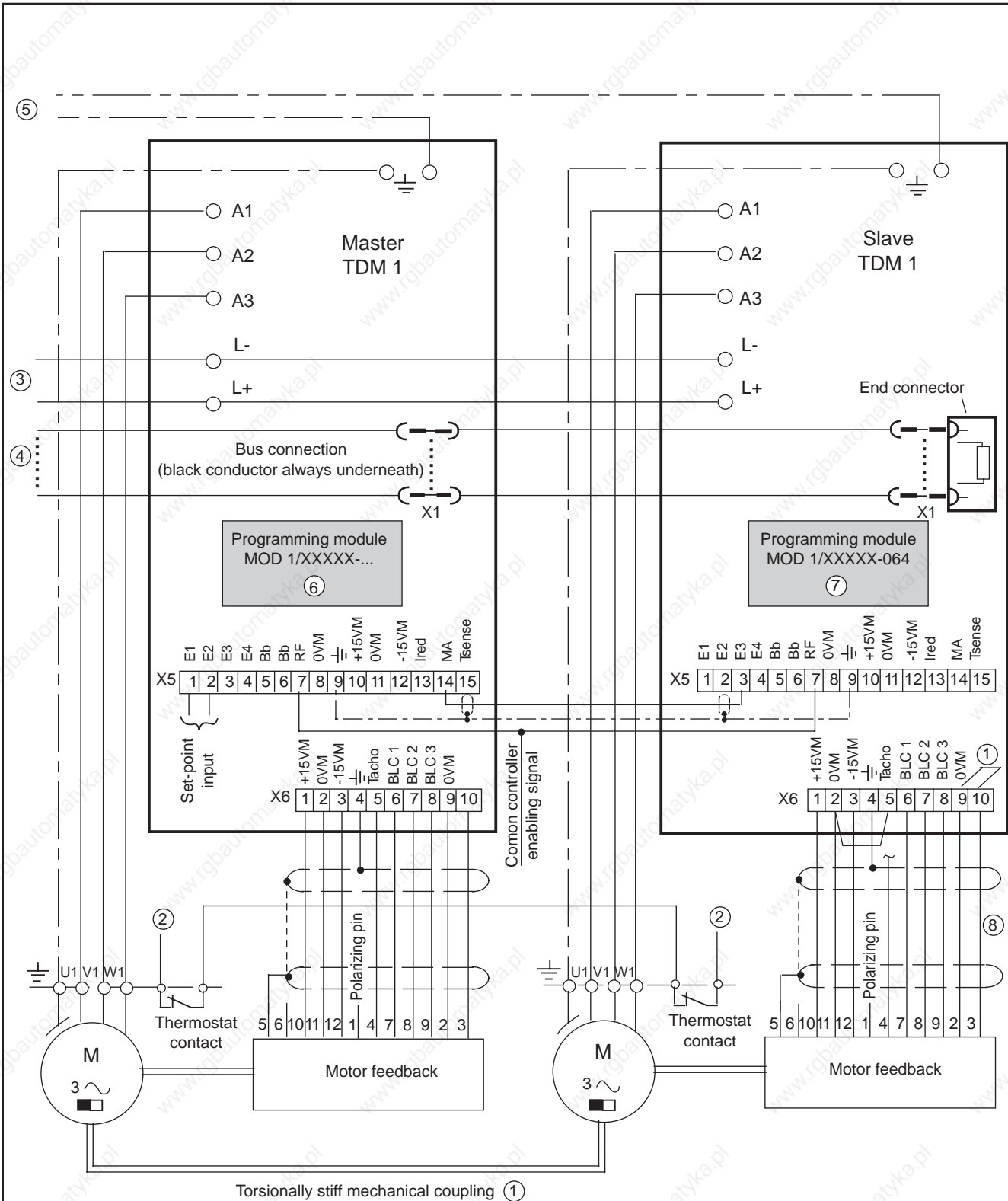
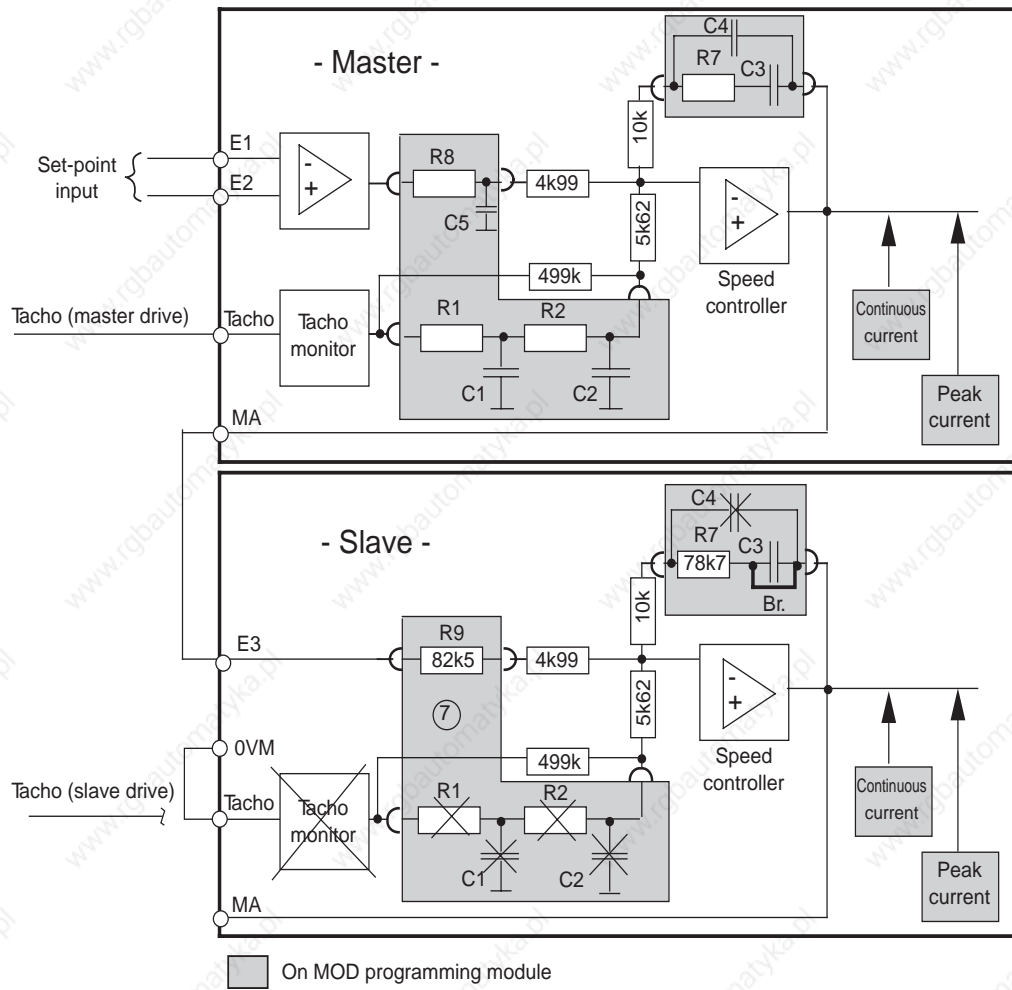

Fig. 12: Connection diagram for master-slave drive with TDM 1

## 2. Functions for the user



- ① Reversing the direction of rotation  
The directions of rotation of the master and slave drives can be identical or opposite, depending on the type of mechanical coupling. The direction of rotation can be matched to these requirements with the jumper ①.

Directions of rotation of master and slave drives are identical 	Directions of rotation of master and slave drives are opposite 
With jumper between X6/9 and X6/10 on slave	Without jumper between X6/9 and X6/10 on slave

- ② Evaluation in the Emergency-stop circuit
- ③ Power supply via DC link circuit
- ④ Bus connection: connecting cable for unit's own power supply and monitoring
- ⑤ To central earthing point on power supply module
- ⑥ Number as per motor/amplifier combination
- ⑦ Slave module component set  
Current limiting as per master; R1=R2=C1=C2=C4=not used; R7=78k7; C3=jumper; input weighting -064 without potentiometer
- ⑧ Use 9-core connecting cable only.

12BENA3A-MS/TDM1

2. Functions for the user

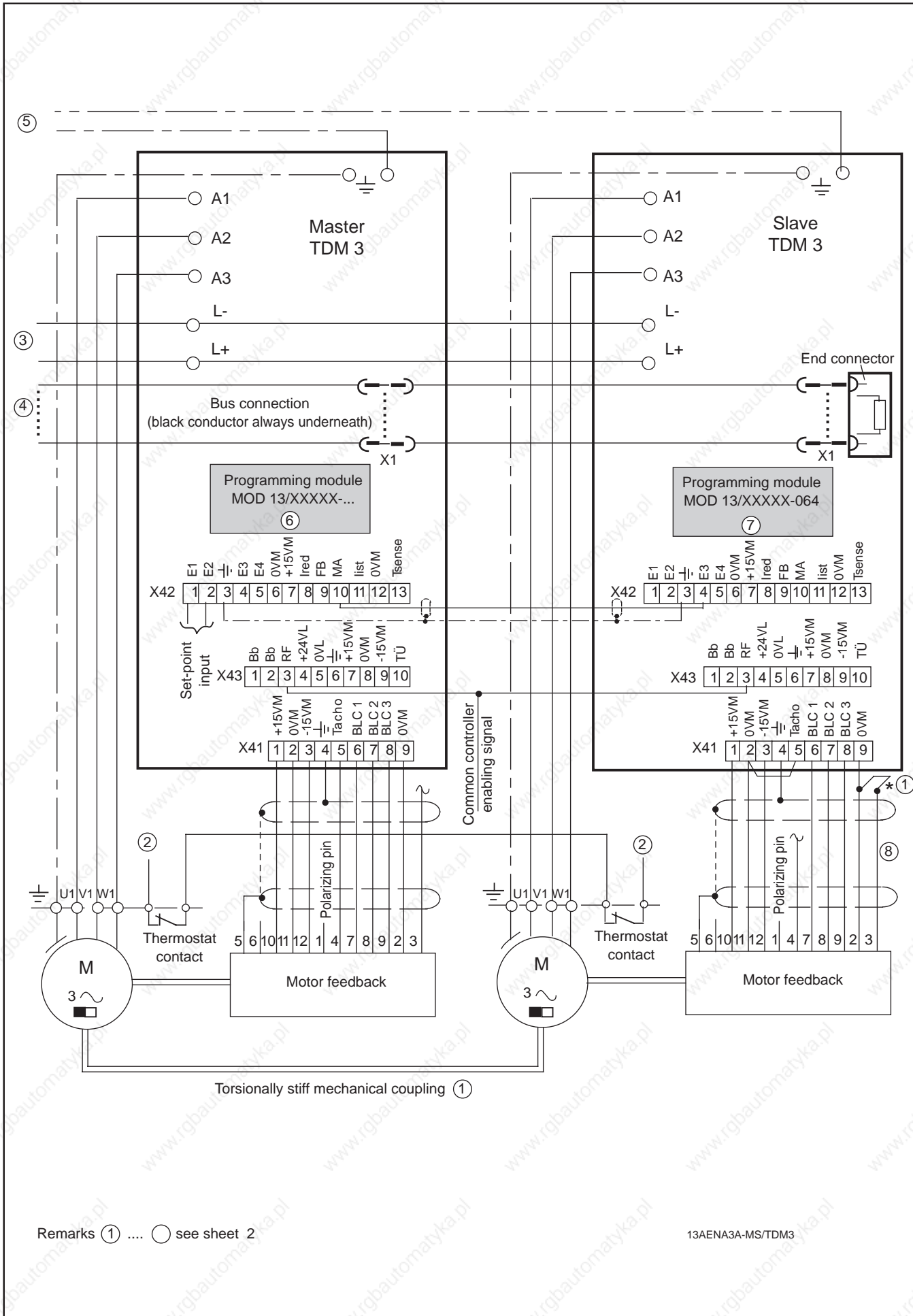
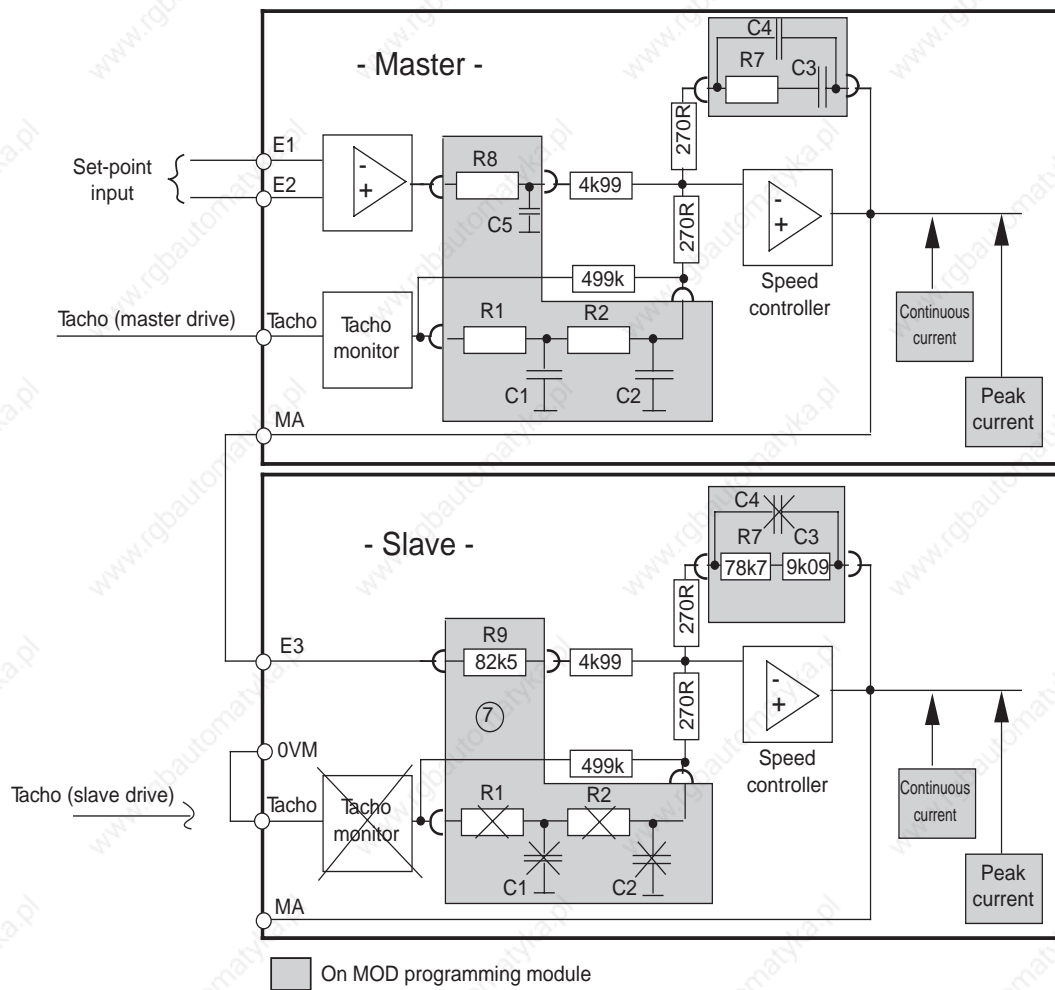

Fig. 13: Master-slave drive with TDM 3

## 2. Functions for the user



- ① Reversing the direction of rotation  
The directions of rotation of the master and slave drives can be identical or opposite, depending on the type of mechanical coupling. The direction of rotation can be matched to these requirements with the jumper ①.

Directions of rotation of master and slave drives are identical	Directions of rotation of master and slave drives are opposite
*Connect this conductor to X41/9 (0VM)	*Do not connect this conductor!

- ② Evaluation in the Emergency-stop circuit
- ③ Power supply via DC link circuit
- ④ Bus connection: connecting cable for unit's own power supply and monitoring
- ⑤ To central earthing point on power supply module
- ⑥ Number as per motor/amplifier combination
- ⑦ Slave module component set  
Current limiting as per master; R1=R2=not used; C1=C2=C4=not used; R7=78k $\Omega$ ; C3=9k09; input weighting -064 without potentiometer
- ⑧ Use 9-core connecting cable only.

13BENA3A-MS/TDM3

2. Functions for the user

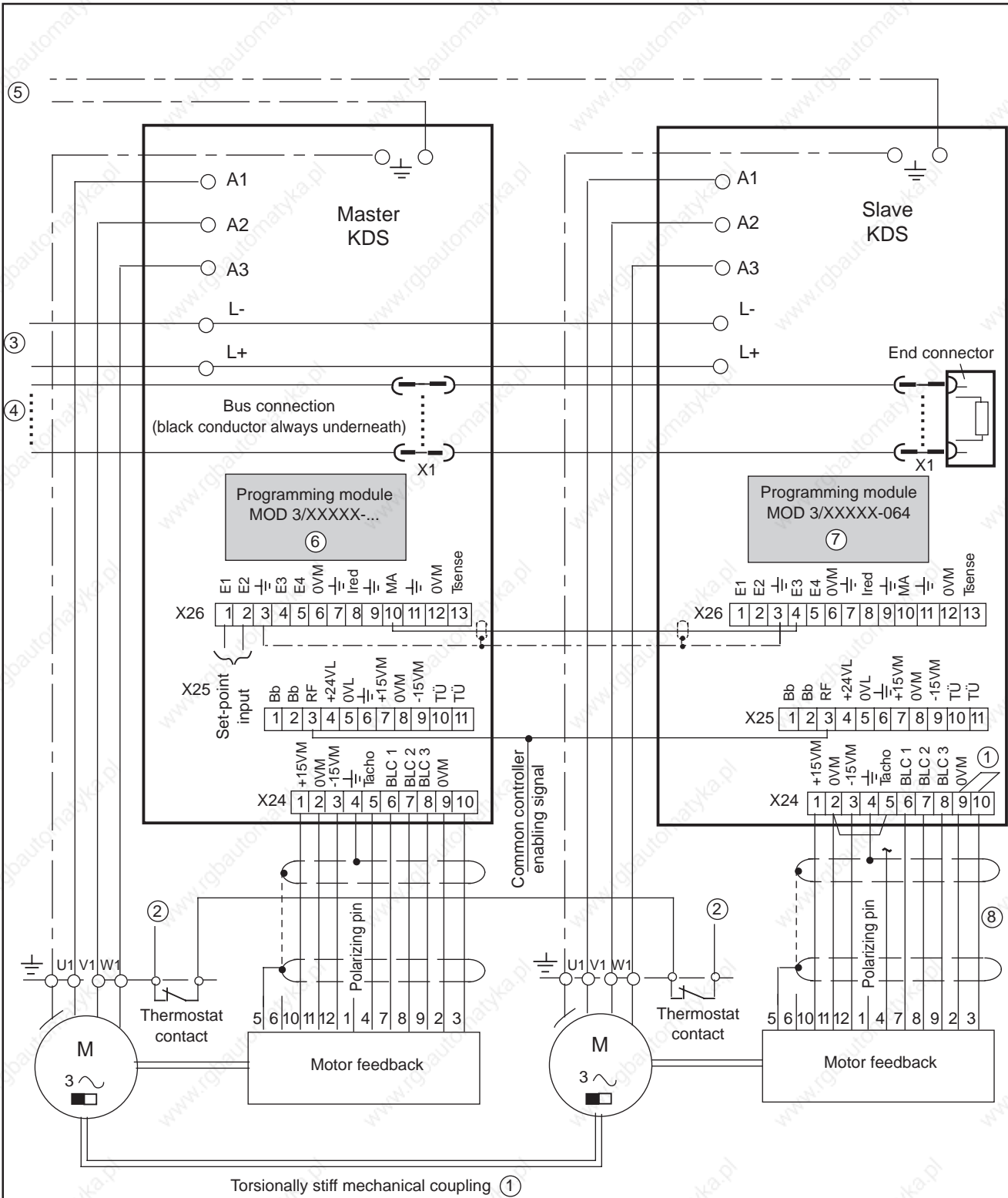

Remarks ① .... ○ see sheet 2

14AENA3A-MS/KDS

Fig. 14: Master-slave drive with KDS 1

## 2. Functions for the user

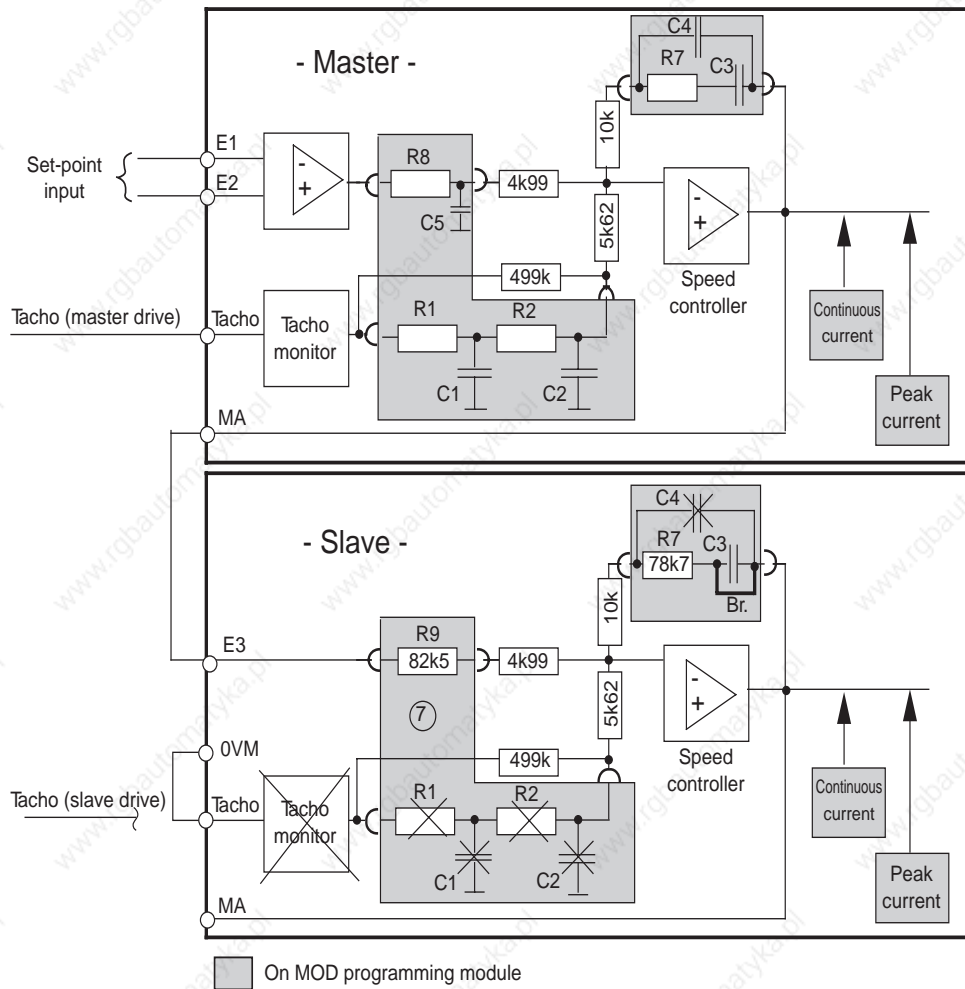

- ① Reversing the direction of rotation  
The directions of rotation of the master and slave drives can be identical or opposite, depending on the type of mechanical coupling. The direction of rotation can be matched to these requirements with the jumper ①.

Directions of rotation of master and slave drives are identical 	Directions of rotation of master and slave drives are opposite 
with jumper between X24/9 and X24/10 on slave	without jumper between X24/9 and X24/10 on slave

- ② Evaluation in the Emergency-stop circuit  
③ Power supply via DC link circuit  
④ Bus connection: connecting cable for unit's own power supply and monitoring  
⑤ To central earthing point on power supply module  
⑥ Number as per motor/amplifier combination  
⑦ Slave module component set:  
Current limiting as per master; R1=R2=C1=C3=C4=not used; R7=78k7; C2=jumper;  
input weighting -064 without potentiometer  
⑧ Use 9-core connecting cable only.

14BENA3A-MS/KDS

2. Functions for the user

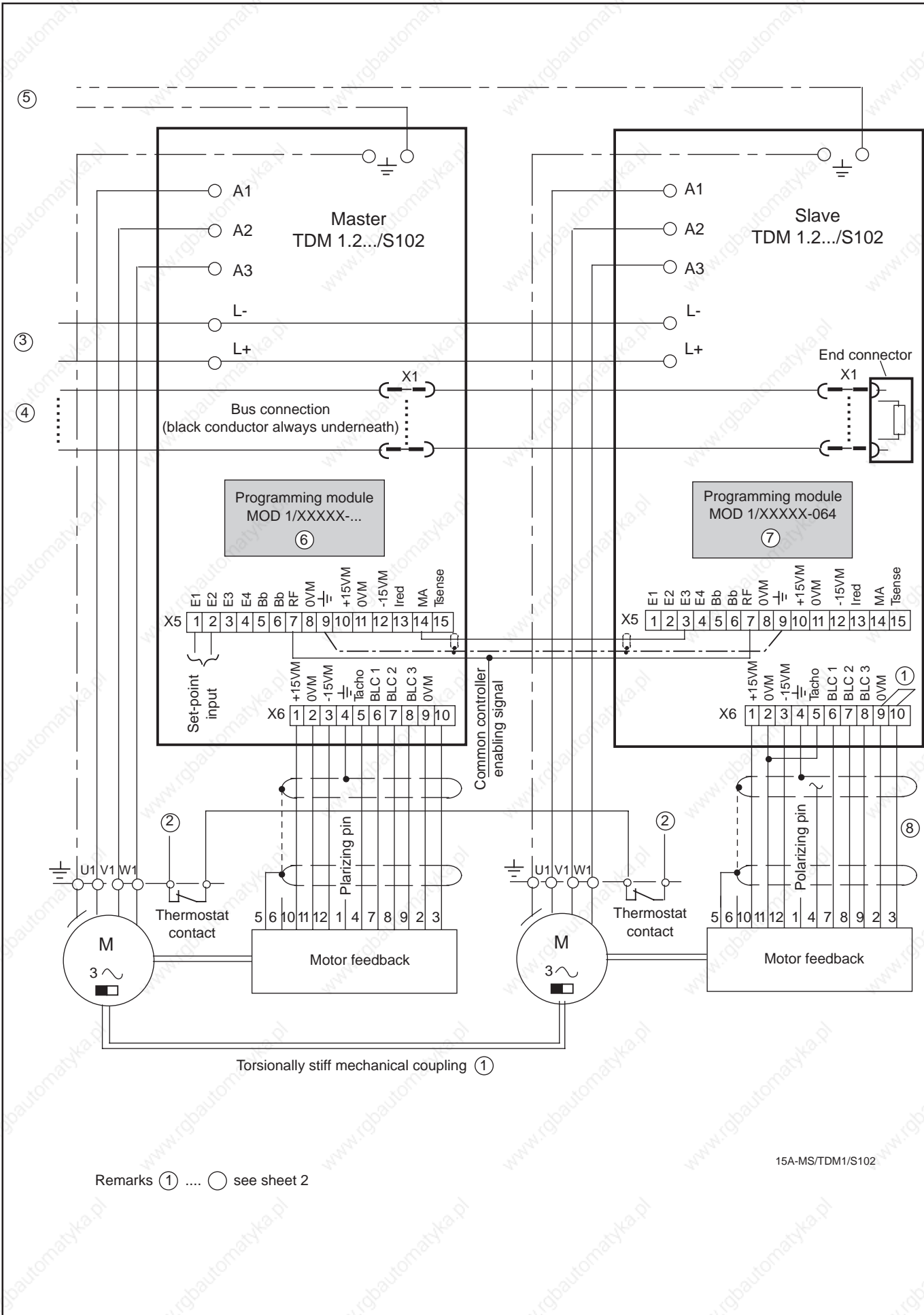

Remarks ① .... ○ see sheet 2

15A-MS/TDM1/S102

Fig. 15: Master-slave drive with TDM 1.2.../S102



## 2. Functions for the user

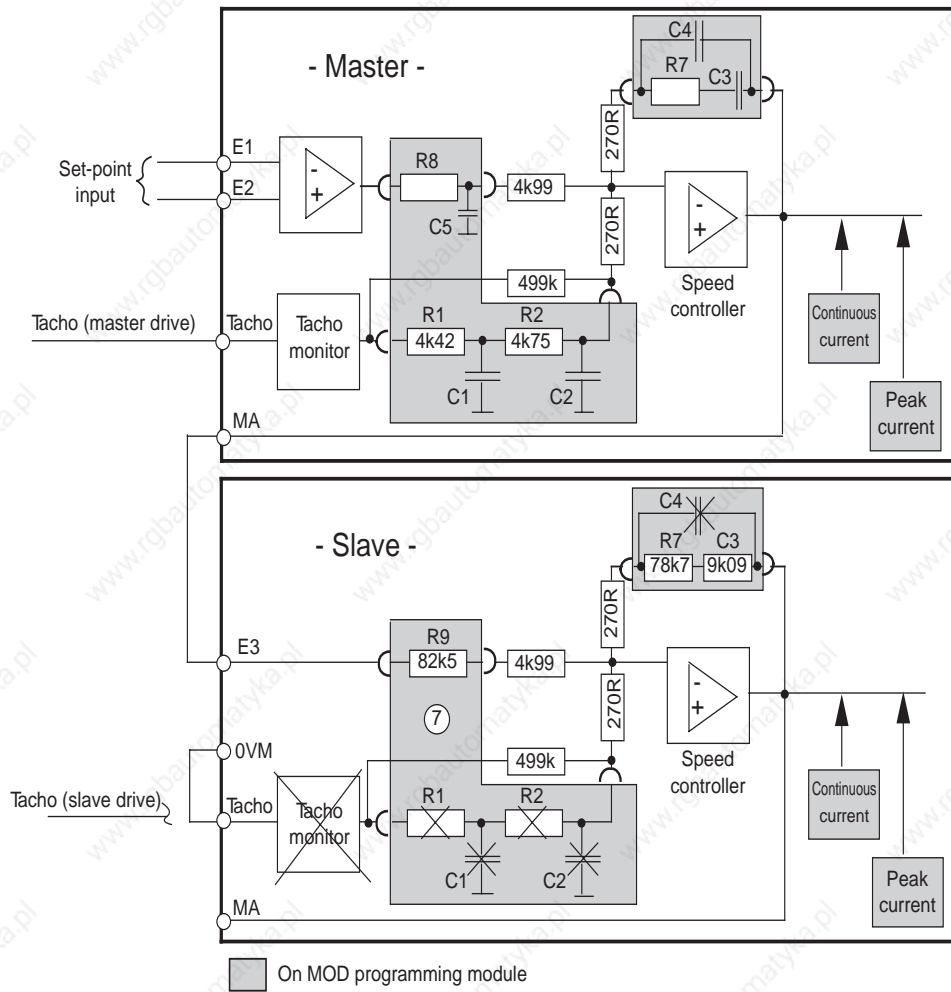

① Reversing the direction of rotation

The directions of rotation of the master and slave drives can be identical or opposite, depending on the type of mechanical coupling. The direction of rotation can be matched to these requirements with the jumper ①.

Directions of rotation of master and slave drives are identical	Directions of rotation of master and slave drives are opposite
with jumper between X6/9 and X6/10 on slave	without jumper between X6/9 and X6/10 on slave

② Evaluation in the Emergency-stop circuit

③ Power supply via DC link circuit

④ Bus connection: connecting cable for unit's own power supply and monitoring

⑤ To central earthing point on power supply module

⑥ Number as per motor/amplifier combination

⑦ Slave module component set:

Current limiting as per master; R1=R2=not used; C1=C2=C4=not used; R7=78k7; C3=9k09; input weighting -064 without potentiometer

⑧ Use 9-core connecting cable only.

15B-MS/TDM1/S102

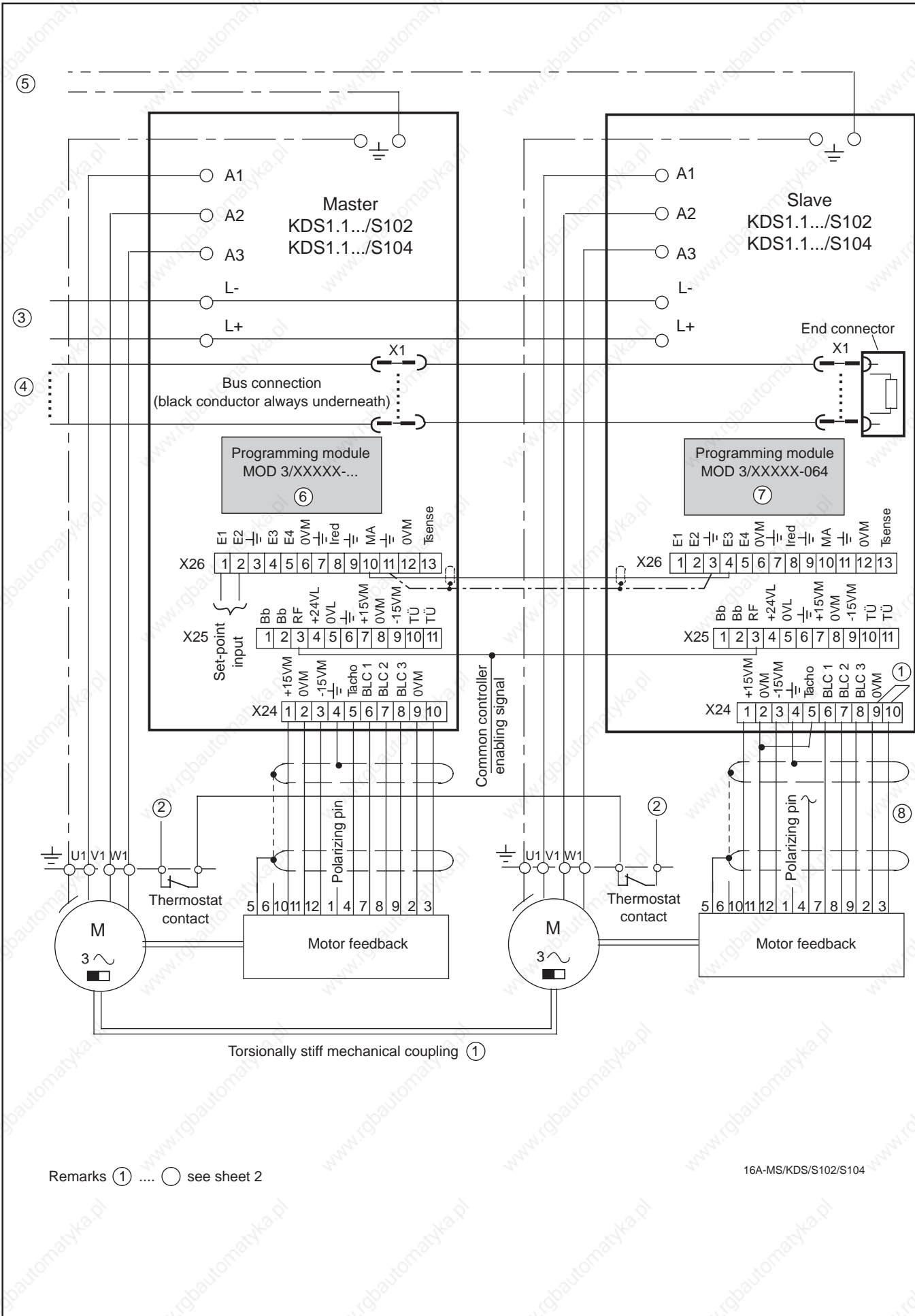

Remarks (1) .... (2) see sheet 2

16A-MS/KDS/S102/S104

Fig. 16: Master-slave drive with KDS 1.1.../S102 and S104

## 2. Functions for the user

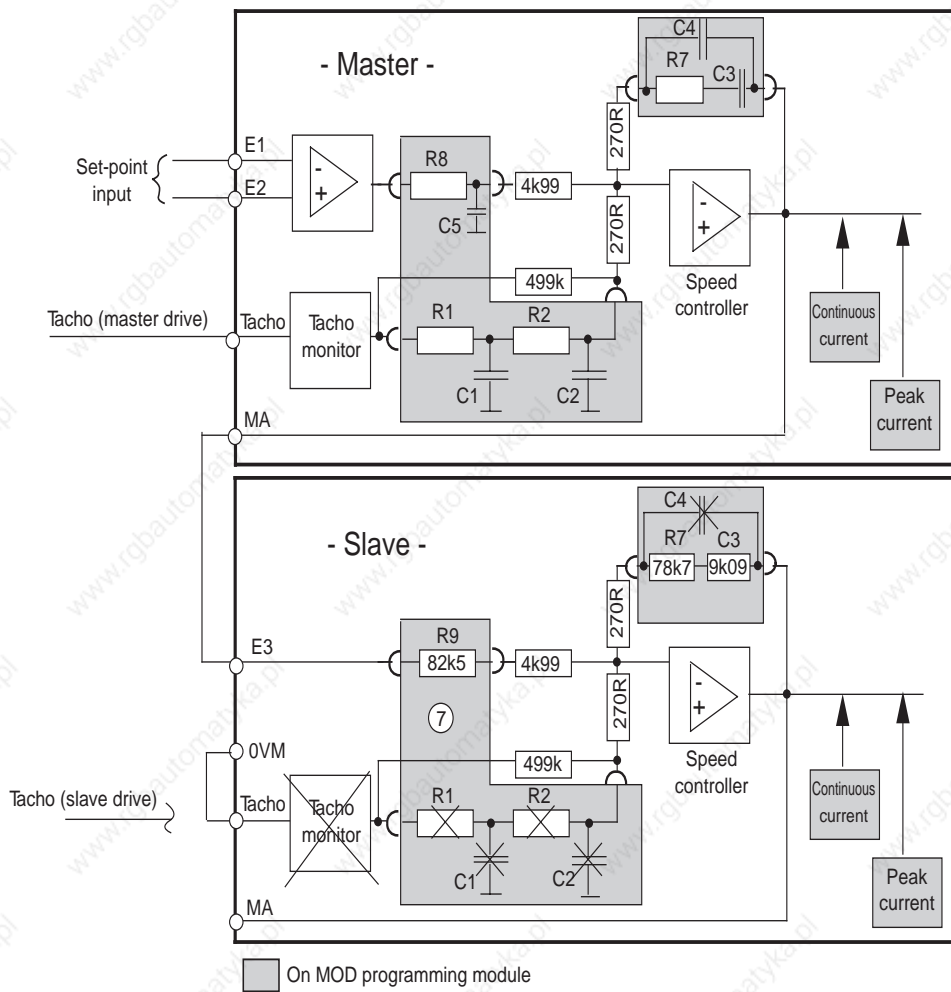

- ① Reversing the direction of rotation  
The directions of rotation of the master and slave drives can be identical or opposite, depending on the type of mechanical coupling. The direction of rotation can be matched to these requirements with the jumper ①.

Directions of rotation of master and slave drives are identical	Directions of rotation of master and slave drives are opposite
with jumper between X24/9 and X24/10 on slave	without jumper between X24/9 and X24/10 on slave

- ② Evaluation in the Emergency-stop circuit  
③ Power supply via DC link circuit  
④ Bus connection: connecting cable for unit's own power supply and monitoring  
⑤ To central earthing point on power supply module  
⑥ Number as per motor/amplifier combination  
⑦ Slave module component set:  
Current limiting as per master; R1=R2=not used; C1=C2=C4=not used; R7=78k7; C3=9k09; input weighting -064 without potentiometer  
⑧ Use 9-core connecting cable only.

16B-MS/KDS/S102/S104



### 3. Handling the MOD programming module

The plug-in MOD programming module is used to match the drive module to the motor type.

It offers the user the following distinct advantages:

- The drive is put into service without time-consuming optimization and adjustments. This applies to conventional applications where the mechanical coupling to the motor is sufficiently stiff and backlash-free, and the ratio of the motor mass to the external masses referred to the motor shaft is between 1:05 and approximately 1:1.5.
- During servicing the unit can be quickly replaced on site by personnel without special training since, apart from drift compensation, no adjustments and matching are required.
- Repair times can thus be appreciably reduced.
- Prior to commissioning check whether the data on the drive amplifier and motor rating plates correspond to those on the rating plate of the programming module.

See Figs. 17 and 18 for rating plate details.

#### 3.1. Determining the type of servo drive and motor

Construction and circuit diagram are shown in Figs. 21 to 30.

The motor type is matched to the drive amplifier by INDRAMAT in the factory by means of resistors and capacitors soldered onto the programming module:

- peak current limiting: R3, R4
- continuous current limiting: R5, R6
- tacho filter: R1, R2, C1, C2
- speed controller circuit: R7, C3, C4  
(control parameters for dynamic performance)
- current controller circuit: R12, R13, C6  
(for TDM 3, TDM 4, TDM 6, TDM 7 only)

#### 3.2. Input weighting and set-point smoothing (matching to NC)

When ordering, the user of the servo drive specifies the analogue interface input weighting appropriate to his NC.

The input weighting of the three inputs is stated in rpm/V on the rating plate of the MOD programming module (see Fig. 18). The last three digits of the module number determine the input weightings of the set-point inputs.

The following components are factory-fitted on the programming module board for input weighting and set-point smoothing:

On programming modules MOD 1, MOD 3, MOD 5, MOD 13, MOD 17, MOD 19, MOD 21 with fine adjustment:

- differential input E1-E2: R8 and installed wire jumper B1
- summing input E3... R9 and installed wire jumper B2
- summing input E4... R10 and installed wire jumper B3
- set-point smoothing at input E1-E2: C5

On programming modules MOD 2, MOD 4, MOD 6, MOD 14, MOD 18, MOD 20, MOD 22 with potentiometer:

- differential input E1-E2: R8 and trimpot. P1  
(or installed wire jumper B1),
- summing input E3: R9 and trimpot. P2  
(or installed wire link B2),
- summing input E4: R10 and trimpot  
(or installed wire jumper B3).
- set-point smoothing  
at input E1-E2: C5

### 3.3. Rating plates, labels and circuit diagrams

Summary of diagrams relating to the MOD programming module

- Fig. 17 Rating plate of MOD programming module
- Fig. 18 Type code of MOD programming module
- Fig. 19 Rating plate of MAC motor
- Fig. 20 Rating plate of servo drive module
- Fig. 21 Module labels : MOD 1, MOD 2 for TDM 1 drive module
- Fig. 22 Circuit diagram: MOD 1, MOD 2 for TDM 1 drive module
- Fig. 23 Module labels: MOD 5, MOD 6 for TDM 2 drive module
- Fig. 24 Circuit diagram: MOD 5, MOD 6 for TDM 2 drive module
- Fig. 25 Module labels: MOD 13, MOD 14 for TDM 3 drive module and MOD 19, MOD 20 for TDM 6
- Fig. 26 Circuit diagram: MOD 13, MOD 14 for TDM 3 drive module and MOD 19, MOD 20 for TDM 6
- Fig. 27 Module labels: MOD 17, MOD 18 for TDM 4 drive module and MOD 21, MOD 22 for TDM 7
- Fig. 28 Circuit diagram: MOD 17, MOD 18 for TDM 4 drive module and MOD 21, MOD 22 for TDM 7
- Fig. 29 Module labels: MOD 3, MOD 4 for KDS 1 drive module

Programming module  
rating plate

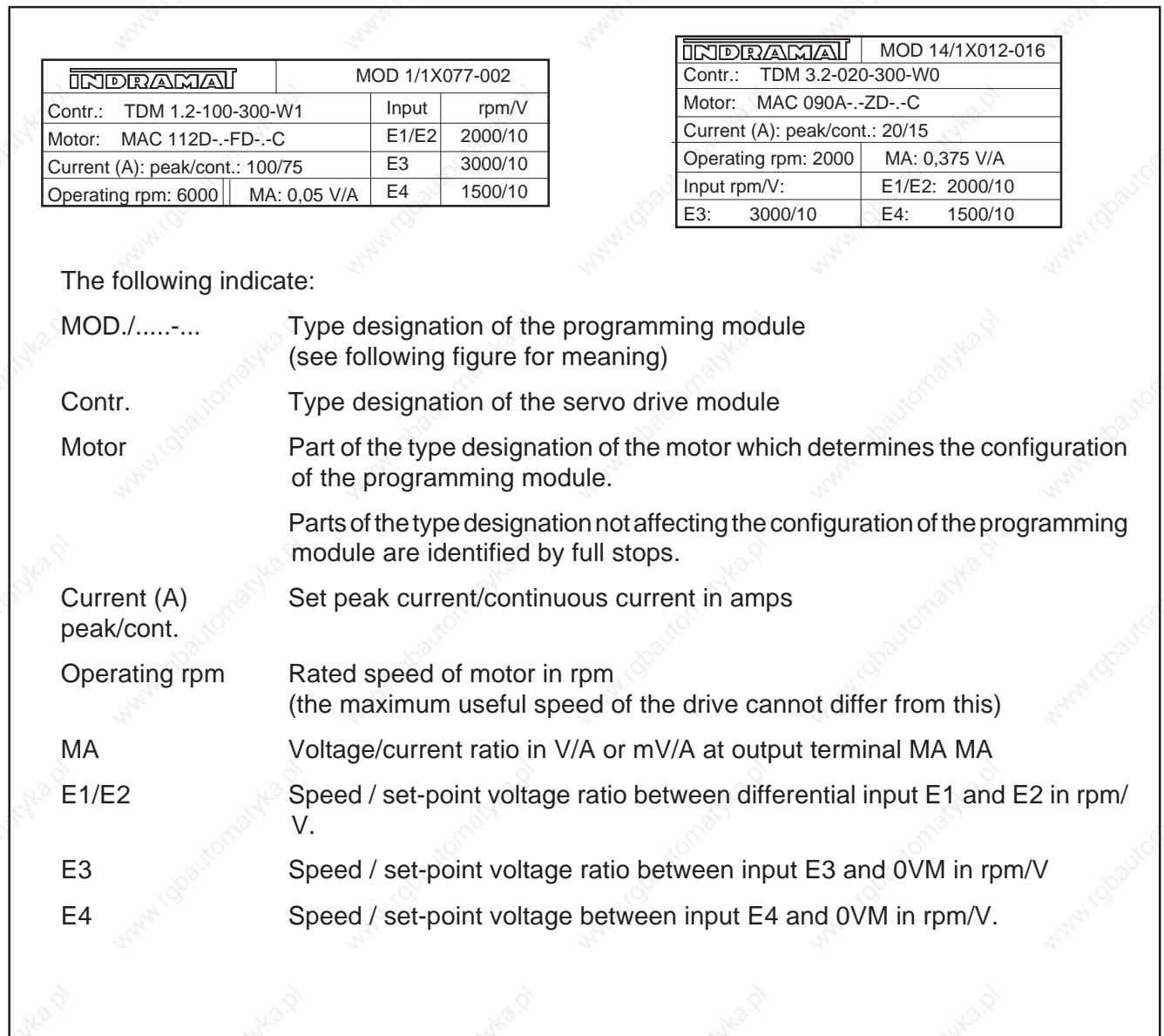

Fig. 17: Rating plate of MOD programming module

### 3. Handling the MOD programming module

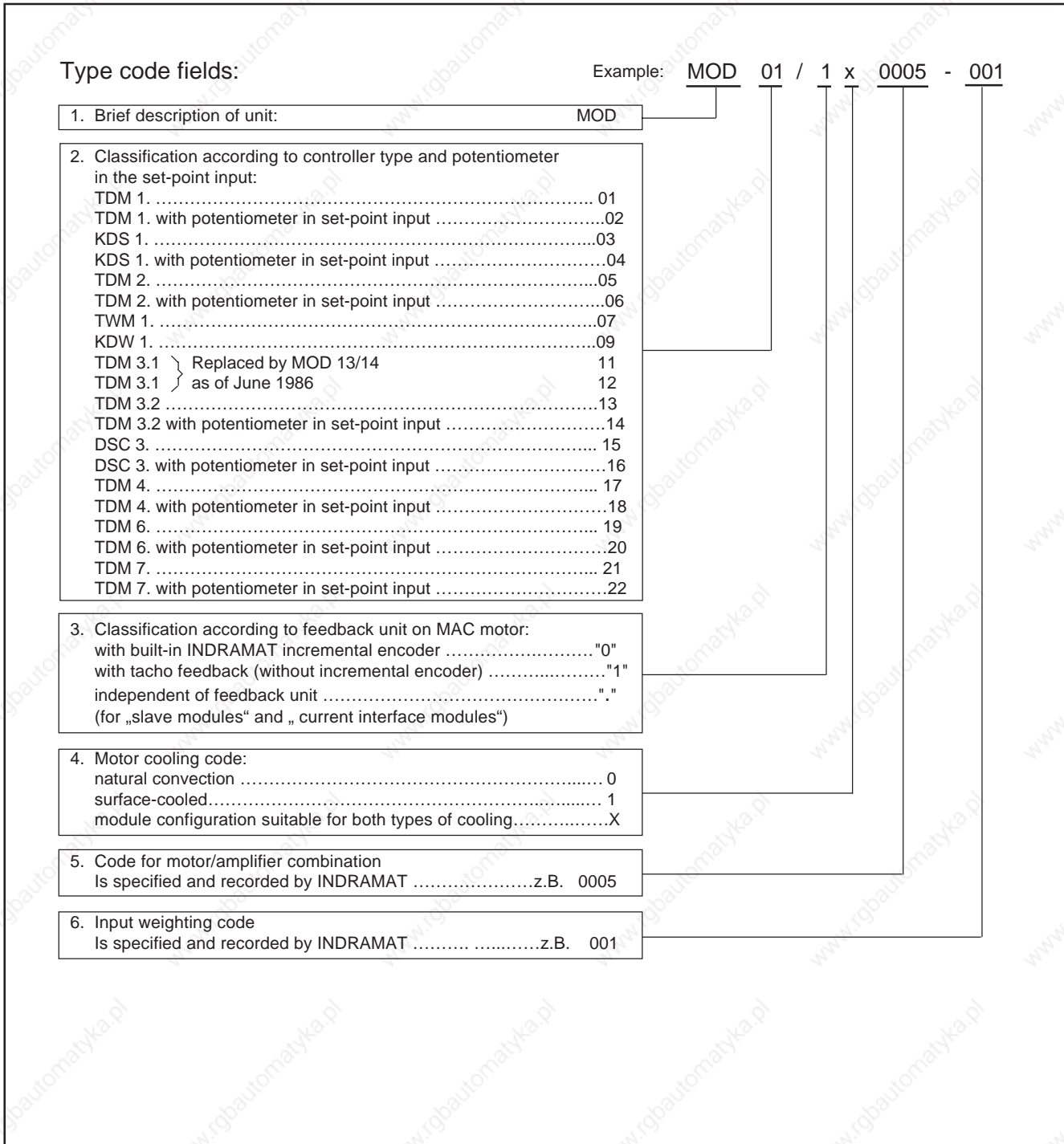



Fig. 18: Type designation of MOD programming module



<b>INDRAMAT</b> GmbH Lohr / Main	<b>Permanentmagnet-Drehstromservomotor</b>	37 89
MAC: 112B-0-PD-2-C/130-A-0/SO5		
Serien Nr.: 38449	R1	Kom.-Nr. 5011 25
Dauer-Md 18.2	① Nm	Md Konst. 0.91 Nm/A
Dauerstrom 21.0	① A	Spitzenstrom 97 A
Motor-EMK	VS/rad	Isolationsklasse F
n <sub>max</sub> 1500	min <sup>-1</sup>	Schutzart IP 65 IP 24 ①
Tacho-EMK	0.0286	VS/rad
Bremse: Md 14 Nm	U <sub>N</sub> 24 V	I <sub>N</sub> 0.75A

① oberflächenbelüftet      ENA3A-TypsSchMAC

From delivery date March 1993

<b>INDRAMAT</b> Permanentmagnet-Motor			
<b>MAC090C-0-WS-4-C/110-A-1/WI520LV/S016</b>			
Part. No. 123456	Build Week 44/91	Com.No. 00123456	
S. No. MAC090- 123456			
			
Made in Germany	natural convection	surface cooled	I.Cl. F IP 65
	MdN 10.4 Nm	MdN 16.0 Nm	n 2000 min <sup>-1</sup>
	IdN 9.5 A	IdN 14.6 A	Km 1.10 Nm/A
	Tacho Const. 3.0 V/1000 min <sup>-1</sup>	m 50 kg	
Brake 14.0 Nm	24 V+-10%	0.75 A	

③ INN 13.05-T1 o      typsSch.tif

The following indicate:

MAC...:	Type designation of servomotor (see Section 13 for details)
Continuous Md; MdN:	Continuous torque of motor in Nm
Continuous current; IdN:	Continuous current of motor in amps
Peak current:	Max. peak current of motor in amps
Motor EMF; km:	Current/torque constant in Nm/A or Vs
Tacho EMF; tacho const:	Tacho voltage in Vs, or V/rpm
nmax;n:	Rated speed of motor in rpm (the maximum useful speed of the drive cannot differ from this)

Fig. 19: Rating plate of MAC motor



<p>TDM 1.2-100-300-W1-0 00 236229                      K13/92</p> <hr/> <p> SN234502-09892      A04</p>	<p>KDS 1.1-050-300-W1-2 20 234601                      K13/92</p> <hr/> <p> SN234547-01690      A02</p>
<p>Serial numbers</p>	

Fig. 20: Rating plate of servo drive module

### 3. Handling the MOD programming module

#### Example of MOD 1 programming module labelling

INDRAMAT		MOD 1/1X077-002	
Contr.: TDM 1.2-100-300-W1	Input	rpm/V	
Motor: MAC 112D-.-FD-.-C	E1/E2	2000/10	
Current (A): peak/cont.: 100/75	E3	3000/10	
Operating rpm: 6000	MA: 0,05 V/A	E4	1500/10

OPERATING PARAMETER: PROGRAMMING MODULE  
 ATTENTION: MOTOR AND CONTROLLER-TYPE INDICATED ON THE MODULE MUST AGREE WITH THE DEVICES IN USE OTHERWISE LACK OF PERFORMANCE AND DANGER OF DAMAGE MAY OCCUR

Betriebsdaten-Programmierungsmodul 

**Achtung:** Motor- und Verstärkertypenangaben müssen mit der Installation übereinstimmen  
 sonst Schädigungsgefahr



#### Example of MOD 2 programming module labelling

INDRAMAT		MOD 2/1X077-016	
Contr.: TDM 1.2-100-300-W1	Input	rpm/V	
Motor: MAC 112D-.-FD-.-C	E1/E2	2000/10	
Current (A): peak/cont.: 100/75	E3	3000/10	
Operating rpm: 6000	MA: 0,05 V/A	E4	1500/10

OPERATING PARAMETER: PROGRAMMING MODULE  
 ATTENTION: MOTOR AND CONTROLLER-TYPE INDICATED ON THE MODULE MUST AGREE WITH THE DEVICES IN USE OTHERWISE LACK OF PERFORMANCE AND DANGER OF DAMAGE MAY OCCUR

Betriebsdaten-Programmierungsmodul 

**Achtung:** Motor- und Verstärkertypenangaben müssen mit der Installation übereinstimmen  
 sonst Schädigungsgefahr

 P1 (E1/E2)     P2 (E3)     P3 (E4)

#### MOD 1 and MOD 2 programming module board layouts

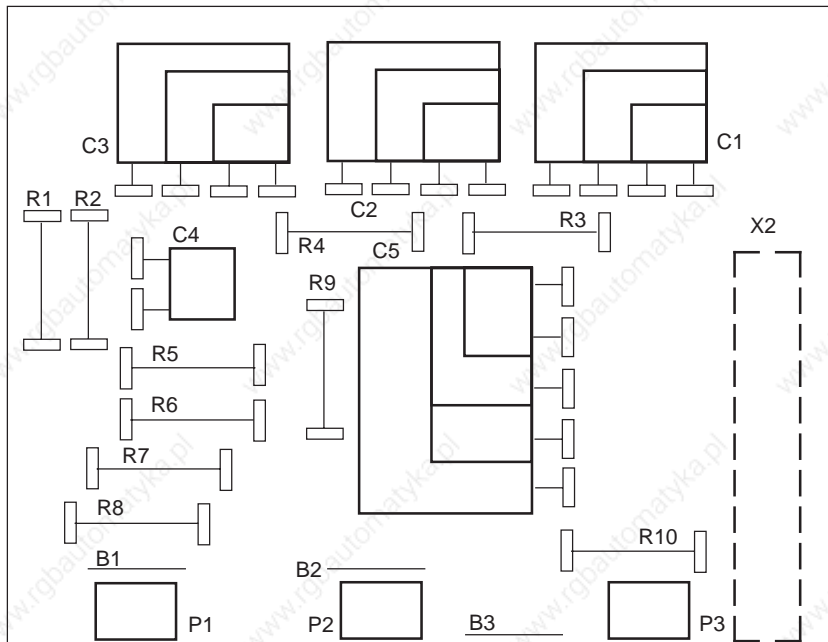

Fig. 21: Module labels: MOD 1, MOD 2 for TDM 1 drive module

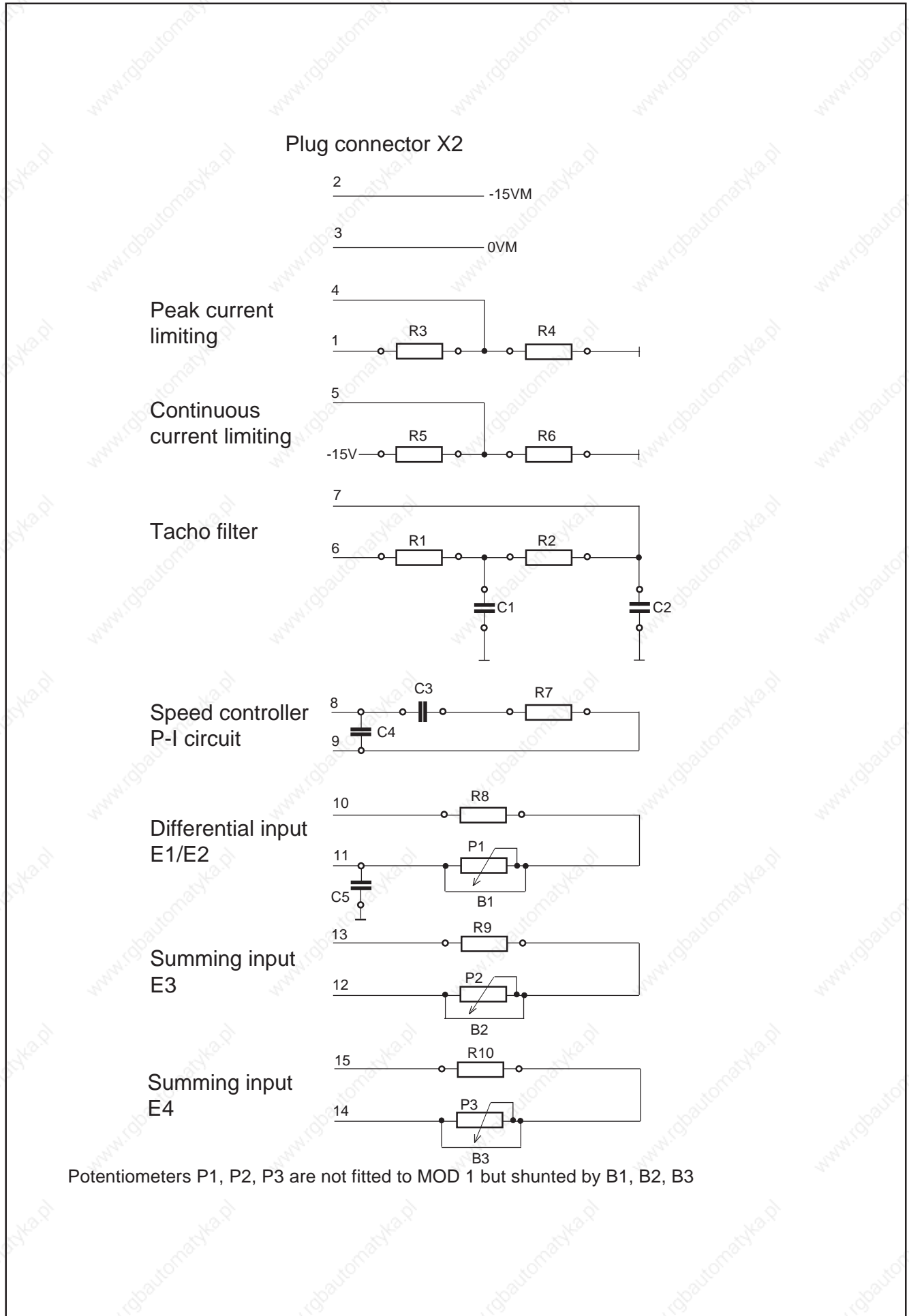

Fig. 22: Circuit diagram: MOD 1, MOD 2 for TDM 1 drive module

### 3. Handling the MOD programming module

#### Example of MOD 5 programming module labelling

INDRAMAT		MOD 5/1X026-185	
Contr.: TDM 2.1-30-300-W0	Input	rpm/V	
Motor: MAC 063D-.-RS-.-C	E1/E2	3500/9	
Current (A): peak/cont.: 17/7	E3	3000/10	
Operating rpm: 6000	MA: 0,25 V/A	E4	1500/10

OPERATING PARAMETER: PROGRAMMING MODULE  
**ATTENTION:** MOTOR AND CONTROLLER-TYPE INDICATED ON THE MODULE MUST AGREE WITH THE DEVICES IN USE OTHERWISE LACK OF PERFORMANCE AND DANGER OF DAMAGE MAY OCCUR

Betriebsdaten-Programmierungsmodul  
**Achtung:** Motor- und Verstärkertypenangaben müssen mit der Installation übereinstimmen  
 sonst Schädigungsgefahr







#### Example of MOD 6 programming module labelling

INDRAMAT		MOD 6/1X026-031	
Contr.: TDM 2.1-30-300-W0	Input	rpm/V	
Motor: MAC 063A-.-RS-.-C	E1/E2	3500/9	
Current (A): peak/cont.: 17/7	E3	3000/10	
Operating rpm: 6000	MA: 0,25 V/A	E4	1500/10

OPERATING PARAMETER: PROGRAMMING MODULE  
**ATTENTION:** MOTOR AND CONTROLLER-TYPE INDICATED ON THE MODULE MUST AGREE WITH THE DEVICES IN USE OTHERWISE LACK OF PERFORMANCE AND DANGER OF DAMAGE MAY OCCUR

Betriebsdaten-Programmierungsmodul  
**Achtung:** Motor- und Verstärkertypenangaben müssen mit der Installation übereinstimmen  
 sonst Schädigungsgefahr



 P1 (E1/E2)    
  P2 (E3)    
  P3 (E4)

#### MOD 5 and MOD 6 programming module board layouts

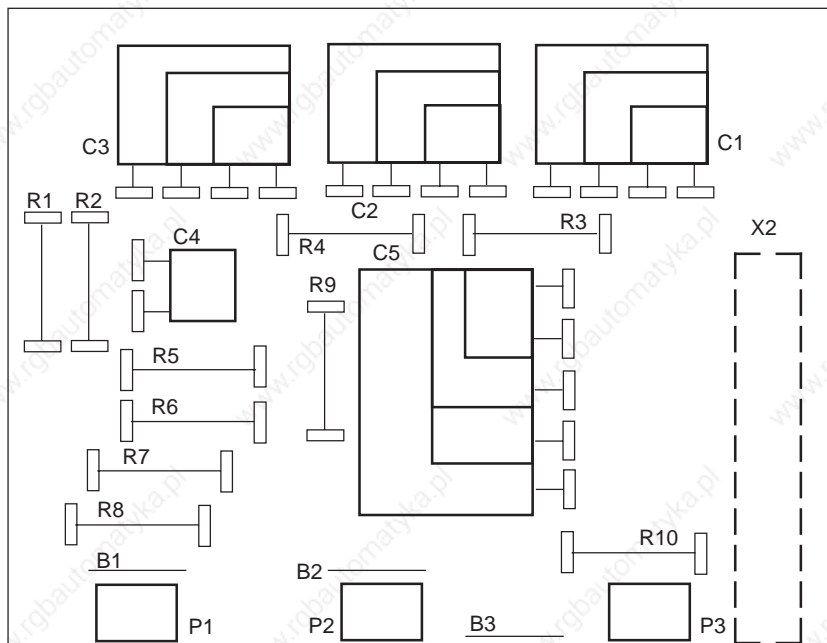

Fig. 23: Module labels: MOD 5, MOD 6 for TDM 2 drive module

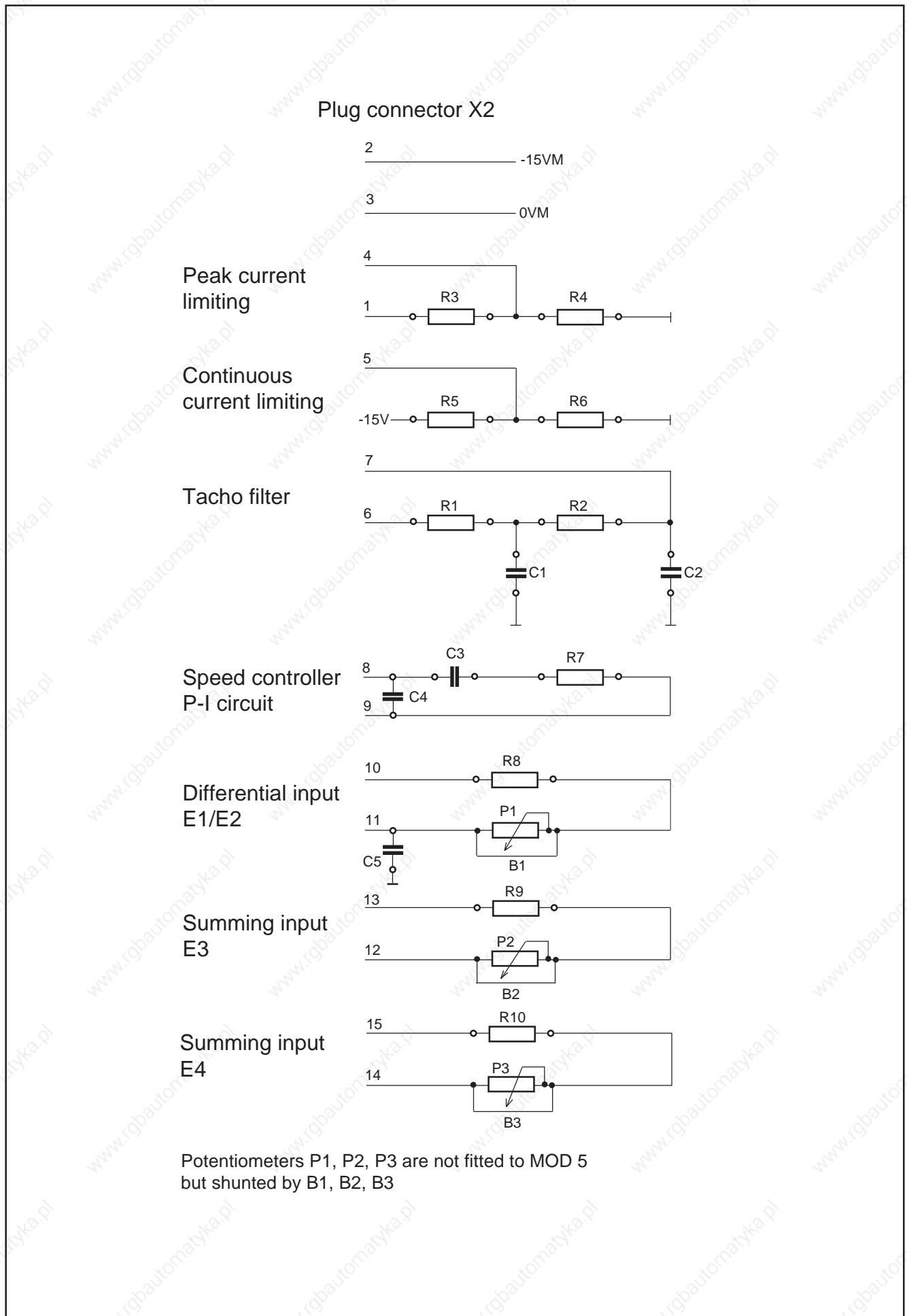

Fig. 24: Circuit diagram: MOD 5, MOD 6 for TDM 2 drive module

### 3. Handling the MOD programming module

#### Example of MOD 13 programming module labelling

<b>INDRAMAT</b>	MOD 13/1X012-002
Contr.: TDM 3.2-020-300-W0	
Motor: MAC 090A--ZD--C	
Current (A): peak/cont.: 20/15	
Operating rpm: 2000	MA: 0,375 V/A
Input rpm/V:	E1/E2: 2000/10
E3: 3000/10	E4:
1500/10	

+

OPERATING PARAMETER-PROGRAMMING MODULE  
ATTENTION: MOTOR AND CONTROLLER-TYPE INDICATED ON THE MODULE MUST AGREE WITH THE DEVICES IN USE. OTHERWISE LACK OF PERFORMANCE AND DANGER OF DAMAGE.

**Betriebsdaten-Programmierungsmodul**  
**Achtung:** Motor- und Verstärkertypenangaben müssen mit der Installation übereinstimmen, sonst Schädigungsgefahr

#### Example of MOD 14 programming module labelling

<b>INDRAMAT</b>	MOD 14/1X012-016
Contr.: TDM 3.2-020-300-W0	
Motor: MAC 090A--ZD--C	
Current (A): peak/cont.: 20/15	
Operating rpm: 2000	MA: 0,375 V/A
Input rpm/V:	E1/E2: 2000/10
E3: 3000/10	E4: 1500/10

+

OPERATING PARAMETER-PROGRAMMING MODULE  
ATTENTION: MOTOR AND CONTROLLER-TYPE INDICATED ON THE MODULE MUST AGREE WITH THE DEVICES IN USE. OTHERWISE LACK OF PERFORMANCE AND DANGER OF DAMAGE.

**Betriebsdaten-Programmierungsmodul**  
**Achtung:** Motor- und Verstärkertypenangaben müssen mit der Installation übereinstimmen, sonst Schädigungsgefahr

  
 P1 P2 P3  
 (E1/E2) (E3) (E4)

#### MOD 13 and MOD 14 programming module board layouts

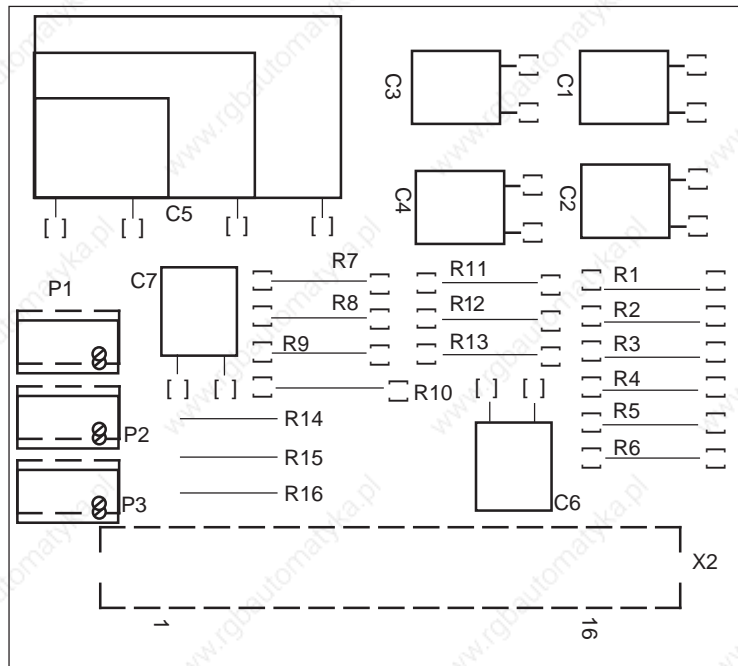

Fig. 25: Module labels: MOD 13, MOD 14 for TDM 3 drive module  
MOD 19, MOD 20 for TDM 6

### 3. Handling the MOD programming module

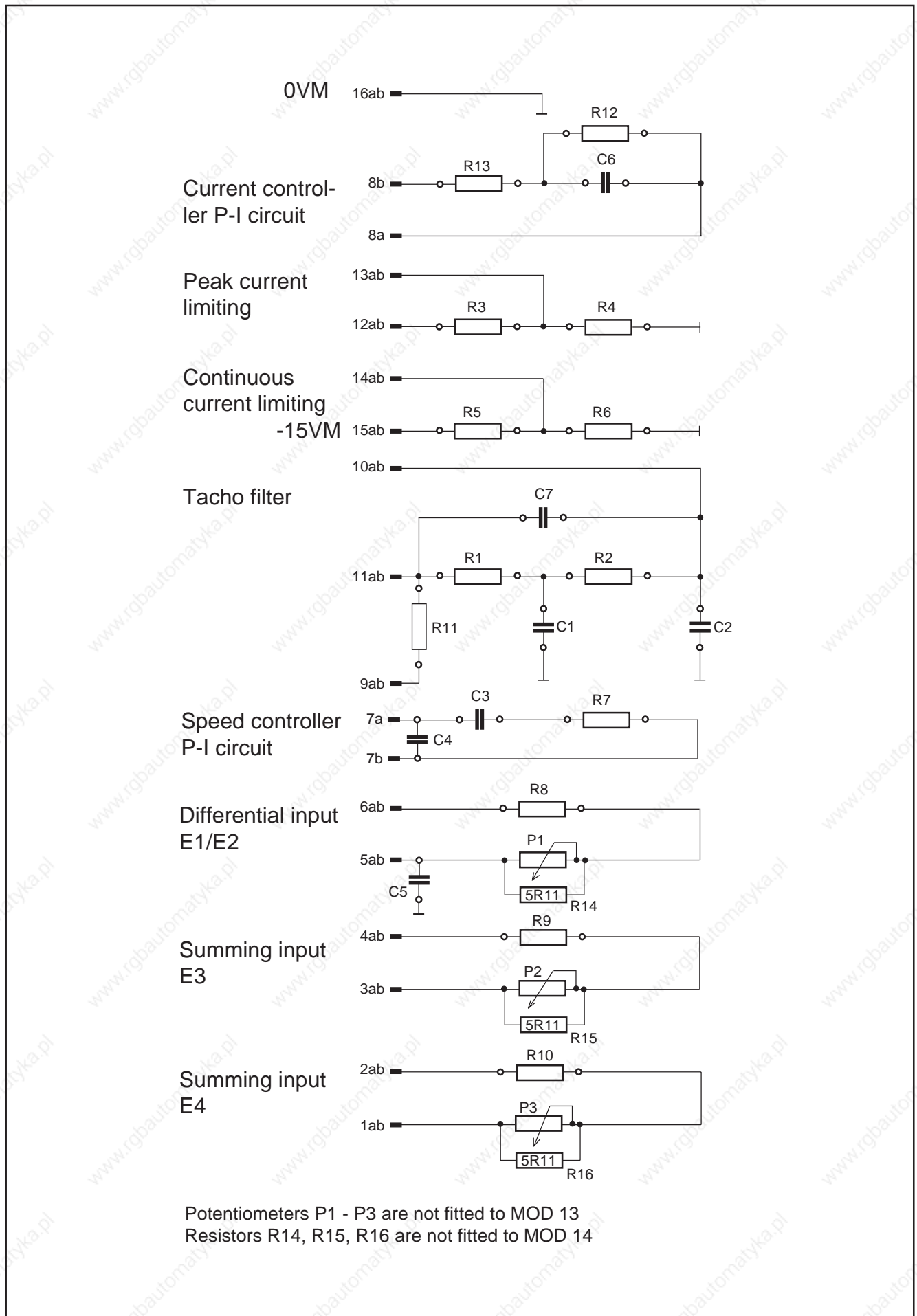

Fig. 26: Circuit diagram: MOD 13, MOD 14 for TDM 3 drive module, MOD 19, MOD 20 for TDM 6

### 3. Handling the MOD programming module

#### Example of MOD 17 programming module labelling

<b>INDRAMAT</b> MOD 17/1X001-193	
Contr.: TDM 4.1-020-300-W0	
Motor: MAC 025C--QS--E	
Current (A): peak/cont.: 14/7	
Operating rpm: 10000 MA: 0,375 V/A	
Input rpm/V:	E1/E2: 10000/10
E3: 10000/10	E4: -----

⊕

OPERATING PARAMETER-PROGRAMMING MODULE  
 ATTENTION: MOTOR AND CONTROLLER-TYPE INDICATED ON THE MODULE MUST AGREE WITH THE DEVICES IN USE. OTHERWISE LACK OF PERFORMANCE AND DANGER OF DAMAGE.

**Betriebsdaten-Programmierungsmodul**  
**Achtung:** Motor- und Verstärkertypenangaben müssen mit der Installation übereinstimmen, sonst Schädigungsgefahr

#### Example of MOD 18 programming module labelling

<b>INDRAMAT</b> MOD 18/1X001-083	
Contr.: TDM 4.1-020-300-W0	
Motor: MAC 025C--QS--E	
Current (A): peak/cont.: 14/7	
Operating rpm: 10000 MA: 0,375 V/A	
Input rpm/V:	E1/E2: 10000/10
E3: 10000/10	E4: -----

⊕

OPERATING PARAMETER-PROGRAMMING MODULE  
 ATTENTION: MOTOR AND CONTROLLER-TYPE INDICATED ON THE MODULE MUST AGREE WITH THE DEVICES IN USE. OTHERWISE LACK OF PERFORMANCE AND DANGER OF DAMAGE.

**Betriebsdaten-Programmierungsmodul**  
**Achtung:** Motor- und Verstärkertypenangaben müssen mit der Installation übereinstimmen, sonst Schädigungsgefahr

⊕ ⊕ ⊕  
 P1 P2 P3  
 (E1/E2) (E3) (E4)

#### MOD 17 and MOD 18 programming module board layouts

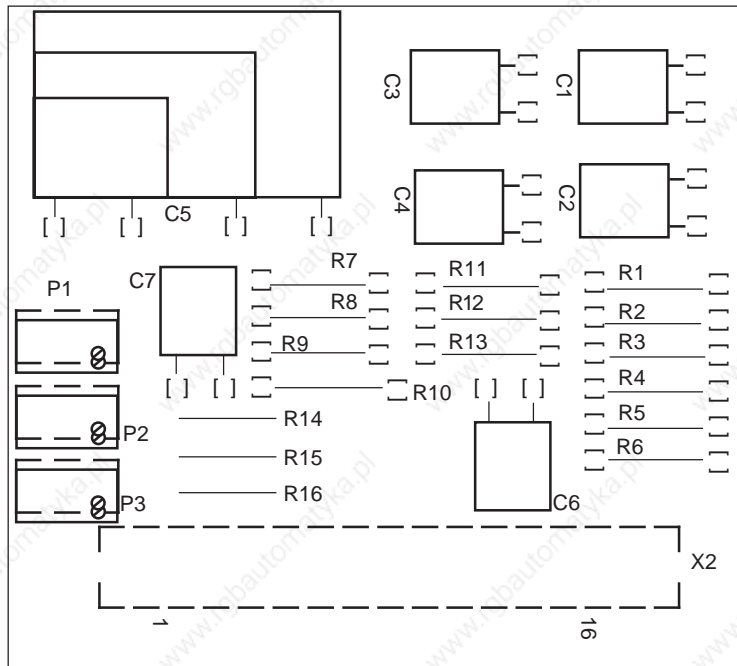

Fig. 27: Module labels: MOD 17, MOD 18 for TDM 4 drive module, MOD 21, MOD 22 for TDM 7



### 3. Handling the MOD programming module

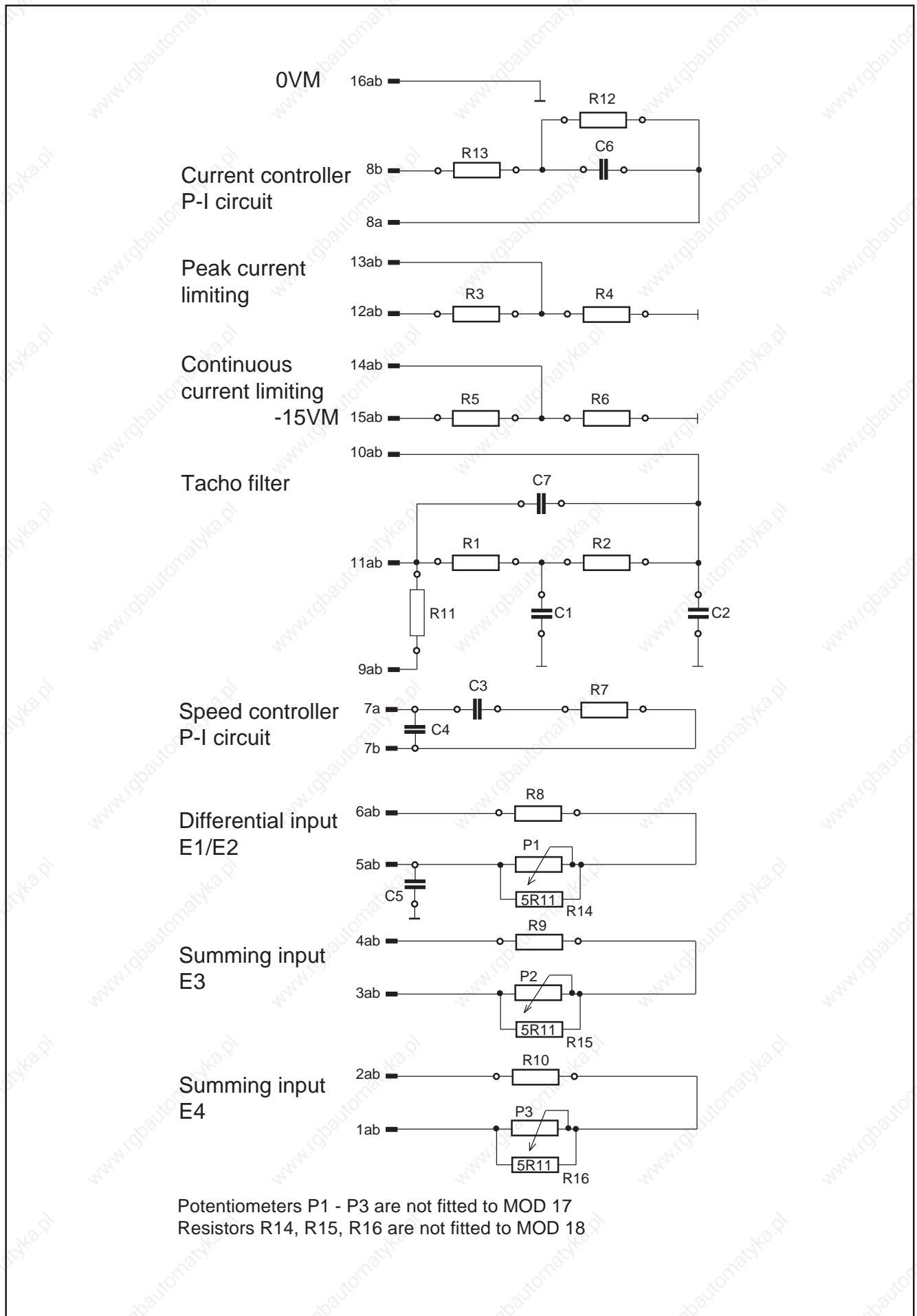

Fig. 28: Circuit diagram: MOD 17, MOD 18 for TDM 4 drive module, MOD 21, MOD 22 for TDM 7

### 3. Handling the MOD programming module

#### Example of MOD 3 programming module labelling

OPERATING PARAMETER: PROGRAMMING MODULE  
 ATTENTION: MOTOR AND CONTROLLER-TYPE INDICATED ON THE MODULE MUST AGREE WITH THE DEVICES IN USE OTHERWISE LACK OF PERFORMANCE AND DANGER OF DAMAGE MAY OCCUR  
 Betriebsdaten-Programmierungsmodul  
**Achtung:** Motor- und Verstärkertypenangaben müssen mit der Installation übereinstimmen sonst Schädigungsgefahr



<b>INDRAMAT</b>		MOD 3/1X022-002	
Contr.: KDS 1.1-150-300-W1	Input	rpm/V	
Motor: MAC 112D-.-FD-.-C	E1/E2	2000/10	
Current (A): peak/cont.: 130/55	E3	3000/10	
Operating rpm: 2000	MA: 0,05 V/A	E4	1500/10

#### Example of MOD 4 programming module labelling

OPERATING PARAMETER: PROGRAMMING MODULE  
 ATTENTION: MOTOR AND CONTROLLER-TYPE INDICATED ON THE MODULE MUST AGREE WITH THE DEVICES IN USE OTHERWISE LACK OF PERFORMANCE AND DANGER OF DAMAGE MAY OCCUR  
 Betriebsdaten-Programmierungsmodul  
**Achtung:** Motor- und Verstärkertypenangaben müssen mit der Installation übereinstimmen sonst Schädigungsgefahr



P1 (E1/E2)    
 P2 (E3)    
 P3 (E4)

<b>INDRAMAT</b>		MOD 4/1X022-016	
Contr.: KDS 1.1-150-300-W1	Input	rpm/V	
Motor: MAC 112D-.-FD-.-C	E1/E2	2000/10	
Current (A): peak/cont.: 130/55	E3	3000/10	
Operating rpm: 2000	MA: 0,05 V/A	E4	1500/10

#### MOD 3 and MOD 4 programming module board layouts

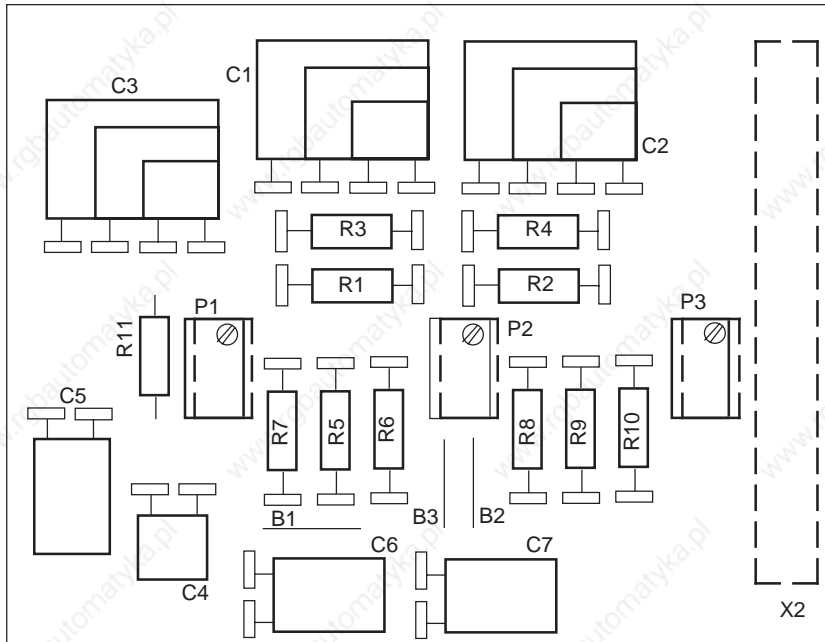

Fig. 29: Module labels: MOD 3, MOD 4 for KDS 1 drive module

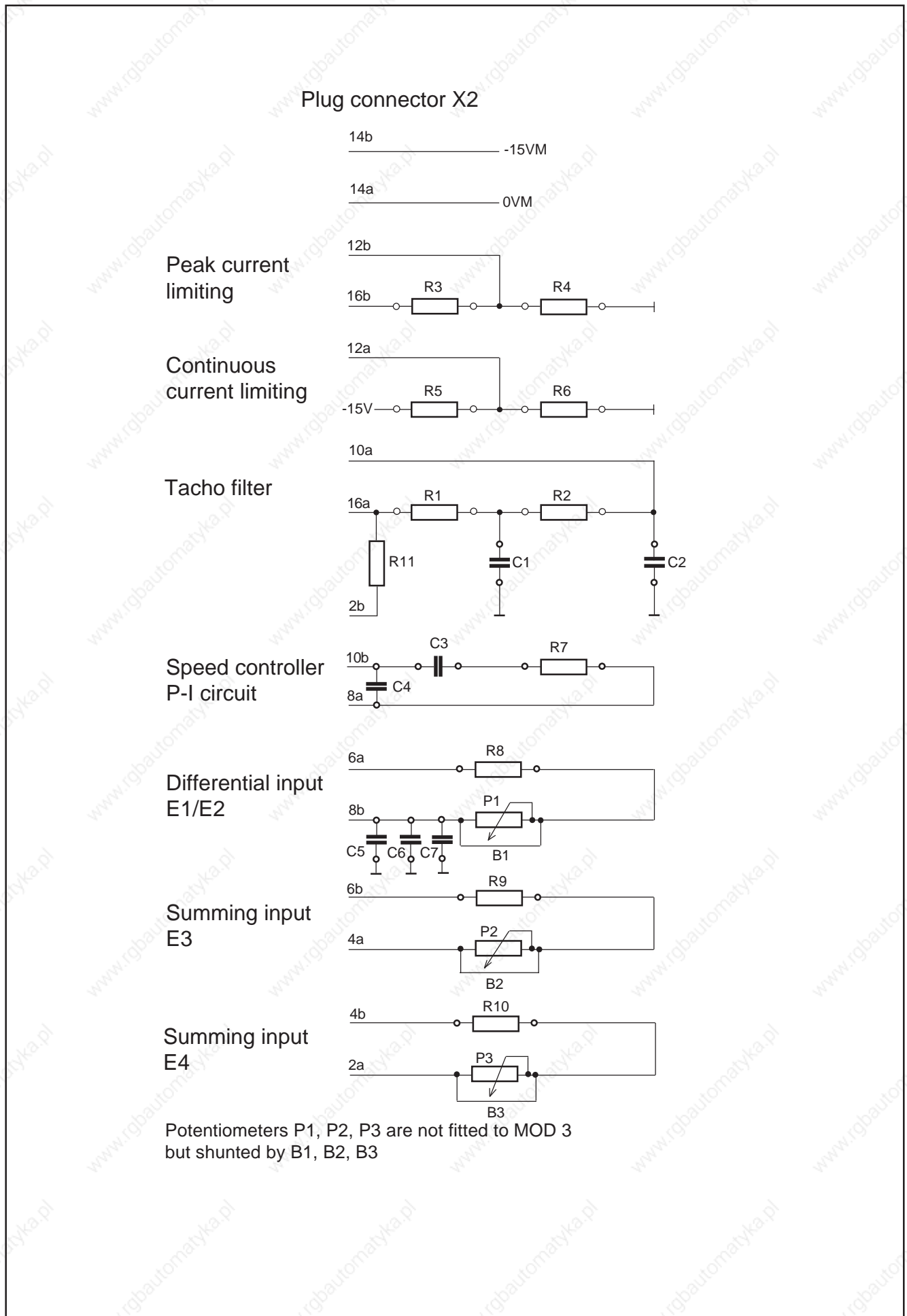

Fig. 30: Circuit diagram: MOD 3, MOD 4 for KDS 1 drive module

## 4. User inputs/outputs

Terminal on servo drive module:				Input	Function	Maximum values of applied DC voltage
TDM 1 TDM 2	TDM 3 TDM 6	TDM 4 TDM 7	KDS1			
X5/1 -X5/2	X42/1 -X42/2	X50/1 -X50/2	X26/1 -X26/2	E1-E2	Differential input for set-point	- 10 to + 10 volts
X5/3	X42/4	X50/4	X26/4	E3	Summing input for set-point with respect to 0VM	- 10 to + 10 volts
X5/4	X42/5	X50/5	X26/5	E4	Summing input for set-point with respect to 0VM	- 10 to + 10 volts
X5/7	X43/3	X49/3	X25/3	RF	Controller enable not active. After controller enabling signal is disconnected only differential input is immediately set to zero internally. The drive still remains under active control for about 300 ms after the controller enabling signal is switched off.	0 to 3 Volt or open input
X5/13	X42/8	X50/8	X26/8	Ired	External torque and current limiting by applying an analogue voltage (see Section 2.3)	3 to 30 volts (0,3 to 3 mA) 0 to 10 volts

Fig. 31: Servo drive module inputs

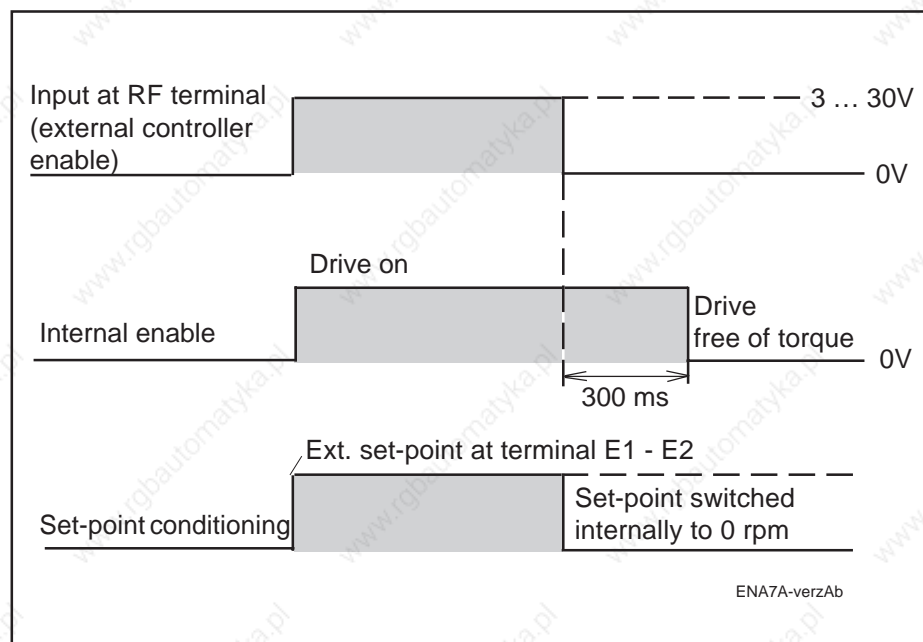

Fig. 32: Delayed disconnection of controller enabling signal

#### 4. User inputs/outputs

Terminal on servo drive module:				Output	Function	Maximum values of DC voltage/current															
TDM 1 TDM 2	TDM 3 TDM 6	TDM 4 TDM 7	KDS1																		
X5/5 -X5/6	X43/1 -X43/2	X49/1 -X49/2	X25/1 -X25/2	Bb - Bb	Signals ready state of drive if contact is closed. Servo drive is OK. (Do not confuse this message with the Bb1 contact of the power supply module)	Relay contact rated for 24 V/1 A max.															
X5/10 X5/12	X43/7 X43/9	X49/6 X49/8	X25/7 X25/9	+ 15 VM - 15 VM	Control voltage for external use	15 mA max.															
X5/11,	X43/8	X49/7	X25/8	0 VM	Reference potential for all inputs/outputs except E1-E2 and Bb-Bb																
X5/14	X42/10	X50/10	X26/10	MA	Master output, torque of current set-point for Measurement of drive performance or as set-point output signal for slave drive in a master/slave drive system (see Section 2.4)	Max. output 0 to 10 V, 1 mA (See footnote (1) for kMA weighting)															
X5/15	X42/13	X50/13	X26/13	Tsense	Speed actual-value (tacho)	Max. output 0 to 10 V (See footnote (2) for weighting)															
—	—	—	X25/10 -X25/11	TÜ-TÜ	Output signals unit is overheating (Temperature pre-warning), if contact is open.	Relay contact rated for 24 V, 1 A max.															
—	X43/10	X49/9	—	TÜ	Output signals unit is overheating (temperature pre-warning) if open-collector output is low resistance at 0 V. Drive package is switched off after 30 seconds.	Weighting values 24V, 100 mA max.															
<p>(1) Weighting kMA of this output MA can be obtained from the rating plate of the programming module under „MA“ in V/A or the table in Section 10.2. The torque can be calculated from this as follows:</p> $M = km * \frac{U(MA)}{kMA} \text{ in Nm}$ <p>km: current torque constant in Nm/A from Section 10.1            U(MA): voltage V measured at MA output</p>																					
<p>(2) The internal resistance of the output is 20 kilohms. The weighting of this output depends on the rated speed of the motor (obtainable from Section 10.1 or rating plate):</p> <table border="1" style="width: 100%; border-collapse: collapse; margin-top: 10px;"> <thead> <tr> <th style="text-align: center;">Max. motor speed in rpm</th> <th style="text-align: center;">Rating plate details (Motor) in Vs/ rad</th> <th style="text-align: center;">Tacho voltage at Tsense output in volts per 1000 rpm</th> </tr> </thead> <tbody> <tr> <td style="text-align: center;">1600</td> <td style="text-align: center;">0,0572</td> <td style="text-align: center;">6</td> </tr> <tr> <td style="text-align: center;">3200</td> <td style="text-align: center;">0.0286</td> <td style="text-align: center;">3</td> </tr> <tr> <td style="text-align: center;">6400</td> <td style="text-align: center;">0.0143</td> <td style="text-align: center;">1.5</td> </tr> <tr> <td style="text-align: center;">12000</td> <td style="text-align: center;">0.00715</td> <td style="text-align: center;">0.75</td> </tr> </tbody> </table>							Max. motor speed in rpm	Rating plate details (Motor) in Vs/ rad	Tacho voltage at Tsense output in volts per 1000 rpm	1600	0,0572	6	3200	0.0286	3	6400	0.0143	1.5	12000	0.00715	0.75
Max. motor speed in rpm	Rating plate details (Motor) in Vs/ rad	Tacho voltage at Tsense output in volts per 1000 rpm																			
1600	0,0572	6																			
3200	0.0286	3																			
6400	0.0143	1.5																			
12000	0.00715	0.75																			

Fig. 33: Servo drive module outputs

## 5. Connections and Installation

### 5.1. Protection of Personnel and Equipment



**The guidelines as listed in Chapter 6.1 on protection of personnel, equipment and machinery when connecting, assembling and testing the drives must be followed.**

### 5.2. Assembly

#### 5.2.1. Preferred arrangement of modular units within the control cabinet

Both the servo drive module and its supply module are flush mounting equipment, as outlined in DIN VDE 0160, Sections 5.5.1.3 and 6.5.1.3. This means that they are intended for mounting in a control cabinet. IP 10 is their protection category.

The control cabinet housing should, in accordance with those safety guidelines valid for this application, guarantee sufficient protection against hazards in areas where the general public has access. (For industrial applications, e.g. see EN 60204/DIN VDE 0113, Section 1.) Only properly trained personnel with proper tools or keys should have access to the interior of the control cabinet.

The modular units should, if possible, be arranged as depicted in Figure 34. The drives with high power and voltages should be located as close as possible to the supply unit.

If the ventilated servo drive modules TDM3 and TDM 4 (type designation TDM 3.2-030-300-**W1**, or TDM 4.1-030-300-**W1**) or TDM 6 and TDM 7 (type designation TDM 6.1-025-300-**W1**, or TDM 7.1-025-300-**W1**)

- are arranged on the left side of the drive packet, or,
- are mounted on the left side at a distance greater than 10 mm from an adjacent module,

then a cooling baffle (INDRAMAT mat. no. 224 869) must be screwed onto the heatsink on the left side of the unit. (Also see the dimensions sheet for the servo-drive module.) Only this arrangement guarantees that the fan will provide sufficient cooling.

The end plug, found in the accessories set of the supply module, is plugged into contact strip X1 located in the unit farthest away from the supply module.

It monitors the line connection X1.

It is also possible to arrange the drive module with supply modules on the right and line up the drive modules on the left.

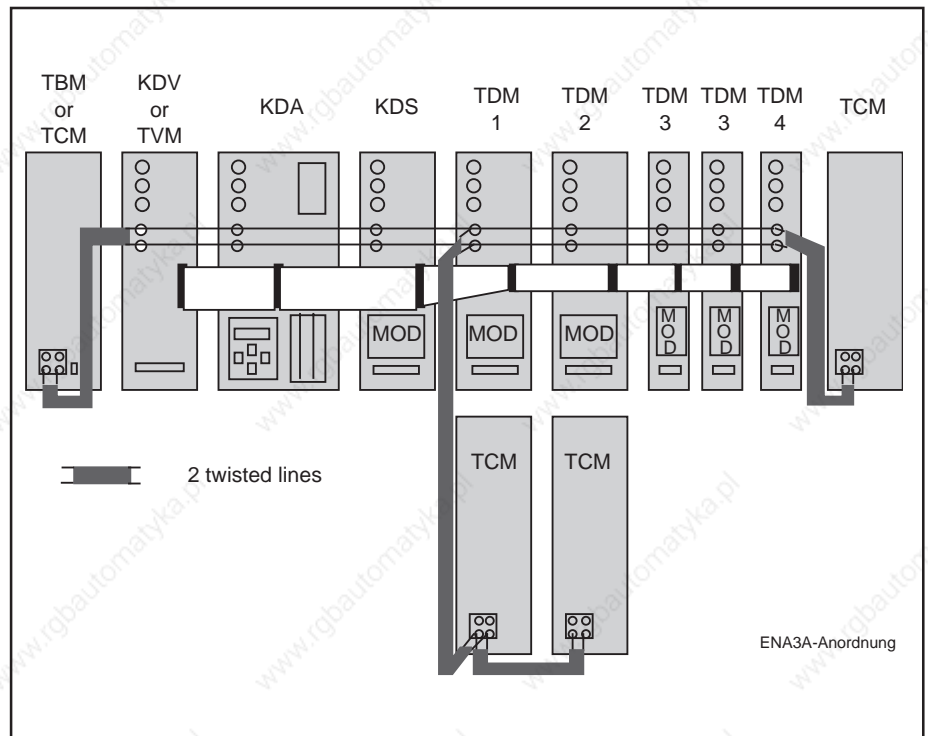

Figure 34: The preferred drive module arrangement

### 5.2.2. Front View with Accessories

Figures 35 through 40 depict a front view of the individual servo drive modules with electrical connecting accessories and programming module MOD.

The components needed for the electrical connections are a part of the „electrical connecting accessories“ supplied by INDRAMAT.

## 5. Connections and Installation

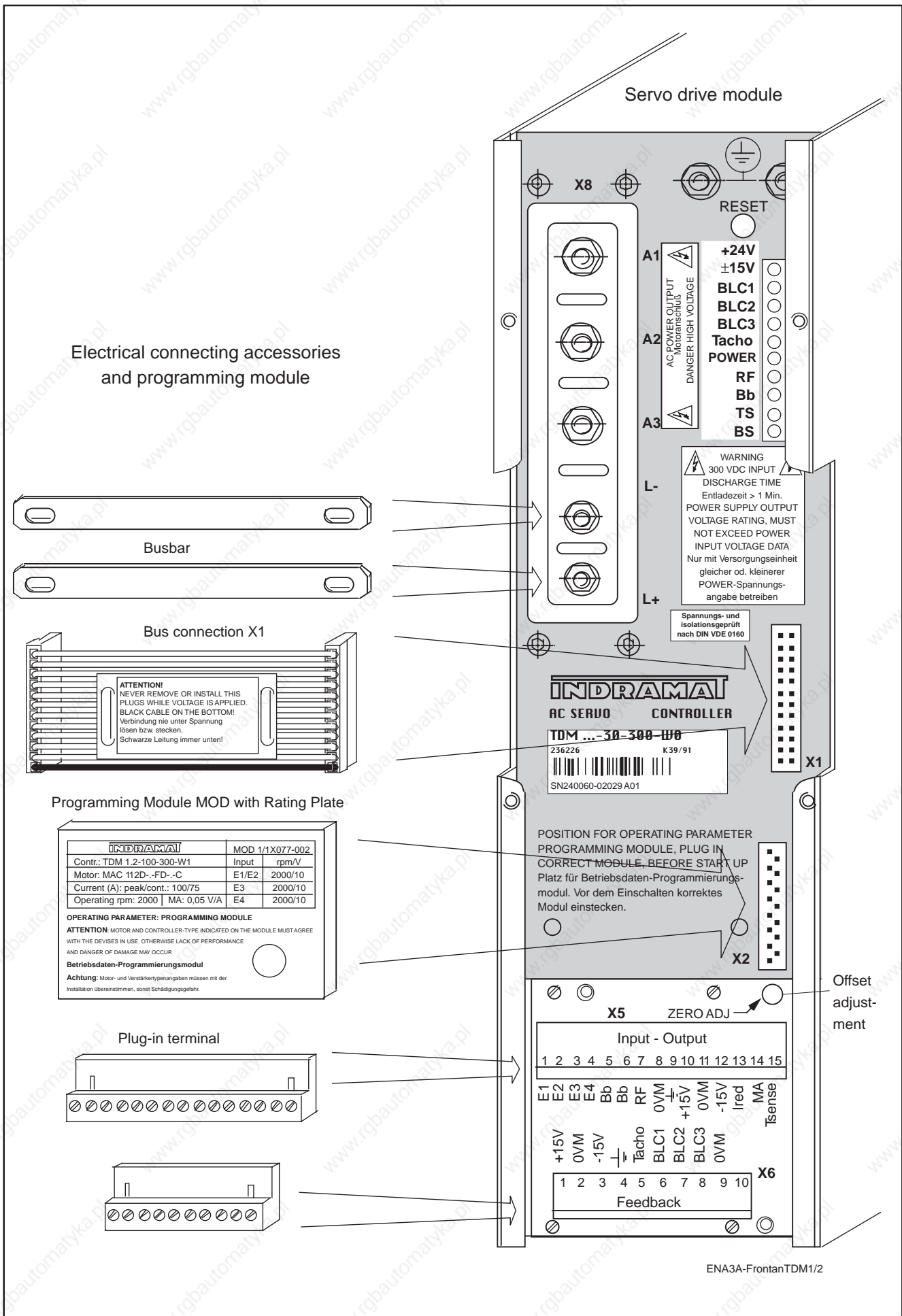

Figure 35: Front view of servo drive modules TDM1 and TDM2 with accessories



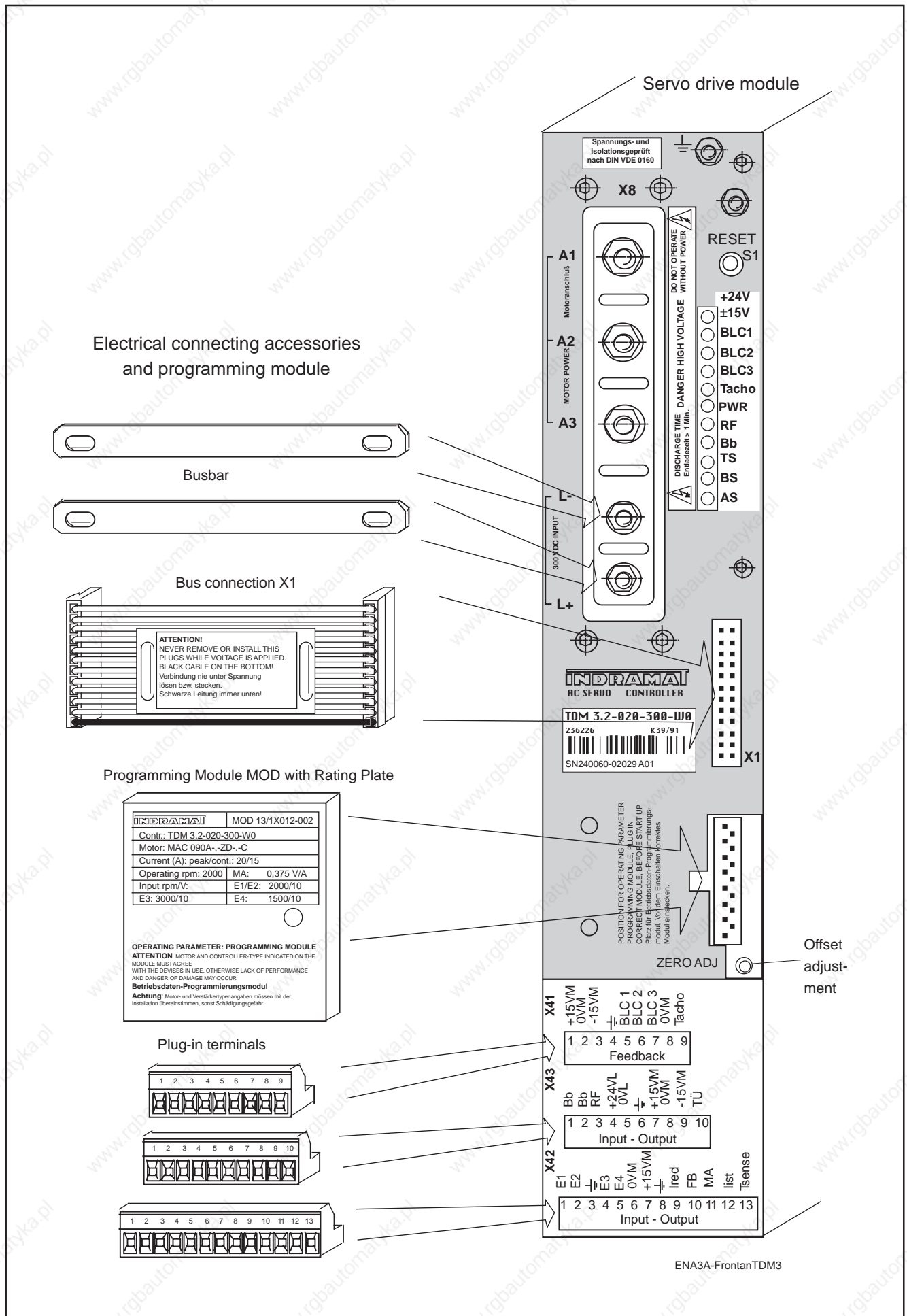

Figure 36: Front view of servo drive module TDM 3 with accessories

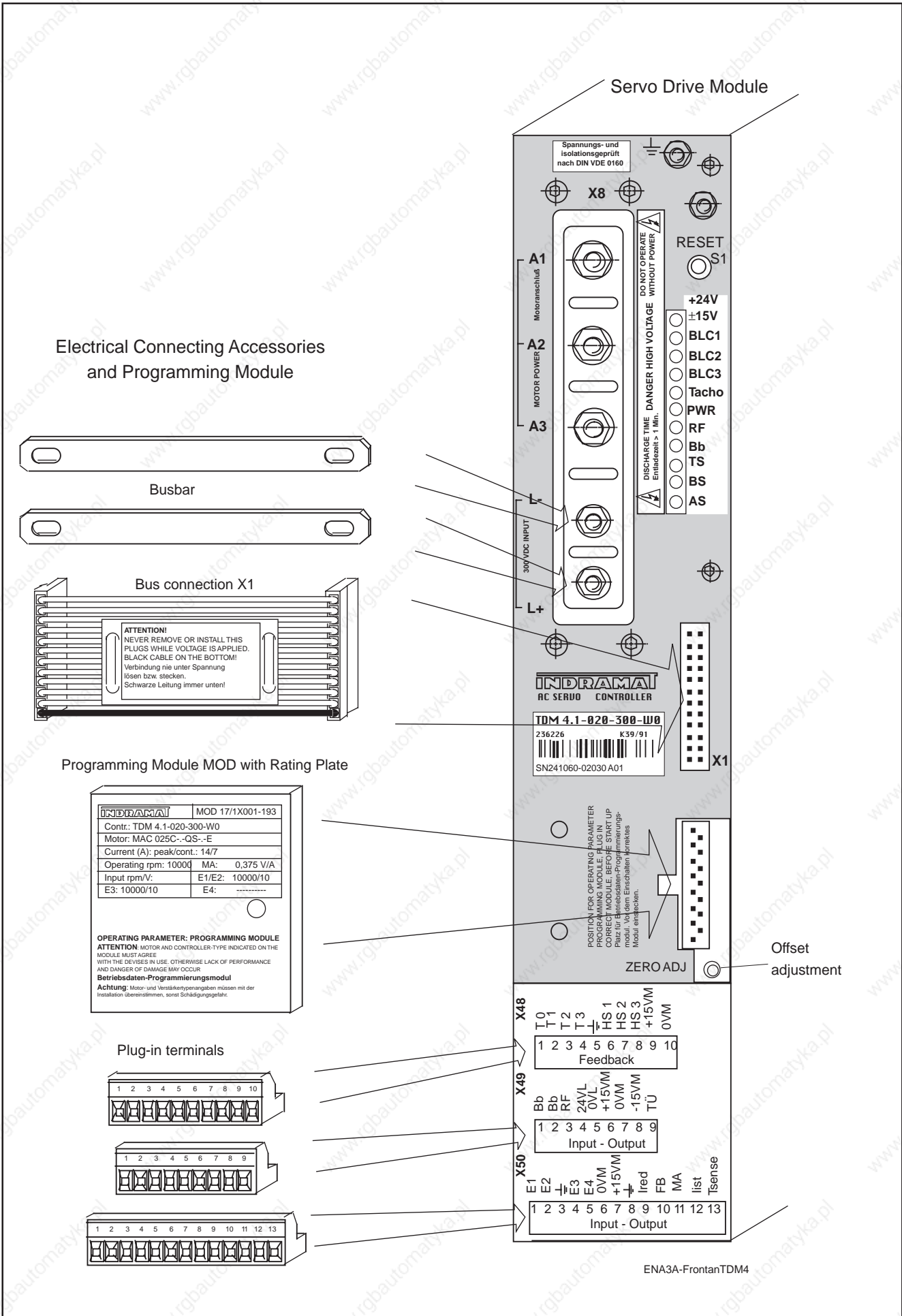

Figure 37: Front view of servo drive module TDM 4 with accessories

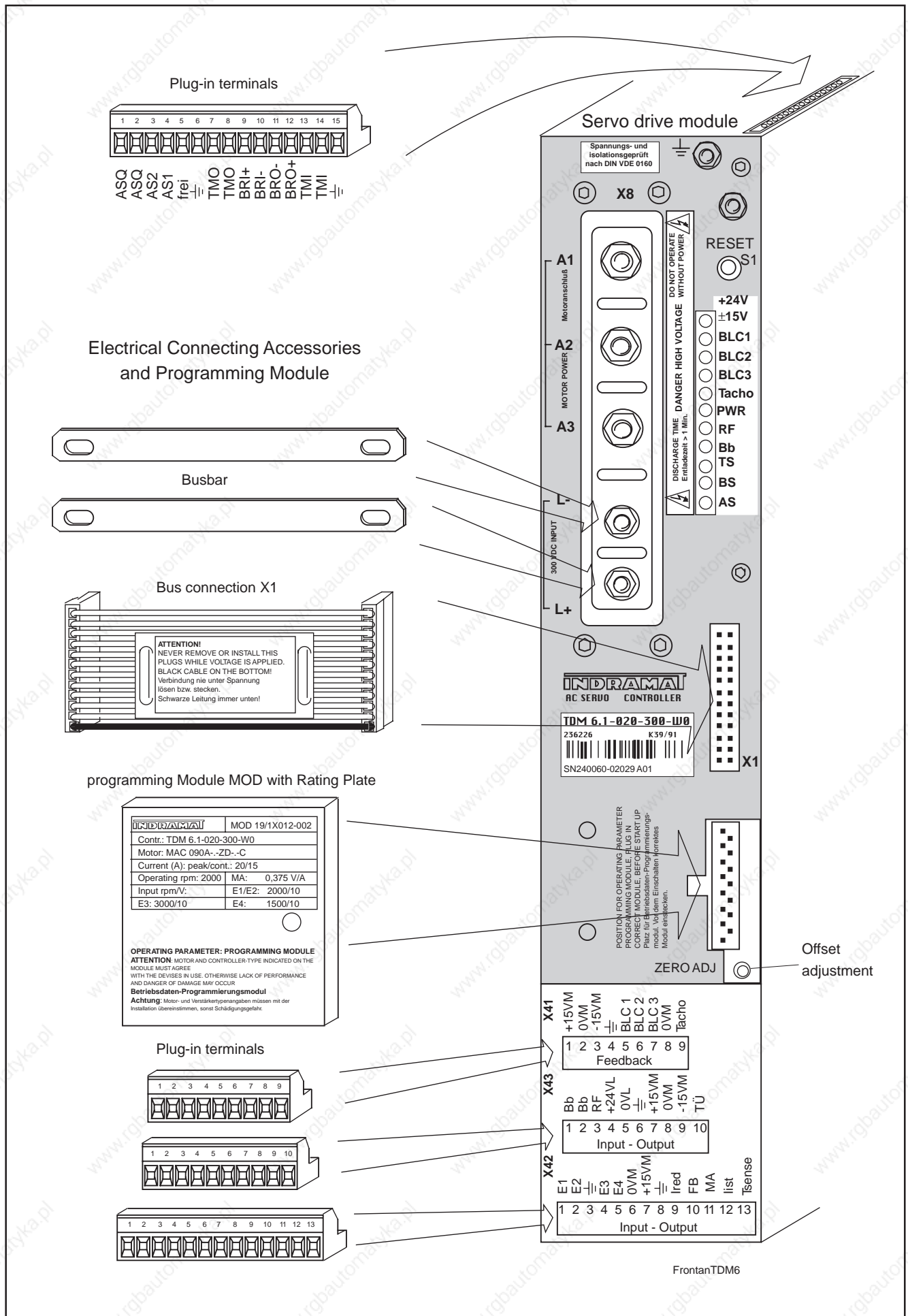

Figure 38: Front view of servo drive module TDM 6 with accessories

## 5. Connections and Installation

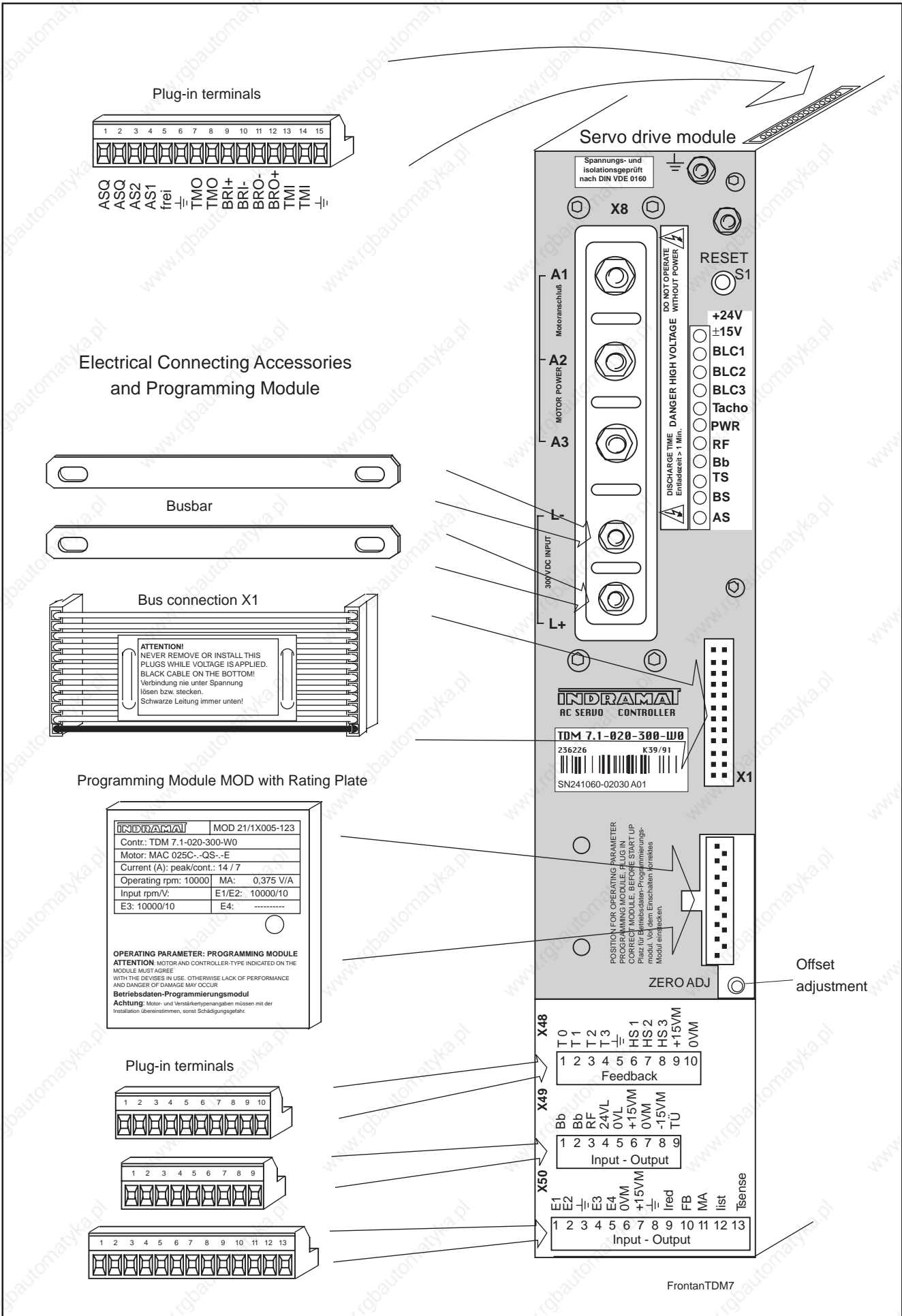

Figure 39: Front view of servo drive module TDM 7 with accessories

## 5. Connections and Installation

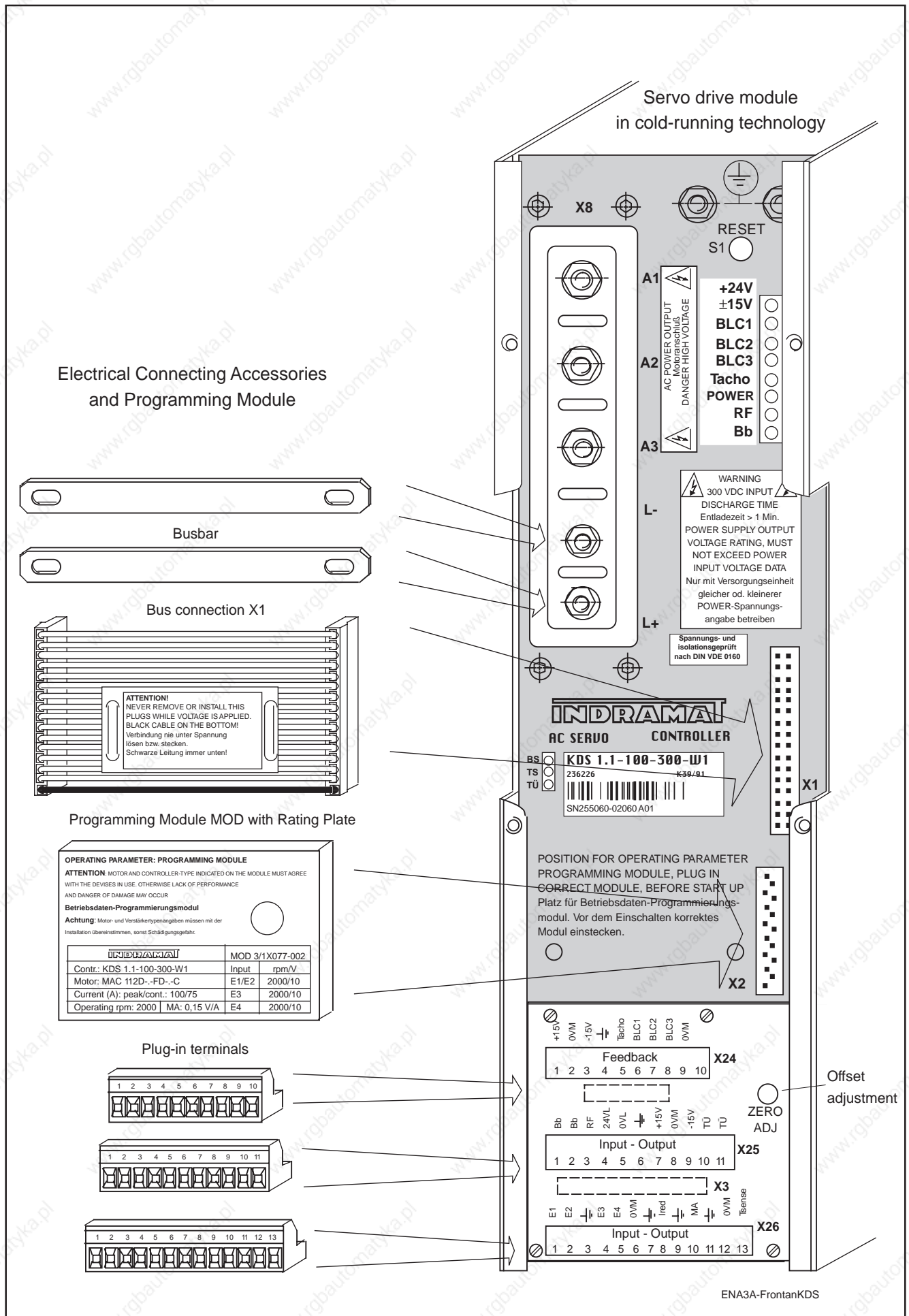

Figure 40: Front view of servo drive module KDS1 with accessories

### 5.2.3. Servo drive module KDS in cold-running technology

Servo drive module KDS in cold-running technology has the advantage that most of the heat loss of the modular units is fed directly out and does not accumulate inside the control cabinet. This is why the cold-running technology version can be built into small cabinets or housing without necessitating the extensive transmission of heat via an expensive heat exchanger.

Ventilation can be forced using an external fan, which can be supplied as an additional set, if power requirements are greater.

The electrical parts of the ventilation are protectively located within the control cabinet, as depicted in Figure 41. The heatsink of the power section and the fan rotor are outside of the control cabinet or housing.

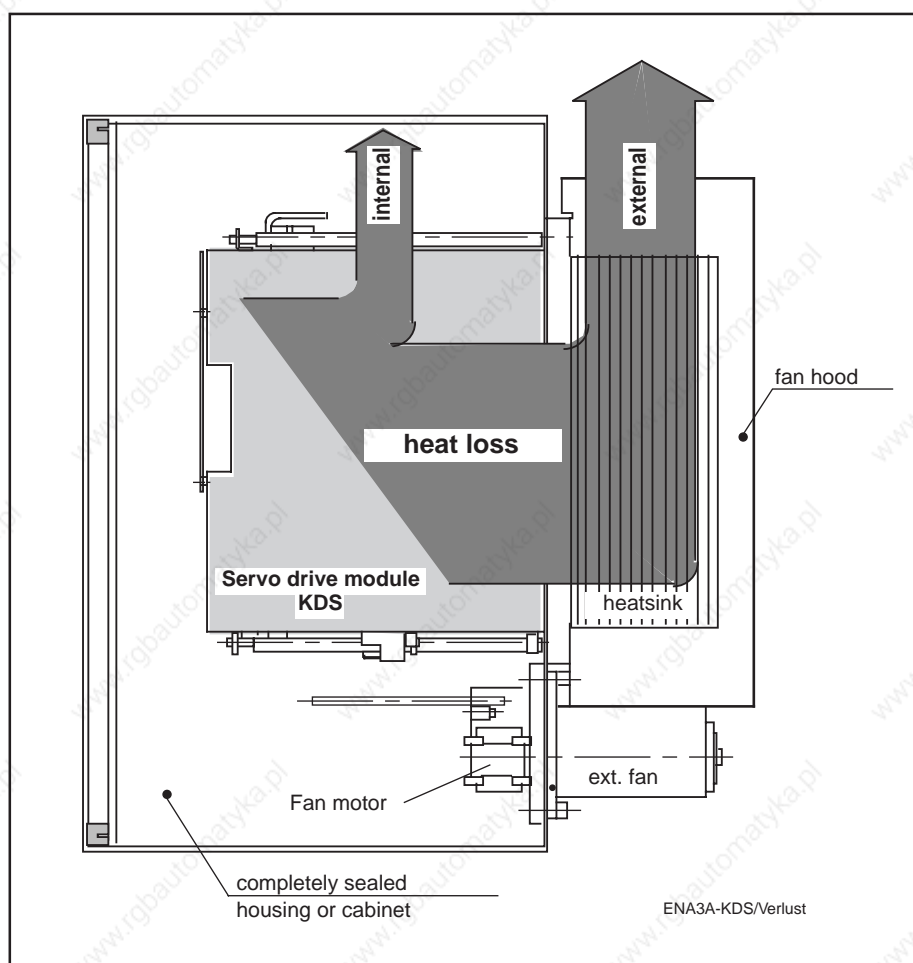

Figure 41: The KDS servo drive module KDS cold module drive in cold-running technology built into control cabinet

The units are mounted by means of a mounting frame in a space on the back wall of the control cabinet in such a way that the drive heatsink with panelling juts out of the control cabinet.

The opening in the control cabinet is tightly sealed with a gasket at the mounting flange of the cold-running version (see mounting drawing, Figure 52, in Chapter 5.2.4). The servo drive module and the external fan are mounted and can be exchanged on the inside of the control cabinet.

#### 5.2.4. Power Reduction for Increased Temperature and Installation Altitude

The data listed on the data sheets and selection lists are valid without restriction, if the servo drive module is operated within an ambient temperature range inside the control cabinet of +5 to +45°C.

Maximum permissible ambient temperature is +55°C.

The values for mean motor current and torque listed in the data sheets are reduced by 2% per degree Celsius or Kelvin of temperature change within the temperature range of +45 ... 55°C.

Maximum mounting altitude is 1000 meters above sea level. The following diagram depicts the reduction in values for mean motor current and torque at higher altitudes:

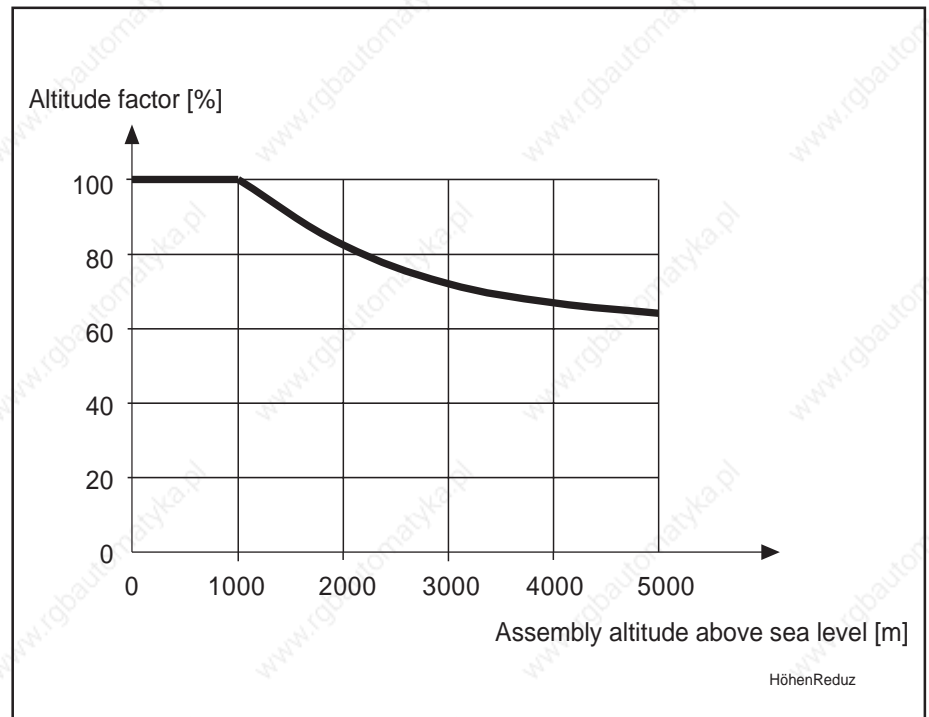

Figure 41a: Altitude-dependent reduction in drive data.

### 5.2.5. Dimensions sheet and mounting dimensions for servo drive modules

The following figures list mounting dimensions and outline the mounting of the servo drive modules:

#### Overview of Dimensions Data

Dimension sheet:	Figure:
Dimension sheet TDM 1, TDM 2	Fig. 42
Mounting dimensions TDM 1, TDM 2	Fig. 43
Dimension sheet TDM 3, TDM 4,	Fig. 44
Dimension sheet TDM 6, TDM 7	Fig. 45
Dimensions for fan attached to modular units	
TDM 3, TDM 4, TDM 6, TDM 7	Fig. 46
Mounting dimensions TDM 3, TDM 4, TDM 6, TDM 7	Fig. 47
Assembly TDM 1, TDM 2, TDM 3, TDM 4,	
TDM 6, TDM 7	Fig. 48
Dimension sheet KDS 1	Fig. 49
Dimensions for available space and arrangement KDS 1	Fig. 50
Mounting dimensions KDS 1	Fig. 51
Assembly KDS 1	Fig. 52

The minimum clearance to adjacent units must be absolutely maintained to guarantee sufficient heat transmission and circulation.

The temperature within the mounting area (interior) of the control cabinet should not exceed 45°C. Forced ventilation, to avoid dammed up heat, as well as a reduction in the max. unit current, by 2.5% / K., become necessary with higher values, up to max. 55°C.

If a cing device is used, then the internal temperature of the control cabinet must be maintained at a minimum of 2 degrees Celsius above external temperatures to prevent bedewing. Bedewing of a printed circuit board can cause drive failure.

Heat-producing built-in parts should not be installed directly underneath the servo drive module.



## 5. Connections and Installation

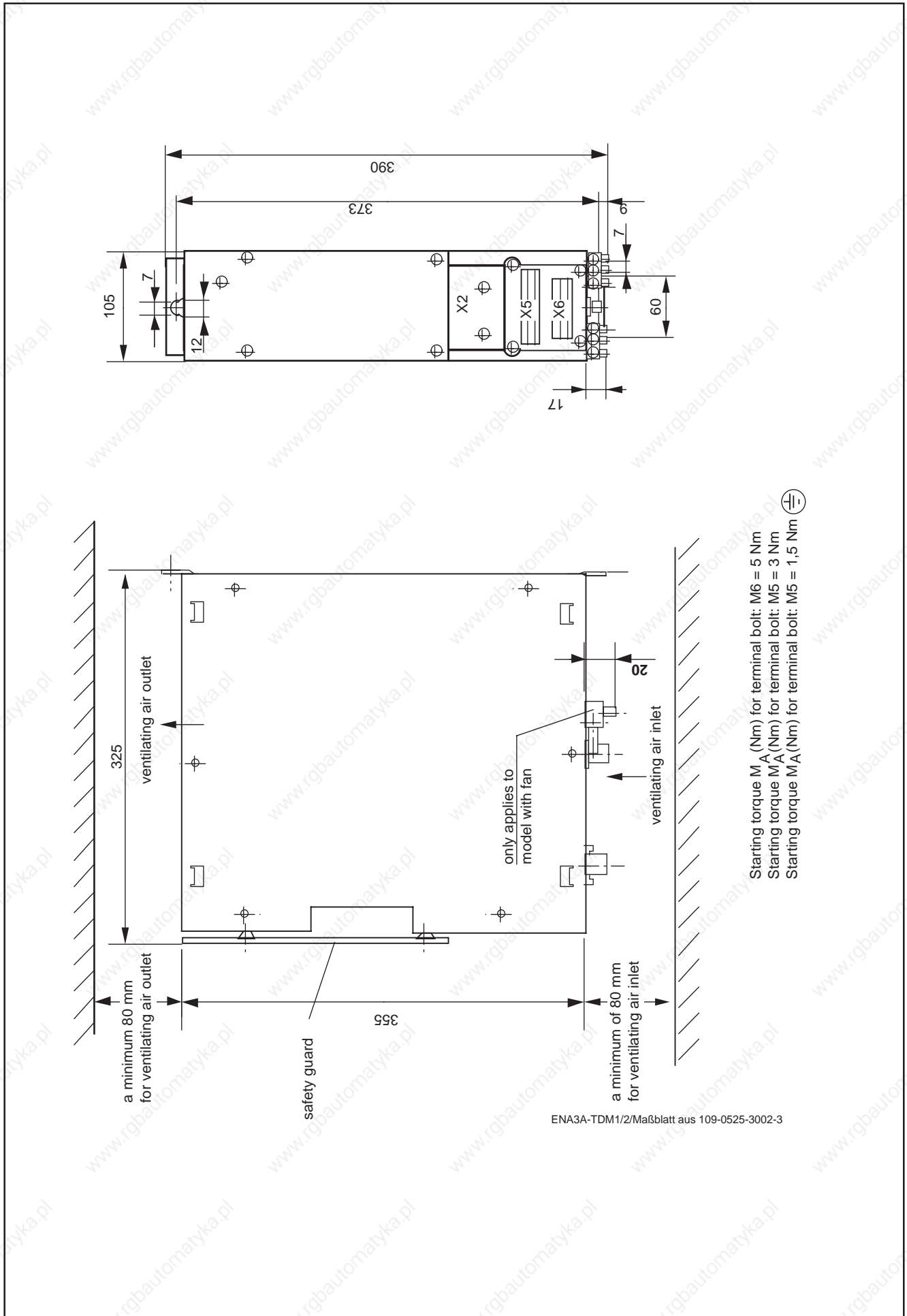

Figure 42: Dimension sheet for TDM 1 and TDM 2

## 5. Connections and Installation

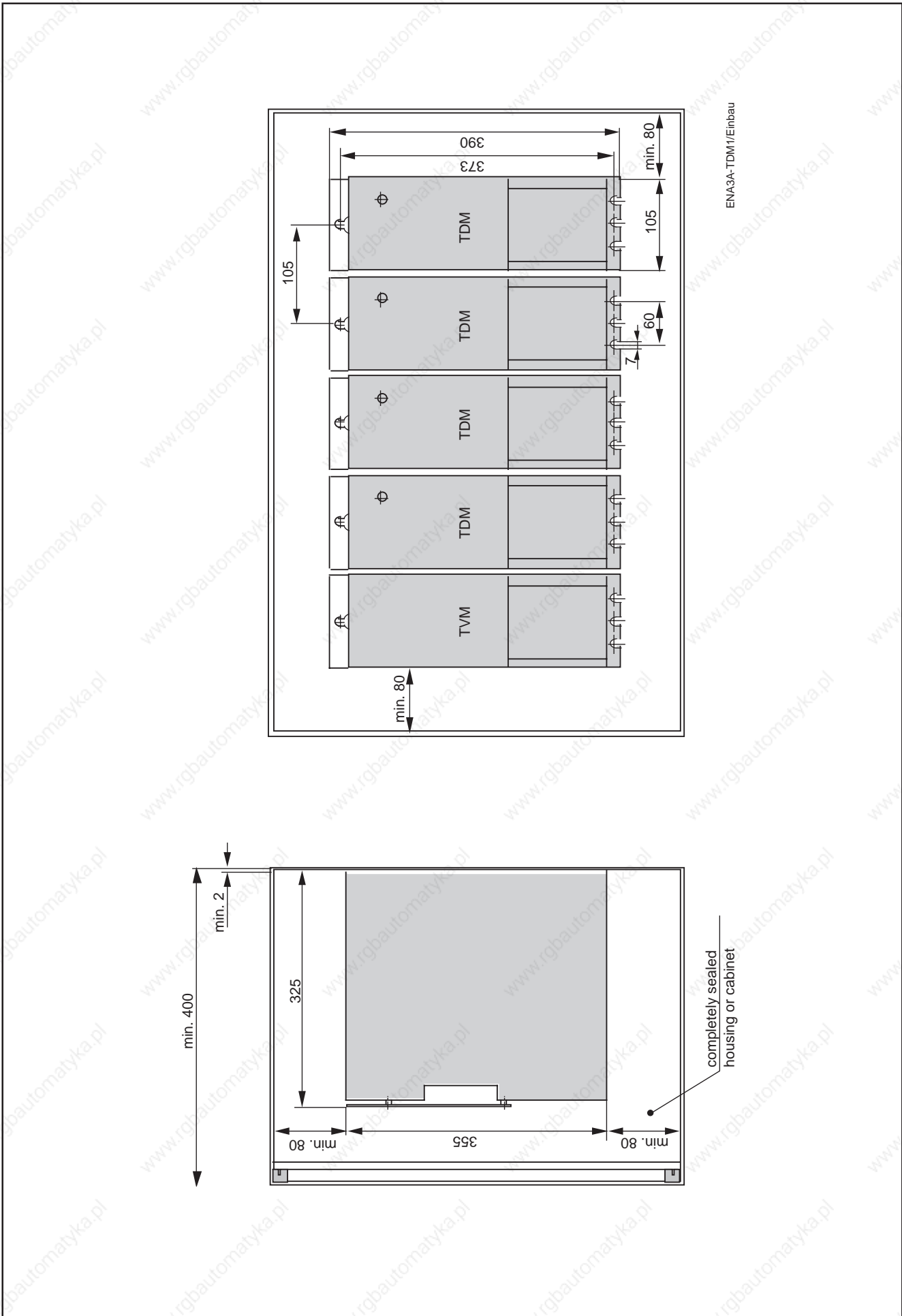

Figure 43: Mounting dimensions for TDM 1 and TDM2

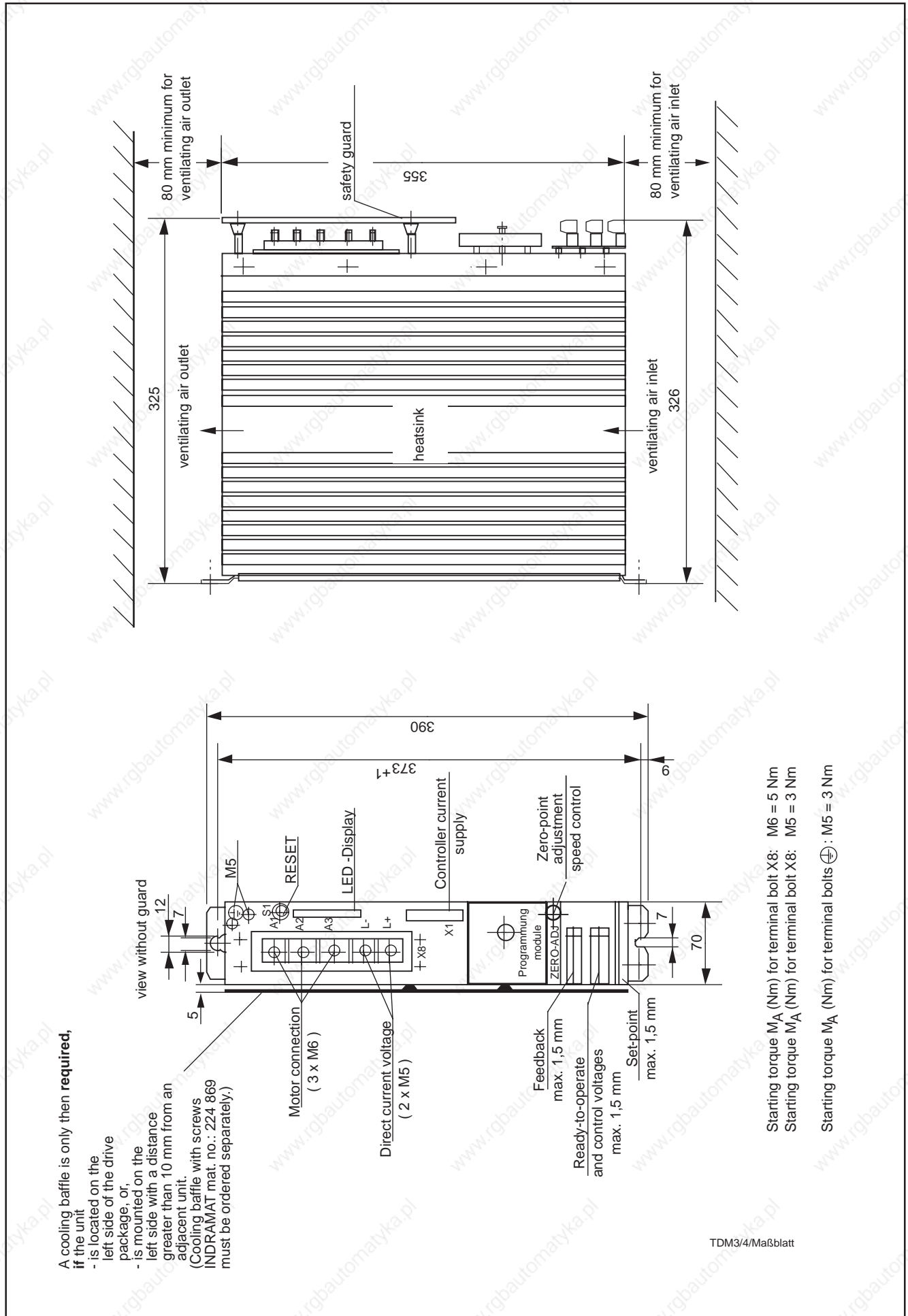
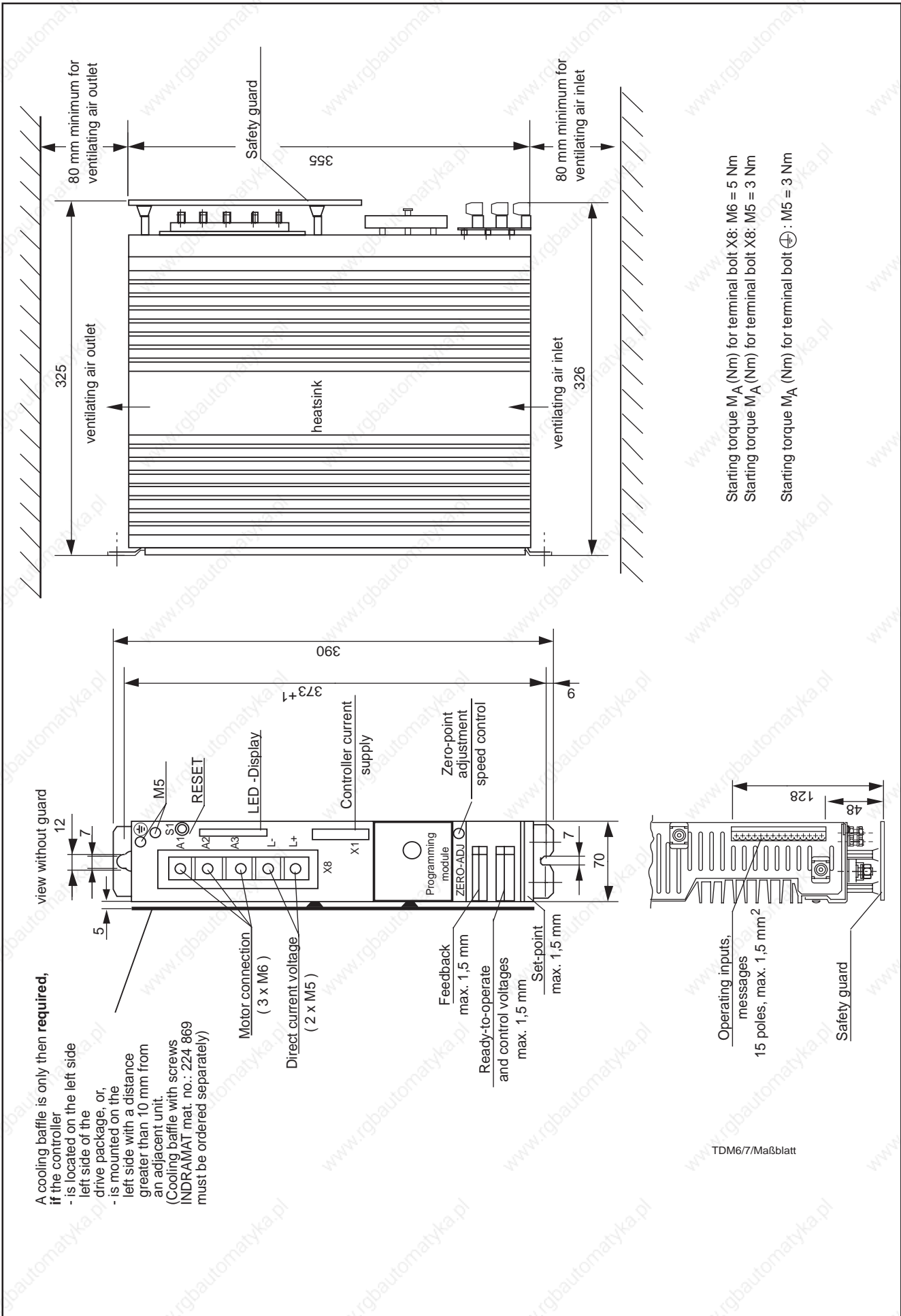

Figure 44: Dimension sheet for TDM 3 and TDM4



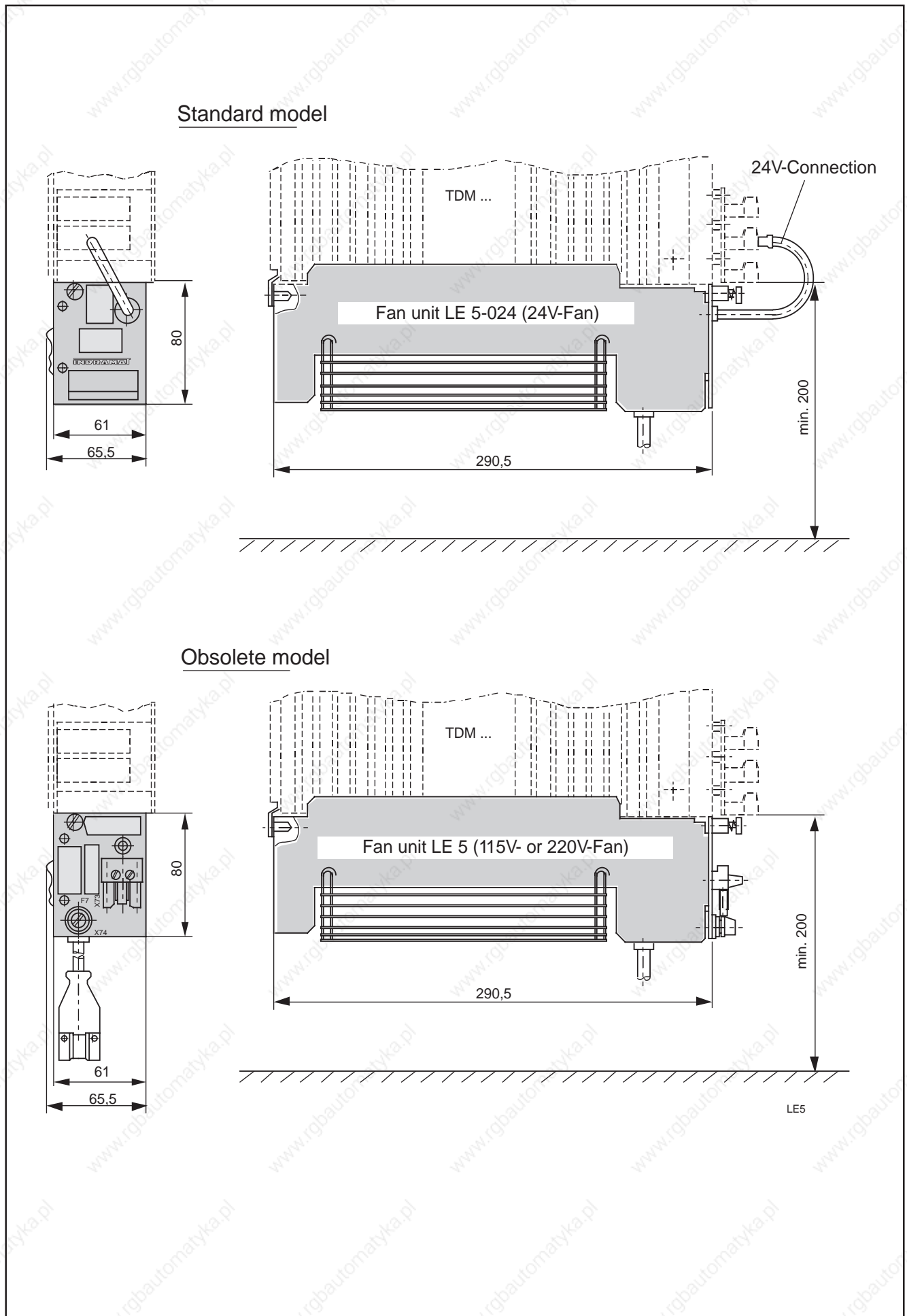

Fig. 46: Dimensions for mounted fan TDM 3, TDM 4, TDM 6, TDM 7

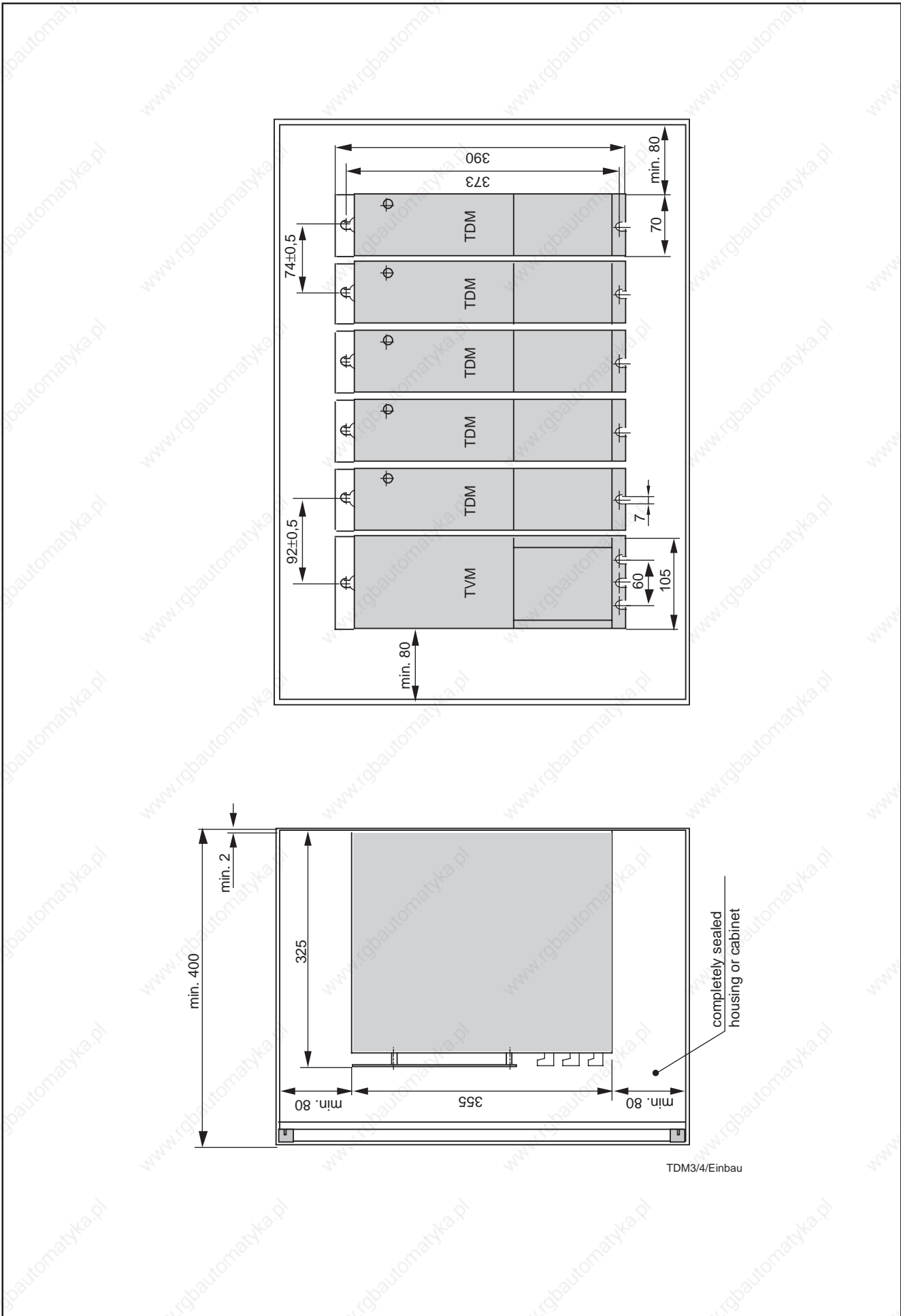

Figure 47: Diagram for flush mounting in TDM3, TDM4, TDM6, TDM7

## 5. Connections and Installation

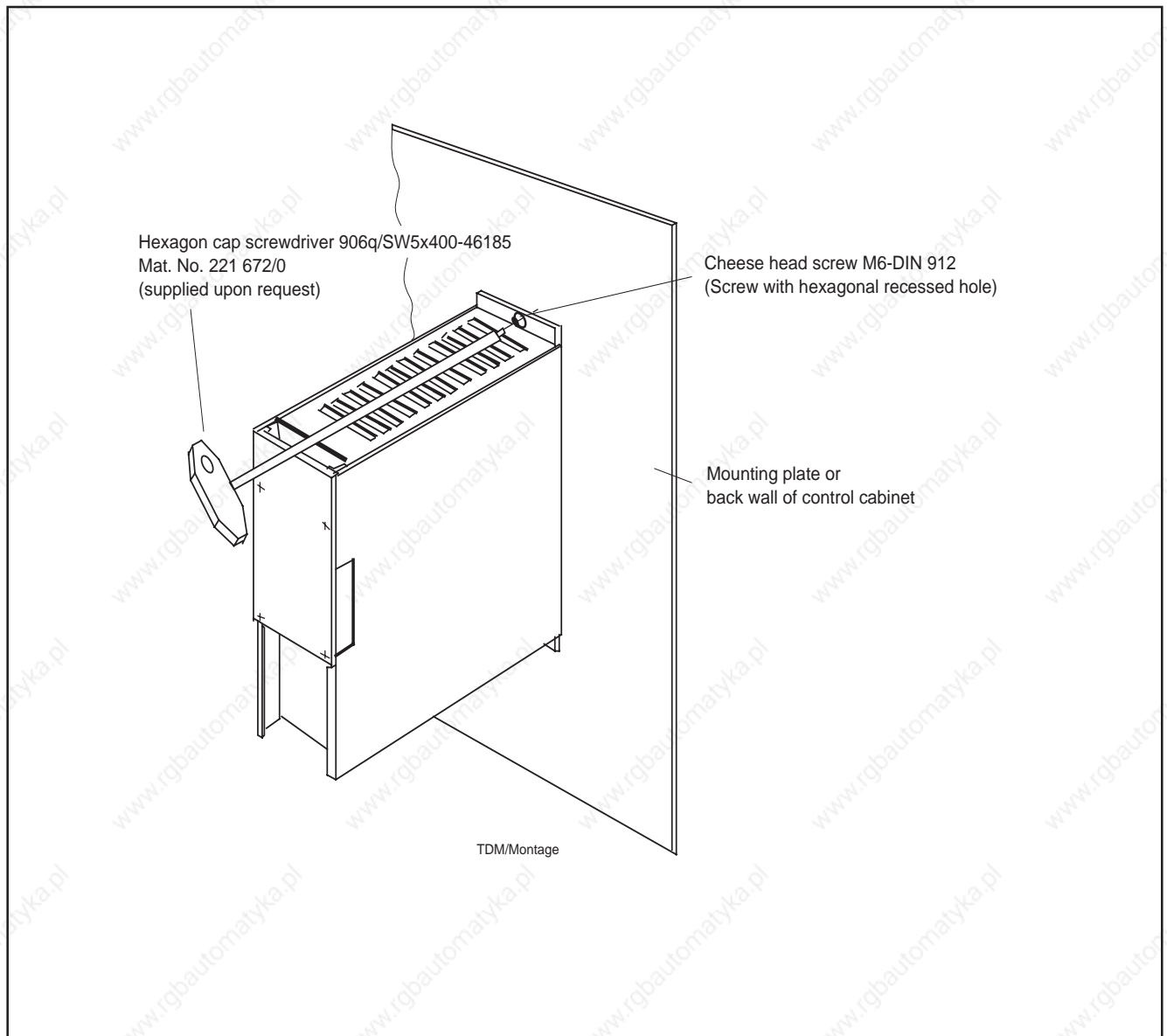

Figure 48: Mounting TDM1, TDM2, TDM3, TDM4, TDM6, TDM7

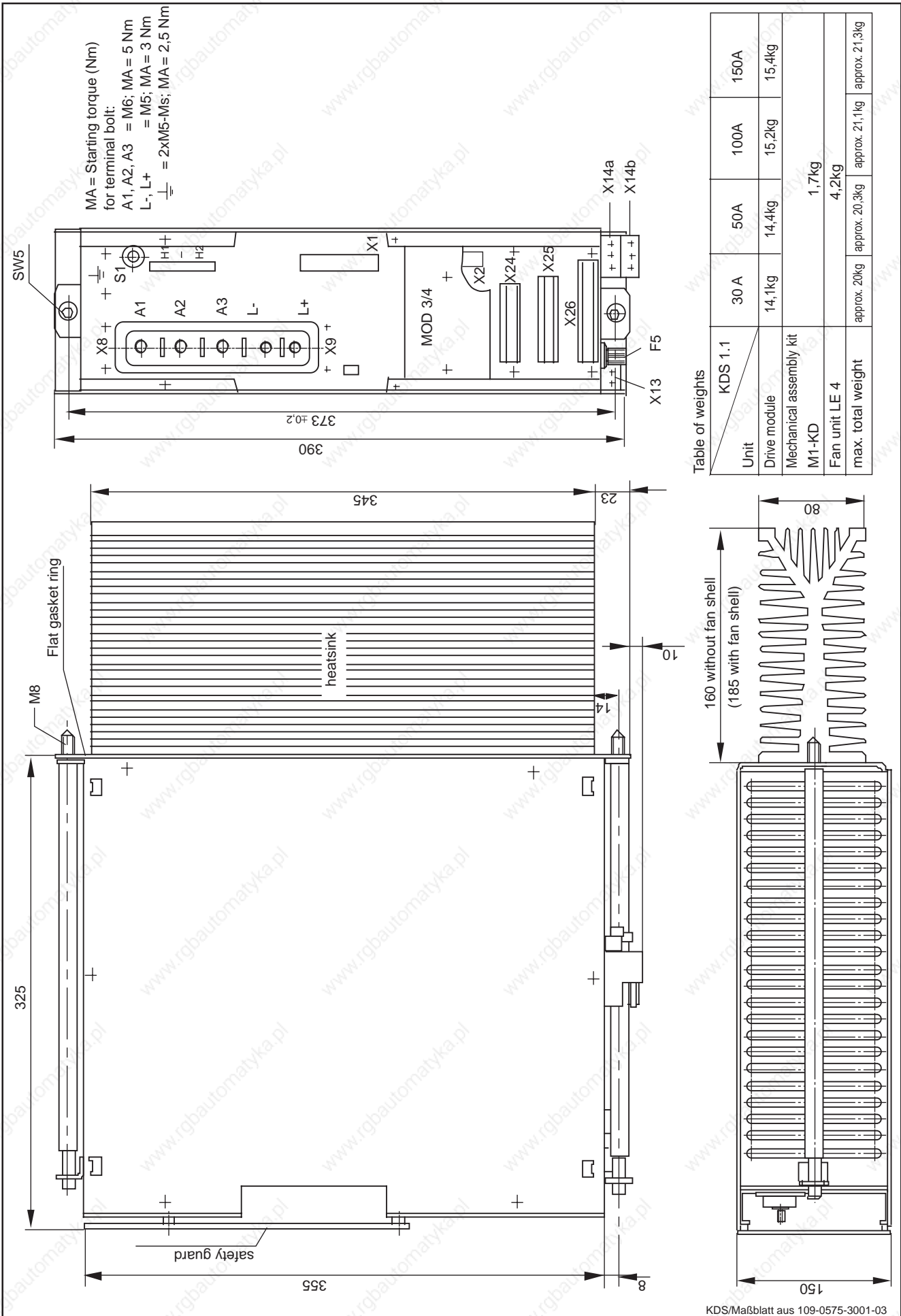

Figure 49: Dimension sheet for KDS1



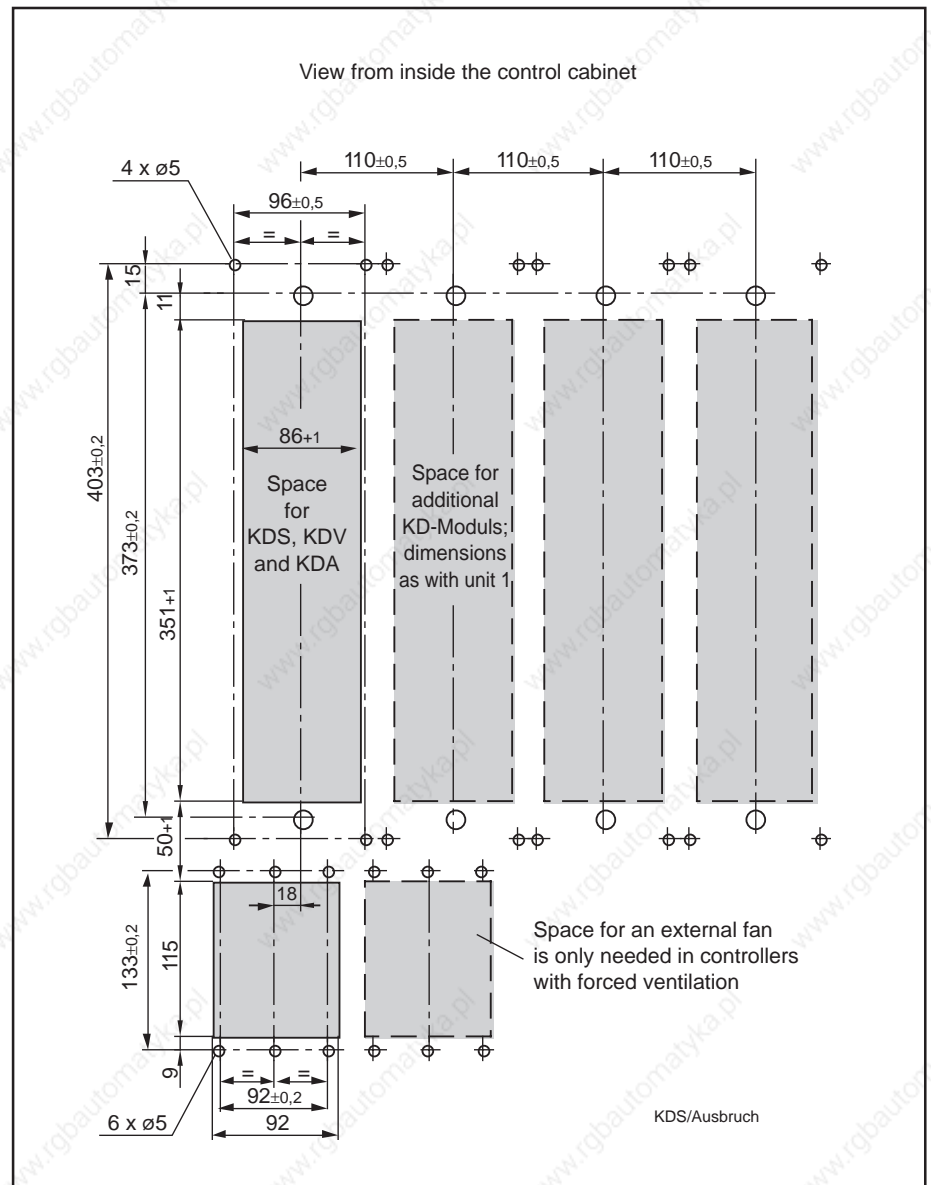

Figure 50: Dimensions for spacing and arranging KDS1

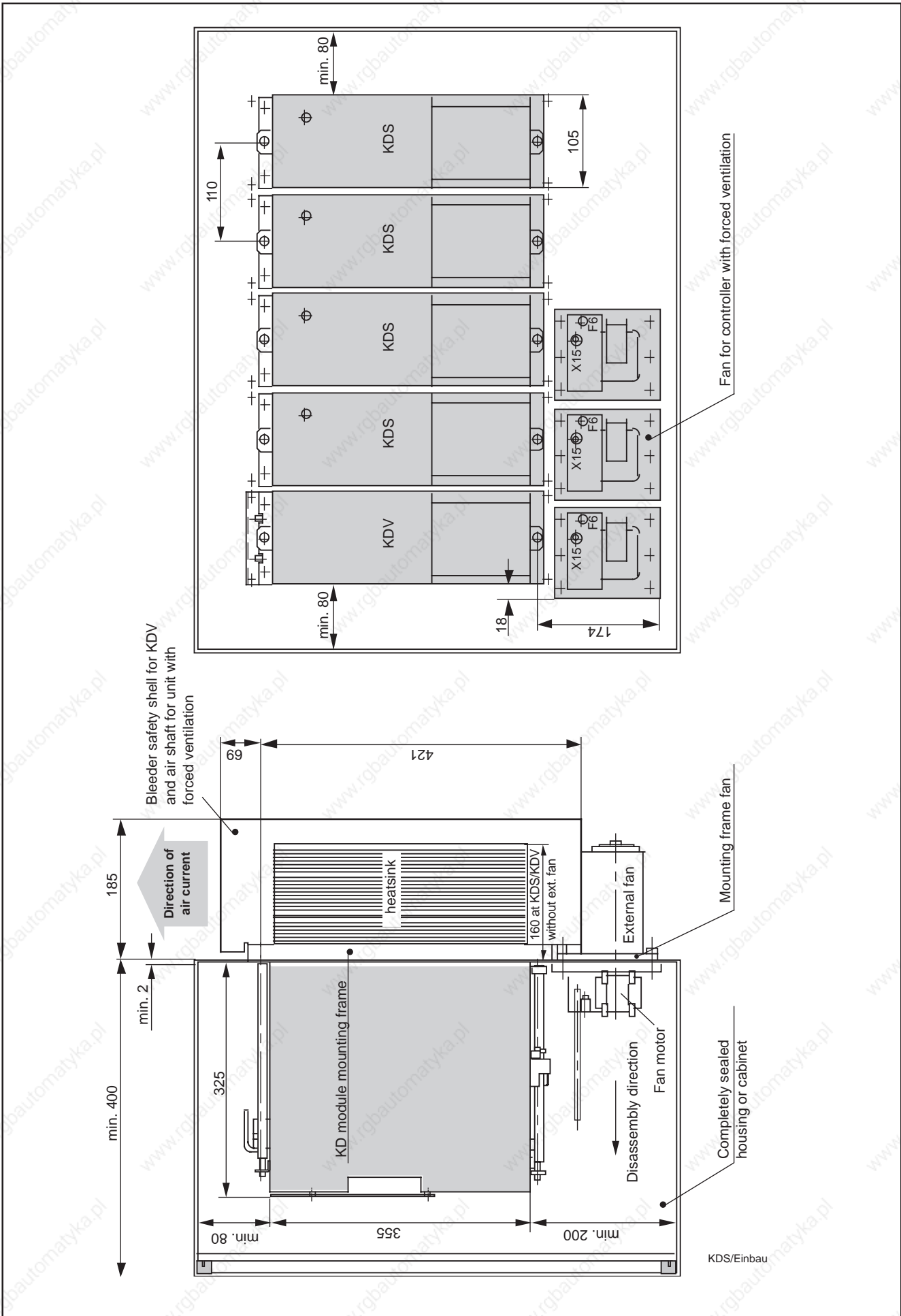

Figure 51: Mounting diagram for KDS1

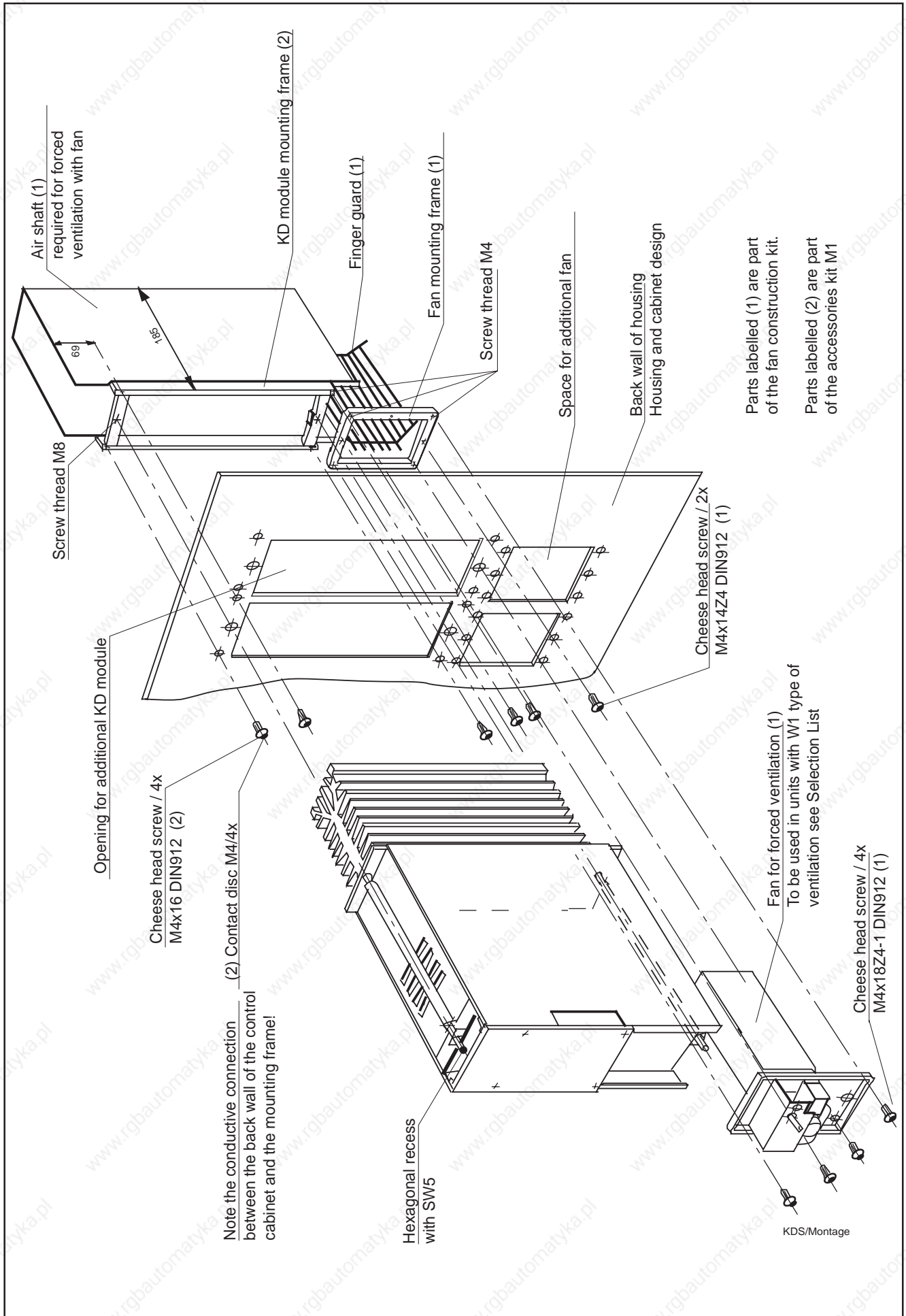

Figure 52: Mounting of KDS1

### 5.3. Connecting and wiring the servo drive module

The servo drive module connection, the plug and terminal box assignments of the MAC motors and the line assignments of the cable connections are depicted in the figures of Chapter 5.6.

The individual guidelines outlined in Chapters 5.3.1 through 5.3.8. should be followed.

#### 5.3.1. Mains connection

The mains connection and the control switch appropriate and recommended for it depend upon the supply module used and are, therefore, outlined in the corresponding supply module description.

#### 5.3.2. Connection accessories as supplied

Remove the following from the accessories as supplied:

- link-circuit busbar for L+ and L- connections,
- end plug X1,
- the plug-in terminals on the drive module for the analogue interfaces and the motor feedback connection, as well as,
- the flat belt bus cable for the low-tension bus plug X1 connections. The black lines of bus cable X1 should be at the bottom, once everything has been plugged in.

The end plug for line monitoring, which is a part of the accessories kit for the supply module, should be plugged into the last modular unit (the unit located farthest away).

#### 5.3.3. Power connections

Line cross-sections should be selected in a size sufficient to avoid any line overloading in the event that maximum ambient temperature and the corresponding currents should occur. (Recommendations can be found in DIN VDE 0113, or EN 60204, Section 1.)

The cross-sections of all lines at power connections must be **twisted** and have a sufficient size, namely:

- Lines to additional bleeder module TBM must be twisted with a cross-section of at least 6mm<sup>2</sup> (line length max. 2m).
- Lines to the additional TCM capacities must be twisted with a cross-section of at least 10mm<sup>2</sup> (see (1), 6 mm<sup>2</sup> with TVM) (max. line length of 0.5m).
- Adjacent drive modules are usually connected via the intermediate circuit busbar, a part of the connecting accessories. If this should not in some cases be possible, then the connection must be laid out in twisted lines which are as short as possible (max length 1m). A minimum cross-section of 10mm<sup>2</sup> suffices in this case (see (1), 6 mm<sup>2</sup> with the TVM).
- Intermediate circuit throttles of the „GLD“ type should be connected to the supply module using twisted lines of 10mm<sup>2</sup>. These should be as short as possible.

**Note (1):**

The permissible minimum cross-section in the link-circuit at terminals L+, L- is determined by the size of the fuse on the side of the mains in supply modules with higher levels of power:

Fuse current with mains voltage	Cross-section of minimum connection at L+, L-
3 x 400 volts	
up to 50 amp.	10 mm <sup>2</sup>
up to 63 amp.	16 mm <sup>2</sup>
up to 80 amp.	25 mm <sup>2</sup>

The earthing of the individual modular units via the protective conductor starts at the supply module and proceeds radially on each unit.

**5.3.4. Motor power cable**

The use of INDRAMAT motor cables is recommended for the lines between the servo drive module and the MAC servo motor.

The power cable contains:

- three lines for the motor power connection,
- one line for the protective conductor connection,
- a separately screened line pair for the motor thermostat contact, and,
- a separately screened line pair for the motor brake.

It can also be obtained as a ready-made cable with motor plug and ring cable sockets/vein end sleeves.

If necessary, the cable can also be made using four twisted individual leads (3 phase, 1 protective conductor) with separately routed, screened, thermal contacts and brake connection lines.

The minimum cross-sections are listed in the document entitled, „Electrical Connections of the AC Servo-Motor“. Maximum cable length equals 75m, if INDRAMAT cables are used.

To increase the immunity to interference, the use of an adaptor board with a connecting terminal for the thermostat contact and brakes is recommended in models TDM1, TDM2, TDM3, TDM4 and KDS (see Figure 53)

- AP 9 with servo modules TDM1, TDM2 and KDS1,
- AP 9/1 with servo modules TDM3 and TDM4.

This adaptor board must be removed and then remounted to the new controller in the event of an exchange.

**5.3.5. Evaluation of the motor thermostat contact**

In the event that the motor temperature exceeds the critical value, which is equal to a motor housing temperature of approximately 105...110 degrees Celsius or 45 K over-temperature, then the thermostat contact opens in the motor windings. In this case, the drive must be shutdown and turned off within one minute after the contact opens. Within this minute, the NC can initiate a machine stop during the program cycle without damaging a workpiece.

## 5. Connections and Installation

It is possible for the thermostat contact in the coil end of the motor to open with increased short-term overloads even with low housing temperatures.

Since interference voltages are inherent in thermostat contact lines (located in the motor power cable), this contact (contact load max. 220 volts, 1 amp.) should only be connected via potential-separated inputs for evaluation in an electronic controller.

Generally, the cable screens should be earthed on the control cabinet side. The ground connection of the shield at the end of the cable should be as short and direct as possible.

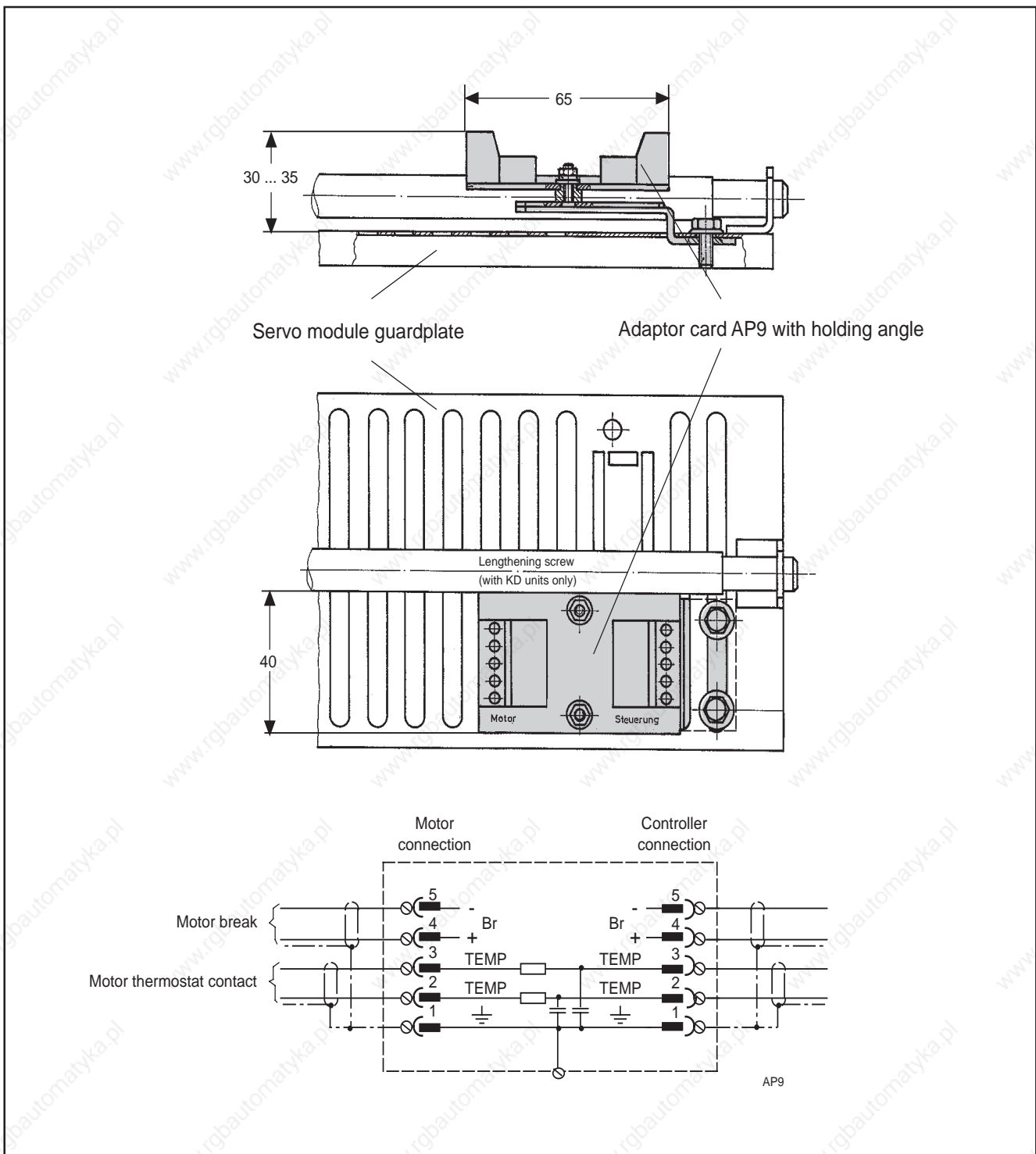

Figure 53: Mounting and connecting adaptor card AP9

### 5.3.6. Motor feedback cables

The shielded motor feedback cable supplied by INDRAMAT contains nine lines. It is also available as a ready-made cable with motor terminal and vein end sleeves.

Both the motor power cable and the feedback cable can have a maximum length of 75m, if original INDRAMAT cables are used.

The feedback cable should be routed separately and as far as possible from all load lines such as mains lines, motor power cables and contactor controller lines because of the possible source of interference they represent, especially with longer cable lengths (longer than 10m). A clearance of at least 100mm to the motor power cable is recommended.

The feedback cable must be single-sidedly earthed to the servo drive module. The ground connection of the shield must be as short and direct as possible.

The cable should not be routed close to high-frequency equipment, magnetic fields from transformers, throttles, motors and other magnetic consumers, as well as, high-voltage lines as otherwise interference could be coupled in.

Maximum shielding can be achieved by routing the motor power cable and the motor feedback cable in separate, grounded metal pipes, Fig. 54, if high demands need to be made of the immunity to interference, in order

- to avoid disruptive couplings between both of these cables, and,
- to avoid disruptive reflections by the motor power cable onto adjacent electronic production facilities and mains.

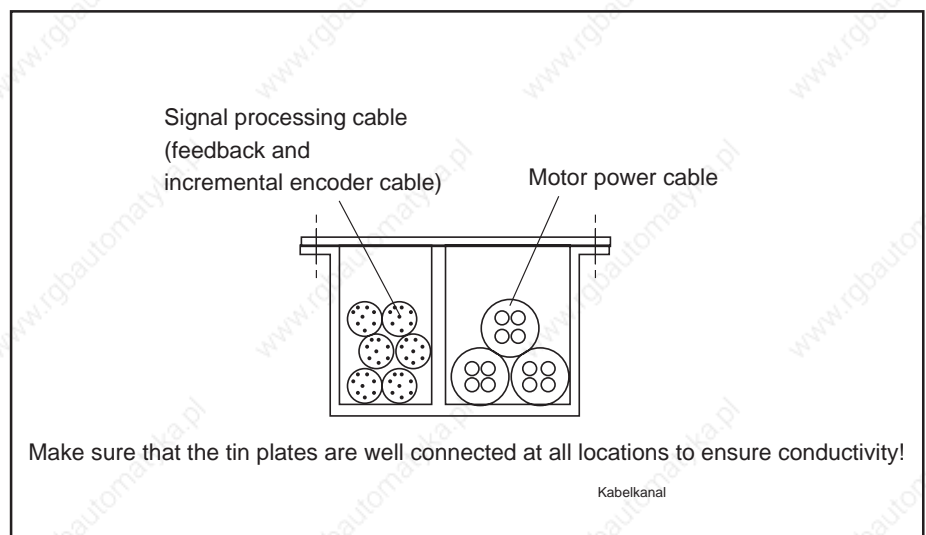

Figure 54: Example of a separated and shielded routing of the motor power and feedback cables in metal pipes or canals!

### 5.3.7. Position Return

Both the connection and maximum cable length of a position encoder attached to the motor are outlined in the corresponding manufacturer's guidelines. The length is dependent upon encoder type and controller input data.

Both connection assignment and maximum cable length for the encoder supplied by INDRAMAT can be found in the appropriate description for position return.

The connecting cables should be routed separated from all load lines such as mains leads, motor power cables and contactor controller lines because of interference.

Both the motor power and the encoder cables should be routed separately, particularly with longer cable lengths (greater than 10m) and using the greatest possible clearances.

Maximum immunity to interference can also be achieved here if motor power and encoder cables are routed in separate metal pipes, Fig. 54.

The cable shields should generally be grounded on one side. The grounding connection of the shield at the end of the cable should be as short and direct as possible.

The signal lines should not be routed near high-frequency equipment, magnetic fields from transformers, throttles, motors and other magnetic consumers as well as high-voltage cables as otherwise interference could be coupled in.

### 5.3.8. Signal lines

The data for the input and output signals of the terminal strips for the user are outlined in Chapter 4.

This includes:

- speed set-point inputs E1, E2, E3, E4
- controller enabler RF,
- external speed or current limit Ired,
- current set-point MA,
- tachometer output Tsense,
- external connection of controller voltage +15Vm, -15Vm, 24V.

In an effort to reduce start-up times, all signal lines have been connected via plug-in terminals, which are part of the electrical connecting accessories. The cross-section equals at least 0.25 mm<sup>2</sup>, but no more than 1.5 mm<sup>2</sup>.

The plug-in terminal connections belong to securely separated electric circuits and may only be, in order to guarantee protection against contact, connected to electric circuits from other units or equipment, if these circuits are also securely separated (low-voltage operation with secure separation, also called „PELV: Protective extra low voltage“).

The messages coming from the terminal strip (terminals Bb1, Bb, TÜ, BVW, TVW, UD, NH, HSM) of the supply module and drive module can



be evaluated in a controller, in accordance with the data found in Chapter 7.2.2. (Figures 77-79).

It is recommended that all signal lines be shielded. The cable shields are generally grounded on one side, namely, the servo module side. The grounding connection of the shield at the end of the cable should be as short and direct as possible. The corresponding signal lines should be routed separated from all load lines such as mains leads, motor power cables and contactor controller lines because of possible interference.

The signal lines should not be routed near high-frequency equipment, magnetic fields from transformers, throttles, motors and other magnetic consumers as well as high-voltage cables as otherwise interference could be coupled in.

### 5.4. Earthing Connections

The protective conductors and earthing connections of the individual modular units should be routed radially from the central earthing point of the supply module, as outlined in the connection plan. The earthing connection of the supply module should be connected to the mains grounding. The measures needed to protect the machinery must be taken into consideration.

Earth circuits should be avoided, if possible, as interconnections can cause operating problems.

### 5.5. Measures to suppress interference

In addition to the guidelines on line routing, outlined in Chapter 5.3 and 5.4, the following should be noted when operating the drives:

#### 5.5.1. Sources of interference in the control cabinet

If, in connection with electronic equipment and construction elements, such inductive loads as throttles, contactors and relays are **switched** by means of contacts or semi-conductors, then these must be suitably suppressed. Direct current actuation achieves this with the arrangement of the free-wheeling diodes, alternating current actuation achieves this with the arrangement of contactor type-related, commercial RC noise suppressors located directly at the inductance.

**Only the noise suppressor arranged directly at the inductance serves this purpose.** Otherwise the noise level becomes too excessive and can interfere in the electronics as well as the operation of the drive.

All other sources of interference, such as high-frequency equipment (components of eloxadizing equipment, amongst others) should be located and wired outside of the control cabinet.

#### 5.5.2. Use of Radio Equipment

If radios are used near the electronically controlled drive while the facility is running, then the following conditions must be maintained to exclude any interference from within:

The control cabinets should always remain closed during normal operation to guarantee a sufficient high-frequency shielding of the internal wiring of the control cabinet and of the electronic equipment.

The motor feedback cable should be routed as close as possible to grounded metal surfaces or in grounded metal cable shafts.

Working with radios during the commissioning process or testing close to an open control cabinet should be avoided while the drives are being operated. If radios are held during transmission close to the open control cabinet door and are pointing at an unfavorable angle in the direction of the control cabinet internal wiring, then uncontrolled motor movements are likely to occur once the drive is released and no higher-ranking monitor has been activated.

### 5.5.3. Radio Interference Suppression

Suppression of radio interference is generally not needed within an industrial area or over larger industrial sites. If, however, machinery equipped with AC drives is operated in residential or smaller industrial areas and suppression of radio interference becomes necessary, then the limiting values of Class B in accordance with DIN VDE 0875, Sections 1, 3 and 11 or EN 55011, EN 55014, EN 50081, CISPR 11, CISPR 14 are adhered to directly at the machine by mounting a noise filter which INDRAMAT recommends into the mains cable.

It is further recommended when longer cable lengths of the motor power cable are used and those motor power cables are not routed in a metal casing

- that a shielded cable be used, or even better,
- that these be routed in grounded metal pipes or in grounded cable shafts lined with metal.

Figure 55, which follows, outlines all connections and terminal of the servo drive module.

### 5.6. Connection and wiring diagrams

Plan overview:

Figure	Connecting plan
Fig. 55	Overview of the connections of the servo drive module
Fig. 56	Connecting plan TDM 1
Fig. 57	Connecting plan TDM 2
Fig. 58	Connecting plan TDM 3
Fig. 59	Connecting plan TDM 4
Fig. 60	Connecting plan TDM 6
Fig. 61	Connecting plan TDM 7
Fig. 62	Connecting plan KDS 1
Fig. 63	Bus connection X1: Plug assignment between the modular units
Fig. 64	Plug connection IN 108 of the motor power cable at motor MAC
Fig. 65	Plug connection IN 172 of the motor power cable at motor MAC
Fig. 66	Plug connection IN 252 of the motor power cable at motor MAC
Fig. 67	Terminal box connection of the motor power cable at motor MAC 132 and MAC 160
Fig. 68	Plug connection of the feedback cable between the feedback unit of the MAC motor and terminal strip of servo drive modules TD1, TDM2, TDM3, TDM6 or KDS1.
Fig. 69	Plug connection of the feedback cable between the feedback unit of the MAC motor and the terminal strip of servo drive modules TDM3, TDM6.
Fig. 70	Plug connection of the feedback cable between the feedback unit of the MAC motor and the terminal strip of servo drive modules TDM 4, TDM7.

Connection, Terminal	Function	Maximum lined-up voltage
L+, L-	Power connection to adjacent equipment using link-circuit busbar. Tighten nut M5 of the fixing bolt with max. 3Nm!	250...450 Volt
A 1 A 2 A 3	Three-phase connection of the motor power cable. Tighten nut M6 of the fixing bolt with max. 5 Nm!	250...450 Volt
X1	The bus connection distributes low-level voltages and the acknowledgement message line of the end plug to the individual drive amplifiers.	$\pm 15V$ , 24 Volt
TDM 1: X5 TDM 2: X5 TDM 3, TDM 6: X42, X43 TDM 4, TDM 7: X49, X50 KDS 1: X25, X26	Terminal strip for user inputs and outputs (description Chapter 4).	$\pm 15 V$ , 24 Volt
TDM 1: X6 TDM 2: X6 TDM 3, TDM 6: X41 TDM 4, TDM 7: X48 KDS 1: X24	Feedback connection for MAC motor This connection supplies the motor feedback electronics and signals rotor position (BIC 1, BLC 2, BLC 3) and the tacho signal to the servo drive module for the purpose of evaluation in the controller.	$\pm 15$ Volt

Figure 55: Servo drive module connections and voltages between the terminals and the housing.

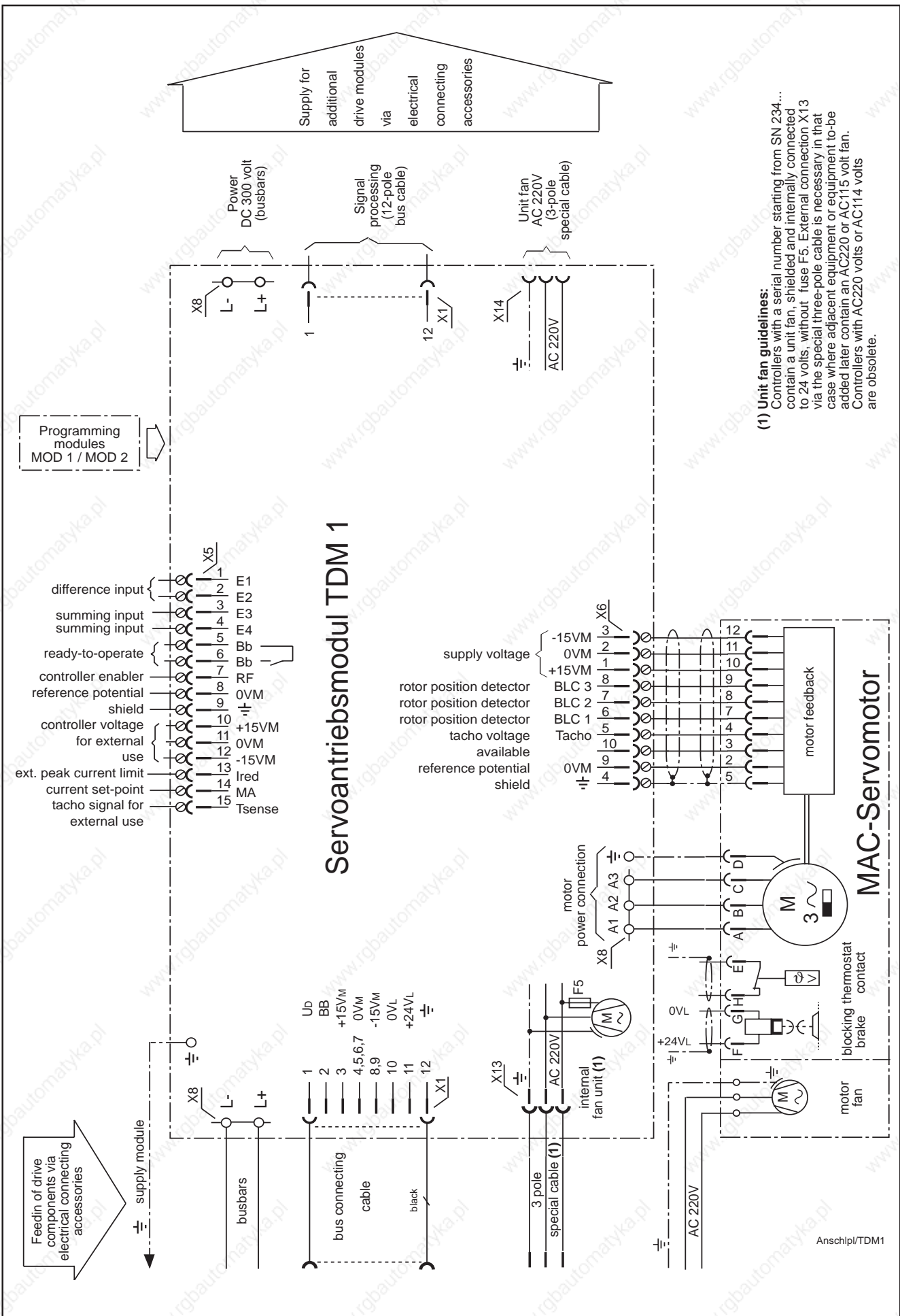

Figure 56: TDM 1 connection plan

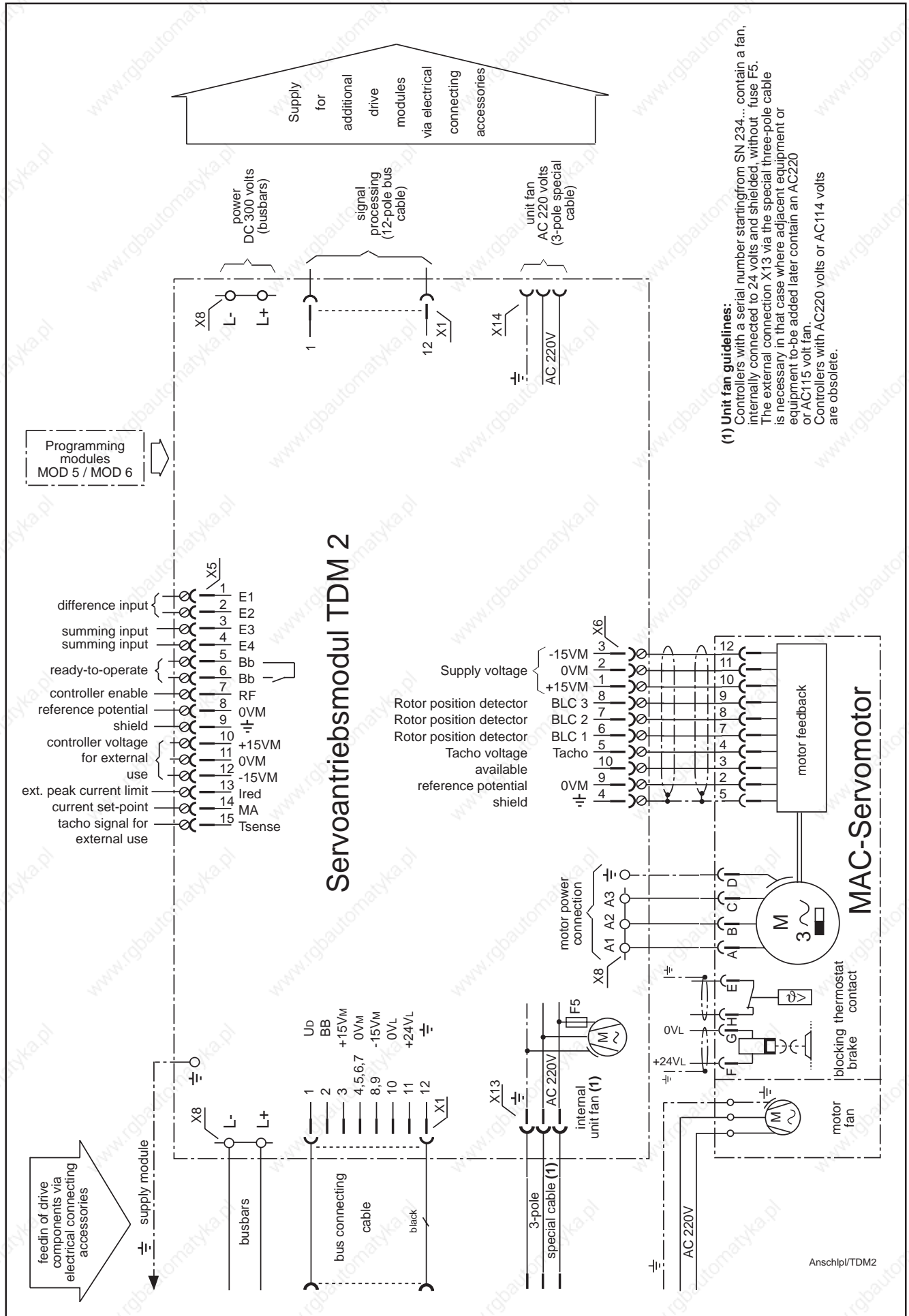

Figure 57: Connecting diagram for TDM2

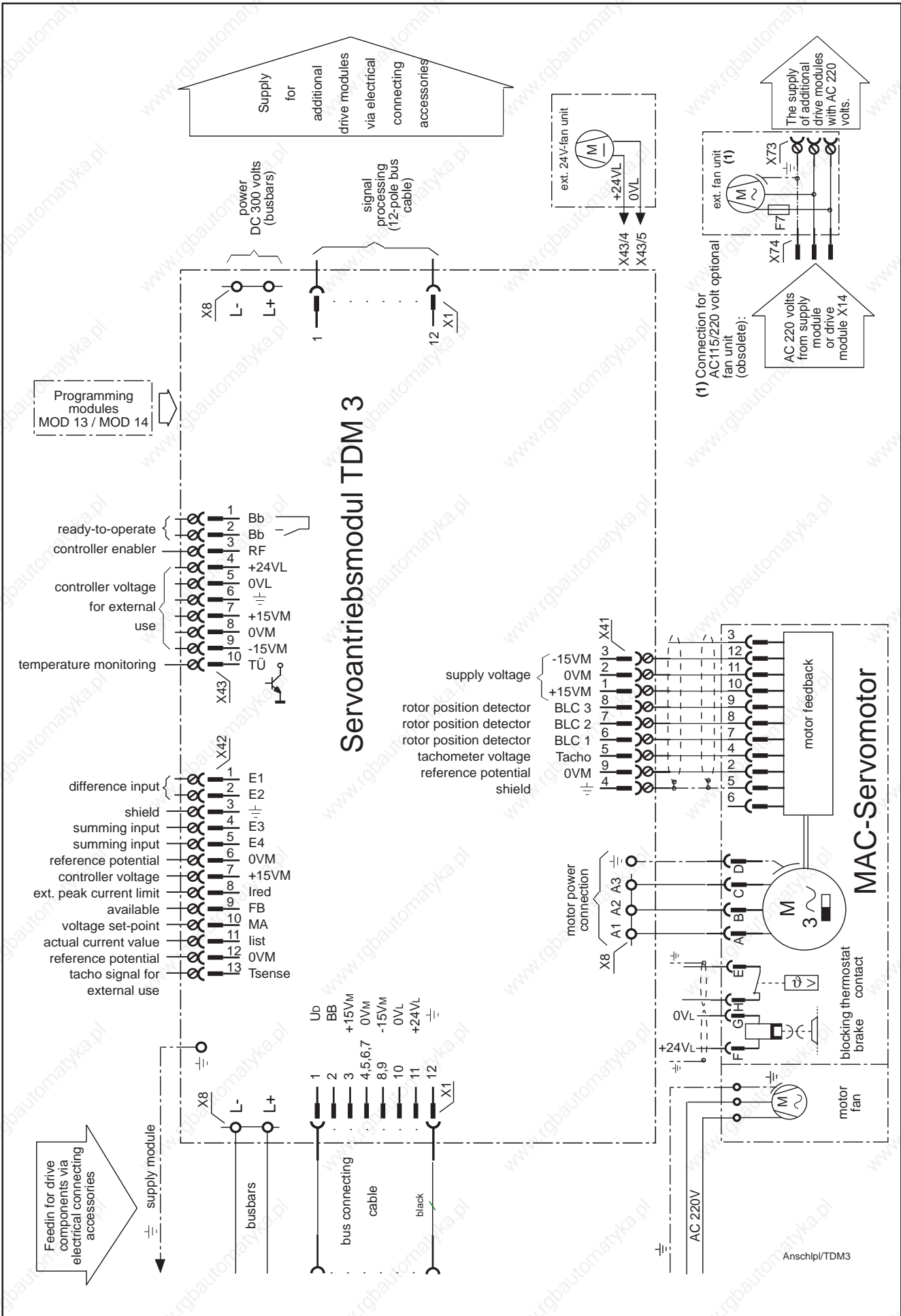

Figure 58: Connection plan for TDM3

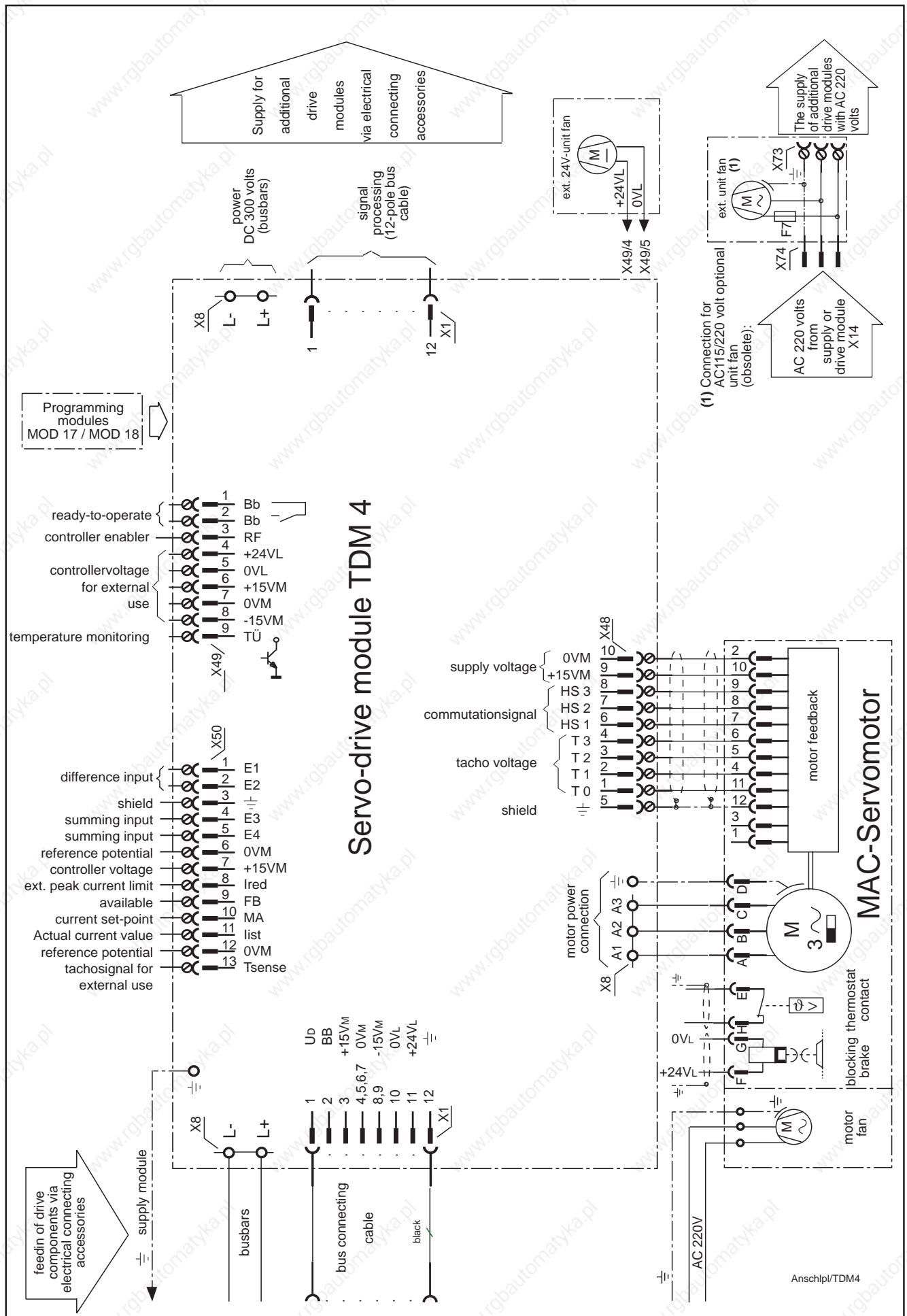

Figure 59: Connection plan for TDM4

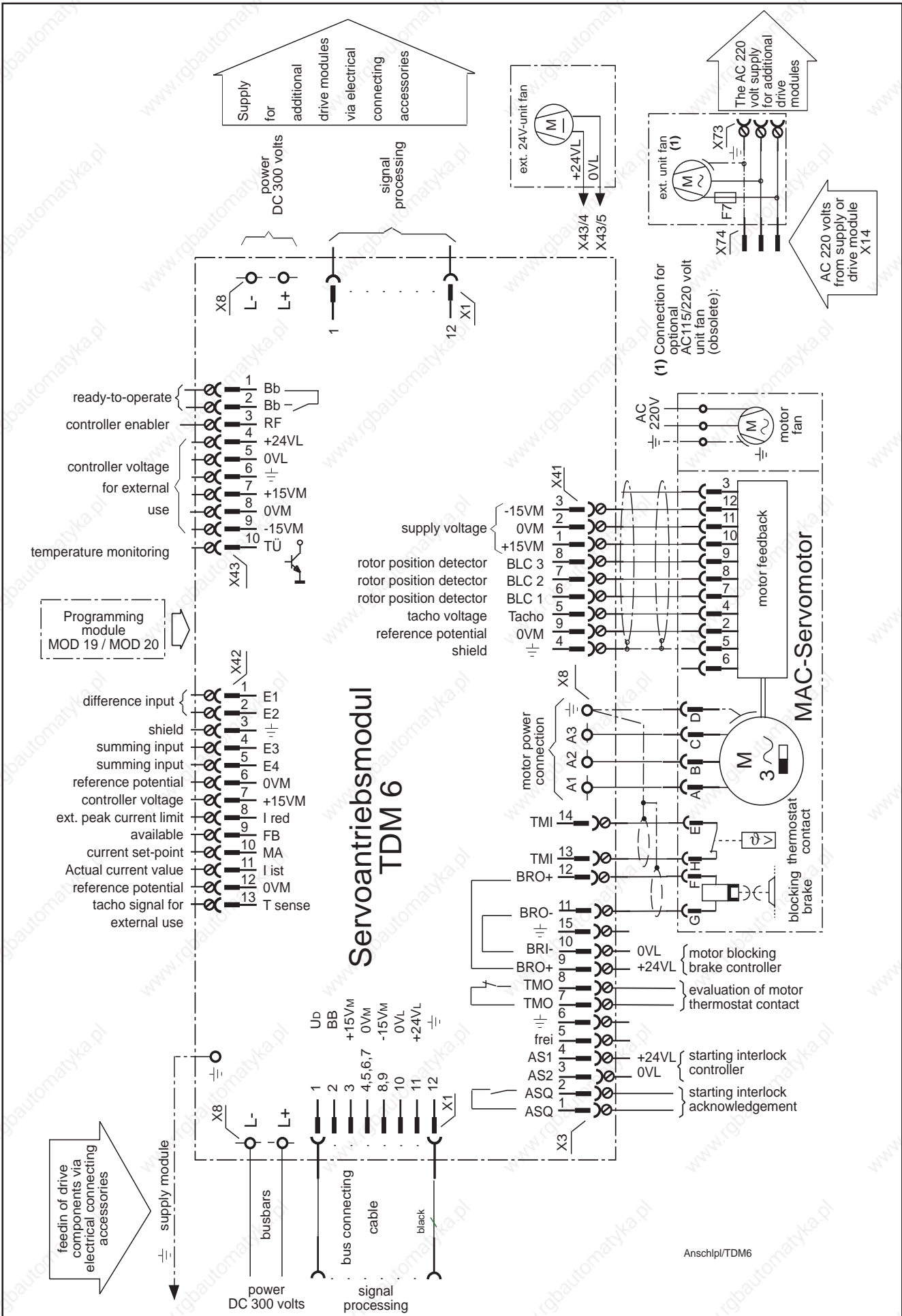

Figure 60: Connection plan for TDM6



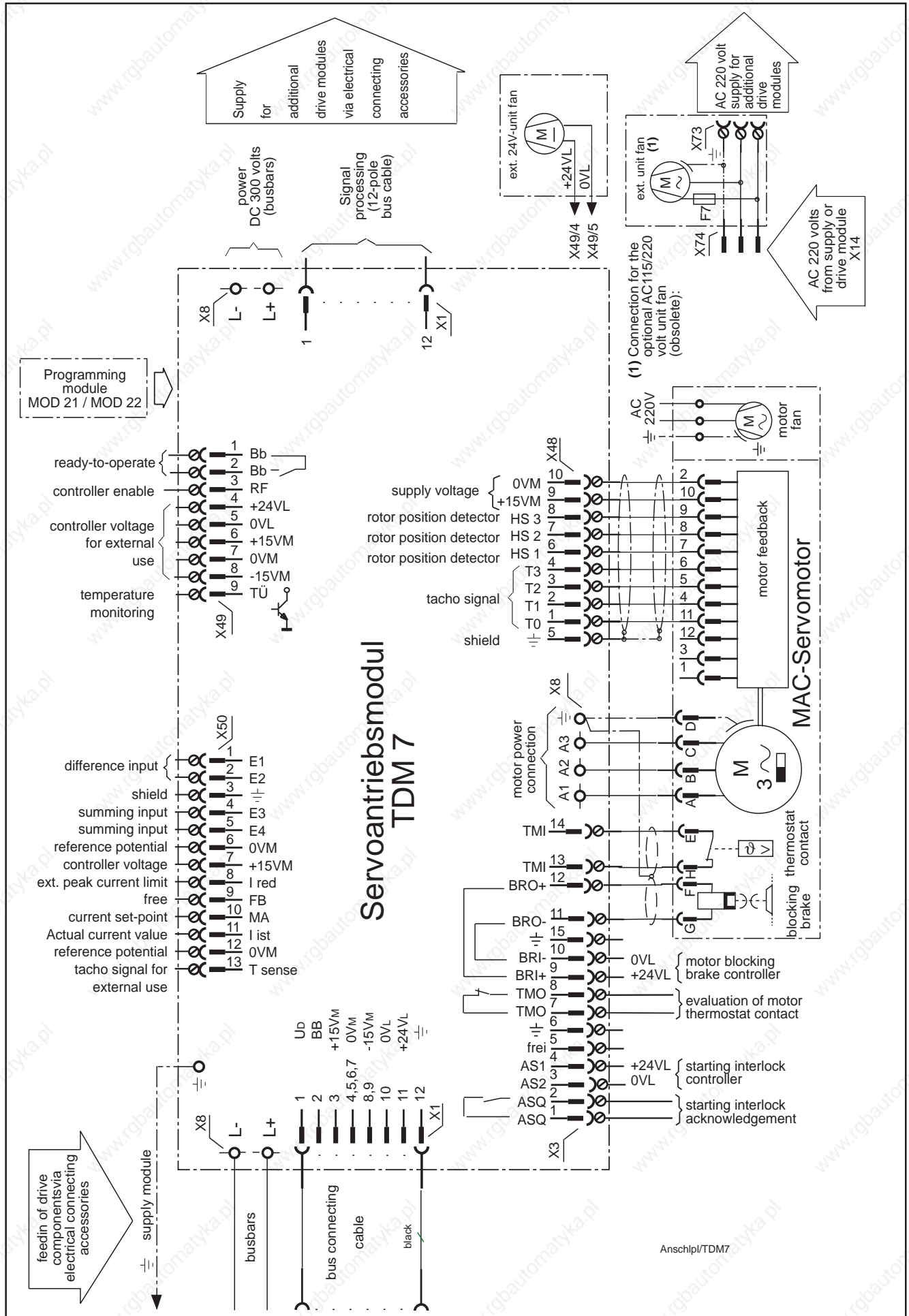

Figure 61: Connection plan for TDM7

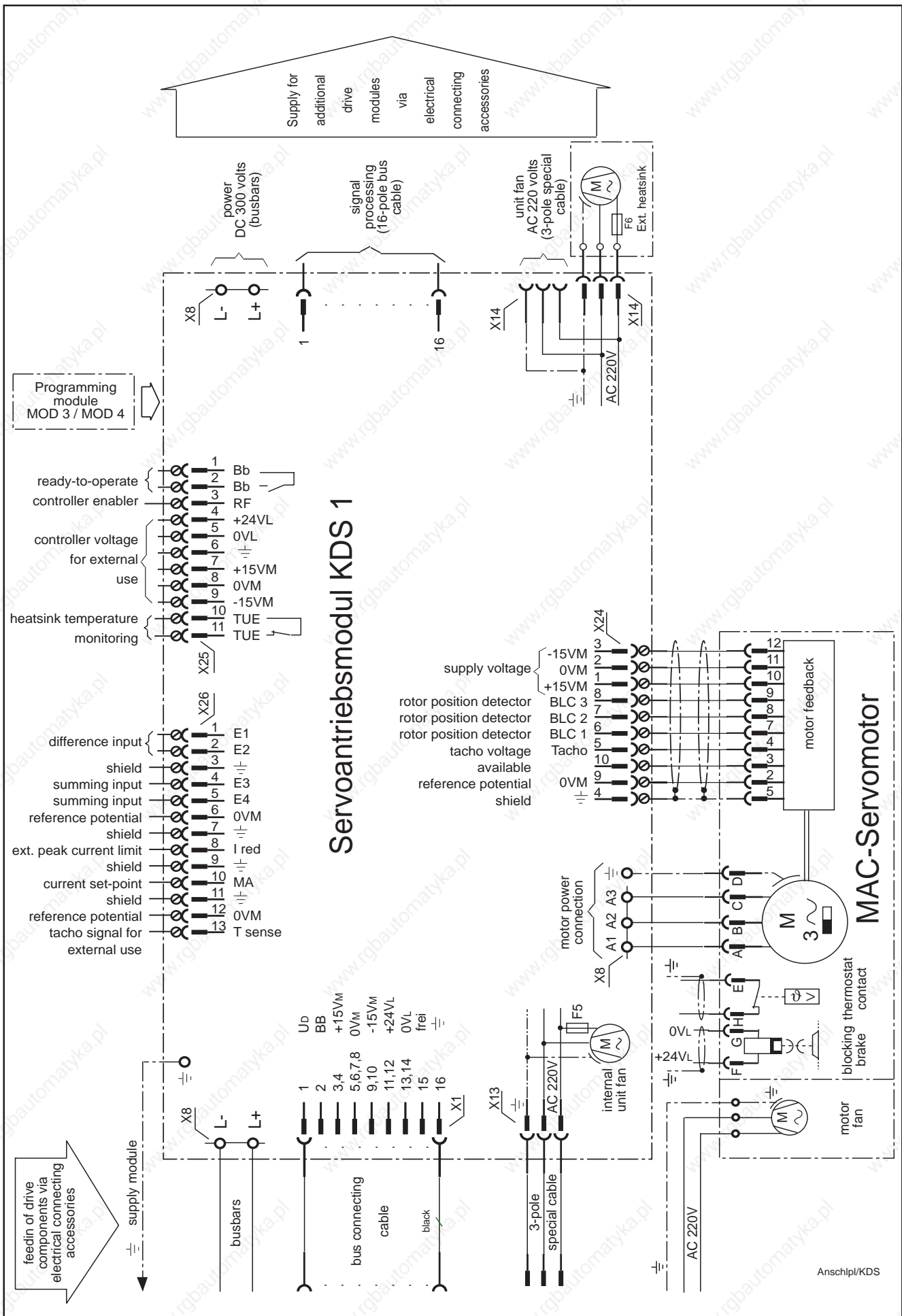

Figure 62: Connection plan for KDS1

## 5. Connections and Installation

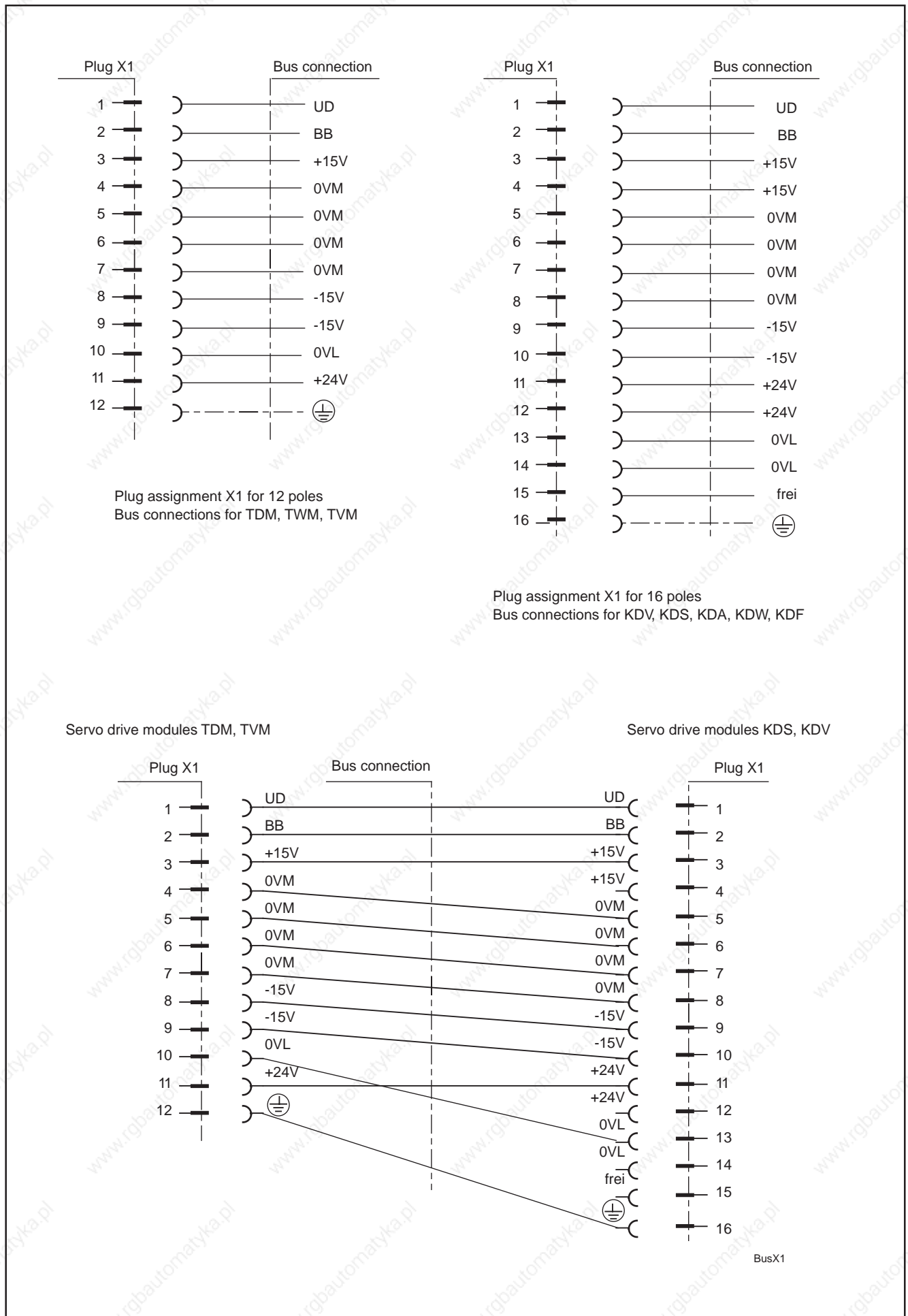

Figure 63: Bus connection X1: Plug assignment between the modular units

## 5. Connections and Installation

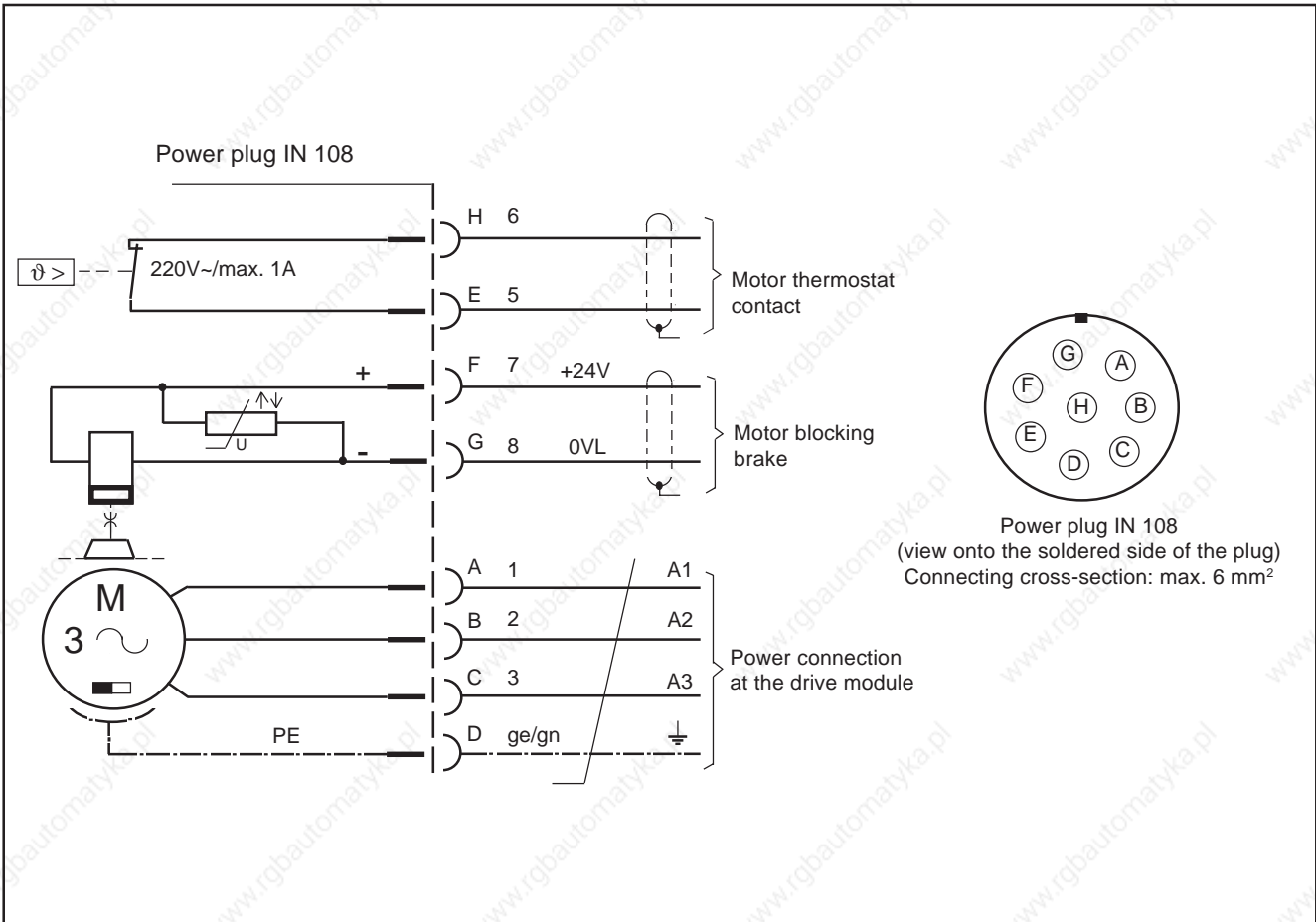

Figure 64: Plug connection IN108 of the MAC motor power cable

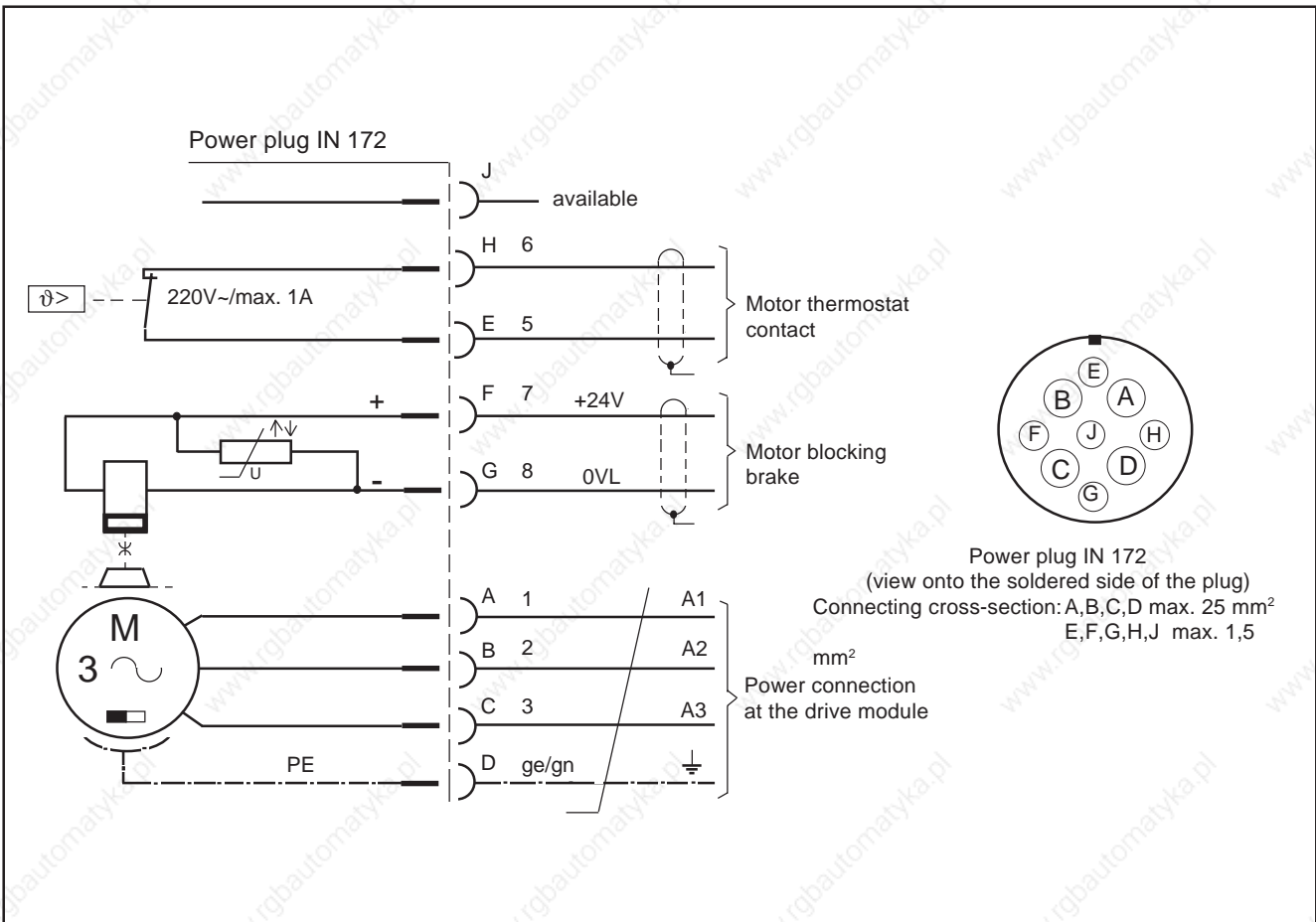

Figure 65: Plug connection IN172 of the MAC motor power cable

## 5. Connections and Installation

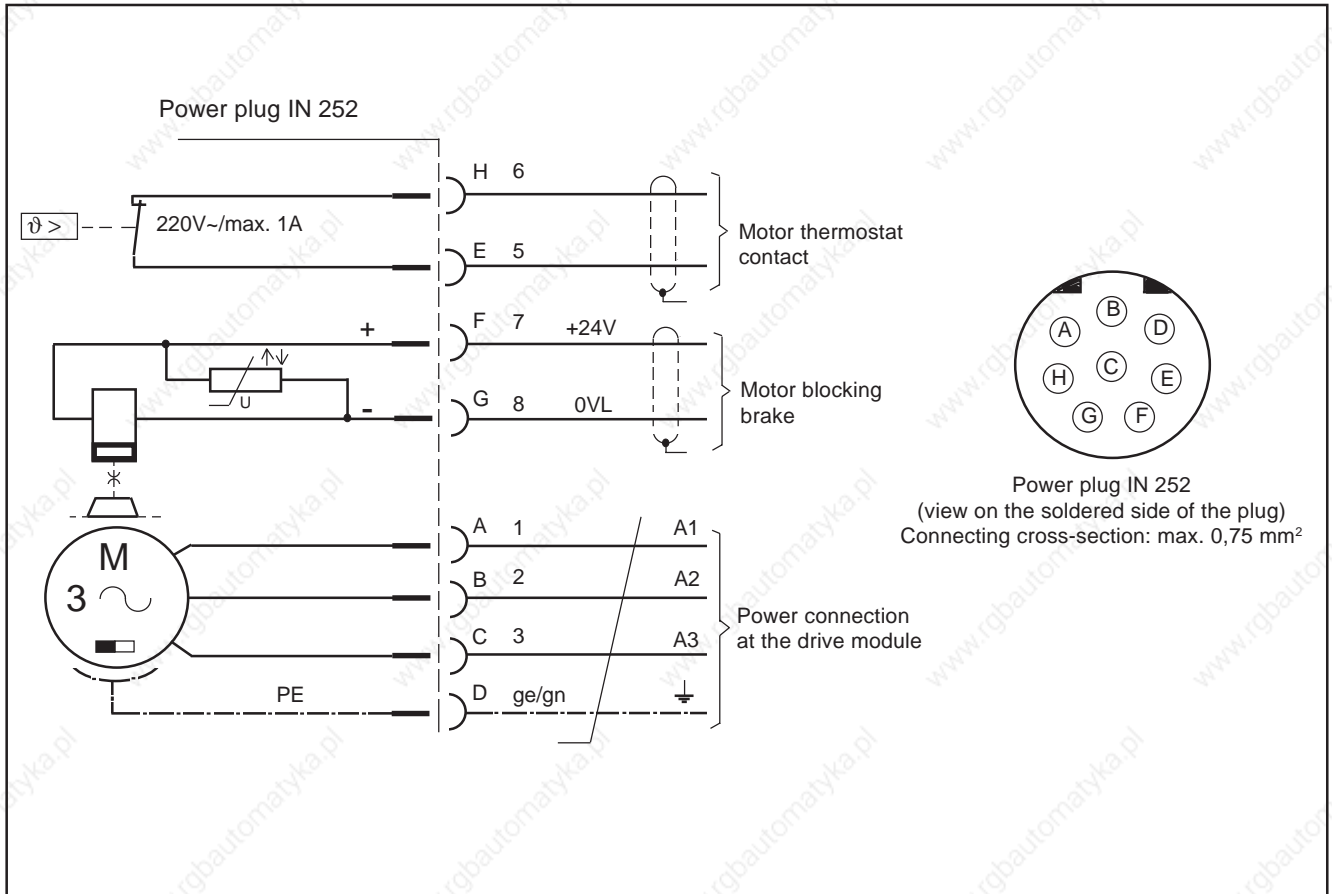

Figure 66: Plug connection IN 252 of the MAC motor power cable

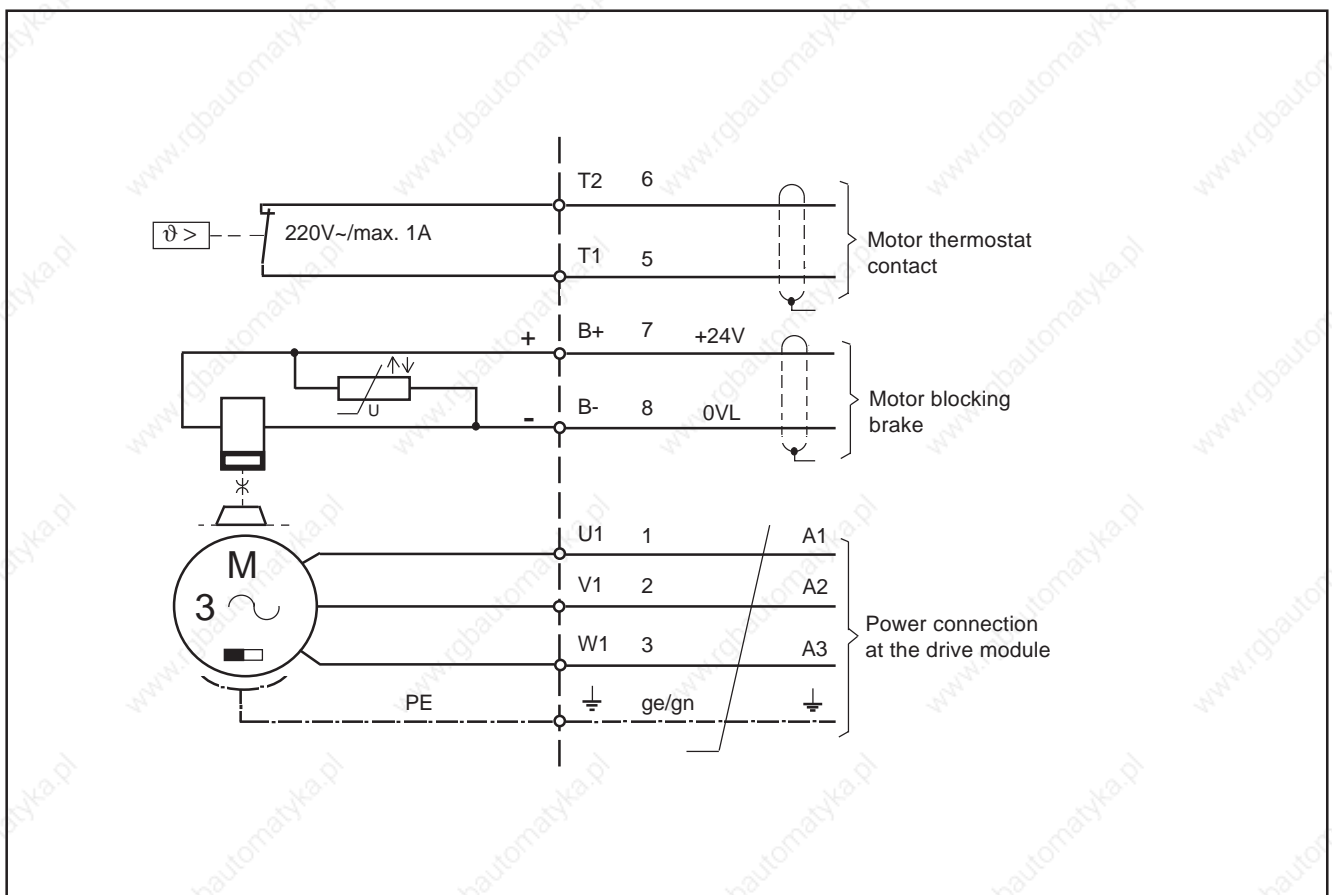

Figure 67: Terminal box connection of the motor power cable on the MAC 132 and MAC 160 motors.

## 5. Connections and Installation

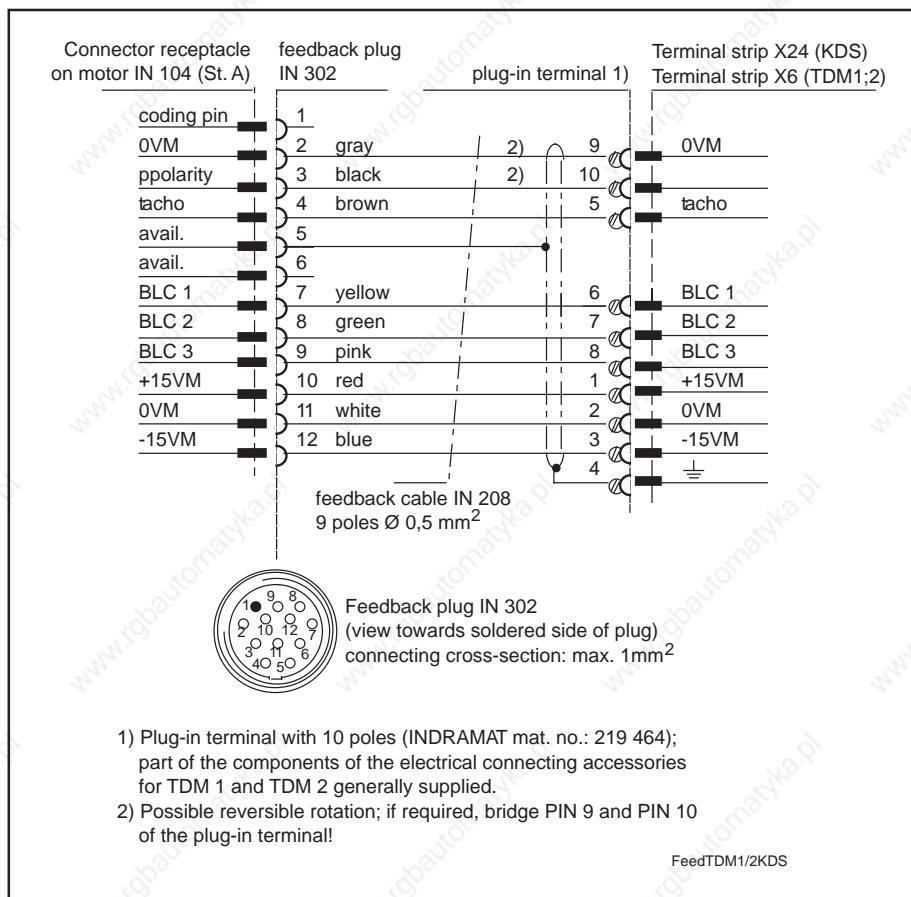

Figure 68: Plug connection of the feedback cable between the return unit of the MAC motor and the terminal strip of servo drive modules TDM1, TDM2 or KDS1.

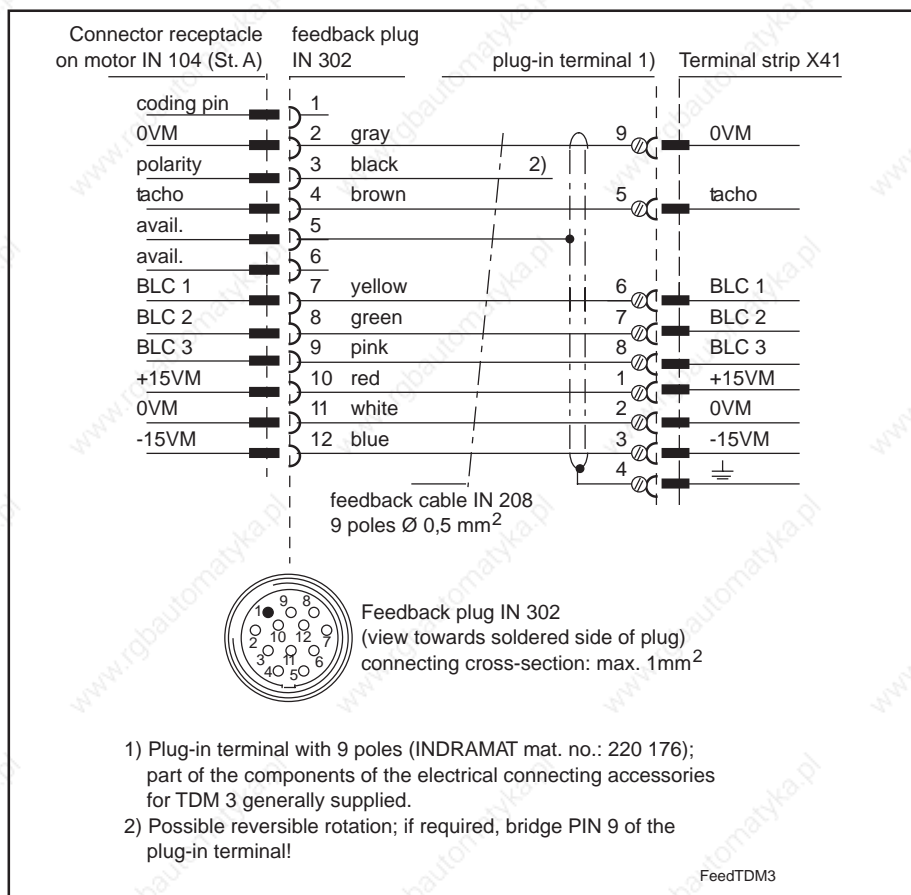

Figure 69: Plug connection of the feedback cables between return unit of the MAC motor and terminal strip of servo drive modules TDM3 and TDM6.

## 5. Connections and Installation

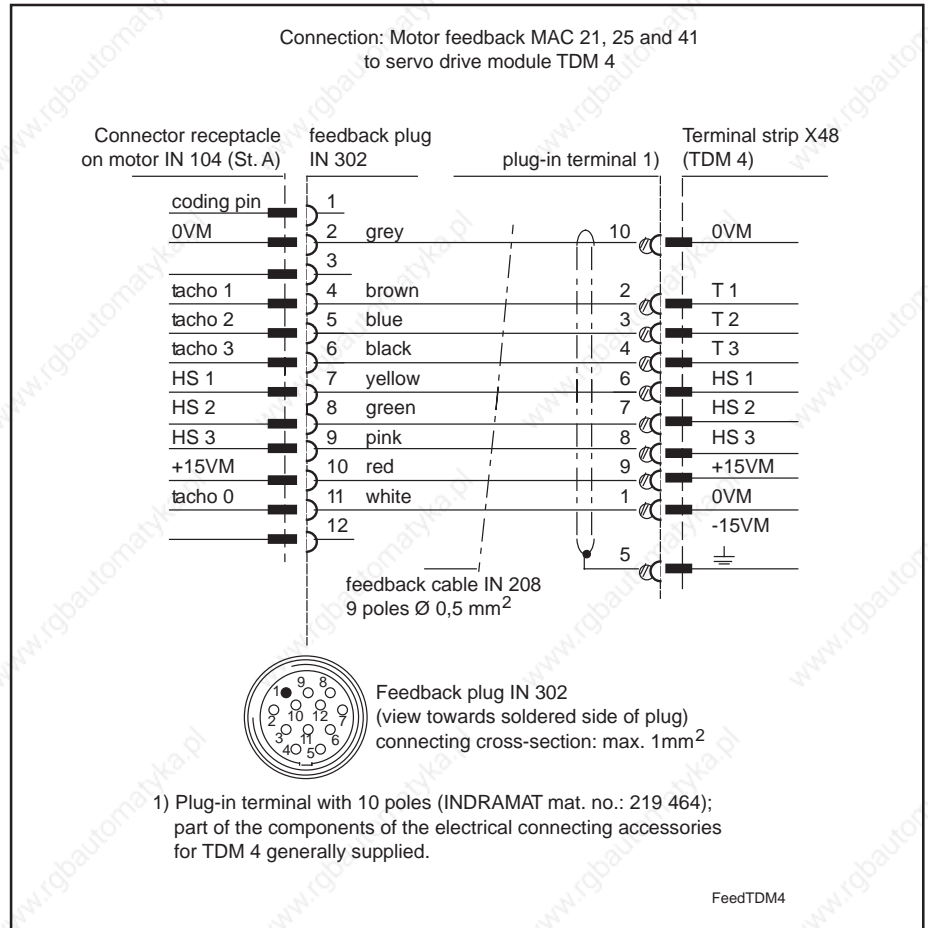

Figure 70: Plug connection of the feedback cable between return unit of the MAC motor and the terminal strip of servo drive modules TDM4 and TDM7.

## 6. Commissioning

Note: The commissioning steps required for the INDRAMAT drives only are described here. The machine manufacturer must submit the commissioning process for the entire machine or facility as required for the individual application.

### 6.1. Protection of Personnel and Machinery

#### 6.1.1. Safety of Personnel

Protection against contact with hot parts.

Sources of Danger:

- high mains voltage at terminals L1, L2, L3
- high link circuit voltage at L+, L-
- high motor voltage at terminals A1, A2, A3 and motor cable plug-in terminals.

Before working on electrical equipment and units:



- **Using the master switch, switch power to the machine off and secure it against being switched back on! In case of doubt, remove fuses.**
- **Wait through the discharge time of the intermediate circuits after shutting down! The discharge time can, depending upon the condensers, take several minutes.**
- **Wait for the motors to stand still because of the motor voltage! Check the voltage between int. circuit busbars L+ and L- after shut down to see if the value is below 50 volts. If in doubt, short-circuit.**

– Before turning units on:



- **Securely cover all hot parts to avoid any accidental contact! Cover the power connections with plastic lids!**
- **Close the control cabinet, if possible. Authorized electrical personnel must secure open electrical control cabinets, accessible electrical facilities and equipment, which could be hot, against contact by personnel at risk.**
- **Check the fixed connection of the protective conductor of all the electrical equipment and motors, in accordance with the connection plans! Operation is only permitted with firmly attached protective conductors in their proper positions on equipment and motor plug, even for quick measuring or testing purposes.**



– Protection against indirect contact with the mains:

Secure against contact by taking the necessary protective measures which are prescribed for the mains situation at hand.



**An F1 protective feature (fault current protective feature) cannot be used for the AC drives! Protection against contact must be secured in some other way, e.g., an over-current protective feature (in accordance with DIN VDE 0160, Section 6.5.2.4).**

Protection against dangerous movements

Danger from unwanted movement exists because of faults

- in the wiring and cables
- in the NC or NC program
- in the measuring value encoders such as the incremental encoder,
- in the operation of the machine, e.g., switching-off safety functions and monitors to check operation and setting.

These faults can occur

- right after commissioning, but also,
- after an indeterminate length of time during normal operation.

The following safety guidelines should therefore be observed:

– While operating the drives:



- **Personnel should not remain within the vicinity of machine activity! Measures that could be taken: protective fences, bars, covers, light barriers and similar.**

**It is absolutely necessary that fences and covers are sufficiently solid to resist any motional energy which might occur!**

- **The emergency off switch must be accessible.**
- **All movement must be carefully observed for possible danger during the commissioning procedure! Measures must be taken promptly, even against problems which only occur very rarely!**

– Remaining within the vicinity of drive motion for performing such tasks as removal or replacement of tools or workpieces.



- **Make sure the drives are standing still before working or entering the danger zone!**
- **Secure against unwanted operation by disconnecting the drives from the mains via the emergency-off switch (switching the power contactor or the master switch off)!**

– Remaining within the vicinity of drive movement for



- **the purpose of maintenance or service,**
- **cleaning, and,**
- **prior to long breaks in operation.**

**Switch all power to the machine off and secure it against being switched back on with the use of the master switch!**

– Care should be taken when operating high-frequency equipment or radios!



**Avoid operating such equipment in close proximity to the drive modules when control cabinets are open and while the drives are running.**

If high-frequency equipment with high transmission power is operated at an unfavorable angle in close proximity to the drive amplifier through the open control cabinet in the direction of the wiring inside the control cabinet, then, in all likelihood, under unfavorable conditions, an uncontrolled movement of the motor is possible unless a higher-ranking monitor has been activated!

Safety during handling and assembly.



- **Use proper assembly and transport devices! Prevent bruises and contusions!**
- **Use only the appropriate tools! Use prescribed special tools!**
- **Do not remain standing under hanging loads!**
- **Any liquids on the floor should be wiped up immediately to prevent slipping!**

### 6.1.2. Protection of Equipment and Machinery

INDRAMAT's electronic drive components have been equipped with extensive safety features and technically secured against overloads to the greatest extent possible.

The following guidelines should be noted to prevent improper handling:

Avoid faulty connections:

Check before switching on:

- Only connect voltages at the controller inputs that correspond to those listed in the datasheets and connection plans!
- Do not connect outputs to an external voltage!
- Check to ascertain that the 24V and the +15V output terminals have not mistakenly been connected!

## 6. Commissioning

---

- Check whether the low voltages, 5, +15, -15 and 24 volts, have been securely separated from the mains potential, have not been externally connected with or come into contact with the
  - power cables,
  - link circuit cables (L+, L-), or,
  - connections to the motor power cables!

They must be sufficiently insulated against each other!

Protection against external or high voltages.

- When **checking** the control cabinet wiring with outside voltages, make sure that no invalid voltages can reach the terminals of the electronic components!

Just to be sure, clamp the connections off before checking!

- High-voltage checks:

INDRAMAT's electronic drive components have been voltage-checked in detailed tests in accordance with VDE 0160. When checking the high-voltage of the electrical devices of industrial machinery and the control cabinet wiring, remove or clamp off all the electronic connections to avoid damaging the electronic components (applicable acc. to VDE 0113, EN 60204)!

The following INDRAMAT products are a part of the electronic equipment: TVM, TVD, TDM, TWM, TFM, TBM, TCM, KDV, TVR, KDR, KVR, KDS, KDW, KDA, KDF, RAC, DSC3 as well as the feedback and encoder electronics of the MAC motors and 2AD.

Protection against electrostatic loads.

Electrostatic loads endanger electronic components. Those bodies that can come into contact with connecting terminals, components and adaptor boards, must be discharged by grounding them.

- Before touching, discharge your own body by touching a conductive, grounded object (e.g., plain grounded metal).
- When soldering, ground the soldering iron!
- Place the parts and tools being used on a conductive, grounded surface.

Endangered parts, such as adaptor boards or programming modules, should only be stored and transported in conductive packaging.

Protecting the equipment against environmental influences

Adhere to the applicable information in the data sheets!

Especially for electronic equipment note:

Humidity

- Built-in units should not be directly subjected to humidity!
- Maintain the internal temperature of the control cabinet with at least 2 degrees C. above the outside temperature to avoid the formation of dew!

The following must especially be noted in the case where refrigerators are to be used in the control cabinets!

- Before commissioning, wait until any collected dew has dissipated, if,
  - the equipment was brought out of the cold into the warm operating area!
  - the location of operation has been moved!
  - if warm air is being blown into cold equipment!
- Permissible relative humidity at the built-in units drops with increasing ambient temperature!

At 40 degrees Celsius, the permissible relative humidity at the equipment for 30 days over a one-year period equals a maximum of only approximately 72%, at 20 ... 35 degrees C. approximately 95% (see DIN 40040 or DIN VDE 0160 E, December 1990).

Condensation water should only be permitted to occur occasionally when the unit is not being operated (DIN VDE 0160 E, December 90).

### Impure air

- Do not permit ambient air with suspended substances to get directly to the electronic equipment!
- Make sure that the ambient air has been sufficiently cleaned before letting it get to the equipment:
  - guide the entering air through sufficiently long air ducts!
  - use sufficiently good air filters!
  - mount such purification devices as ion-exchangers!
  - provide sufficient encasements by using gaskets!
- Do not leave the control cabinets open for longer periods in the presence of unclean air, if electronic equipment has been built-in!

Conductive and water-soluble contaminants and particles in the air are especially critical. With a humidity of 55%, these can already cause superficial currents on leakage paths and corrosion of the electronic parts and adaptor board. After longer periods of operation, it is possible that the machinery

- can be disrupted short-term, or,
- can completely fail

as a result of sneak currents, breakdowns due to surface conduction or corroded power connections.

### Temperature

- Maintain the ambient temperature recommended!

The following applies unless otherwise specified:

- storage temperature: -25...+55 °C,
- transport temperature: -25...+70 °C
- ambient operating temperature: 0...+45 °C.

Oscillation and Shock Stresses

- Do not, if possible, subject encased electronics to severe outside temperature changes when storing and operating! (This also applies to integrated motor feedback.)
- Do not subject electronic equipment, motors or drives to excessive oscillations and shock loads!
- Assemble mechanical parts in accordance with assembly guidelines. Do not use force!
- Use only the proper tools!

Protecting the machine

The machine is in danger when monitors are switched off during commissioning to test functions and make adjustments.

If, for example, the position-control loop of the NC controller is severed and the drive is run in the speed control loop, then, because of the limited paths of the linear axes, the machine is in danger when run

- over the limit stop, or,
- over parts that temporarily project into its working path.

Damage to the machines can be avoided by:

- permitting only properly trained personnel to enable the drives and modulate a speed set-point!
- always checking the safety clearances on the working path!
- securing emergency-off options via the limit switch and emergency-off switch!

6.2. Tools and equipment required for commissioning

The following tools are needed for commissioning:

- multimeters for d.c. and alternating voltages (moving coil instrument)
- set-point encoder with battery:

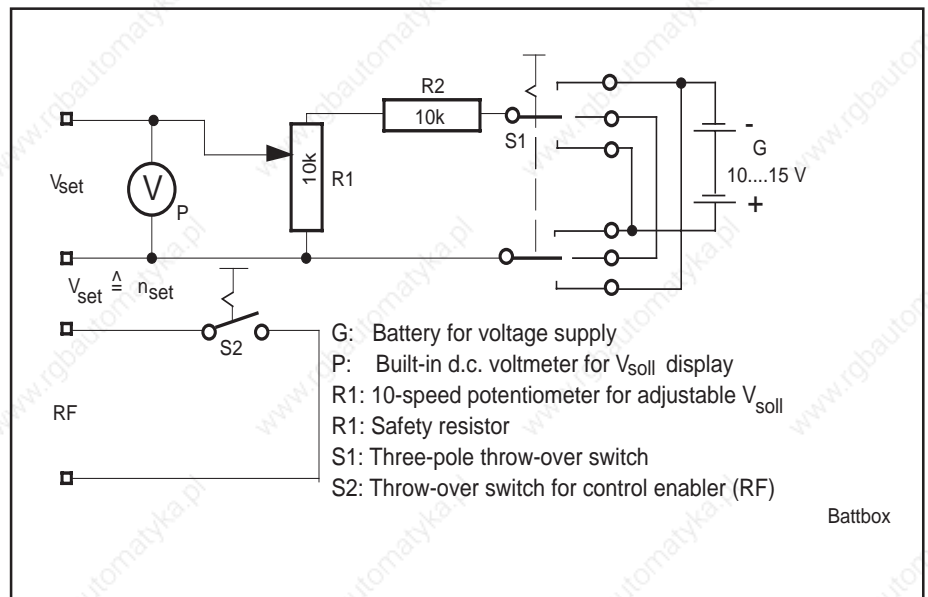

Figure 71: Set-point encoder box with battery.

### 6.3. Checks with the equipment switched off

As soon as all of the equipment has been connected, then all the following points are to be checked without applied power first.

#### 6.3.1. Mains connections conditions

1. The mains connections specified in the descriptions of the supply modules used – TVM, KDV and TVD – should be checked
  - at the voltage control connection, and,
  - at the power connection.

The phase coincidence of the mains auxiliary voltage requirements L1-L3 must be rechecked with the power requirements L1-L2-L3 in KDV2 and KDV3.

2. The terminal voltages of a transformer connected in series must be checked. Input and output should not be inverted.

The center ground of an auto-transformer should not be connected.

Mains without mains-related ground wires must, in any event, use isolating transformers of circuit class YynO. The center ground of the output side must be linked to the central zero point of the supply module and grounded there.

3. The fuses specified for the supply source used (listed in the supply module description) must be checked for correctness.

#### 6.3.2. Installed drive components

The following must be checked for every drive installed:

The data on the rating plate of the programming module on the lines „Contr“ and „Motor“ must be checked to assure that they agree with the data on the rating plates of

- the servo drive module („Contr.“), and,
- the MAC servo motor („Motor“), (see figures in Chapter 3.1).

Should the type designations not agree, then the correct MOD programming module must first be plugged into the servo-drive module; or, the correct motors and controllers need to be mounted. Otherwise, there is danger of damage.

#### 6.3.3. Instructions for replacing programming module MOD

- Neither the supply nor the servo drive modules should have power!
- All voltage supplying the supply module should, therefore, be shut off.
- Check to see whether all light-emitting diodes are off.
- Secure power against being turned back on while the programming module is being changed.

- Release the knurling screw and remove the programming module.
- Using the programming module rating plate, check to see whether the data on the new MOD programming module agree with the type of servo drive module installed and the typer of motor connected.



**Type designation for motor and servo drive module on the programming module must agree with that installed, otherwise, there is the danger of damage.**

- Plug the new programming module into the slot of the old one and tighten the knurling screw of the programming module.
- All power may now be turned back on.

Using potentiometers P1, P2 and P3, it may be necessary to compensate the input information for programming modules MOD2, MOD 4, MOD6, MOD14, MOD18, MOD20 and MOD22.

### 6.3.4. Wiring and line cross-sections

#### 1. Wire in accordance with connection plan:

Every line should be checked for short-circuits, interference, inversions, conductor cross-sections and proper connection, in accordance with INDRAMAT's connection plans.

Conductor cross-sections must be selected in a size sufficient to avoid conductor overload (see Guidelines DIN VDE 0113) in the presence of maximum ambient temperature and corresponding currents.

#### 2. Twist power wiring:

All lines on power connections must be twisted and have a sufficient cross-section:

- All lines to additional bleeder TBM must be twisted and have a cross-section of at least  $6\text{mm}^2$ , and of at least  $10\text{mm}^2$  twisted to additional capacities TCM.
- Adjacent drive modules are normally connected via the link circuit busbars. If this should not be possible in some cases, then the connection should use a twisted line which is as short as possible and has a cross-section of  $10\text{mm}^2$  (max. length approx. 1m).
- Link circuit throttles of the „GLD“ type should also be connected using twisted  $10\text{mm}^2$  lines which are as short as possible.
- The lines between the servo drive module and the MAC servo motor must either be a four-vein motor cable (3X phase, 1X ground), e.g., an INDRAMAT motor cable, or a twisted single line.

### 3. Grounding

Grounding must be carried out as described in Chapter 5.4.

- The protective conductor and grounding connections for the individual modular units must be radially routed from the center ground of supply module TVM, TVD, KDV or KVR, as indicated in the connection plan.
- The center ground of the supply unit must be connected to the ground conductor. The applicable protective measures for machine or plant must be taken into consideration.

Ground loops should be avoided, if at all possible, as interconnections could disrupt operations.

### 4. Bus connections X1:

The supplied flat belt bus cable, to be used for connecting the low-voltage bus plug X1, must be firmly plugged into every controller. The black lines of this cable must be arranged at the bottom.

The end plug for conductor monitoring, a part of the supply module accessories kit, must be plugged into the last modular unit (the one farthest away).

### 5. Shielding:

Check to see whether the guidelines listed in Chapter 5.5 have been adhered to or not. Particular attention must be given to mounting the shield of the set-point line and the motor feedback cable on the side of the servo drive motor.

The shield for the position encoder cable should generally be clamped to the NC.

In the event that shielded motor power cables are used, it is more practical to ground the shield on the motor plug, there where it enters the control cabinet on the control cabinet wall and on the servo drive module.

### 6. Ventilation requirements:

Check whether all lines and cables supplying the controller and motor fans have been properly connected.

### 6.3.5. Terminals and connecting points

Check all electrical connections for safe contact and firm fit on the terminals. It is important that all ground and shield connections have a reliable contact with a surface area which is as large as possible, as there will be interference otherwise.

Connections which have not been firmly clamped or screwed in, can occasionally disrupt operation and lead to the development of heat.





### 6.4. Power-up sequence (summary)

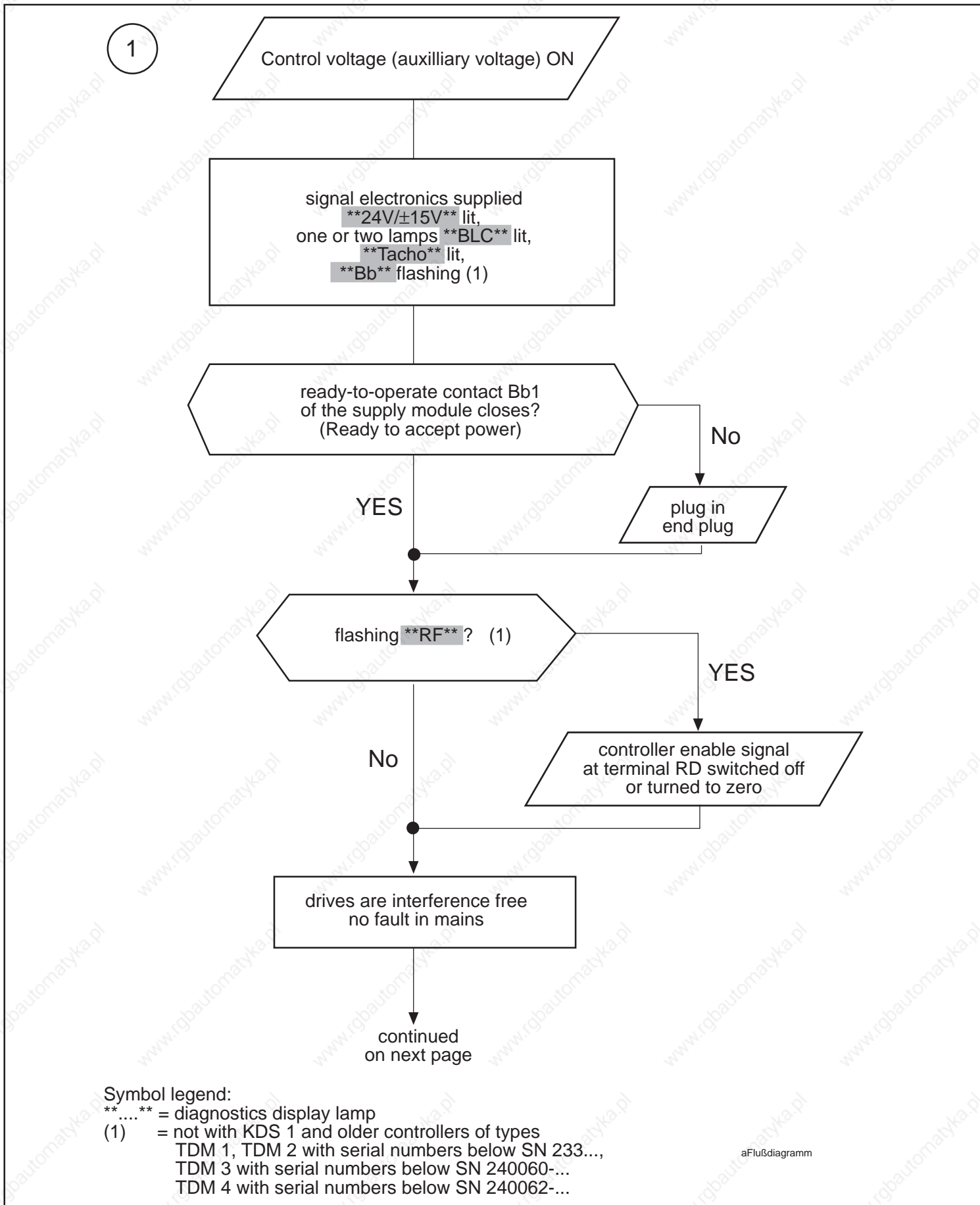
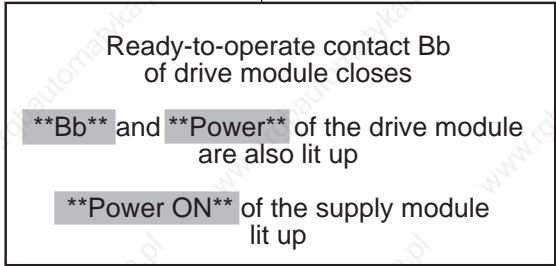
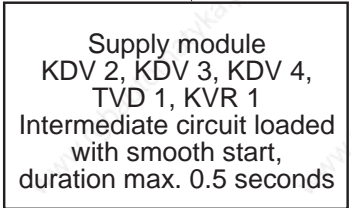
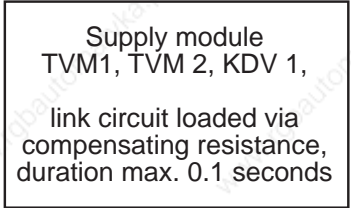
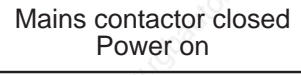
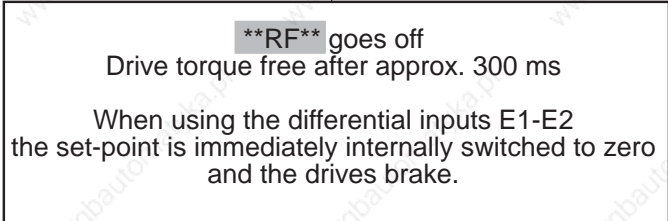
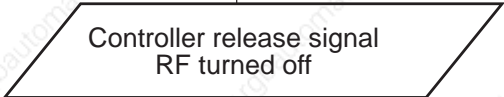
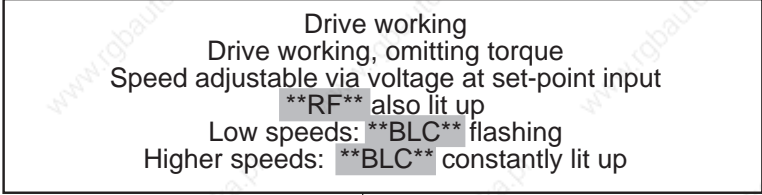
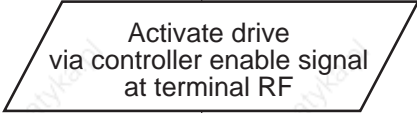

Figure 72: Power-Up Sequence

2



3



bFlußdiagramm

### 6.5. Checks with control voltage applied

Note:

(1) in the following text means:  
does not applied to KDS1 and older types

TDM1, TDM2 with serial numbers below SN 233 ...,

TDM3 with serial numbers below SN 240060-...

TDM4 with serial numbers below SN 240062-...

#### 1. Power separation

First, the power input fuses at the mains should be removed, or the power load between the driving equipment and the mains must be securely separated by some means.

#### 2. Switch-on control voltage

Switch-on control voltage for the supply module (also see power-up sequence, Chapter 6.4).

The green diagnostic display lamps

- „24V/+15V“
- 1 or 2 lamps „BLC1, BLC2, BLC3“, and,
- „tacho“

of the servo drive module light up as well as

- „Bb“ (1), which flashes.

If „RF“ (1) is blinking, then the drive has already been enabled by the externally connected voltage at terminal RF. To avoid any unnecessary start-up after switching on the power, power to terminal RF should be turned off. Lamp „RF“ then goes off.

If there are no problems, and, if the end plug has been plugged-in, then signal contact „Bb1“ of the supply unit closes.

#### 3. Measure voltage rates +15V, -15V, +24V at the supply module and servo drive motor. The 24V voltage rate can, depending upon mains under or over voltage, be either higher or lower in the TVM1.

#### 4. Fan:

It should be checked whether the fans

- in all modular units
- in all ventilated motors

are running and whether the air can enter and exit without obstruction.

#### 5. Blocking brake controller (if one is present):

- First check whether the blocking brake connecting voltage ranges between +21.6V and 26.4V (24V plus/minus 10%).
- The controller enable signal to activate the drive, and the signal to release the blocking brake or any other axis block, should be given **simultaneously**. It must definitely be checked to see whether the axis clamp releases upon input of signal.
- The mechanical brake must be released **prior** to running the drive (Fig. 73) to avoid wear and tear.
- The mechanical brake should not be actuated until **after the drive has stopped** to avoid wear and tear.

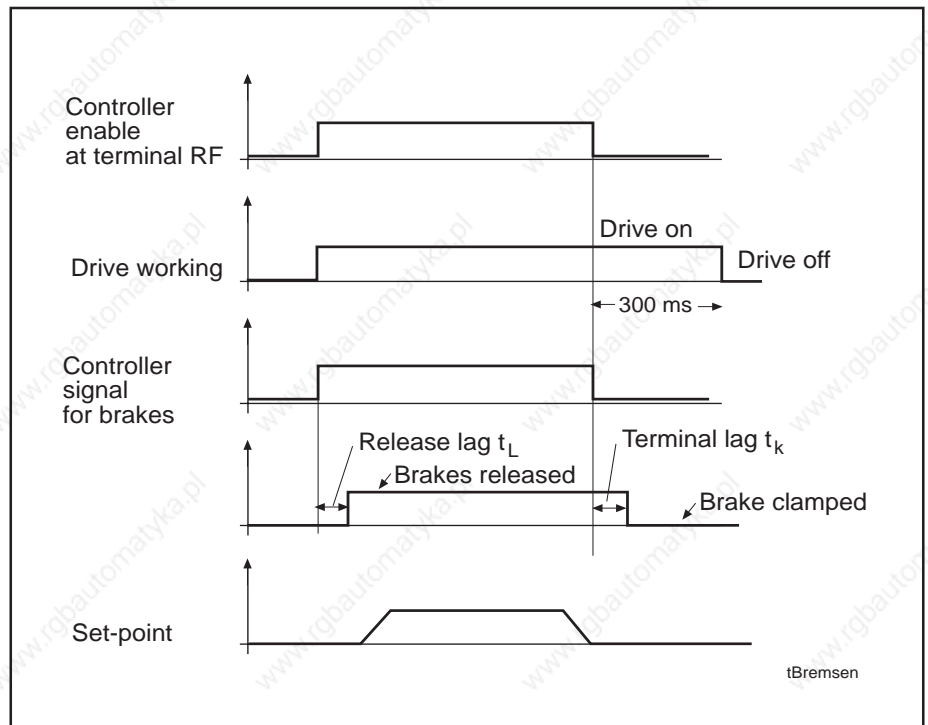

Figure 73: Intervals for clamping and releasing the blocking brake during operation. The  $t_K$  and  $t_L$  values are listed in the motor data sheets.

#### 6. Check link circuit short-circuit (if one is present):

The control switch must guarantee that the mains contactor does not close until the link circuit short-circuit contactor has been opened before hand at the correct time. Otherwise, there is the danger of damaging both the link circuit resistance and the contactor.

Using the link circuit short circuit to brake is not suitable for constant cyclical switching, but only for emergency off situations, or, if the limit switch has been overrun.

#### 7. Emergency-Off Functions

After hitting the emergency-off switch –

- safely open the power contactor on the mains,
- the link circuit short circuit should snap in, if it has been built in,
- the control enable signal at terminal RF must be switched off via a contact,
- the mechanical brake has to snap in, to the extent that it is needed.

This should be checked using the controller switch. (Recommendations can be found in the description of the supply module used.)

It must be guaranteed that the control voltage is maintained and remains on when power is shut off or in an emergency-off situation. This makes it possible for any occurring faults and interferences stored in the equipment to be afterwards read-off from the diagnostic display.

Only the master switch can completely shut down power to the machine.

8. Switch off master switch.
9. Re-secure mains fuses, or reconnect the power lines between the drive equipment and the mains. Clamp off the connecting wire for controller enable at terminal RF, just to be safe.

### 6.6. Checks after the power infeed has been connected.

Switch on controller and power voltage

As soon as the link circuit has reloaded itself via the mains contact to minimum level, and if no fault is present, then the following green diagnostic lamps must remain lit-up:

On the supply module:

- „power-on“

On the servo-drive module:

- „power“ or „PWR“, and,
- „Bb“
- the ready-to-operate contact „Bb“ of the servo-drive module closes. The drive is now ready to operate.

Measure link circuit power



**There are high voltages at the link circuit busbars, mains and motor power connections. It is, therefore, necessary, before accessing hot parts, to disconnect the equipment from the mains, just to be safe, and await the discharge time.**

Using a multimeter, check the link circuit voltage between connecting bolt L+ and L-. The values should range from 255 to 360 volts.

Maximum values approximately equal:

- 325 volts for mains nominal voltage, and,
- 360 volts for mains overvoltage,

if the drives have been shut down.

Should link circuit voltage be too high, then a wrong transformer or an improper connection could be the reason.

If it is too high, then this could be caused by a missing phase, an improper transformer or an incorrect connection on the transformer.

### 6.7. Check after the drive has been connected.



Before activating the drive, make sure that sufficient accident preventive measures have been taken, in accordance with Chap. 6.1. In addition, measures must be taken to avoid damage to the machine which could result from a sudden running of the drive.

Possible measures could, for example, be:

- Make certain that all safety measures necessary for commissioning are functioning properly.
- The emergency-off button is easily and readily accessible.
- Make certain that there is sufficient clearance between the safety limit switch and the limit stop, if a servo-axis is used. The path to the fixed stop should be as long as possible.
- If, in extreme cases, sufficient protection cannot be guaranteed when commissioning as a result of faulty drive movements, then the servo motor should be uncoupled from the mechanics with the first commissioning.

1. Switch controller voltage and power off. Clamp off all set-point cables and servo drive motors.
2. Attach set-point encoder:  
Connect controller enable at terminal RF and clamp on set-point at terminals E1-E2, according to the following figure.

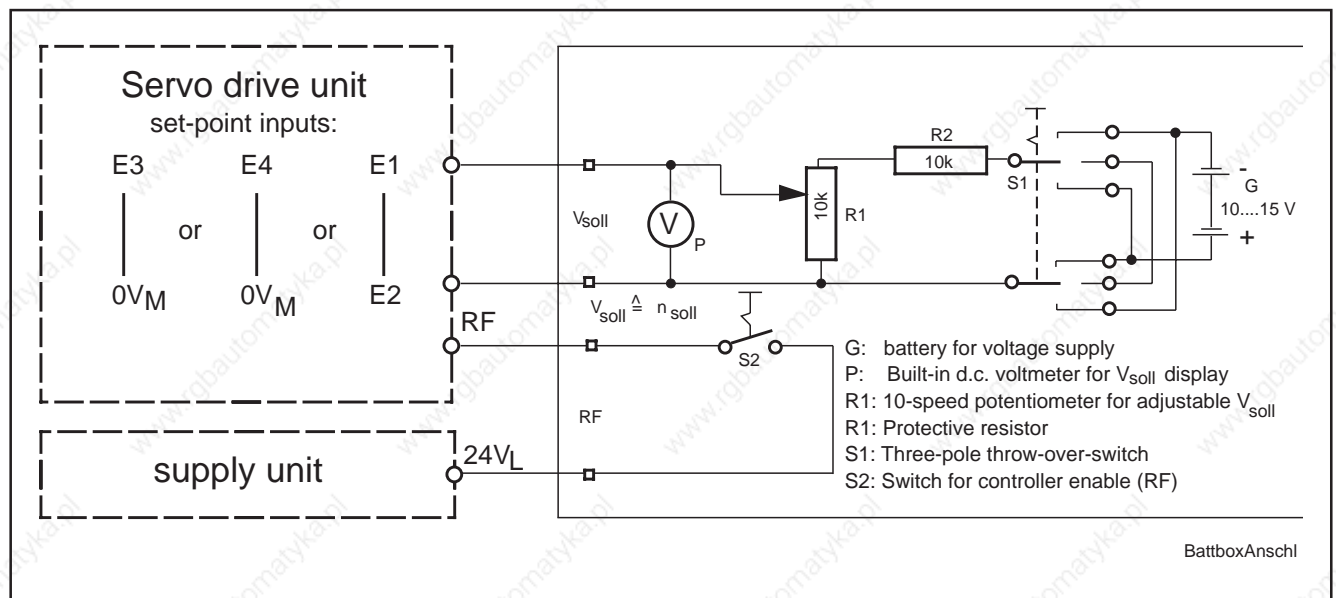

Figure 74: Connecting the set-point encoder.



- **Note on commissioning a master-slave (tandem) drive:**

In this case, the master and the slave drives are simultaneously commissioned. Both the speed set-point and the controller enable are connected to the master servo drive module. The slave drive is then simultaneously controlled by the master servo drive module, in accordance with the connecting planes outlined in Chap. 2.4.

Check whether the master and sequential drives are mechanically free of play and have been reliably connected to each other so that the slave drive cannot, as a result of the input set-point voltage, run up uncontrolled if the mechanical connection should loosen because of a fault.

This connection should be as rigid and as stiff against torsion as possible to avoid any soaring of the mechanics.



It is not possible to commission only the slave drive. The set-point, in this case, directly corresponds to torque so that input even of a very low set-point voltage to the slave drive module means that the slave motor will run up rapidly.

The torque of the master-slave drives must run in the same direction. This particularly applies to hanging axes. If they effect the mechanics in the opposite direction, then rotation direction of the slave drive must be turned around with a bridge ① at the feedback plug (see connection plans, Fig. 12 through 16).



- **Note on NC operation:**

In this case, the drive can also be commissioned via the NC, if there can be a reliable and controlled input of set-point and controller enable to the drive.

The initial commissioning of a new machine (prototype commissioning) makes the opening of the position control circuit and the uncoupling of the NC, in the event of a problem, a practical idea to better help restrict these problems and faults. This also, in particular, applies to drive oscillations, should these occur.

Safety guidelines for this area of application should be followed (see Chapter 6.1)

3. Switch off controller enable on the set-point encoder box and set to zero.  
Remain ready to immediately initiate an emergency-off, should the motor run uncontrolled.
4. Switch on control voltage and then power voltage (mains on).
5. Switch on controller enable. Set low set-point. The motor should rotate as indicated by set-point voltage.



6. Allocating set-point voltage and motor speed.

The input values can, in accordance with the information on the MOD programming module, be checked. A set-point input voltage of X volts equals a speed n of  $n_{max}$  and  $U_e$  are listed in the MOD programming module under column „Input/Rpm“. The formula to be used is:

$$n = \frac{n_{max}}{U_e} \cdot X \quad \text{in } \text{min}^{-1}$$

The motor can now be coupled to the machine if it was previously decoupled.

7. Stopping in an emergency-off situation:

The safety limit switch should be mounted with sufficient distance to the limit stop, and the cams should be checked for sufficient length.

Run the axes individually and at maximum speed onto the safety limit switch. Measure the stopping distance and check to see whether it was long enough. This task should be performed in both directions of a vertical axis.

8. Drift compensation:

No compensation is needed with torque-controlled or slave drives!

Using the adjustment screw, „ZERO ADJUST“, on the right-hand side at the bottom on the front, the zero-point drift can be set to speed zero, if a set-point of 0 volts is given at the corresponding plug-in terminal in the open position-control circuit. The speed drift is determined by observing axis movement or motor speed, or it can, if necessary, be measured at terminal Tsense.

6.8. Matching to the NC

The interaction of the NC, feed drive, position measurements and coupled-in mechanics in the position and speed control loops is outlined in Fig. 75 using the example of a direct measuring system.

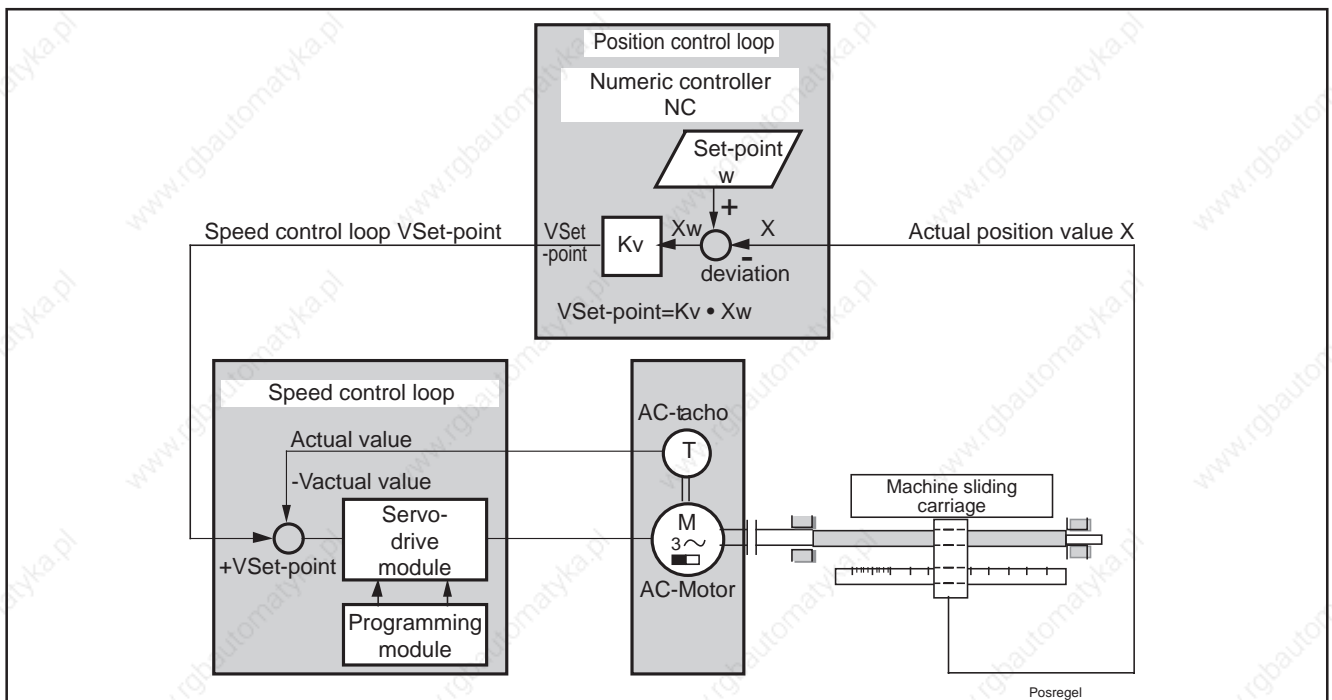

Figure 75: Position control loop with direct measuring system.

## 6. Commissioning

1. Operational sign of the path feed direction (machine coordinates)  
Operate the drive, at first, with the set-point encoder box. It is necessary to check whether the path feed direction indicated by the NC agrees with the actual direction of movement. If it does not, then it should be re-poled according to Chapter 2.1, page 17, in the direction of rotation.
2. Check the drift of the drive with zero speed set-point:  
If the axis moves with zero speed set-point, then using the potentiometer „ZERO ADJ“ on the front plate, set the rotation movement of the axis to zero with control cabinet end temperature.  
This should always be checked after initial commissioning and after the servo drive module has been exchanged.
3. Checking the position control loop:
  - Using the set-point encoder box, enter low **positive** speed set-point voltages of a few mV at the set-point input of the servo-module and run the axis.
  - The controller must emit a negative set-point voltage for the axis. The polarity of the actual position value must be changed, if this is not the case.
4. Switching and clamping off the set-point box.  
Connect set-point line and the controller enable from the controller to the servo drive module.
5. Check input weightings:  
The speed set-point input weightings of the servo drive module must be rated in such a way that maximum motor speed or maximum sliding carriage speed is achieved with 80 to 90% of maximum NC output voltage. This ensures that the position controller remains within the active range, even with minor overshooting in the NC output voltage.  
Input ratings can, if needed, be changed on the programming module in accordance with the data in Chapter 3.2.
6. Check set-point smoothing:  
The NC rated speed set-point values may not exceed the alternating current share of

$0.01 \cdot f \cdot U$  in Volt with

f: frequency of the superimposed pulsating component in kHz  
U: maximum value of the NC output direct voltage in volts

otherwise, stability problems will result.

7. Many numeric controls change their output voltages only gradually in agreement with the computers cycle time. Since the drives attempt to follow every set-point gradation of the step-function, the effects are
  - unnecessary motor power loss,
  - increased machine stress,
  - noise development during acceleration and braking, and,
  - machine vibrations during interpolation.

If such disruptive, harmonic vibrations should appear on the tacho signal - can be measured at terminal Tsense of the servo drive module - as a result of the set-point voltage emitted by the NC (step function) - can be measured at input of set-points at terminals E1-E2, E3 or E4 of the servo drive module - then it is possible to achieve a reduction in the oscillations by soldering a capacitor (set-point smoothing) on programming module MOD, in accordance with Chapter 3.2.

It should be, however, noted that a big capacitor can reduce the dynamics of the position control loops and thereby also make it less responsive (smaller Kv factor).

Determining factors:

$$C5 = \text{ca. } 0,15 \times T_{nc}$$

C5 Capacitor on programming module MOD in  $\mu\text{F}$   
 Tnc Station time of the set-point output of the NC in ms

### 7. Optimization the position control loop

An optimization of the position-control loop with linear movement is primarily achieved via the Kv factor in the NC:

$$K_v = V / X_w \quad \text{in} \quad \frac{\text{m} \cdot \text{mm}}{\text{min}}$$

V: speed in m/ min  
 Xw = Xset-point - Xactual: position deviation

This is increased until a stable and rapid response of the position controller is achieved (see information in NC User Handbook).

## 6.9. Checking Drive Configuration

These tests are recommended to the machine manufacturer when the drives are initially commissioned or with prototype commissioning. They serve to determine whether the drives have been sufficiently adjusted to meet the demands made by the construction of the machine or plant.

An oscilloscope with memory or an analogue recorder are needed for the measurements.

Measurements must be taken in both directions.

### 1. The stability of the control loop

The drive is operated using the set-point battery box, in accordance with Diagram 74. Should mechanical oscillations occur right after the servo drive is switched on via the controller enable while the equipment is still standing still or in the movement of the drives, then the mechanics have not been sufficiently secured against oscillations.

Possible causes:

- The coupling of the load mass to the motor shaft is too elastic. This causes resonance vibrations with the outside inert mass.

- The external inert mass is too great. The speed control loop becomes unstable. Generally, the ratio of the motor's own mass to external mass at the motor shaft equals 1:5.
- Instability of the machine's mechanics.
- Low frequency oscillations at position due to changes in the friction ratio which are not constant (stick-slip-effect).

These oscillations can be verified by measuring the tachometer signal at terminal T<sub>sense</sub> using either an oscilloscope or a recorder. Oscillations with low amplitudes require a fine adjustment of the oscilloscope or a measurement at terminal „MA“.

If the mechanics of the machine can definitely be excluded as the source, or if a structural alteration in the mechanics is too expensive, then a special drive optimization by changing the values of programming module MOD can bring about an improvement.

This can, however, also simultaneously bring about a deterioration in the dynamics at the machine axes. In this case, INDRAMAT's customer service should be consulted prior to changing the wiring of programming module MOD.

When calling in a problem to INDRAMAT's customer service, the following information is important:

- Mechanical construction of the coupling to the servo motor and the entire axes?
- Outside moments of inertia coupled in as relate to motor shaft?
- Continuous or intermittent oscillations and at what stage of operation?
- Size of the oscillation amplitudes of the voltage measured in volt peak-peak?
- Duration or frequency of vibrations?

### 2. Basic torque at different speeds.

Load moment can be measured at terminal „MA“ of the servo drive module, where the current set-point can be read, as the current consumption of the servo drive is a measurement for the given torque.

The corresponding current is calculated

$$I = \frac{UMA}{kMA} \quad \text{in A}$$

with  
kMA in V/ A from Chap. 10.2  
UMA in V measured at terminal „MA“.

A comparison of this Value I with the Value  $I_{(dN)}$  of the motor's permanent or rated current, to be found listed either on the table in Fig. 95 in Chapter 10.1., or on the rating plate of the motor, indicates the torque load of the servo-drive.

These measurements are to be taken at minimum and maximum feed speed, run during a later stage of operation during processing. The current measured at MA should not be greater than 60% of the motor's permanent current.

If the current measured should be greater, then the possible causes for an excessive basic torque, despite correct construction, can be:

- axis clamp not released
- mechanical jams at the drive axis
- insufficient lubrication
- increased adhesive or sliding friction at the carriage guides
- unfavorably adjusted weight compensation

The corresponding torque of motor current I of the measured voltage UMA at terminal MA can be calculated as follows:

$$M = k_m \cdot I = k_m \cdot \frac{UMA}{kMA} \text{ in Nm}$$

$k_m$ : Current-torque-constants in Nm/A  
 (from Fig. 95 of Chapter 10.1)  
 $kMA$ : from Fig. 96 in Chapter 10.2. in V/A

### 3. Rapid Return Motion Torque

Measure as described under 2.

The current at MA should not exceed 75% of the motor's rated current.

Should the current exceed this, then the possible causes for excessive rapid return motion torque, despite proper construction, can be:

- unfavorable hydraulic or pneumatic weight compensation
- excessive liquid friction in the gear-tooth system of an attached oil-bath gearbox
- a breakdown in the lubricating film of the sliding guide
- poor ball return in the nut of the ball roll spindle.

### 4. Adjusting weight compensation with vertical axes

The weight should be compensated so that the motor current input with the up and down motions of the axes always retains the same minimum value. The adjustment should be checked at feed and rapid return motion speeds.

### 5. Acceleration times

In this case, speed as a function of time (run-up curve) when accelerating and braking to the necessary speed, is recorded with

either an oscilloscope or a recorder. Speed output serves as the measurement signal (tacho) at terminal „Tsense“. The evaluation  $cw$  in  $V/A$  depends upon the type of motor and is listed in Fig. 95 of Chapter 10.1.

The corresponding acceleration moment, or current can simultaneously be recorded at terminal „MA“. (The evaluation in  $V/A$  is dependent upon the servo drive module and can be found in Chapter 10.2).

When operating the NC in controlled position, the torque should only reach its maximum value in the first phase of the acceleration/braking procedure, while remaining below maximum value over the remaining period of time in order to maintain sufficient reserves and avoid overshooting its position.

Acceleration and braking times must be measured and compared to the design data.

### 6. Controlling Feedback Energy

- Accelerate all the drives connected to the supply unit to maximum speed and then initiate an emergency off.

A shutdown of the power section via the ready-to-operate contact Bb1 of the supply unit cannot take place.

- Run the drives for at least 15 minutes in an **operative** load cycle during which the highest mean braking energy of all drives can be expected.

In this case as well, the power section should not be switched off via the ready-to-operate contact Bb1 of the supply unit.

Should a switch off nonetheless occur in either of the two cases, then the supply lay-out must be corrected (see supply lay-out description). It is possible that a different supply module or an additional modular unit (TBM or TCM) is required. This depends upon the drive type connected.

## 7. Fault-Finding and Diagnostics

In the event of a problem within the machine or the facility, it can be advantageous to proceed in accordance with the following steps to quickly eliminate faults and resume operation:

1. Determine nature of problem. (Can improper operation or incorrect installation be eliminated from the start?)
2. Follow the effects of the fault and limit the source of the fault.
3. Determine direct cause of fault, defective part.
4. Correct error and control operation.

### About Step 1:

The assumption is made that the checks on the drive equipment, mounting and installation, as outlined in Chapters 6.2 through 6.4, have already been performed. This is generally the case with an already constructed and operating machine.

### About Steps 2 through 4:

INDRAMAT's drives offer definite advantages when searching for and eliminating problems. Long-term searches for problems in individual units and repairing the drive components of the individual machines are not acceptable because of the loss in production that this loss in time represents.

The diagnostic displays and the message signals at the interfaces between drive and controller (terminal strip on the drive module) make a to-the-point and effective problem search possible.

The exchange of individual compact drive components such as supply module, drive amplifier, motor or cable permit a speedy and problem-free elimination of the problem and resumption of operation without lengthy mounting and adjustment work.

Programming modules MOD, optimized and ready-to-use from the factory, make an adjustment-free exchange possible.

### 7.1. Construction of the monitoring system within the modules (Fig. 71)

In the event of a problem in the drive system, the ready-to-operate command is lifted and the at-zero-potential ready-to-operate contact Bb1 in the supply module and Bb in the drive module open.

The opening of the Bb1 contact must achieve, via the controller,

- an immediate mains separation (mains contactor must release),
- the drive's mechanical brakes, (if present), snap in,
- the activation of the link circuit short circuit as an additional electrical brake for the MAC servo motors, (if present).

An overview in Figure 72 of the internal drive monitor offers insight into the effect of an internal fault.

A fault in the **supply unit** is signalled to the drives via the internal „UD“ message X1.1 of the plug-in terminal X1 between the modules. The connected drives decelerate to speed zero and are then subsequently locked (after approximately 300 ms), i.e., switched torque-free.

The same thing occurs with a fault in the **servo drive module**. The drive fault is then signalled to the supply module via the BB return signal cable X1.2 of the bus X1, where it permits the Bb1 signal contact to drop.

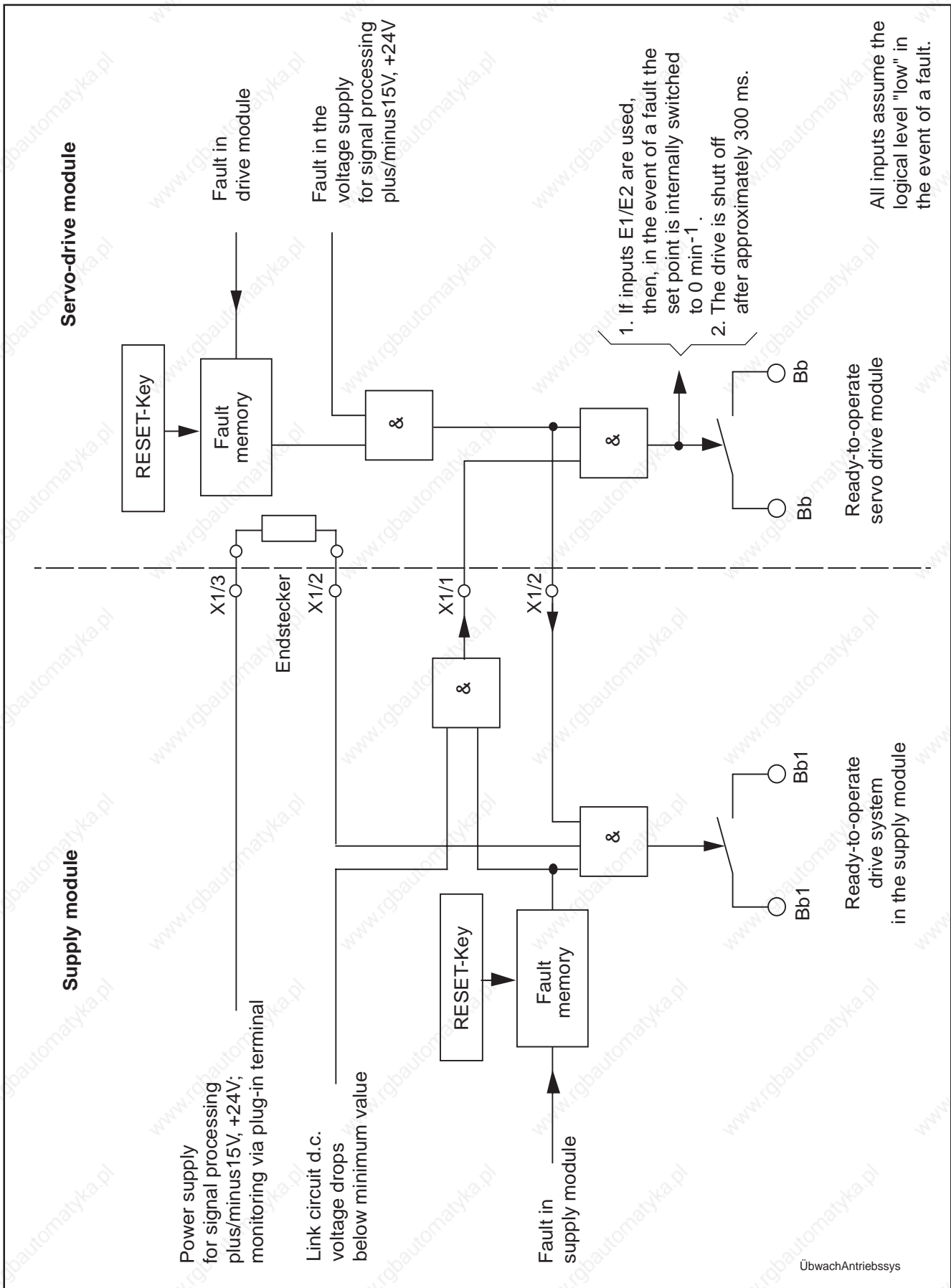

Figure 76: Internal monitoring of the drive system supply module-drive module



## 7.2. Effective fault-finding



**The safety guidelines as outlined in Chapter 6.1 must be noted when troubleshooting in the machine.**

### 7.2.1. Possible causes of malfunctions, general

Faults in the machine or the facility can have very different causes. Drive movements can be effected by faults in the following areas:

1. Mechanical coupling or transmission elements at the motor shaft (loose, elasticity, conversion, moments of inertia, jams, friction)
2. Mechanical stability of the machine's frame (rigidity)
3. Position measuring systems, position encoder
4. Numerical control (NC, CNC)
5. Other controllers (SPS)
6. Driving systems with
  - supply modules
  - drive modules
  - motor cables
  - motor with feedback electronics
7. Mains connections with transformers, throttles and controller loops with contactors and auxiliary relays.
8. Conditions of the electrical mains
9. Electromagnetic influences caused by equipment or machinery working with frequencies higher than the mains frequency, or the use of large amounts of energy.

### 7.2.2. Fault messages at the terminal strips

The machine user should first check the fault messages at the terminal strip (cross-section) of the module in the event of a problem. These signals can easily be evaluated directly at the controller and are displayed on the control panel.

There is an overview of interface signals in Fig. 80.

The **Bb1 contact** of the supply module is integrated, in accordance with the recommended controller description, to the supply unit in the emergency-off loop.

The **Bb contact** of the servo drive module for activating the mains feed is also then used if the commissioning current needs to be restricted with the use of resistors (only applies to supply modules TVM1, TVM2 and KDV1).

In the presence of either a mains fault or a mains failure, or if emergency off is activated, then this fault message is generally transmitted to the drive module via cable X1.1. There it brings about a deceleration of the connected drives and the internal switching off of the controller enable after approximately 300 ms.

It is possible in the case of some of the supply units (not with TVM1, TVM2 and KDV1) to have the NC, with a clamped on **NCB bridge**, brake the attached drives in either an emergency off situation or with a power failure. This obstructs the transmission of the signal via X1.1.

## 7. Fault-Finding and Diagnostics

The prerequisite, in this case, is that the occurring braking energy of all the mounted drives is greater than the energy expended by the motor for the feedback action conducted by the NC and the link circuit output for the signal electronics. It is not permissible to conduct the controller enable over the auxiliary contact of the mains contactor as it would, in this case, be immediately shut down.

It must always be guaranteed, even with a closed NCB bridge, that the drives can be shut down in the event of a fault - even in the NC.

Drive Module (A fault in the drive system means a fault in the supply module, drive module, cable or motor.)			
Terminal Designation	Terminal Strip Output	Meaning of Message	Eliminate Fault
Bb	Contact closed	* The drive is ready to operate. No faults in drive module. Diagnostic lamp „Bb“ lit up.	
	Contact open	* No power, or there is interference, or  * Fault in drive system	* Check power connection and supply module.  * Check <b>diagnostic display</b> on the front plate of the modular unit acc. to Chapter. 7.3.
TÜ (only TDM 3, TDM 4, TDM 6, TDM 7)	Open collector-output open (high-impedance)	* No fault	
	Open collector-output at 0 volts (low-impedance)	* Equipment temperature too high: If drive load is not reduced within 30 seconds, the system will be shut down. Diagnostic lamp „TÜ“ is lit up.	Reduce drive load. Contact TÜ can be evaluated via an external controller.
TÜ (only KDS)	Contact closed	* No fault	
	Contact open	* Equipment temperature too high: If drive load is not reduced within 30 seconds, the system will be shut down. Diagnostic lamp „TÜ“ is lit up.	Reduce drive load. Contact TÜ can be evaluated via an external controller.

Figure 77: Summary of the drive module messages issued at the terminal strip.

## 7. Fault-Finding and Diagnostics

Supply module (fault in drive system means fault in supply module, drive module, cable or motor.)			
Terminal Designation	Terminal Strip Output	Meaning of Message	Fault elimination
Bb1	Contact closed	* Ready to shutdown power. No fault in driving system.	-
	Contact open	* Controller voltage/mains auxilliary voltage lacking at supply module or * Fuse down * Fault in drive system  * TVM only: supply module defective due to excessive deceleration energy (ballast resistance overloaded)——>	* Plug-in end terminal X1 * Control <b>diagnostic display</b> on the front plate of the modular unit, acc. to Chap. 9.2.3. * Check fuses.  * Exchange supply module
BVW (only KDV 2, TVD 1)	Contact closed	* No fault	
	Contact open	* Mean time of drive deceleration too high.  by an additional 25%, then terminal Bb1 will open.)	* Reduce speed, * Initiate emergency off func- (If mean load increases  * Take a break. (Can be recognized and executed by means of external controller.)
TVW (only KDV 3, KDV 4, TVD 1)	Contact closed	* No fault	
	Contact open	* Too much power run on average with the mounted drives; temperature in power section too high. * Shutdown via terminal Bb1 in 30 seconds; diagnostic display lamp „TÜ“ will light up.	* Reduce drive load within the 30 seconds or run free and shut down. (Can be recognized and executed by external controller.)
UD (only KDV 2, KDV3, KDV 4, TVD 1)	Contact closed	* Mains feed on supply module working.	
	Contact open	Mains fault present: * Mains failure, phase failure * Voltage too low * No right rotational field (only applies to KDV3 and KDV4)	* Check mains feed * Check diagnostic display on the supply module, acc. to Chap. 7.3 * The NC can be shut down during operation when UD terminal open, if NCB bridge on terminal strip is closed. If NCB bridge is open, then shut down occurs internally via the drive by internal switching of set point to zero.

*Figure 78: Summary of the drive module messages issued at terminal strip*

## 7. Fault-Finding and Diagnostics

Terminal Designation	Terminal Strip Output	Meaning of Message	Fault Elimination
NH (only KDV 2, KDV 3)	Open collector-output open (high-impedance)	Mains auxiliary power properly applied to mains input terminal of the supply module.	
	Open collector-output at 0 volts (low-impedance)	No mains auxiliary power at terminal L1-L3. Diagnostic lamp „AUX: VOLT“ lit up * Fans simultaneously not being supplied. Should mains auxiliary fail for longer periods of time during operation, then the motors will shut down after a specific length of time because of overtemperature. * Power cannot be turned on until mains auxiliary power is applied.	* Check the mains auxiliary power connection * If mains auxiliary power applied to terminals L1-L3, then the supply module is defective.
HSM (only KDV 4)	Open collector-output at 0 volts (low-impedance)	Mains auxiliary power properly applied to mains input terminal of the supply module.	
	Open collector-output open (high-impedance)	No mains auxiliary power at terminal L1-L3. Diagnostic lamp „AUX: VOLT“ lit up * Fans simultaneously not being supplied. Should mains auxiliary fail for longer periods of time during operation, then the motors will shut down after a specific length of time because of overtemperature. * Power cannot be turned on until mains auxiliary power is applied.	* Check the mains auxiliary power connection * If mains auxiliary power applied to terminals L1-L3, then the supply module is defective.
K1NC (only TVD 1)	Contact closed	Internal mains contactor released	Check unit controller
	Contact open	Internal mains contactor attracted	
K1NO (only TVD 1)	Contact closed	Internal mains contactor attracted	Check unit controller
	Contact open	Internal mains contactor released	

*Figure 79: Overview of drive module messages issued at terminal strip.*

### 7.3. LED Diagnostic Displays

If the fault cannot be located using the messages received at the terminal strips, then the diagnostic displays on the front side of each modular unit, beginning with the supply module, need to be checked. This can be quickly accomplished by using the figures in Chapter 9.

The most practical thing to do **first** is to check to see whether the light emitting diodes are displaying the condition „working“, as indicated in these figures. In the presence of a malfunction, the green lamps generally light up, while the red lamps should be off.

#### Clearing a Fault:

A **reset-key** makes it possible to clear all stored fault messages without having to shutdown the mains auxiliary power/control voltage on the supply module. It is located on the front on the right hand side at the top above the diagnostics display.

The fault messages are automatically cleared and reset after the control voltage has been turned back on.

#### 7.3.1. Diagnostic Displays on the Power Supply Modules

If the diagnostic displays on the supply or driving modules indicate a fault, then the following measures can be taken individually:



**The diagnostic displays are only valid if lamp „24V, plus/minus 15V“ is completely lit up.**

Power o. k.



With fault → off

No power or fault present.

Possible fault causes and measures:

- Link circuit throttle connection of the supply module not allocated (does not apply to TVM 1 and 2).
  - Check whether the throttle on the link circuit throttle connecting terminals 1L+, 2L+, 1L-, 2L- has been properly attached, or whether a wire strap has been clamped on.
- No mains power
  - Check three-phase mains power connection (Look for fault between mains connection and supply unit.)
  - Check the mains contactor control
- Mains voltage too low
  - Test mains power at connecting terminals L1, L2, L3 of the supply module.
  - Incorrect transformer connection or fault in mains
- Mains power phase missing
  - Check and re-measure 3-phase mains power at the supply module
  - Check link circuit short-circuit
  - Check mains fuse

- Only applies to KDV2, 3 and 4:  
No right rotational field present (fault only occurs the first time the machine or the drives are connected to the mains).

→ Check rotational field direction at connecting terminals L1, L2, L3 of the supply module (e.g., with the use of rotational field measuring equipment, or the succession of phases with an oscilloscope). Exchange leads L1 and L2 on the supply module if there is no right rotational field.

Absolute attention must be paid that mains auxiliary power connections L1, or L3 remain connected inphase to power connections L1, or L3 of the supply module KDV, in accordance with connection plans.

- Supply module defective
  - Remove intermediate circuit busbars and bus cable X1 between the supply module and the driving module, then repeat the above check. If no fault can be found now, and the LED „power OK“ of the supply module is lit up, then the fault is in the connected drive modules.
  - Exchange supply modules.

**+24V, ±15V**  

(Only units:  
TVD 1, KDV 3, KDV 4)

With fault → off

The control voltage for the signal electronics is faulty, or exceeds tolerance (the values should range between plus/minus 15V : 14.75 ... 15.25 volts, 24V: 22.3 ... 32 volts).



**Should this LED flash or not light up, then all other diagnostic messages are invalid!**

Possible fault causes and measures:

- Only applies to KDV3 and KDV4:  
No mains auxiliary power at supply module input  
→ Check mains connection for auxiliary power
- Short-circuit in the signal electronics in at least one of the connected drives (in drive module, feedback cable, or motor feedback).  
→ Remove the individual line connections (bus connection X1, feedback cable, wiring on the terminal strips) and then  
→ measure the 24V, plus/minus 15V voltages at the connection points or terminals and, in this way, begin to limit the fault (generally short-circuit).
- Maximum load of the control voltage plus/minus 15 V or 24 V is being exceeded.  
→ Check current load via the connected drives in accordance with the data sheet (current input).
- Only applies to KDV3 and KDV4:  
Defective unit fuse in the supply module  
→ check fuses,  
→ if fault remains, find the fault on the 24 volts or in the fans, and eliminate it,  
→ put in new fuses.

**AUX. VOLT**

(Only units:  
KDV 2, KDV 3, KDV 4)

With fault → off

No auxiliary mains power at terminal L1-L3 and fans not working (risk from excessive temperature).

Possible fault causes and measures:

- Mains failure
  - Nothing needs to be done
  - Drives will continue only as long as there is sufficient power in the link circuit
- Supply module fuses defective
  - Check fuses,
  - See LED "24V, +15V"
  - Insert new fuse
- Supply module fuses defective (Line break, circuit contact defective)
  - Check connection and controller of the mains auxiliary voltage between mains and supply module.
  - Do not run drives for longer periods of time at full load because fan switched off.
  - Eliminate fault.

**MAINS FAULT or  
MAINS O.K.**

(Only units:  
TVD 1, KDV 4)

With fault → off

Mains fault displayed.  
Mains power disrupted or improperly connected  
(voltage too low, phase missing, no right rotational field)

Possible fault causes and measures:

- No mains voltage
  - Measure whether there is mains voltage at connecting terminals L1, L2, L3 of the supply module. (Look for fault between mains connection and supply unit.)
  - Check controller of the mains contactor.
- Mains voltage too low
  - Measure mains voltage at connecting terminals L1, L2, L3 of supply module.
  - Improper transformer connected or fault in mains.
- Only applies to KDV4:  
Right rotational field present (fault only occurs the first time the drives or the motor connected to the mains).
  - Check rotational field direction at connecting terminals L1, L2, L3 of the supply module (e.g., using rotational field measuring equipment or the succession of phases with an oscilloscope).
  - If there is no right rotational field, then exchange lines L1 and L2 on the supply module.

- No phase
  - Re-measure the three phases of the mains connection voltage
  - Check mains connection
  - Check mains fuses
- Supply module defective
  - Separate link circuit busbars and bus cable X1 between the supply and drive modules and repeat the above test. If the mains voltage is working after the above test has been run and the LED „power OK“ of the supply module is off, then the supply module is defective. If „power OK“ is lit up, then the fault is in the connected drive modules.
  - Exchange supply modules

### OVERVOLTAGE or OVERVOLT FUSE

red

(Only units:  
TVM, TVD 1, KDV 1)

With fault → on

Temperature of the loading resistance (bleeder) too high or power section is defective.

After the fault has been eliminated, press the black reset key on the front above the diagnostic display to re-start.

Possible faults and measures:

- Mains voltage too high:
  - Re-measure the voltage at terminals L1-L2
- Only applies to TVM, TVD 1: Incorrect wiring of the additional bleeder module TBM
  - Check wiring in accordance with connection plan
- Only applies to KDV1: Fan not running or air inlet and outlet obstructed
  - Check the fan behind the heatsink
  - Check fan fuses
  - or
  - Internal temperature of control cabinet too high
  - Improve ventilation/cooling of control cabinet
- Deceleration energy of all drives too high:
  1. The fault does not occur until after **several** deceleration procedures. (The deceleration energy feedback over a mean period is too high.)
    - Check the load and processing cycles of the drives and reduce if necessary.
    - Only applies to TVM: An additional bleeder module TBM or additional capacitance TCM must be additionally installed.
  2. Fault already occurs after the **first** drive deceleration (generally in an emergency-off). (The deceleration energy occurring short-term and feedback is too high.)
    - Only applies to TVM: An additional bleeder module TBM must be installed.
    - Reduce energy content of the drives (moment of inertia or max. speed).



- Only applies to TVM, TVD 1: Additional bleeder module TBM defective  
→ Exchange additional bleeder module TBM
- Supply module defective  
→ exchange supply module

**BLEEDER OVERLOAD**



(Only units:  
TVD 1, KDV 2, KDV 3, KDV 4)

With fault → on

Deceleration energy of all drives too high (especially in emergency-off) or the supply module is defective.

After the fault has been corrected, press the black reset key on the front of the diagnostics display to re-start.

Possible fault causes and measures:

- Mains voltage too high  
→ Re-measure voltage at terminal L1-L2
- Fan not working or air inlet or outlet obstructed  
→ check fan  
→ check fan fuses
- Control cabinet internal temperature (ambient temperature) is too high  
→ improve ventilation/cooling in control cabinet
- Only applies to KDV2 and TVD1: deceleration energy of all drives too high
  1. Fault does not occur until after **several** drive decelerations. (The deceleration energy feedback over a mean period of time is too high.)  
→ Check the load and processing cycles of the drive and reduce, if necessary.
  2. Fault already occurs after the **first** drive deceleration (generally in emergency-off). (The short-term deceleration energy feedback is too high.)  
→ An additional TBM bleeder module must be installed.  
→ Reduce the energy content of the drives (moment of inertia or max. speed).
- Supply module defective  
→ Exchange supply module

**EARTH CON.**



(Only units:  
KDV 2, KDV 3, KDV 4)

With fault → on

Ground leak in the supply module, drive module, cables, motor or power wiring.

After fault has been eliminated, press black reset key on front of diagnostics display to re-start.

Possible fault causes and measures:

- Check all drive modules for fault message „BS“ to immediately determine a drive with a defective drive module, cable or motor.

- Ground leak in supply module
  - Remove intermediate circuit busbars.  
If fault should occur again, then the supply module is defective. If it does not, then the ground leak is in the connected drive components.
  - Exchange supply module
- Ground leak in the power wiring
  - Visual check of all connections and terminal connections (e.g., intermediate circuit busbars L+, L- cable connection A1, A2, A3 motor terminal box) for earth contact as well as all lines for insulation failure.
- Ground leak in a motor
  - Remove all motor cables at the motors. If no ground leak occurs, then ground leak is in motor.
  - Exchange motor
- Ground leak in the motor cable or drive module
  - Clamp off motor cable of the drive modules. If ground leak does not occur, then the motor cable is defective. Otherwise, there is probably a ground leak in the drive module.
  - Exchange motor cable
  - Exchange drive module

### OVERCURRENT

red

(Only units:  
TVD 1, KDV 3, KDV 4)

With fault → on

Excess current or short-circuit in the power section of the supply or drive modules or in the motor.

After the fault has been eliminated, press the black reset key on the front of the diagnostics display to switch back on.

#### Possible Faults and Measures:

- Check all drive modules for fault message „BS“ to quickly find a drive with defective drive module, cable or motor.
- Short-circuit at connecting terminals 1L+, 2L+, 1L-, 2L- of the supply module for the link circuit throttle.
  - Check whether the link circuit throttle or the wire strap at this terminal has been properly connected in accordance with the connecting plans.
- Fault only occurs when decelerating the drives: mains inductance too high.
- Programming module MOD does not fit into the drive module - motor combination
  - Check the rating plate information of all drives with the respective drive module and motor type to see whether they match.
- Short-circuit in the supply module
  - Remove link circuit busbars from supply module. If fault occurs again, then supply module is defective. Otherwise, the short-circuit is in the connected drive components.
  - Exchange supply module.

- Short-circuit in the power wiring
  - Visual check of all connections and terminal connections (e.g., link circuit busbars L+, L-, cable connections A1, A2, A3) as well as all lines for insulation damage.
- Short-circuit in a drive module
  - If the red LED „BS“ of a drive module should also light up, then the fault, in the case of this drive, is in the amplifier, motor or cable.
  - Clamp off the motor cables on drive modules at A1, A2, A3. If a short-circuit should still occur, then the drive module is defective. Otherwise, the short is in the cable or motor.
  - Exchange defective drive module
- Short-circuit in a motor cable or the motor
  - Disconnect the motor cable at the motors. Bridge thermostat contact. If short occurs now, then the fault is in the motor cable. Otherwise, the motor has an interturn short-circuit.
  - Measure motor inturn resistance and exchange defective motor.

**TEMP. FAULT**



(Only units:  
TVD 1, KDV 3, KDV 4)

With fault → on

Shutdown due to excessive temperature. The temperature pre-warning via contact TVW was ignored.

After the fault has been eliminated, press the black reset key on the front of the diagnostics display to re-start.

Possible fault causes and measures:

- Fan not working, air inlet and outlet obstructed or the heatsink is dirty.
  - Check fan
  - Check fan fuse
  - Clean heatsink, if necessary.
- Inside temperature of control cabinet (ambient temperature) too high
  - Improve control cabinet ventilation/cooling
- Overall efficiency of connected drives too high
  - Check the overall efficiency of the drives, a second supply module may be needed.
- Supply module defective
  - Exchange unit

**Bb1 CLOSED**



(Only units: TVD 1)

With fault → off

Ready-to-operate contact is open because there is a fault in the supply module or in drive.

After the fault has been eliminated, press the black reset key on the front of the diagnostics display to re-start.

Possible fault causes and measures:

- Fault in supply module:
  - Check the other diagnostics lamps to see what fault is present. The green lamp „+24V/+15V“ must be lit up. All red LED's must be off.
  - Exchange supply module
- Fault in drive module:
  - Check all diagnostic displays on the front of all drive modules, to see which fault is present. All red LED's must be off.

### 7.3.2. Diagnostic Displays on the Drive Modules



**The diagnostic displays are only valid if the lamp „24V, plus/minus +15V“ is lit up**

- (1) = does not apply to KDS1 and the older units of the types TDM1, TDM2 with serial numbers below SN 233 ....., TDM3 with serial numbers below SN 240060-..., TDM4 with serial numbers below SN 240062-...

**+24 V, ±15 V**



With fault → off

Control voltage for signal electronics disrupted, or outside of tolerance (the values must range as follows: plus/minus 15V: 14.75 ... 15.25 volts, 24 V: 22.5 ... 32 volts).

After the fault has been eliminated, press the black reset button on the front of the diagnostics display to re-start.



**All other diagnostic messages are invalid if this LED is either flashing or lit up!**

Possible fault causes and measures:

- No mains auxiliary voltage at input of the supply module
  - Check mains connection (open circuit, switching contact defective)
  - Check connection and controller of the mains auxiliary voltage between mains and supply module.
- Loose or defective bus cable connection X1
  - Bus cable X1 must be firmly plugged in, exchange if defective.
- Short-circuit in at least one of the connected drives (in drive module, feedback cable, or motor feedback)
  - Remove the individual connections (bus connection X1, feedback cable, wiring to the terminal strip), and then,
  - measure the 24V, +15V voltage at the connecting points of the terminals in an effort to locate the fault (generally short-circuit).
- Response during operation: The maximum load of the control voltage +15 V or 24 V is being exceeded.

- Check the current load from the connected drives in accordance with the data sheet (current consumption).
- Defective fuse in supply module
  - Check fuse
  - If fault still present, locate overload at the 24 volts or in the fans and eliminate.
  - Put in new fuse

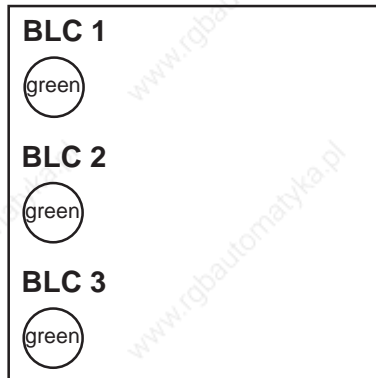

Rotor position signals:  
 Only one or two diagnostic lamps should light up **simultaneously** during a shutdown or when the speed is low. The lamps blink at low speed. All three lamps appear to be lit up simultaneously at high speeds.

Fault:  
 A fault is present if all three lamps are **simultaneously** lit up during shutdown or with low speeds.

Checking procedure:

- Switch power to mains off (disconnect mains contactor). Switch only mains auxiliary voltage/control voltage on at supply module.
- Disconnect motor cable from motor.
- Release brakes.
- Pull motor shaft through by hand and check all 6 states for correctness, in acc. with Fig. 80.

Possible fault causes and measures:

- Faulty connection of the feedback cable to the drive module
  - check connection
- Fault in motor feedback cable
  - exchange cable
- Fault in the motor feedback
  - measure plus/minus 15 volts voltage of the motor feedback
  - exchange motor
- Fault in drive module
  - Exchange unit



With fault → off

Interference in tacho signal or signals BLC1, BLC2, BLC3 (1).  
 After the fault has been cleared, press the black reset key on the front of the diagnostics display to re-start.

Possible faults causes and measures:

- Faulty connection or break in the motor feedback cable
  - check feedback connection
  - exchange feedback cable

## 7. Fault-Finding and Diagnostics

- Excessive motor speed
  - check feedback connection
  - exchange feedback cable
- Motor feedback defective
  - exchange motor
- Servo drive module defective
  - exchange unit
- Fault in BLC signals
  - check BLC signals, as described in LED „LBC1, BLC2, BLC3.

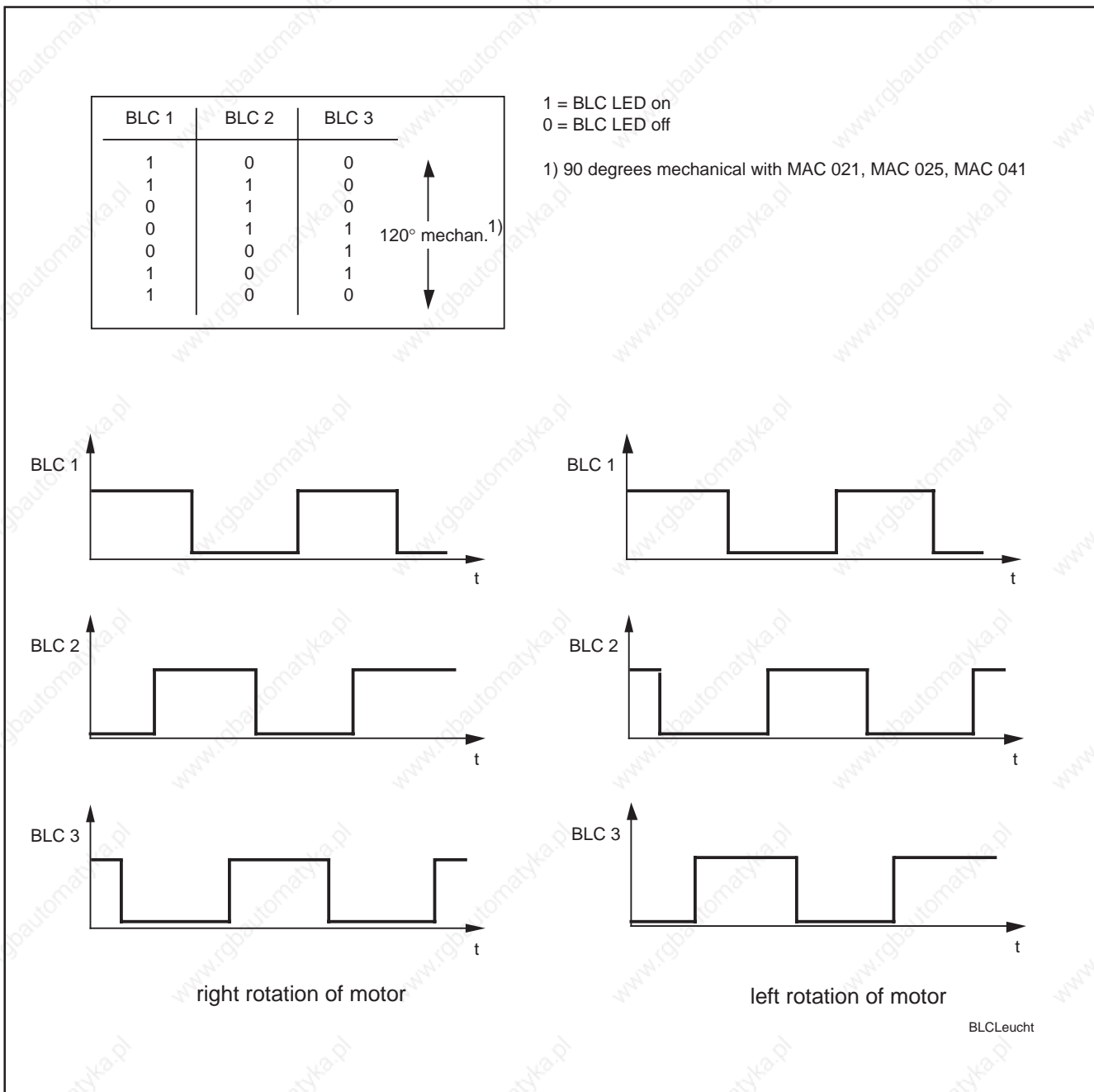

Figure 80: BLC LEDs and signal path

**Power or PWR**

With fault → off

No power applied or power disrupted.

Possible fault causes and measures:

- Link circuit busbars not sufficiently or not at all screwed in.  
Green lamp „power OK“ on the supply module is lit up.  
→ Check the fit of the link circuit busbars
- Link circuit throttle connection of the supply module (if present) not allocated  
→ Check whether the throttle at the link circuit throttle connection terminals 1L+, 2L+, 1L-, 2L- are properly connected, or whether there is a wire strap present.
- No mains voltage  
If green lamp „power OK“ at the supply module not lit up,  
→ check 3-phase mains voltage connection. (Look for fault between mains connection and supply unit.)  
→ Check the controller of the mains contactor.
- Mains voltage lacks phase:  
→ check 3-phase mains voltage at the supply module and re-measure,  
→ check link circuit short-circuit,  
→ check mains fuse.
- Only applies to KDV2, KDV3 and KDV4:  
No right rotational field (fault only occurs with first connection of machine or drive to the mains).  
→ Check the rotational direction at connecting terminals L1, L2, L3 of the supply module (e.g., using rotational field measuring device, or check phase sequence with an oscilloscope). If there is no right rotational field, exchange leads L1 and L2 at the supply module. Attention must be paid that mains auxiliary voltage connections L1 or L2 remain inphase with power connections L1, or L3 of supply module KDV, in accordance with the connection plan!
- Mains voltage too low  
→ Measure mains voltage at connection terminals L1, L2, L3 of the supply module.  
→ Faulty transformer connection or fault in mains
- Supply module defective  
→ Disconnect link circuit busbars and bus cable X1 between supply module and drive modules and repeat the above check. If there is no fault now, and the LED „power OK“ of the supply module is lit up, then the fault is in the connected drive module.  
→ Exchange supply module.



With fault → off  
 Controller release not applied to terminal RF  
 With fault → flashes (1)  
 Drive is interference free, but locked internally as there is no power voltage

Possible fault causes and measures:

LED flashing:  
 see above under LED „power“/“PWR“

LED off:  
 If message „power“ / „PWR“ lit up, then it should be possible to operate the drive after controller enable signal (3.30 volts) is input at terminal RF. Otherwise there is a fault in the drive.  
 → Measure voltage terminal RF



With fault → off  
 The drive is not ready to operate.  
 Bb contact of the drive module is open.  
 With fault → flashes (1)  
 No power voltage, drive interference-free

Possible fault causes and measures:

- No power voltage  
 → see LED „power“/“PWR“
- Fault in drive  
 → see which LEDs display fault „plus/minus 15V, 24V“, „tacho“, „TS“, „BS“, „TÜ“.



With fault → flashes (1)  
 Temperature pre-warning, maximum equipment temperature exceeded. Drive to shut down in 30 seconds.  
 With fault → on  
 Shutdown due to excessive equipment temperature.  
 After fault has been recovered, press the black reset key on the front of the diagnostics display to re-start.

Possible fault causes and measures:

- Fan not working or air inlet or outlet obstructed.  
 → Check fan  
 → Check fan fuse
- Inside temperature of control cabinet too high (ambient temperature)  
 → Improve control cabinet ventilation/cooling



- Load cycle of the drive too high
  - Increase break times or reduce load
- Wrong programming module MOD plugged in
  - Check the data on the rating plate for agreement



With fault → off

Temperature pre-warning that equipment temperature has already been exceeded.

The temperature monitoring opens (only in the KDS). The "open" collector output temperature monitoring (only in TDM3 and TDM4) switches to low-impedance 0 volts. Should the drive load not be sufficiently reduced within the next 30 seconds, then the drive package will be switched off.

Possible fault causes and measures:

see above under LED „TS“



With fault → on

Shutdown due to (even short-term) overcurrent, short-circuit or ground leak (1) in the drive module, cable or motor.

After fault has been recovered, press the black reset key on the front of the diagnostics display to re-start.

Possible fault causes and measures:

- Overcurrent when drive is run
  - Hit reset key once, input speed set point to zero and turn drive on with signal at terminal RF:
    - If fault does not occur again immediately, then there was an overcurrent during the run of the drive.
    - In this case, check to see whether the motor and controller types listed on the rating plate of programming module MOD have actually been built-in.
    - NOTE: In this case do not repeatedly hit the reset, as this might otherwise cause further damage to motor and drive modules.

Fault should continue to be localized and all components tested first:

- Short-circuit or ground leak in cable or connection
  - Test connection and cable, exchange if necessary.
- Short circuit or ground fault in motor
  - Check the motor for a short-circuit or ground leak, exchange if necessary.

Should the fault occur again after the reset has been hit, then

- the drive module is defective
  - exchange drive module

### 7.4. General faults and possible remedial measures

(1)=For add. measures, see respective Diagnostics Display in Chapter 7.3

No. Fault	Message at Terminal Strip	Diagnostics message in event of fault	Action to be taken
1. Mains cannot be switched on.	Terminal Bb1 open	„24V/ ±15V“ off	<ul style="list-style-type: none"> <li>- Switch on mains auxiliary voltage/ controller voltage</li> <li>- Check mains connection</li> <li>- Check bus cable connecting equipment for short circuit</li> <li>- Check diagnostics „24V/ plus/minus 15V“ (1)</li> </ul>
		„24V/ ±15V“ on	<ul style="list-style-type: none"> <li>- Fault in drive system</li> <li>- Check diagnostics display (1)</li> </ul>
	Terminal Bb1 closed	„Power“ off („PWR“)	<ul style="list-style-type: none"> <li>- No fault in drive system</li> <li>- Switch power on</li> <li>- Mains voltage lacking or faulty (1)</li> <li>- Check link circuit throttle connection</li> <li>- Check diagnostics display (1)</li> </ul>
		„Power“ on („PWR“)	Mains voltage on
2. Equipment fuses in supply unit blow:  24VL-fuse F2, mains auxiliary voltage connection, controller voltage connection fuses F3, F4  Fan fuses F5 on corresponding fan plate, F7, F8 on the front plate of the supply module (if present).  Power fuse F1 in TVM 1, TVM 2 and KDV 1	Terminal Bb1 open	„24V/ ±15V“ off	<ul style="list-style-type: none"> <li>- Short-circuit or overload in power section or in the 24 VL outputs</li> <li>- Check 24 VL outputs at the supply module and at the connected drive modules.</li> <li>- Check 24VL current load from the connected drives. Is the supply module overloaded?</li> <li>- Remove bus X1 from the supply module. Should problem still occur, then exchange supply module (usually if F3, F4 defective). If problem no longer occurs, determine drive module with short circuit or overload at the 24VL, and exchange if defective.</li> </ul>
		„Power“ off („PWR“)	<ul style="list-style-type: none"> <li>- Short-circuit or overload caused by attached fans.</li> <li>- Check the current load of the attached fans.</li> <li>- Locate defective fan or defective modular unit by removing the connecting cable and exchange, if necessary.</li> </ul>
		„BS“ on (Drive module)	<ul style="list-style-type: none"> <li>- Short-circuit in power section</li> <li>- Separate link circuit busbars from supply module.</li> <li>- If problem continues, exchange supply module. If problem no longer occurs, determine drive with short-circuit by measuring resistance between L+ and L- (also check diagnostics light „BS“ (1)).</li> <li>- If the problem occurs while drives are operating, then the supply module is overloaded.</li> </ul>
3. Fans not running			<ul style="list-style-type: none"> <li>- No mains auxiliary voltage at input terminals of supply modules (only with KDV2, KDV3 and KDV4).</li> <li>- No fan supply voltage</li> <li>- Fuses F7, F8 defective (only with KDV2, KDV3 and KDV4).</li> <li>- Check fuses on the fan plates of the corresponding fans.</li> <li>- Exchange fan or modular unit.</li> <li>- Fan rotor mechanically blocked.</li> </ul>

Figure 81: Summary of possible problems and actions to be taken.

## 7. Fault-Finding and Diagnostics

No. Fault	Message at Terminal Strip	Diagnostics message in event of fault	Action to be taken
4. Drive cannot be shut down and remains torque free		<p>„Power“ off</p> <p>„Power“ on „RF“ off „RF“ on or flashing</p>	<ul style="list-style-type: none"> <li>- Switch on mains voltage: (see Point 1 of this table)</li> <li>- Input set point</li> <li>- Input controller enable signal (1)</li> <li>- Eliminate break in motor or feedback line (1)</li> <li>- Motor mechanically blocked, eliminate blockage</li> <li>- Aereate motor brake, if drive blocked</li> <li>- Exchange servo drive module</li> <li>- Exchange motor (motor feedback defective)</li> </ul>
5. Drive active but not turning or cannot be moved.		<p>„RF“ off</p>	<ul style="list-style-type: none"> <li>- Input set point</li> <li>- Input controller enable signal (1)</li> <li>- Eliminate break in motor or feedback cable (1)</li> <li>- Motor mechanically blocked, eliminate blockage</li> <li>- Aereate motor brake, if drive blocked</li> <li>- Check load momentum</li> <li>- Exchange servo drive module</li> <li>- Motor feedback defective, exchange motor</li> </ul>
6. Drive runs uncontrolled to positive speed after being switched on.			<ul style="list-style-type: none"> <li>- Check whether speed set point equals zero.</li> <li>- Exchange speed set point polarity with feedback of position control loop.</li> <li>- Position control in NC defective.</li> <li>- Exchange feedback cable.</li> <li>- Exchange servo drive module.</li> <li>- Exchange motor.</li> </ul>
7. Unwanted halting of drives during operation.			<ul style="list-style-type: none"> <li>- Check diagnostics display (1) (Problem in drive system)</li> </ul>
8. Non-uniform turning of drives, non-uniform feed movement.			<ul style="list-style-type: none"> <li>- Check labelling of programming module MOD (wrong drive module or motor)</li> <li>- Check speed set point input value, adjust to NC output.</li> <li>- Check motor power connection (connections transposed, loose terminal point or a break in the cable)</li> <li>- Check motor feedback connection (connections transposed, loose terminal point or break in cable)</li> <li>- Check whether mains input at connection L1, L2, L3 of supply module is achieved using only two mains phases: <ul style="list-style-type: none"> <li>* check fuses</li> <li>* check mains connection</li> </ul> </li> <li>- Check interference suppression measures (see Chapter 5.5): <ul style="list-style-type: none"> <li>* contactor and relay coils</li> <li>* cable shields</li> </ul> </li> <li>- Aereate brakes if motor running against brakes.</li> <li>- Cut off mechanical coupling at motor shaft: <ul style="list-style-type: none"> <li>* load moment of inertia too high?</li> <li>* coupling too soft? (e.g., bellows coupling)</li> <li>* slack in the coupling?</li> <li>* too much friction or is there jamming?</li> </ul> </li> <li>- Optimize NC position control if Kv amplification too high.</li> <li>- Check NC set point Excessive harmonic vibrations on the NC set point: <ul style="list-style-type: none"> <li>* reduce harmonic vibrations or</li> <li>* increase set point smoothing and new optimization of position control (smaller Kv amplification)</li> </ul> </li> <li>- Check position analysis <ul style="list-style-type: none"> <li>* position encoder defective?</li> <li>* mechanical slack between position encoder and motor?</li> </ul> </li> <li>- Exchange motor</li> </ul>

## 8. Notes on Equipment Replacement

Time consuming searches for the faults within the individual units or the repair of the units within the machine are not acceptable because of the loss in production that these represent.

The diagnostic displays and the fault signals at the controller interfaces of INDRAMAT's AC Drives make a to-the-point and effective troubleshooting possible.

Once a drive component such as the supply module, drive amplifier module, motor or cable is diagnosed as defective, it can be exchanged without any problem. This makes a speedy elimination of the problem and a resumption of operation without drawn out assembly and adjustment work possible.

The factory-ready and optimized programming module MOD makes this adjustment-free exchange possible.

The following should be noted when exchanging a component:

- The new unit, motor or cable must have the exact same type designation on its rating plate as the one that is being replaced.
- In the case of a servo drive module (generally not defective), programming module MOD should be removed from the defective unit and plugged into the replacement drive module.
- The drift must be checked when exchanging the servo drive module, in accordance with Chapter 2.1, keyword „Drift Alignment“.
- When returning a defective unit to Indramat Customer Service, the „Repair Card“,

depicted on the next page, should accompany the return, after it has been filled out, to indicate all problems and faults which occurred.

If no repair card is available, then just make a copy of the following page, fill it out, and return it with the defective part. A short description of the faults and problems which occurred should, in any case, accompany the return to guarantee a quick and effective repair.

A repair card can be obtained from INDRAMAT.

Customer service contacts:

INDRAMAT GmbH  
Bgm.-Dr. Nebel-Str. 2  
D-97816 Lohr am Main

Technical service:	Mr. Krasemann	Tel. 09352/404496 Fax 09352/404440
--------------------	---------------	---------------------------------------

Sales and organizational handling:	Ms. Kissner	Tel. 09352/404950 Fax 09352/404992
------------------------------------	-------------	---------------------------------------

8. Notes on Equipment Replacement

<b>Repair Card</b> for INDRAMAT Units and Unit Components			
Name:		Company/Location:	
Date:		Serial no.: SN:	
Unit or Part, Type:		Del. cons. No.:	
Mach. no.:		Del. date:	
Mach. manuf./Co.:		Type	
Mach. no.:		Date op. started:	
Problem in axis:		Duration of operation:	
<input type="checkbox"/> horizontal <input type="checkbox"/> vertical <input type="checkbox"/>		Breakdown date:	
<b>Malfunction condition:</b> Fault _____ _____ <input type="checkbox"/> continuously present <input type="checkbox"/> occurs sporadically <input type="checkbox"/> occurs after approx. _____ hrs. <input type="checkbox"/> occurs with vibrations <input type="checkbox"/> is temperature-dependent <input type="checkbox"/> other _____ _____ _____		<b>Additional notes:</b> (e.g., LED diagnoses, fault message on display) _____ _____ _____ _____ _____	
<b>Cause of fault:</b> <input type="checkbox"/> unknown <input type="checkbox"/> connection error <input type="checkbox"/> external short <input type="checkbox"/> mechanical damage <input type="checkbox"/> loose cable connection <input type="checkbox"/> other _____ _____ _____ _____			
Additional Notes			
<b>General information:</b> <input type="checkbox"/> does not operate <input type="checkbox"/> drives run smudgy <input type="checkbox"/> uncontrolled drive movement <input type="checkbox"/> fault in only one direction <input type="checkbox"/> supply fuse blown <input type="checkbox"/> other _____ _____ _____		<b>Accompanying affects:</b> <input type="checkbox"/> problem in mechanics <input type="checkbox"/> mains section failure <input type="checkbox"/> controller failure <input type="checkbox"/> motor failure <input type="checkbox"/> break in cable <input type="checkbox"/> other _____ _____ _____	
<b>Controller</b> <input type="checkbox"/> does not operate <input type="checkbox"/> display faulty <input type="checkbox"/> no set-point output <input type="checkbox"/> diagnosis <input type="checkbox"/> position offset in ___ direction <input type="checkbox"/> Emergency off loop interrupted <input type="checkbox"/> Position control loop does not close <input type="checkbox"/> Fault in program sequence <input type="checkbox"/> Int. auxilliary function faulty (outputs) <input type="checkbox"/> acknowledgement messages not accepted (inputs) <input type="checkbox"/> other _____ _____ _____		<b>Motor</b> <input type="checkbox"/> Thermocouple element defective <input type="checkbox"/> brake defective <input type="checkbox"/> fan defective <input type="checkbox"/> feedback defective <input type="checkbox"/> tacho signal faulty <input type="checkbox"/> BLC signal faulty <input type="checkbox"/> frame ground short <input type="checkbox"/> thermal overload <input type="checkbox"/> other _____ _____ _____ _____	
<b>Controller, Supply Unit, Amplifier, Mains Section:</b> <input type="checkbox"/> LED diagnosis _____ <input type="checkbox"/> controller voltage faulty <input type="checkbox"/> mains section fuse F___ blew <input type="checkbox"/> fan defective <input type="checkbox"/> bleeder resistance def. <input type="checkbox"/> power voltage faulty <input type="checkbox"/> connecting bolt torn off <input type="checkbox"/> other _____ _____			
<b>Comments:</b> _____ _____ _____ _____ _____ _____			
Rep_Bglk.fh3			

Figure 82: Repair Card

## 9. Summary of Diagnostic Displays on Modules

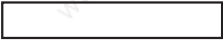





Figure	Figure Diagnostic Display for Unit Type	Serial no.
Servo drive module:		
Fig. 83	TDM 1, TDM 2	from SN234...
Fig. 84	TDM 1, TDM 2	below SN233...
Fig. 85	TDM 3, TDM 6	from SN240060-... —
Fig. 86	TDM 3,	below SN240060-...
Fig. 87	TDM 4, TDM 7	from SN240062-... —
Fig. 88	TDM 4,	below SN240062-...
Fig. 89	KDS 1	—
Supply module:		
Fig. 90	TVM 1, TVM 2, KDV 1	—
Fig. 91	KDV 2	—
Fig. 92	KDV 3	—
Fig. 93	KDV 4	—
Fig. 94	TVD 1	—

## Diagnostic Display Servo Drive Modules TDM 1 and TDM 2

Equipment with serial numbers from SN 234... is equipped with expanded diagnostics

**Note:** The messages are only then valid if "+24V, plus/minus15V" message emits constant green light.

(1) Message and unit lock are being stored.  
Re-set by hitting re-set key or switching back on.

Light-emitting diode	Off	Flashing	Cont. Light
<b>+24V, ±15V</b> green			
	Switched off because there was no controller voltage or temporary interference (1)		Controller voltage <b>working</b>
<b>BLC 1</b> green	Rotor position  <b>Working:</b> One or two light-emitting diodes out  <b>Malfunction:</b> BLC 1, BLC 2, BLC 3 are simultaneously out. Faulty connection or fault in feedback cable	<b>Working:</b> Each "BLC" LED flashes at low speed ( $n < 100 \text{ min}^{-1}$ )  The flashing appears to be a constant light when speeds are higher.	<b>Working:</b> Motor standing still: One or two LEDs lit up.  <b>Malfunction:</b> BLC 1, BLC 2, BLC 3 simultaneously lit up with low speeds or stand still. Faulty connection or fault in feedback cable.
<b>BLC 2</b> green			
<b>BLC 3</b> green			
<b>Tacho</b> green	Disconnect due to tacho or BLC malfunction, faulty connection or break in cable of the feedback cable or motor overspeed (1)		Tacho and BLC <b>Working</b>
<b>Power</b> green	Power voltage not switched on or disrupted.		Power voltage present <b>Working</b>
<b>RF</b> green	No controller enable signal at terminal RF	Unit internally locked because no power voltage and/or fault present	Controller enable applied, drive active <b>Working</b>
<b>Bb</b> green	Unit locked because no power voltage and/or fault present (display via different LED)	Drives trouble-free, no power voltage	Drive ready-to-operate <b>Working</b>
<b>TS</b> red	Temperature within acceptable range <b>Working</b>	Equipment temperature too high. Drive will shut down in 30 seconds.	Shutdown due to excessive equipment temperature (1)
<b>BS</b> red	Current within acceptable range <b>Working</b>		Shutdown due to overcurrent, short-circuit or ground leak in amplifier, cable or motor (1)

DiagTDM1/2neu

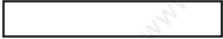









Figure 83: Diagnostics Display Servo Drive Modules TDM1 and TDM2 with Serial Numbers from SN 234 ...

## Diagnostic Displays Servo Drive Modules TDM 1, TDM 2

Equipment with serial numbers from SN 233...

**Note:** The messages are only then valid if "+24V, plus/minus15V" message displays constant green light.

(1) Message and unit lock are being stored.  
Re-set by hitting re-set keyor switching back on.

Light-emitting diode		Off 	Flashing 	Cont. Light 
<b>+24V, ±15V</b> green		Switched off as no controller voltage		Controller voltage <b>working</b>
<b>BLC 1</b> green	Rotor position	<b>Working:</b> One or two light-emitting diodes out.  <b>Malfunction:</b> BLC 1, BLC 2, BLC 3 are simultaneously out. Faulty connection or fault in feedback cable.	<b>Working:</b> Each "BLC" LED flashes at low speed ( $n < 100 \text{ min}^{-1}$ )  The flashing appears to be a constant light at higher speed.	<b>Working:</b> Motor standing still: One or two LEDs lit up.  <b>Malfunction:</b> BLC 1, BLC 2, BLC 3 simultaneously lit up with low speeds or stand still. Faulty connection or fault in feedback cable.
<b>BLC 2</b> green				
<b>BLC 3</b> green				
<b>Tacho</b> green		Disconnected due to tacho malfunction, faulty connection or break in cable of the feedback cable or motor overspeed (1)		Tacho and BLC <b>working</b>
<b>Power</b> green		Power voltage not switched on or disrupted.		Power voltage present <b>Working</b>
<b>RF</b> green		No controller enable signal at terminal RF		Controller enable applied Terminal RF on <b>Working</b>
<b>Bb</b> green		Unit locked because no power voltage and/or fault present (display via different LED)		Drive ready to operate <b>Working</b>
<b>TS</b> red		Temperature within acceptable range <b>Working</b>		Shutdown due to excessive equipment temperature (1)
<b>BS</b> red		Current within acceptable range <b>Working</b>		Shutdown due to overcurrent, short-circuit or ground leak in amplifier, cable or motor (1)

DiagTDM1/2alt

Figure 84: Diagnostics Display Servo Drive Modules TDM1 and TDM2 with Serial Numbers from SN 233 ...







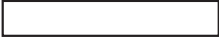

## Diagnostic Displays Servo Drive Modules TDM 3 and TDM 6

Equipment with serial numbers from SN 240 060 - XXXXX are equipped with expanded diagnostics.

**Note:** The messages are only then valid if "+24V, plus/minus15V" message displays constant green light.

- (1) Message and unit lock are being stored.  
Re-set by hitting re-set key or switching back on.

Light-emitting diode	Off	Flashing	Cont. Light
<b>+24V, ±15V</b> green			
	Switched off because there was no controller voltage or it was temporarily disrupted (1)		Controller voltage <b>working</b>
<b>BLC 1</b> green	Rotor position	<b>Working:</b> Each "BLC" LED flashes at low speed. ( $n < 100 \text{ min}^{-1}$ )  The flashing appears to be a constant light at higher speeds.	<b>Working:</b> Motor standing still: One or two LEDs lit up.  <b>Malfunction:</b> BLC 1, BLC 2, BLC 3 simultaneously lit up with low speeds or stand still. Faulty connection or fault in feedback cable.
<b>BLC 2</b> green			
<b>BLC 3</b> green			
<b>Tacho</b> green	Disconnected due to tachometer or BLC malfunction, faulty connection or break in cable of the feedback cable or motor overspeed (1)		Tacho and BLC <b>Working</b>
<b>PWR (Power)</b> green	Power voltage not switched on or disrupted.		Power voltage present <b>Working</b>
<b>RF</b> green	No controller enable signal at terminal RF	Controller enable applied, but unit internally locked because no power voltage and/or malfunction present	Controller enable applied, Drive active <b>Working</b>
<b>Bb</b> green	Unit locked because fault present (display via different LED)	Drive problem free, no power voltage	Drive ready-to-operate <b>Working</b>
<b>TS</b> red	Temperature within acceptable range <b>Working</b>	Equipment temperature too high. Drive will shut down in 30 seconds.	Shutdown due to excessive equipment temperature (1)
<b>BS</b> red	Current within acceptable range <b>Working</b>		Shutdown due to overcurrent, short-circuit or ground leak in amplifier, cable or motor (1)

DiagTDM3neu/6

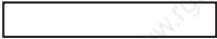









Figure 85: Diagnostics Display Servo Drive Module TDM3 with Serial Numbers from SN 240060-... and TDM6

## Diagnostic Displays Servo Drive Modules TDM 3

Equipment with serial numbers from SN 240 060-XXXXX

**Note:** The messages are only then valid if "+24V, plus/minus15V" message displays constant green light.

(1) Message and unit lock are being stored.  
Re-set by hitting re-set key or switching back on.

Light-emitting diode	Off	Flashing	Cont. Light
<b>+24V, ±15V</b> green			
<b>BLC 1</b> green	<p style="text-align: center;"><b>Working:</b> Motor standing still: One or two light-emitting diodes out.</p> <p style="text-align: center;"><b>Malfunction:</b> BLC 1, BLC 2, BLC 3 are simultaneously out. Faulty connection or fault in feedback cable.</p>	<p style="text-align: center;"><b>Working:</b> Each "BLC" LED flashes at low speed (n &lt; 100 min<sup>-1</sup>)</p> <p style="text-align: center;">The flashing appears to be a constant light at higher speeds.</p>	<p style="text-align: center;"><b>Working:</b> Motor standing still: One or two LEDs lit up.</p> <p style="text-align: center;"><b>Malfunction:</b> BLC 1, BLC 2, BLC 3 simultaneously lit up with low speeds or stand still. Faulty connection or fault in feedback cable.</p>
<b>BLC 2</b> green			
<b>BLC 3</b> green			
<b>Tacho</b> green	Disconnected due to tachometer or BLC malfunction, faulty connection or break in cable of the feedback cable or motor overspeed (1)		Tachometer and BLC <b>Working</b>
<b>POWER</b> green	Power voltage not switched on or disrupted.		Power voltage present <b>Working</b>
<b>RF</b> green	No controller enabler signal at terminal RF.		Controller enabler applied Drive active <b>Working</b>
<b>Bb</b> green	Unit locked because fault present (display via different LED).		Drive ready to operate <b>Working</b>
<b>BS</b> red	Current within acceptable range <b>Working</b>		Shutdown due to overcurrent or short-circuit in amplifier, cable or motor (1)
<b>TÜ</b> red	Temperature within acceptable range <b>Working</b>		Equipment temperature too high. Drive to shutdown in 30 seconds.
<b>TS</b> red	<b>Working</b>		Shutdown due to excessive equipment temperature (1)

DiagTDM3alt







Figure 86: Diagnostics Display Servo Drive Module TDM3 with Serial Numbers below SN 240060-...

## Diagnostic Displays Servo Drive Modules TDM 4, TDM 7

Equipment with serial numbers from SN 240 062 - XXXXX are equipped with expanded diagnostics.

**Note:** The messages are only then valid if "+24V, plus/minus15V" message displays constant green light.

(1) Message and unit lock are being stored.  
Re-set by hitting re-set key or switching back on.

Light-emitting diode	Off	Flashing	Cont. Light
<b>+24V, ±15V</b> green			
<b>+24V, ±15V</b> green	Switched off because there was no controller voltage or it was temporarily disrupted (1).		Controller voltage <b>working</b>
<b>BLC 1</b> green	<b>Working:</b> Motor standing still: One or two light-emitting diodes out.  <b>Malfunction:</b> BLC 1, BLC 2, BLC 3 are simultaneously out. Faulty connection or fault in feedback cable.	<b>Working:</b> Each "BLC" LED blinks with low speed. ( $n < 100 \text{ min}^{-1}$ )  The blinking appears to be a constant light at higher speeds.	<b>Working:</b> Motor standing still: One or two LEDs lit up.  <b>Malfunction:</b> BLC 1, BLC 2, BLC 3 simultaneously lit up with low speeds or stand still. Faulty connection or fault in feedback cable.
<b>BLC 2</b> green			
<b>BLC 3</b> green			
<b>Tacho</b> green	Disconnected due to tacho or BLC malfunction, or motor overspeed (1)		Tacho and BLC <b>Working</b>
<b>PWR</b> (Power) green	Power voltage not switched on or disrupted.		Power voltage present <b>Working</b>
<b>RF</b> green	No controller enable signal at terminal RF	Controller enable applied, but unit internally locked because no power voltage and/or fault present.	Controller enable applied Drive active <b>Working</b>
<b>Bb</b> green	Unit locked because fault present (display via different LED).	Drive fault free, no power voltage.	Drive ready-to-operate <b>Working</b>
<b>TS</b> red	Temperature within acceptable range <b>Working</b>	Temperature too high. Drive will shutdown in 30 seconds.	Shutdown due to excessive equipment temperature (1)
<b>BS</b> red	Current within acceptable range <b>Working</b>		Shutdown due to overcurrent, short-circuit or ground leak in amplifier, cable or motor (1)

DiagTDM4neu7

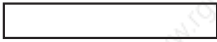









Figure 87: Diagnostics Display Servo Drive Modules TDM4 with Serial Numbers from SN 240062-... and TDM7

## Diagnostic Displays Servo Drive Modules TDM 4

Equipment with serial numbers from SN 240 062-XXXXX

**Note:** The messages are only then valid if "+24V, plus/minus15V" message displays constant green light.

(1) Message and unit lock are being stored.  
Re-set by hitting re-set key or switching back on.

Light- emitting diode		Off 	Flashing 	Cont. Light 
<b>+24V, ±15V</b> green		Switched off as no controller voltage		Controller voltage <b>Working</b>
<b>BLC 1</b> green	Rotor position	<b>Working:</b> Motor standing still: One or two light-emitting diodes out.  <b>Malfunction:</b> BLC 1, BLC 2, BLC 3 are simultaneously out. Faulty connection or fault in feedback cable.	<b>Working:</b> Each "BLC" LED flashes at low speed. ( $n < 100 \text{ min}^{-1}$ )  The flashing appears to be a constant light at higher speeds.	<b>Working:</b> Motor standing still: One or two LEDs lit up.  <b>Malfunction:</b> BLC 1, BLC 2, BLC 3 simultaneously lit up with low speeds or stand still. Faulty connection or fault in feedback cable.
<b>BLC 2</b> green				
<b>BLC 3</b> green				
<b>Tacho</b> green		Disconnect due to tacho or BLC malfunction, or motor overspeed (1)		Tacho and BLC <b>Working</b>
<b>POWER</b> green		Power voltage not switched on or disrupted.		Power voltage present <b>Working</b>
<b>RF</b> green		No controller enable signal at terminal RF		Controller enable applied Drive active <b>Working</b>
<b>Bb</b> green		Unit locked because fault present (display via different LED)		Drive ready-to-operate <b>Working</b>
<b>BS</b> red		Current within acceptable range <b>Working</b>		Shutdown due to overcurrent, or short-circuit in amplifier, cable or motor (1)
<b>TÜ</b> red		Temperature within acceptable range <b>Working</b>		Equipment temperature too high. Unit will shutdown in 30 seconds.
<b>TS</b> red		<b>Working</b>		Shutdown due to excessive equipment temperature (1)



DiagTDM4alt

Figure 88: Diagnostics Display Servo Drive Module TDM4 with Serial Numbers below SN 240062-...

## Diagnostic Displays Servo Drive Modules KDS 1

**Note:** The messages are only then valid if "+24V, plus/minus15V" message displays constant green light.

(1) Message and unit lock are being stored.  
Re-set by hitting re-set key or switching back on.

Light-emitting diode	Off 	Flashing 	Cont. Light 
<b>+24V, ±15V</b> green	Switched off as no controller voltage	—————	Controller voltage <b>Working</b>
<b>BLC 1</b> green	Rotor position  <b>Working:</b> Motor standing still: One or two light-emitting diodes out.  <b>Malfunction:</b> BLC 1, BLC 2, BLC 3 are simultaneously out. Faulty connection or fault in feedback cable.	<b>Working:</b> Each "BLC" LED flashes at low speed ( $n < 100 \text{ min}^{-1}$ )  The flashing appears to be a constant light at higher speeds.	<b>Working:</b> Motor standing still: One or two LEDs lit up.  <b>Malfunction:</b> BLC 1, BLC 2, BLC 3 simultaneously lit up with low speeds or stand still. Faulty connection or fault in feedback cable.
<b>BLC 2</b> green			
<b>BLC 3</b> green			
<b>Tacho</b> green	Disconnect due to tacho malfunction, faulty connection or cable disruption of the feedback cable or motor overspeed (1)	—————	Tacho and BLC <b>Working</b>
<b>POWER</b> green	Power voltage not switched on or disrupted.	—————	Power voltage present <b>Working</b>
<b>RF</b> green	No controller release signal at terminal RF.	—————	Controller enable applied Drive active <b>Working</b>
<b>Bb</b> green	Unit locked because fault present (display via different LED).	—————	Drive ready-to-operate <b>Working</b>
<b>BS</b> red	Current within acceptable range <b>Working</b>	—————	Shutdown due to overcurrent, or short-circuit in amplifier, cable or motor (1)
<b>TS</b> red	<b>Working</b>	—————	Shutdown due to excessive equipment temperature (1)
<b>TÜ</b> red	Temperature within acceptable range <b>Working</b>	—————	Equipment temperature too high. Drive will shutdown in 30 seconds.



DiagKDS1

Figure 89: Diagnostics Display Servo Drive Module KDS1

## Diagnostic Displays Supply Modules TVM 1, TVM 2, KDV 1

**Note:** The messages are only valid if the "+24V, plus/minus15V" constantly lit up.

(1) Message and equipment lock are stored.  
Re-set by pressing re-set key or switching back on.

Light-emitting diodes		Off	Cont. light
			
H3	<b>Überspannung OVERVOLTAGE</b> red	Deceleration capabilities of drive within permissible range <b>Working</b>	Power off due to excessive deceleration energy, excessive mains voltage or defective drive module (1)
H4	<b>Leistung Ein POWER ON</b> green	Power not switched on or disrupted	Power voltage <b>Working</b>



DiagTVM1/2KDV1

Figure 90: Diagnostics Display for Supply Modules TVM1, TVM2 and KDV1

## Diagnostics Display for Supply Module KDV 2

**Note:** The messages are only valid if the "+24V, plus/minus15V" message is constantly lit up.

(1) Message and equipment lock are stored.  
Re-set by pressing re-set key or switching back on.

Light-emitting diodes		Off	Cont. light
			
	<b>Bleeder Überlast BLEEDER OVERLOAD</b> red	Deceleration capabilities of drive within permissible range <b>Working</b>	Power off due to excessive deceleration energy or fault in supply module (1)
	<b>Erdschluß EARTH CON.</b> red	No ground leak <b>Working</b>	Power off due to ground leak in supply module, in drive module, in cable or in motor (1)
	<b>Hilfsspannung AUX. VOLT</b> green	No mains auxiliary voltage at terminals L1 ... L3	Mains auxiliary voltage <b>Working</b>
	<b>Leistung o.k. POWER o.k.</b> green	Power not switched on or disrupted	Power voltage <b>Working</b>



DiagKDV2

Figure 91: Diagnostics Display for Supply Module KDV2

## Diagnostic Displays for Supply Module KDV 3

**Note:** The messages are only valid if the "+24V, plus/minus15V" message is constantly lit up.

(1) Message and equipment lock are stored.  
Re-set by pressing re-set key or switching back on.

Light-emitting diodes	Off 	Cont. light 
<b>+24V/±15V</b> green	Power off due to faulty controller voltage	Controller voltage <b>Working</b>
<b>Hilfsspannung AUX. VOLT</b> green	No mains auxiliary voltage at terminals L1 ... L3	Mains auxiliary voltage <b>Working</b>
<b>Leistung o.k. POWER o.k.</b> green	Power not on or disrupted.	Power voltage <b>Working</b>
<b>Überstrom OVERCURRENT</b> red	Current in power section within permissible range <b>Working</b>	Power off due to overcurrent, short circuit in supply module, in drive module, in cable or in motor <b>(1)</b>
<b>Erdschluß EARTH CON.</b> red	No ground leak <b>Working</b>	Power off due to ground leak in supply module, in drive module, in cable or in motor <b>(1)</b>
<b>Übertemperatur TEMP. FAULT</b> red	Equipment temperature <b>Working</b>	Power off as unit temperature too high <b>(1)</b>
<b>Bleeder Überlast BLEEDER OVERLOAD</b> red	Deceleration capabilities of drive within permissible range <b>Working</b>	Power off due to excessive deceleration energy or fault in supply module <b>(1)</b>



DiagKDV3

Figure 92: Diagnostics Display for Supply Module KDV3

## Diagnostics Display on Supply Module KDV 4

**Note:** The messages are only valid if the "+24V, plus/minus15V" message is constantly lit up.

- (1) Message and equipment locked are stored.  
Re-set by pressing re-set key or switching back on.

Light-emitting diodes		Off 	Cont. light 
<b>H1</b>	<b>Hilfsspannung AUX. VOLT</b> green	No mains auxiliary voltage at terminals L1 ... L3	Mains auxiliary voltage <b>Working</b>
<b>H2</b>	<b>+24V/±15V</b> green	Power off due to faulty controller voltage	Controller voltage <b>Working</b>
<b>H3</b>	<b>Netzüberwachung MAINS FAULT</b> green	mains malfunction: Phase missing, no right rotational field or mains voltage too low	Mains <b>Working</b>
<b>H4</b>	<b>Leistung o.k. POWER o.k.</b> green	Power not switched on or disrupted	Power voltage <b>Working</b>
<b>H5</b>	<b>Bleeder Überlast BLEEDER OVERLOAD</b> red	Deceleration capabilities within permissible range <b>Working</b>	Power off due to excessive braking energy or fault in supply module <b>(1)</b>
<b>H6</b>	<b>KK-Übertemperatur TEMP. FAULT</b>	Equipment temperature <b>Working</b>	Power off as equipment temperature to high <b>(1)</b>
<b>H7</b>	<b>Überstrom OVERCURRENT</b> red	Current within power section within permissible range <b>Working</b>	Power off due to overcurrent, short circuit in supply module, in drive module, in cable or in motor <b>(1)</b>
<b>H8</b>	<b>Erdschluß EARTH CON.</b> red	No ground leak <b>Working</b>	Power off due ground leak in supply or drive module, cable or motor <b>(1)</b>

DiagKDV4

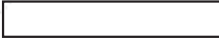

Figure 93: Diagnostics Displays on Supply Module KDV4



## Diagnostics Display on Supply Module TVD 1

**Note:** The messages are only valid if the "+24V, plus/minus15V" message is constantly lit up.

(1) Message and equipment locked are stored.  
Re-set by pressing re-set key or switching back on.

Light-emitting diodes		Off 	Flashing 	Cont. light 
H1B green	<b>+24V/±15V</b>	Signal voltage disrupted	—————	Power voltage <b>Working</b>
H2B green	<b>Bb1      CLOSED              geschl.</b>	Malfunction in supply module or in drive (1)	—————	Supply module and drives are fault-free
H3B green	<b>MAINS      OK Netzspg.</b>	No mains connection, Phase missing or mains voltage to low	—————	Mains connection <b>Working</b>
H4B green	<b>POWER      OK Leistung</b>	Mains contactor not switched on or disrupted, or rectifier disrupted.	—————	Link circuit voltage <b>Working</b>
H1A red	<b>OVERCURRENT Überstrom</b>	Current in power section within permissible range	Power on with existing short circuit in TVD, in drive module, in cable or in motor [5]	Power off due to overcurrent short circuit in TVD, drive module, cable or motor (1)
H2A red	<b>BLEEDER OVERL. Überl.</b>	Deceleration capabilities within permissible range.	Deceleration capabilities of the drives may not be increased	Power off due to excessive deceleration energy (1)
H3A red	<b>TEMP. FAULT KK-Übertemp.</b>	Equipment temperature within permissible range.	Equipment temperature too high; power off within 30 seconds	Power off due to excessive equipment temperature (1)
H4A red	<b>OVERVOLT FUSE Übersp.sich.</b>	Voltage in power section has not exceeded its maximum value	—————	Overvoltage fuse blown

DiagTVD1

Figure 94: Diagnostics Display on Supply Module TVD 1

## 10. Summary of Data

### 10.1. Important Motor Data

MOTOR MAC	Rated speed	Tacho constants	Torque constants	Continuous torque		Continuous current		Motor moment of inertia
	(1)		(2)	not ventilated (3)	ventilated	not ventilated (3)	ventilated	J
	n <sub>max</sub>	C <sub>w</sub>	K <sub>m</sub>	M <sub>(dN)</sub>	M <sub>(dN)</sub>	I <sub>(dN)</sub>	I <sub>(dN)</sub>	J
	min <sup>-1</sup>	V/1000min <sup>-1</sup>	Nm/A	Nm	Nm	A	A	kgm <sup>2</sup> x10 <sup>-4</sup>
021A-0-YS	10000	0.75	0.190	0.15	0.00	0.79	0.00	0.22
021B-0-WS	10000	0.75	0.190	0.3	0.00	1.60	0.00	0.31
025A-0-WS	10000	0.75	0.220	0.33(0.27)		1.54(1.26)		0.23
025B-0-ZS	10000	0.75	0.220	0.60(0.51)		2.80(2.38)		0.32
025C-0-QS	10000	0.75	0.230	0.90(0.75)		4.00(3.40)		0.41
041A-0-FS	6000	0.75	0.330	0.64(0.59)		2.00(1.80)		0.70
041B-0-BS	6000	0.75	0.310	1.35(1.26)		4.40(4.10)		1.30
041C-0-TS	6000	0.75	0.330	2.05(1.93)		6.30(5.90)		1.90
041A-0-IS	10000	0.75	0.200	0.64(0.59)		3.30(3.00)		0.70
041B-0-QS	10000	0.75	0.190	1.35(1.26)		7.30(6.80)		1.30
041C-0-LS	10000	0.75	0.200	2.05(1.93)		10.50(9.90)		1.90
063A--RS	6000	1.50	0.230	0.80	1.00	3.50	4.40	2.40
063B--JS	6000	1.50	0.260	1.50	1.70	5.80	6.60	3.20
063C--HS	6000	1.50	0.310	2.10	2.70	6.80	8.70	4.00
063D--FS	6000	1.50	0.320	2.70	3.50	8.40	11.00	4.80
063A--ES	3500	1.50	0.370	0.80	1.00	2.20	2.70	2.40
063B--GS	3500	1.50	0.420	1.50	1.70	3.60	4.00	3.20
063C--MS	3500	1.50	0.510	2.10	2.70	4.10	5.30	4.00
063D--JS	3500	1.50	0.530	2.70	3.50	5.10	6.60	4.80
071A--HS	2000	3.0	0.860	2.20	3.30	2.60	4.10	5.40
071B--FS	2000	3.0	0.880	4.40	6.60	5.00	7.90	9.90
071C--US	2000	3.0	0.900	6.60	9.90	7.30	11.8	12.90
071A--OS	3000	3.0	0.580	2.20	3.30	3.80	6.00	5.40
071B--TS	3000	3.0	0.600	4.40	6.60	7.30	11.7	9.90
071C--NS	3000	3.0	0.600	6.60	9.90	11.0	17.7	12.90
071A--ES	4000	1.50	0.440	2.20	3.30	5.00	7.90	5.40
071B--PS	4000	1.50	0.460	4.40	6.60	9.60	15.3	9.90
071C--JS	4000	1.50	0.430	6.60	9.90	15.3	24.8	12.90
071A--VS	6000	1.50	0.300	2.20	3.30	7.30	11.70	5.40
071B--KS	6000	1.50	0.310	4.40	6.60	14.20	22.30	9.90
071C--GS	6000	1.50	0.300	6.60	9.90	22.00	35.40	12.90
090A--ZD	2000	3.0	0.510	3.70	5.00	8.10	10.90	20.00
090B--PD	2000	3.0	0.670	7.20	10.50	11.90	17.40	36.00
090C--KD	2000	3.0	0.680	10.40	16.00	17.00	26.10	53.00
090A--RD	3000	3.0	0.340	3.50	5.00	11.40	16.30	20.00
090B--ND	3000	3.0	0.580	6.70	10.50	13.00	20.00	36.00
090B--JD	3000	3.0	0.410	6.70	10.50	18.20	28.50	36.00
090C--GD	3000	3.0	0.430	9.60	16.00	24.80	41.30	53.00
090C--ED	5000	1.5	0.310	10.00	16.00	35.00	52.00	53.00

## 10. Summary of Data

MOTOR MAC	Rated speed	Tacho constants	Torque constants	Continuous torque		Continuous current		Motor moment of inertia
	(1)		(2)	not ventilated	ventilated	not ventilated	ventilated	
	n <sub>max</sub>	C <sub>w</sub>	K <sub>m</sub>	M <sub>(dN)</sub>	M <sub>(dN)</sub>	I <sub>(dN)</sub>	I <sub>(dN)</sub>	J
	min <sup>-1</sup>	V/1000min <sup>-1</sup>	Nm/A	Nm	Nm	A	A	kgm <sup>2</sup> x10 <sup>-4</sup>
092A-0-DD	4000	1.5	0.240	1.50	0.00	6.90	0.00	8.70
092B-0-QD	4000	1.5	0.280	3.00	0.00	11.90	0.00	16.00
093A--WS	2000	3.0	0.875	9.20	12.00	11.00	14.00	22.00
093B--OS	2000	3.0	0.831	14.50	20.00	18.00	25.00	29.00
093C--KS	2000	3.0	0.910	19.50	28.00	22.00	32.00	42.00
093A--PS	3000	3.0	0.620	9.20	12.00	15.00	20.00	22.00
093B--JS	3000	3.0	0.554	14.50	18.30	27.00	34.00	29.00
093C--FS	3000	3.0	0.579	19.50	28.00	35.00	50.00	42.00
093A--LS	4000	1.5	0.438	9.20	12.00	22.00	28.00	22.00
093B--GS	4000	1.5	0.388	14.50	20.00	38.00	53.00	29.00
093C--DS	4000	1.5	0.413	19.50	28.00	48.00	69.00	42.00
093A--HS	6000	1.5	0.292	9.20	9.80	32.00	34.00	22.00
093B--ES	6000	1.5	0.277	14.50	20.00	54.00	74.00	29.00
093C--CS	6000	1.5	0.331	19.50	28.00	60.00	87.00	42.00
095A-0-VS	3000	3.0	0.550	2.40	0.00	4.50	0.00	8.70
095B-0-AS	3000	3.0	0.500	4.50	0.00	9.20	0.00	13.60
095C-0-RS	3000	3.0	0.504	6.70	0.00	13.60	0.00	17.00
112A--ZD	1500	3.0	0.820	10.70	13.00	14.50	17.20	61.00
112B--PD	1500	3.0	0.910	18.20	29.00	21.00	33.00	120.00
112C--KD	1500	3.0	1.000	28.00	44.00	31.00	49.00	170.00
112D--HD	1500	3.0	1.010	38.00	57.00	42.00	63.00	230.00
112A--VD	2000	3.0	0.630	10.50	13.00	18.50	22.90	61.00
112B--LD	2000	3.0	0.740	17.50	29.00	26.30	43.50	120.00
112C--HD	2000	3.0	0.730	27.00	44.00	41.00	67.00	170.00
112D--FD	2000	3.0	0.760	38.00	57.00	56.00	83.00	230.00
112A--LD	3000	3.0	0.350	9.80	13.00	31.00	41.30	61.00
112B--GD	3000	3.0	0.430	16.00	29.00	41.00	75.00	120.00
112C--ED	3000	3.0	0.470	24.00	44.00	57.00	104.00	170.00
112D--ED	3000	3.0	0.620	35.00	57.00	63.00	102.00	230.00
112C-0-CD	5000	1.5	0.330	27.00	0.00	91.00	0.00	17.00
114A-0-ED	3000	3.0	0.400	4.20	0.00	11.70	0.00	35.00
114B-0-SD	3000	3.0	0.550	9.00	0.00	18.20	0.00	61.00
114C-0-MD	3000	3.0	0.580	13.00	0.00	24.90	0.00	87.00
114E-0-ND	3000	3.0	0.550	24.00	0.00	48.50	0.00	120.00
115A--HS	2000	3.0	0.882	28.00	42.00	32.50	48.80	123.00
115B--GS	2000	3.0	0.952	38.00	61.00	40.90	66.00	172.00
115C--ES	2000	3.0	0.880	47.00	75.00	55.00	87.00	222.00
115D--DS	2000	3.0	0.864	57.00	88.00	68.00	104.00	271.00
115A--FS	3000	3.0	0.588	28.00	42.00	48.80	73.20	123.00
115B-0-DS	3000	3.0	0.544	38.00	0.00	72.00	0.00	172.00
115C-0-CS	3000	3.0	0.528	47.00	0.00	91.00	0.00	222.00
115D-0-CS	3000	3.0	0.648	57.00	0.00	90.00	0.00	271.00

10. Summary of Data

MOTOR MAC	Rated speed	Tacho constants	Torque constants	Continuous torque		Continuous current		Motor moment of inertia
	(1)		(2)	not ventilated	ventilated	not ventilated	ventilated	
	n <sub>max</sub> min <sup>-1</sup>	C <sub>w</sub> V/1000min <sup>-1</sup>	K <sub>m</sub> Nm/A	M <sub>(dN)</sub> Nm	M <sub>(dN)</sub> Nm	I <sub>(dN)</sub> A	I <sub>(dN)</sub> A	J kgm <sup>2</sup> x10 <sup>-4</sup>
117A-0-PS	2000	3.0	0.775	6.50	0.00	8.60	0.00	30.00
117A-0-BS	3000	3.0	0.517	6.50	0.00	12.90	0.00	30.00
117A-0-TS	4000	1.5	0.351	6.50	0.00	19.00	0.00	30.00
117B-0-WS	2000	3.0	0.849	12.50	0.00	15.10	0.00	54.00
117B-0-OS	3000	3.0	0.554	12.50	0.00	23.10	0.00	54.00
117B-0-KS	4000	1.5	0.406	12.50	0.00	31.60	0.00	54.00
117C-0-QS	2000	3.0	0.886	18.00	0.00	21.00	0.00	78.00
117C-0-KS	3000	3.0	0.609	18.00	0.00	30.00	0.00	78.00
117C-0-HS	4000	1.5	0.443	18.00	0.00	41.70	0.00	78.00
117D-0-MS	2000	3.0	0.887	23.00	0.00	27.00	0.00	102.00
117D-0-HS	3000	3.0	0.591	23.00	0.00	40.00	0.00	102.00
117D-0-FS	4000	1.5	0.443	23.00	0.00	53.20	0.00	102.00
117E-0-JS	2000	3.0	0.922	28.00	0.00	31.10	0.00	126.00
117E-0-GS	3000	3.0	0.646	28.00	0.00	44.40	0.00	126.00
117E-0-ES	4000	1.5	0.461	28.00	0.00	62.20	0.00	126.00
117C-0-ES	6000	1.5	0.277	18.00	0.00	67.00	0.00	78.00
132B-1-ID	1000	3.0	1.293	58.00	82.00	45.00	63.60	140.00
160C-0-ED	2000	3.0	1.010	64.00	0.00	70.00	0.00	850.00
160D-0-ED	1500	3.0	1.360	84.00	0.00	69.00	0.00	1150.0
160E-0-ED	1200	3.0	1.750	104.00	0.00	66.00	0.00	1450.0

- (1) The motor speed which can be implemented is dependent upon the servo drive and supply modules used.
- (2) (2) For the precise calculation of the torque, the torque constant for motors MAC 071, MAC 095, MAC 095, MAC 115 and MAC 117 should be multiplied by the reduction factor RF, in accordance with the figure below.
- (3) The values indicated in parentheses apply to motors with integrated brakes.

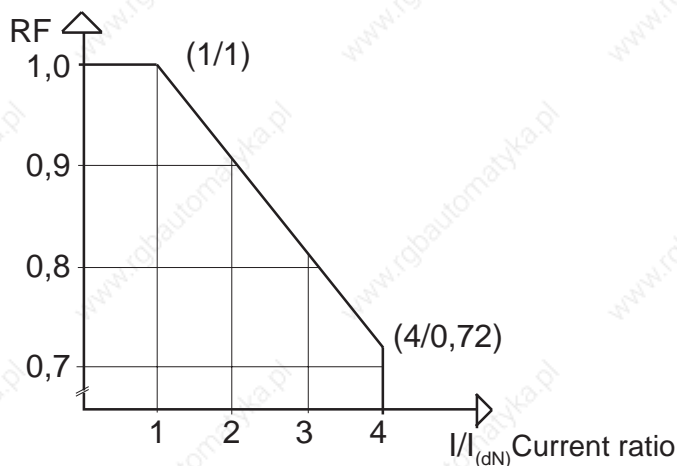

Figure 95: Summary of important data for MAC motors (additional motor data can be found in the description „Application Data MAC XXX“).

**10.2. Important Data on the Servo Drive Module**

Servo drive module for unit type	Current set-point Terminal MA		Current actual value Terminal Ired		Minimum adjustable current Imin		Corresponding Programming Module MOD	
	V/A	V/A	V/A	A	list	Imin	Without setpoint potentiometer compensation	With set-point potentiometer compensation
TDM 1.2-030-300	0.050	-	-	15		15	MOD 1	MOD 2
TDM 1.2-050-300	0.050	-	-	15		15	"	"
TDM 1.2-100-300	0.050	-	-	15		15	"	"
TDM 1.2-030-300/ SO 100	0.250	-	-	3		3	"	"
TDM 1.2-050-300/ SO 100	0.150	-	-	5		5	"	"
TDM 1.2-100-300/ SO 100	0.075	-	-	10		10	"	"
TDM 2.1-015-300	0.075	-	-	1.5		1.5	MOD 5	MOD 6
TDM 2.1-030-300	0.250	-	-	3		3	"	"
TDM 3.2-020-300	0.375	0.375	0.375	1		1	MOD 13	MOD 14
TDM 3.2-030-300	0.250	0.250	0.250	1.3		1.3	"	"
TDM 4.1-020-300	0.375	0.375	0.375	1		1	MOD 17	MOD 18
TDM 4.1-030-300	0.250	0.250	0.250	1.3		1.3	"	"
TDM 6.1-015-300	0.500	0.500	0.500	1		1	MOD 19	MOD 20
TDM 6.1-030-300	0.250	0.250	0.250	1.3		1.3	"	"
TDM 7.1-015-300	0.500	0.500	0.500	1		1	MOD 21	MOD 22
TDM 7.1-030-300	0.250	0.250	0.250	1.3		1.3	"	"
KDS 1.1-030-300	0.250	-	-	1.3		1.3	MOD 3	MOD 4
KDS 1.1-050-300	0.150	-	-	2		2	"	"
KDS 1.1-100-300	0.075	-	-	4		4	"	"
KDS 1.1-150-300	0.050	-	-	6		6	"	"

Figure 96: Summary of important data on the servo drive module (additional data outlined in the data sheets in Chapter 12).

## 11. Equipment fuses for individual modular units

The fuse types are listed on the front plates with the exception of the fan fuses which are listed on the fan plate located on the under side of the modular units.

(1) Microfuse size 5 X 20 mm			
Module type	Symbol	Fuse type	Designation
Suply module:			
TVM...-220/380	F1	Siemens Neozed 25A/380V	Power section fuse
	F2	M10A/250E	24V controller voltage supply
	F3	M6.3A/250E	Module's inherent supply
	F4	M6.3A/250E	"
	F5	0.315A/250E	Internal fan 220 V (only in TVM ...-W1-...)
TVM...-115/220	F1	Siemens Neozed 25A/380V	Power section fuse
	F2	M10A/250E	24V controller voltage supply
	F3	M10A/250E	Module's inherent supply
	F4	M10A/250E	"
	F5	0.630A/250E	Internal fan 115 V (only in TVM ...-W1-...)
KDV 1...-220	F1	Siemens Neozed 100A/380V	Power section fuse
	F2	M10A/250E	24V controller voltage supply
	F3	M6.3A/250E	Module's inherent supply
	F4	M6.3A/250E	"
	F5	0.630A/250E	Internal fan 220 V (only in KDV...-W1-...)
KDV1...-115	F1	Siemens Neozed 25A/380V	Power section fuse
	F2	M10A/250E	24V controller voltage supply
	F3	M10A/250E	Module's inherent supply
	F4	M10A/250E	"
	F5	1.25A/250E	Internal fan 115 V (only in KDV...-W1-...)
TBM.../220	F5	0.315A/250E	Internal fan 220 V
TBM.../115	F5	0.630A/250E	Internal fan 115 V
KDV 2, KDV 3,	F2	M2A/250E	24V controller voltage supply
	F3	T10A/250E	Module's inherent supply
	F4	T10A/250E	"
	F7	T10A/250E	Internal fan 220 V
	F8	T10A/250E	"
TVD	none		
External fan for cold-running technology:			
LE...-220	F6	0.630A/250E	Externally mounted fan
LE...-115	F6	1.25A/250E	Externally mounted fan
Servo drive module:			
TDM...-W1-220	F5	0.315A/250E	Internal fan 220 V (only in TDM...-W1-...)
TDM...-W1-115	F5	0.630A/250E	Internal fan 115 V (only in TDM...-W1-...)
KDS...-W1-220	F5	0.630A/250E	Internal fan 220 V (only in KDS...-W1-...)
KDS...-W1-115	F5	1.25A/250E	Internal fan 115 V (only in KDS...-W1-...)
External fan for cold-running technology:			
LE...-220	F6	0.630A/250E	Externally mounted fan
LE...-115	F6	1.25A/250E	Externally mounted fan

Figure 97: Fuses for individual modular units

## 12. Technical Data of the Servo Drive Modules

Values in [ ] apply to new modules with serial numbers starting from SN 234 ...

### Technical Data TDM1

Designation	Symbol	Unit	TDM1.2-030-300-W0	TDM1.2-030-300-W1	TDM1.2-050-300-W1	TDM1.2-100-300-W1
			natural convection	forced ventilation		
Current	I(type)	(A)	30	30	50	100
Peak current	I(peak)	(A)	30	30	50	100
Continuous current	I(cont)	(A)	25	30	45	65
<b>Link circuit d.c. voltage</b>	U(DC)	(V)	300 (± 15%)			
Power	P(cont)	(kW)	9	9	15	30
Power loss with I(cont)	P(v)	(W)	160	190	250	400
Weight	m	(kg)	9	10	10	10,5
<b>Current consumption of signal processing (without external load)</b>						
+ 24V Load voltage	I(+UL)	(mA)	750 [250]	750 [350]	950 [350]	1450 [400]
+ 15V Measuring voltage	I(+UM)	(mA)	140			
- 15V Measuring voltage	I(-UM)	(mA)	60			
<b>Current capacitance of the voltages at terminal X5 for external consumption</b>						
+ 15V Measuring voltage	I(+UM)	(mA)	15			
- 15V Measuring voltage	I(-UM)	(mA)	15			
<b>Unit fan connection</b>						
Supply voltage	U	(V)	220 or 115			
Frequency	f	(Hz)	50 ... 60 Hz			
Power consumption	P	(VA)	without	30		
<b>Operating conditions</b>						
permissible ambient temperature range with rated data	(°Centigrade)		+5 ... +45			
maximum permissible ambient temperature with reduced rated data	(°Centigrade)		55			
Storage and transport temperatures	(°Centigrade)		-30 ... +85			
Mounting altitude without reduction of rated data			max. 1000m above NN			
Permissible humidity acc. to humidity classification			F in acc. with DIN 40 040			
Insulation category			C in acc. with DIN VDE 0110			
Type of protection			IP 10 acc. to DIN 40 050			

Figure 98: Technical Data of Servo Drive Module TDM1

**Technical Data TDM 2**

Values in [ ] apply to new modules with serial numbers starting from SN 234

...

Designation	Symbol	Unit	TDM2.1-015-300-W0	TDM2.1-030-300-W0	TDM2.1-030-300-W1
<b>Type of cooling</b>			natural convection		forced ventilation
Current	I(type)	(A)	15	30	30
Peak current	I(peak)	(A)	15	30	30
Continuous current	I(cont)	(A)	15	25	30
Link circuit d.c. voltage	U(DC)	(V)	300 (± 15%)		
Power	P(cont)	(kW)	4,5	9	9
Power loss with I(cont)	P(v)	(W)	110	160	190
Weight	m	(kg)	9		10
<b>Current consumption of signal processing (without external load)</b>					
+ 24V Load voltage	I(+UL)	(mA)	750 [350]		
+ 15V Measuring voltage	I(+UM)	(mA)	140		
- 15V Measuring voltage	I(-UM)	(mA)	60		
<b>Current capacitance of the voltages at terminal X5 for external consumption</b>					
+ 15V Measuring voltage	I(+UM)	(mA)	15		
- 15V Measuring voltage	I(-UM)	(mA)	15		
<b>Fan connection</b>					
Supply voltage	U	(V)	220 or 115		
Frequency	f	(Hz)	50 - 60 Hz		
Power consumption	P	(VA)	without		30
<b>Operating conditions</b>					
permissible ambient temperature range with rated data		(°Celsius)	+5 ... +45		
maximum permissible ambient temperature with reduced rated data		(°Celsius)	55		
Storage and transport temperatures		(°Celsius)	-30 ... +85		
Mounting altitude without reduction of rated data			max. 1000m above NN		
Permissible humidity acc. to humidity classification			F in acc. with DIN 40 040		
Insulation category			C in acc. with DIN VDE 0110		
Type of protection			IP 10 acc. to DIN 40 050		

Figure 99: Technical Data of Servo Drive Module TDM2



## Technical Data TDM 3

Designation	Symbol	Unit	TDM3.2-020-300-W0	TDM3.2-030-300-W1 <sup>1)</sup>	
<b>Type of cooling</b>			natural convection	forced ventilation	
<b>Power section</b>					
Current	I(type)	(A)	20	30	
Peak current	I(peak)	(A)	20	30	
Continuous current	I(cont)	(A)	15	25	
Link circuit d.c. voltage	U(DC)	(V)	300 (± 15%)	300 (± 15%)	
Power	P(cont)	(kW)	6	9	
Power loss with I(cont)	P(v)	(W)	110	175	
Weight	m	(kg)	8	8	
<b>Current consumption of signal processing (without external load)</b>					
+ 24V Load voltage	I(+UL)	(mA)	400	800 <sup>2)</sup>	
+ 15V Measuring voltage	I(+UM)	(mA)	120	125	
- 15V Measuring voltage	I(-UM)	(mA)	50	55	
<b>Current capacitance of the voltages at terminal X43 for external consumption</b>					
+ 24V Load voltage	I(+UL)	(mA)		50	
+ 15V Measuring voltage	I(+UM)	(mA)		15	
- 15V Measuring voltage	I(-UM)	(mA)		15	
<b>Operating conditions</b>					
permissible ambient temperature range with rated data		(°Celsius)		+5 ... +45	
maximum permissible ambient temperature with reduced rated data		(°Celsius)		55	
Storage and transport temperatures		(°Celsius)		-30 ... +85	
Mounting altitude without reduction of rated data				max. 1000m above NN	
Permissible humidity acc. to humidity classification				F in acc. with DIN 40 040	
Insulation category				C in acc. with DIN VDE 0110	
Type of protection				IP 10 acc. to DIN 40 050	
<p>1) Servo drive module TDM 3.2-030-300-W1 can only be operated with one fan unit.</p> <p>2) Current consumption equals 800 mA when the 24V direct current fan unit LE5-024 is connected to the +24V of the servo drive module. Current consumption is reduced to 650 mA, if fan units LE5-220 or LE5-115 are used.</p>					
<b>Technical Data: fan unit for forced ventilation in TDM 3.2-030-300-W1</b>					
				<b>Obsolete modules</b>	
Designation	Symbol	Unit	LE5-024-..	LE5-220-..	LE-115-..
Supply voltage	U	(V)	DC24(-10%/+20%)	AC220(±10%)	AC115(±10%)
Frequency	f	(Hz)	-	50 ... 60	50 ... 60
Power consumption	P		3,6 W	20 VA	20VA
Weight	m	(kg)	1	1,17	1,17

Figure 100: Technical Data of Servo Drive Module TDM 3

## Technical Data TDM 4

Designation	Symbol	Unit	TDM4.1-020-300-W0	TDM4.1-030-300-W1 <sup>1)</sup>
<b>Type of cooling</b>			natural convection	forced ventilation
<b>Power section</b>				
Current	I(type)	(A)	20	30
Peak current	I(peak)	(A)	20	30
Continuous current	I(cont)	(A)	15	25
Link circuit d.c. voltage	U(DC)	(V)	300 (± 15%)	300 (± 15%)
Type power	P(cont)	(kW)	6	9
Power loss with I(cont)	P(v)	(W)	110	175
Weight	m	(kg)	8	8
<b>Current consumption of signal processing (without external load)</b>				
+ 24V Load voltage	I(+UL)	(mA)	400	800 <sup>2)</sup>
+ 15V Measuring voltage	I(+UM)	(mA)	150	150
- 15V Measuring voltage	I(-UM)	(mA)	60	60
<b>Current capacitance of the voltages at terminal X43 for external consumption</b>				
+ 24V Load voltage	I(+UL)	(mA)		50
+ 15V Measuring voltage	I(+UM)	(mA)		15
- 15V Measuring voltage	I(-UM)	(mA)		15
<b>Operating conditions</b>				
permissible ambient temperature range with rated data		(°Celsius)		+5 ... +45
maximum permissible ambient temperature with reduced rated data		(°Celsius)		55
Storage and transport temperatures		(°Celsius)		-30 ... +85
Mounting altitude without reduction of rated data				max. 1000m above NN
Permissible humidity acc. to humidity classification				F in acc. with DIN 40 040
Insulation category				C in acc. with DIN VDE 0110
Type of protection				IP 10 acc. to DIN 40 050

1) Servo drive module TDM 4.1-030-300-W1 can only be operated with a fan unit.

2) Current consumption is 800 mA when the 24V direct current fan unit LE5-024 is connected to the +24V of the servo drive module. Current consumption is reduced to 650 mA, if fan units LE5-220 or LE5-115 are used.

### Technical data: fan unit for forced ventilation in TDM 4.1-030-300-W1

Designation	Symbol	Unit	Obsolete modules		
			LE5-024-..	LE5-220-..	LE-115-..
Supply voltage	U	(V)	DC24(-10%/+20%)	AC220(±10%)	AC115(±10%)
Frequency	f	(Hz)	-	50 ... 60	50 ... 60
Power consumption	P		3,6 W	20 VA	20VA
Weight	m	(kg)	1	1,17	1,17

Figure 101: Technical Data of Servo Drive Module TDM 4

## Technical Data TDM 6

Designation	Symbol	Unit	TDM6.1-015-300-W0	TDM6.1-030-300-W1 <sup>1)</sup>
<b>Type of cooling</b>			natural convection	forced ventilation
<b>Power section</b>				
Current	I(type)	(A)	15	30
Peak current	I(peak)	(A)	15	30
Continuous current	I(cont)	(A)	8	12
Link circuit d.c. voltage	U(DC)	(V)	300 (± 10%)	300 (± 10%)
Power	P(cont)	(kW)	4,5	9
Power loss with I(cont)	P(v)	(W)	90	135
Weight	m	(kg)	6,5	6,5
<b>Current consumption of signal processing (without external load)</b>				
+ 24V Load voltage	I(+UL)	(mA)	250	250
+ 15V Measuring voltage	I(+UM)	(mA)	150	150
- 15V Measuring voltage	I(-UM)	(mA)	75	75
<b>Current capacitance of the voltages at terminal X43 for external consumption</b>				
+ 24V Load voltage	I(+UL)	(mA)		50
+ 15V Measuring voltage	I(+UM)	(mA)		15
- 15V Measuring voltage	I(-UM)	(mA)		15
<b>Operating conditions</b>				
Permissible ambient temperature range with rated data		(°Celsius)		+5 ... +45
Maximum permissible ambient temperature with reduced rated data		(°Celsius)		55
Storage and transport temperatures		(°Celsius)		-30 ... +85
Mounting height without reduction of rated data				max. 1000m above NN
Permissible humidity acc. to humidity classification				F in acc. with DIN 40 040
Insulation category				C in acc. with DIN VDE 0110
Type of protection				IP 10 acc. to DIN 40 050

1) Servo drive module TDM 6.1-030-300-W1 can only be operated with one fan unit.

2) Current consumption is 800 mA when the 24V direct current fan unit LE5-024 is connected to the +24V of the servo drive module. Current consumption is reduced to 650 mA, if fan units LE5-220 or LE5-115 are used.

### Technical data: fan unit for forced ventilation in TDM 6.1-030-300-W1

Designation	Symbol	Unit	Obsolete modules		
			LE5-024-..	LE5-220-..	LE-115-..
Supply voltage	U	(V)	DC24(-10%/+20%)	AC220(±10%)	AC115(±10%)
Frequency	f	(Hz)	-	50 ... 60	50 ... 60
Power consumption	P		3,6 W	20 VA	20VA
Weight	m	(kg)	1	1,17	1,17

Figure 102: Technical Data of Servo Drive Module TDM 6

## Technical Data TDM 7

Designation	Symbol	Unit	TDM7.1-015-300-W0	TDM7.1-030-300-W1 <sup>1)</sup>
<b>Type of cooling</b>			natural convection	forced ventilation
<b>Power section</b>				
Current	I(type)	(A)	15	30
Peak current	I(peak)	(A)	15	30
Continuous current	I(cont)	(A)	8	12
Intermediate circuit d.c. voltage	U(DC)	(V)	300 (± 10%)	300 (± 10%)
Type power	P(cont)	(kW)	4,5	9
Power loss with I(cont)	P(v)	(W)	90	135
Weight	m	(kg)	6,5	6,5
<b>Current consumption of signal processing (without external load)</b>				
+ 24V Load voltage	I(+UL)	(mA)	250	250
+ 15V Measuring voltage	I(+UM)	(mA)	150	150
- 15V Measuring voltage	I(-UM)	(mA)	75	75
<b>Current capacitance of the voltages at terminal X43 for external consumption</b>				
+ 24V Load voltage	I(+UL)	(mA)		50
+ 15V Measuring voltage	I(+UM)	(mA)		15
- 15V Measuring voltage	I(-UM)	(mA)		15
<b>Operating conditions</b>				
Permissible ambient temperature range with rated data		(°Celsius)		+5 ... +45
Maximum permissible ambient temperature with reduced rated data		(°Celsius)		55
Storage and transport temperatures		(°Celsius)		-30 ... +85
Mounting height without reduction of rated data				max. 1000m above NN
Permissible humidity acc. to humidity classification				F in acc. with DIN 40 040
Insulation category				C in acc. with DIN VDE 0110
Type of protection				IP 10 acc. to DIN 40 050

1) Servo drive module TDM 7.1-030-300-W1 can only be operated with a fan unit.

2) Current consumption is 800 mA when the 24V direct current fan unit LE5-024 is connected to the +24V of the servo drive module. Current consumption is reduced to 650 mA, if fan units LE5-220 or LE5-115 are used.

### Technical data: fan unit for forced ventilation in TDM 7.1-030-300-W1

Designation	Symbol	Unit	LE5-024-..	Obsolete modules	
				LE5-220-..	LE-115-..
Supply voltage	U	(V)	DC24(-10%/+20%)	AC220(±10%)	AC115(±10%)
Frequency	f	(Hz)	-	50 ... 60	50 ... 60
Power consumption	P		3,6 W	20 VA	20VA
Weight	m	(kg)	1	1,17	1,17

Figure 103: Technical Data of Servo Drive Module TDM7

## Technical Data KDS 1

Designation	Symbol	Unit	KDS1.1-030-300-W0	KDS1.1-050-300-W0	KDS1.1-100-300-W0	KDS1.1-50-300-W1	KDS1.1-100-300-W1	KDS1.1-150-300-W1
			Natural convection			Forced ventilation		
<b>Type of cooling</b>			Natural convection			Forced ventilation		
Current	I(type)	(A)	30	50	100	50	100	150
Peak current	I(peak)	(A)	30	50	100	50	100	150
Continuous current	I(cont)	(A)	25	35	45	50	93	96
Link circuit d.c. voltage	U(DC)	(V)	300 (± 15%)					
Power	P(cont)	(kW)	9	15	30	15	30	45
Power loss with internal with I(cont)	P(v-int)	(W)	60	70	90	85	150	160
Power loss external	P(v-ext)	(W)	130	150	200	220	400	430
Weight of drive module	m	(kg)	14,1	14,1	15,2	14,4	15,2	15,4
Weight of mechanical assembly set M1-KD	m	(kg)	1,7					
Weight of fan unit	m	(kg)	without LE4			4,2		
<b>Current consumption of signal processing (without external load)</b>								
+ 24V Load voltage	I(+UL)	(mA)	750	950	1450	950	1450	1950
+ 15V Measuring voltage	I(+UM)	(mA)	140					
- 15V Measuring voltage	I(-UM)	(mA)	50					
<b>Current capacitance of the voltages at terminal X25 for external consumption</b>								
+ 24V Load voltage	I(+UL)	(mA)	50					
+ 15V Measuring voltage	I(+UM)	(mA)	15					
- 15V Measuring voltage	I(-UM)	(mA)	15					
<b>Operating conditions</b>								
Permissible ambient temperature range with rated data		(°Celsius)	+5 ... +45					
Maximum permissible ambient temperature with reduced rated data		(°Celsius)	55					
Storage and transport temperatures		(°Celsius)	-30 ... +85					
Mounting altitude without reduction of rated data			max. 1000m above NN					
Permissible humidity according to humidity classification			F in acc. with DIN 40 040					
Insulation category			C in acc. with DIN VDE 0110					
Type of protection			IP 10 acc. to DIN 40 050					

Figure 104: Technical Data of Servo Drive Module KDS1

## Technical Data TVM 1

Designation	Symbol	Unit	TVM1. not ventilated	TVM1. ventilated
Current	I(type)	(A)	50	
Peak current (300ms)	I(peak)	(A)	150	
Nominal input voltage	U(ACN)	(V)	220 (± 15%)	
Link circuit d.c. voltage	U(DC)	(V)	300 (± 15%)	
Power	P(typ)	(kW)	15	15
Maximum power loss	P(v)	(W)	400	550
Bleeder peak power	P(peak)	(kW)	10	10
Bleeder continuous power	P(cont)	(W)	300	450
Maximum feedback energy	W	(kWs)	14	14
Weight	m	(kg)	14,3	15
<b>Controller voltage output</b>				
+ 24V Load voltage	U(L)	(V)	24 ... 30	
+ 24VL Continuous current	I(UL)	(A)	4	
+ 24VL Standing wave ratio		(%)	10	
± 15V Measuring voltage	U(M)	(V)	14,9 ... 15,1	
+ 15VM Continuous current	I(+UM)	(A)	0,85	
- 15VM Continuous current	I(-UM)	(A)	0,85	
± 15VM Standing wave ratio		(%)	2	
<b>Auxiliary voltage</b>				
Input alternating-current voltage	U(AC)	(V)	220/380 or 115/220	
Frequency	f	(Hz)	50 ... 60	
Voltage tolerance		(%)	+15 ... -10	
<b>Supply for unit ventilation</b>				
Supply voltage	U	(V)	dropped	220 oder 115
Frequency	f	(Hz)	dropped	50 ... 60
Power consumption	P	(W)	dropped	30
<b>Conditions of Operation</b>				
Permissible ambient temperature range with rated data		(°Celsius)	+5 ... +45	
Max. perm. ambient temperature with reduced rated data		(°Celsius)	55	
Storage and transport temperatures		(°Celsius)	-30 ... +85	
Assembly altitude without reduction of rated data			max. 1000m above NN	
Perm. humidity acc. to humidity classification			F in acc. with DIN 40040	
Insulation category			C in acc. with DIN 570110	
Type of protection			IP 10 acc. to DIN 40050	

Figure 105: Technical data of supply module TVM1

## Technical Data TVM 2

Designation	Symbol	Unit	TVM 2.1-...	TVM 2.2-....
Current	I(type)	(A)	50	
Peak current (300ms)	I(peak)	(A)	150	
Nominal input voltage	U(ACN)	(V)	220 (± 15%)	
Link circuit direct current voltage	U(DC)	(V)	300 (± 15%)	
Type power	P(typ)	(kW)	15	
Maximum power loss	P(v)	(W)	580	
Bleeder peak power	P(peak)	(kW)	10	
Bleeder continuous power	P(cont)	(W)	450	
Maximum feedback energy	W	(kWs)	14	
Weight	m	(kg)	15	
<b>Controller voltage output</b>				
+ 24V Load voltage	U(L)	(V)	24 ... 30	
+ 24VL Continuous current	I(UL)	(A)	8	
+ 24VL Standing wave ratio		(%)	10	
± 15V Measuring voltage	U(M)	(V)	14,9 ... 15,1	
+ 15VM Continuous current	I(+UM)	(A)	0,9	1,3
- 15VM Continuous current	I(-UM)	(A)	1,0	
± 15VM Standing wave ratio		(%)	2	
<b>Supply for controller voltage</b>				
Input alternating-current voltage	U(AC)	(V)	220/380 or 115/220	
Frequency	f	(Hz)	50 ... 60	
Voltage tolerance		(%)	+15 ... -10	
<b>Supply for unit ventilation</b>				
Supply voltage	U	(V)	220 or 115	
Frequency	f	(Hz)	50 ... 60	
Power consumption	P	(W)	30	
<b>Conditions of Operation</b>				
Permissible ambient temperature range with rated data		(°Celsius)	+5 ... +45	
Max. perm. ambient temperature with reduced rated data		(°Celsius)	55	
Storage and transport temperatures		(°Celsius)	-30 ... +85	
Assembly altitude without reduction of rated data			max. 1000m above NN	
Perm. humidity acc. to humidity classification			F in acc. with DIN 40040	
Insulation category			C in acc. with DIN 570110	
Type of protection			IP 10 acc. to DIN 40050	

Figure 106: Technical data of supply module TVM2

## Technical Data KDV 1.3

Designation	Symbol	Unit	KDV 1.3-100-220/300-...
Current	I(type)	(A)	100
Peak current (300ms)	I(peak)	(A)	300
Nominal input voltage	U(ACN)	(V)	220 (± 10%)
Link circuit d.c. voltage	U(DC)	(V)	300 (± 10%)
Type power	P(typ)	(kW)	max. 30
Power loss inside of control cabinet	P(v)	(W)	150
Power loss outside of control cabinet	P(v)	(W)	max. 2000
Bleeder peak power	P(peak)	(kW)	40
Bleeder continuous power	P(cont)	(kW)	2
Maximum feedback energy	W	(kWs)	60
KDV Weight	m	(kg)	21
Weight of mechanical mounting accessories	m	(kg)	1,7
Weight of bleeder protective shell	m	(kg)	1,7
Weight of fan unit LE3	m	(kg)	2,5
<b>Controller voltage output</b>			
+ 24V Load voltage	U(L)	(V)	22 ... 30
+ 24VL Continuous current	I(UL)	(A)	8
+ 24VL Standing wave ratio		(%)	10
± 15V Measuring voltage	U(M)	(V)	14,9 - 15,1
+ 15VM Continuous current	I(+UM)	(A)	1,5
- 15VM Continuous current	I(-UM)	(A)	1,5
± 15VM Standing wave ratio		(%)	0,1
<b>Supply for controller voltage</b>			
Input voltage	U(AC)	(V)	220/380 or 220/115 (+15 ... -10)%
Frequency	f	(Hz)	50 ... 60
Power consumption auxiliary voltage	P	(VA)	500
<b>Supply for unit ventilation</b>			
Supply voltage	U(AC)	(V)	220 or 115 (+15 ... -10)%
Frequency	f	(Hz)	50 ... 60
Power consumption	P	(VA)	15
<b>Conditions of Operation</b>			
Permissible ambient temperature range with rated data		(°Celsius)	+5 ... +45
Max. perm. ambient temperature with reduced rated data		(°Celsius)	55
Storage and transport temperatures		(°Celsius)	-30 ... +85
Assembly height without reduction of rated data			max. 1000m above NN
Perm. humidity acc. to humidity classification			F in acc. with DIN 40040
Insulation category			C in acc. with DIN 570110

Figure 107: Technical data of supply module KDV1



## Technical Data KDV 2.2

Designation	Symbol	Unit	KDV 2.2-100-220/300-220
Current	I(type)	(A)	100
Peak current (300ms)	I(peak)	(A)	300
Nominal input voltage	U(ACN)	(V)	220 (± 10%)
Link circuit d.c. voltage	U(DC)	(V)	300 (± 10%)
Type power	P(typ)	(kW)	max. 30
Power loss inside of control cabinet	P(v)	(W)	150
Power loss outside of control cabinet	P(v)	(W)	max. 2000
Bleeder peak power	P(peak)	(kW)	40
Bleeder continuous power	P(cont)	(kW)	2 (shutdown occurs at 2.5kW)
Maximum feedback energy	W	(kWs)	100
KDV Weight	m	(kg)	17
Weight of mechanical mounting accessories	m	(kg)	1,7
Weight of bleeder protective shell	m	(kg)	1,7
Weight of fan unit LE3	m	(kg)	2,5
<b>Controller voltage output</b>			
+ 24V Load voltage	U(L)	(V)	22 ... 26
+ 24VL Continuous current	I(UL)	(A)	12
+ 24VL Standing wave ratio		(%)	2
± 15V Measuring voltage	U(M)	(V)	14,9 ... 15,1
+ 15VM Continuous current	I(+UM)	(A)	2
- 15VM Continuous current	I(-UM)	(A)	2
± 15VM Standing wave ratio		(%)	0,1
<b>Auxiliary voltage and fan supply</b>			
Input voltage	U(AC)	(V)	220
Frequency	f	(Hz)	50 ... 60
Voltage tolerance		(%)	+10 ... -10
Power consumption auxiliary voltage	P	(VA)	500
Power consumption fan supply	P	(VA)	1000
<b>Conditions of operation</b>			
Permissible ambient temperature range with rated data		(°Celsius)	+5 ... +45
Max. perm. ambient temperature with reduced rated data		(°Celsius)	55
Storage and transport temperatures		(°Celsius)	-30 ... +85
Assembly altitude without reduction of rated data			max. 1000m above NN
Perm. humidity acc. to humidity classification			F in acc. with DIN 40040
Insulation category			C in acc. with DIN 570110
Type of protection			IP 10 ac. to DIN 40050

Figure 108: Technical data of supply module KDV2

## Technical Data KDV 3.1

Designation	Symbol	Unit	KDV 3.1-100-220/300-220
<b>Power section</b>			
Type current	I(type)	(A)	100
Peak current (300ms)	I(peak)	(A)	160
Nominal input voltage	U(ACN)	(V)	3 x 220 ( $\pm 10\%$ ) 50 ... 60 Hz
Link circuit d.c. voltage	U(DC)	(V)	300 ( $\pm 10\%$ )
Feed-in continuous power	P(cont)	(kW)	30 (with additional capacity 4 mF) 22 (with additional capacity 2 mF) 14 (without additional capacity)
Feed-in peak power	P(peak)	(kW)	48
Feedback continuous power	P(RD)	(kW)	20 (with additional capacity 2 mF) 14 (without additional capacity)
Feedback peak power	P(RS)	(kW)	40
Bleeder continuous power	P(BD)	(W)	0
Bleeder peak power	P(BM)	(kW)	40
Maximum feedback energy with power off	W	(kWs)	100
Power loss inside control cabinet	P(v)	(W)	150
Power loss outside control cabinet	P(v)	(W)	500
KDV Weight	m	(kg)	21
Weight of mechanical mounting accessories	m	(kg)	1,7
Weight of fan unit LE4	m	(kg)	4,2
<b>Controller voltage output</b>			
+ 24V Load voltage	U(L)	(V)	22 ... 26
+ 24VL Continuous current	I(UL)	(A)	11,5
+ 24VL Standing wave ratio		(%)	2
$\pm 15V$ Measuring voltage	U(M)	(V)	14,9 ... 15,1
+ 15VM Continuous current	I(+UM)	(A)	2
- 15VM Continuous current	I(-UM)	(A)	2
$\pm 15VM$ Standing wave ratio		(%)	0,1
<b>Auxiliary voltage and fan supply</b>			
Input voltage	U(AC)	(V)	220 ( $\pm 10\%$ )
Frequency	f	(Hz)	50 ... 60
Power consumption auxiliary voltage	P	(VA)	500
Max. power consumption of fan supply	P	(VA)	1000
<b>Conditions of operation</b>			
Permissible ambient temperature range with rated data		(°Celsius)	+5 ... +45
Max. perm. ambient temperature with reduced rated data		(°Celsius)	55
Storage and transport temperatures		(°Celsius)	-30 ... +85
Assembly height without reduction of rated data			max. 1000m above NN
Perm. humidity acc. to humidity classification			F in acc. with DIN 40040
Isulation category			C in acc. with DIN 570110
Type of protection			IP 10 acc. to DIN 40050

Figure 109: Technical data of supply module KDV3

## Technical Data KDV 4.1

Designation	Symbol	Unit	KDV 4.1-30-3
<b>Input power section</b>			
Nominal input voltage	U(ACN)	(V)	3 x 380 ... 460 ( $\pm 10\%$ ) 50 ... 60 Hz
<b>Output power section</b>			
Link circuit direct current voltage	U(DC)	(V)	320 ( $\pm 10\%$ )
Link circuit continuous power	P(cont)	(kW)	30 (with additional capacity 4 mF) 22 (with additional capacity 2 mF) 14 (without additional capacity)
Link circuit peak power	P(peak)	(kW)	48
Feedback continuous power	P(RD)	(kW)	20 (with additional capacity 2 mF) 14 (without additional capacity)
Feedback peak power	P(RS)	(kW)	40
Bleeder continuous power	P(BD)	(W)	0
Bleeder peak power	P(BM)	(kW)	40
Maximum feedback energy with power off	W	(kWs)	100
Power loss inside control cabinet	P(v)	(W)	150
Power loss outside control cabinet	P(v)	(W)	500
KDV Weight	m	(kg)	21
Weight of mechanical mounting accessories	m	(kg)	1,7
Weight of fan unit LE4	m	(kg)	4,2
<b>Controller voltage output</b>			
+ 24V Load voltage	U(L)	(V)	22 ... 26
+ 24VL Continuous current	I(UL)	(A)	11,5
+ 24VL Standing wave ratio		(%)	2
$\pm 15V$ Measuring voltage	U(M)	(V)	14,9 ... 15,1
+ 15VM Continuous current	I(+UM)	(A)	2
- 15VM Continuous current	I(-UM)	(A)	2
$\pm 15VM$ Standing wave ratio		(%)	0,1
<b>Auxiliary voltage and fan supply</b>			
Input voltage	U(AC)	(V)	220 ( $\pm 10\%$ )
Frequency	f	(Hz)	50 ... 60
Power consumption auxiliary voltage	P	(VA)	500
Max. power consumption of fan supply	P	(VA)	1000
<b>Conditions of operation</b>			
Permissible ambient temperature range with rated data		(°Celsius)	+5 ... +45
Max. perm. ambient temperature with reduced rated data		(°Celsius)	55
Storage and transport temperatures		(°Celsius)	-30 ... +85
Assembly height without reduction of rated data			max. 1000m above NN
Perm. humidity acc. to humidity classification			F in acc. with DIN 40040
Insulation category			C in acc. with DIN 570110
Type of protection			IP 10 acc. to DIN 40050

Figure 110: Technical data of supply module KDV4

## Technical Data TVD 1

Designation	Symbol	Unit	TVD 1.2-15-3	TVD 1.2-08-3
<b>Power section</b>				
Input voltage	U(ACN)	(V)	3 x 380 ... 460 ( $\pm 10\%$ )	
Frequency	f(N)	(Hz)	50 ... 60	
Link circuit direct current voltage	U(DC)	(V)	320 ( $\pm 5\%$ )	
Link circuit continuous power	P(DC)	(kW)	15	7,5
Link circuit peak power	P(KB-03)	(kW)	45	22,5
Bleeder continuous power	P(BD)	(kW)	1	0,5
Bleeder peak power	P(BM)	(kW)	40	20
Maximum feedback energy	W(max)	(kWs)	60	30
Power loss with unit at maximum load	P(v)	(W)	330	180
Weight	m	(kg)	11,2	10,5
<b>Controller voltage output</b>				
Input voltage	U(AC)	(V)	3 x 380 ... 460 ( $\pm 10\%$ )	
Frequency	f(N)	(Hz)	50 ... 60	
Power consumption	S(el)	(VA)	300	
<b>Controller voltage output</b>				
+ 24V Load voltage	U(L)	(V)	22 ... 26	
+ 24VL Continuous current	I(UL)	(A)	7,5	
+ 24VL Standing wave ratio		(%)	2	
$\pm 15V$ Measuring voltage	U(M)	(V)	14,9 ... 15,1	
+ 15VM Continuous current	I(+UM)	(A)	2,5	
- 15VM Continuous current	I(-UM)	(A)	1,5	
$\pm 15VM$ Standing wave ratio		(%)	0,1	
<b>Conditions of operation</b>				
Permissible ambient temperature range with rated data	T(um)	( $^{\circ}\text{C}$ )	+5 ... +45	
Max. perm. ambient temperature with reduced rated data	T(umr)	( $^{\circ}\text{C}$ )	55	
Storage and transport temperatures	T(L)	( $^{\circ}\text{C}$ )	-30 ... +85	
Assembly height without reduction of rated data			max. 1000m above NN	
Perm. humidity acc. to humidity classification			F in acc. with DIN 40 040	
Insulation category			C in acc. with DIN 570 110	
Type of protection			IP 10 acc. to DIN 40 050	

Figure 111: Technical data of supply module TVD1

## 13. Type Designation of Drive Components (Type Codes)













## 14. Summary of the most important standards for INDRAMAT drive components

Status: 02.93

Germany <b>DIN VDE-Norm</b>	Europe <b>EN-Norm</b>	International <b>IEC-Norm</b>	Defines
DIN VDE 0160			Electronic resources such as: - Supply module (TVM, KDV, TVD), - Drive controllers (TDM, KDS, KDA, DDS) - Compact controllers (DSC, RAC) - Motor feedback electronics, Geber
DIN VDE 0530	EN 60034	IEC 34-1	Motors (MAC, 2AD, 1MB, MDD)
DIN VDE 0532		IEC 76-1 IEC 14 (CO)75	Transformers, Impedance coils (DST, DTT, DLT, GLD)
DIN VDE 0250 DIN VDE 0471 DIN VDE 0289 DIN VDE 0113	EN 60204-1	IEC 204-1, IEC 550	Cable, insulated leads
DIN VDE 0627			Plug connections
DIN VDE 0113	EN 60204-1	IEC 204-1 IEC 550	Complete drive systems
DIN VDE 0558		IEC 22B (CO) 50	Semi-conductor rectifier - Supply module (TVM, KDV; TVD), - Drive controllers (TDM, KDS; KDA; DDS) - Compact controllers (DSC, RAC)
DIN VDE 0550			Small transformers
DIN VDE 0302		IEC 505	Insulation, insulating systems
DIN VDE 0110		IEC 664	Insulation coordination, air and leakage paths of all equipment
DIN VDE 0100		IEC 64	Construction of power plants below 1000 volts
DIN VDE 0105		IEC 64	Power plant operation
DIN VDE 0106		IEC 64	Protection categories, dangerous body currents

**15. List of key words****A**

Acceleration times 117  
 Action to be taken 138  
 adaptor board AP 9 77  
 adjustment 119  
 air ducts 100  
 ambient air 100  
 ambient temperature 63, 136  
 application-specific functions 11  
 Applications 11  
 arrangement of modular units 54  
 AUX. VOLT 127  
 auxiliary mains power 127

**B**

basic torque 117  
 Bb contact 121, 122, 136  
 Bb1 CLOSED 131  
 Bb1 contact 119, 121  
 BLC 1 133  
 BLC 2 133  
 BLC 3 133  
 BLC signals 134  
 BLEEDER OVERLOAD 129  
 Blocking brake 108  
 brake 108  
 BS 137  
 bus cable 76  
 Bus connection X1 91  
 Bus connections X1 104  
 BVW contact 123

**C**

cable screens 78  
 cable shield 80  
 cable X1.1 121  
 Check 102  
 checking 99  
 cing device 64  
 Circuit diagram MOD 1 43  
 Clearing a Fault 125  
 cold-running technology 62  
 Commissioning 96  
 commissioning 101  
 Connecting plan 82  
 connection 76  
 Connection accessories 76  
 connection plan 84  
 Control cabinet internal temperature 129  
 control cabinets 100  
 Control circuit signal 17  
 Control voltage 132  
 control voltage 108, 126  
 controller enable 112  
 controller enabling signal 52  
 Controller release 136  
 controller voltage 111  
 cross-sections 103  
 current 117

## **D**

Data on the Servo Drive Module 157  
Deceleration energy 128  
dew 100  
diagnostic 108  
Diagnostic displays 125  
Diagnostics 119, 138  
differential input 18  
Dimensions sheet 64  
direction of rotation 19  
discharge time 110  
disruptive reflections 79  
Drift compensation 20, 113  
Drive Configuration 115

## **E**

EARTH CON 129  
Earthing Connections 81  
electrical connecting accessories 55  
electrostatic loads 99  
eliminate faults 119  
emergency off situations 109  
emergency-off button 111  
Emergency-Off Functions 109  
emergency-off options 101  
emergency-off switch 97  
Emergency-stop function 23  
enable signal 108  
enabling signal 52  
encoder 80  
environmental influences 99  
Equipment fuses 158  
Equipment Replacement 140  
Excess current 130

## **F**

fault 125  
fault causes 125  
Fault messages 121  
Fault-Finding 119  
fault-finding 121  
Faults 121  
feedback cable 94  
Feedback Energy 118  
filters 100  
flush mounting equipment 54  
front view 55

## **G**

gasket 62  
Ground leak 130  
ground leak 137  
Grounding 104

## **H**

heatsink 62  
high-frequency equipment 81, 98

## 15. List of key words

---

High-voltage checks 99  
HSM contact 124  
Humidity 99

### I

immunity to interference 77  
Impure air 100  
Input weighting 37  
input weightings 114  
inputs/outputs 52  
Inside temperature of control cabinet 131, 136  
Instability 116  
interface signals 121  
interference 80  
ired input 22

### K

K1NC contact 124  
K1NO contact 124

### L

line connection X1 54  
Line cross-section 76  
link circuit busbars 110  
link circuit short circuit 109  
link circuit voltage 110  
low voltages 99

### M

MAC servo motor 17  
mains power 127  
mains auxiliary voltage 132  
mains auxilliary voltage 102  
MAINS FAULT 127  
mains power 125  
mains voltage 135  
master switch 98, 109  
master-slave drive 23, 26, 112  
Maximum cable length 77  
measures 125  
mechanical brake 119  
mechanics 116  
minimum clearance 64  
motor brake 77  
motor cable 131  
motor current 117  
Motor Data 154  
motor feedback cable 133  
Motor feedback cables 79  
Motor power cable 77  
motor power cable 92  
motor temperature 77  
motor thermostat contact 77  
motor type 37  
mounting altitude 63  
mounting dimensions 64  
mounting frame 62

### N

NC 113, 118, 121

## 15. List of key words

---

NC operation 112  
NCB bridge 121  
NH contact 124

### O

oscillations 116  
OVERCURRENT 130  
OVERVOLT FUSE 128  
OVERVOLTAGE 128

### P

Plug connection 92  
plug-in terminal X1 119  
plug-in terminals 80  
position control loop 114  
Position return 80  
position-control loop 101, 115  
Power or PWR 135  
Power Reduction 63  
power wiring 103  
Power-Up Sequence 106  
Preferred arrangement of modular units 54  
problem 119  
programming module 18, 37, 39  
programming module MOD 116  
Protecting the machine 101  
Protection 97  
Protection of Equipment and Machinery 98  
Protection of Personnel 54  
prototype commissioning 112, 115  
purpose of service 98

### R

radio 98  
Radio Equipment 81  
Radio Interference Suppression 82  
rated speed of the motor 53  
Rating plate 39  
rating plate 37, 102, 117  
rating plate details 37  
Rating plate of MAC motor 41  
Rating plate of servo drive module 41  
ready to operate 136  
ready-made cable 77, 79  
ready-to-operate 119  
reduced motor current 22  
Reduction 63  
refrigerators 100  
Repair Card 141  
replacing programming module MOD 102  
resonance vibrations 115  
Reversing the direction of rotation 20  
RF 136  
right rotational field 126  
Rotor position signals 133

### S

safety guidelines 54  
Safety of Personnel 96  
servo applications 11

## 15. List of key words

---

set-point encoder 111  
Set-point smoothing 19  
set-point smoothing 37, 114  
Shielding 104  
Short-circuit 130, 137  
shut down 122  
Signal lines 80  
slave drive 23, 112  
Smoothing 19  
smoothing 37  
soaring of the mechanics 112  
sources of interference 81  
Speed 15  
Speed-controlled drive 18  
stability 115  
standards 179  
Stopping 113  
summing input 18  
supply module 15, 102, 104  
suppress interference 81  
switching on 98

### **T**

Tacho 133  
Tacho voltage 53  
tandem drive 23  
Technical Data 159  
TEMP. FAULT 131  
temperature 64  
temperature of the control cabinet 99  
Temperature pre-warning 136  
Terminal Strip 138  
terminal strip 80  
thermostat contact 77  
tools 98  
Torque 15, 117  
torque 20, 53  
Torque reduction 22  
TS 136  
TÜ 137  
TÜ contact 122  
TVW contact 123  
Type Designation 173  
type designations 102  
type of servo drive 37

### **U**

UD contact 123

### **V**

Ventilation requirements 104

### **W**

weight compensation 117  
Weighting kMA 53  
wiring diagrams 82

### **Z**

zero drift 20  
zero speed set-point 114





256496

Printed in Germany

