

Typ3 osa

Connectivity Requirements



Edition

103

Typ3 osa

Connectivity Requirements

1070 073 736-103 (99.05) GB



© 1995 – 1999

by Robert Bosch GmbH, Erbach / Germany
All rights reserved, including applications for protective rights.
Reproduction or handing over to third parties are subject to our written permission.

Discretionary charge 20.00 DM

Contents

	Page	
1	Safety Instructions	1-1
1.1	Proper use	1-1
1.2	Qualified personnel	1-3
1.3	Safety markings on products	1-4
1.4	Safety instructions in this manual	1-5
1.5	Safety instructions concerning the product described	1-6
1.6	Documentation, software release and trademarks	1-9
2	Typ3 osa System Overview	2-1
2.1	Typ3 osa-compact	2-3
2.2	Typ3 osa-modular	2-5
2.3	Standards applied	2-8
2.4	Conditions of application	2-8
3	Modules	3-1
3.1	osa master L, osa master XL	3-1
3.1.1	Connectors	3-4
3.1.2	S1 Rotary Switch	3-7
3.1.3	H1 Diagnostic Display	3-10
3.1.4	PC Card (PCMCIA Card)	3-12
3.2	osa plc (ICL 700)	3-13
3.2.1	Connectors	3-14
3.3	osa profibus fms	3-17
3.4	osa dc interface / osa dc interface ana	3-18
3.4.1	Connectors	3-19
3.4.2	RESET Key	3-25
3.4.3	LED's	3-25
3.4.4	F1 Fuse	3-25
3.4.5	Battery Compartment	3-26
4	PC Control Panels	4-1
4.1	Technical data	4-2
4.1.1	Overview	4-2
4.1.2	osa display (display unit)	4-3
4.2	Power connections	4-4
4.3	Interfaces	4-7
4.3.1	Overview	4-7
4.3.2	Serial interfaces COM1 and COM2	4-8
4.3.3	LPT1 parallel port	4-12
4.3.4	3.5" Floppy disk drive interface	4-13
4.3.5	Ethernet interface	4-15
4.3.6	SVGA interface	4-16
4.3.7	MF2 interface	4-16
4.3.8	Free ISA slots	4-17
4.4	osa keyboard	4-19
4.5	osa switch (Machine Control Panel)	4-21
4.5.1	Connection to osa master	4-22
4.5.2	Connection of EMERGENCY-STOP mushroom striker	4-23
4.5.3	Connection of digital handwheel/manual operating unit	4-24
4.5.4	Connection of additional external keys	4-25
4.5.5	Front-sided interface	4-26

5	Installation	5-1
5.1	osa rack 2 for Typ3 osa-compact	5-1
5.2	osa rack 2 for Typ3 osa-modular	5-3
5.3	osa rack 4 for Typ3 osa-modular	5-4
5.4	PC Control Panels "osa display pc" and "typ3 compact pc" ...	5-5
5.5	osa switch (machine control panel)	5-9
6	Electrical Connection	6-1
6.1	Notes on Protective Earth (PE) Connectors and Screening ...	6-2
6.2	Interference Suppression Information	6-3
6.3	Power Supply	6-5
6.3.1	24 VDC Power Supply	6-5
6.3.2	230/115 VAC supply	6-6
6.4	Power Connections	6-7
7	3.5" Floppy Disk Drive	7-1
7.1	Control elements	7-1
7.2	Connectors	7-2
7.3	Installation	7-3
7.4	Installation cut-out	7-4
7.5	Dimensions	7-4
7.6	Software installation	7-5
8	Maintenance and Spare Parts List	8-1
8.1	Maintenance	8-1
8.2	Spare Parts List	8-2
8.2.1	osa rack for Typ3 osa-modular	8-2
8.2.2	osa rack for Typ3 osa-compact	8-2
8.2.3	Plug-in modules for osa rack	8-2
8.2.4	PC Control Panels (with integrated PC)	8-3
8.2.5	osa keyboard	8-4
8.2.6	Floppy disk drive	8-4
8.2.7	Software for modular PC Control Panel	8-4
8.2.8	Machine control panel	8-5
8.2.9	Cables	8-6
8.2.10	Accessories	8-6
A	Appendix	A-1
A.1	Abbreviations	A-1
A.2	Index	A-2

1 Safety Instructions

Please read this manual before commissioning the Typ3 osa. Store this manual in a place to which all users have access at any time.

1.1 Proper use

This manual contains all information required for the proper use of the control unit. For reasons of clarity, however, it cannot contain each and every detail about each and all combinations of functions. Likewise, as the control unit is usually part of a larger installation or system, it is impossible to consider each and any aspect of integration or operation.

The Typ3 osa is used to

- activate feed drives, spindles and auxiliary axes of a machine tool via SERCOS interface for the purpose of guiding a processing tool along a programmed path to process a workpiece (CNC). Furthermore, a PLC is required with appropriate I/O components which – in communication with the actual CNC – controls the machine processing cycles holistically and acts as a technical safety monitor.
- program contours and the processing technology (path feedrate, spindle speed, tool change) of a workpiece.

Any other application is deemed improper use!

The products described

- have been developed, manufactured, tested and documented in compliance with the safety standards. These products pose no danger to persons or property if they are used in accordance with the handling stipulations and safety notes prescribed for their configuration, mounting, and proper operation.
- comply with the requirements of
 - the EMC Directives (89/336/EEC, 93/68/EEC and 93/44/EEC)
 - the Low-Voltage Directive (73/23/EEC)
 - the harmonized standards EN 50081-2 and EN 50082-2
- are designed for operation in industrial environments (emission class A), i.e.
 - no direct connection to public low-voltage power supply,
 - connection to the medium- or high-voltage system via a transformer.

In residential environments, in trade and commerce as well as small enterprises class A equipment may only be used if it does not inadmissibly interfere with other equipment.

 **This is a class A device which may cause radio interference in residential environments. In this case, the operator may be required to take suitable countermeasures and to bear the cost of the same.**

The faultless, safe functioning of the product requires proper transport, storage, erection and installation as well as careful operation.



CAUTION

This product was examined by us for "Year 2000 Compliance" using our operating, programming, visualization and control software, and passed the relevant tests.

We should like to point out that the "Year 2000 Compliance" may get lost if additional software packages are installed, for which the customer is responsible.

Examples of a possible loss of "Year 2000 Compliance" known to us include:

- 1. If other software packages are installed, parts of the software supplied by us may be overwritten (e.g. DLL's).**
- 2. The additionally installed software reads the date directly from the BIOS or even the date/time module. In order to correct the date after the millennium change, it will be sufficient to restart the unit.**
- 3. Some components of Microsoft products (e.g. the File Manager and the Explorer) are limited as to "Year 2000 Compliance". For more information, please refer to the Microsoft web pages at <http://www.eu.microsoft.com/ithome/topics/year2k/product/product.htm> .**

1.2 Qualified personnel

The requirements as to qualified personnel depend on the qualification profiles described by ZVEI (central association of the electrical industry) and VDMA (association of German machine and plant builders) in:

Weiterbildung in der Automatisierungstechnik
edited by: ZVEI and VDMA
MaschinenbauVerlag
Postfach 71 08 64
D-60498 Frankfurt.

The present manual is designed for NC project engineers and NC specialists.

Programming, start and operation as well as the modification of program parameters is reserved to properly trained personnel! This personnel must be able to judge potential hazards arising from programming, program changes and in general from the mechanical, electrical, or electronic equipment.

Interventions in the hardware and software of our products, unless described otherwise in this manual, are reserved to our specialized personnel.

Tampering with the hardware or software, ignoring warning signs attached to the components, or non-compliance with the warning notes given in this manual can result in serious bodily injury or property damage.

Only electrotechnicians as recognized under VDE 1000-10 who are familiar with the contents of this manual may install and service the products described.

Such personnel are

- those who, being well trained and experienced in their field and familiar with the relevant norms, are able to analyze the jobs being carried out and recognize any hazards which may have arisen.
- those who have acquired the same amount of expert knowledge through years of experience that would normally be acquired through formal technical training.

Please note our comprehensive range of training courses.

Our training center will be pleased to provide you with further information, telephone: +49 (0) 6062 78-258.

1.3 Safety markings on products



Warning of dangerous electrical voltage!



Warning of danger caused by batteries!



Components sensitive to electrostatic discharge!



Warning of hazardous light emissions (optical fiber cable emissions)



Disconnect from mains before opening!



Pin for connecting PE conductor only!



Connection of shield conductor only

1.4 Safety instructions in this manual



DANGEROUS ELECTRICAL VOLTAGE

This symbol is used to warn of a **dangerous electrical voltage**. The failure to observe the instructions in this manual in whole or in part may result in **personal injuries**.



DANGER

This symbol will be used if the failure to observe the instructions in this manual in whole or in part may result in **personal injuries**.



CAUTION

This symbol will be used if the failure to observe the instructions in this manual in whole or in part may result in **damages to equipment or data files**.

 This symbol will be used to draw the user's attention to special circumstances.

1.5 Safety instructions concerning the product described

**DANGER**

Retrofits or modifications may adversely affect the safety of the products described!

The consequences may include severe injuries, damage to equipment, or environmental hazards. Possible retrofits or modifications to the system using third-party equipment therefore have to be approved by Bosch.

**DANGER**

Danger of life through inadequate EMERGENCY-STOP devices! EMERGENCY-STOP devices must be active and within reach in all system modes. Releasing an EMERGENCY-STOP device must not result in an uncontrolled restart of the system! First check the EMERGENCY-STOP circuit, then switch the system on!

**DANGER**

Danger for persons and equipment!

First every new program should be thoroughly tested without axis movement! In the "Automatic" group operating mode, the control offers the opportunity to inhibit axis movements and/or the output of auxiliary functions by pressing certain softkeys.

**DANGEROUS ELECTRICAL VOLTAGE**

Unless described otherwise, maintenance works must be performed on inactive systems! The system must be protected against unauthorized or accidental reclosing.

Measuring or test activities on the live system are reserved to qualified electrical personnel!

**DANGER**

Tool or axis movements!

Feed and spindle motors generate very powerful mechanical forces and can accelerate very quickly due to their high dynamics.

- Always stay outside the danger area of the machine when it is running!
 - Do not ever deactivate the safety-relevant functions of the unit!
 - Report any malfunction of the unit to your servicing and repairs department immediately!
-

**DANGER**

Getting caught by moving parts of machinery!

During careless handling of machines with moving parts, clothes or long hair may get caught in the mechanics, pulling operators into the machine!

- Wear a hair net!
- Wear a protective suit!
- Take off protective gloves before working near moving parts!
- Take off any jewelry and wristwatches!

**DANGER**

Remember that chippings may be cast out during operation of the machine!

They can cause eye injuries and burns.

- Wear protective goggles!
- Wear a protective suit !

**DANGER**

Sharp edges on workpieces and tools!

- Wear protective gloves!

**CAUTION**

Only spare parts approved by Bosch may be used!

**CAUTION**

Observe all precautions for ESD protection when handling modules and components! Avoid electrostatic discharge!

The following protective measures must be observed for modules and components sensitive to electrostatic discharge (ESD)!

- The personnel responsible for storage, transport, and handling must have been trained for ESD protection.
- ESD-sensitive components must be stored and transported in their prescribed protective packaging.
- ESD-sensitive components may only be handled at special ESD-workplaces.
- Personnel, working surfaces, as well as all equipment and tools which get in contact with ESD-sensitive components must have the same potential (e.g., by grounding).
- Wear an approved grounding bracelet. The grounding bracelet must be connected with the working surface through a cable with an integrated resistor of 1 MΩ.

- ESD-sensitive components must by no means get in contact with chargeable objects, including most plastic materials.
- When ESD-sensitive components are installed in or removed from equipment, the equipment must be de-energized.

1.6 Documentation, software release and trademarks

Documentation

The present manual provides information on operating conditions and hardware components of the Typ3 osa.

Overview of available documentation	Part no.	
	German	English
Interface conditions for project engineering and maintenance	1070 073 704	1070 073 736
Operating instructions Standard operator interface	1070 073 726	1070 073 739
Operating instructions – Diagnostics	1070 073 779	1070 073 780
DIN programming instructions for programming to DIN 66025	1070 073 725	1070 073 738
CPL programming instructions	1070 073 727	1070 073 740
ICL700 system description, program structure of the integrated PLC	1070 073 706	1070 073 737
ICL700 project planning manual, software interfaces and CNC interface signals of the integrated PLC	1070 073 728	1070 073 741
MACODA operation and configuration of the machine parameters	1070 073 705	1070 073 742
Tool Management Parameter Setting	1070 073 782	–
Software PLC Development Environment for Windows NT	1070 073 783	1070 073 792
Measuring Cycles for Touch-Trigger Switching Probes	1070 073 788	1070 073 789

 **In the present manual, the floppy disk drive is always drive A, the fixed disk is drive C.**

Special keys or combinations of keys are represented by pointed brackets:

- Special keys: e.g. <enter>, <pgup>,
- Key combinations (pressed simultaneously): e.g. <ctrl> + <pgup>

★ This asterisk symbol refers to an activity to be performed by the user.

Version

- ☞ **This description refers to version:
Software: 4.3**
- ☞ **The current release number of the individual software modules can be viewed by selecting the "Control-Diagnostics" softkey in the "Diagnostics" group operating mode.**
- ☞ **The software version of Windows95 or WindowsNT is displayed by selecting the "My Computer" icon on the Start screen and then the HELP menu, item "About Windows95" or "About WindowsNT".**

Modifications

Modifications in the present manual as compared to the previous edition are marked by black vertical bars on the margin.

Trademarks

All trademarks for software installed on Bosch products upon delivery are the property of the respective manufacturers.

Upon delivery, all installed software is copyright-protected. The software may only be reproduced with the approval of Bosch or in accordance with the license agreement of the respective manufacturer.

MS-DOS® and Windows™ are registered trademarks of Microsoft Corp.

PROFIBUS® is a registered trademark of PROFIBUS Nutzerorganisation e. V.

SERCOS interface® is a registered trademark of Interessengemeinschaft SERCOS interface e.V.

2 Typ3 osa System Overview

Two system variants of Typ3 osa are available:

- **Typ3 osa-compact:**

The system unit of Typ3 osa is completely coupled to the PC Control Panel (osa display PC).

- **Typ3 osa-modular:**

The system unit is installed as an independent rack in the switch cabinet. The PC Control Panel is located on the machine.

Each system variant is a combination of the following modules and PC Control Panels (for part numbers, refer to section 8):

Baugruppen

- **osa master L**

Computer module for NC core and system coordination. Functions:

- Management of the entire data traffic on the system bus of the control unit and of the entire Typ3 osa file system
- Block processing of part programs, plus interpolation
- Communicating with the drives via SERCOS interface. Connection of 1 optical fiber cable ring.
- Communicating with the PC Control Panel via 10-Base-T Ethernet
- Communicating with external devices (e.g. PC) via V24 interface
- Debugging via 2nd V24 interface (only in conjunction with the "osa dc interface" module)
- Accepting a PCMCIA Card (portable memory medium, e.g. for customer programs, program cycles or even system software).

- **osa master XL**

Computer module similar to osa master L, but with additional 2nd optical fiber cable ring for drives with SERCOS interface.

- **osa plc**

High-performance PLC controller. Functions:

- Processing / linking of digital signals
- Communicating with external programming device
- Connecting a PLC expansion unit with I/O periphery via CMOS bus. For available PLC components, refer to "CL500 control manual". Furthermore, the plug-in PLC module "E24V/DC, 95-fold" is available.



The osa plc module can only be used together with the "Typ3 osa-modular" variant. For a description of the functional scope and performance, refer to the "ICL700 system description" manual.

- **osa profibus fms**

Interface module comprising 1 x RS 485 and 1 x optical fiber cable. Functions:

- Communicating with external devices via Profibus FMS to DIN 19245 Parts 1 and 2

- **osa dc interface**

24 V power supply with peripheral interfaces. Functions:

- Power supply to Typ3 osa components (except PC Control Panel in "Typ3 osa-modular" system variant)
- Buffering of all Typ3 osa RAM areas via backup battery
- Capture of max. 8 digitale high-speed input signals
- Generating max. 6 digital high-speed output signals
- Communicating with external devices via Profibus DP interface
- Controlling the READY2 contact (readiness signalling)
- Typ3 osa RESET function
- Controlling RESET-Out contact.

- **osa dc interface ana**

24 V power supply with peripheral interfaces. Additional functions compared to osa dc interface:

- D/A conversion for 4 analog output signals
- A/D conversion for 8 analog input signals
- Communication with external devices via Bitbus OFC interface

PC Control Panels

- **osa display pc**

The PC Control Panel comprises the following individual components:

- osa display with TFT flat screen
- PC, coupled to osa display
- osa keyboard (the "osa switch" machine control panel may be optionally used)

Functions:

- Communicating between Typ3 osa and the user via the standard operator interface
- Connecting a digital handwheel (to osa switch)
- other functions can be performed via the integrated PC (e.g. WOP programming, management of part programs, CNC data backup, printer control, etc.)

- **typ3 compact pc**

The PC Control Panel comprises the following individual components:

- osa display with TFT flat screen
- PC, coupled to osa display
- osa keyboard (the "osa switch" machine control panel may be optionally used)
- osa rack 2

Functions:

- Accommodating the Typ3 osa modules in the osa rack 2
- Communication between Typ3 osa and the user via the standard operator interface
- Connecting a digital hand wheel (to osa switch)
- other functions can be performed via the integrated PC (e.g. WOP programming, management of part programs, CNC data backup, printer control, etc.)

2.1 Typ3 osa-compact

All CNC components are accommodated within the operating range of the machine. In the event that the PC Control Panel "typ3 compact pc" with 24VDC power supply is used, the "osa dc interface" module will also power the integrated PC.

Components:

- PC Control Panel "typ3 compact pc"
- osa master L/XL
- osa dc interface or osa dc interface ana
- osa rack 2
- Software PLC for PLC functions

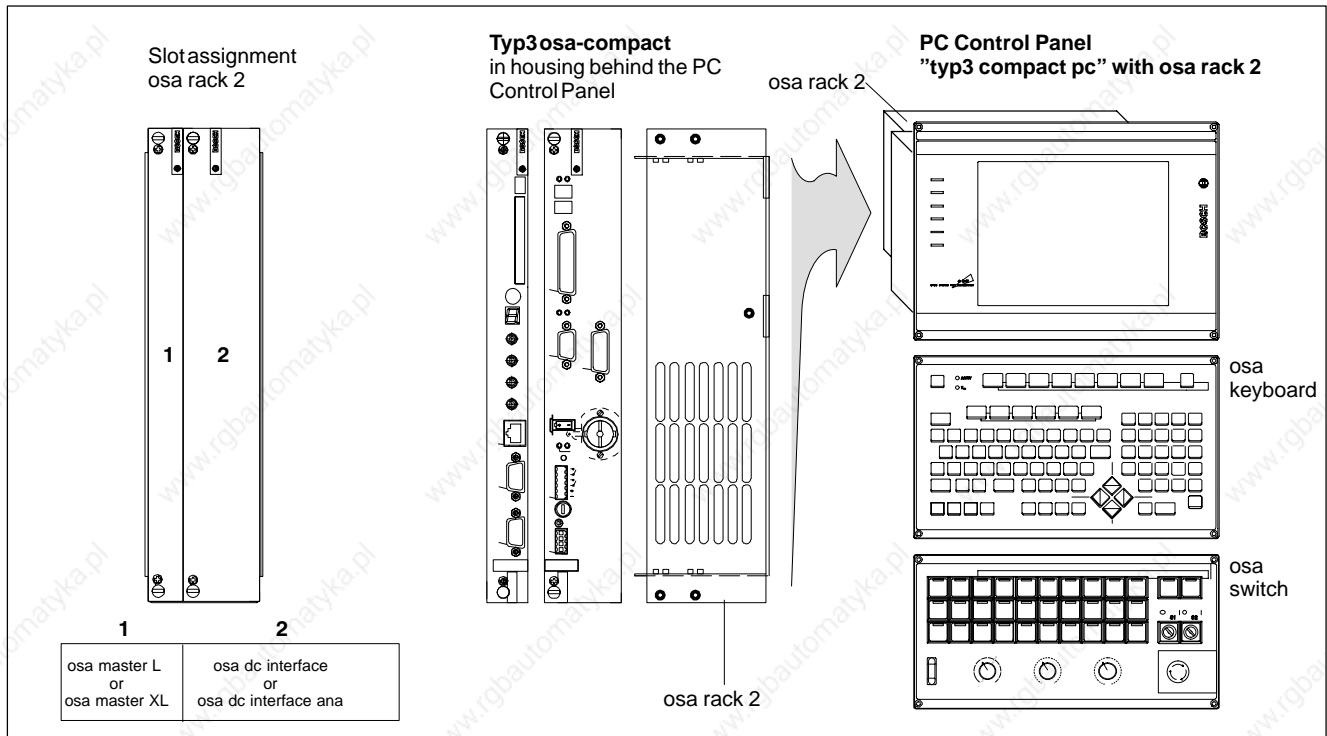

Typ3 osa-compact with "typ3 compact pc" PC Control Panel

Linking components

All connections between the system components can be made using ready-made cables (for part no., refer to section 8). For more information on cable lengths and pin assignments, refer to section 3.



CAUTION

Damages to system components may result from making or removing plug-in connections during system operation!
You should always shut off the system before you connect the components.

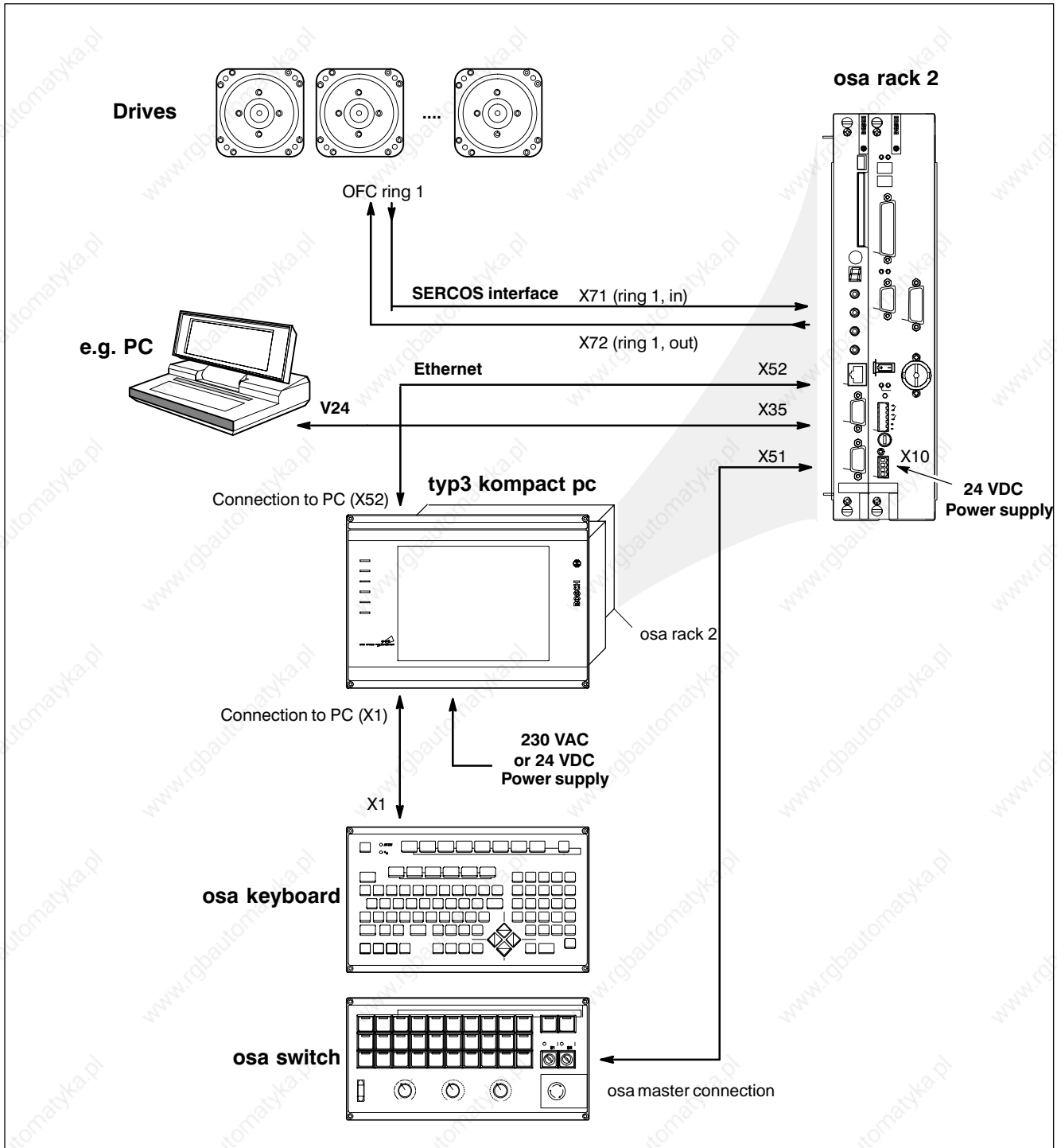

Establishing connections: Typ3 osa-compact with "typ3 compact pc" PC Control Panel

2.2 Typ3 osa-modular

Only the PC Control Panel is located in the operating area of the machine. The system unit of Typ3 osa is installed in the separate osa rack 2 or osa rack 4 inside the switch cabinet.

The osa dc interface module ensures the power supply to all Typ3 osa components. For this purpose, it requires an external 24 VDC power source.

Typ3 osa-modular with osa rack 4

(components and possible module equipment):

- PC Control Panel "osa display pc"
- osa master L/XL
- osa plc
- osa dc interface or osa dc interface ana
- osa rack 4

Optionally:

- osa profibus fms for communication with external units.

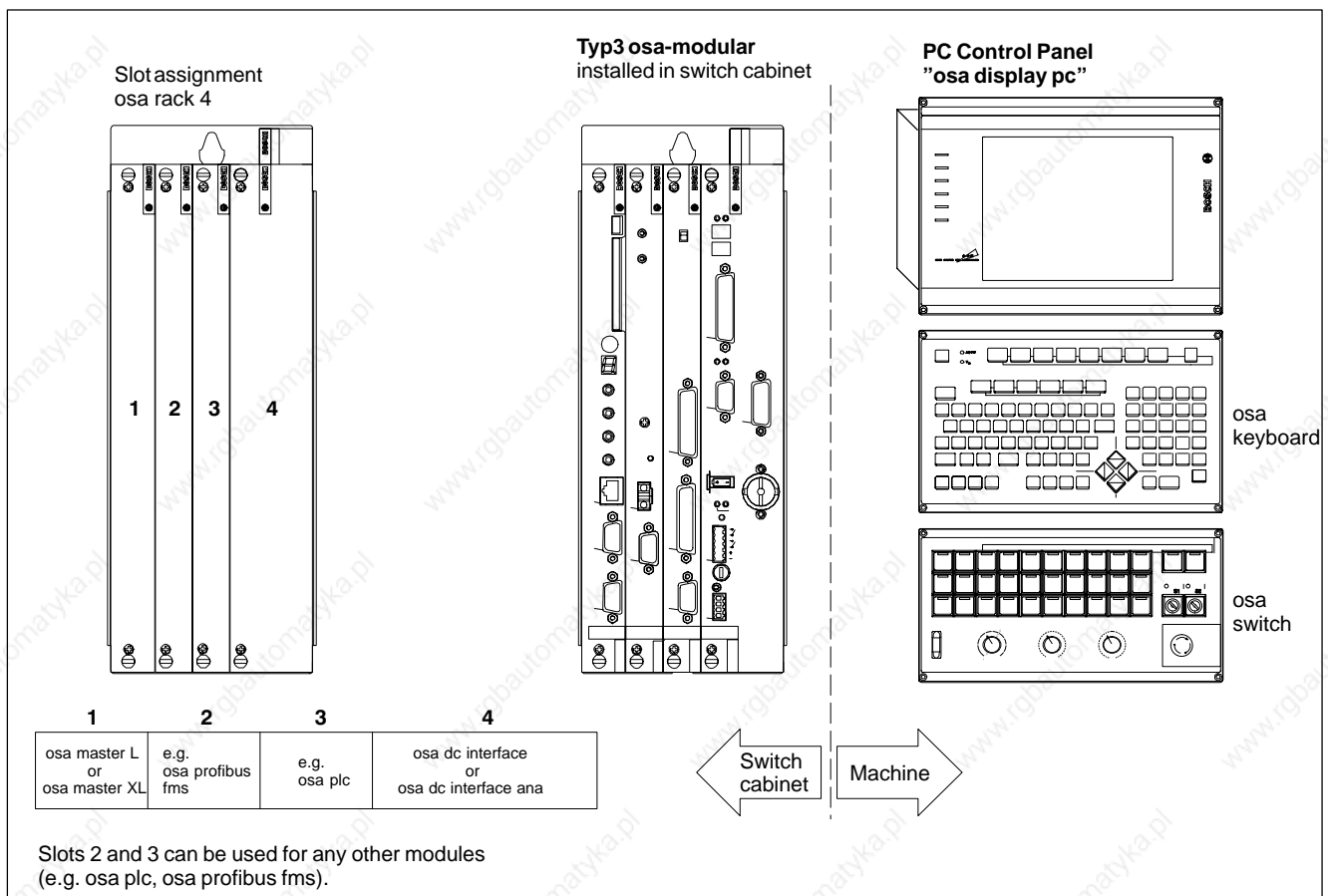

Typ3 osa-modular in osa rack 4 with "osa display pc" PC Control Panel

Typ3 osa-modular with osa rack 2
(components and possible module equipment):

- PC Control Panel "osa display pc"
- osa master L/XL
- osa dc interface or osa dc interface ana
- osa rack 2

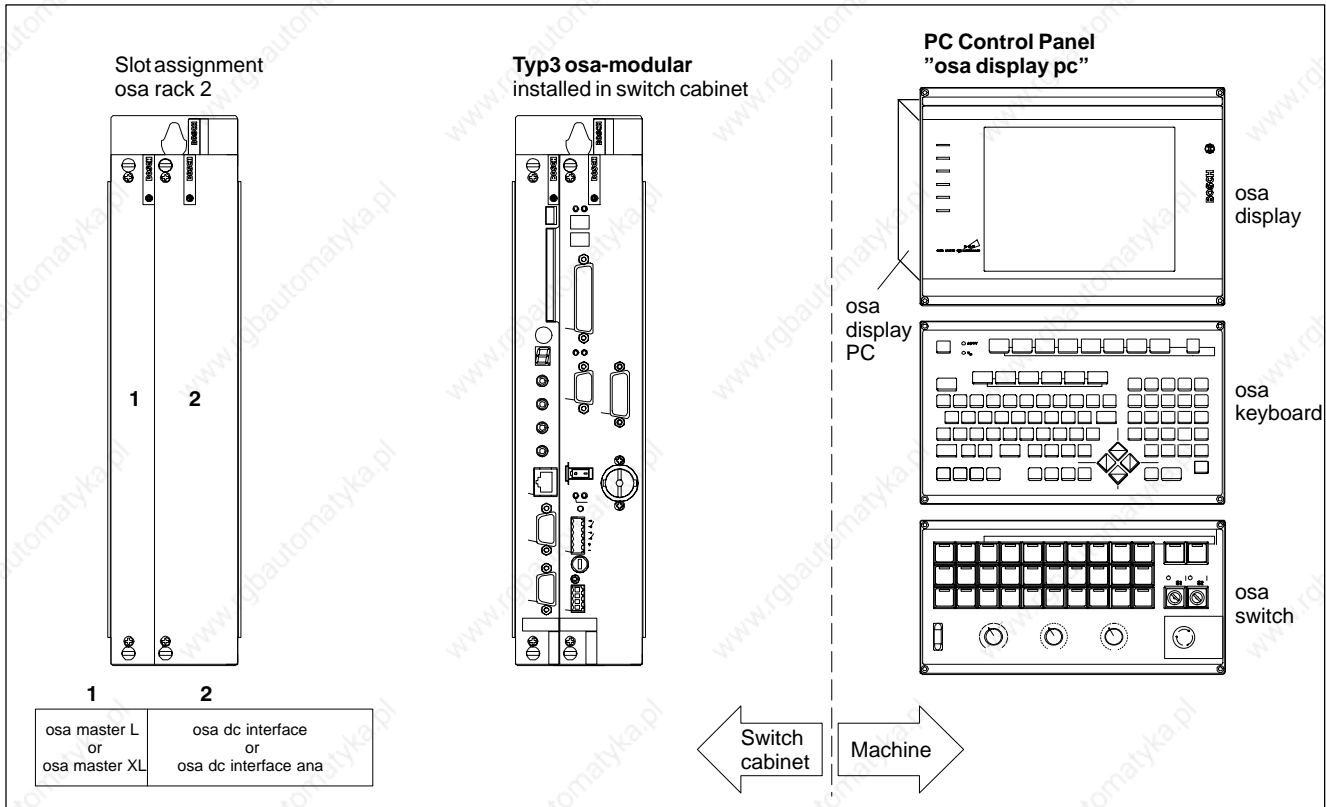

Typ3 osa-modular in osa rack 2 with "osa display pc" PC Control Panel

Linking components

All connections between the system components can be made using ready-made cables (for part no., refer to section 8). For more information on cable lengths and pin assignments, refer to section 3.



CAUTION

Damages to system components may result from making or removing plug-in connections during system operation!
You should always shut off the system before you connect the components.

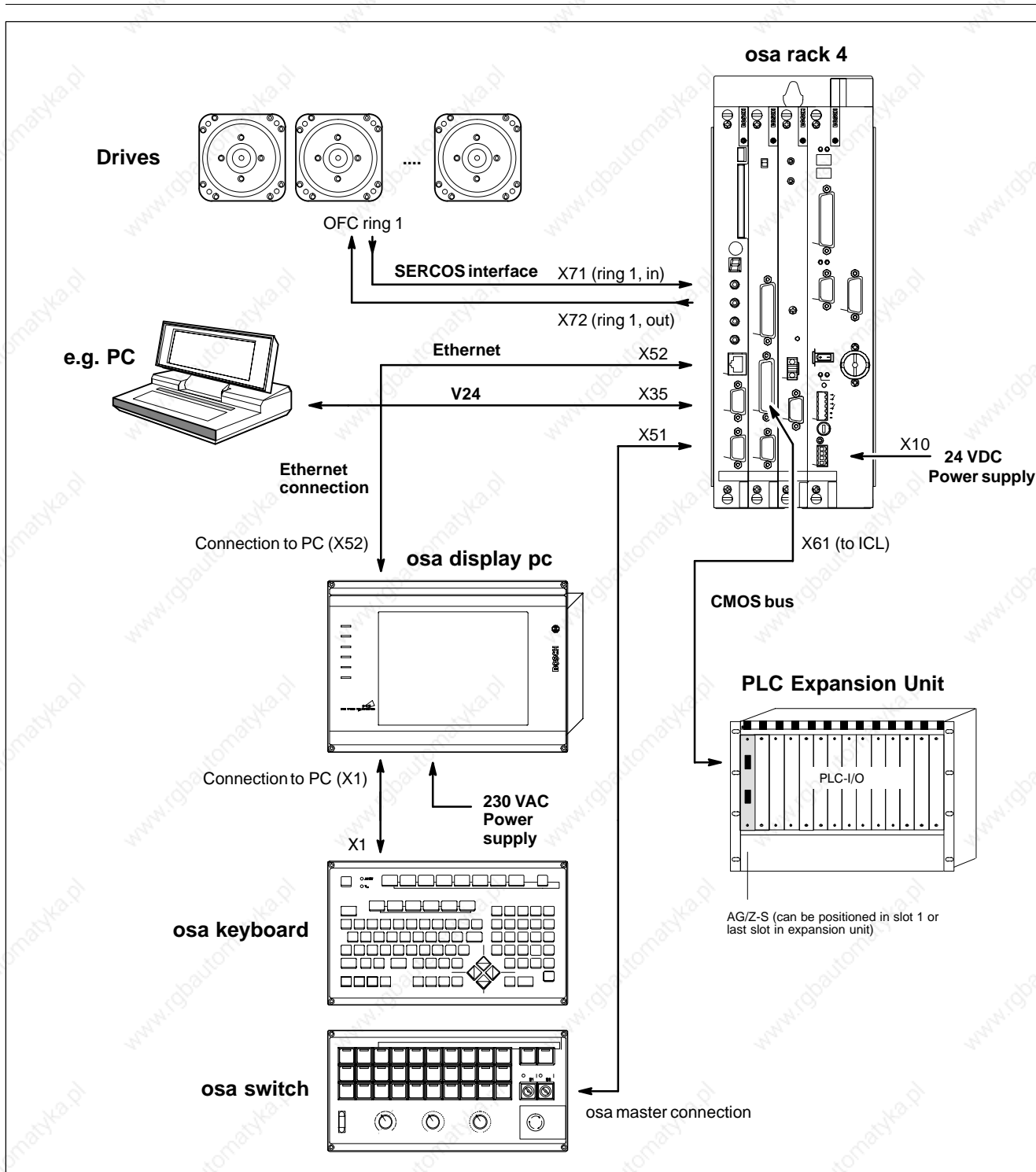

Establishing connections: Typ3 osa-modular with "osa display pc" PC Control Panel

2.3 Standards applied

The Typ3 osa system components comply with the following standards:

- EN 60 204-1 Electrical equipment of machines
- EN 50187 Electronic equipment for use in power installations (with respect to VDE160)
- EN 50 081-2 Generic emission standard for industrial environments
- EN 50 082-2 Generic immunity standard for industrial environments
- EN 60 742 Isolating transformers and safety isolating transformers (transformer for 24V power supply, safe isolation)
- EN 61 131-2 EMC requirements for programmable controllers (requirements on 24V power supply)
- EN 418 Safety of machinery; emergency stop equipment
- EN 60 529 Degrees of protection provided by enclosures
- EN 60 068-2-6 Environmental testing – Part 2: Vibration
- EN 60 068-2-27 Basic environmental testing procedures – Part 2: Shock

Exception:

For PC Control Panels, standard EN 50 187 is not applicable, but rather:

- EN 60 950 Overvoltage category II

2.4 Conditions of application

Unless described otherwise in the individual sections, the following data applies to the system components:

Temperatures

Storage temperature:

- PC Control panels: -20°C up to +60°C
- all other components: -25_C up to +70_C

Ambient temperature:

- Modular control panels: +5°C up to +45°C
- 3.5" Floppy Disk drive: +5°C up to +45°C
- all other components +5_C up to +55_C

The ambient temperatures are applicable for the installation instructions described in section 5.

Temperature changes over time are admissible up to 3°C per minute.

Humidity

Climatic category 3K3 to EN 60 529, condensation is not permitted.

Air pressure

For operation up to 1000 m above m.s.l.: to DIN 60204

Protection standards

The switch cabinets and installation rooms for Typ3 osa must at least comply with protection standard IP54 (dust filter in front of air inlet and outlet).

- PC Control Panels: Front covers IP65, otherwise IP00 min. designed for installation to IP54
- All card racks: IP20 min. designed for installation to IP54
- osa switch: IP00 min. designed for installation to IP54
- 3.5" Floppy Disk drive: With protective cover IP54, otherwise IP00 min. designed for installation to IP54



CAUTION

Danger for product!

The ambient air must be free from conductive contaminations (acids, alkalis, corrosive agents, salts, metal vapors, etc.).

Filters in the air inlet and outlet must be regularly serviced.

Your notes:

3 Modules

This chapter provides – sorted by module types – the following information:

- Module illustrations / diagrams
- Explanations of control and display elements where applicable
- Interface pin assignments and specifications

 For information on the installation of a module, refer to section 5. ■



CAUTION

Improper pin assignment of connecting cables may result in destruction of interfaces!

Therefore use only cables with suitable pin assignments, and label the cables accordingly.

3.1 osa master L, osa master XL

Central system module of Typ3 osa which is available in two versions and is always required.

- osa master L (SNCI_2/12/8 with 1 SERCOS ring)
- osa master XL (SNCI_2/X with 2 SERCOS rings)

The osa master L/XL module is equipped with a gold capacitor which buffers the RAM data for at least 10...60 min even if the board has been removed.



CAUTION

Data loss through discharged capacitor!

Do not place any modules on conductive surfaces. Reinstall the modules in the rack after approx. 5 min.

When the card is plugged in, but the mains voltage is interrupted, the data will be buffered by the battery of osa interface dc/ana (refer to section 3.4.5).

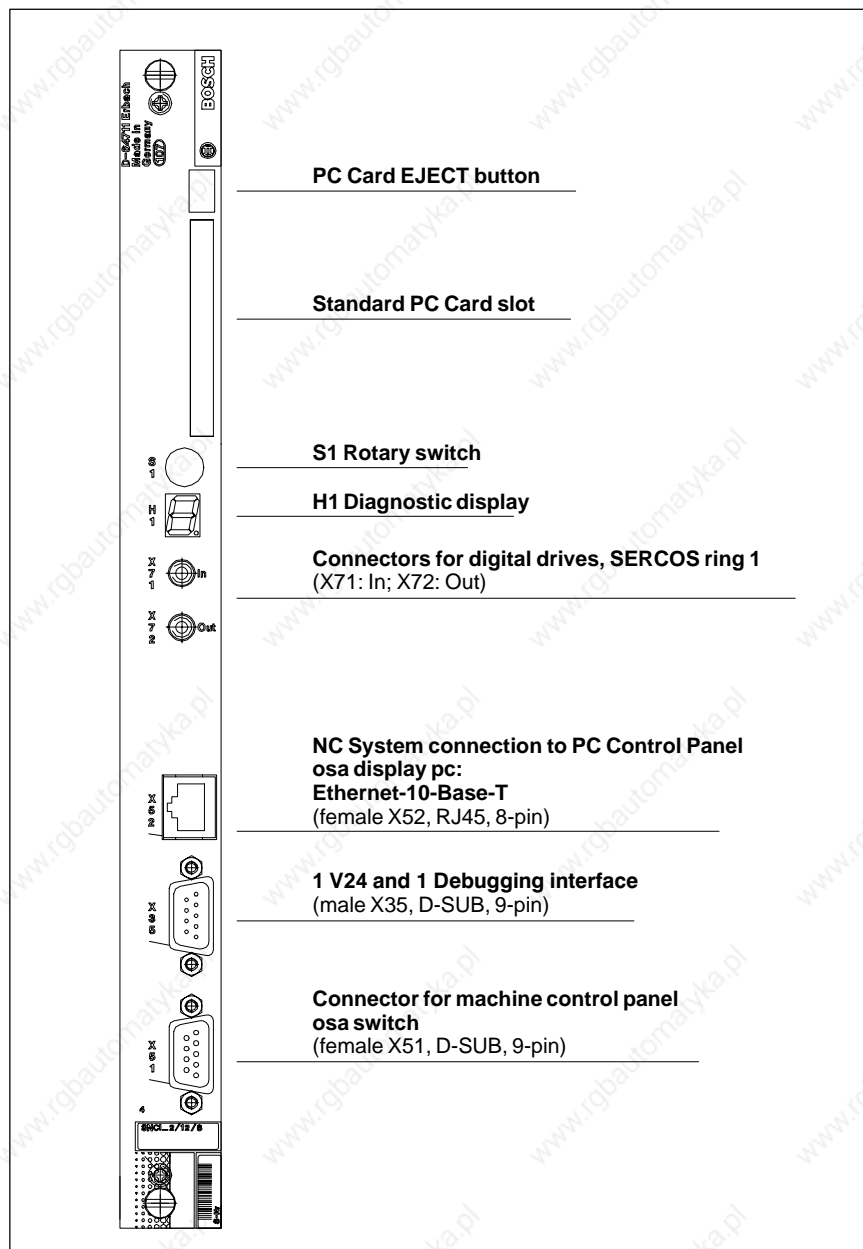

Front view of osa master L

**CAUTION**

Take all precautions necessary for ESD protection when handling modules and components! Avoid electrostatic discharge!

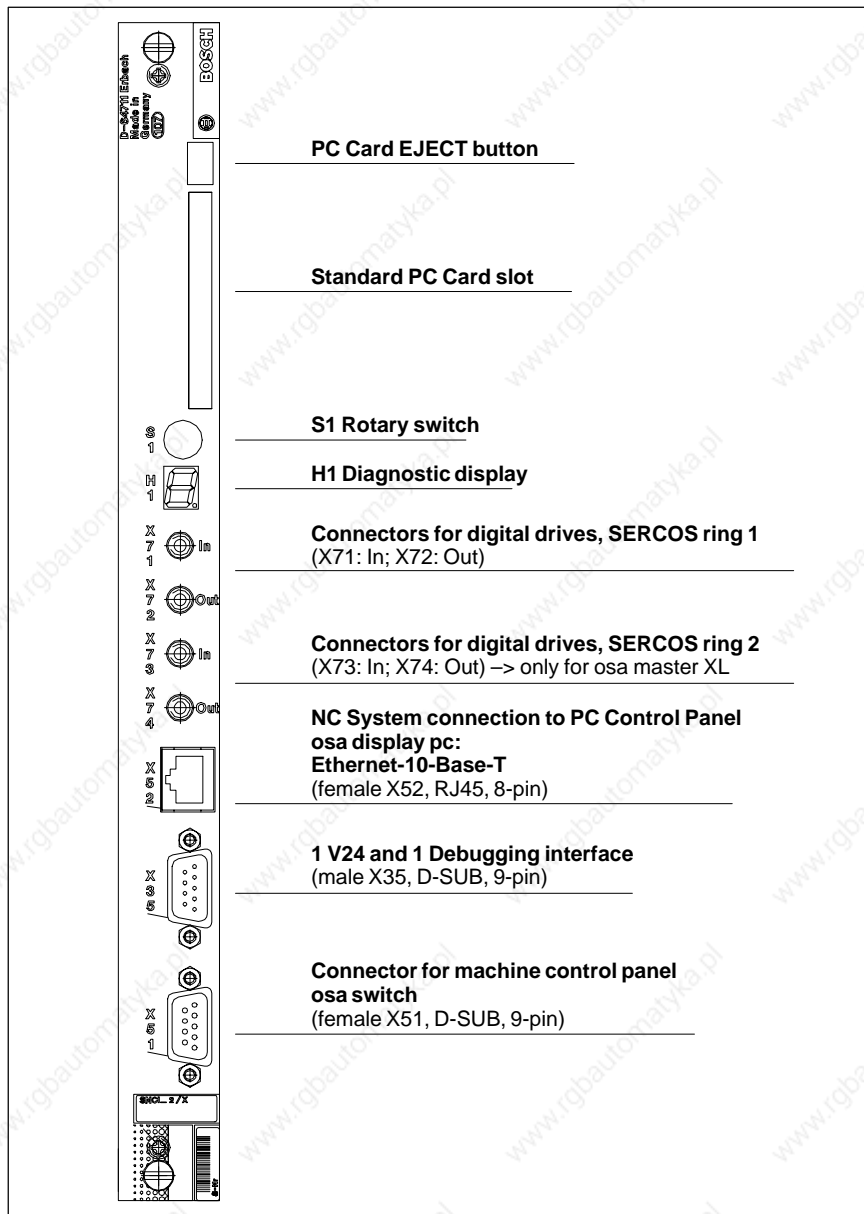

Front view of osa master XL

3.1.1 Connectors

X71...X74 SERCOS interface connectors

Connection of digital drives with SERCOS interface via optical fiber cables. Depending on the module, 1 or 2 SERCOS interface rings may be connected:

X71: Ring 1, In
X72: Ring 1, Out
X73: Ring 2, In
X74: Ring 2, Out

The connectors used comply with the F-SMA standard to IEC 874-2. Prefabricated optical fiber cables with connectors and strain reliefs at both ends are available 2 m, 5 m and 10 m long. They are made of plastic material and equipped with a step-index profile. For part numbers, refer to section 8.2.

The number of drives per SERCOS interface depends upon the required cycle time and the data volume occurring on each drive (max. 4 Mbaud per OFC ring).



DANGER

The high power of the LED's in the optical fiber conductors may endanger your eyesight when looking straight at the LED's. When the inverter is switched on, do not look into the LED or the open end of a short connected line.

 **Measuring systems are connected to the drive modules.**

X35 V.24/Debugging interface

Maximum of 2 serial V.24 interfaces. While the interface labelled "V.24" in the following illustration is always available for connecting external periphery, the interface labelled "Debugger" can be used for debugging only.

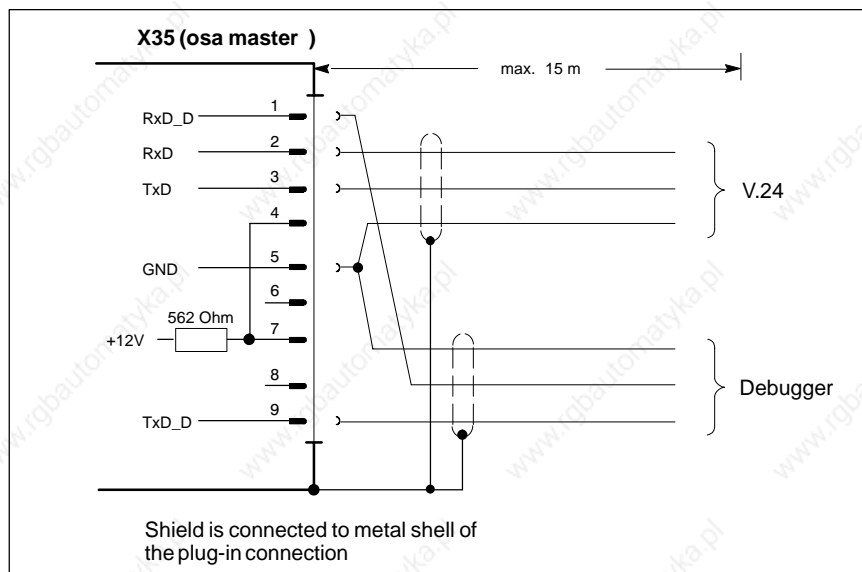

X35 pin assignment (osa master)

D-SUB connector, 9-pin

Level:	HIGH: +3V ... +9V LOW: -3 V... -9V
Transmission speed:	max. 19200 Baud (fixed speed of 9600 baud for Debugger interface)
Handshake:	Software (X _{ON} , X _{OFF})
Tx	Transmit Data line of CNC
Rx	Receive Data line of CNC
GND	Signal Ground
Line length:	max. 15 m, for longer lines, suitable repeaters with a metal housing must be interconnected.
Cable type:	Shielded cable, conductor cross-section 0.14 mm ²

 **For interface test units, Typ3 osa outputs a permanent HIGH signal at pins 4 and 7. Please note that hardware handshake signals of a connected unit (CTS/RTS or DTR/DSR) will not be evaluated!**

**CAUTION**

Malfunctions caused by inadequate screening!

Always use only metal and/or conductive male and female connector/coupling shells with a large-area shield conductor surface.

X51 Connection to osa switch

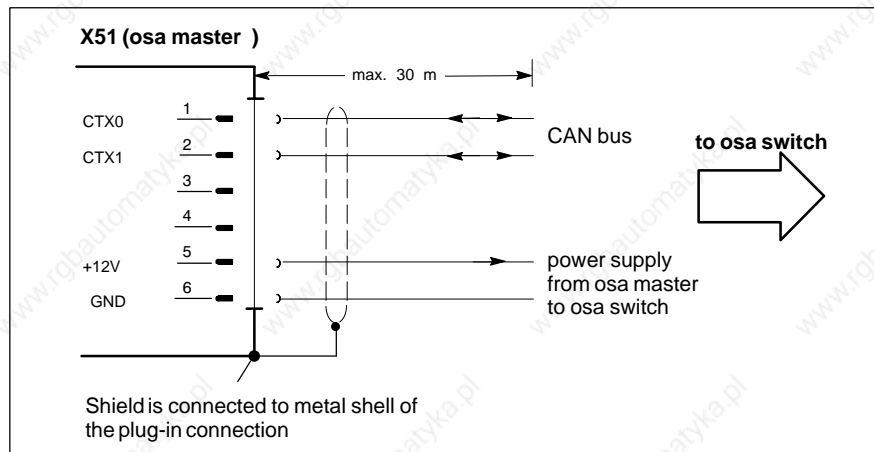

X51 pin assignment (osa master)

D-SUB connector, 9-pin

Connection type: CAN bus

Line length: max. 30m

Cable type: preassembled cable, shielded, conductor area $2 \times 2 \times 0.25 \text{ mm}^2$

X52 NC System Connection with PC Control Panel "osa display pc"

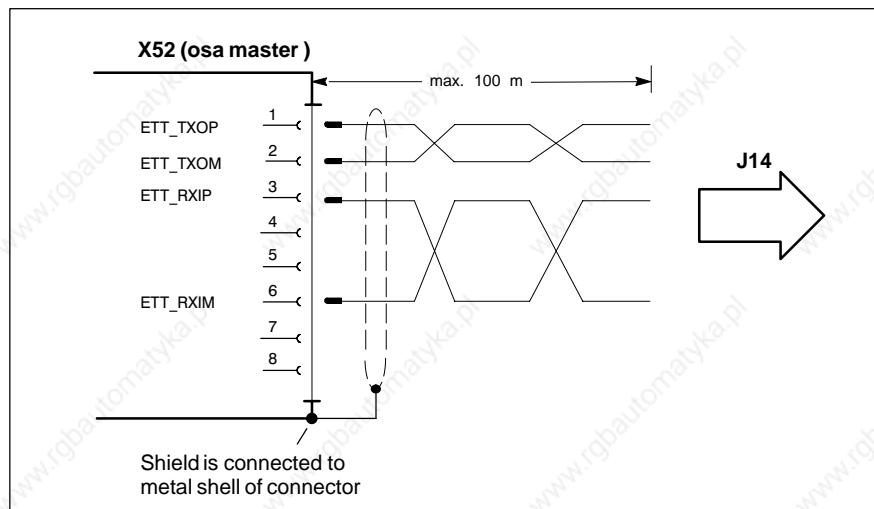

X52 pin assignment (osa master)

RJ45, female, 8-pin.

Connection type: Ethernet 10-Base-T

Line length: max. 100 m

Cable type: preassembled, shielded twisted Pair



CAUTION

Malfunctions caused by incompatible cables!

Use only preassembled original cables for connecting the modular Control Panel.

3.1.2 S1 Rotary Switch



CAUTION

Loss of Data or possible malfunction!

The position of the rotary switch influences the start sequence of the Typ3 osa Numerical Control.

For this reason, setting the S1 switch to positions other than "0" is authorized for service purposes only, and is restricted to specially trained service technicians!

- Position "0":** Switch position for standard operation ("Normal mode"). The file systems are retained and will be checked for consistency during run-up. If the FEPROM file system is defective, the unit cannot be run up. In this case, the control must be reloaded. If a root file system is defective and cannot be automatically repaired, the control will not run up. A critical system error will be displayed. During the next run-up a new, empty file system will be automatically generated. If a defective usrfep file system is detected, the control will try to link the file system to the "!usrfep!" directory reserved for this purpose (mounting). The user can then copy the still readable files to another file system (e.g. root file system). After having run up in switch position "7", the recovered files can be copied back to the new usrfep file system. The PLC systems software is retained and will not be loaded again to the osa plc. The base monitor activates the Ethernet interface. The debugging interface is activated by the base monitor only if the osa dc interface module is available.
- Position "1":** The osa plc remains in STOP condition when the control has run up. The PLC user program is not executed. Otherwise as position "0".
- Position "2":** Debugging mode with and without osa dc interface; otherwise as position "1" (only for osa master L/XL).
- Position "3":** Guaranteed run-up. The control runs up with a minimal configuration, independent of the machine parameter settings. Thus, a false configuration of the machine parameters, which prevents a run-up in normal mode (position "1"), can be circumvented; otherwise as position "1" (only for osa master L/XL).
- Position "4":** as position "2". (only for osa master L/XL).
- Position "5":** as position "2", but without "power fail handling" (only for osa master L/XL).

Position "6": Initial program loading. Used for the first start-up of a newly installed NC control. First, a new Root file system is generated. The hardware configuration of the part program memory (e.g. with/without PC card) is determined. The PLC system firmware and PLC application program are loaded for the first time. The Typ3 osa then copies, from the "usrfep" FEPRPOM file system, all data required for the start-up. In the event that such data does not exist in that location, the control software proceeds by generating the factory-preset basic configuration with the use of data from the "feprom" FEPRPOM file system.
The PLC application program is then started.

**CAUTION****Loss of Data!**

Switch position "6" causes all data of the old file system to be deleted. You are cautioned to use this setting only when you have completed the backup of all important data (such as MACODA parameters, SERCOS files, etc.) in the "usrfep" FEPRPOM file system. Otherwise you will have to perform a complete new software installation!

Position "7": Initial loading of basic data. Used for starting up a control, the "usrfep" FEPRPOM file system of which has been destroyed or contains inconsistent data, making the start-up of the Typ3 osa Numerical Control impossible. In contrast to the consequences of switch Position "6", the old "usrfep" FEPRPOM file system is also deleted entirely, and newly generated. The data of the root file system is retained. Otherwise as "Normal mode".

**CAUTION****Loss of Data!**

Switch position "7" causes all data of the "usrfep" FEPRPOM file system to be deleted. The root file system remains intact.

You are cautioned to use this setting only when you have completed the backup of all important data (such as MACODA parameters, SERCOS files, etc.) to an external data storage medium. Otherwise you will have to perform a complete new software installation!

Position "8": Similar to Position "9" (applies exclusively to osa master L/XL)

Position "9": Debugging mode. The hardware is initialized, and the entire software is loaded into the individual modules. All modules – with the exception of the CL – are initialized, assume the monitor mode and stand by for debugging instructions. The osa plc delay both loading and starting the PLC application program until all other modules have been started.

Position "A": Debugging mode. The hardware is initialized without loading the software into the individual modules. From this point onward, functions are the same as with Position "F." This position is intended for loading software into RAM via Ethernet.

Position "B": Initial loading of basic data or software swap from PC Card. The PC Card must have been specially prepared for this purpose. If this is not the case, the system, will not start up.
 The Typ3 osa copies, from an appropriately prepared PC Card, all data into its internal boot and/or data FE-PROM's. This way, any Typ3 software can be introduced to the NC Control (even into a new, completely "empty" control).
 Please keep in mind that the destination areas on the control will be overwritten: In the event that the PC Card contains, for example, the "usrfep" and "feprom" FE-PROM file systems, the data of all preexisting "usrfep" and/or "feprom" FE-PROM file systems on the control will be deleted!

Position "C": For backing up the osa plc system software to the FE-PROM of the NC control. The backup procedure must be started from a programming device connected to the osa plc. The osa plc then copies the system software into the FE-PROM range of the NC control.

Position "D": Debugging mode. Deletes all subsequently loaded software, if any, in the RAM reload mode.
 Deletes the root parameters in the FE-PROM (PC card extension of the root file system, etc.)

Position "E": Debugging mode. The position is designated for the display of the Ethernet address and the debugging baudrate on the H1 display. All characters are displayed in succession.
 In the event that the switch position is changed while the Ethernet address is displayed, the control discontinues the Ethernet address display and commences with the display of the debugging baudrate. In the event that switch S1 is no longer positioned at "E" subsequent to displaying the last figure, the Typ3 osa Control will initialize its debugging interface at a speed of 9600 Baud. The remaining functions are as with Position "F," below.

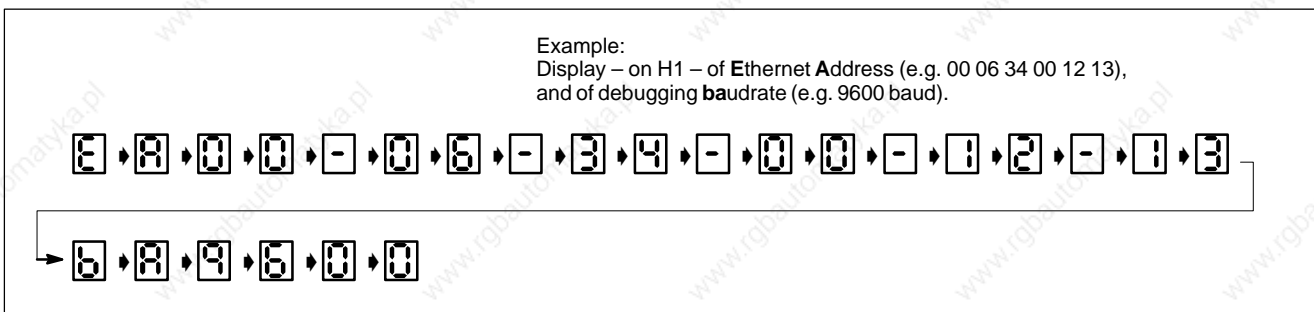

Ethernet address display on H1

Position "F": Debugging mode. Activates the base monitor. The Typ3 osa communicates with the debugging computer via the second V24 interface on X35 (default baudrate is 9600). The pin assignment of the X35 interface connector is specified on page 3-5.

☞ **While in the debugger window, the command Ctrl Y can be generated by entering the "nmi" character string.**

3.1.3 H1 Diagnostic Display

The H1 diagnostic display is used – at different times and by different software functions (e.g. basis monitor, PC Card bootloader, start-up software) – for displaying status information and fault messages.

Display readings during standard operation, NC control running

"-": If "-" is not displayed although S1 rotary switch is set to "0" position, please contact our customer service.

Decimal point: Illuminates for at least 0.2 sec with each data packet transmitted via Ethernet.

Displays during debugging operating

☞ **In the event that the Typ3 osa is booted with the S1 switch set to "E," it will initially return different configuration data on H1. The explanation of displays appears in Section 3.1.2, "Position E".**

"8", "A": The system is in basis monitor mode. If "A" is displayed, the monitor expects data from the debugging interface and/or from the Ethernet interface.

"L": Loading via Ethernet. The control is currently processing a data packet.

"d": Loading via Ethernet. The control is currently deleting FEPROM ranges.

Decimal point: Illuminates for at least 0.2 sec with each verified data packet transmitted via Ethernet.

Displays during the boot process (faults)

Any faults occurring during the boot process of the Typ3 osa cannot immediately be returned to the H1 display. For this reason, bootloader and start-up software are using the H1 as a diagnostic display. In this case, a complete fault message is formed by characters that are displayed in succession on a timeline.

Faults occurring in the bootloader area are identified by the starting sequence "P" and "E" (Panic Error), and in the software area by "F" and "E" (Fatal Error). The timed succession of the fault messages are depicted in the illustration below. For example, "PE 0 86" and/or "FE 1 56":

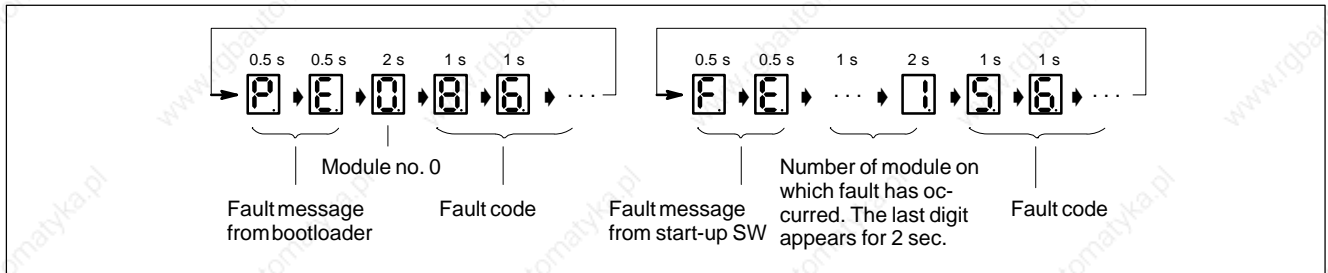

Error displays during the boot process

Displays during “osa plc software backup to Typ3 osa FEPR0M” (S1 Position: “C”)

- “C”: FEPR0M range is currently being deleted.
- Decimal point and rotating through 1 segment each time: Now programming FEPR0M area.

Example:

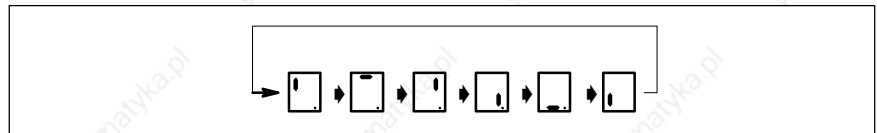

Display during FEPR0M programming

- “E”: Fault detected during deleting or programming FEPR0M area. Process was aborted.
- “8”: Verifies complete and fault-free data transfer to control memory.

Displays during “initial data loading or SW swap from PC Card” (S1 Position: “B”)

- “C”: Now programming a range of 32 kB in boot FEPR0M. See also “0” and “L.”
- “d”: Now programming a range of 8 kB in data FEPR0M. See also “0” and “L.”
- “0”: Display alternates between “C” and “d.” Now programming corresponding FEPR0M range with value “0.”
- “L”: Display alternates between “C” and “d.” Now programming the corresponding FEPR0M range with data from PC Card.
- “F”: Now clearing FEPR0M’s.
- “P”: Now verifying the checksum of the data to be programmed (in blocks of 64 kB). In case of fault, refer to “E.”
- “E”: Fault detected during programming FEPR0M’s. Programming was aborted.
- “U”: Switch S1 not in Position “B.”
- “A”: The PC Card was filled with data, the destination addresses of which are outside the FEPR0M range of the NC control. Programming is aborted.
- “S”: Faulty data on PC Card. Programming is aborted.
- “2”: ZWS RAM cannot be written to, or insufficient capacity (<256 kB).
- “8.”: Verifies fault-free data copy from PC Card to NC control.

3.1.4 PC Card (PCMCIA Card)

PC cards are available with different memory sizes and storage media. For Typ3 osa, you may use Flash-EEPROM and SRAM PC cards.

- For example, the PC card may be used to load or store user programs, cycles, or even system software.
- SRAM PC cards may be used to expand the part program memory of the osa master.

 **Typ3 osa must be run up in switch position 6 for this purpose.**

PC Card Slot:	68-pin, as per PCMCIA/JEIDA standard
Memory address range:	max. 64 MByte
Bus width:	16 Bit
Access time:	< 250 ns



CAUTION

**The PC card may be damaged by ejecting or inserting it while the card slot is powered!
Data contained in the card could be destroyed.
Therefore, activate the mechanical write-protection switch of the card before you insert or eject it!**

3.2 osa plc (ICL 700)

High-performance PLC for the "Typ3 osa-modular" system variant. It processes the input/output signals generated by the peripheral devices of the PLC.

The osa plc board contains a gold capacitor which buffers the RAM data for at least 10...60 min even if the board has been unplugged.



CAUTION

Data loss through discharged capacitor!

Do not place any modules on conductive surfaces. Reinstall the modules in the rack after approx. 5 min.

When the board is plugged in and the power supply is interrupted, the data will be buffered by the battery of the osa interface dc/ana (cf. section 3.4.5).

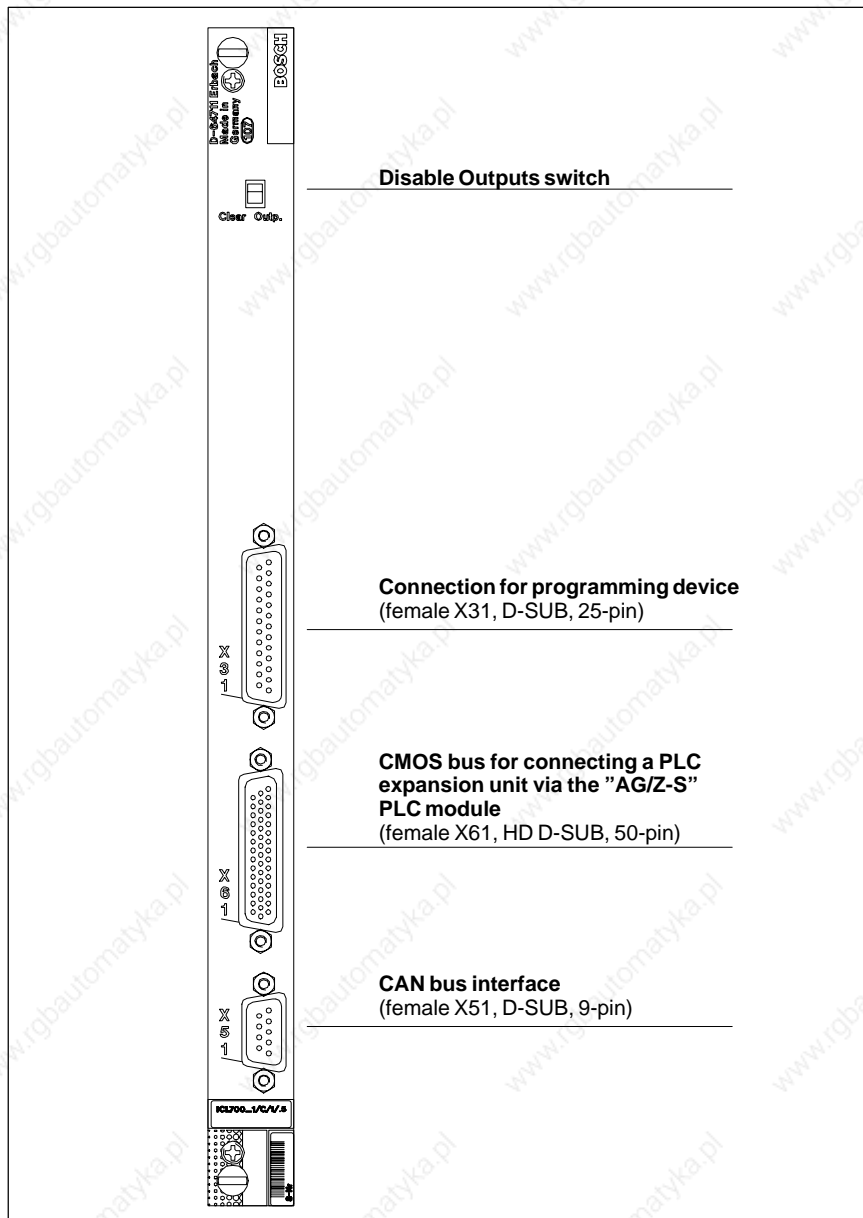

osa plc (front view)



CAUTION
 Take all precautions necessary for ESD protection when handling modules and components! Avoid electrostatic discharge!

3.2.1 Connectors

X31 Programming device connection

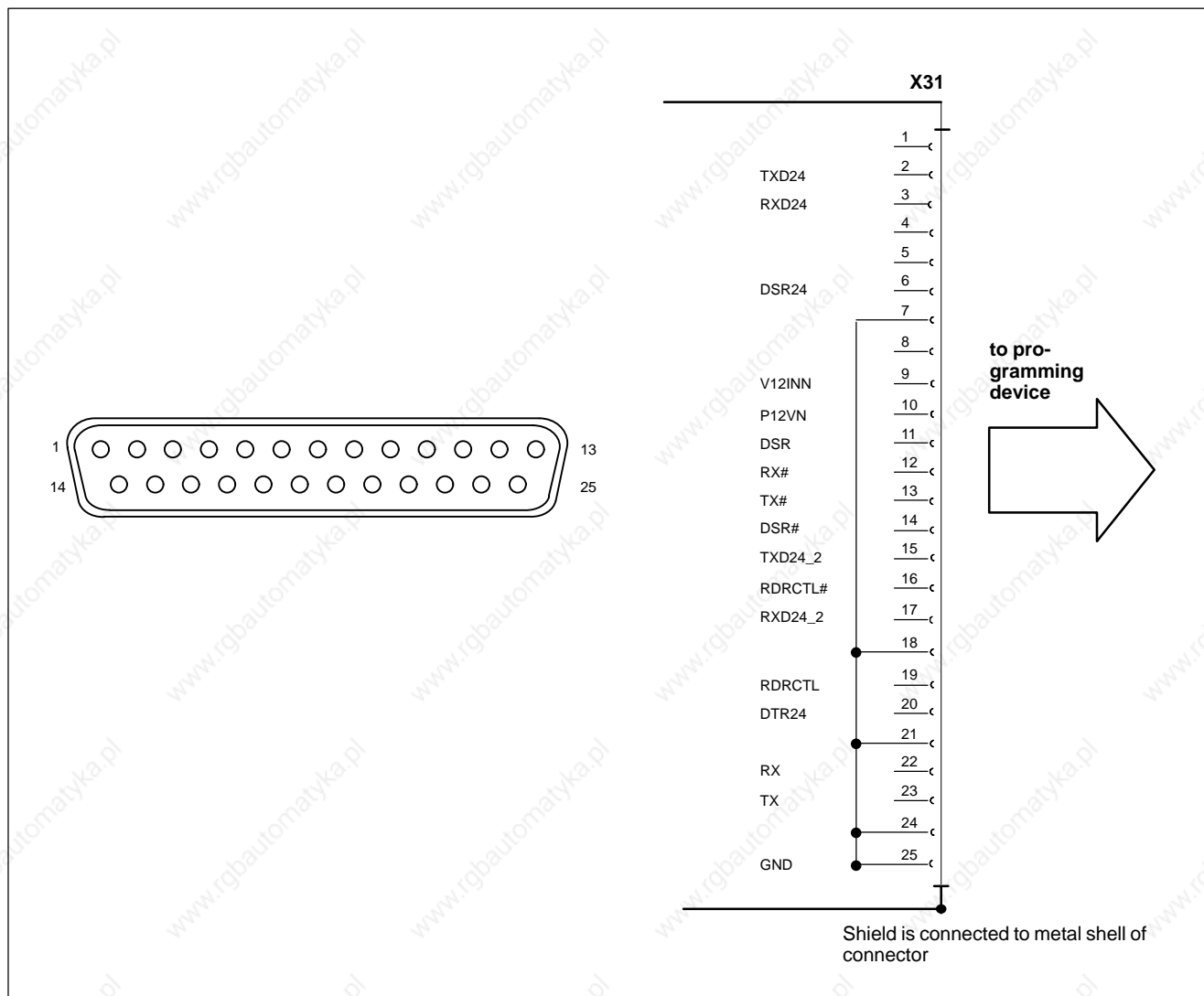

Connector X31 (osa plc)

Female D-SUB connector, 25-pin

Cable type: preassembled cable, part no. 1070 054 956

X61 CMOS bus for AG/ZS (PLC expansion unit)

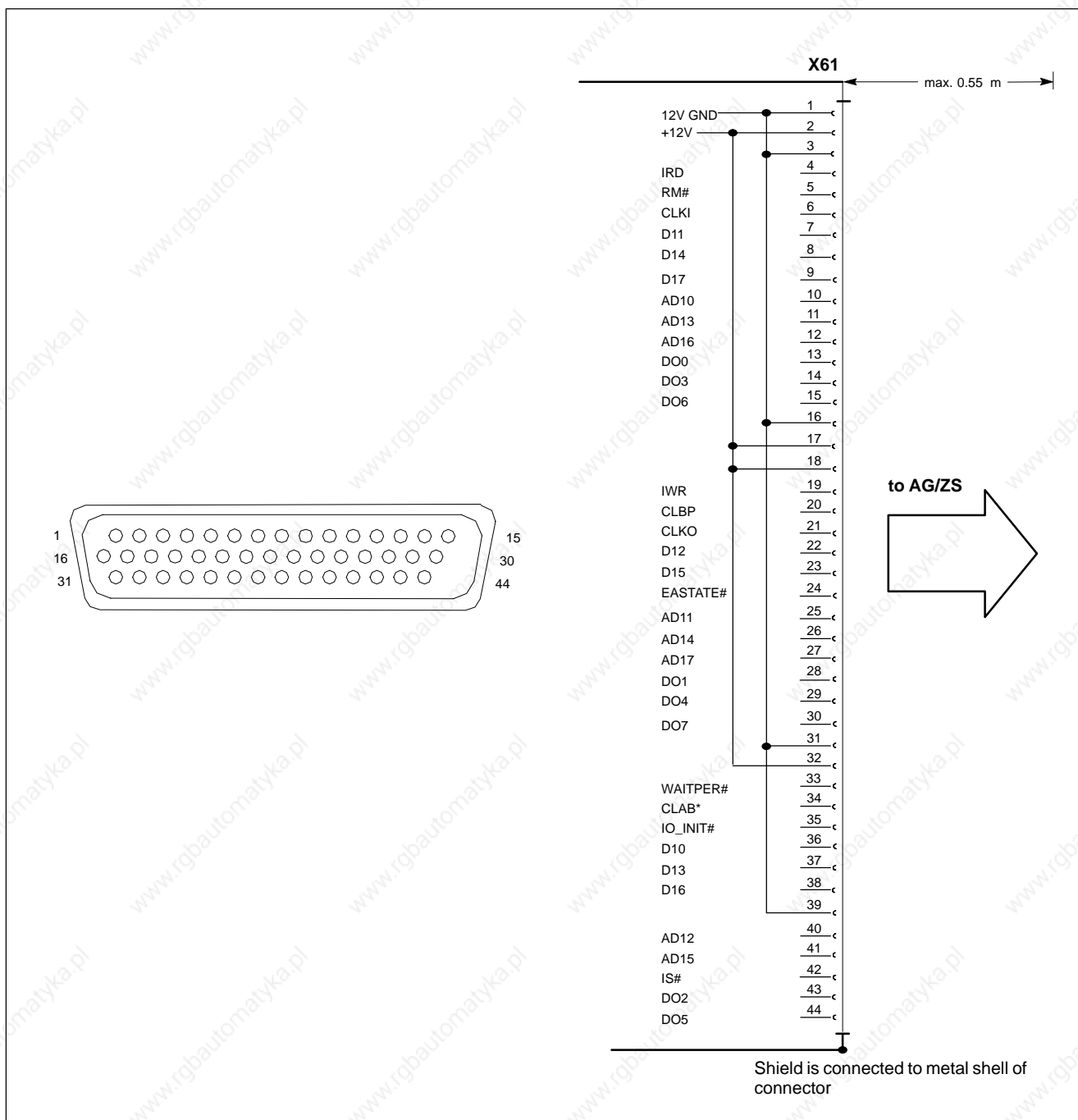

Connector X61 (osa plc)

Female D-SUB connector, 44-pin

- Connection type: CMOS bus
- Line length: max. 0.55 m
- Cable type: preassembled, part no. 1070 070 755

X51 Connection to osa switch

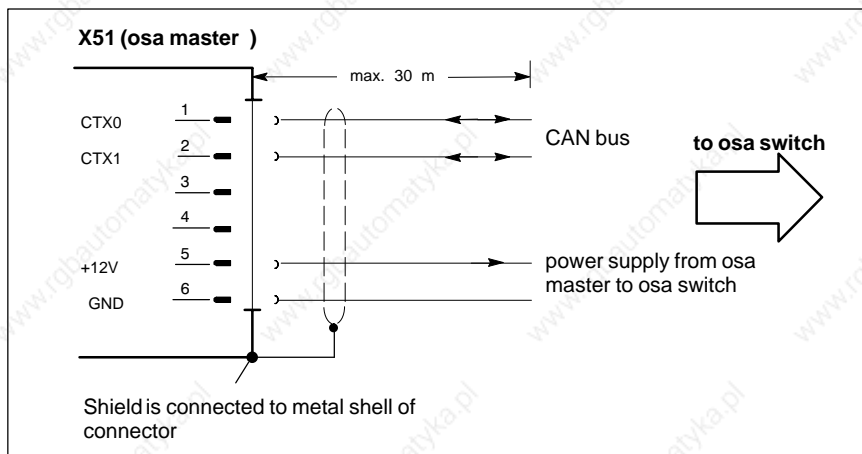

Connector X51 (osa master)

Male D-SUB connector, 9-pin

Connection type: CAN bus
 Line length: max. 30m



CAUTION
Malfunctions caused by incompatible cables!
Use only preassembled original cables for all connections.

3.3 osa profibus fms

Connection module enabling the Typ3 osa Numerical Control to interface with the PROFIBUS FMS.

Current consumption of osa profibus fms: 0.3 A/24VDC



CAUTION

Take all precautions necessary for ESD protection when handling modules and components! Avoid electrostatic discharge!

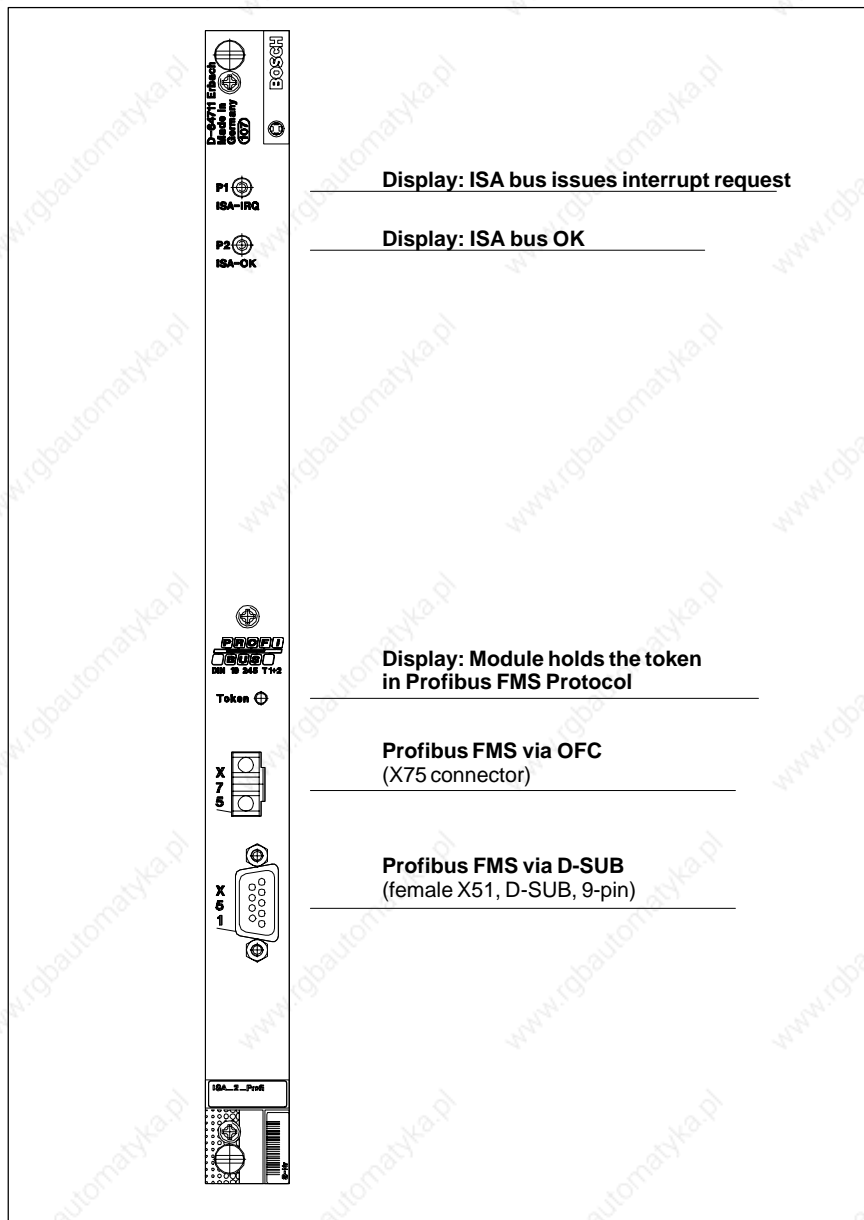

osa profibus fms (front view)

This module can only be used for the "Typ3 osa-modular" system variant.



CAUTION

Malfunctions caused by incompatible cables!
Use only preassembled original cables for all connections.

3.4 osa dc interface / osa dc interface ana

Central power supply and interface module of Typ3 osa. Two versions of this module, which is always required, are available.

- osa dc interface (DCIO_1/MK) with Profibus-DP and digital I/O interfaces
- osa dc interface ana (DCIO_1) additionally with analog I/O and bit bus interfaces

The description refers to osa dc interface ana.

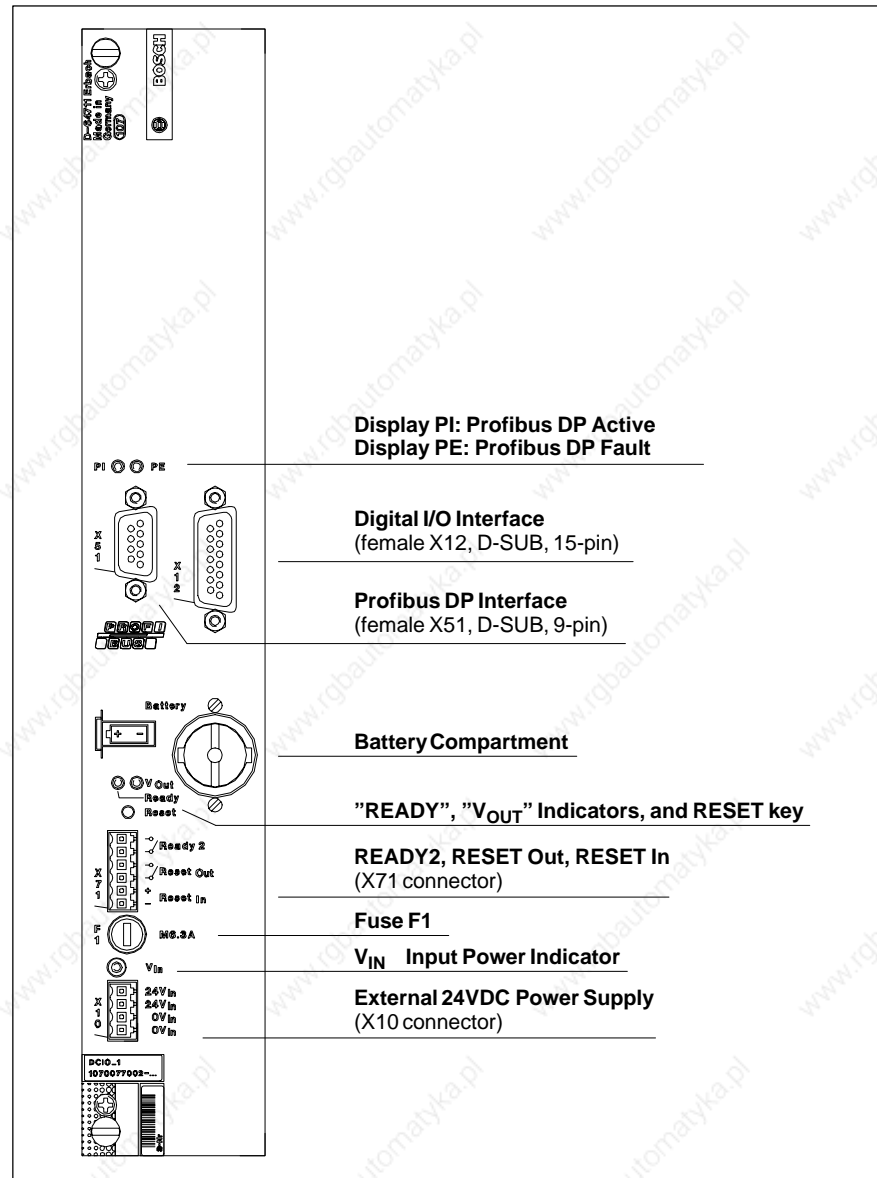

osa dc interface (front view)



CAUTION

Take all precautions necessary for ESD protection when handling modules and components! Avoid electrostatic discharge!

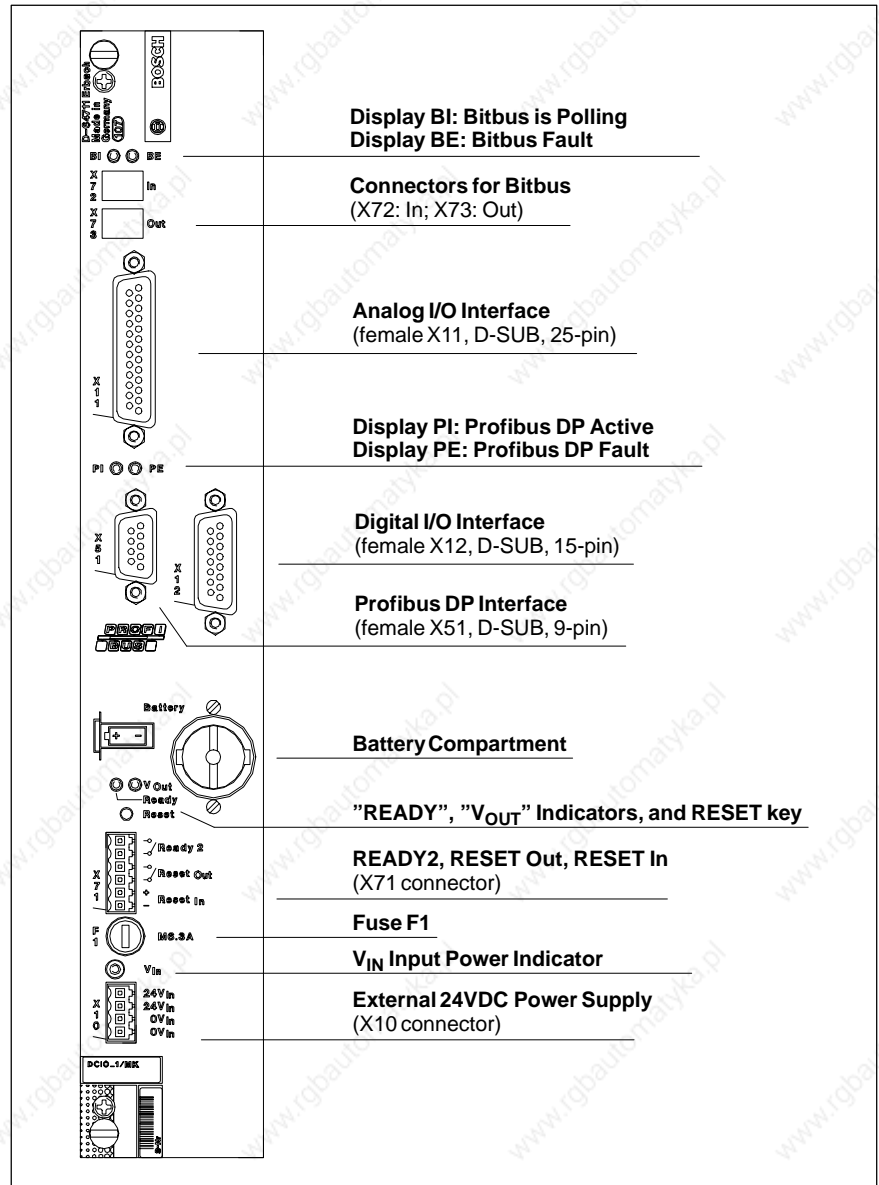

osa dc interface ana (front view)

3.4.1 Connectors

X72, X73 Bitbus Connectors

Optical fiber connectors for OFC connecting cables (mfg. Hewlett Packard, Type HFBR-PNS x; x = cable length).

- X72: In
- X73: Out

- Minimum cable length: 3 m
- Maximum cable length: 20 m

X11 Analog I/O Interface

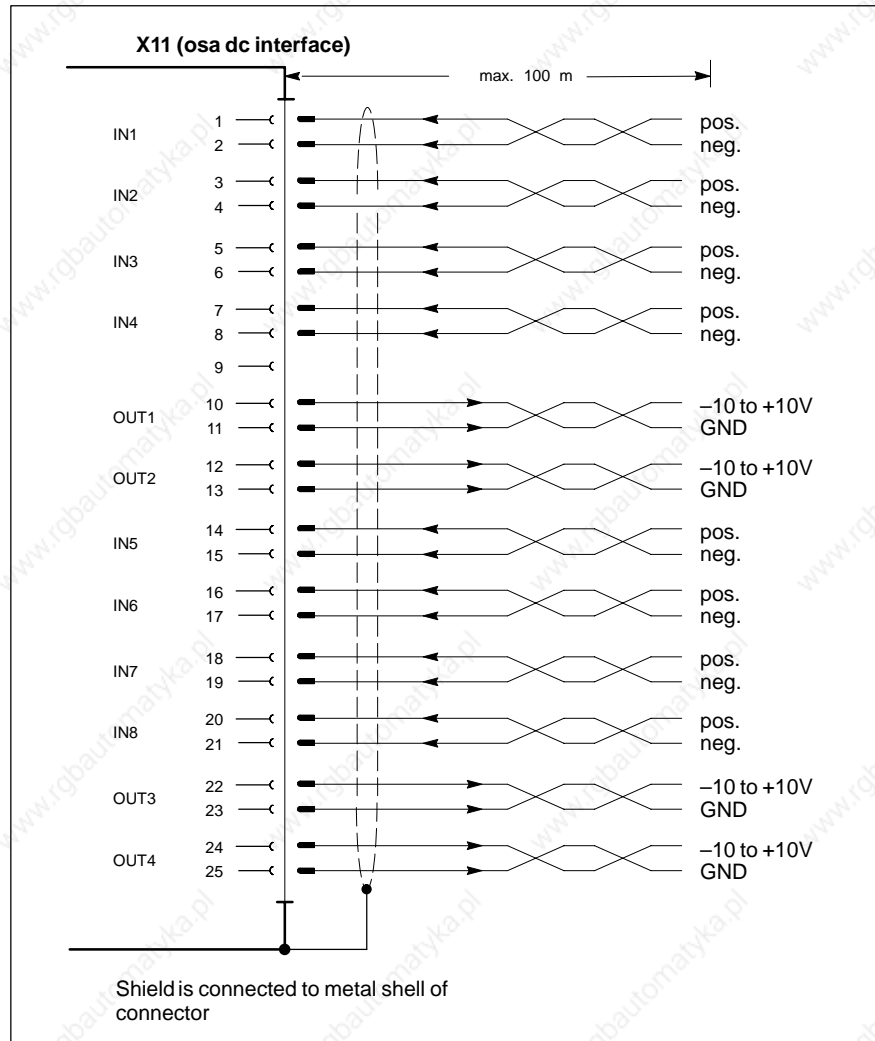

Connector X11 (osa dc interface)

Female D-SUB connector, 25-pole

Line length:

max. 100m

Cable type:

Shielded, twisted-pair

**CAUTION****Malfunctions caused by inadequate shielding!****Always use only metal and/or conductive male and female connector/coupling shells with a large-area shield conductor surface.****Specifications – Inputs**

Input type:

Differential inputs

Input measuring range:

 ± 10 V

Resolution:

12 Bit

Conversion accuracy:

 ± 2 LSB

Conversion interval:

10 μ s per channel

Input resistance:

typ. 1G Ω

Input frequency:

max. 10 kHz

Specifications – Outputs

Output type:	Ground-referenced
Output voltage range:	+10 V
Resolution:	12 Bit
Conversion accuracy:	± 2 LSB
Conversion interval:	max. 50 μs
Input resistance of connected input:	min. 10 kΩ

☞ **RESET resets all digital outputs to "logic 0" (see section 3.4.2).**

X12 Digital I/O Interface (High-speed Inputs/outputs)

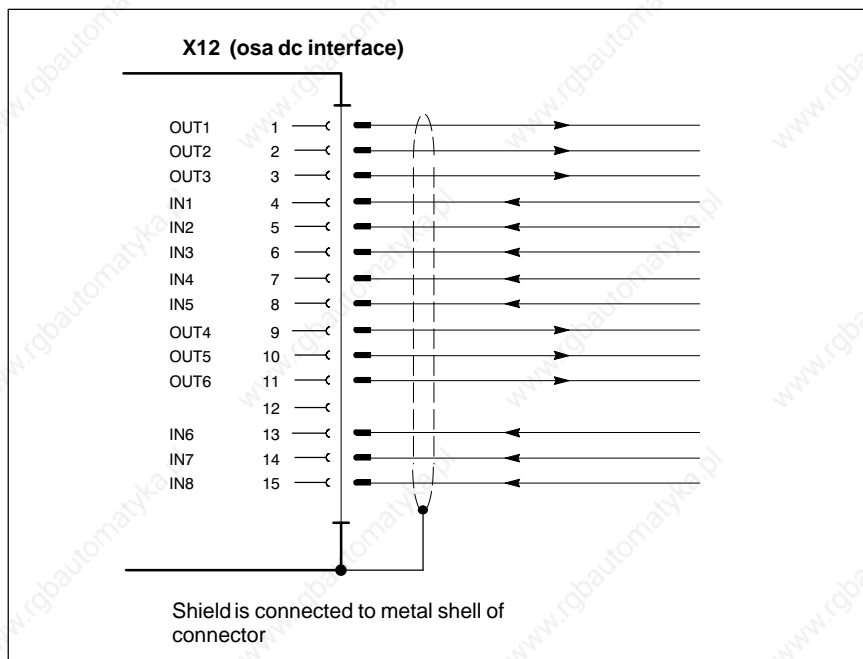

Connector X12 (osa dc interface)

Female D-SUB connector, 15-pin

Specifications – Inputs

Galvanic isolation:	via optocoupler
Voltage ranges:	LOW level: -3 to +5V HIGH level: +15 to +30V
Input current:	0.14 mA / V of input voltage
Input delay:	max. 0.2ms

Specifications – Outputs

Concurrence:	100%
Nominal ratings:	24VDC, 0.5A
Max. current at max. voltage:	0.6A
Internal voltage drop:	1V
Max. leakage current, LOW level:	0.5mA
Max. short-circuit current:	1.7A, electronically limited

ON delay: 0.2ms
 OFF delay: 0.05ms

 **RESET** resets all digital outputs to "logic 0" (see page 3-23).



CAUTION

The output stages may get damaged!

Do not connect capacitive loads. Inductive loads must be sufficiently protected against interference. Note the information in section 6.2 in this respect.

X51 Profibus DP Interface

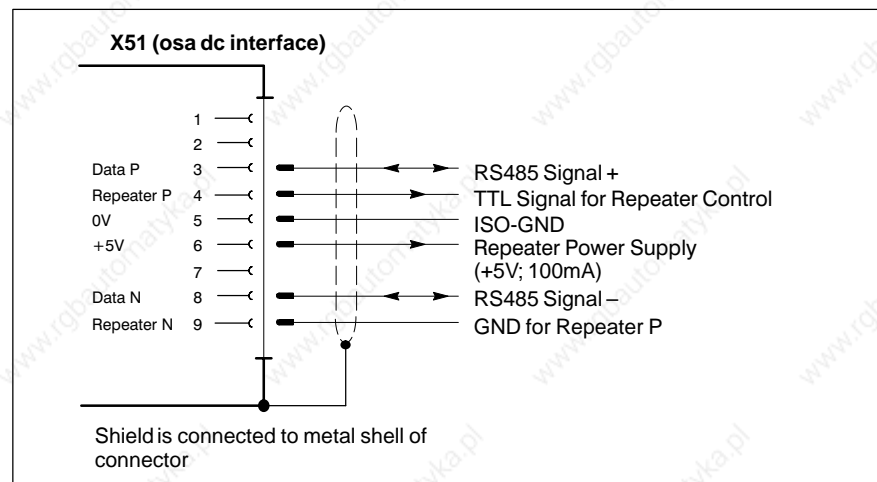

Female D-SUB connector, 9-pole

The maximum permissible line lengths are dependent upon the baudrate being used (as per DIN E 19245, part 3):

Baudrate (kBits/s)	max. line length (m)
500	400
1500	200
3000	100
6000	100
12000	100

For longer lines, suitable repeaters with a metal housing must be interconnected.



CAUTION

Malfunctions caused by inadequate shielding!

Always use only metal and/or conductive male and female connector/coupling shells with a large-area shield conductor surface.

X71 READY2, RESET Out, RESET In

In-line plug-in connector MSTB, 1.5, 6-pin, mfg. Weidmüller

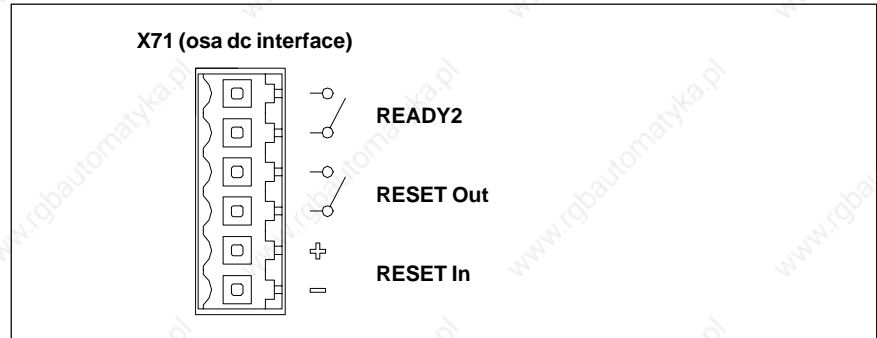

Connector X71 (osa dc interface)

Specifications – READY2:

Function:	Announces the operational readiness of the Typ3 osa Numerical Controller by closing the floating contact.
Switching current:	max. 1 A
Switching voltage:	max. 40 VDC
Switching load:	max. 40 W
Response time:	3 ms
Contact release time:	2 ms
Bounce time:	0.5 ms
Conductor area (max.):	1.5 mm ²

**DANGER**

Integrate the READY2 contact into the EMERGENCY-STOP loop of the system!

Make sure that all hazardous machine functions immediately enter a safe condition when the contact is opened.

Specifications – RESET Out

Function:	Announces the proper operating status of the internal power generation of the osa dc interface by closing the floating contact.
Switching current:	max. 0.5 A
Switching voltage:	max. 40 VDC
Switching load:	max. 15 W
Response time:	3 ms
Contact release time:	2 ms
Bounce time:	1 ms
Conductor area (max.):	1.5 mm ²

Specification – RESET In:

Function:	As RESET key (cf. page 3–23). Initiates a RESET when high level is present.
Input characteristic:	24 VDC, floating
Voltage ranges:	LOW: –3 ... +5 V HIGH: +15 ... +30 V
Conductor area (max.):	1.5 mm ²

X10 24 VDC External Power Supply

Power supply via a DC/DC converter for generating all voltages required internally and for power supply to the digital I/O interface X12 (see page 3–21).

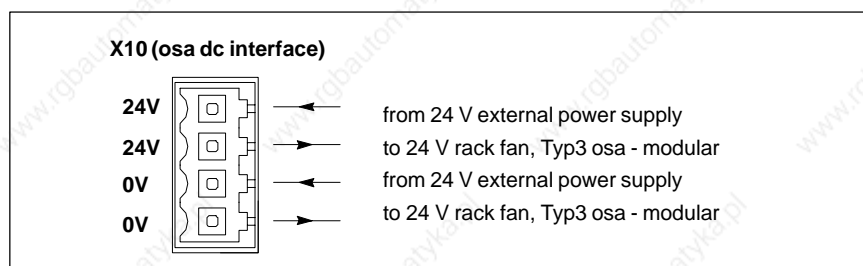

Connector X10 (osa dc interface)

In-line plug-in connector MSTB, 1.5, 4-pin, mfg. Weidmüller

Input voltage:	24 VDC, +20 %, –15 %
Permitted ripple voltage:	max. 1.2 V _{pp}
Current draw:	depending on system variant; max. 3.5 A osa rack 2: 1.22 A osa rack 4: 1.58 A (with osa master and osa plc)
Fuse protection:	Fuse F1, M6.3A
Conductor area (max.):	1.5 mm ²

**DANGEROUS ELECTRICAL VOLTAGE**

The 24 VDC input voltage must satisfy the requirements of "Safety separation"!

**CAUTION**

Risk of damage to machine or workpieces!

During the power-down sequence of the machine ensure that all drives and actuators are electrically disabled before the input power to X10 is switched OFF!

3.4.2 RESET Key

Initiates a restart of the control unit (hardware Reset).

For safety reasons, the key is concealed. It may be operated with a screwdriver or a similar instrument.



CAUTION

Loss of data and damage to the machine!

Upon detection of a RESET command, the READY2 contact opens immediately, the microprocessor of the Typ3 osa interrupts all current processes and proceeds with a restart of the control unit. This causes all unsecured data (e.g. a part program that has not yet been saved) to be lost.

Press the RESET key only if no processing operation is active and all data has been saved.

3.4.3 LED's

V_{Out} Output voltage indicator

Led illuminates when the internal supply voltages for the Typ3 osa control are being properly generated, and as long as no overtemperature is detected ($>55^{\circ}\text{C}$).

V_{In} Input voltage indicator

LED illuminates when voltage is present at X10.

Ready Ready indicator

LED illuminates when the READY2 contact is closed. This indicates that the control is operational.

3.4.4 F1 Fuse

Fuse, M 6.3 A, for protection of X10

In the presence of excessive power consumption or in the case of input voltage polarity reversal at X10, fuse F1 will blow to protect the Typ3 osa modules.

3.4.5 Battery Compartment

Accommodates a Lithium battery (Type Li-SL-760/S, 3.6 V, 1.8 Ah, AA size; order no. 1070 914 446).

The battery backs up the RAM memory ranges of all modules (osa master and osa plc). Accordingly, the data held in RAM and in the internal system clock is retained even if power to the unit is switched OFF.

The control unit permanently checks the battery charge level and, in the event that the battery must be replaced, returns an appropriate message via the display unit.

- NC hardware: ... is "empty" or "wrong polarity"

The battery can be replaced during operation because the gold capacitors on the osa master and osa plc modules provide for short-time power supply back-up.



CAUTION

Risk of data loss if battery is empty, or if the control unit is switched off when the battery is empty.

Replace a discharged battery immediately with a fresh battery of the same type.



CAUTION

Risk of health hazards caused by lithium-containing battery!

The empty battery must be disposed of as hazardous waste with the waste key code number 35 325. It may be returned to Bosch.

4 PC Control Panels

The PC Control Panels are available in the following designs:

- **osa display pc**, consisting of
 - "osa display" display unit
 - PC connected to osa display
 - osa keyboard, optionally osa switch
- **typ3 compact pc**, consisting of
 - "osa display" display unit
 - PC connected to osa display
 - osa rack 2, connected to PC
 - osa keyboard, optionally osa switch

Every PC Control Panel is connected to the osa master module via 10BaseT-Ethernet. Using this link and suitable PC software the PC displays the operator interface information of Typ3 osa on the display unit and vice versa, it feeds back all keyboard events to Typ3 osa (NC mode). File transfer between Typ3 osa and the PC is also effected via the Ethernet link.

You may change between the NC mode and the PC mode at any time via the keyboard. If the PC display is active, keyboard entries are not transmitted to Typ3 osa, in this case, the PC behaves like a standard PC.

4.1 Technical data

PC Control Panels are available with different technical specifications:

Display unit	– DSTN – TFT
Power supply	– 230 VAC – 24 VDC
CPU power	– AMD – Intel Pentium
DRAM on-board	– 16, 32, 64 MB

4.1.1 Overview

		PC Control Panel						
Control Panel variant		osa display pc (DSTN)			osa display pc (TFT)			typ3 compact pc
Designation		486A DSTN 230V	PENA DSTN 230V	PENA DSTN 24V	486A TFT color 230V	PENA TFT color 230V	PENA TFT color 24V	TFT color 24V
		PCPLN 486A	PCPLN PENA	PCPLN PENA	PCPLN 486A	PCPLN PENA	PCPLN PENA	PCPNL PENA
		32TF1 ISA2A2	32DS1 ISA2A	32DS1 ISA2D	32TF1 ISA2A	32TF1 ISA2A	32TF1 ISA2D	32TF1 ISA2KS
Part no.		1070080135	1070079816	1070079815	1070080984	1070079814	1070079813	1070079525
CPU	AMD/DX5 133 MHz	●	–	–	●	–	–	●
	Pentium 133 MHz	–	●	●	–	●	●	–
Main memory	32 MB DRAM onboard	●	●	●	●	●	●	●
Hard disk	> 840 MB IDE	–	–	–	–	–	–	●
	> 1.6 GB IDE	●	●	●	●	●	●	–
Graphics controller	for TFT color: max. resolution 640x480	–	–	–	●	●	●	●
	for DSTN color: max. resolution 640x480	●	●	●	–	–	–	–
	ext. CRT monitor connection; max. resolution 1024x768 pixels (256 colors)	●	●	●	●	●	●	●
Free slots	ISA bus (2/3 slot)	2	2	2	2	2	2	2
Power supply		osa display pc (DSTN)			osa display pc (TFT)			typ3 compact pc
PC	85–264V _{AC} In	X20	X20	–	X20	X20	–	–
	24V _{DC} In	–	–	X10	–	–	X10	X10
3.5" Floppy Disk	+5V _{DC} , +12V _{DC}	X70	X70	X70	X70	X70	X70	X70

● = available

– = not available

Interfaces	Characteristics	Connector designation (all PC variants)
1x COM1 (serial)	RS232 (UART 16550)	X34
1x COM2 (serial)	RS232 or RS485 (UART 16550)	X35
1x LPT1 (parallel)	in SPP, EPP or ECP mode	X61
1x floppy disk drive (data)	for 3.5" floppy disk drive; formatting: (720kB; 1.44MB; 2.88MB)	X71
Keyboard	MF2	X1
1x SVGA	for ext. CRT monitor connection; max. resolution 1024x768 pixels	X11
1x Ethernet	10 Base T	X52

Basic System	Operating system software	PC	Typ3osa-modular Typ3osa-compact
PC	Windows95 (US version)	Option	–
	Windows95 (German version)	●	–
	WindowsNT (US version)	Option	–
	WindowsNT (German version)	Option	–
Typ3 osa	Typ3 osa Version 3.x (German version)	–	●
	Typ3 osa Version 4.x (German version)	–	●
	Typ3 osa Version x.x (export version)	–	in preparation

●= available

–= not available

4.1.2 osa display (display unit)

The display unit is available in two designs:

- 10.4 inch LCD colour flat display, passive
- 10.4 inch TFT colour flat display, active

All flat display types provide a resolution of 640x480 pixels. Higher resolutions (800x600 and/or 1024x768) can be obtained with a separate CRT monitor. An SVGA signal output connector is provided for this purpose at the rear panel of the PC Control Panel.

4.2 Power connections

Overview

Depending on the design, the supply voltage is

- 85–264 VAC In (connector X20) or
- 24 VDC In (connector X10)

It is used for power supply to

- osa display and keyboard
- integrated PC
- 3.5" floppy disc drive

PC rear view

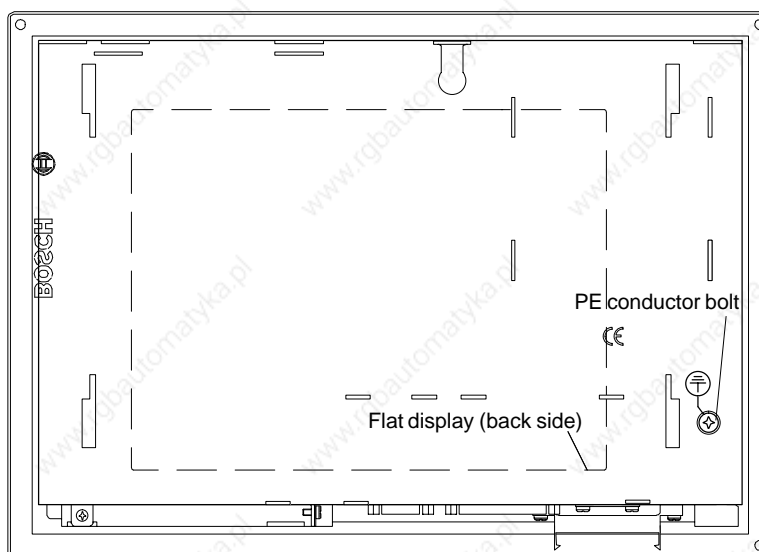

Interface:
Power supply
85–264 VAC In

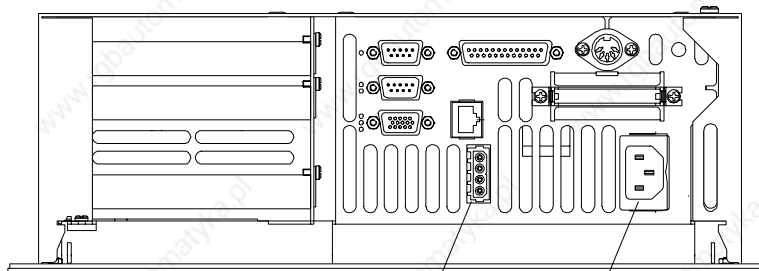

osa display

Power supply to floppy
disk drive (X70)

Power supply
85–264 VAC In (X20)

Interface:
Power supply 24 VDC In

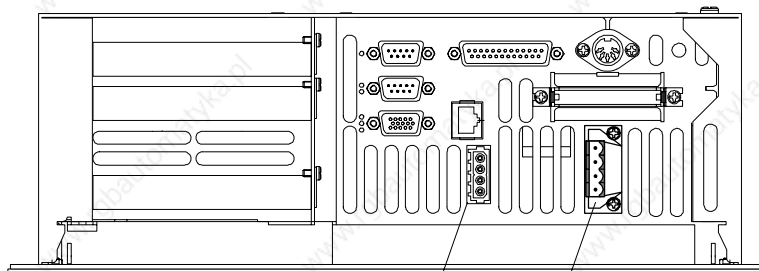

osa display

Power supply to floppy
disk drive (X70)

Power supply
24 VDC In (X10)

 The 24 VDC power connector is identical for typ3 compact pc and osa display pc.

X20 85–264 VAC power connector

Available as an alternative to the 24 VDC power connector for:

- osa display pc

All voltages required internally are generated by the internal power supply unit.

Supply:	85...264 VAC, 47–63 Hz
Max. conductor area:	1.5 mm ²
Current consumption with U _{nom} = 230VAC:	0.7 A
Current consumption with U _{nom} = 115VAC:	0.2 A (only for 80135 and 80984)
	1.4 A
	0.4 A (only for 80135 and 80984)



X10 24 VDC power connector

Available for:

- osa display pc (alternative to 85–264 VAC power connector)
- typ3 compact pc

Supply via a DC/DC converter for generating all voltages required internally.

Supply:	24 VDC, 3.5 A
Max. conductor area:	1.5 mm ² (cf. section 6.4 "Power supply")
Weidmüller plug-in terminal, MSTB 1.5, 4-pin	

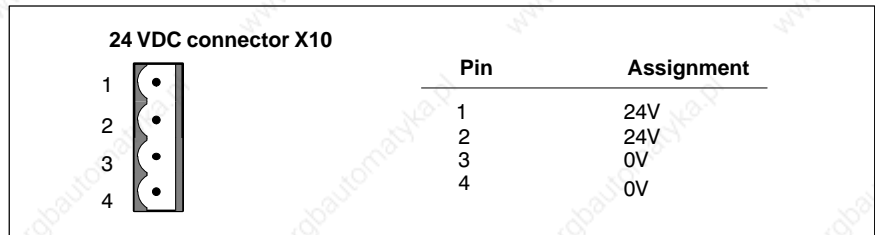

DANGEROUS ELECTRICAL VOLTAGE

The 24 VDC input voltage must satisfy the requirements of "Safety separation"!



CAUTION

Risk of damage to machine or workpieces!

During the power-down sequence of the machine ensure that all drives and actuators are electrically disabled before the input power to X10 is switched OFF!

X70 3.5" floppy disk drive power supply

Power supply to an optionally connected 3.5" floppy disk drive.

Supply: +5V, +12V, 0.9A max.

Female plug-in connector,
4-pin

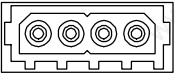
Connector (X70)		Pin	Assignment		
1	2	3	4	1	+5V
				2	GND
				3	GND
				4	+12V

4.3 Interfaces

4.3.1 Overview

The following table describes the built-in connector types of the PC Control Panels and their mating connectors.

Connector	Connection	Connector type (built-in)	Mating connector or cable
X34	COM1	9-pin male Cannon connector	9-pin female Cannon connector (V24)
X35	COM2	9-pin male Cannon connector	9-pin female Cannon connector (V24)
X61	LPT1	25-pin female Cannon connector	25-pin Cannon connector (e.g. from printer cable)
X71	Floppy data interface	34-pin male connector (IDC)	34-pin socket connector (IDC) (floppy disk drive data cable)
X52	Ethernet	Female RJ45 connector	Male RJ45 connector (twisted-pair, 8 cores)
X11	SVGA	15-pin SVGA socket	15-pin SVGA connector (from ext. monitor)
X1	Keyboard	5-pin MF2 socket	MF2 keyboard, MF2 plug

osa display plc PC Control Panel as 230 VAC variant (for 24VDC variant, cf. section 4.2):

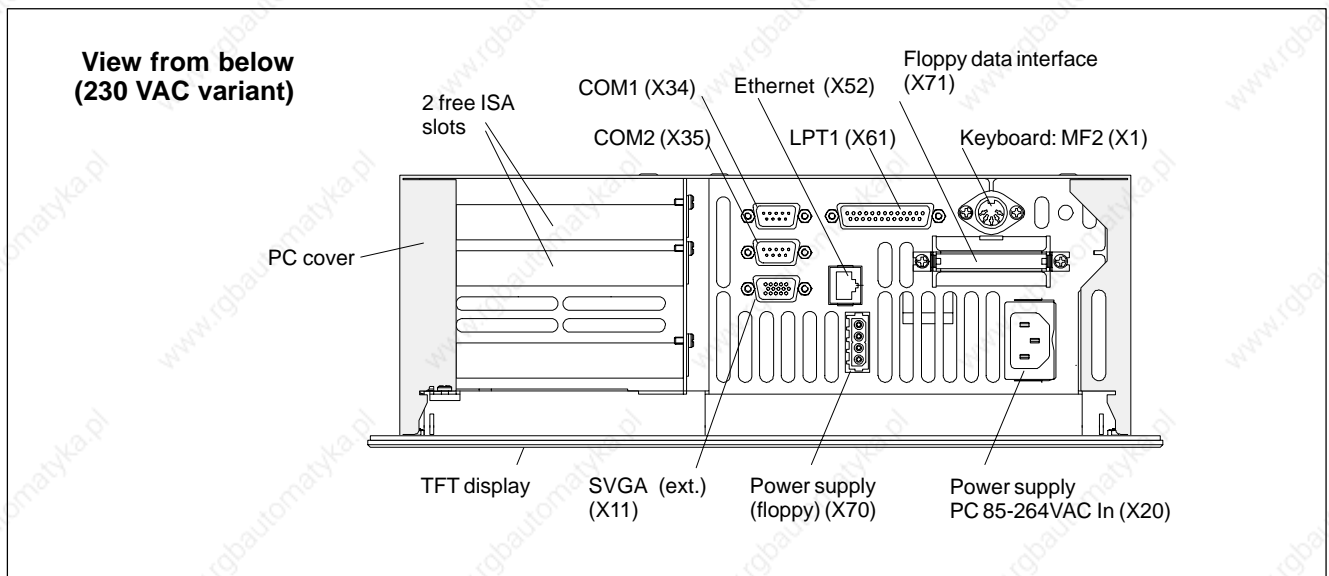

typ3 compact pc PC Control Panel with Typ3 compact connected:

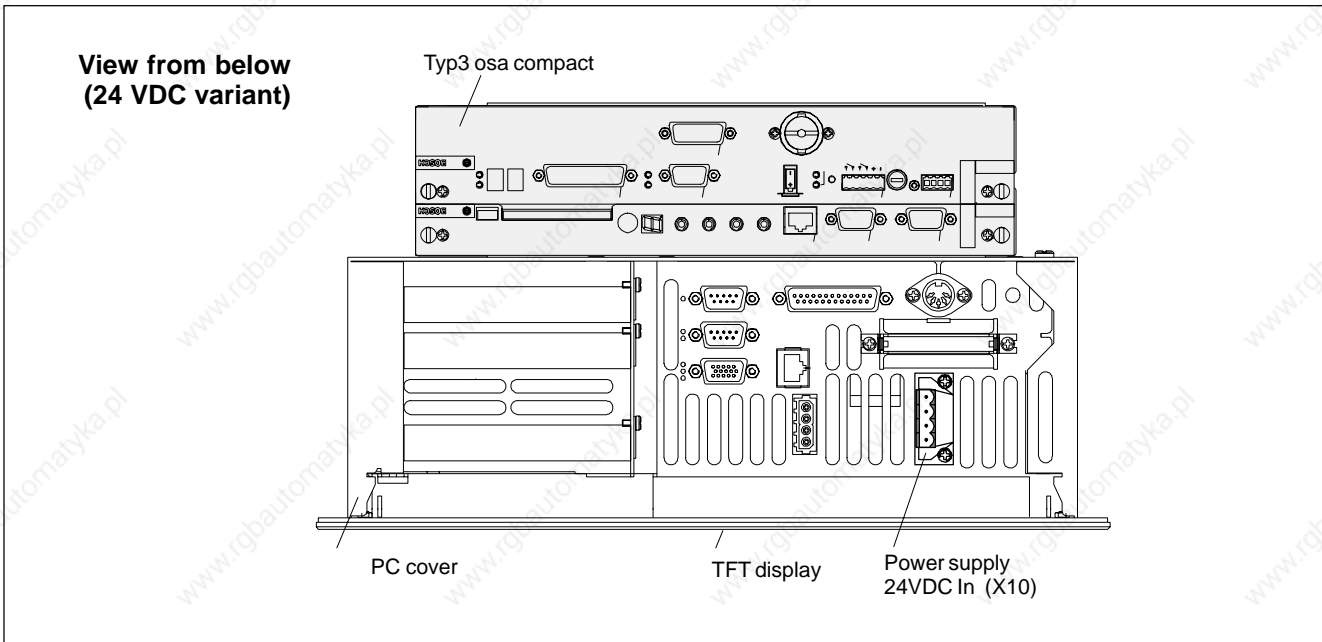

4.3.2 Serial interfaces COM1 and COM2

X34 COM1 as RS232 interface

9-pin male Cannon connector

Type:

RS232

Cable length:

max. 15 m

Cable type:

shielded, min. conductor cross-section 0.14 mm²

Transmission rate:

max. 115,200 bits/s

Handshake:

hardware and software handshake (X_{ON}, X_{OFF})

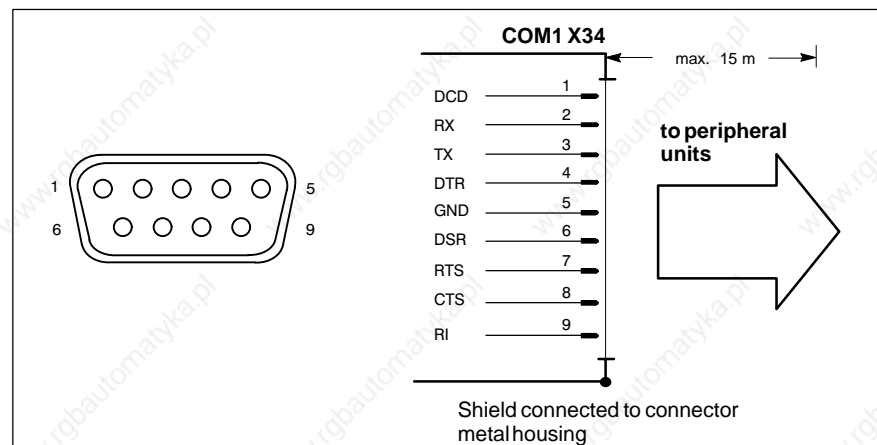

For pin assignment, cf. page 4-11.



If special hardware is to be connected to COM1, it may be necessary to adjust the communication parameters of COM1. For this purpose, call up the Windows 95/NT "System control" and select the appropriate COM1 parameter settings.



CAUTION

Malfunctions caused by inadequate screening!

Always use only metal and/or conductive male and female connector/coupling shells with a large-area shield conductor surface.

COM1 used as V.24 interface

If COM1 is used as a V.24 interface, other peripherals (e.g. an external PC) may be linked to the PC Control Panel.

The cable, part no. 1070 077 753 (length 5 m) facilitates data transmission between the PC Control Panel and an external PC with a suitable V.24 interface. Use a special transmission program, e.g. "Windows Terminal Program" for data transfer.

- Cable type: 5 x 0.14 mm²
- Cable length: 5 m (standard)
- Connector: 9-pin female D-SUB

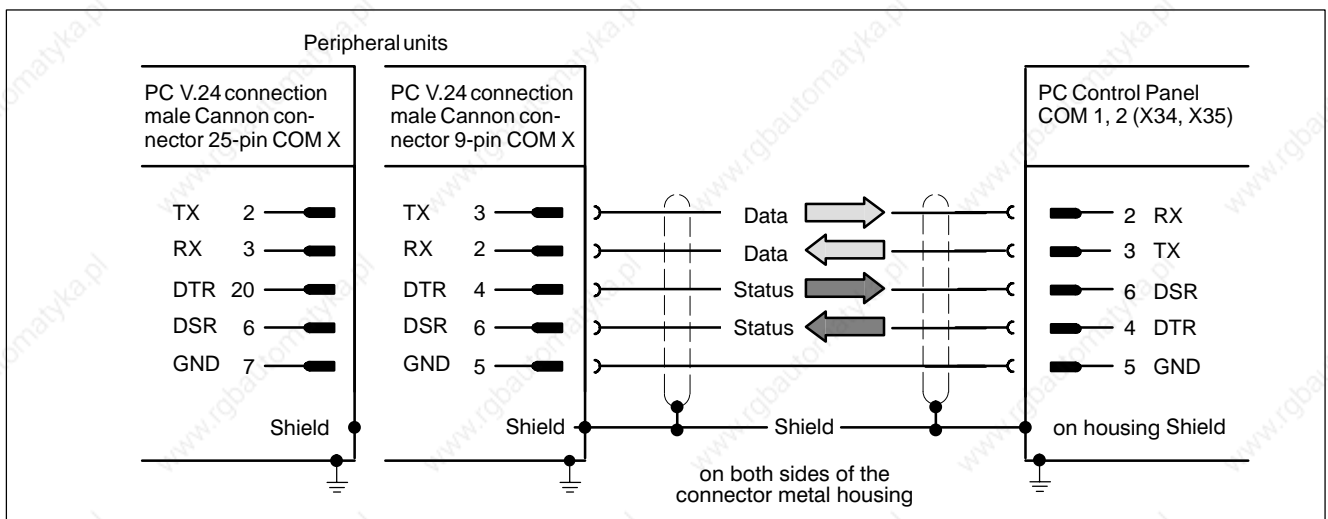

Data communication with serial peripherals

ⓘ A cable with a 25-pin female connector is not included in the Bosch delivery. 9-pin female to 25-pin female adapters are commercially available.

X35 COM2 used as RS232 or RS485 interface

9-pin male D-SUB connector

Type: RS232 or RS485; default setting depends on order

Cable length: RS232: max. 15 m;
RS485: max. 100 m

Cable type: shielded cable, min. conductor cross-section 0.14 mm²

Transmission rate: max. 115,200 bits/s (RS232)

Handshake: hardware and software handshake (X_{ON}, X_{OFF})

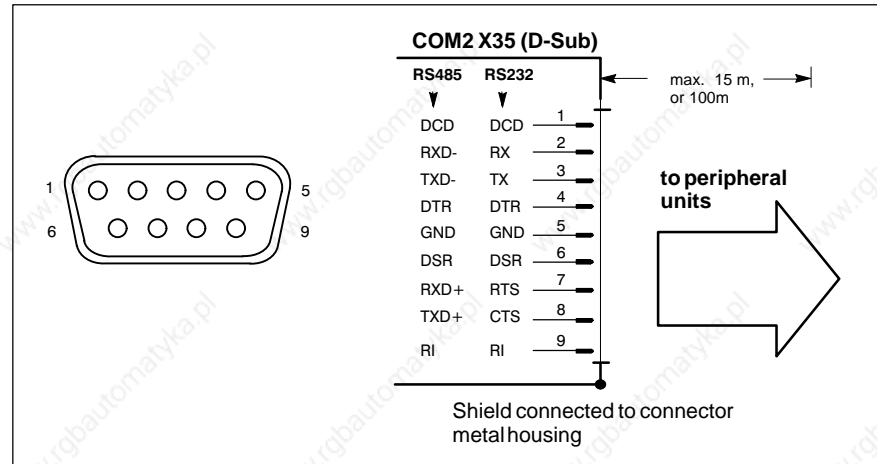

COM2 must be configured as RS232 or RS485 interface by setting an appropriate jumper (default setting depends on order):

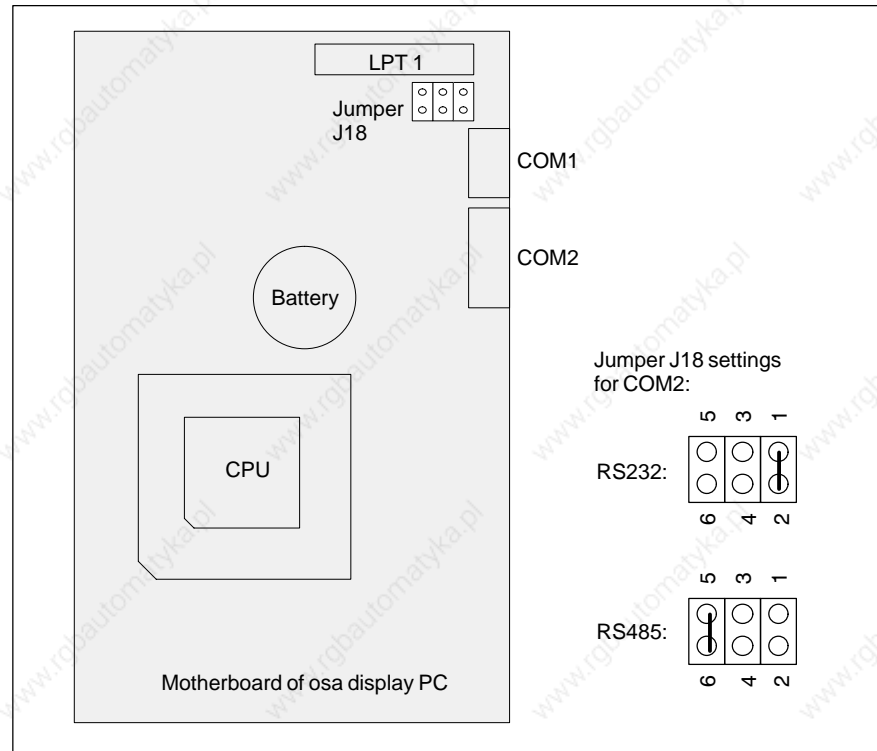

Motherboard jumper settings for COM2

Pin assignment for RS232 interface:

DCD	Data Carrier Detect; receive line used, for example, by a connected modem to signal to the PC that it is receiving a carrier signal (connection established).
RX	Receive Data; receive line for data.
TX	Transmit Data; transmit line for data to peripheral device.
DTR	Data Terminal Ready; transmit line used by the PC to signal to a connected peripheral device that its interface is enabled and initialized.
DSR	Data Set Ready; receive line used by the connected peripheral device to signal to the PC that it is powered up and initialized.
GND	Signal Ground
RTS	Request to Send; receive line used by the connected peripheral device to signal to the PC that it requests permission to send data.
CTS	Clear to Send; transmit line used by the PC to inform the connected peripheral that it is clear to send, i.e., that it has permission to send data.
RI	Ring Indicator; receive line used by a connected modem to signal to the PC that an incoming call is waiting.
Shield	Contact to metal frame of hardware module via connector metal housing of the D-SUB plug-in connector.

Pin assignment for RS485 interface:

DCD	identical to RS232
RXD-, RXD+	Receive Data; receive lines for data.
TXD-, TXD+	Transmit Data; transmit lines, data to peripheral device.
DTR	identical to RS232
DSR	identical to RS232
GND	identical to RS232
RI	identical to RS232
Shield	identical to RS232

In order to use COM2 as RS485, the cable between the motherboard and the D-SUB connector of COM2 inside the PC must be replaced (part no.: 1070078881, 14-core ribbon cable). It replaces the line inserted if COM2 is used as RS232.

**CAUTION**

Malfunctions caused by inadequate screening!

Always use only metal and/or conductive male and female connector/coupling shells with a large-area shield conductor surface.



If special hardware is to be connected to COM2, it may be necessary to adjust the communication parameters of COM2. For this purpose, call up the Windows 95/NT "System control" and select the appropriate COM2 parameter settings.

COM2 used as V.24 interface

If used as a V.24 interface, other peripherals (e.g. an external PC) may be linked to COM2 as well as COM1 (cf. page 4-9).

4.3.3 LPT1 parallel port

X61 LPT1 printer port

All printers equipped with a parallel port can be connected using a commercially available printer cable.

Male D-SUB connector, 25-pin

Type: SPP (bidirectional), EPP or ECP
 Cable length: max. 3 m
 Cable type: shielded cable, min. conductor cross-section 0.14 mm²

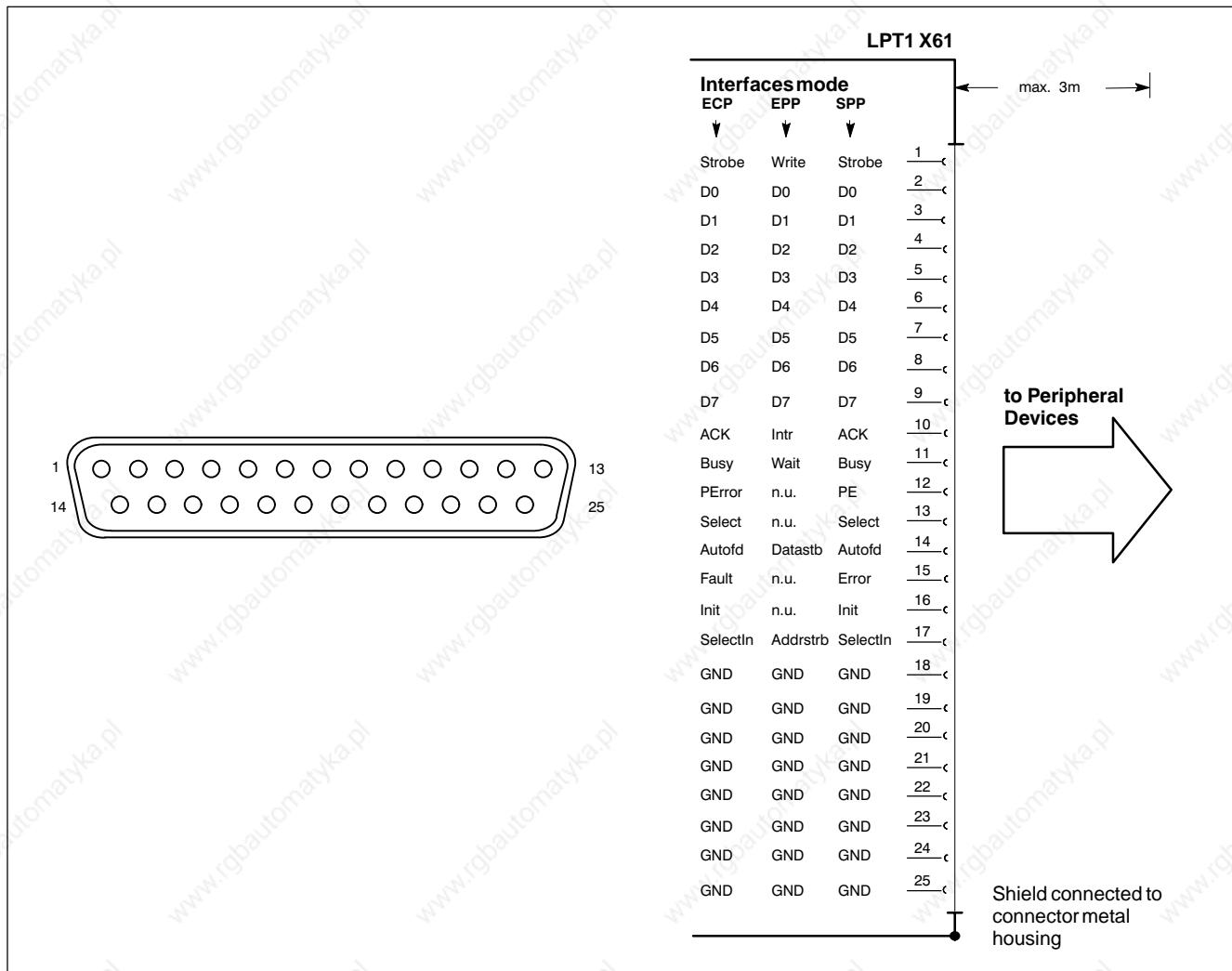

The parallel port is usually operated in SPP standard mode. It may also be used in EPP (Enhanced Parallel Port) or ECP (Extended Capabilities Port) modes if suitable peripherals are available. The settings in the PC BIOS must be changed accordingly. For more information please contact Bosch.



CAUTION

Malfunctions caused by inadequate screening!

Always use only metal and/or conductive male and female connector/coupling shells with a large-area shield conductor surface.

4.3.4 3.5" Floppy disk drive interface

X71 Connection of drive "A"

For connecting a floppy disk drive. The onboard floppy controller supports the following drive types:

- 5.25 and/or 3.5 inch
- Single-Density (360 kB and/or 720 kB)
- Double-Density (1.2 MB and/or 1.44 MB)
- Enhanced Floppy Mode (2.88 MB)

Only one drive type can be connected using a 34-pin floppy disk ribbon cable. For recommended floppy disk drives, refer to section 7.

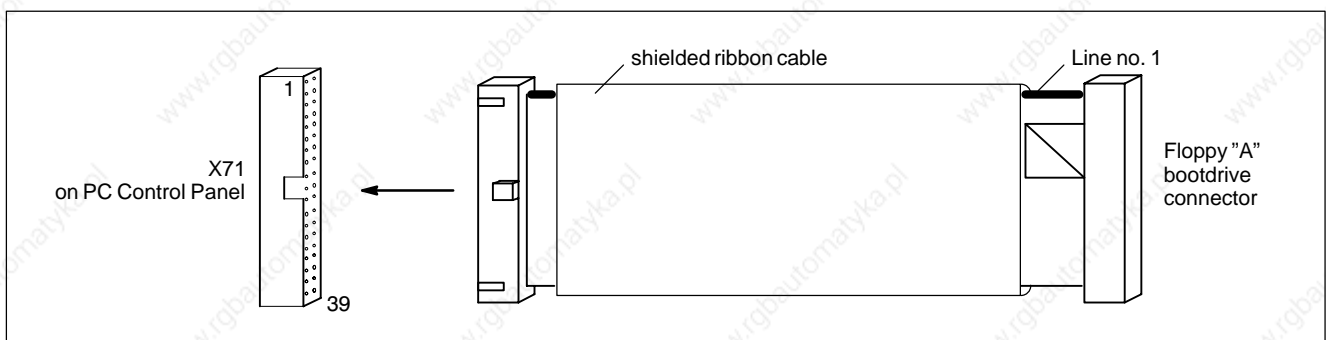

Installation

- Connect the Floppy "A" bootdrive end of the ribbon cable to the floppy disk drive. The other end of the cable should be plugged into the X71 floppy disk drive connector of the PC Control Panel. Note the line with the red marking on the ribbon cable, which always has to connect to PIN 1 of the equipment connectors to be linked. In most cases, connector notches prevent incorrect connections.
- Furthermore, the floppy disk drive has to be connected to the power supply. For this purpose, connect the cable (4-pin male connector) coming from the floppy disk drive to X70 of the PC Control Panel.

☞ If the floppy disk drive is permanently installed, both connections (X70, X71) must be shielded, and the shield conductor must be connected to frame potential at both ends.

Subsequent to the installation, you must register the installed drives by means of the PC's AMIBIOS setup program. Proceed as follows:

- Switch ON the PC Control Panel again.
- When you see the "Hit if you want to run SETUP" user prompt, press the DEL key. This starts the setup program.
- Begin by selecting the Standard symbol, followed by Floppy A.
- Select the value matching the drive's capacity (360 kB, 720 kB, 1.2 MB, 1.44 MB or 2.88 MB).
- Return to the Main Menu of the setup program, and select the Peripheral symbol. There, the OnBoard FDC parameter must be set to Enabled. If this is not the case, you should first set the Programming Mode parameter to manual. Conclude by setting the OnBoard parameter to enabled.

- Save the new settings by pressing the ESC key while in the Main Menu, and then selecting Save changes and Exit.
- Once the PC has booted up again, you should be able to access drive A. If this is not the case, switch OFF the PC Control Panel and check that controller cable and floppy disk drive wiring are properly seated in their sockets. Reboot the PC.

4.3.5 Ethernet interface

X52 Ethernet

The Ethernet interface is used to connect the PC Control Panel to Typ3 osa. This connection can also be made via a network (cf. figure).

Femal RJ45 connector, 8-pin

Type:	Ethernet 10-Base-T
Cable length:	max. 100 m
Cable type:	Shielded twisted-pair
Transmission speed:	10 Mbit/s 100 Mbit/s (in preparation)

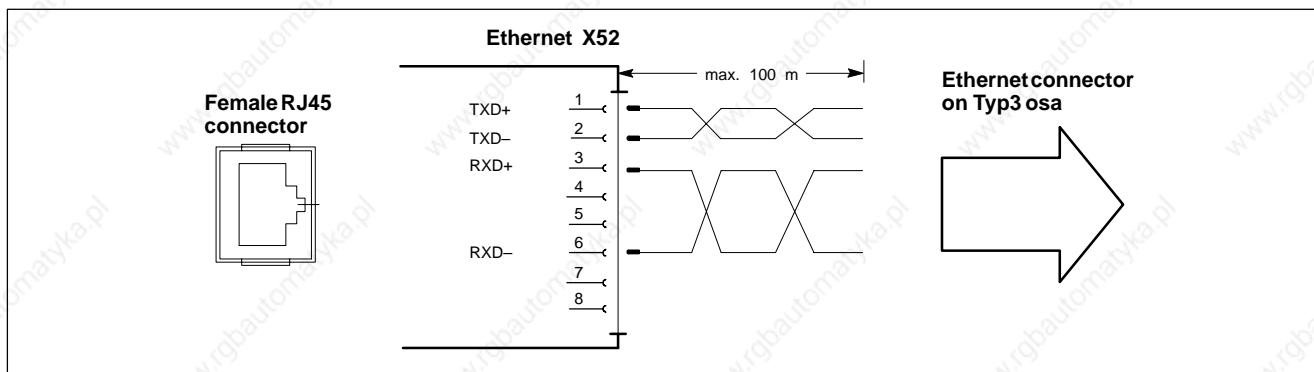

Network wiring

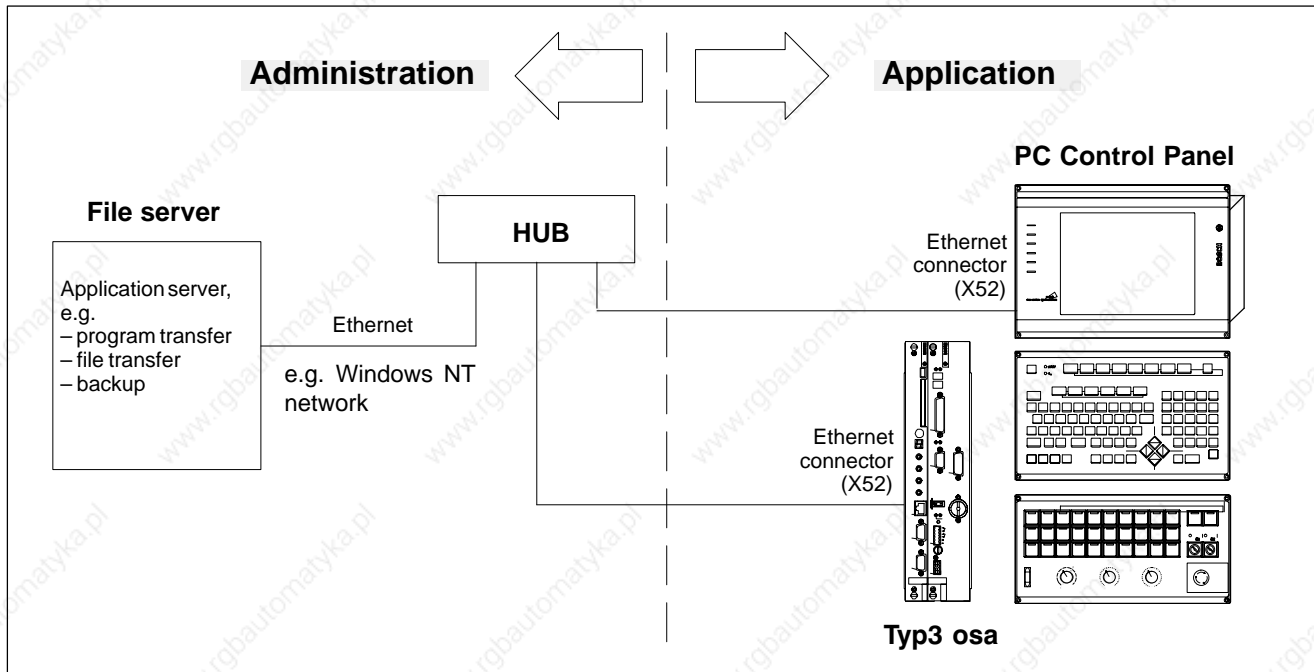

CAUTION
Malfunctions caused by incompatible cables!
Use only preassembled original cables for all connections.

4.3.6 SVGA interface

X11 Screen connector

SVGA output for connecting a CRT monitor to obtain a higher screen resolution.

Female HD connector, 15-pin

Max. resolution: 1024 x 768 pixels (at 256 colors)

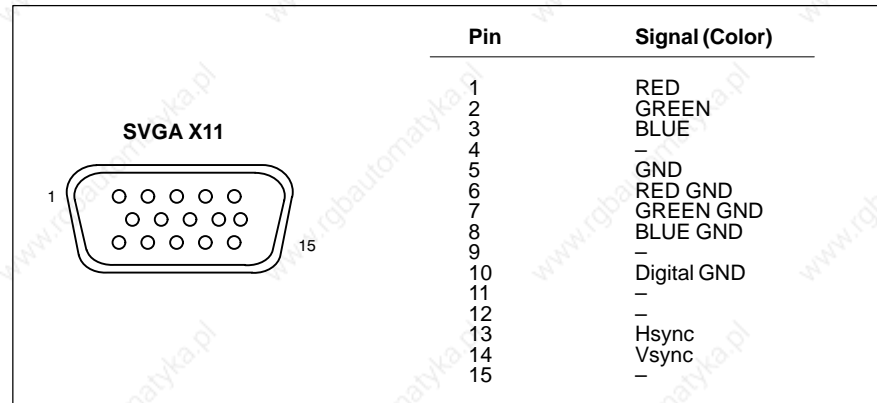

4.3.7 MF2 interface

X1 MF2 keyboard connector

Female DIN connector, 5-pin

Cable length: max. 1.5 m

Cable type: shielded cable, min. conductor cross-section 0.14 mm²

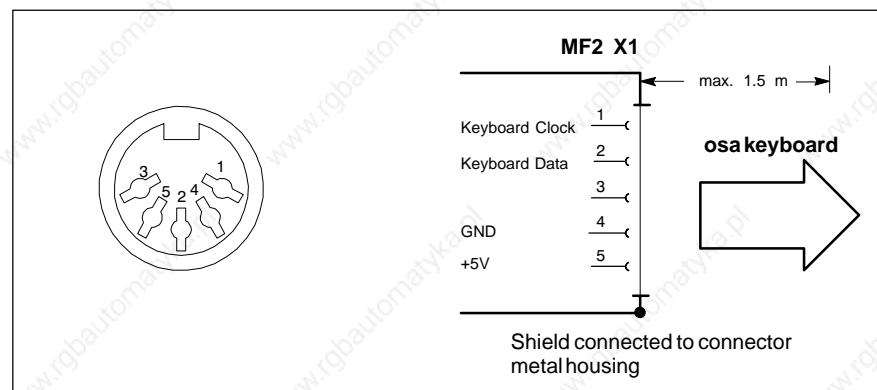

4.3.8 Free ISA slots

The PC Control Panel can accommodate 2 additional expansion boards. The dimensions of the expansion board may be approx. 180x100 cm (2/3 board), and the board must be suitable for the ISA bus.

There are no limitations as to the selection of the expansion board, provided that it satisfies the technical requirements of the Windows 95 and/or Windows NT operating system and is operational in this environment.

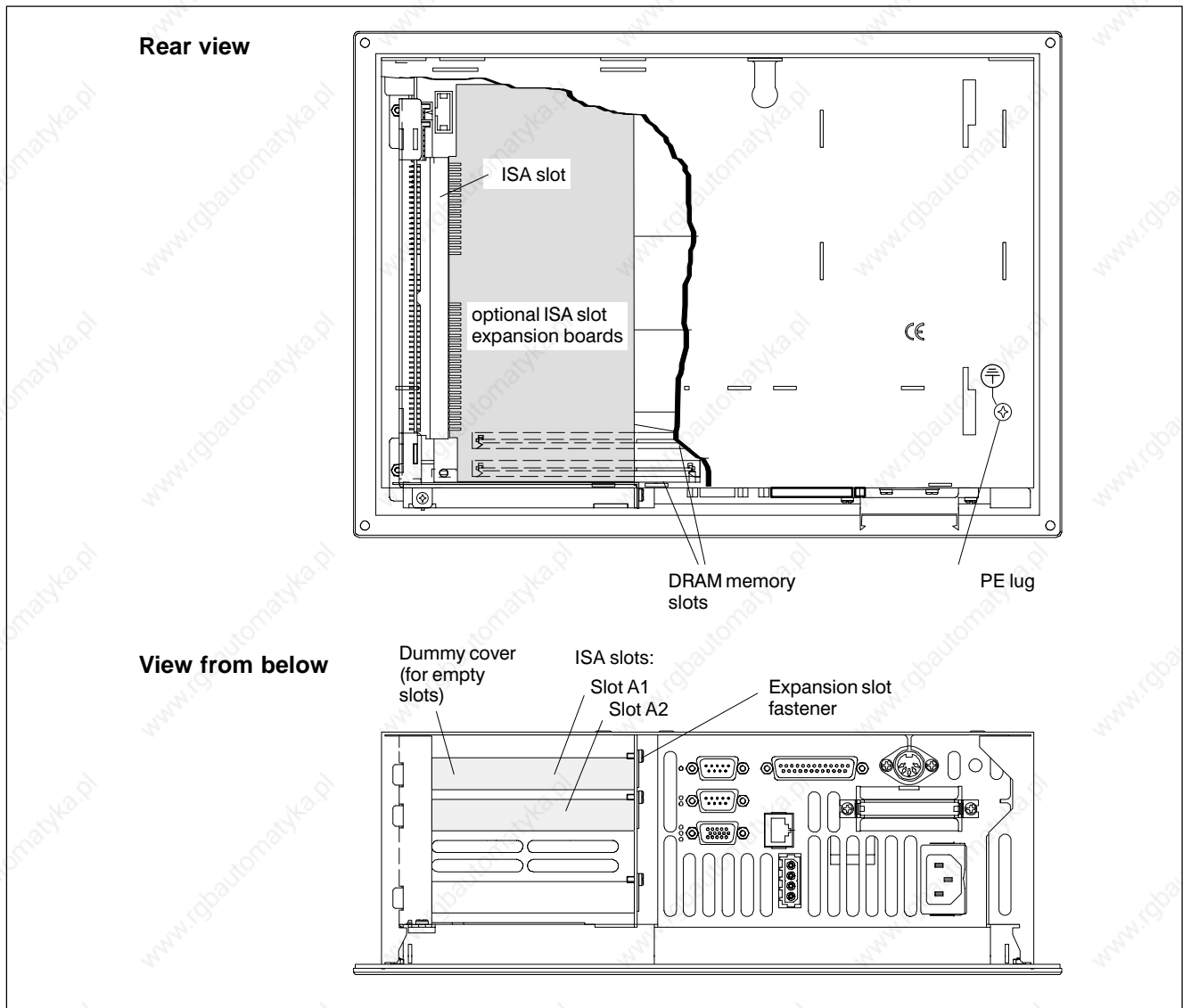

Installation of an ISA expansion card

- ★ Disconnect the unit from power (if necessary, remove plug from connector X20/X10).
- ★ Remove the PC cover and blanking plate (dummy cover) of the slot
- ★ Press the contact side of the expansion board into one of the slots at the side of the board.

- ★ Fasten the mounting frame of the expansion board to the PC enclosure (original fastening of dummy cover) and reinstall the PC enclosure to the PC-Modular. Keep the dummy cover in case the expansion board is removed later.
- ★ Reconnect the power supply to the PC (connector X20).
- ★ When the PC operating system has been rebooted, you may configure the driver software and the associated expansion board software as described by the manufacturer.

Software installation

Normally, the ISA expansion board is accompanied by the driver software for the PC. Make sure that the card is accompanied by the driver software required for **Windows95** and/or **WindowsNT** (depending on the operating system installed on your PC when delivered). For more details on the installation, please refer to the manufacturer's manual for the board.

Application example:

Internal modem for data transmission through the telephone network:

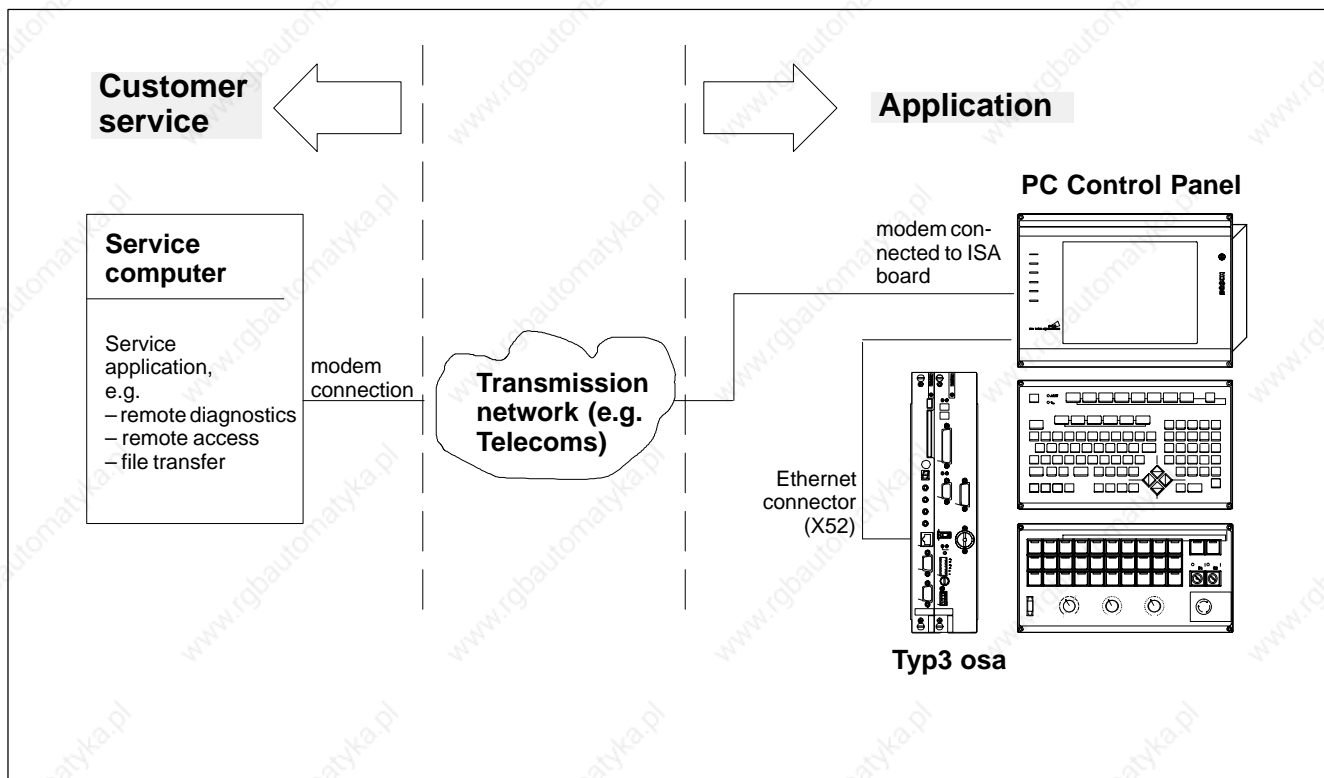

4.4 osa keyboard

The osa keyboard is an integral component of the PC Control Panel. It includes:

- CNC-specific keys, including Softkeys.
- QWERTY keyboard
- Separate numeric keypad

The keyboard is used to operate both the Typ3 osa Numerical Control and the integrated PC. An additional PC keyboard is therefore not required.

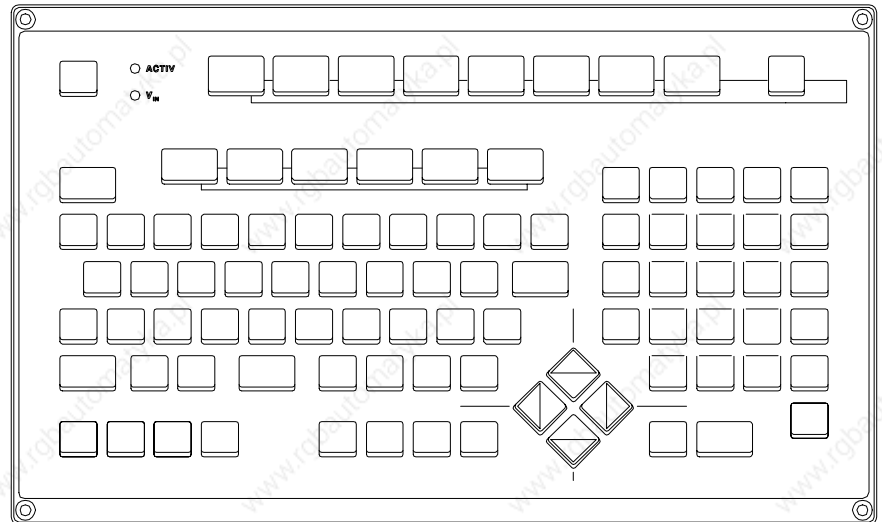

The keyboard is shipped from the factory with a 1.5-metre connecting cable and connector to match the keyboard interface (X1) of the integrated PC.

In the event that you are not using the standard keyboard cable supplied by Bosch, please ensure that the maximum permissible length of 2.5 m between keyboard and PC is not exceeded.

Keyboard setting options

On the back side of the keyboard, there are DIP switches for adjusting the keyboard to the PC.

The DIP switch positions are set to default settings for standard applications in the factory.

Explanation of DIP Switches

Switch	Position: OFF	Position: ON
S1	Automatic match to XT / AT	XT
S2	Reserved. / Pass-through enabled	Reserved. / Pass-through disabled
S3	Auto repeat normal	Auto repeat OFF
S4	Key click ON	Key click OFF
S5	n-key rollover	2-key rollover
S6	not used	not used

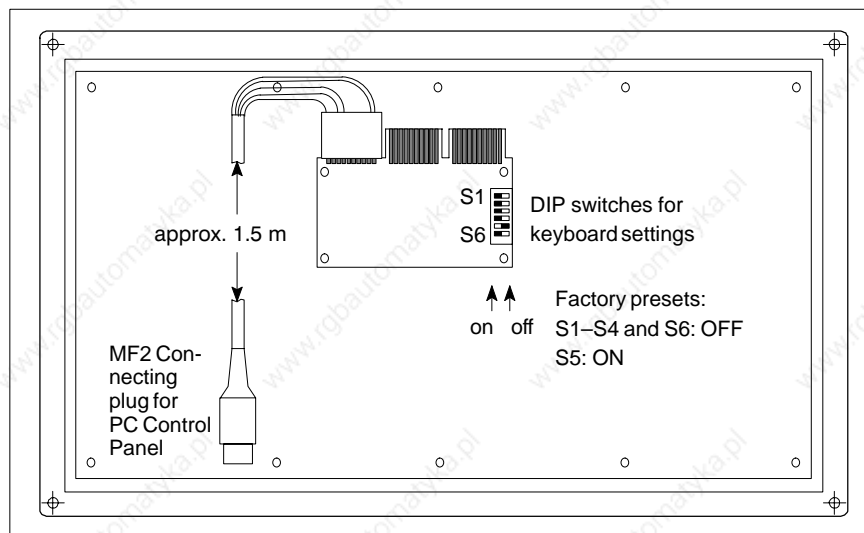

Back side of osa keyboard

4.5 osa switch (Machine Control Panel)

The osa switch is available as an optional accessory. With regard to design and dimensions, it is designed to match PC Control Panel. Connection to X51 of the osa master module.

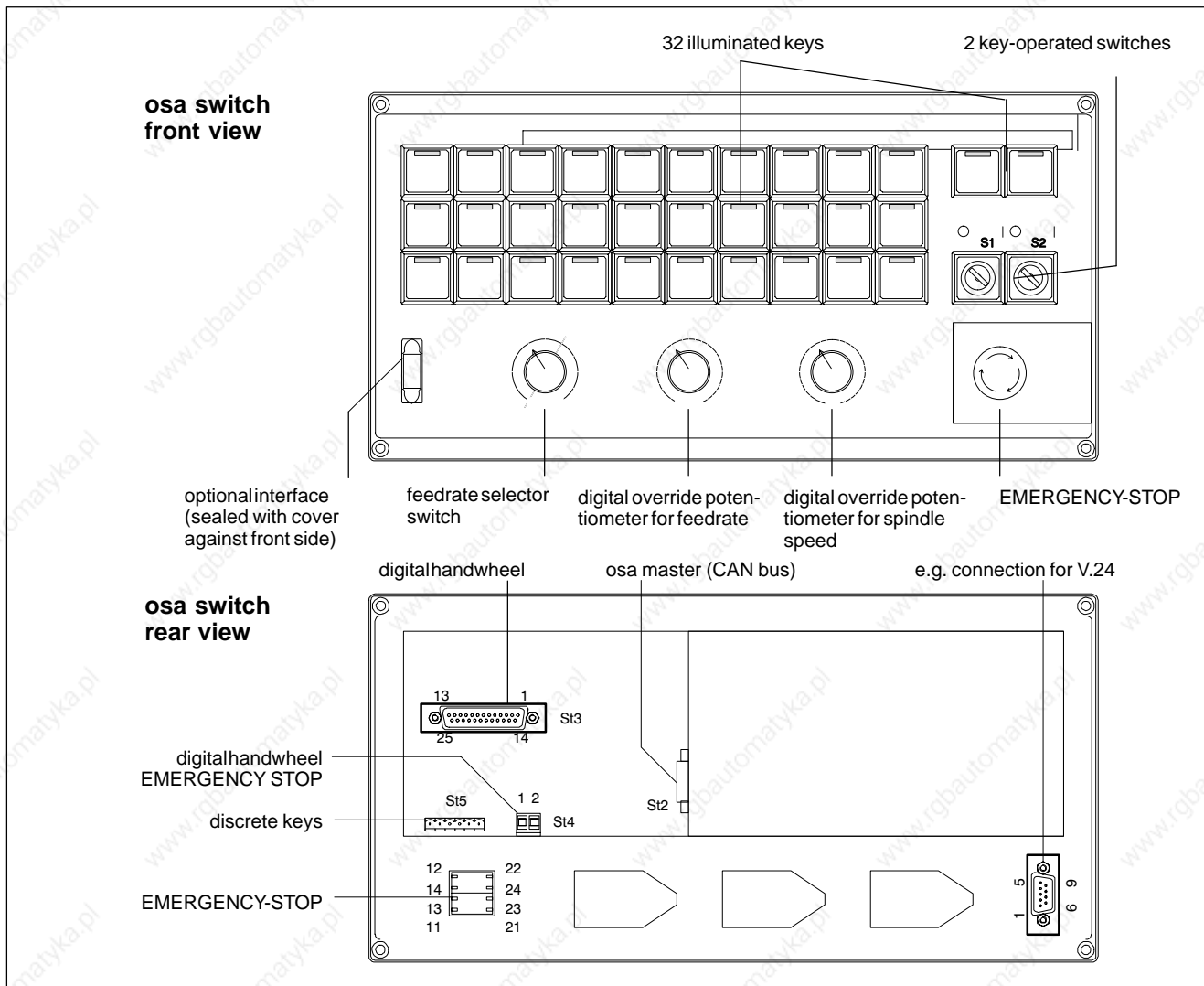

Control elements and interface connectors:

- 32 illuminated keys
 - Key switches
 - Feedrate selector switch (max. 11 steps)
 - Digital stepping switch for feedrate in % (max. 28 steps)
Although ranges and increment sizes can be modified by means of MACODA parameter 103000004, key labeling will no longer correspond to actual settings.
- Total range: from 0 to 120%,
 subdivided into individual ranges: 0 to 10% (increment size: 2.5%)
 10 to 80% (increment size: 10%)
 80 to 120% (increment size: 2.5%).

- Digital stepping switch for spindle speed in % (max. 31 steps)
Although ranges and increment sizes can be modified by means of MACODA parameter 107000018, key labeling will no longer correspond to actual settings.

Total range: from 0 to 150% in 5 % increments

- EMERGENCY-STOP, 2-channel, max. load: 24 V, 2 A (safe to EN 418)
- Interface for digital handwheel (female D-SUB connector, 25-pin)
- Male D-SUB connector, 9-pin, for connection to X51 of the osa master module
- D-SUB 9-pin male/male coupling. Used, for example, to bring out the V24 interface X35 from the osa master to the front panel of the osa switch.

The logical statuses of all keys, switches and potentiometers – as well as the data of a connected handwheel – are cyclically transferred to the Typ3 osa via CAN bus, and mapped onto markers. Furthermore, markers can be set for the purpose of switching On or Off the function and illumination of individual keys. The functionality of individual control elements must be implemented by means of the appropriate interpretation of markers through the PLC software.

 For additional information (i.e., assignment of control elements and marker addresses), please refer to the “Typ3 osa Project Planning Manual ICL700”, cf. page 1-9.

4.5.1 Connection to osa master

St2 CAN bus

Osa switch is connected to X51 of the osa master module via St2

Female D-SUB connector, 9-pin

Type: CAN bus

Cable length: max. 30 m

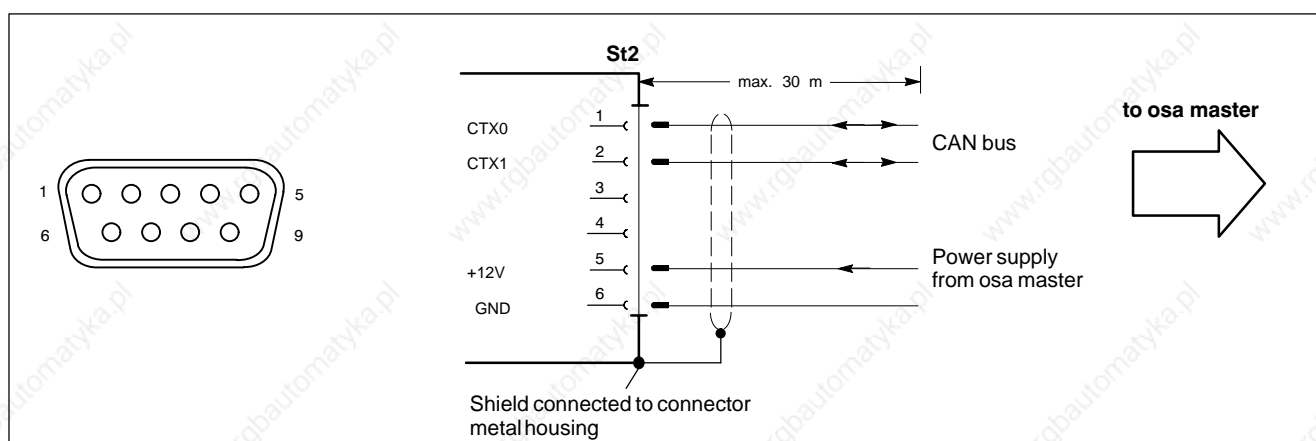

CAUTION

Malfunctions caused by incompatible cables!

Use only preassembled original cables for all connections.

4.5.2 Connection of EMERGENCY-STOP mushroom striker

The EMERGENCY-STOP mushroom striker must be connected to the EMERGENCY-STOP loop. It is tamper-proof to EN 418.

Male connector, 8-pin

Type: two-channel: 2 ncc's, 2 noc's

Max. load: 24 V, 2 A

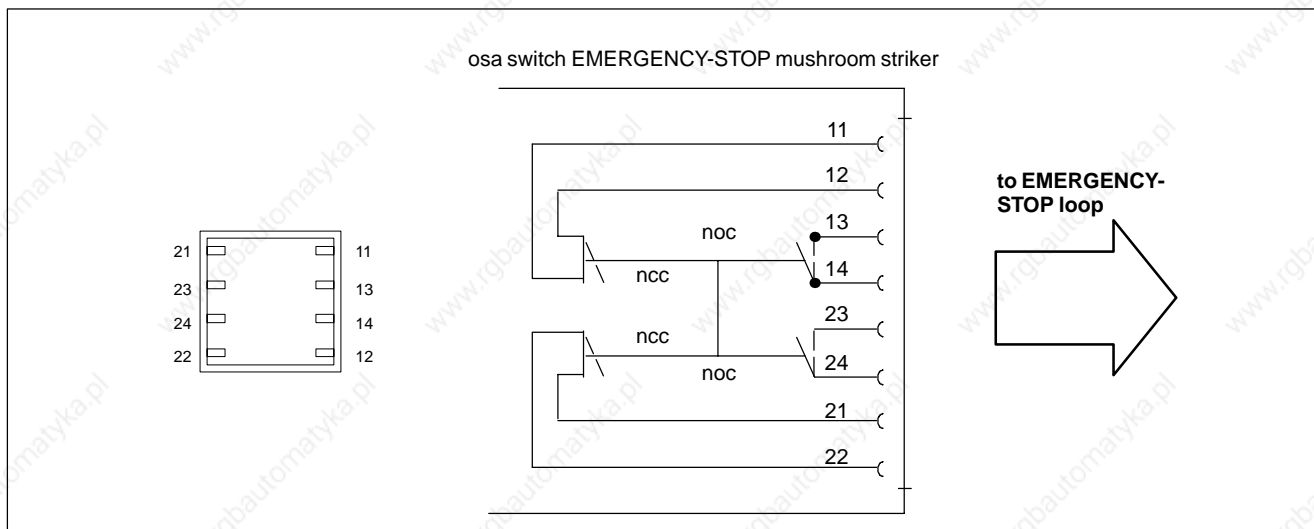

DANGER
 Danger of life through inadequate EMERGENCY-STOP devices!
 EMERGENCY-STOP devices must be active and within reach in all system modes. Releasing an EMERGENCY-STOP device must not result in an uncontrolled restart of the system! First check the EMERGENCY-STOP circuit, then switch the system on!

4.5.3 Connection of digital handwheel/manual operating unit

St3 Data lines

The following pin assignment of St3 on the osa switch is shown as an example of a connection configuration for a handwheel or manual operating unit made by Messrs. Euchner:

Female D-SUB connector,
25-pin

Connection type: iaw RS422 A

Line length: max. 3.5 m, extendible spiral cable

Supply voltage: 5 V

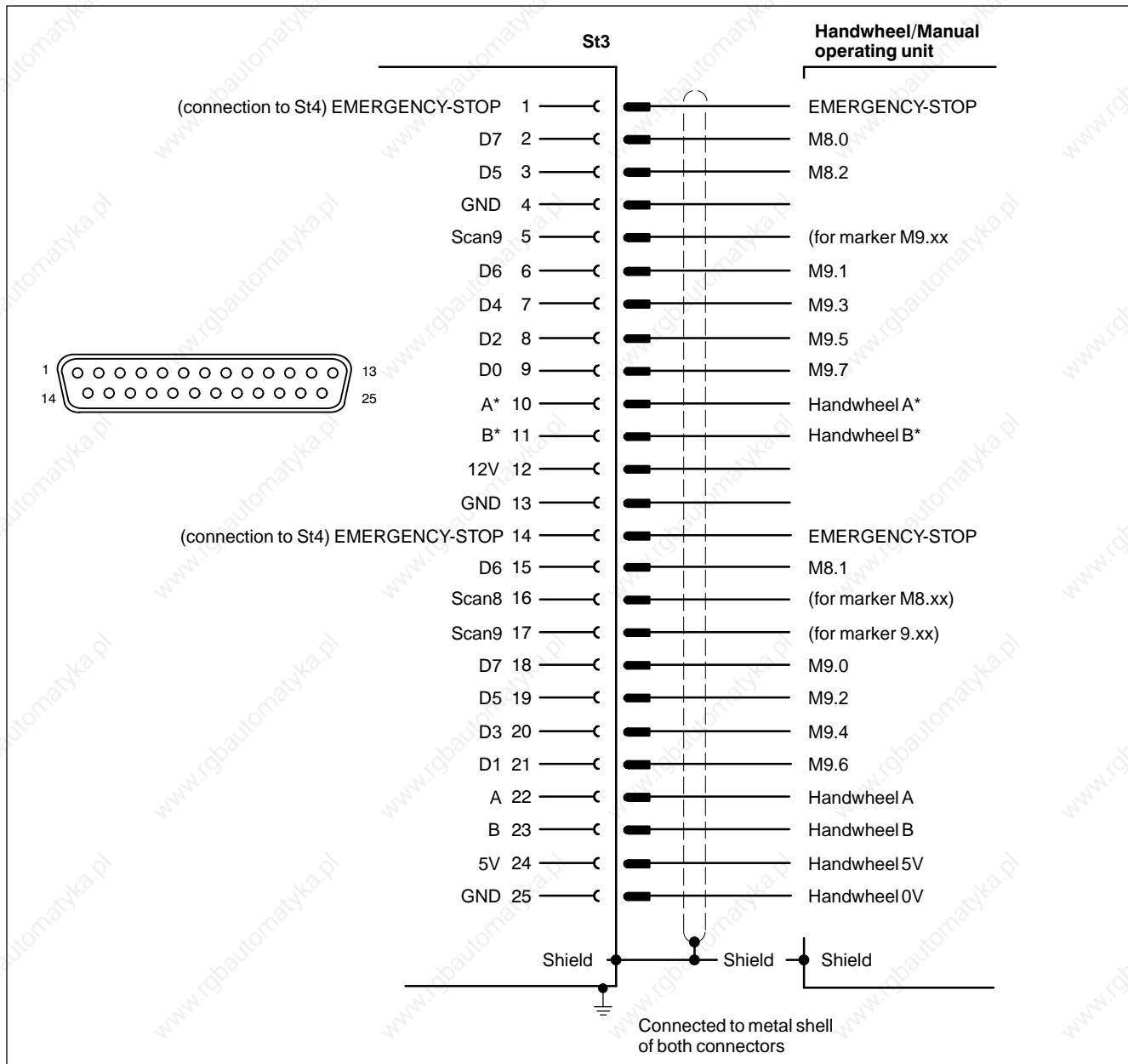

St4 EMERGENCY-STOP connection

The St4 EMERGENCY-STOP connection may be used if a manual operating unit is equipped with an EMERGENCY-STOP button which is to be connected to the EMERGENCY-STOP loop. The EMERGENCY-STOP signal is supplied by connector St3 and connected to St4 via the circuit board. The contacts of St4 are linked to the EMERGENCY-STOP circuit.

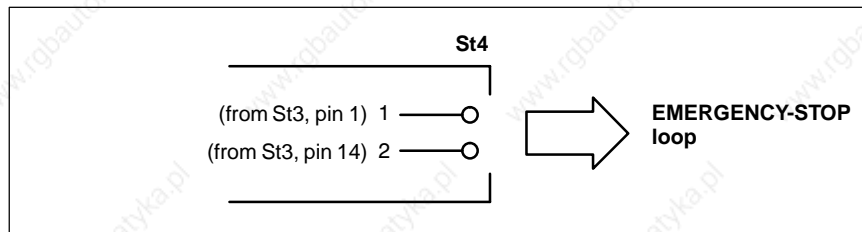

4.5.4 Connection of additional external keys

St5 additional discrete keys

Male Weidmüller connectors, 6-pin

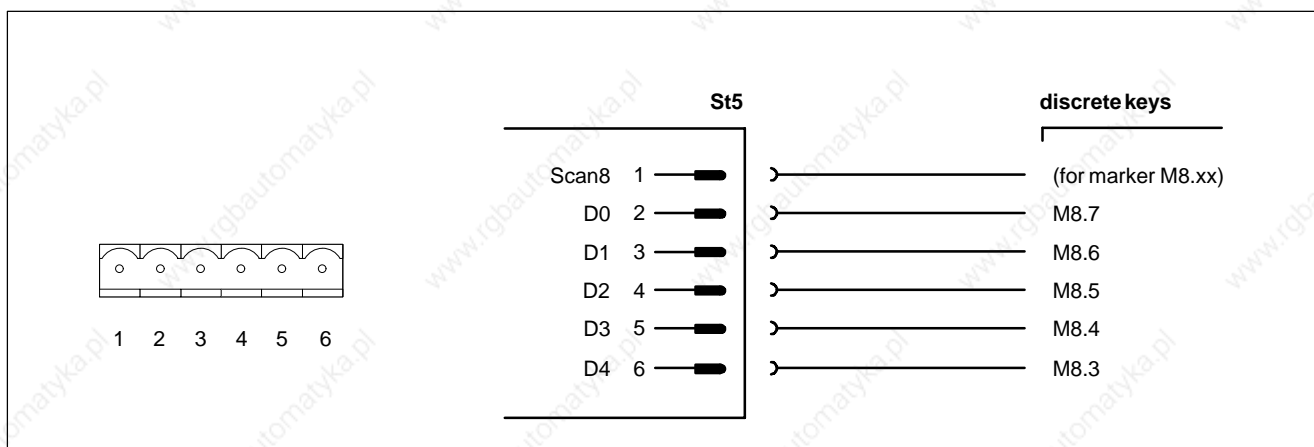

4.5.5 Front-sided interface

The front side of the osa switch accommodates an interface connector which can be alternatively assigned as:

- V.24 interface to osa master (X35) or
- COM1/2 port for connection to PC Control Panel

A detachable cap is fitted to the interface connector to protect it against moisture.

V.24 interface X35 of osa master:

The interface designated V.24 in the figure below is always available as a data port for linking external peripherals. The interface named Debugging can only be used for debugging purposes.

 **The Debugging interface can only be used if the "osa dc interface" module has been inserted.**

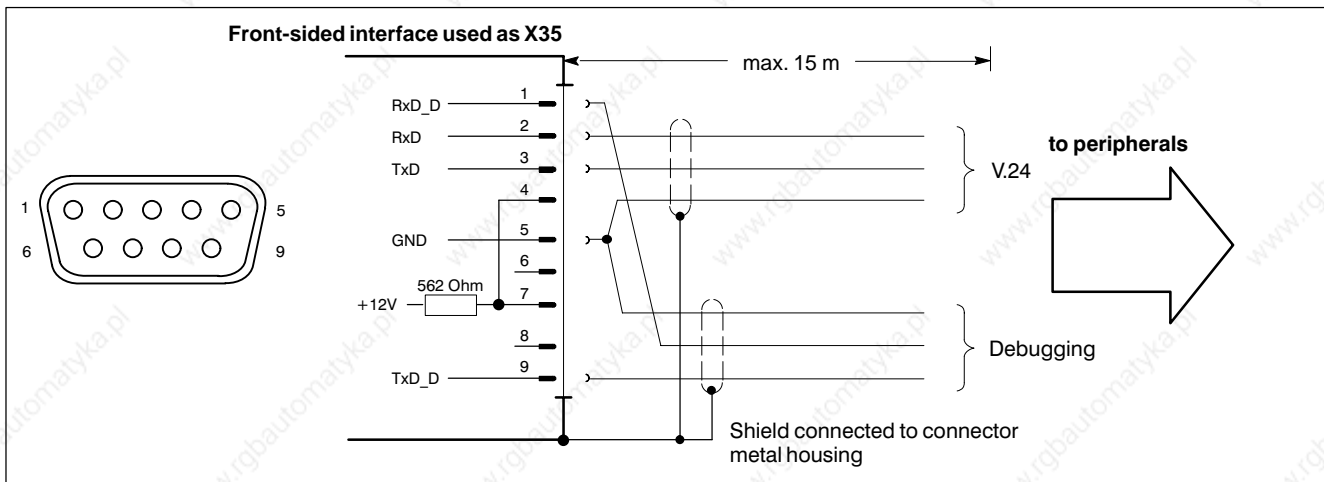

 **The pin assignment is identical to X35 of the osa master, cf. page 3-5.**

RS232 interface COM1 of PC Control Panel

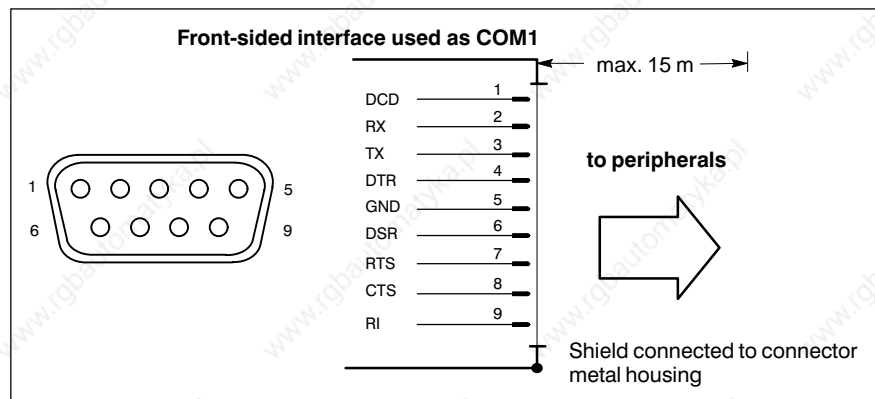

 **The pin assignment is identical to COM1 of the PC Control Panel, cf. page 4-8.**

5 Installation

The following installation instructions refer to the PC Control Panel variants "osa display pc" and "typ3 compact pc", osa keyboard, and osa switch, as well as the control unit versions Typ3 osa-compact and Typ3 osa-modular. For applicable standards and conditions of use, refer to sections 2.3 and 2.4.



CAUTION

Danger for product!

The ambient air must be free from conductive contaminations (acids, alkalis, corrosive agents, salts, metal vapors, etc.).

Filters in the air inlet and outlet must be regularly serviced.



DANGER

The operational reliability of components designed to be installed in housings or switch cabinets is considerably impaired if these units are operated or handled while not being installed in such enclosures.

Therefore, you should operate and handle the Typ3 osa components only when installed in an enclosure.

- ☞ **A maintenance-friendly installation, i.e. easy access to the connection leads and fuses, is of great importance.**
- ☞ **Prior to installation, you should note down the data on the nameplates. In case nameplates are no longer visible or legible after installation, you may access this data quickly at any time.**

5.1 osa rack 2 for Typ3 osa-compact

Weight: approx. 4 kg when fully equipped

Orientation: 0° to max. 45° slanted position; fastened to back side of the osa display PC

Installation type: in console or swivel frame, sealed in accordance with IP54

- In order to ensure adequate ventilation and cable access, provide a minimum top and bottom clearance of 50 mm.
- The maximum distance between the osa rack and a PLC expansion rack is limited by the length of the available connecting cables between ICL and AG/Z-S. Cable length is 0.55 m.
- Maintain as much distance as possible from sources of interference.

For installation, push the osa rack 2 into the holding slots of the PC cover.

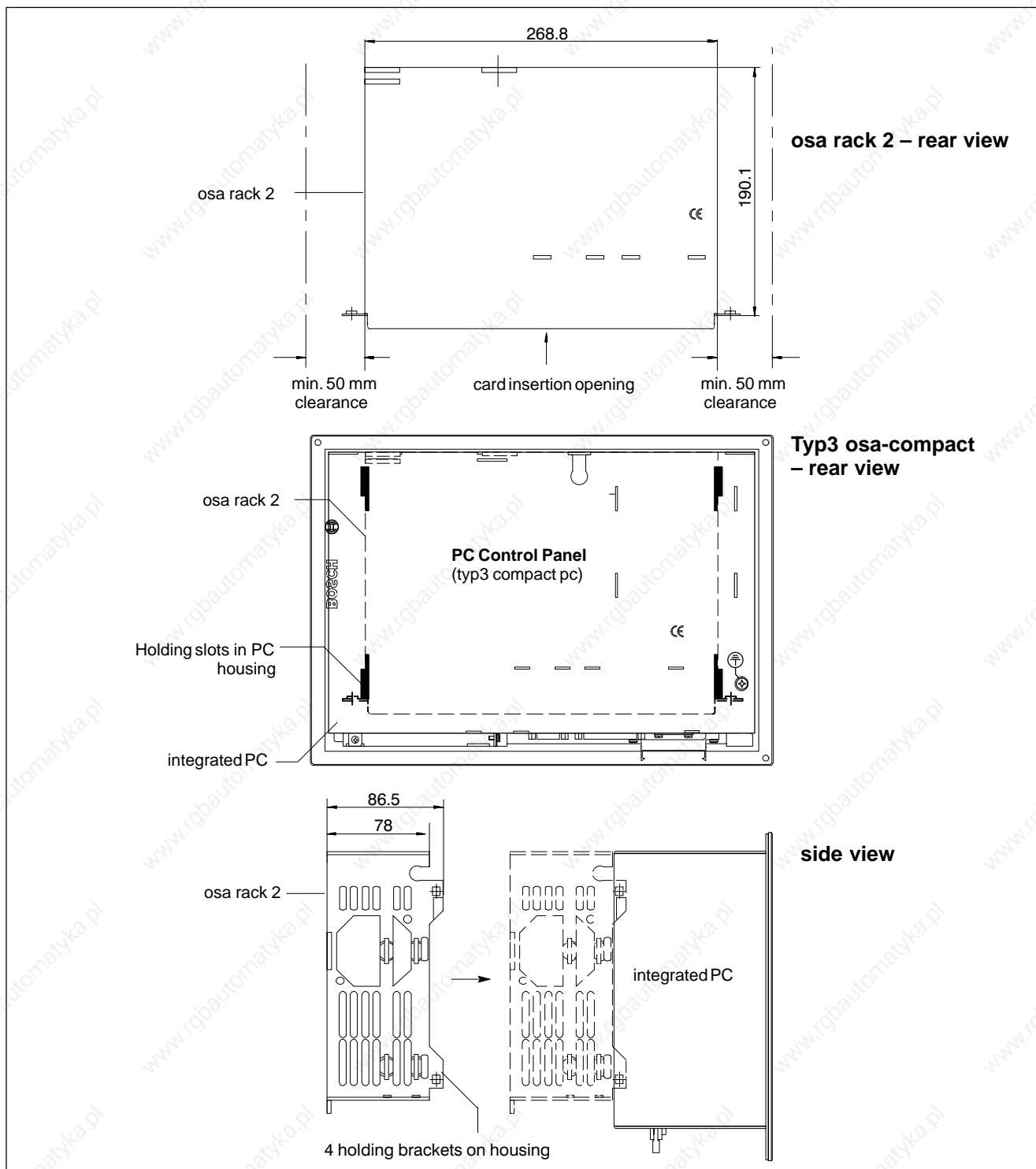

5.2 osa rack 2 for Typ3 osa-modular

Weight: approx. 9 kg when fully equipped
 Orientation: vertically; fastened to back side
 Installation type: in switch cabinet, sealed in accordance with IP54

- In order to ensure adequate ventilation and cable access, provide a minimum top and bottom clearance of 50 mm.
- The maximum distance between the osa rack and a PLC expansion rack is limited by the length of the available connecting cables between ICL and AG/Z-S. Cable length is 0.55 m.
- Maintain as much distance as possible from sources of interference.
- Fasten the osa rack 2 with 2 hexagon head approx. screws size M6 on an even metallic surface.
- Hang the osa rack onto the screws and tighten the screws. A conductive connection to the mounting surface must be established via the screws.

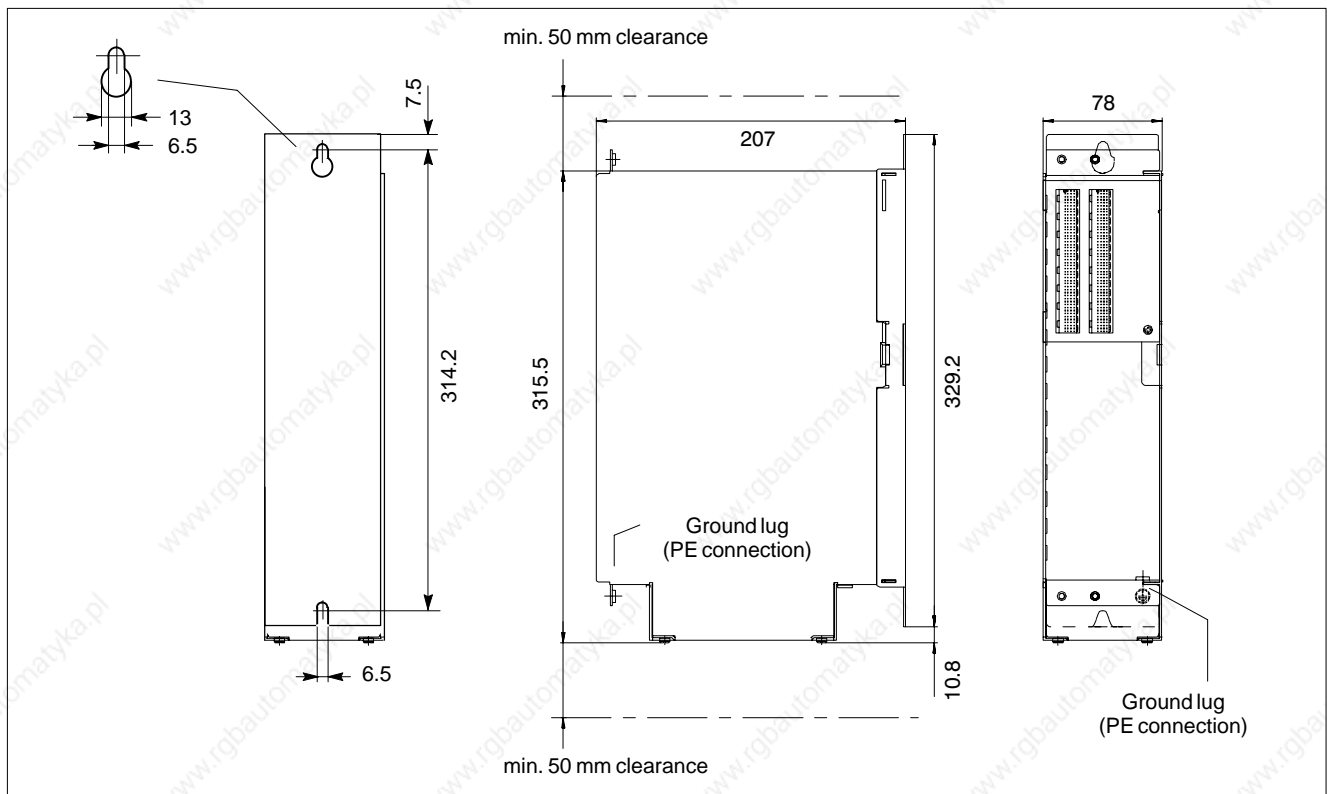

5.3 osa rack 4 for Typ3 osa-modular

Weight: approx. 10 kg when fully equipped
 Orientation: vertically; fastened to back side
 Installation type: in switch cabinet, sealed in accordance with IP54

- In order to ensure adequate ventilation and cable access, provide a minimum top and bottom clearance of 50 mm.
- The maximum distance between the osa rack and a PLC expansion rack is limited by the length of the available connecting cables between ICL and AG/Z-S. Cable length is 0.55 m.
- Maintain as much distance as possible from sources of interference.
- Fasten the osa rack 4 with 2 hexagon head approx. screws size M6 on an even metallic surface.
- Hang the osa rack onto the screws and tighten the screws. A conductive connection to the mounting surface must be established via the screws.

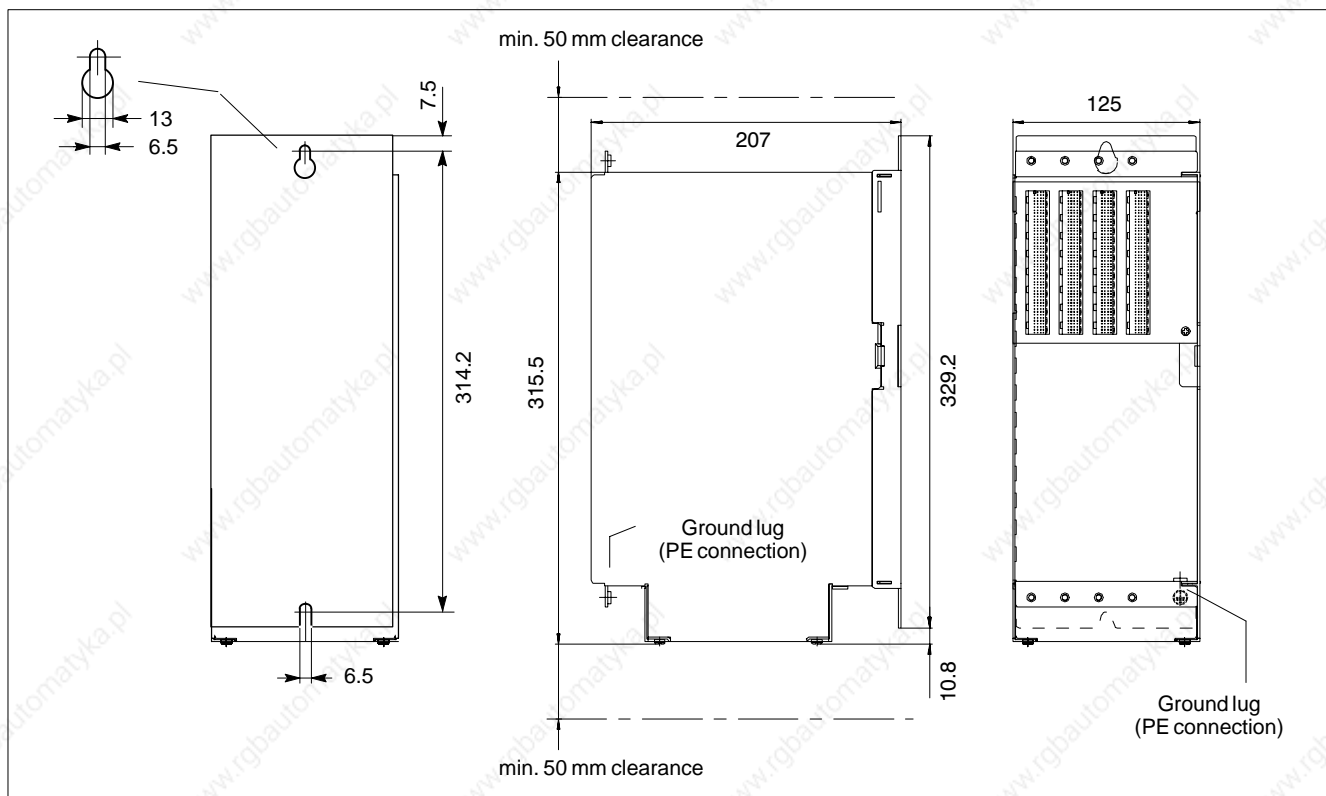

5.4 PC Control Panels "osa display pc" and "typ3 compact pc"

Weight:	osa display pc: approx. 4 kg typ3 compact pc: approx. 8 kg (including Typ3 osa-compact) osa keyboard: approx. 1 kg
Orientation:	osa display: 0° to max. 45° slanted position. osa keyboard: 0° to max. 90° slanted position, centered below the osa display. Max. distance from osa display: 100 mm.
Installation type:	in console or swivel frame, sealed in accordance with IP54

 **Please consider that the front of the control panel may get contaminated more quickly if installed in slanted or horizontal orientation.**

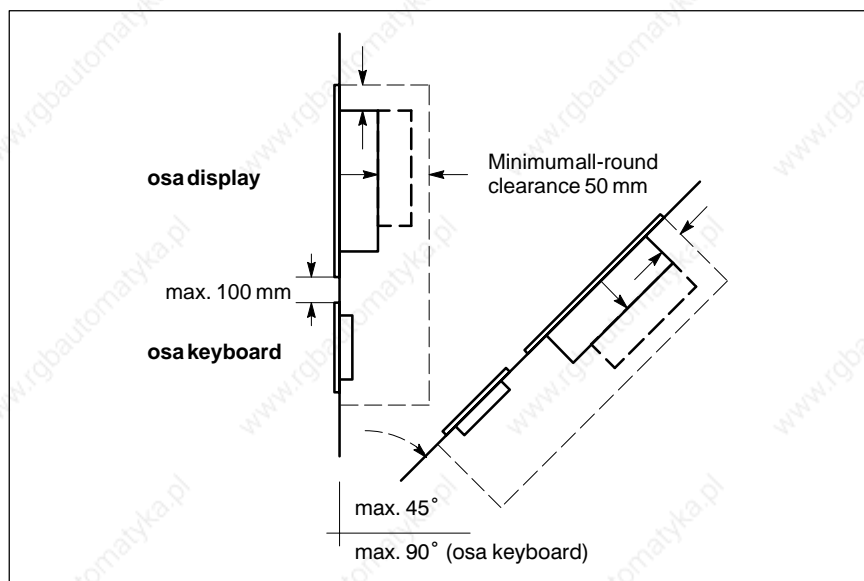

- Install the PC Control Panel in a way that facilitates the most ergonomic operator access and operation. Also, the operator must always have a clear line of sight toward all moving machine components!
- Avoid installation locations exposed to direct sunlight (reduction of display readability, additional thermal load).
- In order to ensure adequate ventilation and cable access, provide a minimum all-round clearance of 50 mm.
- Route all connecting cables in loops, and provide strain reliefs for all cables.
- Maintain as much distance as possible from sources of interference.
- Use only silicone-free sealing compounds, adhesives or insulating media.

PC Control Panel osa display pc

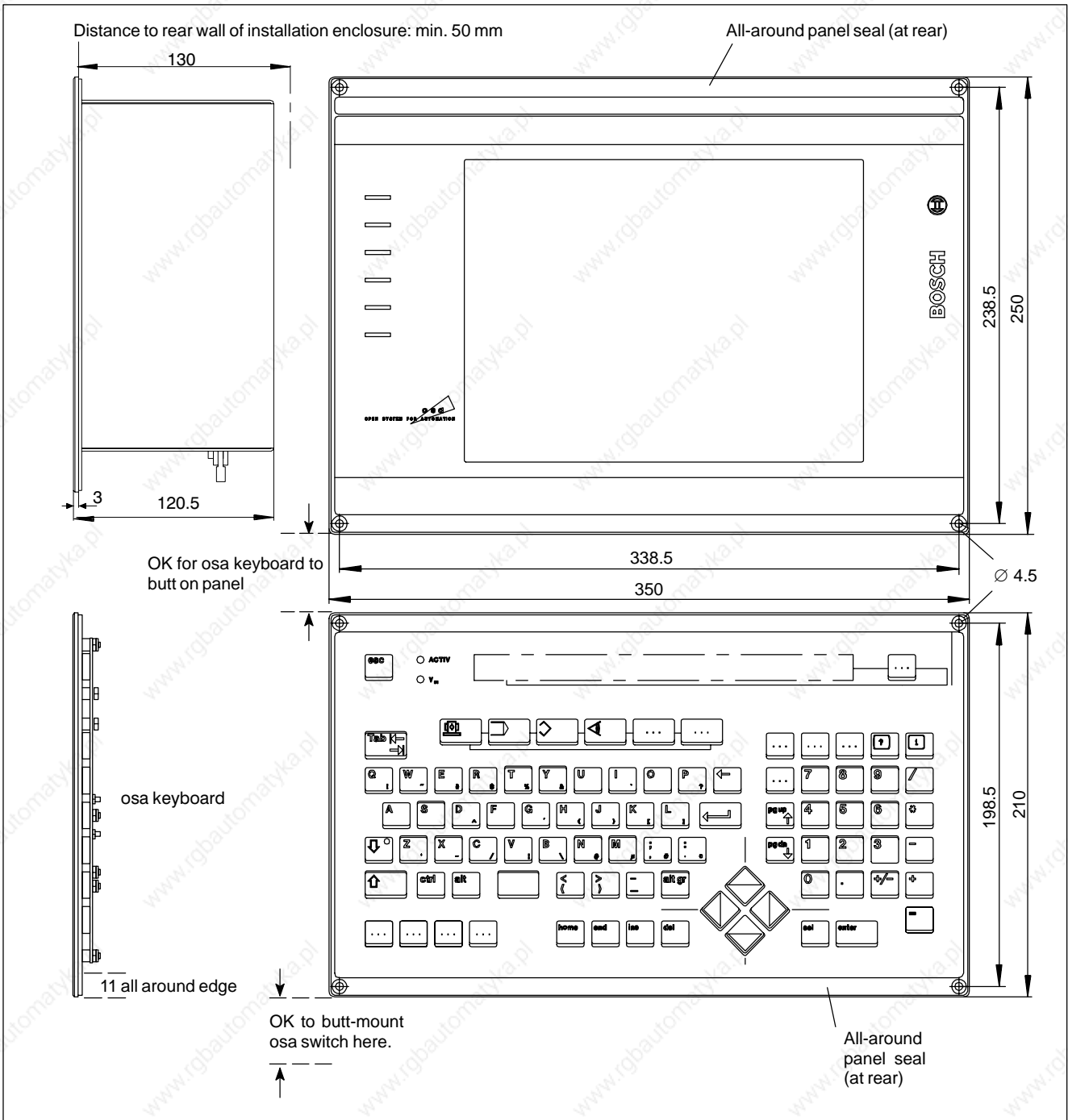

PC Control Panel typ3 compact pc including Typ3 osa-compact

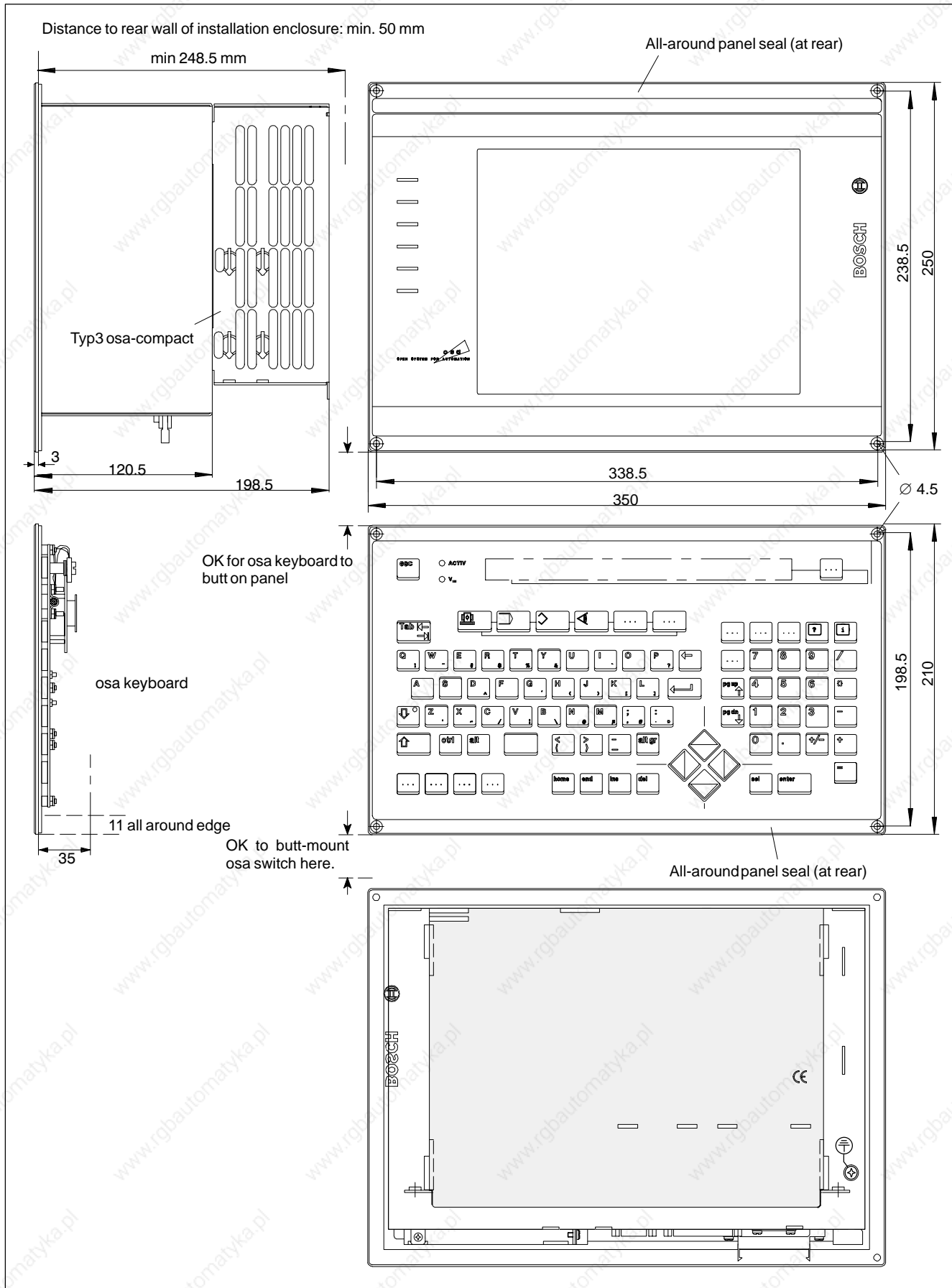

Installation cut-outs

PC Control Panel osa display pc

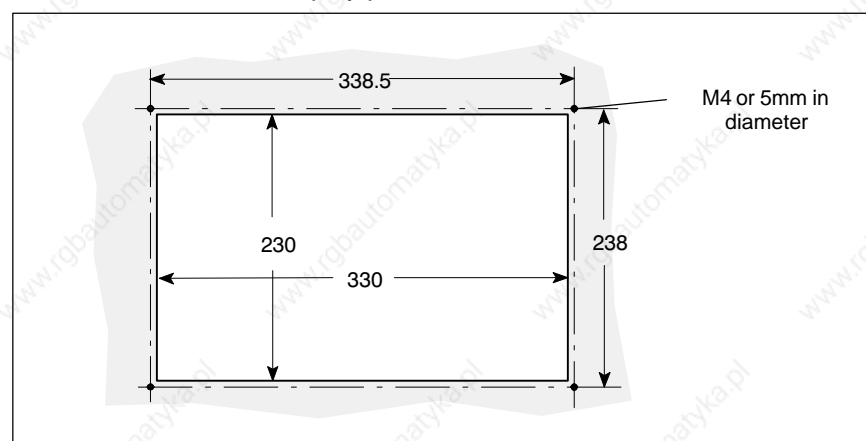

PC Control Panel typ3 compact pc incl. Typ3 osa-compact

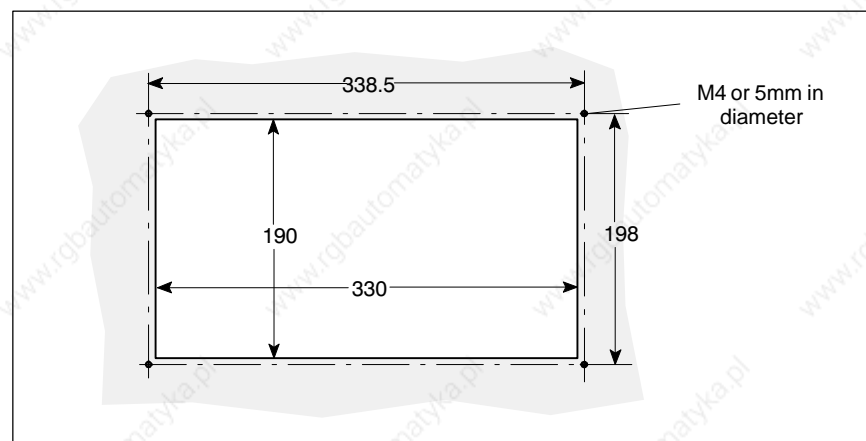

5.5 osa switch (machine control panel)

Weight:	approx. 1,7 kg
Orientation:	0° to max. 90° slanted position. centered under osa keyboard. Max. distance from osa display: 300 mm.
Installation type:	in console or swivel frame, sealed in accordance with IP54

 **Please consider that the front of the control panel may get contaminated more quickly if installed in slanted or horizontal orientation.**

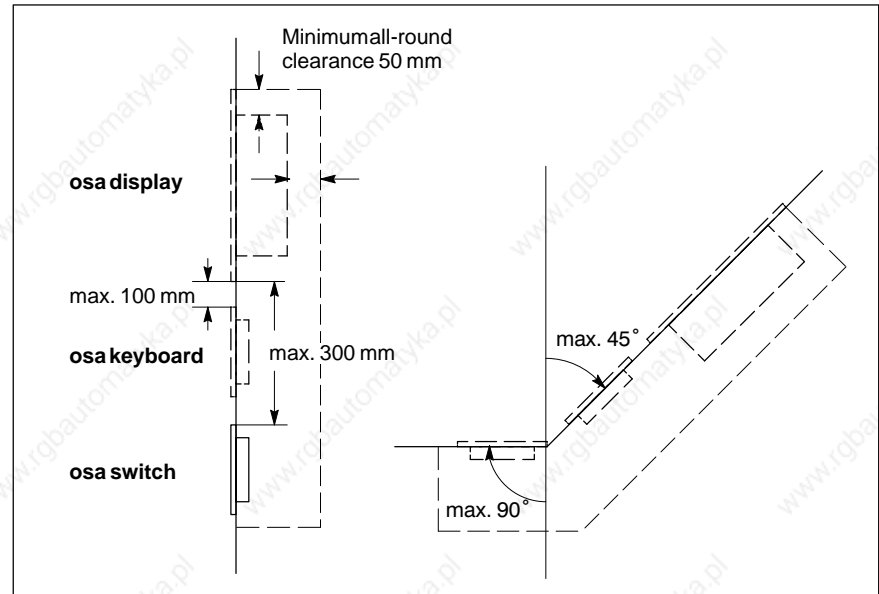

- Install the osa switch in a way that facilitates the most ergonomic operator access and operation. Also, the operator must have a clear line of sight toward all moving machine components!
- Avoid installation locations exposed to direct sunlight (illuminated keys are harder to differentiate, additional thermal load).
- In order to ensure adequate ventilation and cable access, provide a minimum all-round clearance of 50 mm.
- Route all connecting cables in loops, and provide strain reliefs for all cables.
- Maintain as much distance as possible from sources of interference.
- Use only silicone-free sealing compounds, adhesives or insulating media.

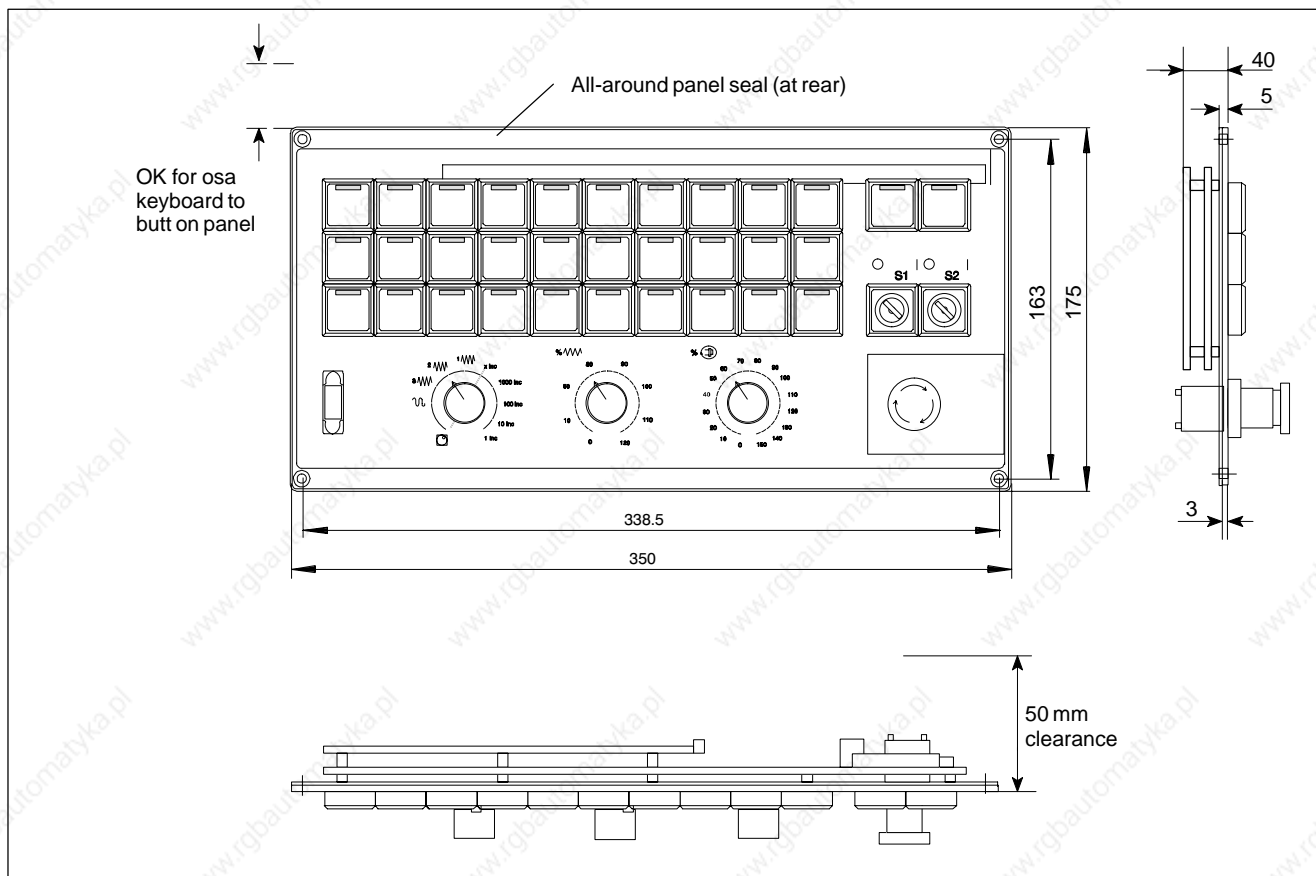

Installation cut-out

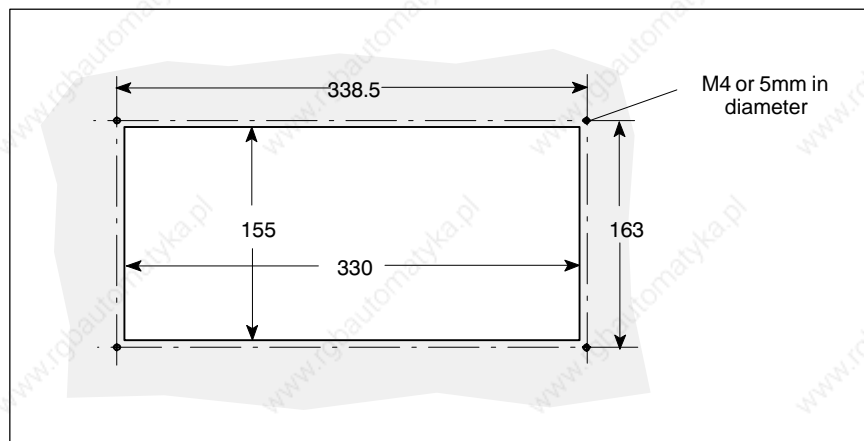

6 Electrical Connection

The present chapter describes only the principles guiding the electrical connection of the Typ3 osa Numerical Control. It contains information that is of concern mainly to the system planner/designer.

It is the responsibility of the system planner to provide for, and incorporate, required components, such as EMERGENCY-OFF control circuits, mains switches, etc., in accordance with accepted industry practice, while ensuring the highest degree of safety.

 **Therefore, with regard to electrical connections, the connection diagrams and installation instructions supplied by the machine manufacturer shall always be binding!**



CAUTION

**Damages to system components may result from making or removing plug-in connections during system operation!
You should always shut off the system before you connect the components.**

6.1 Notes on Protective Earth (PE) Connectors and Screening



DANGER

Hazardous conditions, functional failures and physical system damage through insufficient potential equalization or poor screening between individual components!

Equipotential bonding currents must not flow through the screening of interface cables.

- ★ Ground wiring must be structured in a meshed arrangement. All components, switch cabinet housings/doors and the mounting plate must be grounded.
- ★ Equipotential bonding lines/PE lines of all plant sections should be as short and as low-resistance as possible.
- ★ Install PE rails, preferably with full conductance, on the mounting plate in the switching cabinet. In the case of isolated PE rails, both ends of the rail must be connected to the mounting plate by means of sufficiently dimensioned copper grounding straps not exceeding 20 cm in length. Position PE rails in such a way that the length of PE conductors connecting individual modules in the switching cabinet does not exceed 1 meter.
- ★ Ensure that a sufficient conductor area (cross-section) is always used throughout the PE system. Refer also to EN 60204 Part 1 (max. electrical resistance and testing of PE wiring installations).
- ★ If at all possible, connect the screening at both ends.
- ★ Ensure that potential equalization currents do not flow through the screening conductors of interface cables. Therefore, always provide proper equipotential bonding between the devices to be connected already prior to the first system start-up. In doing so, also take into account such types of interfaces that are used to connect devices in different locations – regardless of distance or mains power supply.



DANGER

Danger of electric shock through insufficient PE conductor connection!

PE conductor connections must not be negatively affected by mechanical, chemical, or electro-chemical influences. The connection must be lasting.

6.2 Interference Suppression Information

When planning the system, and to improve operational system safety, you are advised to take into account all interference suppression regulation guidelines and statutes governing the interference clearing of individual components.



DANGER

Hazardous conditions, functional failures and physical system damage through EMC or conducted interference!

Inadequate line routing, insufficient cable shielding or inappropriate PE system designs may introduce interference into electronic equipment.

Therefore, signal voltage lines should be laid at appropriate distances from power cables (e.g. motor cables). If this is not possible, separate metal cable ducts must be used.

The following sections endeavour to provide you with a brief overview of optional interference suppression measures in the switching cabinet. They include, for example:

- Filters
- Spark quenching circuits
- Attenuation of inductive switching surges
- Limiting the switching impulse voltage of fast semiconductors
- Screening

To provide effective interference suppression, *all* of the above components must be considered because only in combination will they produce optimum efficiency. The principle applying to interference suppression is summarized as follows:

- Interference suppression as close as possible to the interferer
- Use of components restricted to those identified as having interference-suppressing properties
- Limiting leakage currents in accordance with safety regulations
- Providing protective insulation
- Ensuring sufficient mechanical support to prevent vibration breakage.

When using pin-point precision in the application of interference suppression measures, the question of symmetry or asymmetry is an essential one. Besides symmetrical interference voltage components occurring between mains connecting lines, asymmetrical interference voltages are produced as well. They are caused, for example, by capacitive coupling between the source of interference and the mains network.

A commonly used interference suppression circuit is shown in the diagram below. The asymmetrical interference voltages are dispersed across C_y towards the housing. C_x effects an attenuation of the symmetrical interference voltages.

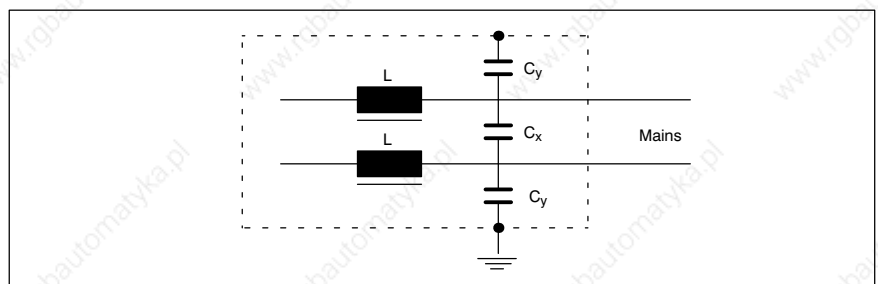

Interference Suppression Examples:

Suppression example – **Contacts:**

(Alternating current, Direct current, offset DC current)

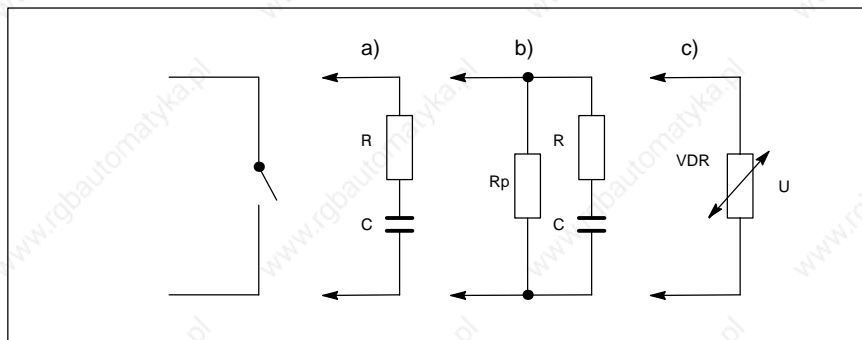

to b) for sensitive contact points; residual current on open contact!

to c) voltage-dependent resistance, residual current on open contact!

Suppression example – **Inductive load:**

(Motors, solenoid, relay and contactor coils)

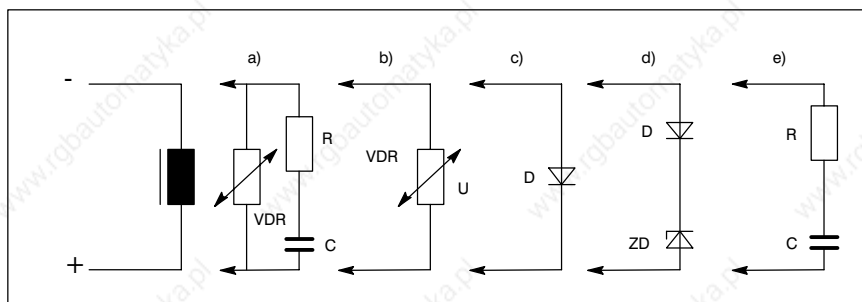

to c) with relay, cut-off delay

to d) with relay, defined cut-off delay

to e) must be optimized for inductance!

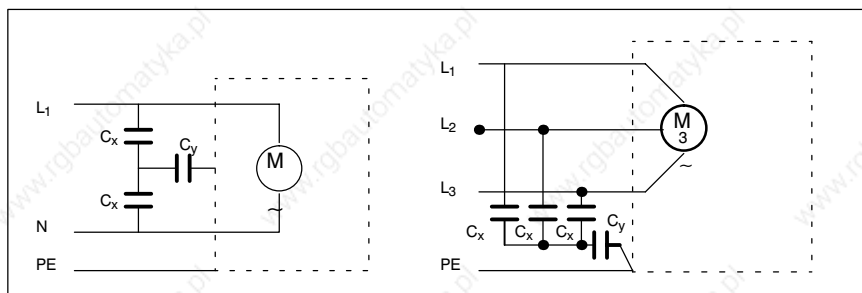
Suppression example – **Mains input:**

6.3 Power Supply

In normal circumstances the entire system draws its power from the 3-phase rotary current mains network. All internal voltages required by the system are derived from this power supply.



DANGER

Hazardous system conditions and functional failures of electrical modules through wrong power supply voltages!

- All required supply voltages must be within specified voltage ranges.
- Fluctuations or deviations from nominal values must neither exceed nor fall short of specified tolerances.
- The required electrical fuse protection must be provided on the mains side!

6.3.1 24 VDC Power Supply

Rated voltage U_N :	24VDC ; +20%, -15%
Residual ripple at U_N :	see diagram below
Interference resistance and surge immunity:	$U_{max} = 35V$ (for $t < 100ms$)
Consumption at U_N :	max. 3.5A (Typ3 osa-compact) max. 3.5A (Typ3 osa-modular)
Input fuse, Typ3 osa:	M4A (5x20) medium slow-blow
Polarization:	through decoupling diode; reversal of polarity triggers input fuse.



DANGEROUS ELECTRICAL VOLTAGE

The 24 VDC input voltage must satisfy the requirements of "Safety separation"!

Safety transformer pursuant to EN 60742

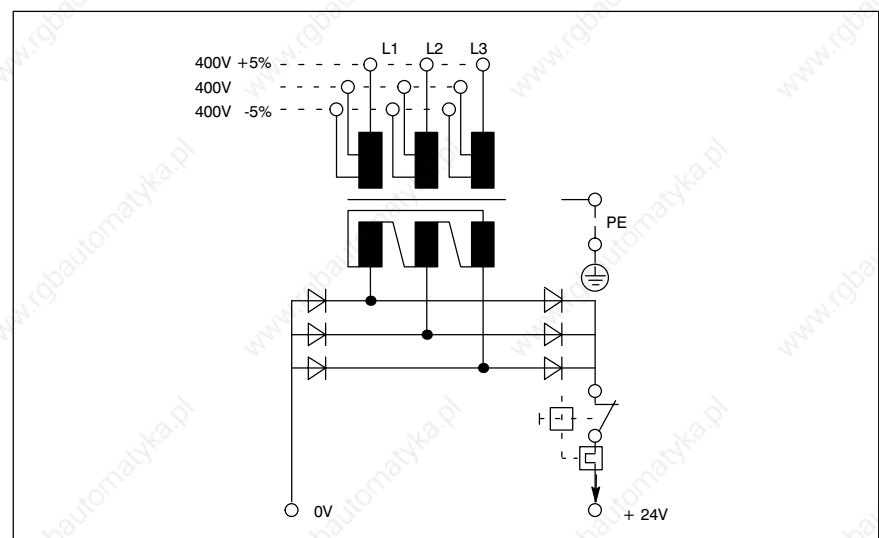

Offset AC voltage components of the type produced by an unregulated rotary current bridge circuit without smoothing, at a ripple factor of 5%, are permissible (refer to DIN 40110/10.75, Sect. 1.2).

This produces, as the upper voltage limit, the highest absolute value of 30.2 V, and the smallest absolute value of 18.5 V as the lower voltage limit.

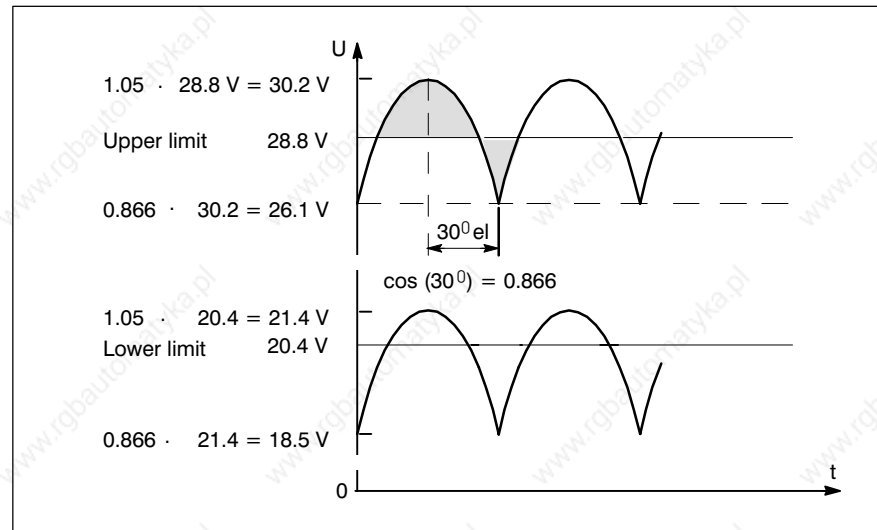

6.3.2 230/115 VAC supply

The 230/115 VAC supply is used for the "osa display pc" and "typ3 compact pc" PC Control Panels.

Rated voltage:	85VAC ... 264VAC; long-range input
Current consumption	0.7 A
at $U_{\text{nom}}=230\text{VAC}$:	0.2 A (only for 80135 and 80984)
Current consumption	1.4 A
at $U_{\text{nom}}=115\text{VAC}$:	0.4 A (only for 80135 and 80984)
Making current at 230VAC:	30A cold start 25°C
at 115VAC:	15A cold start 25°C
Input fuse:	4A (5x20)

6.4 Power Connections

The following block diagrams describe only the essential principles of making the various power connections. The information thus provided expressly addresses the system planner/designer.

It is the responsibility of the system planner to provide for, and incorporate, required components, such as EMERGENCY-OFF control circuits, mains switches, etc., in accordance with accepted industry practice, while ensuring the highest degree of safety.

☞ **Therefore, with regard to electrical connections, the connection diagrams and installation instructions supplied by the machine manufacturer shall always be binding!**



DANGEROUS ELECTRICAL VOLTAGE

Possible Danger to life and severe equipment damage through faulty or improperly configured EMERGENCY-OFF circuit!

Also, integrate the EMERGENCY-OFF pushbutton on the osa switch into the EMERGENCY-OFF circuit!



DANGER

Uncontrolled traversing movements as a result of improper system shut-down procedure!

Therefore, configure the system control circuits in a way that ensures that a shut-down procedure automatically includes powering down the drives prior to disconnection the power supply voltages.

Please note the following in order to avoid functional system faults:

- Ensure that the installation of the terminal strips for 24 VDC and 0 V potentials in the switching cabinet provides for *isolation*. Maintain a minimum distance of 10 cm from power lines when routing signal cables.
- Configure the system control circuits in a way that ensures that control panels, CNC and PLC are always powered up simultaneously.

Fig. 1: Mains Connection

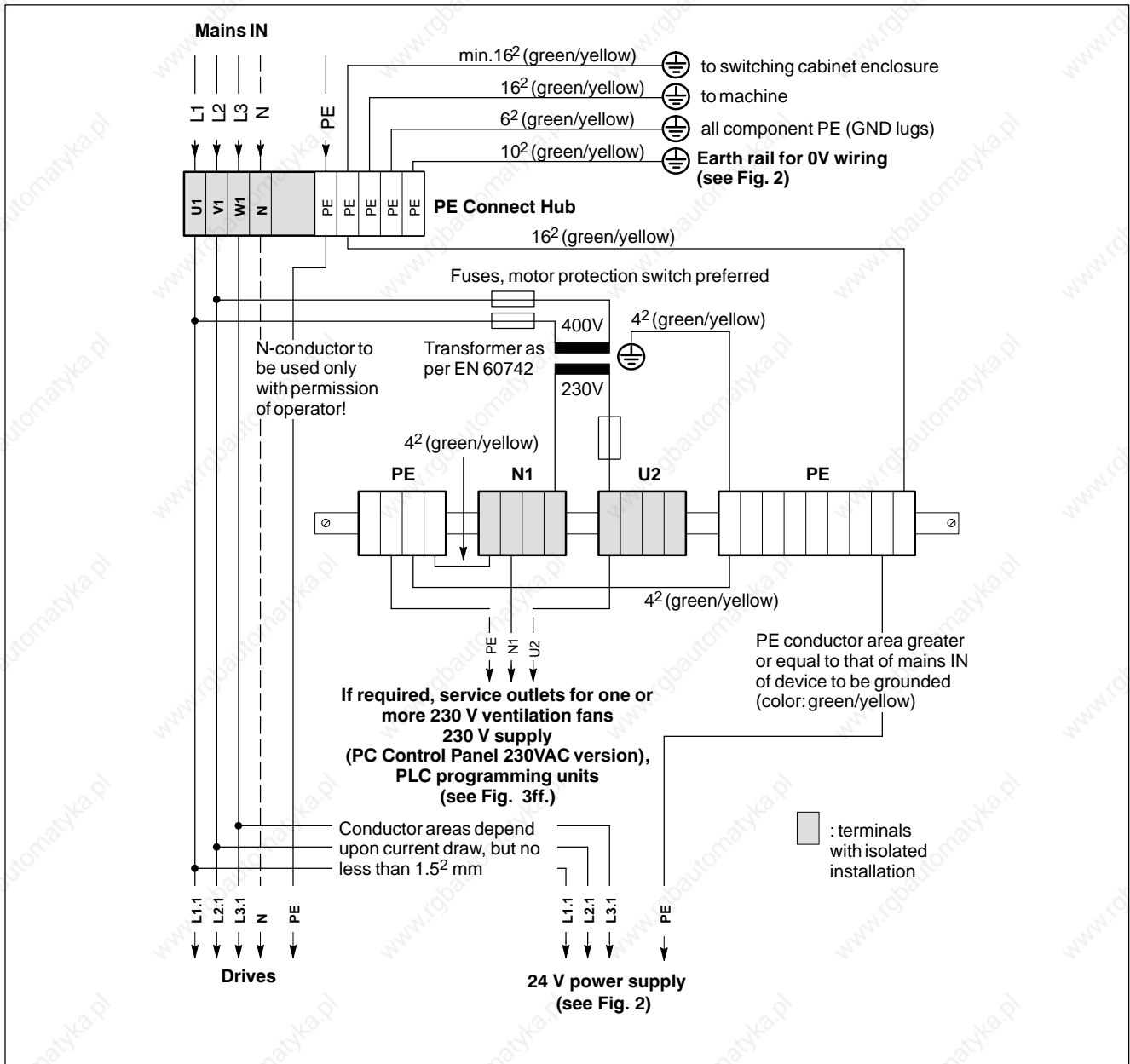

Fig. 2: Generation of 24 VDC Power

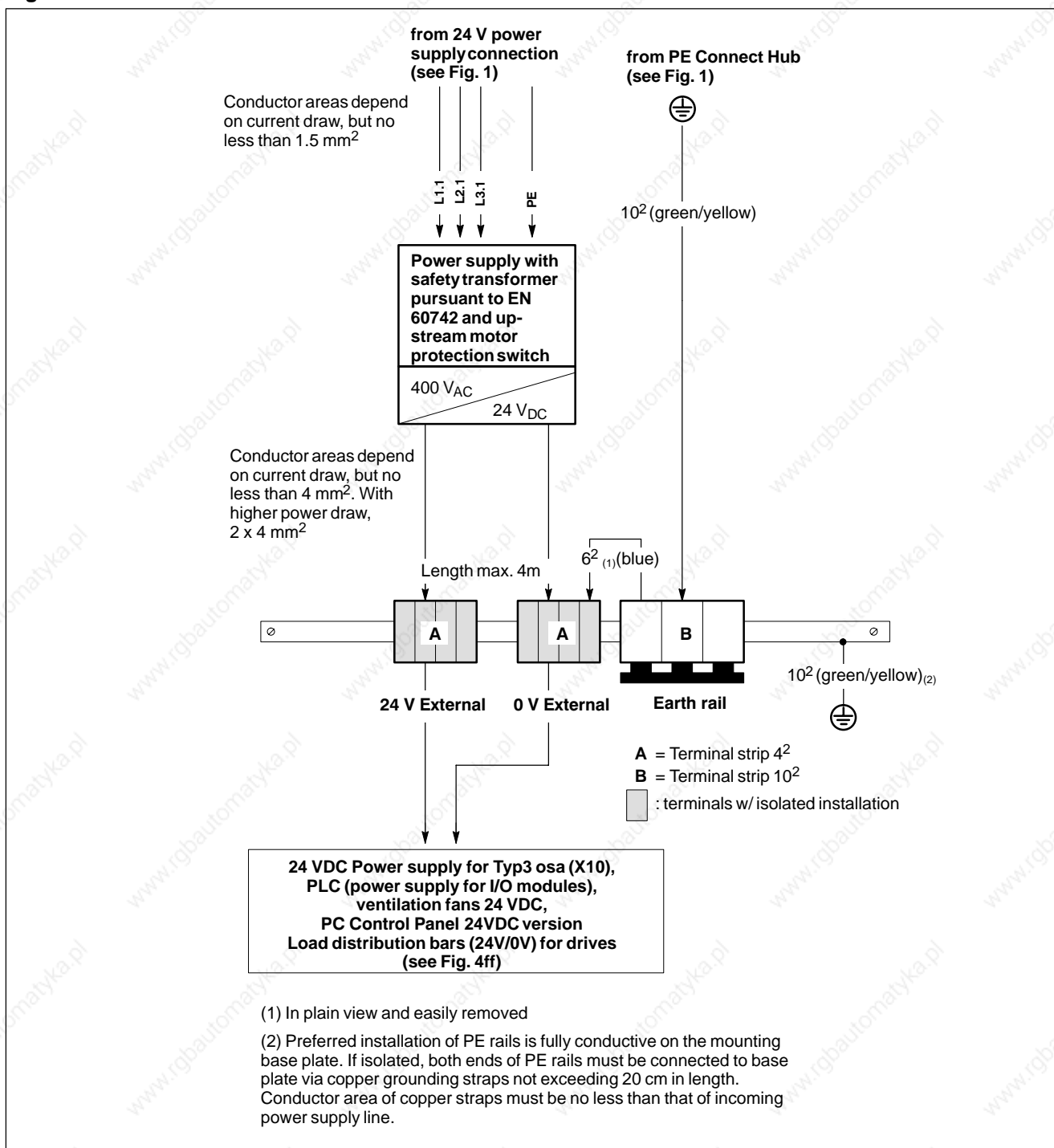

Fig. 3a: Using Typ3 osa with PC Control Panel (230 VAC supply)

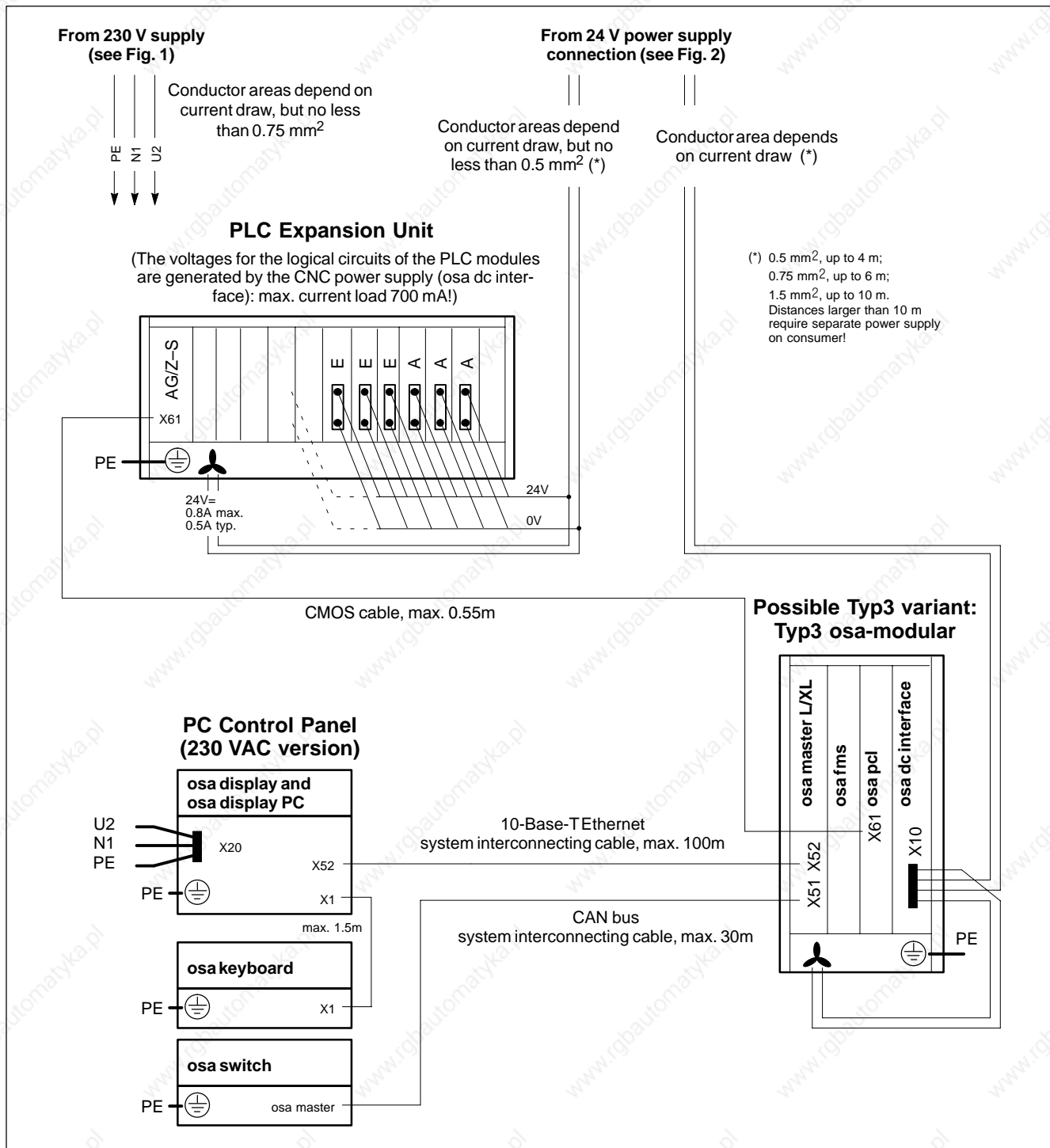

Fig. 3b: Using Typ3 osa with PC Control Panel (24 VDC supply)

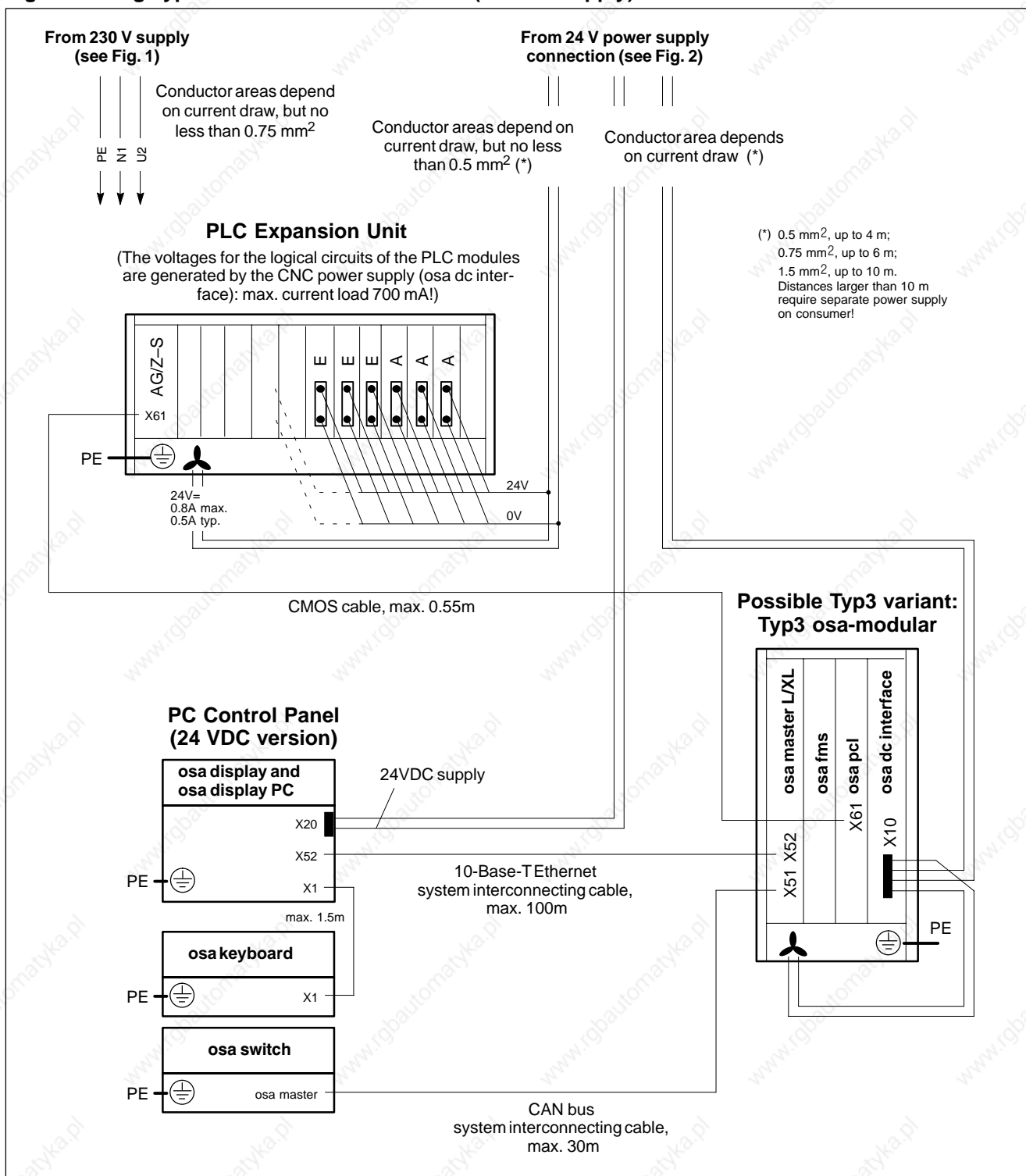

Fig. 3c: Using Typ3 osa-compact with PC Control Panel (230 VAC supply)

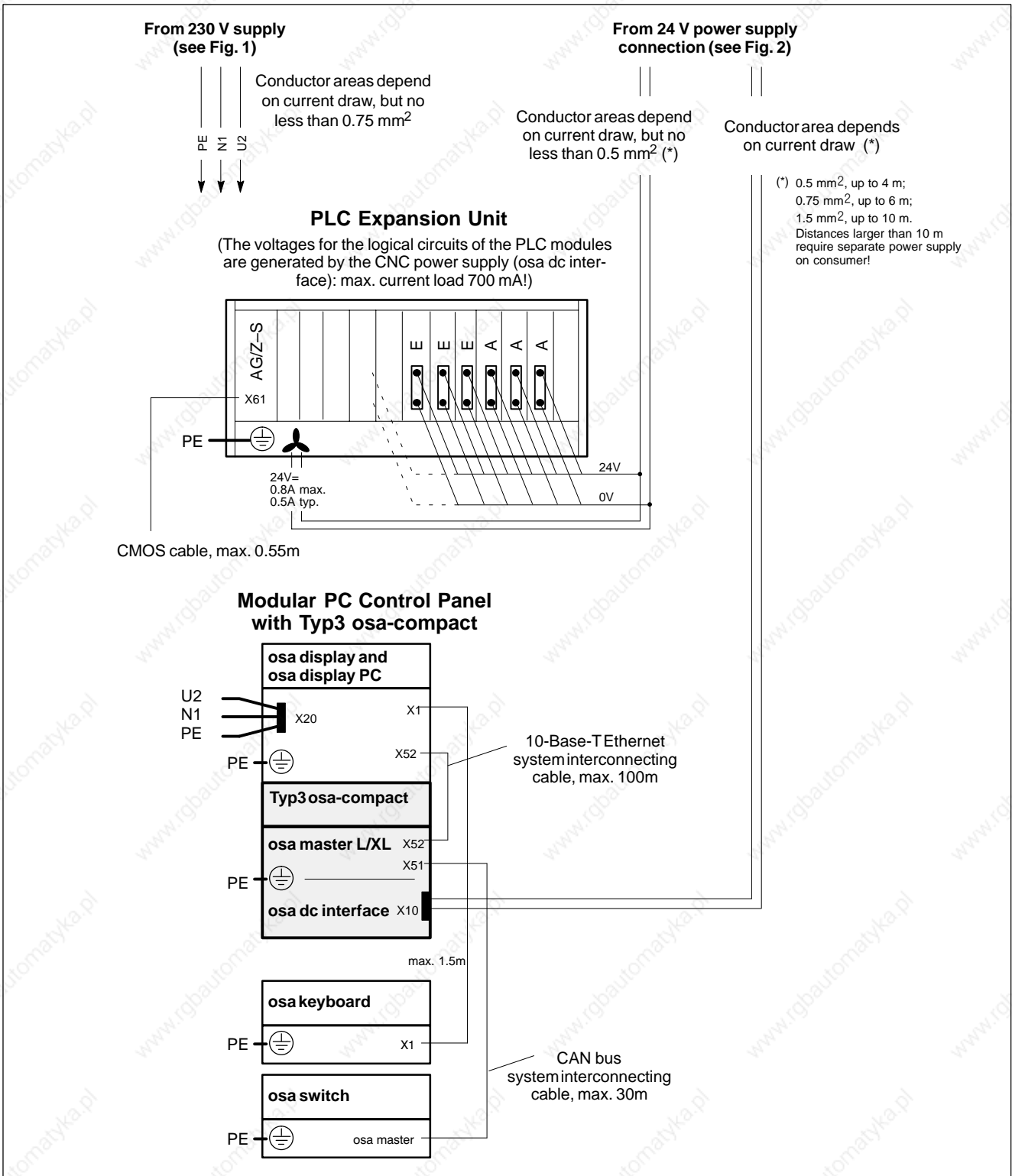
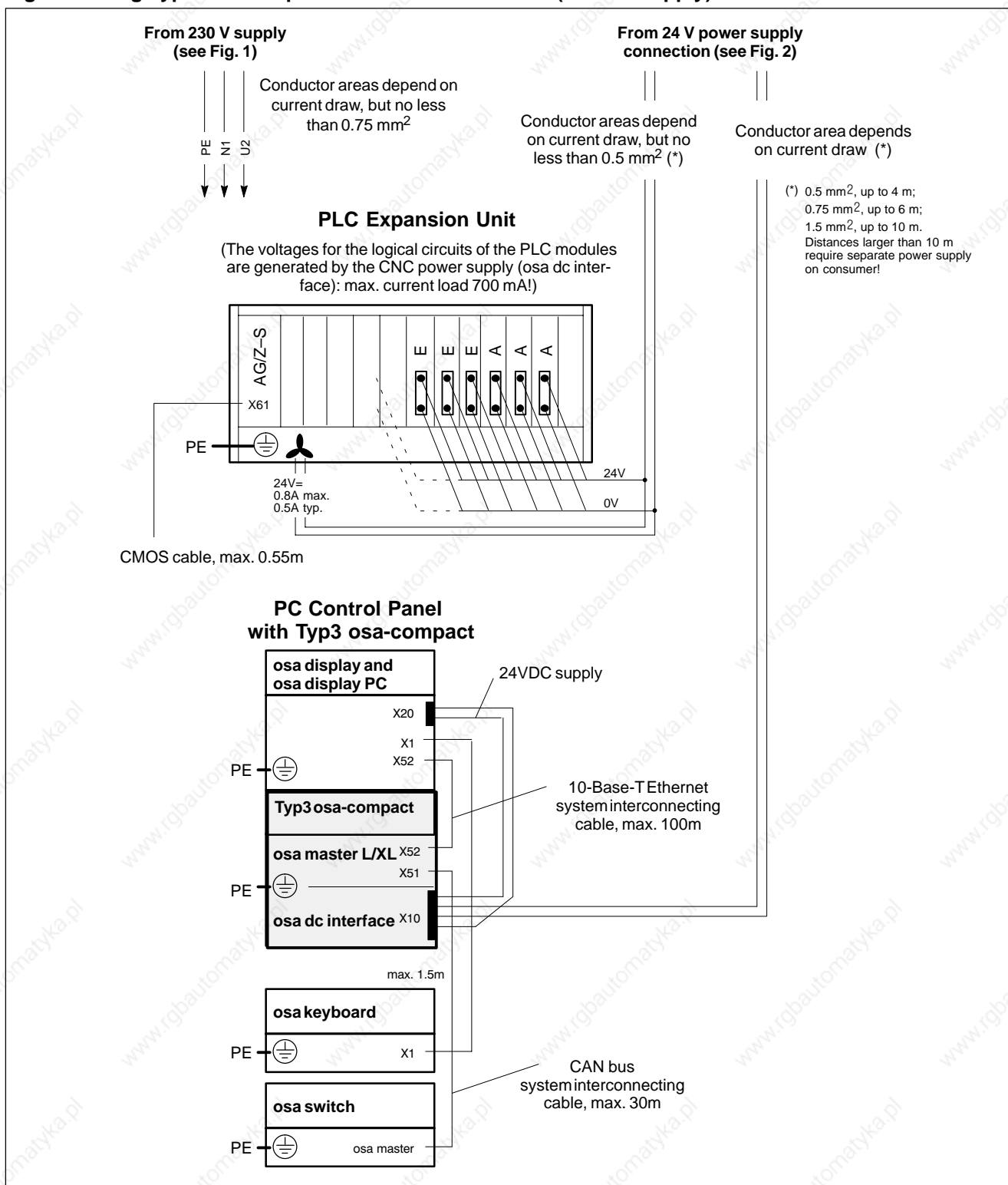

Fig. 3d: Using Typ3 osa-compact with PC Control Panel (24 VDC supply)



Your notes:

7 3.5" Floppy Disk Drive

A 3.5" floppy disk drive for 1.44 MB or 720 kB floppy disks is available for saving data.

It is supplied as an assembly with a mounting frame open at the back side and connection cables for control panel installation.

Its front side is protected against dust and liquids by a hinged cover (IP54).

7.1 Control elements

To insert the 3.5" floppy disk, first open the **protective cover** and then insert the disk with the sliding element first into the **drive slot** until the disk is engaged in the drive (clicking sound). When the **control LED** flickers, the PC accesses the floppy disk.

To remove the floppy disk press the **eject key**.

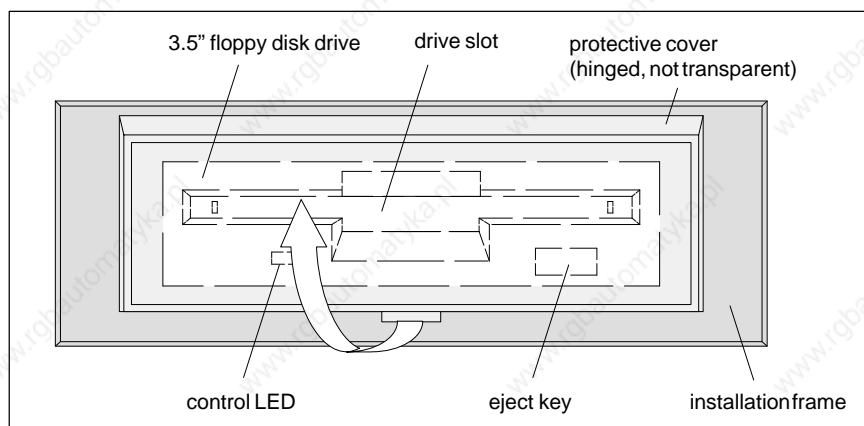

7.2 Connectors

The rear side of the floppy disk drive accommodates the connectors for data transmission (K1) and power supply (K2):

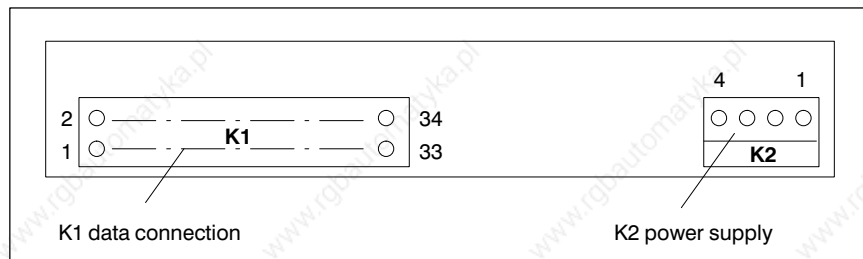

Data transmission

Data transmission between the drive and the PC Control Panel is facilitated by the 34-wire ribbon cable included in the delivery of the 3.5" floppy disk drive.

If a 34-pole standard ribbon cable is used, cores 10...16 must be reversed (cf. section 4.3.4).

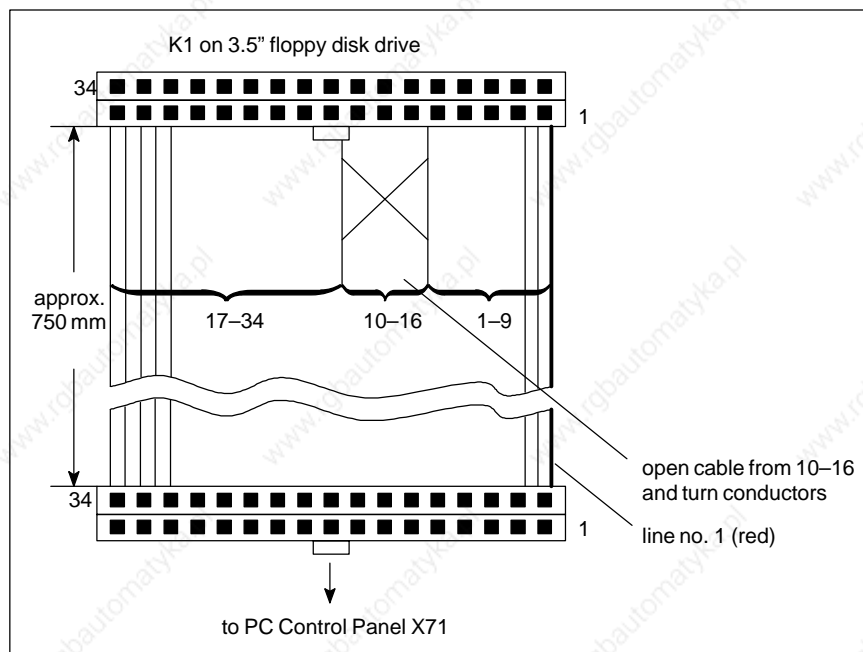

Power supply

Power supply to the 3.5" floppy disk drive is achieved by connecting the supplied cable to connector K2.

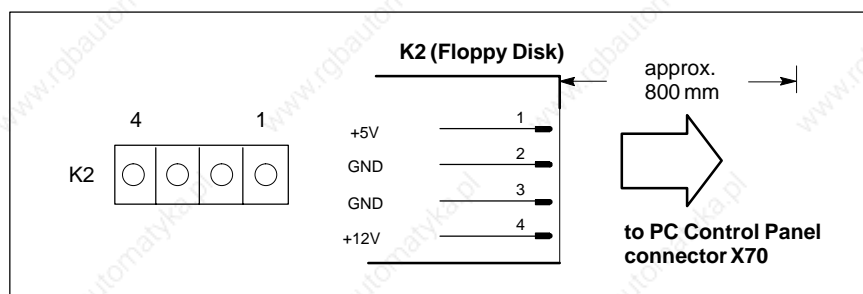

7.3 Installation

For more instructions on the 3.5" floppy disk drive, please refer to the sections "standards applied" and "conditions of use".

Weight:	approx. 0.7–1 kg
Orientation:	horizontally, vertically
Place of installation:	with protective cover IP54, otherwise IP00 designed for installation at least to IP54
Display:	indicator LED for floppy disk access
Control elements:	eject key for floppy disk, dust hood with interlock
Installation elements:	Installation frame and mounting frame for front-sided and rear-sided fastening of the floppy disk drive.
Power supply:	+5VDC; +10%, –10%
Power consumption:	0.9A _{max.}
Power input:	1.5W; (30mW in stand-by mode)



CAUTION

Take all precautions necessary for ESD protection when handling modules and components! Avoid electrostatic discharge!

Permitted orientations of the 3.5" floppy disk drive:

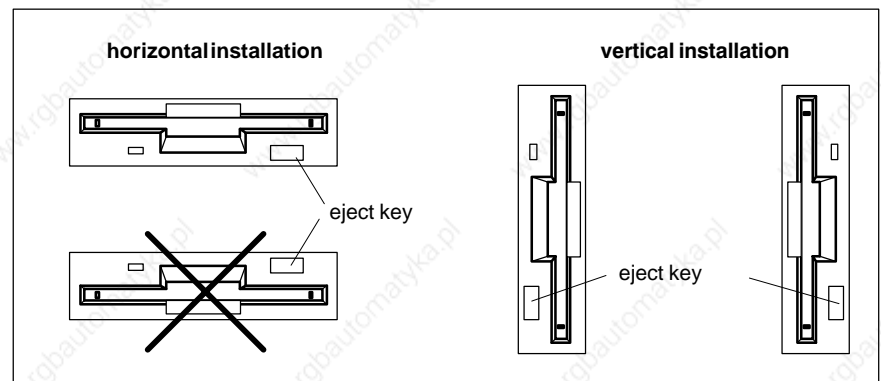

CAUTION

When installed horizontally, the eject key of the 3.5" floppy disk drive must not point upward.

7.4 Installation cut-out

The supplied installation frame is fixed and aligned in the installation area shown below. Afterwards, insert the floppy disk drive into the rear mounting frame and fasten it to the installation frame.

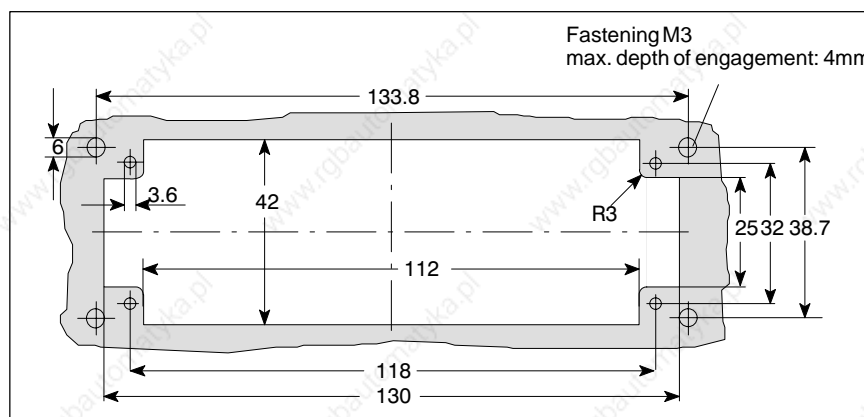

7.5 Dimensions

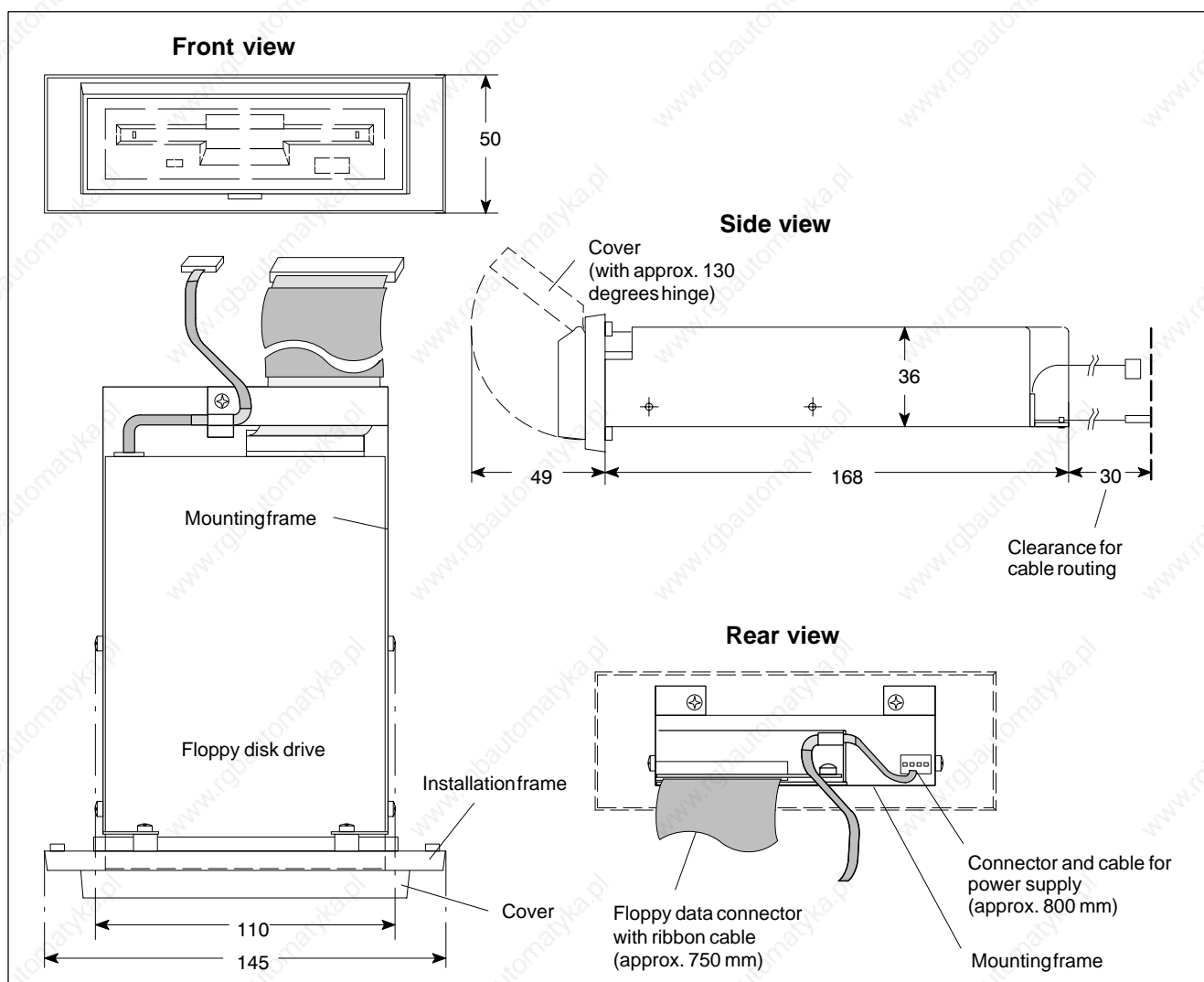

7.6 Software installation

When you have installed and connected the 3.5" floppy disk drive, you should boot the PC. While booting, press the key on the keyboard.

When the AMIBIOS setup screen is displayed (may also be a setup routine of a different manufacturer), select "Standard setup". Select Floppy A from the "Standard setup" menu. In the "Floppy A" menu select the type of floppy disk drive connected (e.g. 1.44 MB 3.5" for floppy disk or osa disc). Then press the ESC key several times until you reach the "Exit Setup" menu.

To accept the settings, select "Save changes and exit". If you do not want to accept the settings, select the "Do not save changes and Exit" option from the "Exit Setup" menu. You thereby quit the AMIBIOS setup, and the PC is automatically booted.



CAUTION

Avoid incorrect booting. Do not change any other entries in the AMIBIOS setup!

Note the relevant instructions contained in this manual, the documentation for the integrated PC and the documentation of your floppy disk supplier.

Backup your hard disk data before you start! Note down the original settings before making any changes. Thus, you can always restore the original condition. Record all changes to the PC settings. Incorrect BOOT processes caused by your changes may thus be reverted, if necessary. Incorrect BOOT process may possibly have the effect that your system is not started up properly, or even not started up at all!

Your notes:

8 Maintenance and Spare Parts List

8.1 Maintenance

**DANGER**

Dangerous System Conditions or Possible Component Damage!
Please observe the "Maintenance and Repairs" section in the chapter on "Safety Instructions."

Add the following tasks to your maintenance schedule:

- **Clean the screen surface** at least **once a week** with an antistatic cloth or with an alcohol-based window cleaner.

**CAUTION**

Solvents may dissolve the film surface and display sealing of the osa display!

Do not use any solvents (e.g. thinner)!

- Replace the **backlights** in the display units at least **every 2 years**. Based on the functional principle of these units, a gradual loss of brightness will be noted over time, causing a deterioration of screen readability.
- Check all **plug-in and terminal connections at least once a year** for proper tightness and possible damage. Inspect cables for cracks, pinching damage or other signs of mechanical distress! Have damaged parts replaced immediately!
- Check **fans and fan filter mats** at least **once a year**. Contaminated filter mats block the air volume throughput required for device ventilation and cooling. Therefore, wash contaminated filter mats in soapy suds, or replace them with new ones. Subsequent to washing filter mats, ensure that they are fully dried before reinserting them into the filter frame!

**DANGER**

Risk of injury by rotating air impeller!

Keep hands out of the air impeller, and do not insinuate any other items.

- Replace the Lithium battery in the osa dc I/O module **immediately upon the appearance of the fault message in the display**. For replacement, use a new battery of the same type (type Li-SL-760/S, 3.6 V, 1.8 Ah, AA size; order no.: 1070 914 446).

8.2 Spare Parts List

8.2.1 osa rack for Typ3 osa-modular

osa rack 2 NC cardrack 3-C2 (including fan) 2 slots for – osa master and – osa dc interface	1070 079 596
osa rack 4 NC cardrack 3-C4 (including fan) 4 slots for – osa master, – osa dc interface – osa plc, – osa profibus fms	1070 078 280
osa cover (for covering a slot in osa rack 2/4)	1070 075 608

8.2.2 osa rack for Typ3 osa-compact

Included in PC Control Panel typ3 compact pc.

8.2.3 Plug-in modules for osa rack

osa master L (module SNCI_2/12/8)	1070 080 399
osa master XL (module SNCI_2/X)	1070 080 397
osa dc interface (module DCIO_1/MK)	1070 077 995
osa dc interface ana (module DCIO_1)	1070 077 994
osa plc (module ICL700_1/C/!/.5)	1070 681 97
osa profibus fms (module ISA_2_Profi) on request	1070 080 312

8.2.4 PC Control Panels (with integrated PC)

osa display pc 486A DSTN, 230V 1070 080 135
(PCPNL 486A32TF1ISA2A2)

Display unit with integrated industry-standard PC:
 Equipment front IP65, DSTN Color LCD,
 AMD/DX5 133 MHz CPU, 32MB DRAM, >1.6 MB hard disk 2,5",
 1x RS232, 1x RS485/RS232, LPT1, Ethernet 10BaseT,
 2 free ISA slots,
 230V mains connection

osa display pc PENA DSTN, 230V 1070 079 816
(PCPNL PENA32DS1ISA2A)

Display unit with integrated industry-standard PC:
 Equipment front IP65, DSTN Color LCD,
 Pentium 133 MHz CPU, 32MB DRAM, >1.6 GB hard disk 2,5",
 1x RS232, 1x RS485/RS232, LPT1, Ethernet 10BaseT,
 2 free ISA slots,
 230V mains connection

osa display pc PENA DSTN, 24V 1070 079 815
(PCPNL PENA32DS1ISA2D)

Display unit with integrated industry-standard PC:
 Equipment front IP65, DSTN Color LCD,
 Pentium 133 MHz CPU, 32MB DRAM, >1.6 GB hard disk 2,5",
 1x RS232, 1x RS485/RS232, LPT1, Ethernet 10BaseT,
 2 free ISA slots,
 24V mains connection

osa display pc 486A TFT color, 230V 1070 080 984
(PCPNL 486A32TF1ISA2A)

Display unit with integrated industry-standard PC:
 Equipment front IP65, TFT Color LCD,
 AMD/DX5 133 MHz CPU, 32MB DRAM, >1.6 MB hard disk 2,5",
 1x RS232, 1x RS485/RS232, LPT1, Ethernet 10BaseT,
 2 free ISA slots,
 230V mains connection

osa display pc PENA TFT color, 230V 1070 079 814
(PCPNL PENA32TF1ISA2A)

Display unit with integrated industry-standard PC:
 Equipment front IP65, DSTN Color LCD,
 Pentium 133 MHz CPU, 32MB DRAM, >1.6 GB hard disk 2,5",
 1x RS232, 1x RS485/RS232, LPT1, Ethernet 10BaseT,
 2 free ISA slots,
 230V mains connection

osa display pc PENA TFT color, 24V 1070 079 813
(PCPNL PENA32TF1ISA2D)

Display unit with integrated industry-standard PC:
 Equipment front IP65, DSTN Color LCD,
 Pentium 133 MHz CPU, 32MB DRAM, >1.6 GB hard disk 2,5",
 1x RS232, 1x RS485/RS232, LPT1, Ethernet 10BaseT,
 2 free ISA slots,
 24V mains connection

**typ3 compact pc 486A TFT color, 24V
(PCPNL PENA32TF1ISA2KS)** 1070 079 525

Display unit with integrated industry-standard PC:
Equipment front IP65, TFT Color LCD,
AMD/DX5 133 MHz CPU, 32MB DRAM, >840 MB hard disk 2.5",
1x RS232, 1x RS485/RS232, LPT1, Ethernet 10BaseT,
2 free ISA slots,
24V mains connection
and integrated osa rack 2 (no modules included in price!)

8.2.5 osa keyboard

osa keyboard 1070 917 943
ASCII keyboard with special keys, IP65
MF2 connector, only suitable for osa display PC

8.2.6 Floppy disk drive

Floppy disk drive 1.44 MB 1070 081 360
ext. 3.5" floppy disk drive with mounting frame
for installation in switch cabinet, front side IP54,
connection cable (data, power supply) to osa display PC

8.2.7 Software for modular PC Control Panel

Operating system: (pre-installed on PC Control Panel)

Windows95 (German license, OEM version OSR 2.1) 1070 079 966
with data carrier

Windows95 (English license, OEM version OSR 2.1) 1070 079 783
with data carrier

WindowsNT 4.0 (German license) with data carrier 1070 079 964
Precondition: min. 32 MB DRAM on-board of osa display PC

WindowsNT 4.0 (English license) with data carrier 1070 079 965
Precondition: min. 32 MB DRAM on-board of osa display PC

X Server: (pre-installed on PC Control Panel)

X Server for osa display PC under Windows95/NT 1070 079 784
Hummingbird eXeed V5.1 required for
operator interface on osa display PC,
installed on osa display PC,
without data carrier, with software license agreement

Operating system:**(software supplied for installation of the operating system on the PC Control Panel by the user):**

Windows95 (German license, OEM version OSR 2.1) 1070 919 148
with data carrier,
only available in connection with osa display PC

Windows95 (English license, OEM version OSR 2.1) 1070 919 000
with data carrier,
only available in connection with osa display PC

WindowsNT 4.0 (German license) with data carrier 1070 919 163
Precondition: min. 32 MB DRAM on-board of osa display PC
only available in connection with osa display PC

WindowsNT 4.0 (English license) with data carrier 1070 919 164
Precondition: min. 32 MB DRAM on-board of osa display PC,
only available in connection with osa display PC

X Server:**(software supplied for installation of the operating system on the PC Control Panel by the user):**

X Server for osa display PC under Windows95/NT 1070 918 999
Hummingbird eXeed V5.1 required for
operator interface on osa display PC,
installed on osa display PC,
without data carrier, with software license agreement,
only available in connection with osa display PC

Bosch operating system:**(pre-installed on Typ3 osa-modular or Typ3 osa-compact)**

Typ3 osa software version 3.x 1070 079 727

Typ3 osa software version 4.x 1070 080 180

Typ3 osa software export version x.x in preparation

8.2.8 Machine control panel

osa switch 1070 077 735
standard machine control panel
30 push buttons with control lamp
2 x key switches
2 x override,
connector for electronic handwheel,
connector for 8 additional push buttons,
machine keys

8.2.9 Cables

Cable / Connector	Part no.
Power cable for PC Control Panel	1070 048 937
Optical fiber cable for SERCOS interface, pre-assembled	
2 m	1070 917 885
5 m	1070 917 887
10 m	1070 918 956
CAN bus (osa master L/XL ↔ osa switch)	
SDH 2.5 m	1070 917 673
SDH 5.0 m	1070 918 954
SDH 10 m	1070 917 177
SDH 25 m	1070 918 955
Ethernet cable 10-Base-T, shielded, twisted pair, crossed (osa master L/XL ↔ PC Control Panel)	
2.5 m	1070 919 188
5.0 m	1070 919 257
10 m	1070 919 795
25 m	1070 919 797
Connection (osa plc ↔ AG/Z-S)	0.55 m
1070 070 755	
Connection (osa plc ↔ programming unit), 0.55 m	1070 054 956
Bus cable Commnet DP (traction cable)	1070 917 201
V.24 cable (PC Control Panel ↔ external PC), 5 m	1070 077 753
Internal ribbon cable for RS485, 14-pole (Motherboard ↔ COM2)	1070 078 881
Special cable for digital handwheel	1070 908 558
Adapter cable for serial interface/D-SUB male, 9-pin	1070 079 801
D-SUB male connector, 9-pin	1070 910 258
D-SUB female connector, 9-pin	1070 912 981
Metal shell for D-SUB connector, 9-pin	1070 913 723

8.2.10 Accessories

Accessories	Part no.
osa mbf interface (interface module for connecting machine keys and elec- tronic handwheel)	1070 075 062
PCMCIA card (PC card) 1 MB SRAM, for expanding the osa master L/XL part program memory	1070 918 722
Lithium battery for osa dc I/O and osa dc I/O ana, type Li-SL-760/S, 3.6 V, 1.8 Ah, AA size	1070 914 446
Digital handwheel	1070 096 167
Profibus card (plug-in card for PC)	1070 917 151
Ethernet cable 10-Base-T, shielded, twisted pair (osa master L/XL ↔ HUB, PC Control Panel ↔ HUB)	
2.5 m	1070 918 793
5.0 m	1070 919 258
HUB (Ethernet distribution for 4 x 10-Base-T, 1 x 10-Base-2)	on request
HUB interface adapter for 10-Base-T, 10-Base-2	on request

A Appendix

A.1 Abbreviations

Abbreviation	Description
C:	Drive name, in this case drive C (hard disk drive)
ESD	Electro-Static Discharge Abbreviation for all terms relating to electro-static discharge, e.g. ESD protection, ESD hazards, etc.
Fx	Function key with number x
GB	Gigabyte
GOM	Group Operating Mode
HP	Main Program ('Hauptprogramm')
LSEC	Lead Screw Error Compensation
MB	Megabyte
MCP	Machine Control Panel
MDI	Mode "Manual Data Input"
MP	Machine parameter
MSD	Machine-Status Display
MTB	Machine-Tool Builder
NC, CNC	Control Unit
OFC	Optical Fiber Cable
OI	Operator Interface
OM	Operating Mode
PC	Personal Computer
PLC	Programmable Logic Controller
SDH	Serial Digital High-Speed interface
SK	Softkey
SP	Subprogram

A.2 Index

Numbers

24V Power supply, 3-24

A

AG/ZS connection (osa plc), 3-15

Ambient temperature, 2-8

Analog I/O interface (osa dc interface), 3-20

B

Battery, 3-26

Bitbus connection (osa dc interface), 3-19

C

CAN bus (osa Master L/XL), 3-6

CAN bus (osa master L/XL), 3-16

CAN bus (osa switch), 4-22

CMOS bus (osa plc), 3-15

COM1, 4-8

COM2, 4-10

Components, Connections overview, 2-4 , 2-7

Connection, electrical, 6-1

Connection for programming device (osa plc), 3-14

Connection of digital drives, 3-4

Connection of PC Control Panel, 3-6

Connector types and cables, 4-7

D

Debugging interface (osa master L/XL), 3-5

Debugging mode, 3-8

Deleting USFREP File system, 3-8

Diagnostic Display H1 (osa master L/XL), 3-10

Digital handwheel (St3), osa switch, 4-24

Digital I/O interface (osa dc interface), 3-21

Dimensioned drawings

Floppy disk, 7-4

osa rack 2 for Typ3 osa-compact, 5-1

osa rack 2 for Typ3 osa-modular, 5-3

osa rack 4 for Typ3 osa-modular, 5-4

osa switch, 5-9

PC Control Panel

osa display pc, 5-6

typ3 compact pc, 5-7

Discrete keys (St5), osa switch, 4-25

Disk drive, Floppy disk, 7-1

Display unit, osa display, 4-3

Documentation, 1-9

E

Electrical connection

230/115 VAC supply, 6-6

24VDC supply, 6-5

EMC Directive, 1-1

EMERGENCY-STOP connection of digital handwheel, osa switch, 4-25

EMERGENCY-STOP devices, 1-6 , 4-23

EMERGENCY-STOP mushroom striker, osa switch, 4-23

ESD, Electrostatic discharge, 1-7

ESD-sensitive components, 1-7

Ethernet connection, osa display PC, 4-15

F

F1 Fuse (osa dc interface), 3-25

Fixed disk, 1-9

Floppy disk

Assignment of connecting cable, 7-2

Control elements, 7-1

Disk drive, 7-1

Installation dimensions, 7-4

Installation instructions, 7-3

Orientations, 7-3

Software installation, 7-5

Floppy disk drive, 1-9

Connection, 4-13

H

H1 H1 Diagnostic Display (osa master L/XL), 3-10

High-speed I/O (osa dc interface), 3-21

Humidity, relative, 2-8

I

Initial program loading, 3-8

Installation, 5-1

Floppy disk, 7-3

ISA expansion card, 4-17

Installation cut-out, Floppy disk, 7-4

Interfaces overview, osa display PC, 4-7

Interference suppression, 6-3

ISA slot, 4-17

Application, 4-18

Driver installation, 4-18

Expansion board selection, 4-17

Installation of expansion cards, 4-17

ISA bus, 4-17

J

Jumper settings for COM2, RS232, RS485, 4-10

K

Keyboard (osa keyboard), PC Control Panel, 4-19

L

Linking components overview, 2-4 , 2-7

Loading basic program, 3-8

Low-Voltage Directive, 1-1

LPT1, 4-12

M

Machine Control Panel osa switch, Machine Control Panel, 4-21

Maintenance, 8-1

Measuring activities, 1-6

MF2 keyboard connector, osa display PC, 4-16

Modifications, 1-10

Modules

Overview, 2-1

Typ3 osa, 3-1

Modules sensitive to electrostatic discharge. See ESD-sensitive components

O

Operational readiness of the Typ3 osa, 3-23

osa dc interface, 3-18

osa display (display unit), 4-3

osa display pc, Dimensioned drawing, 5-6

osa keyboard, PC Control Panel, 4-19

osa master L/XL, 3-1

osa plc, PLC, 3-13

osa rack 2, Dimensioned drawing, 5-1 , 5-3

osa rack 4, Dimensioned drawing, 5-4

osa switch, 4-21 , 4-22

Digital handwheel (St3), 4-24

Dimensioned drawing, 5-9

discrete keys (St5), 4-25

EMERGENCY-STOP connection of digital handwheel, 4-25

EMERGENCY-STOP mushroom striker, 4-23

P

PC card (osa master L/XL), 3-12

PC Control Panel, 4-1

230VAC In power connector, 4-5

24 VDC power connector, 4-5

COM1, 4-8

COM2, 4-10

Connection of floppy disk drive, 4-13

Connection to osa master L/XL, 3-6

Connector types and cables, 4-7

Ethernet connection, 4-15

Floppy disk DC power supply, 4-6

Interfaces overview, 4-7

ISA slot, 4-17

LPT1, 4-12

MF2 keyboard connector, 4-16

osa keyboard, 4-19

Overview, 2-2

Power connections, 4-4

Serial interfaces, 4-8

SVGA connector, 4-16

Technical data, 4-2

PE connectors, 6-2

Pin assignment for V.24 interface, 4-11

PLC, osa plc, 3-13

Port, parallel, LPT1, 4-12

Power connections, Overview, 4-4

Power connector

230 V AC, 4-5

24 V DC, 4-5

Power supply, 6-5

Power supply (osa dc interface), 3-24

Profibus DP interface (osa dc interface), 3-22

Profibus FMS, 3-17

Proper use, 1-1

Protective earthing system, 6-2

Q

Qualified personnel, 1-3

R

READY indicator, 3-25

READY2 contact (osa dc interface), 3-23

RESET In input (osa dc interface), 3-24

RESET key (osa dc interface), 3-25

RESET Out contact (osa dc interface), 3-23

RS232 interface

COM1, 4-8

COM2, 4-10

RS485 interface, COM2, 4-10

S

S1 Rotary Switch (osa master), 3-7

Safety instructions, 1-5

Safety markings, 1-4

Safety transformer, 6-5

Screening, 6-2

SDH signals (osa master L/XL), 3-6 , 3-16

SERCOS interface connectors, 3-4

Serial interfaces, osa display PC, 4-8

Software swap with PC Card, 3-9

Spare parts, 1-7

Spare parts list, 8-2

Storage temperature, 2-8

Supply voltages, 6-5

SVGA connector, 4-16

System variants, Overview, 2-1

T

Technical data, PC Control Panel, 4-2

Temperature

during operation, 2-8

when stored, 2-8

Terminal software, 4-9

Trademarks, 1-10

typ3 compact pc, Dimensioned drawing, 5-7

Typ3 osa, Modules, 3-1

Typ3 osa run-up sequence, 3-7

Typ3 osa-compact

Installation in osa rack 2, 5-1

Overview, 2-3

Typ3 osa-modular

Connections overview, 2-4 , 2-7

Installation in osa rack 2, 5-3

Installation in osa rack 4, 5-4

Overview, 2-5

V

V.24 interface, Pin assignment, 4-9
V24 interface (osa master L/XL), 3-5
Version, 1-10
Video data signals (osa master L/XL), 3-6 , 3-16
Vin Input voltage indicator, 3-25
Vout output voltage indicator, 3-25

X

X1: MF2 keyboard connector, 4-16
X10: 24 VDC External power supply (osa dc interface), 3-24
X10: 24 VDC power connector, 4-5
X11 (osa dc interface), 3-20
X11: SVGA connector, 4-16
X12 (osa dc interface), 3-21
X20: 230VAC In power connector, osa display PC, 4-5

X31 (osa plc), 3-14
X34: RS232 interface, COM1, 4-8
X35 (osa master L/XL), 3-5
X35: RS232 interface (osa display PC), COM2, 4-10
X35: RS485 interface, COM2, 4-10
X51 (osa dc interface), 3-22
X51 (osa master L/XL), 3-6 , 3-16
X52 (osa masterL/XL), 3-6
X52: Ethernet connection, 4-15
X61 (osa plc), 3-15
X61: Port, parallel, LPT1, 4-12
X70: Floppy disk DC power supply, 4-6
X71 (osa dc interface), 3-23
X71 to X74 (SERCOS connectors), 3-4
X71: Connection of floppy disk drive, 4-13
X72 (osa dc interface), 3-19
X73 (osa dc interface), 3-19

Bosch-Automationstechnik

Robert Bosch GmbH
Geschäftsbereich
Automationstechnik
Industriehydraulik
Postfach 30 02 40
D-70442 Stuttgart
Telefax (07 11) 8 11-18 57

Robert Bosch GmbH
Geschäftsbereich
Automationstechnik
Fahrzeughydraulik
Postfach 30 02 40
D-70442 Stuttgart
Telefax (07 11) 8 11-17 98

Robert Bosch GmbH
Geschäftsbereich
Automationstechnik
Pneumatik
Postfach 30 02 40
D-70442 Stuttgart
Telefax (07 11) 8 11-89 17

Robert Bosch GmbH
Geschäftsbereich
Automationstechnik
Montagetechnik
Postfach 30 02 07
D-70442 Stuttgart
Telefax (07 11) 8 11-77 77

Robert Bosch GmbH
Geschäftsbereich
Automationstechnik
Antriebs- und Steuerungstechnik
Postfach 11 62
D-64701 Erbach
Telefax (0 60 62) 78-4 28

Robert Bosch GmbH
Geschäftsbereich
Automationstechnik
Schraub- und Einpreßsysteme
Postfach 11 61
D-71534 Murrhardt
Telefax (0 71 92) 22-1 81

Robert Bosch GmbH
Geschäftsbereich
Automationstechnik
Entgrattechnik
Postfach 30 02 07
D-70442 Stuttgart
Telefax (07 11) 8 11-34 75

Robert Bosch GmbH
Geschäftsbereich
Automationstechnik
Schulung AT/VSZ
Berliner Straße 25
D-64711 Erbach
Telefax (0 60 62) 78-8 33

Technische Änderungen vorbehalten

Ihr Ansprechpartner

BOSCH



Robert Bosch GmbH
Geschäftsbereich
Automationstechnik
Antriebs- und Steuerungstechnik
Postfach 11 62
D-64701 Erbach
Telefax (0 60 62) 78-4 28