

SIMOREG DC Master 6RA70 Series Base Drive Instructions

Microprocessor-based converters from 15A to 1680A
for variable speed DC drives

Rev6.0



dc drives INSTRUCTIONS



SIEMENS

Global network of innovation

Converter software version:

As these Operating Instructions went to print, SIMOREG 6RA70 DC Master converters were being delivered from the factory with software version **2.2** installed.

These Operating Instructions also apply to other software versions.

Earlier software versions: Some parameters described in this document might not be available in the software (i.e. the corresponding functionality is not available on the converter) or some parameters will have a restricted setting range. SIMOREG 6RA70 Base Drive Panel series requires software version 1.8 or later.

Later software versions: Additional parameters might be available on the SIMOREG DC Master (i.e. extra functions might be available which are not described in these Operating Instructions) or some parameters might have an extended setting range. In this case, leave the relevant parameters at their factory setting, or do not set any parameter values which are not described in these Instructions !

The latest software version of the SIMOREG DC Master can be read in parameters r060 and r065.

The latest software version is available at the following Internet site:

<http://www4.ad.siemens.de/view/cs/en/8467834>

The reproduction, transmission or use of this document or contents is not permitted without express written authority. All rights, including rights created by patent grant or registration of a utility model or design, are reserved.

We have checked that the contents of this publication agree with the hardware and software described herein. Nonetheless, differences might exist and therefore we cannot guarantee that they are completely identical. The information given in this publication is reviewed at regular intervals and any corrections that might be necessary are made in the subsequent printings. Suggestions for improvement are welcome at all times.

SIMOREG © is a registered trademark of Siemens

0 Contents

	Page
1 Safety information	1-1
2 Introduction	
2.1 Base Drive Panel Description	2-1
2.2 General Information	2-1
2.3 Rated DC Current	2-2
2.4 Card Rack Assembly	2-2
3 Parts and Service	
3.1 Base Drive Panel model numbers	3-1
3.2 Service	3-2
3.3 Option part numbers	3-3
3.4 Spare Parts	3-4
3.5 Standard Terms & Conditions	3-10
4 Receiving and Unpacking	4-1
5 Technical Data	
5.1 15 to 100 ADC Base Drive Panels	5-1
5.2 140 to 850 ADC Base Drive Panels	5-2
5.3 1180 to 1680 ADC Base Drive Panels	5-3
5.4 Applicable Standards	5-5
6 Installation and Dimensions	
6.1 Installation Information	6-1
6.2 Base Drive Panel Outlines	6-2
7 Base Drive Panel Connections	
7.1 Base Drive Panel Schematics	7-2
7.2 Control Connections CUD1	7-16
7.3 Control Connections CUD2	7-18
7.4 Description of Power/Control Terminals	7-20

8	Start-up	
	8.1 General safety information	8-1
	8.2 Operator control panels	8-2
	8.3 Parameterization procedure	8-4
	8.4 Typical connection diagrams	8-6
	8.5 Reset to factory default values	8-8
	8.6 Start-up procedure	8-9
9	Faults and Alarms	
	9.1 Fault messages	9-1
	9.2 Alarm messages	9-28
10	Abbreviated Parameter List	
	Overview	10-1
	Overview of Abbreviations	10-3
	10.1 Operating Status Display	10-5
	10.2 General Visualization Parameters	10-7
	10.3 Access Authorization Levels	10-11
	10.4 Definition of SIMOREG Converter	10-13
	10.5 Setting Values for Converter Control	10-17
	10.6 Definition of Motor	10-22
	10.7 Definition of Speed Sensing Pulse Encoder	10-27
	10.8 Armature Current Control, Reversing, Gating	10-30
	10.9 Current/Torque Limitation	10-32
	10.10 Auto-reserving stage. Armature gating unit	10-34
	10.11 Speed Controller	10-34
	10.12 Field Current Control, Gating	10-36
	10.13 Closed Loop EMF Control	10-38
	10.14 Ramp Function Generator	10-39
	10.15 Setpoint Processing	10-41
	10.16 Ramp Function generator	10-42
	10.17 Monitoring Functions and Limits	10-42
	10.18 Limit-Value Monitors	10-43
	10.19 Settable fixed values	10-45
	10.20 Fixed control bits	10-46
	10.21 Digital Setpoint Inputs	10-46
	10.22 Position sensing with pulse encoder	10-48
	10.23 Connector selector switches	10-49

10.24	Motorized potentiometer	10-49
10.25	Oscillation	10-51
10.26	definition of Motor Interface	10-52
10.27	Torque Shell Input	10-53
10.28	Speed limiting controller	10-54
10.29	Friction compensation	10-54
10.30	Compensation of moment of inertia(dv/dt injection)	10-55
10.31	Speed controller	10-57
10.32	Field reversal	10-59
10.33	Input Quantities for Signals	10-59
10.34	Configuring of Closed-Loop Control	10-60
10.35	Control and Status Word	10-68
10.36	Further Configuring Measures	10-71
10.37	Analog Inputs	10-72
10.38	Analog Outputs	10-76
10.39	Binary Outputs	10-78
10.40	Configuration of Serial Interfaces	10-79
10.41	Deactivation of Monitoring Functions	10-89
10.42	Compensation values	10-89
10.43	Thyristor Diagnostics	10-90
10.44	Parameters for DriveMonitor and OP1S	10-90
10.45	Profile Parameters	10-90
10.46	Fault memory	10-91
10.47	Visualization parameters: Alarms	10-92
10.48	Device identification	10-93
10.49	Visualization parameters: Control and status word	10-93
10.50	Resetting and Storing Parameters	10-93
11	Simplified Block Diagrams	11-1

1 Safety information



WARNING



Hazardous voltages and rotating parts are present in this electrical equipment during operation. Non-observance of the safety instructions can result in death, severe personal injury or substantial property damage.

Only qualified personnel should work on or around the equipment after first becoming thoroughly familiar with all warning and safety notices and maintenance procedures contained herein. The successful and safe operation of this equipment is dependent on proper handling, installation, operation and maintenance.

Definitions:

- **QUALIFIED PERSONNEL**

For the purpose of this Instruction Manual and product labels, a "Qualified Person" is someone who is familiar with the installation, construction and operation of the equipment and the hazards involved. He or she must have the following qualifications:

1. Trained and authorized to energize, de-energize, clear, ground and tag circuits and equipment in accordance with established safety procedures.
2. Trained in the proper care and use of protective equipment in accordance with established safety procedures.
3. Trained in providing first aid.

- **DANGER**

For the purpose of this Instruction Manual and product labels, "**Danger**" indicates that death, severe personal injury or substantial property damage **will** result if proper precautions are not taken.

- **WARNING**

For the purpose of this Instruction Manual and product labels, "**Warning**" indicates that death, severe personal injury or substantial property damage **can** result if proper precautions are not taken.

- **CAUTION**

For the purpose of this Instruction Manual and product labels, "**Caution**" indicates that minor personal injury or property damage **can** result if proper precautions are not taken.

- **NOTE**

For the purpose of this Instruction Manual, "**Note**" indicates information about the product or the respective part of the Instruction Manual which requires particular attention.

NOTE

These operating instructions do not purport to cover all details or variations in equipment, nor to provide for every possible contingency to be met in connection with installation, operation or maintenance.

Should further information be desired or should particular problems arise which are not covered sufficiently for the purchaser's purposes, the matter should be referred to the local Siemens Sales Office.

The contents of these operating instructions shall not become part or modify any prior or existing agreement, commitment or relationship. The Sales Contract contains the entire obligations of Siemens. The warranty contained in the contract between the parties is the sole warranty of Siemens. Any statements contained herein do not create new warranties or modify the existing warranty.



DANGER

Converters contain hazardous electrical voltages, Death, severe bodily injury or significant material damage can occur if the safety measures are not followed.

1. Only qualified personnel, who are knowledgeable about the converters and the provided information, can install, start up, operate, troubleshoot or repair the converters.
2. The converters must be installed in accordance with all relevant safety regulations (e.g. NEC, DIN, VDE) as well as all other national or local regulations. Operational safety and reliability must be ensured by correct grounding, cable sizing and appropriate short-circuit protection.
3. All panels and doors must be kept closed during normal operation.
4. Before carrying out visual checks and maintenance work, ensure that the AC power supply is disconnected and locked out. Before the AC supply is disconnected, both converters and motors have hazardous voltage levels. Even when the converter contactor is open, hazardous voltages are still present.
5. When making measurements with the power supply switched on, electrical connections must not be touched under any circumstances. Remove all jewelry from wrists and fingers. Ensure that the test equipment is in good conditions and operationally safe.
6. When working on units that are switched on, stand on an insulating surface, i.e. ensure that you are not grounded.
7. Carefully follow the relevant instructions and observe all danger, warning and cautionary instructions.
8. This does not represent a full listing of all the measures necessary for safe operation of the equipment. If you require other information or if certain problems occur which are not handled in enough detail in the information provided in the Instruction Manual, please contact your local Siemens office.





CAUTION

Electro-statically sensitive devices

The converter contains electro-statically sensitive devices. These can easily be destroyed if they are not handled correctly. If, however, it is absolutely essential for you to work on electronic modules, please pay careful attention to the following instructions:

- Electronic modules (PCBs) should not be touched unless work has to be carried out on them.
- Before touching a PCB, the person carrying out the work must himself be electro-statically discharged. The simplest way of doing this is to touch an electrically conductive ground object, e.g. socket outlet ground contact.
- PCBs must not be allowed to come into contact with electrically insulating materials – plastic foil, insulating table tops or clothing made of synthetic fibers –
- PCBs may only be set down or stored on electrically conducting surfaces.
- When carrying out soldering jobs on PCBs, make sure that the soldering tip has been grounded.
- PCBs and electronic components should generally be packed in electrically conducting containers (such as metallized-plastic boxes or metal cans) before being stored or shipped.
- If the use of non-conducting packing containers cannot be avoided, PCBs must be wrapped in a conducting material before being put in them. Examples of such materials include electrically conducting foam rubber or household aluminum foil.

For easy reference, the protective measures necessary when dealing with sensitive electronic components are illustrated in the sketches below.

a = Conductive flooring

d = Anti-static overall

b = Anti-static table

e = Anti-static chain

c = Anti-static footwear

f = Grounding connections of cabinets

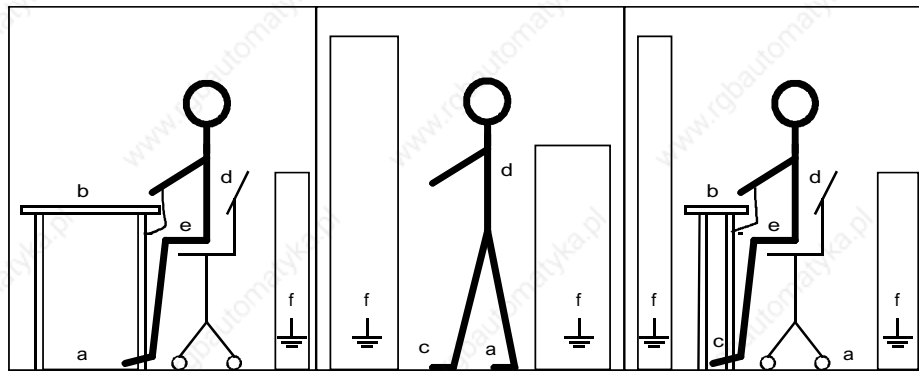

Seated workstation

Standing workstation

Standing/seated workstation

NOTES:

2 Description

2.1 Base Drive Panel Description

Series 6RA70 SIMOREG DC MASTER Base Drive Panels are complete drive assemblies ready to be installed and operated. They include a 3-phase armature converter, single-phase field converter, main contactor, protective semiconductor fuses, control power transformer, and power / control terminals.

Base Drive Panels are fully digital, compact units which supply the armature and field of variable-speed DC drives with rated armature currents from 15A to 1680A. The motor field circuit can be supplied with DC currents of up to 85A (current levels depend on the armature rated current).

2.2 General Information

Series 6RA70 SIMOREG DC MASTER converters are characterized by their compact, space-saving construction. Their compact design makes them particularly easy to service and maintain since individual components are readily accessible. The electronics box contains the basic electronic circuitry as well as any supplementary option boards.

All SIMOREG DC MASTER units are equipped with a PMU simple operator panel mounted in the converter door. The panel consists of a five-digit, seven-segment display, three LED's as status indicators and three parameterization keys. The PMU also features connector X300 with an USS interface in accordance with the RS232 or RS485 standard. The panel provides all the facilities for making adjustments or settings and displaying measured values required to start-up the converter.

The OP1S optional converter operator panel can be mounted directly in the converter door or externally, e.g., in the cubicle door. When mounted remotely, the OP1S can be connected to the converter with cables up to 5 meters (15 feet) length. Cable up to 50 meter (164 feet) in length can be used if a separate 5 VDC power supply is available. The OP1S connects to the SIMOREG through connector X300 using the RS485 interface. The OP1S can be installed as an economic alternative to conventional door mounted metering devices (i.e., voltmeters, ammeters, and speed indicator).

The OP1S features a liquid crystal display with 4 x 16 characters for displaying parameter names in plain text. English, German, French, Spanish and Italian can be selected as the display languages. In addition the OP1S can store parameter sets for easy downloading to other drives.

The converter can also be parameterized on a standard PC with appropriate software connected to the serial interface on the basic unit. This PC interface is used during start-up, for maintenance during shutdown and for diagnosis in operation. Furthermore, converter software upgrades can be loaded through this interface for storage in flash memory.

On single-quadrant converters, a fully controlled three-phase bridge supplies the armature. On four-quadrant converters, two fully controlled three-phase bridges are connected in an inverse-parallel connection to allow both positive and negative armature current. For the field converter, a single-phase, half-controlled 2-pulse bridge supplies the motor shunt field.

The armature and field converters can operate with AC line frequencies from 45 to 65 Hz. If required for a specific application, the frequency of the armature and field AC supplies can be different. The armature converter 3 phase AC supply is phase insensitive however on base drives rated 1180, 1660 and 1680 amperes, the 3 phase cooling fan must be connected to get the proper direction of rotation. The power section cooling system is monitored by means of temperature sensors.

The power section for the armature and field converters is constructed of isolated thyristor modules for converters rated from 15A to 850A at 460VAC-line voltage. The heat sink in this case is electrically isolated and at ground potential. On converters rated 1180, 1660 and 1680 amperes at 460 VAC, the power section for the armature circuit is constructed using disk thyristors and the heat sinks are at line voltage potential. The housing and terminal covers on power connections provide protection against accidental contact for operators working in the vicinity. All connecting terminals are accessible from the front.

All open and closed-loop drive control and communication functions are performed by two powerful microprocessors. Drive control functions are implemented in the software as program modules that can be "wired up" and changed by parameters.

2.3 Rated DC Current:

The rating plate of the 6RA70 power module has 2 rated currents listed on it. The first output rating is a IEC class I ratings and has no bearing on the base drive panel rating. The second rating is the US (NEMA) rating which the Base Drive Panel rating is derived from.

The US (NEMA) rated current allows operation at this rated current followed by an overload of 150% for 60 seconds in a 45°C ambient. The overload can be applied no sooner than every 10 minutes. Base Drive Panels are designed using the US rating which means that fuses, contactors, and terminal blocks are sized for the rated US (NEMA) current.

The IEC class I rating is the maximum current the power module can supply continuously with no overload. Because an overload is not possible the class I rated current is higher than the US rating. The IEC class I rating cannot be used with Base Drive Panels because the Base Drive Panel fuses, contactors, and terminal blocks will be overloaded.

The microprocessor calculates the current I²t value of the power section cyclically to ensure that the thyristors are not damaged in overload operation.

2.4 Card Rack Assembly

One of the many features of the 6RA70 is its ability to expand its functionality modularly through the use of adding additional option cards inserted in the internal card rack of the power module. A complete list of the option cards can be found in 6RA70 catalog available from your local Siemens Sales office.

The card rack assembly contains the CUD1 microprocessor board and two additional slots for two full size option cards or four half-size option cards. The back plane of the card rack assembly contains an EEPROM allowing the CUD1 to be replaced without reprogramming of the parameters. **Since additional information specific to the individual unit is programmed into the back plane of the card rack assembly (model #, serial #, PIN code, etc..) the card rack assembly should never be interchanged with another unit. If ordering an additional back plane (part # 6RY1703-0GA01) the model and serial number of the power module will be required.**

3 Parts and Service

3.1 Base Drive Panel Catalog Numbers

US RATING (Amps DC)	1-QUAD TYPE (Catalog No.)	4-QUAD TYPE (Catalog No.)	Horsepower (240V DC ¹)	Horsepower (500V DC)
15	6RA7013-2FS22-0	6RA7013-2FV62-0	3HP	7.5HP
30	6RA7018-2FS22-0	6RA7018-2FV62-0	7.5HP	15HP
60	6RA7025-2FS22-0	6RA7025-2FV62-0	15HP	30HP
100	6RA7030-2FS22-0	6RA7030-2FV62-0	25HP	60HP
140	6RA7072-2FS22-0	6RA7072-2FV62-0	40HP	75HP
210	6RA7075-2FS22-0	6RA7075-2FV62-0	60HP	125HP
255	6RA7077-2FS22-0	6RA7077-2FV62-0	75HP	150HP
430	6RA7082-2FS22-0	6RA7082-2FV62-0	125HP	250HP
510	6RA7083-2FS22-0	6RA7083-2FV62-0	150HP	300HP
850	6RA7087-2FS22-0	6RA7087-2FV62-0	250HP	500HP
1180 ⁽²⁾	6RA7091-2FS22-0	6RA7091-2FV62-0	350HP	700HP
1660 ⁽²⁾	6RA7094-2FS22-0	6RA7094-2FV62-0	500HP	1000HP
1680 ⁽²⁾	6RA7094-2FS22-085	6RA7094-2FV62-085	500HP	1000HP

1) Standard voltage configuration as shipped is 460V AC. See Technical application note for 230V AC connection.

2) Standard voltage configuration as shipped is 460V AC. See Technical application note for 575V AC connection on 1180 1660 & 1680A Base drives

3.2 Service

Spare Parts

An excellent stock of drive products spare parts is maintained at the Alpharetta, Georgia factory. Same day delivery and after hour shipments can be serviced from this stock, including on weekends and holidays. To contact Customer Service, simply call our Customer Service Group general phone number:

1-800-333-PIC1 (7421)

Technical Assistance

Should you need technical assistance (other than ordering a part), a reliable answering service ensures that your request is relayed immediately to one of our technical support engineers 24 hours a day. To contact the Technical Support and Field Service groups simply call:

1-800-333-PIC1 (7421)

3.3 Option Part Numbers

Options	Order No.
Terminal expansion card (CUD2)	6RX1700-0AK00
User-friendly operator control panel (OP1S)	6SE7090-0XX84-2FK0
AOP1 adapter for mounting OP1A in cubicle door, including 5 m connecting cable	6SX7010-0AA00
PMU-OP1S connecting cable, 3m	6SX7010-0AB03
PMU-OP1S connecting cable, 5m	6SX7010-0AB05
LBA Local bus adapter for the electronics box Note: LBA is needed to install any boards listed below	6SE7090-0XX84-4HA0
ADB Adapter board Note: ADB is always needed to install CBC, CBP2, CBD, EB1, EB2, SBP and SLB boards	6SE7090-0XX84-0KA0
SBP Pulse encoder evaluation board 1) 2)	6SX7010-0FA00
EB1 Terminal expansion board 2)	6SX7010-0KB00
EB2 Terminal expansion board 2)	6SX7010-0KC00
SLB SIMOLINK board 2)	6SX7010-0FJ00
CBP2 Communications board interface for PROFIBUS 2)	6SX7010-0FF05
CBC Communications board interface for CAN protocol 2)	6SX7010-0FG00
CBD Communications board interface for DeviceNet protocol 2)	6SX7010-0FK00
T400 Technology board with SPW 420 Axial winder software 2)	6DD1-842-0AA0
T400 Technology board with SPW 440 Angular Synchr. Software 2)	6DD1-842-0ABO

- 1) A pulse encoder evaluation circuit is a standard component of the basic SIMOREG converter. The SBP only needs to be ordered in configurations requiring evaluation of a second pulse encoder.
- 2) The LBA local bus adapter and ADB adapter board must be ordered as additional components for installing supplementary boards in the SIMOREG converter.

3.4 Spare Parts

Printed Circuit Boards

DESCRIPTION	WHERE USED US Rating 460V	PART NUMBER	RECOM SPARE
Microprocessor board CUD1 (C98 043-A7001-L1)	All Ratings	6RY1703-0AA00	1
Power Interface board 1Q (85 to 575 VAC) (C98 043-A7002-L1)	All 1Q Ratings	6RY1703-0DA01	1
Power Interface board 4Q (85 to 575 VAC) (C98 043-A7002-L4)	All 4Q Ratings	6RY1703-0DA02	1
PMU Operator Panel (C98 043-A7005-L1)	All Ratings	6RY1704-0AA00	-
Field Supply board (C98 043-A7014-L1)	30 to 100 Amp	6RY1703-0CA03	1
Field Supply board (C98 043-A7014-L2)	140 to 510 Amp	6RY1703-0CA01	1
Field Supply board (C98 043-A7004-L1)	850 to 1660 Amp	6RY1703-0EA01	1
Field Supply board (C98 043-A7004-L3)	1680 Amp	6RY1703-0EA03	1
Snubber board (C98 043-A7007-L4)	60 to 100 Amp	6RY1703-0FA04	
Snubber board (C98 043-A7007-L6)	30, 140 & 210 Amp	6RY1703-0FA11	-
Snubber board (C98 043-A7011-L6)	255 & 430 Amp	6RY1703-0FA10	-
Snubber boards (C98 043-A7011-L1)	510 & 850 Amp	6RY1703-0FA06	-
Main Power Section Connector board (C98 043-A7010-L2)	15 Amp (1Q, 4Q)	6RY1703-0CA04	1
Fuse for Power Supply, 1 amp F1, F2 Mounted on Power Interface board	15 – 1680 Amp	6RY1702-0BA00	2

Cables

DESCRIPTION	WHERE USED US Rating 460V	PART NUMBER	RECOM SPARE
Ribbon Cable 20 pole X102	15 amp	6RY1707-0AA00	
Ribbon Cable 64 pole X101	15 to 430 amp	6RY1707-0AA01	-
Ribbon Cable 20 pole X102	30 to 210 amp	6RY1707-0AA02	-
Ribbon Cable 20 pole X102	255 & 430 amp	6RY1707-0AA03	-
Ribbon Cable 20 pole X102	510 amp	6RY1707-0AA12	-
Ribbon Cable 64 pole X101	510 amp	6RY1707-0AA05	-
Ribbon Cable 20 pole X102	850 to 1680 amp	6RY1707-0AA06	-
Ribbon Cable 64 pole X101	850 to 1680 amp	6RY1707-0AA07	-

Fans/Blowers

DESCRIPTION	WHERE USED US Rating 460V	PART NUMBER	RECOM SPARE
FAN, 24 VDC (C98130-A1256-C553)	140 & 210 amp	6RY1701-0AA07	2
FAN, 230 VAC, 1 Phase (C98130-A7004-B130)	255, 430 & 510 amp	6RY1701-0AA11	1
FAN, 230 VAC, 1 Phase (C98130-A7004-B330)	850 amp	6RY1701-0AA12	1
FAN, 460 VAC, 3 Phase (C98 247-S1002-C25)	1180, 1660 &1680 amp	6RY1701-0AA04	1

Thyristors & Diodes

Armature Converter Thyristor Modules, (for 1-Quad Drives)

DESCRIPTION	WHERE USED US Rating 460V	PART NUMBER	RECOM SPARE
Dual Thyristor Module	15 amp 1Q	6RY1700-0AA16	3
Dual Thyristor Module	30 amp 1Q	6RY1700-0AA17	3
Dual Thyristor Module	60 amp 1Q	6RY1700-0AA18	3
Dual Thyristor Module	100 amp 1Q	6RY1700-0AA11	3
Dual Thyristor Module	140 amp 1Q	6RY1700-0AA14	3
Dual Thyristor Module	210 amp 1Q	6SY7010-0AA02	3
Dual Thyristor Module	255 amp 1Q	6RY1700-0AA15	3
Dual Thyristor Module	430 amp 1Q	6SY7010-0AA05	3
Dual Thyristor Module	510 amp 1Q	6SY7010-0AA04	3
Dual Thyristor Module	850 amp 1Q	6RY1700-0AA04	3
Thyristor/Heatsink Assembly, Front (C98 130-A1255-B510)	1180 amp 1Q	6RY1702-0CA15	2
Thyristor/Heatsink Assembly, Back (C98 130-A1255-B511)	1180 amp 1Q	6RY1702-0CA16	2
Thyristor/Heatsink Assembly, Front (C98 130-A1255-B520)	1660 amp 1Q	6RY1702-0CA17	2
Thyristor/Heatsink Assembly, Back (C98 130-A1255-B521)	1660 amp 1Q	6RY1702-0CA18	2
Thyristor/Heatsink Assembly, Front	1680 amp 1Q	6RY1702-0CA30	2
Thyristor/Heatsink Assembly, Back	1680 amp 1Q	6RY1702-0CA31	2

Armature Converter Thyristor Modules, (for 4-Quad Drives)

DESCRIPTION	WHERE USED US Rating 460V	PART NUMBER	RECOM SPARE
Dual Thyristor Module	15 amp 4Q	6RY1700-0AA16	3
Dual Thyristor Module	30 amp 4Q	6RY1700-0AA17	3
Dual Thyristor Module	60 & 100 amp 4Q	6RY1700-0AA11	3
Dual Thyristor Module	140 amp 4Q	6RY1700-0AA14	3
Dual Thyristor Module	210 amp 4Q	6SY7010-0AA02	3
Dual Thyristor Module	255 amp 4Q	6RY1700-0AA15	3
Dual Thyristor Module	430 amp 4Q	6SY7010-0AA05	3
Dual Thyristor Module	510 to 850 amp 4Q	6SY7010-0AA04	3
Thyristor/Heatsink Assembly C98 130-A1256-B510	1180 amp 4Q	6RY1702-0CA02	2
Thyristor/Heatsink Assembly C98 130-A1256-B520	1660 amp 4Q	6RY1702-0CA03	2
Thyristor/Heatsink Assembly	1680 amp 4Q	6RY1702-0CA34	2

Field Converter Thyristor Modules

DESCRIPTION	WHERE USED US Rating 460V	PART NUMBER	RECOM SPARE
Dual Thyristor Module	15 to 430 amp	6RY1700-0AA12	1
Dual Thyristor Module	510 to 1660 amp	6RY1700-0AA17	1
Dual Thyristor Module	1680 amp	6RY1700-0AA05	1

Field Converter Diode Modules

DESCRIPTION	WHERE USED US Rating 460V	PART NUMBER	RECOM SPARE
Dual Diode Module	15 to 430 amp	6RY1700-0BA04	1
Dual Diode Module	510 to 1660 amp	6RY1700-0BA01	1
Dual Diode Module	1680 AMP	6RY1700-0BA05	1

Power Fuses

Armature Converter AC Line Fuses, (1PFU - 3 PFU)

DESCRIPTION	WHERE USED US Rating 460V	PART NUMBER	RECOM SPARE
25 amp, 700 volt	15 amp	A1-FUF-END-C25	3
50 amp, 700 volt	30 amp	A1-FUF-END-CDN	3
70 amp, 500 volt	60 amp	A1-FUF-00D-014	3
125 amp, 500 volt	100 amp	A1-FUF-00D-018	3
150 amp, 500 volt	140 amp	A1-FUF-00D-019	3
200 amp, 500 volt	210 amp	A1-FUF-00D-021	3
250 amp, 500 volt	255 amp	A1-FUF-00D-023	3
400 amp, 500 volt	430 amp	A1-FUF-00D-028	3
500 amp, 500 volt	510 amp	A1-FUF-00D-030	3
800 amp, 800 volt (Leg Fuse)	850 amp	3NE3338-8	3
1000 amp, 660 volt (Leg Fuse)	1180 amp	6RY1702-0BA02	3
1250 amp, 660 volt (Leg Fuse)	1660 amp	6RY1702-0BA01	3
1500 amp, 660 volt (Leg Fuse)	1680 amp	6RY1702-0BA05	3

Armature Converter DC Fuses, 4-Quad Only, (4PFU)

DESCRIPTION	WHERE USED US Rating 460V	PART NUMBER	RECOM SPARE
25 amp, 700 volt	15 amp	A1-FUF-END-C25	2
50 amp, 700 volt	30 amp	A1-FUF-END-CDN	2
90 amp, 700 volt	60 amp	A1-FUF-00E-016	2
150 amp, 700 volt	100 amp	A1-FUF-00E-019	2
175 amp, 700 volt	140 amp	A1-FUF-00E-020	2
250 amp, 700 volt	210 amp	A1-FUF-00E-023	2
300 amp, 700 volt	255 amp	A1-FUF-00E-025	2
500 amp, 700 volt	430 amp	A1-FUF-00E-030	2
600 amp, 700 volt	510 amp	A1-FUF-00E-031	2

Field Converter AC Line Fuses (1 & 2FSFU)

DESCRIPTION	WHERE USED US Rating 460V	PART NUMBER	RECOM SPARE
20 amp, 700 volt	60 to 210 amp	A1-FUF-END-C20	2
40 amp, 700 volt	255 to 850 amp	A1-FUF-END-C40	2
50 amp, 700 volt	1180 to 1660 amp	A1-FUF-END-C50	2
125 amp, 600 volt	1680 amp	A1-FUF-HHA-024	2

Control Transformer Primary Fuses (1CFU, 2CFU)

DESCRIPTION	WHERE USED US Rating 460V	PART NUMBER	RECOM SPARE
1.25 amp, 600 volt, Class "CC"	15 to 100 amp	A1-FUF-AFA-006	2
2.5 amp, 600 volt, Class "CC"	140 & 210 amp 1180, 1660 & 1680 amp	A1-FUF-AFA-011	2
3.5 amp, 600 volt, Class "CC"	255 to 510 amp 850 amp, (460 volt input only)	A1-FUF-AFA-014	2
5 amp, 600 volt, Class "CC"	1180, 1660 & 1680 amp (4CFU, 5CFU, 6CFU, 7CFU)	A1-FUF-AFA-016	4

Control Transformer Secondary Fuse (3CFU)

DESCRIPTION	WHERE USED US Rating 460V	PART NUMBER	RECOM SPARE
0.75 amp, 250 volt, Type MDL	15 to 100 amp	A1-FUF-DKA-GBF	2
1.5 amp, 250 volt, Type MDL	140 & 210 amp 1180, 1660 & 1680 amp	A1-FUF-DKA-GBP	2
2 amp, 250 volt, Type MDL	255 to 510 amp	A1-FUF-DKA-GBV	2
6.25 amp, 250 volt, Type MDL	850 amp	A1-FUF-DKA-GCM	2

Control Transformer (1CTR, 2CTR, 3CTR)

DESCRIPTION	WHERE USED US Rating 460V	PART NUMBER	RECOM SPARE
460 VAC Primary			
115 VA, 230 VAC secondary	15 to 100 amp	A1-TRC-Q0C-285	-
250 VA, 230 VAC secondary	140 & 210 amp 1180, 1660 & 1680 amp	A1-TRC-Q0C-286	-
350 VA, 230 VAC secondary	255 to 510 amp	A1-TRC-Q0C-287	-
1000 VA, 230 VAC secondary	850 amp	A1-TRC-Q0C-288	-
750 VA, 460 VAC secondary	1180,1660 & 1680 amp	A1-TRC-Q0C-289	-

Main Contactor (M)

DESCRIPTION	WHERE USED US Rating 460V	PART NUMBER	RECOM SPARE
3 Pole AC contactor, 240 VAC coil	15 amp	3RT1016-1AP61	-
3 Pole AC contactor, 240 VAC coil	30 amp	3RT1025-1AP60	-
3 Pole AC contactor, 240 VAC coil	60 amp	3RT1035-1AP60	-
3 Pole AC contactor, 240 VAC coil	100 amp	3RT1044-1AP60	-
3 Pole AC contactor, 240 VAC coil	140 amp	3RT1045-1AP60	-
3 Pole AC contactor, 240 VAC coil	210 amp	3RT1456-6AP36	-
3 Pole AC contactor, 240 VAC coil	255 amp	3RT1456-6AP36	-
1 Pole DC contactor, 250 VDC coil	430 to 1680 amp	A1-CRD-CAC-010	-

Contactors Coil Suppressor (1SP, ENSP)

DESCRIPTION	WHERE USED US Rating 460V	PART NUMBER	RECOM SPARE
Suppressor, varistor type 127 – 240 V	15 amp 430 to 1680 amp	3RT1916-1BD00	-
Suppressor, varistor type 127 – 240 V	30 to 140 amp	3RT1926-1BD00	-

Auxiliary Relay, (EN), and Rectifier Bridge, (MREC)

DESCRIPTION	WHERE USED US Rating 460V	PART NUMBER	RECOM SPARE
Relay, 2-NO, 2-NC, 230 VAC coil	430 to 1680 amp	3RH1122-1AP60	-
Rectifier Bridge, 1 Phase, 5A, 800 V	430 to 1680 amp	A1-116-002-001	-

3.5 Standard Terms and Conditions of Sale

Siemens Energy & Automation, Inc. ("Seller")

1. **WARRANTY** - Seller warrants that on the date of shipment the goods are of the kind and quality described herein and are free of non-conformities in workmanship and material. This warranty does not apply to goods delivered by Seller but manufactured by others.

(b) Buyer's exclusive remedy for a nonconformity in any item of the goods shall be the repair or the replacement (at Seller's option) of the item and any affected part of the goods. Seller's obligation to repair or replace shall be in effect for a period of one (1) year from initial operation of the goods but not more than eighteen (18) months from Seller's shipment of the goods, provided Buyer has sent written notice within that period of time to Seller that the goods do not conform to the above warranty. Repaired and replacement parts shall be warranted for the remainder of the original period of notification set forth above, but in no event less than 12 months from repair or replacement. At its expense, Buyer shall remove and ship to Seller any such nonconforming items and shall reinstall the repaired or replaced parts. Buyer shall grant Seller access to the goods at all reasonable times in order for Seller to determine any nonconformity in the goods. Seller shall have the right of disposal of items replaced by it. If Seller is unable or unwilling to repair or replace, or if repair or replacement does not remedy the nonconformity, Seller and Buyer shall negotiate an equitable adjustment in the contract price, which may include a full refund of the contract price for the nonconforming goods.

(c) SELLER HEREBY DISCLAIMS ALL OTHER WARRANTIES, EXPRESS OR IMPLIED, EXCEPT THAT OF TITLE. SPECIFICALLY, IT DISCLAIMS THE IMPLIED WARRANTIES OF MERCHANTABILITY, FITNESS FOR A PARTICULAR PURPOSE, COURSE OF DEALING AND USAGE OF TRADE.

(d) Buyer and successors of Buyer are limited to the remedies specified in this article and shall have no others for a nonconformity in the goods. Buyer agrees that these remedies provide Buyer and its successors with a minimum adequate remedy and are their exclusive remedies, whether Buyer's or its successors' remedies are based on contract, warranty, tort (including negligence), strict liability, indemnity, or any other legal theory, and whether arising out of warranties, representations, instructions, installations, or non-conformities from any cause.

Note: This article 1 does not apply to any software which may be furnished by Company. In such cases, the attached [Software License Addendum](#) applies.

2. **PATENTS** - Seller shall pay costs and damages finally awarded in any suit against Buyer or its vendees to the extent based upon a finding that the design or construction of the goods as furnished infringes a United States patent (except infringement occurring as a result of incorporating a design or modification at Buyer's request), provided that Buyer promptly notifies Seller of any charge of infringement, and Seller is given the right at its expense to settle such charge and to defend or control the defense of any suit based upon such charge. Seller shall have no obligation hereunder with respect to claims, suits or proceedings, resulting from or related to, in whole or in part, (i) the use of software or software documentation, (ii) compliance with Buyer's specifications, (iii) the combination with, or modification of, the goods after delivery by Seller, or (iv) the use of the goods, or any part thereof, in the practice of a process. THIS ARTICLE SETS FORTH SELLER'S ENTIRE LIABILITY WITH RESPECT TO PATENTS.

3. **PERFORMANCE; DELAYS** - Timely performance by Seller is contingent upon Buyer's supplying to Seller, when needed, all required technical information and data, including drawing approvals, and all required commercial documentation. If Seller suffers delay in performance due to any cause beyond its reasonable control, the time of performance shall be extended a period of time equal to the period of the delay and its consequences. Seller will give to Buyer notice within a reasonable time after Seller becomes aware of any such delay.

4. **SHIPMENT, TITLE AND RISK OF LOSS** - (a) The term "shipment" means delivery to the initial carrier in accordance with the delivery terms of this contract. Seller may make partial shipments. Seller shall select method of transportation and route, unless terms are f.o.b. point of shipment and Buyer specifies the method and route and is to pay the freight costs in addition to the price. When terms are f.o.b. destination or freight allowed to destination, "destination" means common carrier delivery point (within the United States, excluding Alaska and Hawaii) nearest the destination.

(b) Title to the goods and risk of loss or damage shall pass to Buyer at the f.o.b. point. Seller shall not be responsible for damage to the goods after having received "in good order" receipts from the carrier.

5. **TAXES** - Any applicable duties or sales, use, excise, value-added or similar taxes will be added to the price and invoiced separately (unless an acceptable exemption certificate is furnished).

6. **TERMS OF PAYMENT** - (a) Unless otherwise stated, all payments shall be in United States dollars, and a pro rata payment shall become due as each shipment is made. If shipment is delayed by Buyer, date of notice of readiness for shipment shall be deemed to be date of shipment for payment purposes.

(b) On late payments, the contract price shall, without prejudice to Seller's right to immediate payment, be increased by 1 1/2% per month on the unpaid balance, but not to exceed the maximum permitted by law.

(c) If any time in Seller's judgment Buyer is unable or unwilling to meet the terms specified, Seller may require satisfactory assurance or full or partial payment as a condition to commencing or continuing manufacture or making shipment, and may, if shipment has been made, recover the goods from the carrier, pending receipt of such assurances.

7. NONCANCELLATION - Buyer may not cancel or terminate for convenience, or direct suspension of manufacture, except with Seller's written consent and then only upon terms that will compensate Seller for its engineering, fabrication and purchasing charges and any other costs relating to such cancellation, termination or suspension, plus a reasonable amount for profit.

8. NUCLEAR - Buyer represents and warrants that the goods covered by this contract shall not be used in or in connection with a nuclear facility or application. If Buyer is unable to make such representation and warranty, then Buyer agrees to indemnify and hold harmless Seller and to waive and require its insurers to waive all right of recovery against Seller for any damage, loss, destruction, injury or death resulting from a "nuclear incident", as that term is defined in the Atomic Energy Act of 1954, as amended, whether or not due to Seller's negligence.

9. LIMITATION OF LIABILITY - Neither Seller, nor its suppliers shall be liable, whether in contract, warranty, failure of a remedy to achieve its intended or essential purposes, tort (including negligence), strict liability, indemnity or any other legal theory, for loss of use, revenue or profit, or for costs of capital or of substitute use or performance, or for indirect, special, liquidated, incidental or consequential damages, or for any other loss or cost of a similar type, or for claims by Buyer for damages of Buyer's customers. Seller's maximum liability under this contract shall be the contract price. Buyer and Seller agree that the exclusions and limitations set forth in this article are separate and independent from any remedies which Buyer may have hereunder and shall be given full force and effect whether or not any or all such remedies shall be deemed to have failed of their essential purpose.

10. GOVERNING LAW AND ASSIGNMENT - The laws of the State of Georgia shall govern the validity, interpretation and enforcement of this contract, without regard to its conflicts of law principles. The application of the United Nations Convention on Contracts for the International Sale of Goods shall be excluded. Assignment may be made only with written consent of both parties; provided, however, Seller may assign to its affiliate without Buyer's consent.

11. ATTORNEY FEES - Buyer shall be liable to Seller for any attorney fees and costs incurred by Seller in enforcing any of its rights hereunder.

12. DISPUTES - Either party may give the other party written notice of any dispute arising out of or relating to this contract and not resolved in the normal course of business. The parties shall attempt in good faith to resolve such dispute promptly by negotiations between executives who have authority to settle the dispute. If the matter has not been resolved within 60 days of the notice, either party may initiate non-binding mediation of the dispute.

13. STATUTE OF LIMITATIONS - To the extent permitted by applicable law, any lawsuit for breach of contract, including breach of warranty, arising out of the transactions covered by this contract, must be commenced not later than twelve (12) months from the date the cause of action accrued.

14. PRICES - In the event of a price increase or decrease, the price of goods on order will be adjusted to reflect such increase or decrease. This does not apply to a shipment held by request of Buyer. Goods already shipped are not subject to price increase or decrease. Orders on a bid or contract basis are not subject to this article. Orders amounting to less than \$100.00 net will be invoiced at \$100.00 plus transportation charges for goods covered by discount schedules. Seller's prices include the costs of standard domestic packing only. Any deviation from this standard packing (domestic or export), including U.S. Government sealed packing, will result in extra charges. To determine such extra charges, consult Seller's sales offices.

15. ADDITIONAL TERMS OF PAYMENT - (a) Invoice payment terms are as shown on latest discount sheets as issued from time to time. Cash discounts are not applicable to notes or trade acceptances, to prepaid transportation charges when added to Seller's invoices or to discountable items if there are undisputed past due items on the account. Portions of an invoice in dispute should be deducted and the balance remitted with a detailed explanation of the deduction. Cash discounts will only be allowed on that portion of the invoice paid within the normal discount period.

(b) Freight will be allowed to any common-carrier free-delivery point within the United States, excluding Alaska and Hawaii, on shipments exceeding \$1,000 net or more providing Seller selects the carrier. On shipments to Alaska and Hawaii, freight will be allowed to dockside at the listed port of debarkation nearest the destination point on shipments of \$1,000 net or more. Buyer shall pay all special costs such as cartage, stevedoring and insurance. Special freight allowances are as shown on latest discount sheets as issued from time to time. Cataloged weights are estimated, not guaranteed. Seller assumes no responsibility for tariff classifications on carriers.

16. CHANGES IN LAWS AND REGULATIONS - Seller's prices and timely performance are based on all applicable laws, rules, regulations, orders, codes, standards or requirements of governmental authorities effective on the date of Seller's proposal. Any change to any law, rule, regulation, order, code, standard or requirement which requires any change hereunder shall entitle Seller to an equitable adjustment in the prices and any time of performance.

NOTES:

4 Receiving, unpacking

SIMOREG Base Drive Panels are packed at the manufacturing plant in protective containers suitable for shipping. Avoid dropping and shocks during unloading and moving the SIMOREG during receiving. Observe the instructions on the package for transport, storage, and correct handling.

If you discover that the Base Drive Panel has been damaged during shipment, please inform your shipping agent immediately.



WARNING



If a SIMOREG Base Drive Panel was damaged during transport, it must not be connected up without first being repaired and tested by a qualified repair person.

Non-observance of the safety instructions can result in death, severe personal injury or substantial property damage.

Only qualified personnel should work on or around the equipment after first becoming thoroughly familiar with all warning and safety notices and maintenance procedures contained herein. The successful and safe operation of this equipment is dependent on proper handling, installation, operation and maintenance.

Procedure for Shipping Damage

SIMOREG Base Drive Panels are normally shipped FOB factory making it the buyers responsibility to make sure the equipment is received undamaged. Carefully examine the equipment before accepting the shipment from the transport carrier. If you do not notify the carrier immediately of any damage you may lose your right to file a damage claim. If required you can request support from the local Siemens office.

- When received, examine the shipment to ensure that it is complete and not damaged.
- Damaged or missing items that are obviously visible should be specified in the shipping papers and must be countersigned by personnel from the transport company.
- Immediately notify the transport company in writing of any damage or missing items

NOTES:

5 Technical data:

5.1 15ADC to 100ADC Base Drive Panels, 3AC 460V, 1 & 4Q

Rated supply voltage armature ¹⁾	V	3 Phase 460 (+10% / – 5%)			
Rated input current armature + field ²⁾	A	17.3	34.6	59.2	92
Rated supply voltage field	V	1 Phase 460 (+10%)			
Rated frequency	Hz	45 to 65 Hz self adapting (armature and field are independent)			
Rated DC voltage ³⁾	V	500			
Rated DC armature current	A	15	30	60	100
Overload capability 60s ⁷⁾		150% of rated DC current			
Rated output @ 500 VDC	Hp	7 ½	15	30	60
Rated output @ 240 VDC	Hp	3	7 ½	15	25
Power loss at rated DC current (approximate)	W	150	200	360	510
Rated DC voltage field	V	300			
Rated DC field current	A	5	10		
Operational ambient temperature	°C	0 to 45 at I _{rated} self-cooled ⁴⁾			
Storage and transport temperature	°C	– 25 to +70			
Installation altitude above sea level		≤ 1000 m at rated DC current ⁵⁾			
Control stability		$\Delta n = 0.006\%$ of the rated motor speed, valid for pulse encoder operation <u>and</u> digital setpoint $\Delta n = 0.1\%$ of the rated motor speed, valid for analog tachometer or analog setpoint ⁶⁾			
Degree of protection		Open Chassis (IP00)			
Dimensions		See dimension drawings in Section 6			
Weights (approx.)	Lbs.	35	55	60	70

x) Explanation at end of list of tables

5.2 140ADC to 850ADC Base Drive Panels, 3AC 460V, 1 & 4Q

Rated supply voltage armature ¹⁾	V	3 Phase 460 (+10% / - 5%)					
Rated input current armature + field ²⁾	A	129.8	187.2	234.1	377.6	448.2	727
Fan type	V	Internal 24VDC		1 Phase 230V			
Air flow rate	ft ³ /min	100		570		1300	
Fan noise level	dBA	40		76		85	
Rated supply voltage field	V	1 Phase 460 (+10%)					
Rated frequency	Hz	45 to 65 Hz self adapting (armature and field are independent)					
Rated DC voltage ³⁾	V	500					
Rated DC armature current	A	140	210	255	430	510	850
Overload capability 60s ⁷⁾		150% of rated DC current					
Rated output @ 500 VDC	Hp	75	125	150	250	300	500
Rated output @ 240 VDC	Hp	40	60	75	125	150	250
Power loss at rated DC current (approximately)	W	740	1000	1300	1915	2180	3850
Rated DC voltage field	V	300					
Rated DC field current	A	15		25		30	
Operational ambient temperature	°C	0 to 45 at I _{rated} fan-cooled ⁴⁾					
Storage and transport temperature	°C	- 25 to +70					
Installation altitude above sea level		≤ 1000 m at rated DC current ⁵⁾					
Control stability		$\Delta n = 0.006\%$ of the rated motor speed, valid for pulse encoder operation <u>and</u> digital setpoint $\Delta n = 0.1\%$ of the rated motor speed, valid for analog tachometer or analog setpoint ⁶⁾					
Degree of protection		Open Chassis (IP00)					
Dimensions		Refer to dimension drawings in Section 6					
Weights (approx.)	Lbs.	90	95	145	160	210	400

5.3 1180ADC, 1660ADC & 1680ADC Base Drive Panels, 3AC 460V, 1 & 4Q

Rated supply voltage armature 1)	V	3 Phase 460 (+10% / - 5%)		
Rated input current armature 2)	A	1000	1401	1455
Fan type	V	3 Phase 460V		
Air flow rate	ft ³ /min	824		
Fan noise level	dBA	88		
Rated supply voltage field	V	1 Phase 460 (+10%)		
Rated frequency	Hz	45 to 65 Hz self adapting (armature and field are independent)		
Rated DC voltage 2)	V	500		
Rated DC armature current	A	1180	1660	1680
Overload capability 60s 7)		150% of rated DC current		
Rated output @ 500 VDC	Hp	700	1000	1000
Rated output @ 240 VDC	Hp	350	500	500
Power loss at rated DC current (approximately)	W	5540	7590	7280
Rated DC voltage field	V	300		
Rated DC field current	A	40		85
Operational ambient temperature	°C	0 to 45 at I _{rated} fan-cooled 4)		
Storage and transport temperature	°C	- 25 to +70		
Installation altitude above sea level		≤ 1000 m at rated DC current 5)		
Control stability		Δn = 0.006% of the rated motor speed, valid for pulse encoder operation <u>and</u> digital setpoint Δn = 0.1% of the rated motor speed, valid for analog tachometer or analog setpoint 6)		
Degree of protection		Open Chassis (IP00)		
Dimensions		Refer to dimension drawings in Section 6		
Weights (approx.)	Lbs.	725	755	760

Notes:

- 1) Operation with reduced input voltage will result in reduced maximum output voltage accordingly.
- 2) Values apply for rated DC output current on both the armature and field circuits.
- 3) The specified output DC voltage can be guaranteed up to an undervoltage of 5% of rated line voltage.
- 4) The table below gives load values, (DC current), as a function of ambient temperature surrounding the Base Drive Panel, (refer to P077). **Note, Important:** When Base Drive Panels are installed into enclosures, make sure the temperature inside does not exceed 45°C, otherwise derate the DC current rating per the table below.

Ambient temperature	% reduction in base drive dc ampere rating	
	Self-cooled converters (15, 30, 60, 100 ADC)	Fan-cooled converters (140 - 1660 ADC)
+40°C	- 0 %	- 0 %
+45°C	- 0 %	- 0 %
+50°C	- 6 %	- 5 % a)
+55°C	- 11 %	- 5 % a)
+60°C	- 18 %	- 5 % a)

- a) Operation of fan cooled units at ambients above 50°C is not permitted because of limitations on the allowable fan operating temperature.

- 5) Load values, (DC current), as a function of installation altitude (refer to P077)

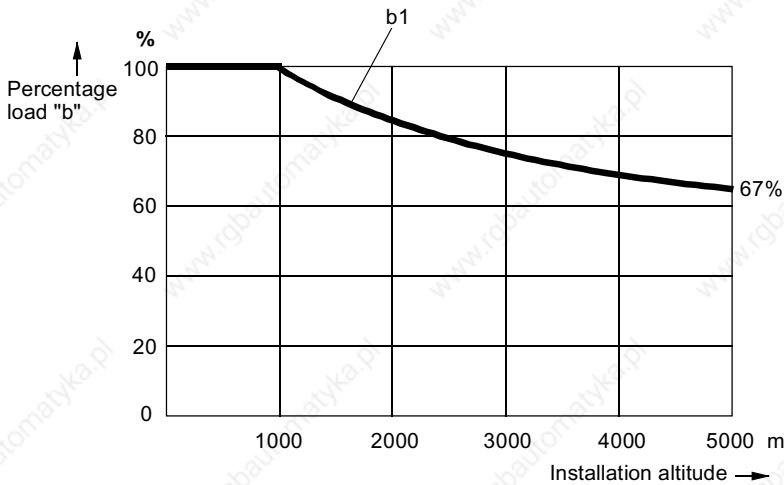

Curve b1: Reduction factor of load values, (DC current), at installation altitudes above 1000 m.

No derating of the supply voltages to any circuits is required up to an installation altitude of 5000 m for basic insulation.

6) Requirements to achieve control stability:

The control stability (closed-loop PI control) is referred to the rated motor speed and applies when the SIMOREG converter is warm. The following conditions are applicable:

- Temperature changes of ± 10 °C.
- Line voltage changes corresponding to +10% / – 5% of the rated input voltage.
- Temperature coefficient of temperature-compensated tachometer 0.15‰ per 10 °K, (applies only to analog tachometer).
- Constant setpoint (14-bit resolution).
- Motor, load, and encoder are correctly aligned and the load is balanced.

7) Details of overload capability:

Following operation at rated load, base drive panels are capable of carrying 150% of rated load for 1 minute, followed by a period of light load operation of such duration that the rms load does not exceed rated continuous current. Base Drive Panels are designed for operation with heatsink air inlet temperatures up to 45°C.

5.4 Applicable standards

UL508A

National Electrical Code 1999

NOTES:

6 Installation and Dimensions

6.1 Installation Information

SIMOREG Base Drive Panels are designed as chassis units intended to be mounted inside a protective enclosure or inside a control room. The units are to be mounted vertically in cubicles usually with the power connections at the top and the control connections at the bottom. A minimum 100-mm (4-inch) clearance must be kept above and below the converter in order to ensure unrestricted cooling airflow. The minimum enclosure size to be used is 23.6 by 23.6 by 86.6 inch high. The open chassis units are designed to operate in a 45°C ambient. When enclosed in a cubicle the ambient temperature outside the cubicle should not exceed 40°C, which then allows for a 5°C-temperature rise inside the cubicle. Care must be taken in the selection of the cubicle so that the internal temperature rise does not exceed 5°C. Refer to section 5 for approximate power loss data.

Note, Important: This equipment is designed and package-protected to handle the normal shock and vibration typically encountered in shipment. **Do not install these Base Drive Panels on equipment subject to shock or vibration. Select a reasonably clean location for installation, free from corrosive or conductive materials or fumes.**



CAUTION

Failure to lift the Base Drive Panel in the correct manner can result in bodily injury and/or property damage.

The Base Drive Panel must be lifted using suitable equipment and under the instruction of appropriately qualified personnel.

The user is responsible for installing the Base Drive Panel, motor, transformer as well as other equipment according to safety regulations (e.g. NEC), as well as all other relevant national or local regulations regarding cable sizing and protection, grounding, disconnects, overcurrent protection, etc.



The Base Drive Panels must be installed in accordance with the relevant safety regulations (e.g. NEC), as well as all other relevant national and local regulations. It must be ensured that the grounding, cable sizing and appropriate short-circuit protection have been implemented to guarantee operational safety and reliability.

Note, Important: Base Drive Panels have high-speed semiconductor fuses installed for protection of the thyristors in the event high fault currents are encountered. These fuses are “special purpose” fuses, and do not meet the requirements of the NEC for short-circuit protection in motor branch circuits. It is necessary to provide other devices for short-circuit protection. Typically molded case circuit breakers or NEC style fuses are used for this purpose. Refer to applicable sections of the NEC for additional information.



NOTE



The fundamental principles of EMC in Section 6.1 of SIMOREG 6RA70 DC Master operating instructions (Order # 6RX1700-0AD76) must be adhered to when installing any unit.

6.2 Base Drive Panel Outlines:

Dimensions are mm (inches)

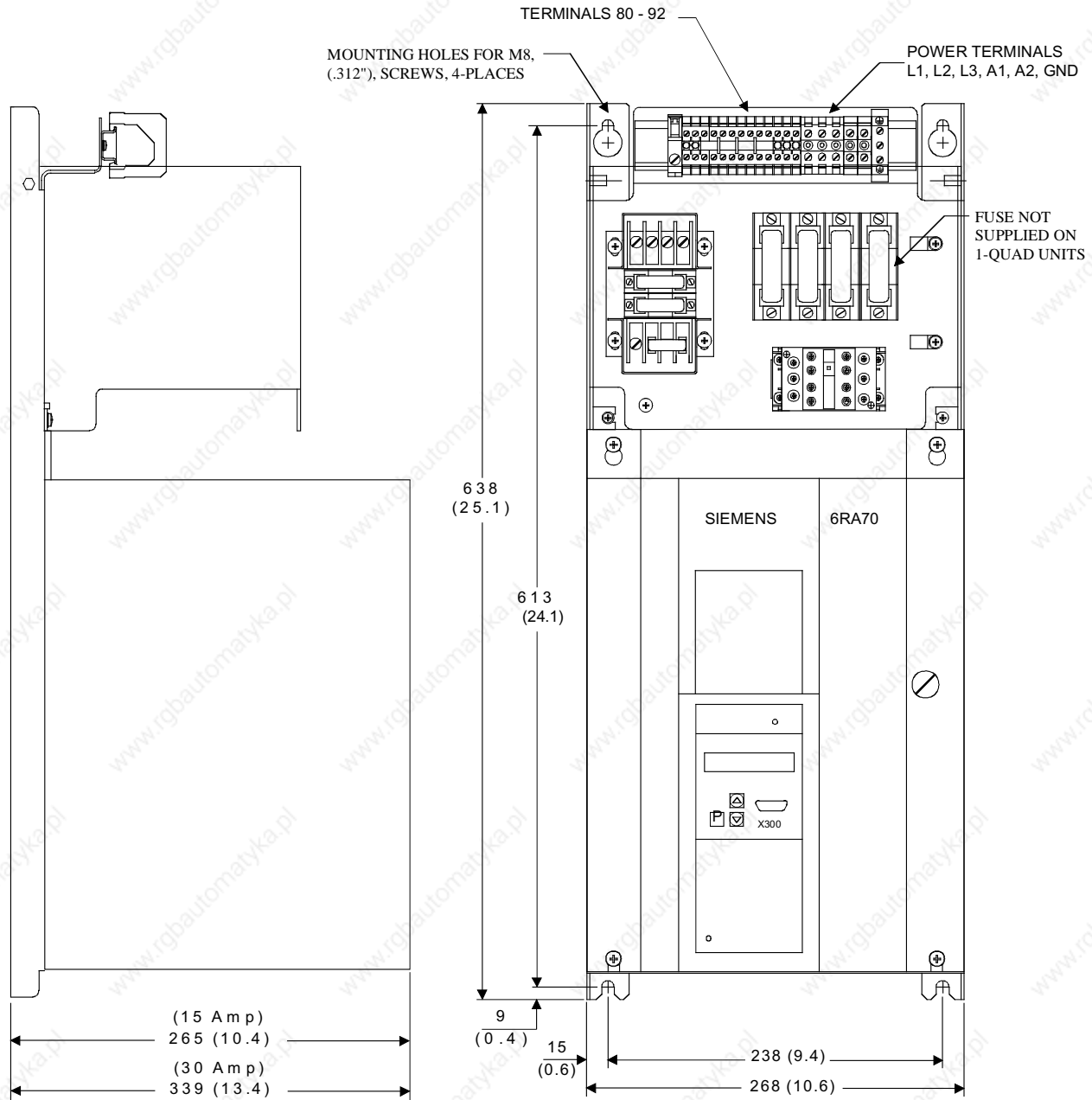

NOTE, IMPORTANT: ALLOW AT LEAST 100 MILLIMETERS, (4"), OF CLEARANCE ABOVE AND BELOW THE UNIT TO ENSURE UNRESTRICTED AIR FLOW. ADDITIONAL CLEARANCE MAY BE REQUIRED TO ALLOW FOR WIRE OR CABLE ENTRY/EXIT AND BENDING. REFER TO APPLICABLE CODES FOR FURTHER INFORMATION.

15 - 30 AMP BASE DRIVE PANELS, (1 & 4Q)

Dimensions are mm (inches)

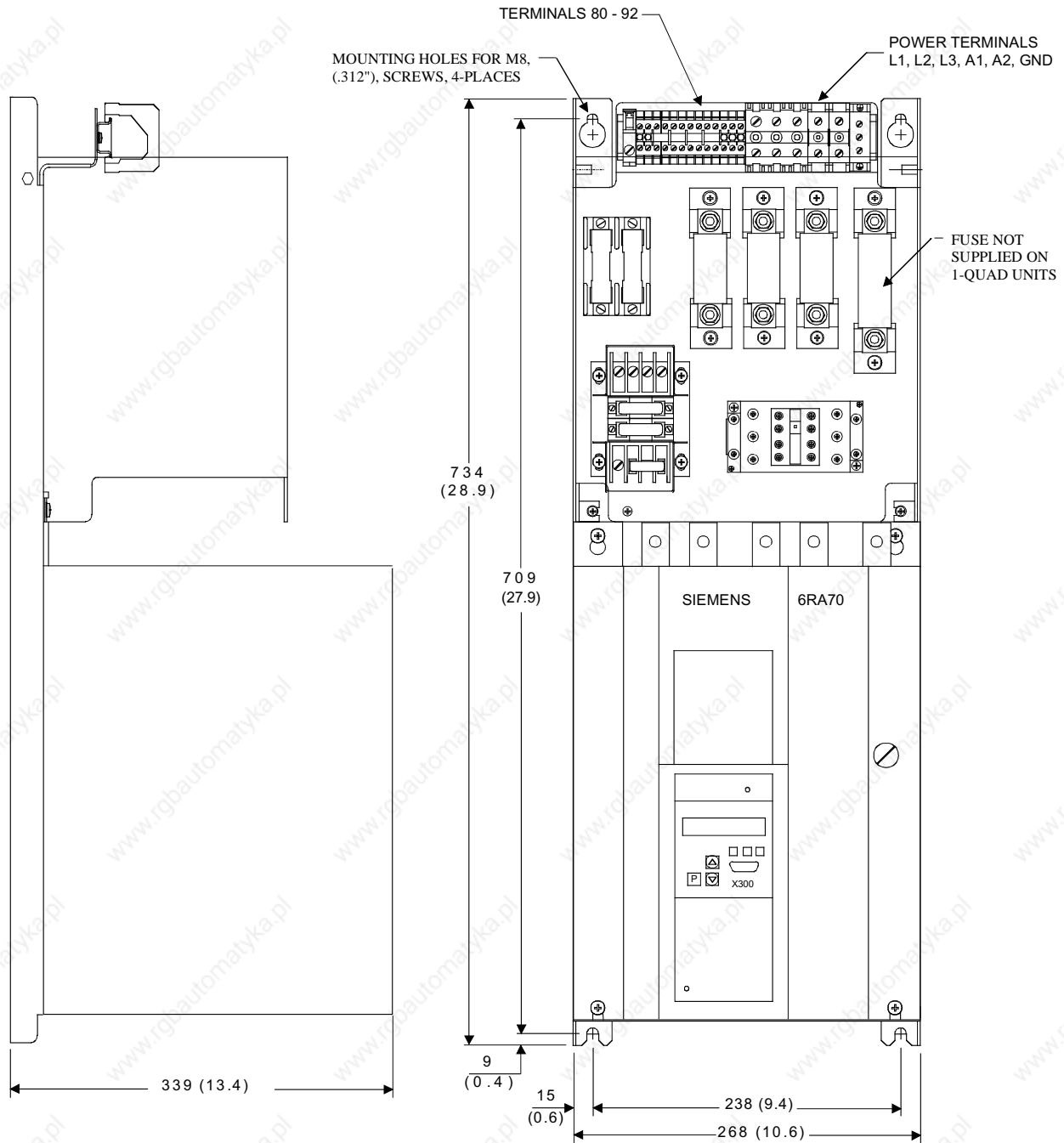

NOTE, IMPORTANT: ALLOW AT LEAST 100 MILLIMETERS, (4"), OF CLEARANCE ABOVE AND BELOW THE UNIT TO ENSURE UNRESTRICTED AIR FLOW. ADDITIONAL CLEARANCE MAY BE REQUIRED TO ALLOW FOR WIRE OR CABLE ENTRY/EXIT AND BENDING. REFER TO APPLICABLE CODES FOR FURTHER INFORMATION.

60 AMP BASE DRIVE PANEL, (1 & 4Q)

Dimensions are mm (inches)

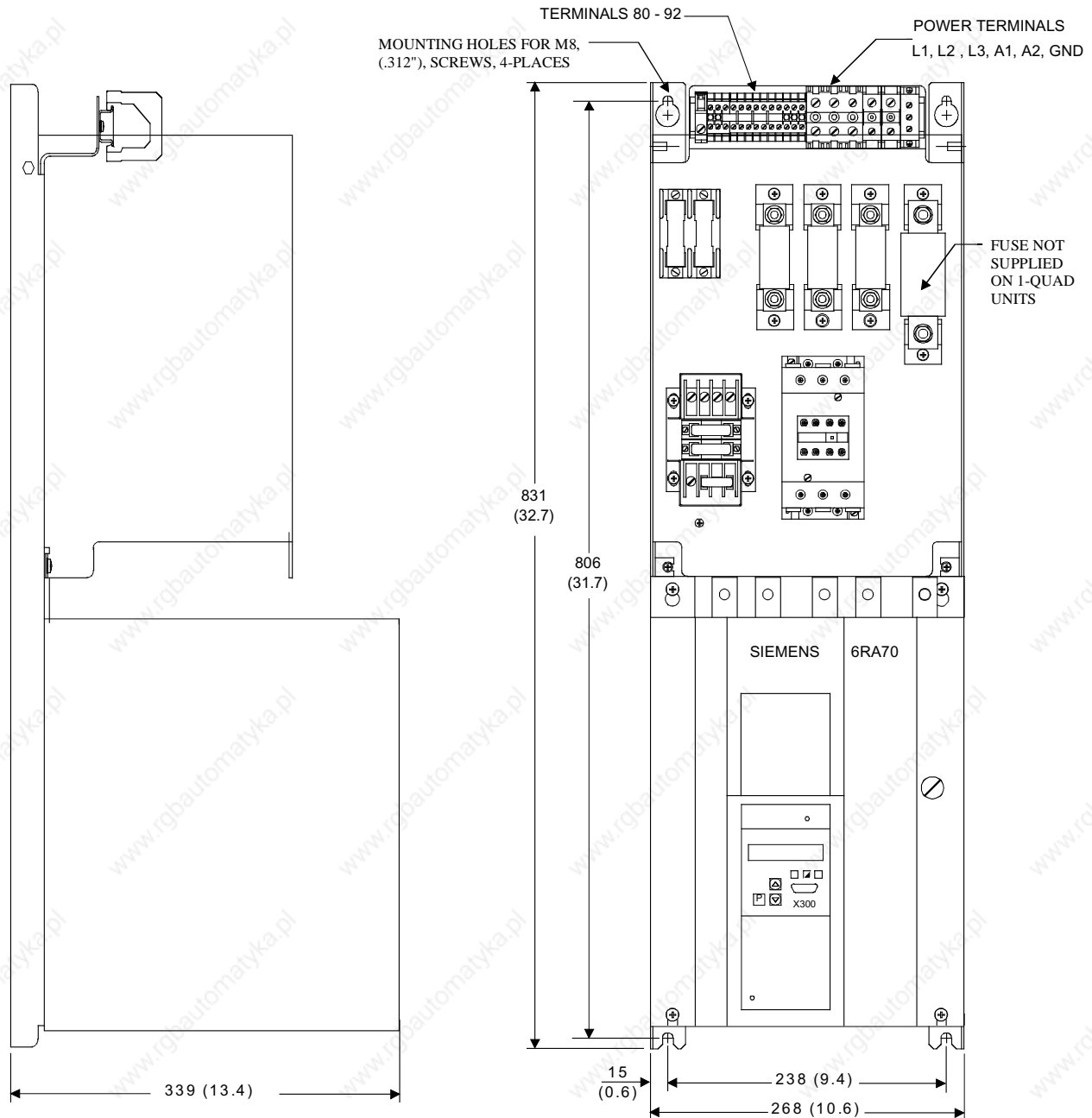

NOTE, IMPORTANT: ALLOW AT LEAST 100 MILLIMETERS, (4"), OF CLEARANCE ABOVE AND BELOW THE UNIT TO ENSURE UNRESTRICTED AIR FLOW. ADDITIONAL CLEARANCE MAY BE REQUIRED TO ALLOW FOR WIRE OR CABLE ENTRY/EXIT AND BENDING. REFER TO APPLICABLE CODES FOR FURTHER INFORMATION.

100 AMP BASE DRIVE PANEL, (1 & 4Q)

Dimensions are mm (inches)

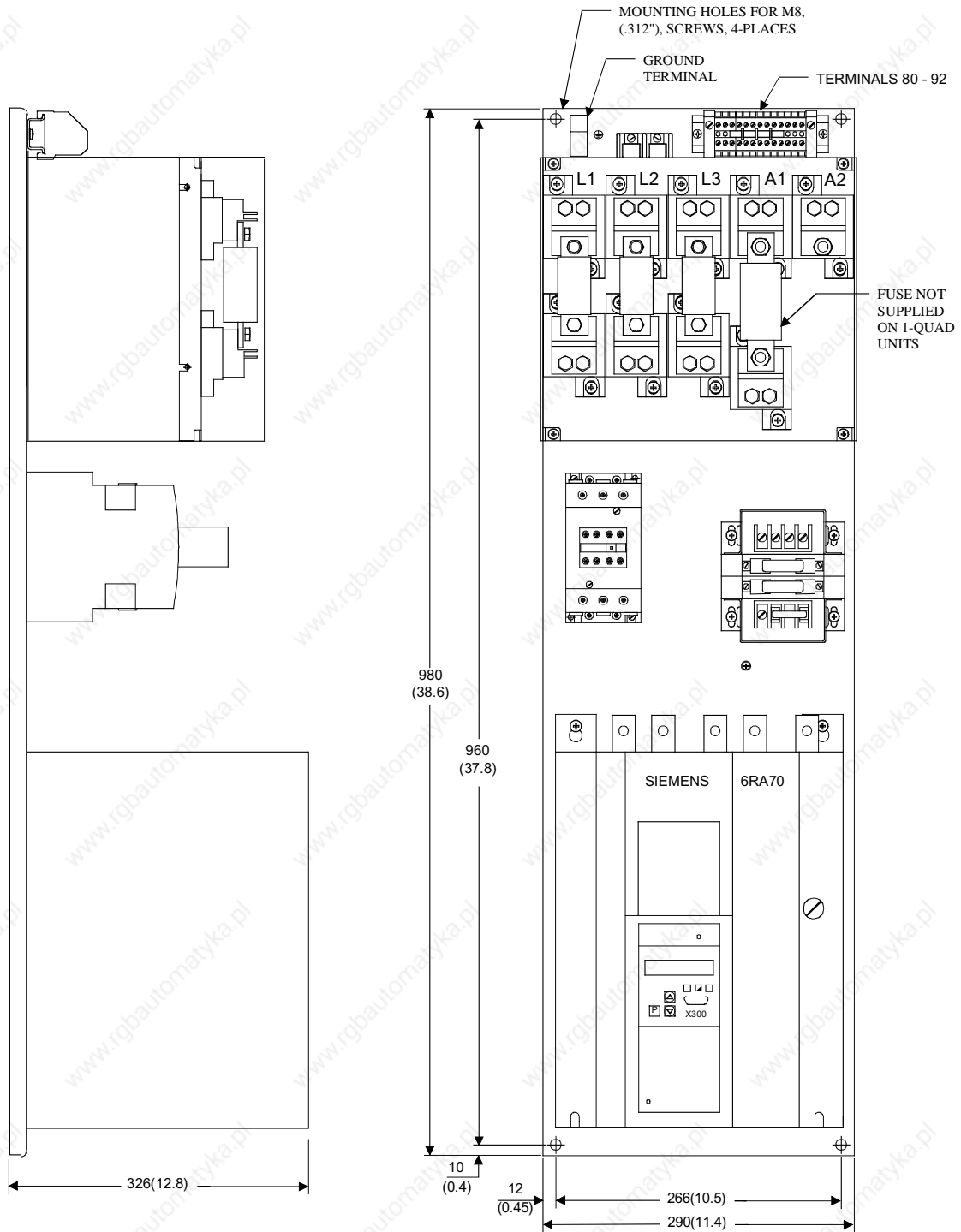

NOTE, IMPORTANT: ALLOW AT LEAST 100 MILLIMETERS, (4"), OF CLEARANCE ABOVE AND BELOW THE UNIT TO ENSURE UNRESTRICTED AIR FLOW. ADDITIONAL CLEARANCE MAY BE REQUIRED TO ALLOW FOR WIRE OR CABLE ENTRY/EXIT AND BENDING. REFER TO APPLICABLE CODES FOR FURTHER INFORMATION.

140 AMP BASE DRIVE PANEL, (1 & 4Q)

Dimensions are mm (inches)

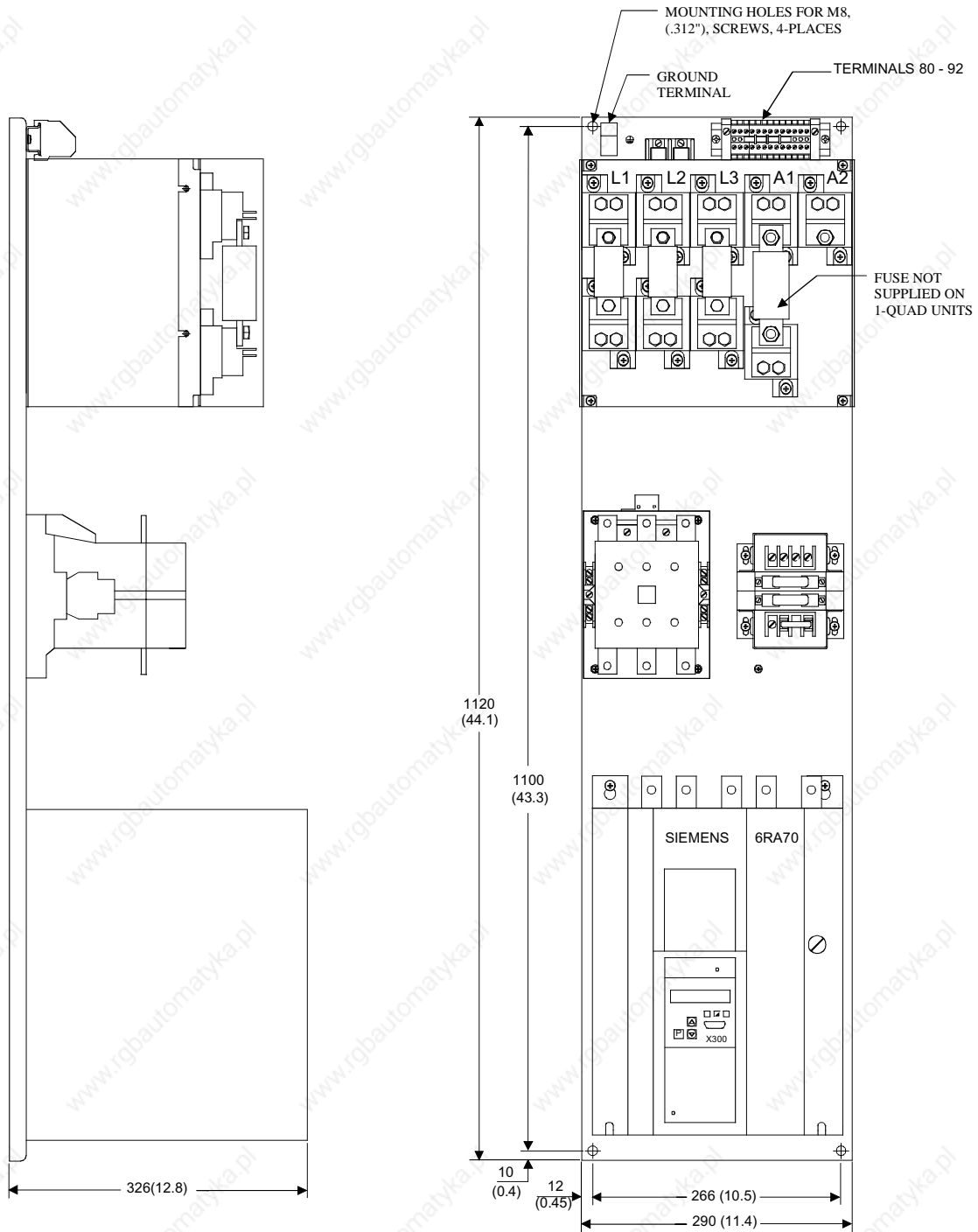

NOTE, IMPORTANT: ALLOW AT LEAST 100 MILLIMETERS, (4"), OF CLEARANCE ABOVE AND BELOW THE UNIT TO ENSURE UNRESTRICTED AIR FLOW. ADDITIONAL CLEARANCE MAY BE REQUIRED TO ALLOW FOR WIRE OR CABLE ENTRY/EXIT AND BENDING. REFER TO APPLICABLE CODES FOR FURTHER INFORMATION.

210 AMP BASE DRIVE PANEL, (1 & 4Q)

Dimensions are mm (inches)

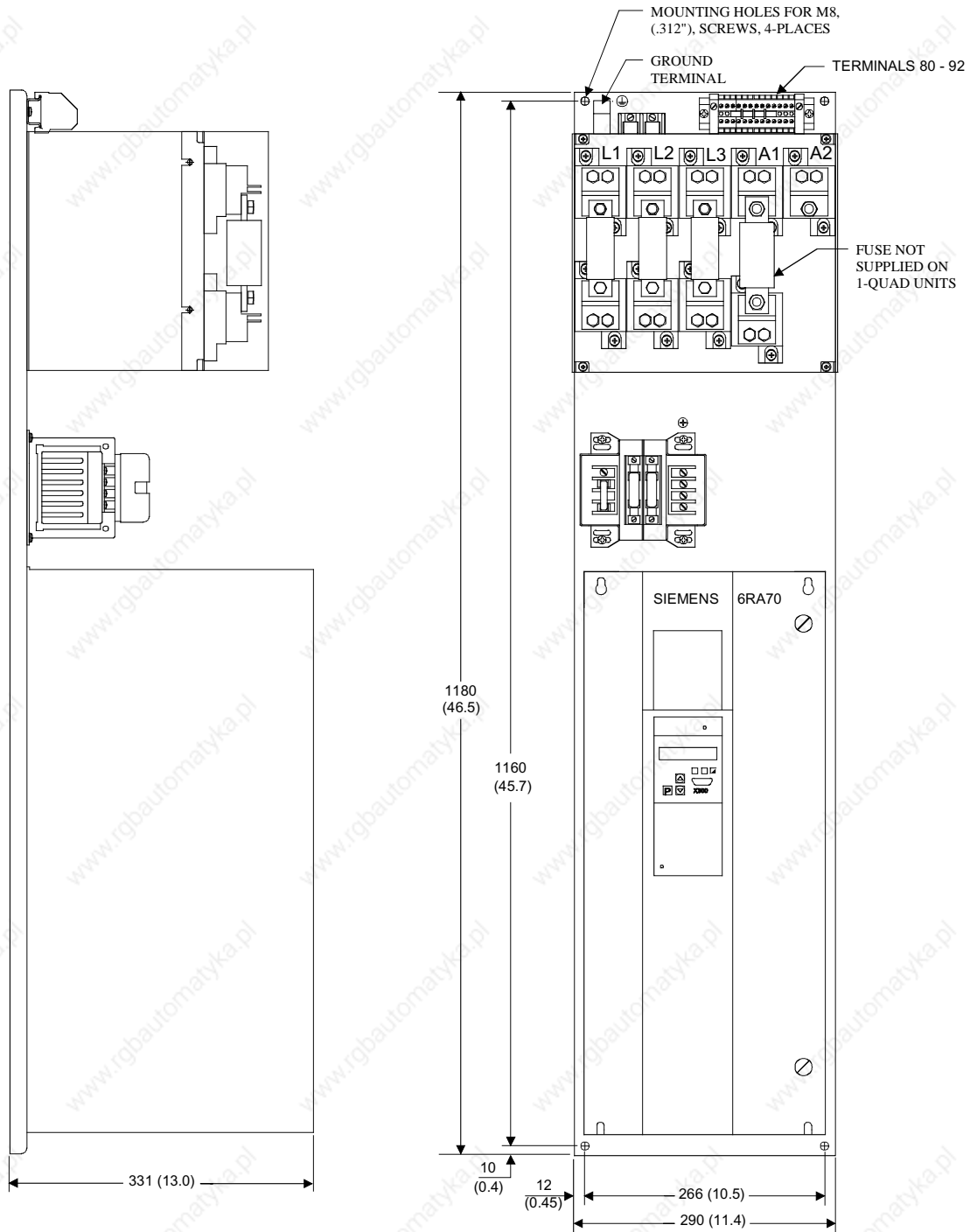

NOTE, IMPORTANT: ALLOW AT LEAST 100 MILLIMETERS, (4"), OF CLEARANCE ABOVE AND BELOW THE UNIT TO ENSURE UNRESTRICTED AIR FLOW. ADDITIONAL CLEARANCE MAY BE REQUIRED TO ALLOW FOR WIRE OR CABLE ENTRY/EXIT AND BENDING. REFER TO APPLICABLE CODES FOR FURTHER INFORMATION.

255 AMP BASE DRIVE PANEL, (1 & 4Q)

Dimensions are mm (inches)

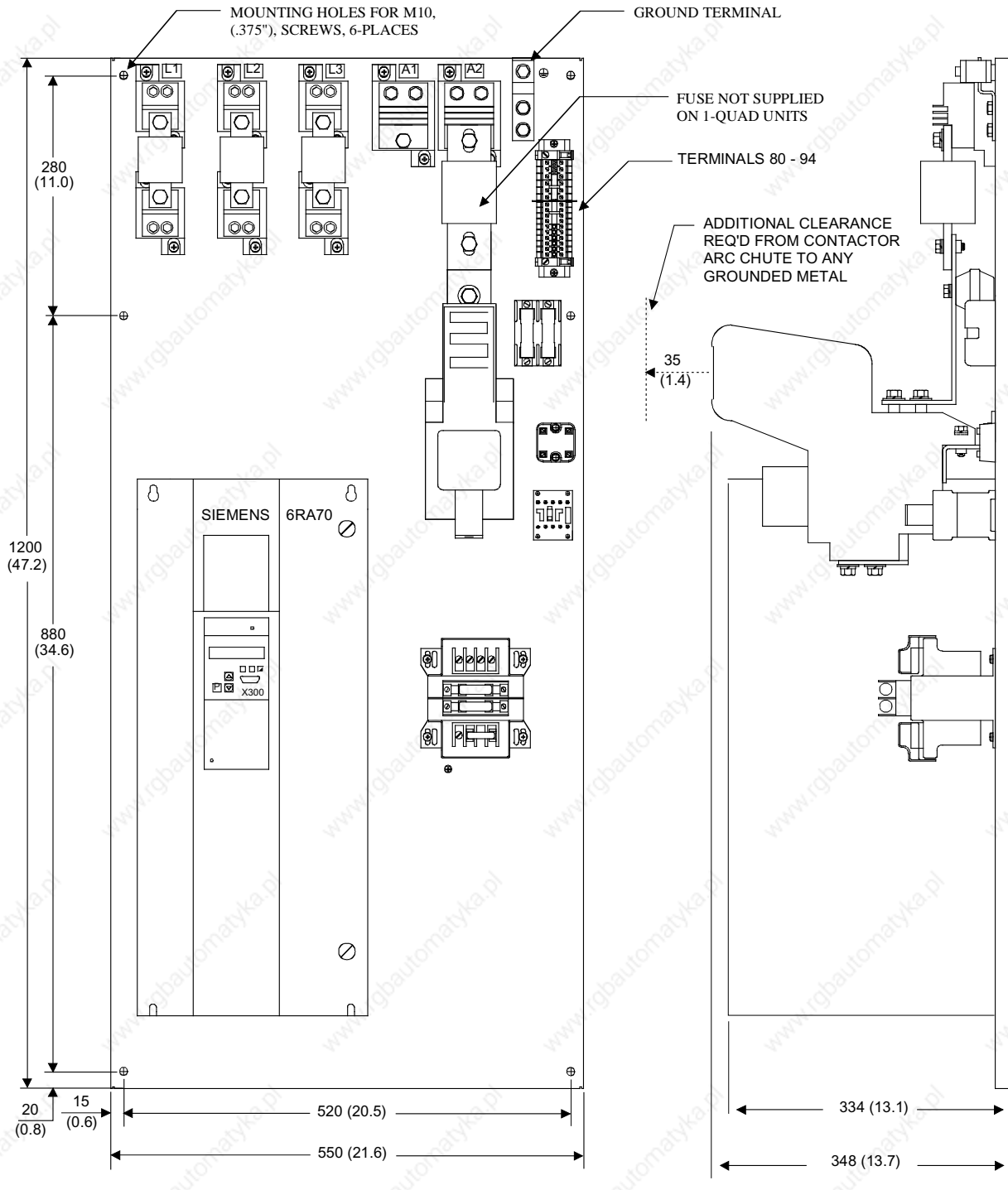

430 AMP BASE DRIVE PANEL, (1 & 4Q)

Dimensions are mm (inches)

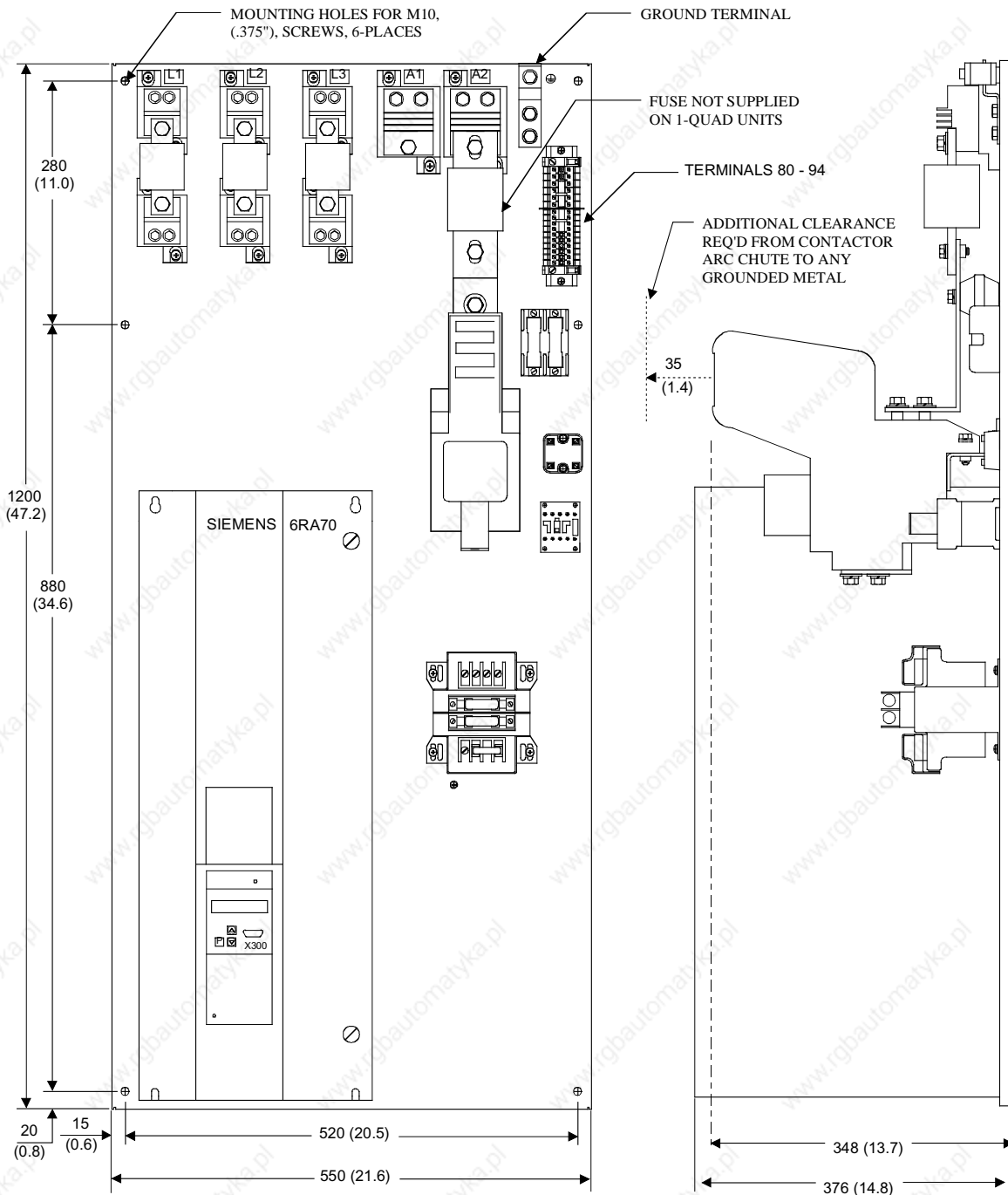

NOTE, IMPORTANT: ALLOW AT LEAST 100 MILLIMETERS, (4"), OF CLEARANCE ABOVE AND BELOW THE UNIT TO ENSURE UNRESTRICTED AIR FLOW. ADDITIONAL CLEARANCE MAY BE REQUIRED TO ALLOW FOR WIRE OR CABLE ENTRY/EXIT AND BENDING. REFER TO APPLICABLE CODES FOR FURTHER INFORMATION.

510 AMP BASE DRIVE PANEL, (1 & 4Q)

Dimensions are mm (inches)

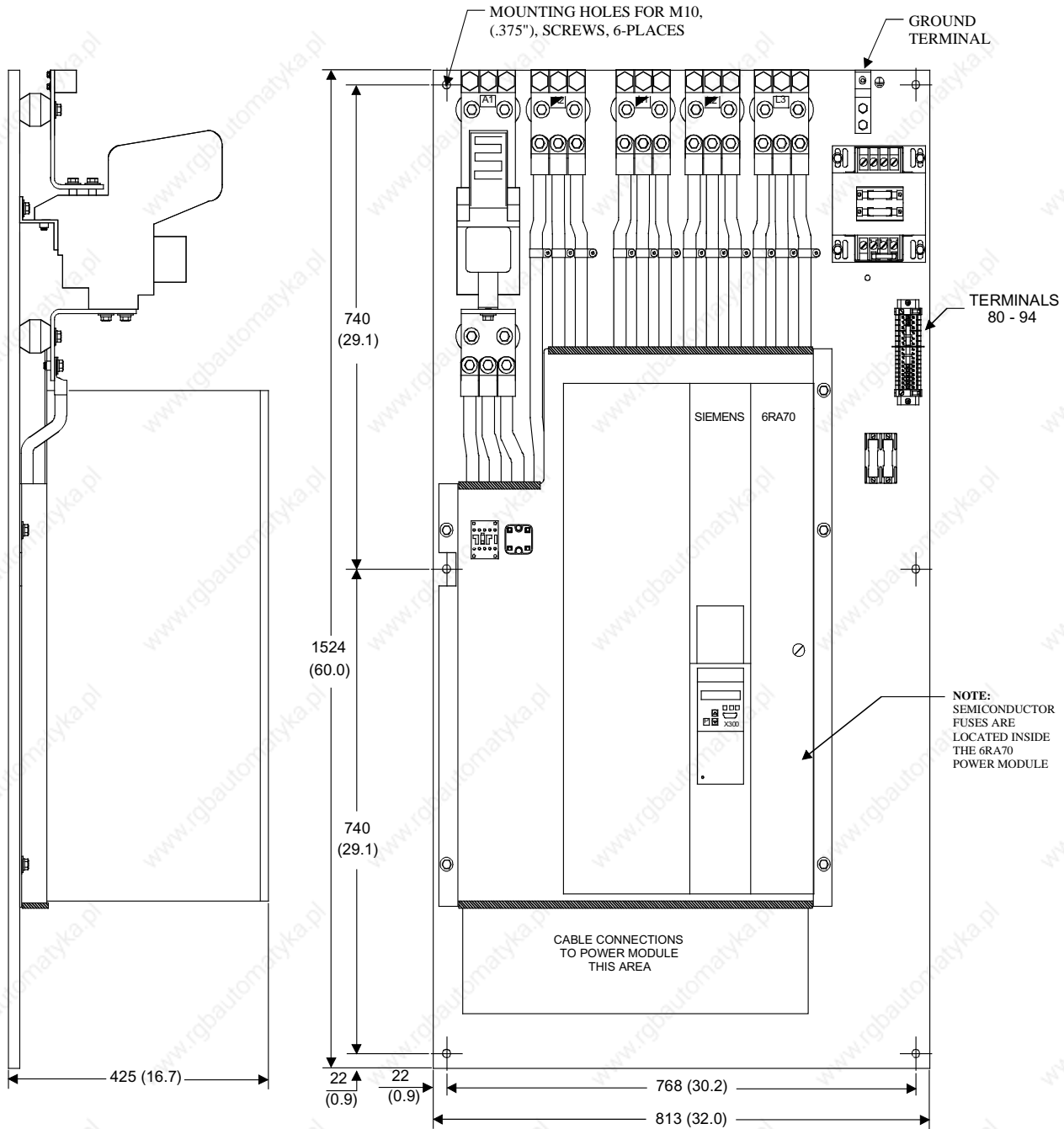

850 AMP BASE DRIVE PANEL, (1 & 4Q)

Dimensions are mm (inches)

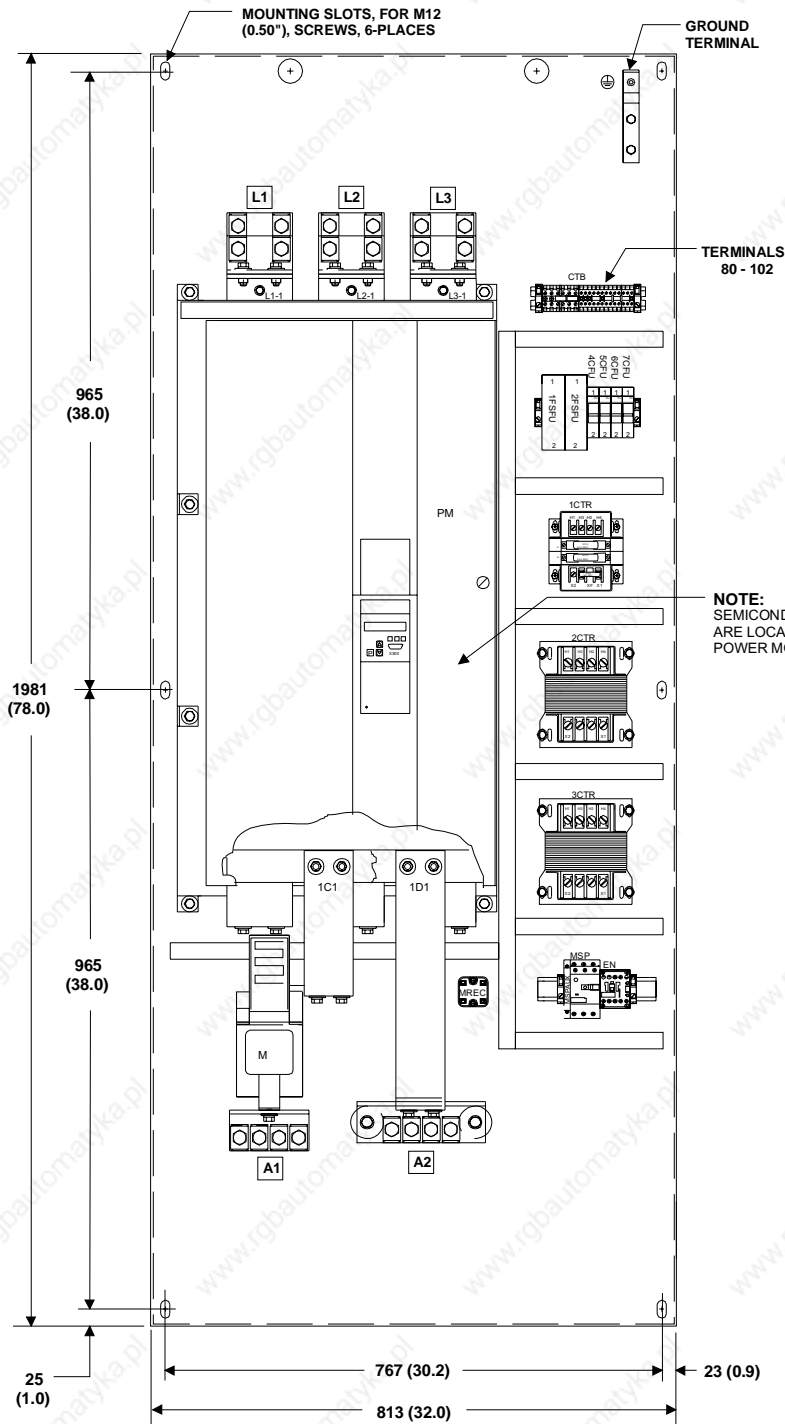

NOTE: FROM THE BACK OF THE MOUNTING PANEL TO THE TOP OF THE POWER MODULE, (TALLEST COMPONENT) = 629 (24.8")

1180 AMP BASE DRIVE PANEL, (1 & 4Q)

Dimensions are mm (inches)

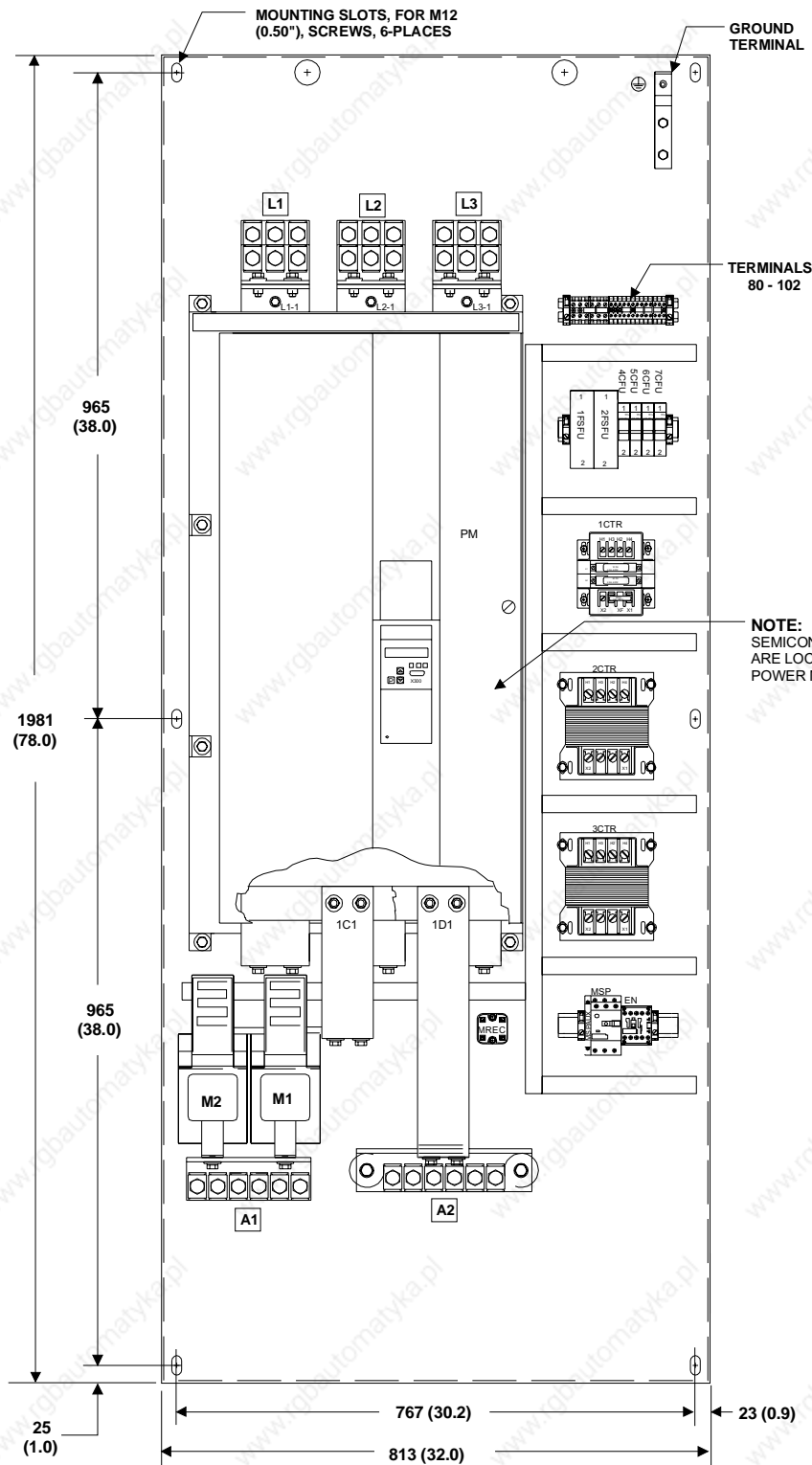

NOTE: FROM THE BACK OF THE MOUNTING PANEL TO THE TOP OF THE POWER MODULE, (TALLEST COMPONENT) = 629 (24.8")

1660 AMP BASE DRIVE PANEL, (1 & 4Q)

Dimensions are mm (inches)

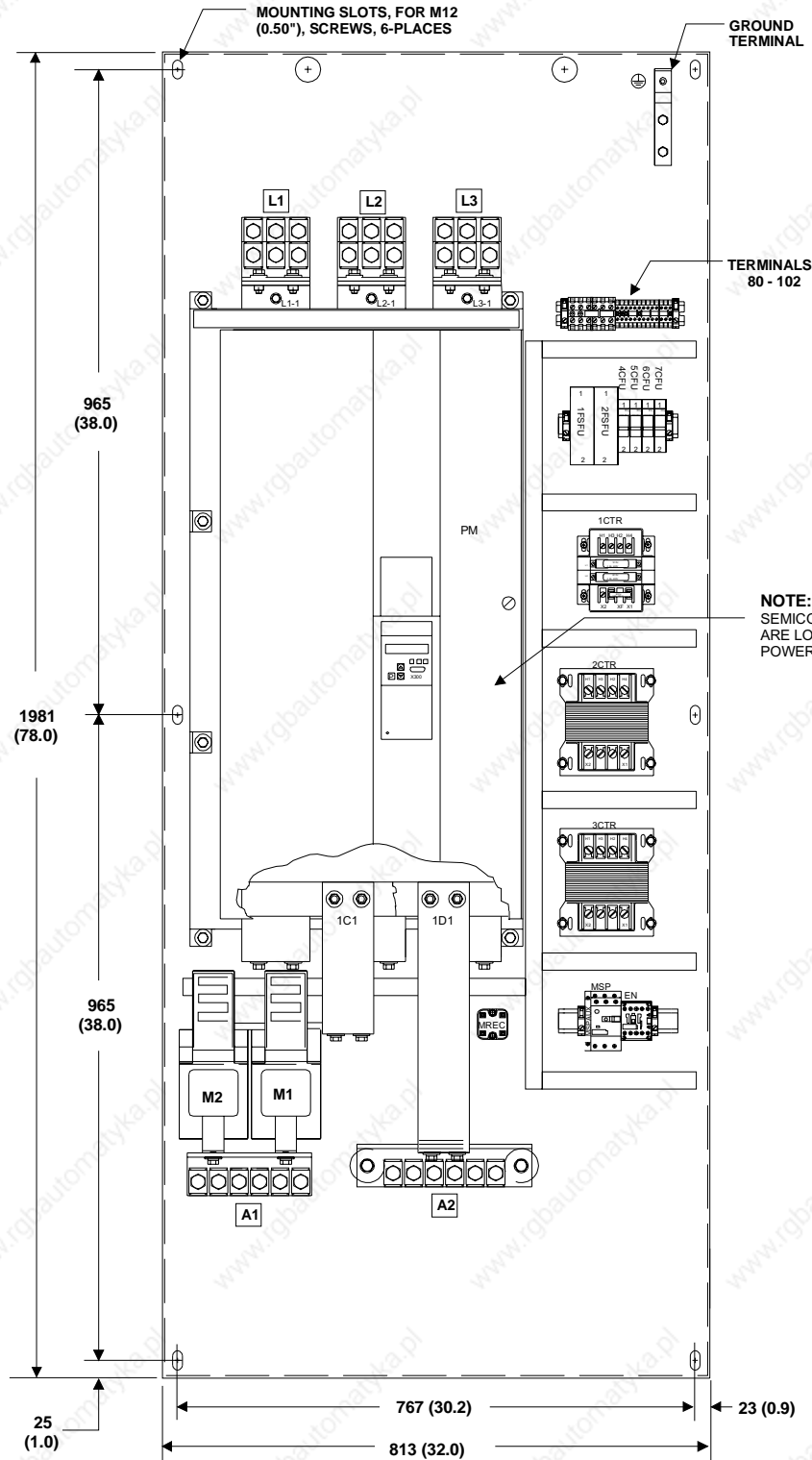

NOTE:
SEMICONDUCTOR FUSES
ARE LOCATED INSIDE THE
POWER MODULE, (PM).

NOTE: FROM THE BACK OF THE MOUNTING PANEL TO THE TOP OF THE POWER MODULE, (TALLEST COMPONENT) = 629 (24.8")

1680 AMP BASE DRIVE PANEL, (1 & 4Q)

NOTES:

7 Base Drive Panel Connections



WARNING

Base Drive Panels are operated at high voltages.

Disconnect the power supply before making any connections!

Only qualified personnel who are thoroughly familiar with all safety notices contained in the operating instructions as well as erection, installation, operating and maintenance instructions should be allowed to work on these devices.

Non-observance of the safety instructions can result in death, severe personal injury or substantial property damage.

Failure to make the correct connections may result in irreparable damage to the unit.

Voltage may be present at the power and control terminals even when the motor is stopped.



The snubber capacitors may still carry a hazardous voltage for up to 2 minutes after disconnection. For this reason, wait for at least 2 minutes before opening the converter.

When working on the open converter, remember that live parts are exposed. The unit must always be operated with the standard front covers in place.

The user is responsible for ensuring that the motor, SIMOREG Base Drive Panel and other devices are installed and connected up in accordance with the approved codes of practice of the country concerned and any other regional or local codes that may apply. Special attention must be paid to proper conductor sizing, fusing, grounding, isolation and disconnection measures and to overcurrent protection.

These units contain hazardous rotating machinery (fans) and control rotating mechanical components (motors). Death, serious bodily injury or substantial property damage may occur if the instructions in the relevant operating manuals are not observed.

The successful and safe operation of this equipment is dependent on careful transportation, proper storage and installation as well as correct operation and maintenance.

7.1 Base Drive Panel Schematics

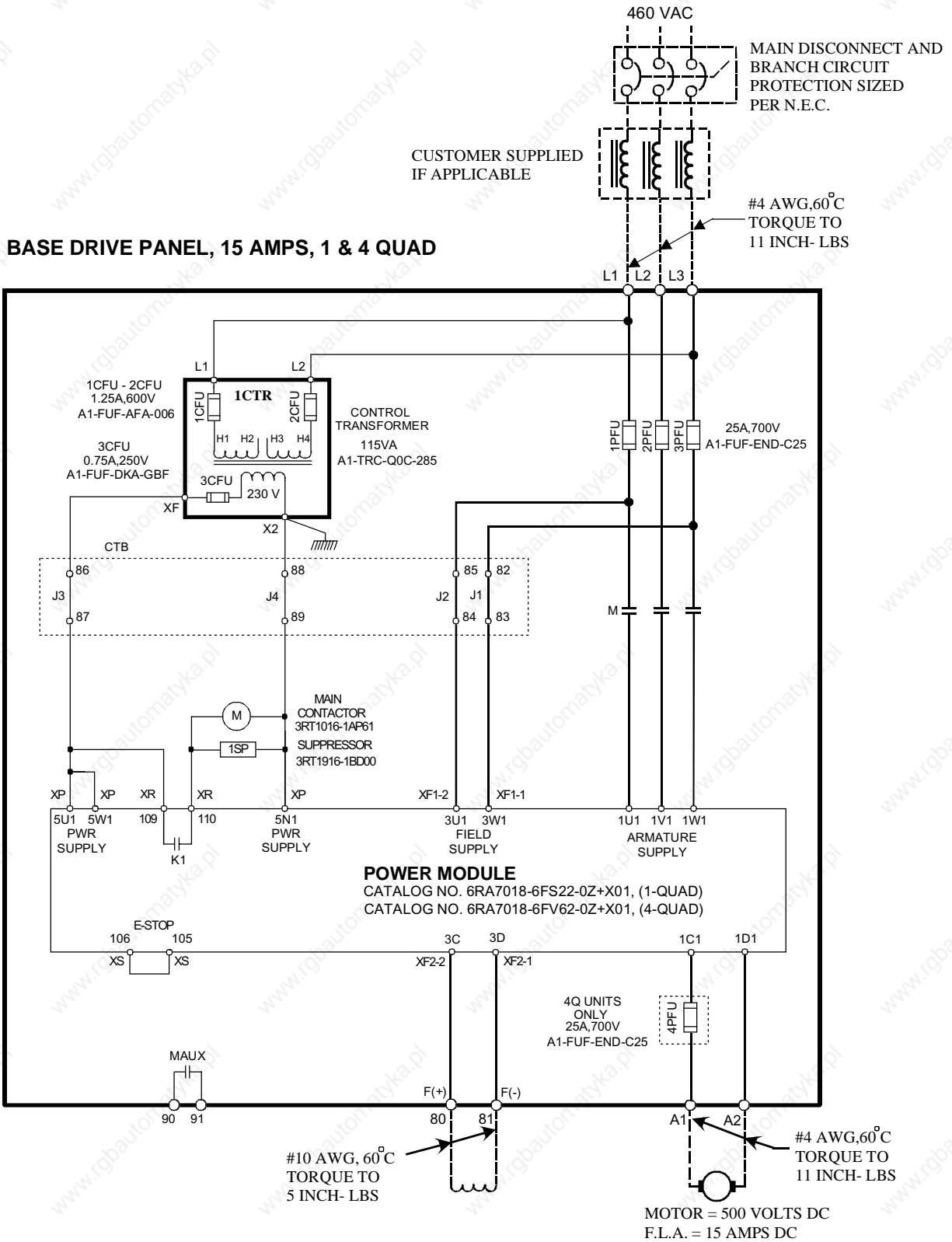

BASE DRIVE PANEL, 30 AMPS, 1 & 4 QUAD

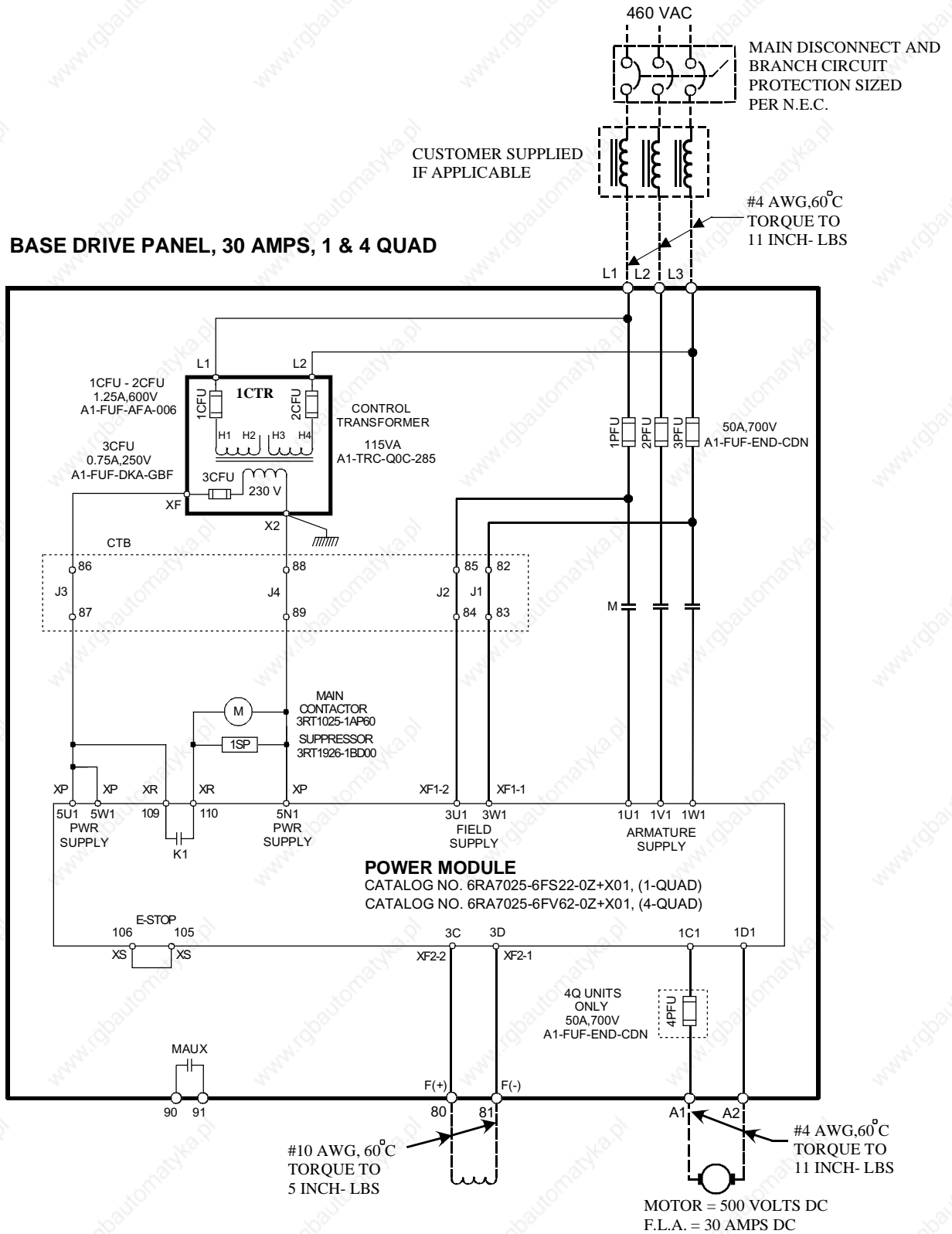

BASE DRIVE PANEL, 60 AMPS, 1 & 4 QUAD

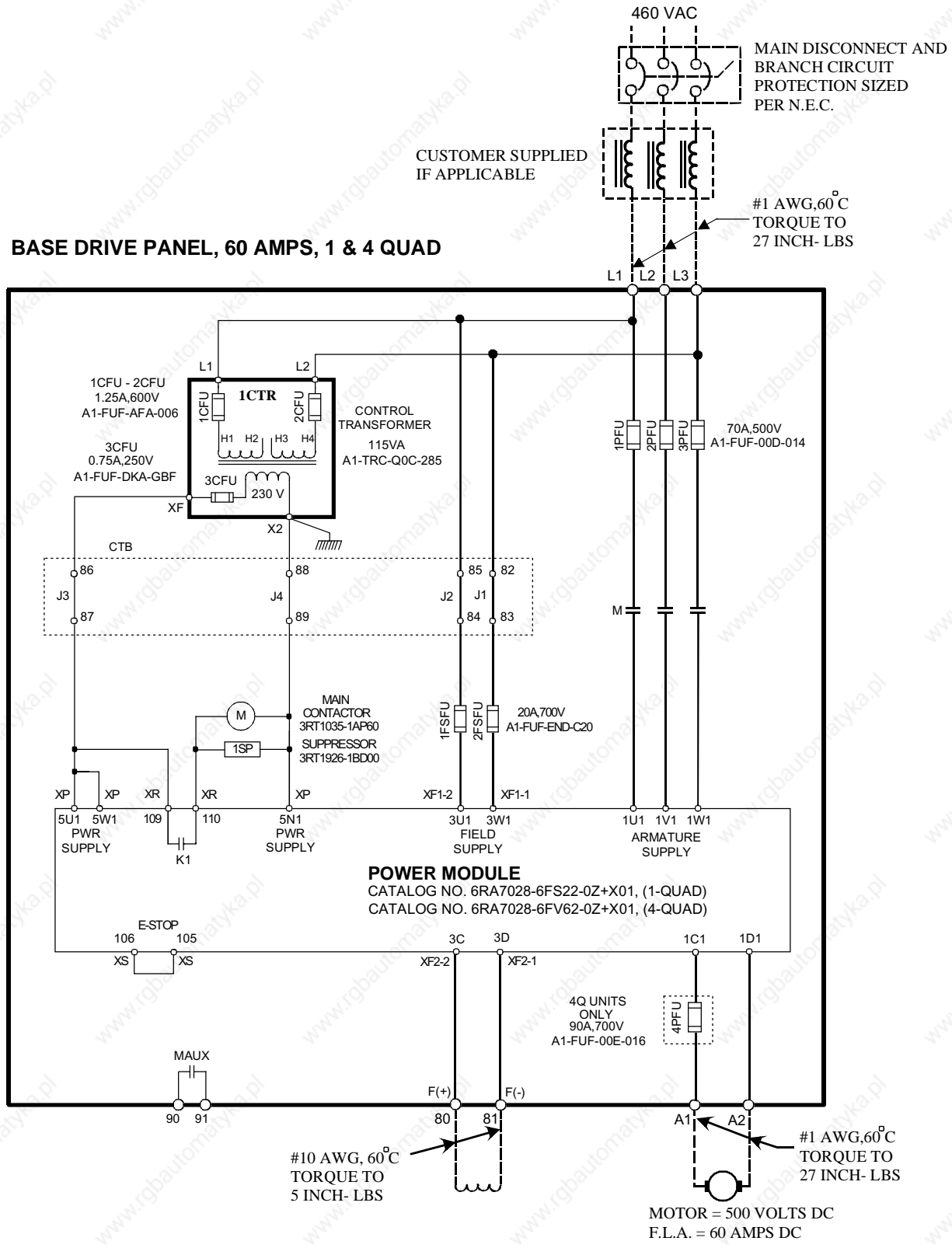

BASE DRIVE PANEL, 100 AMPS, 1 & 4 QUAD

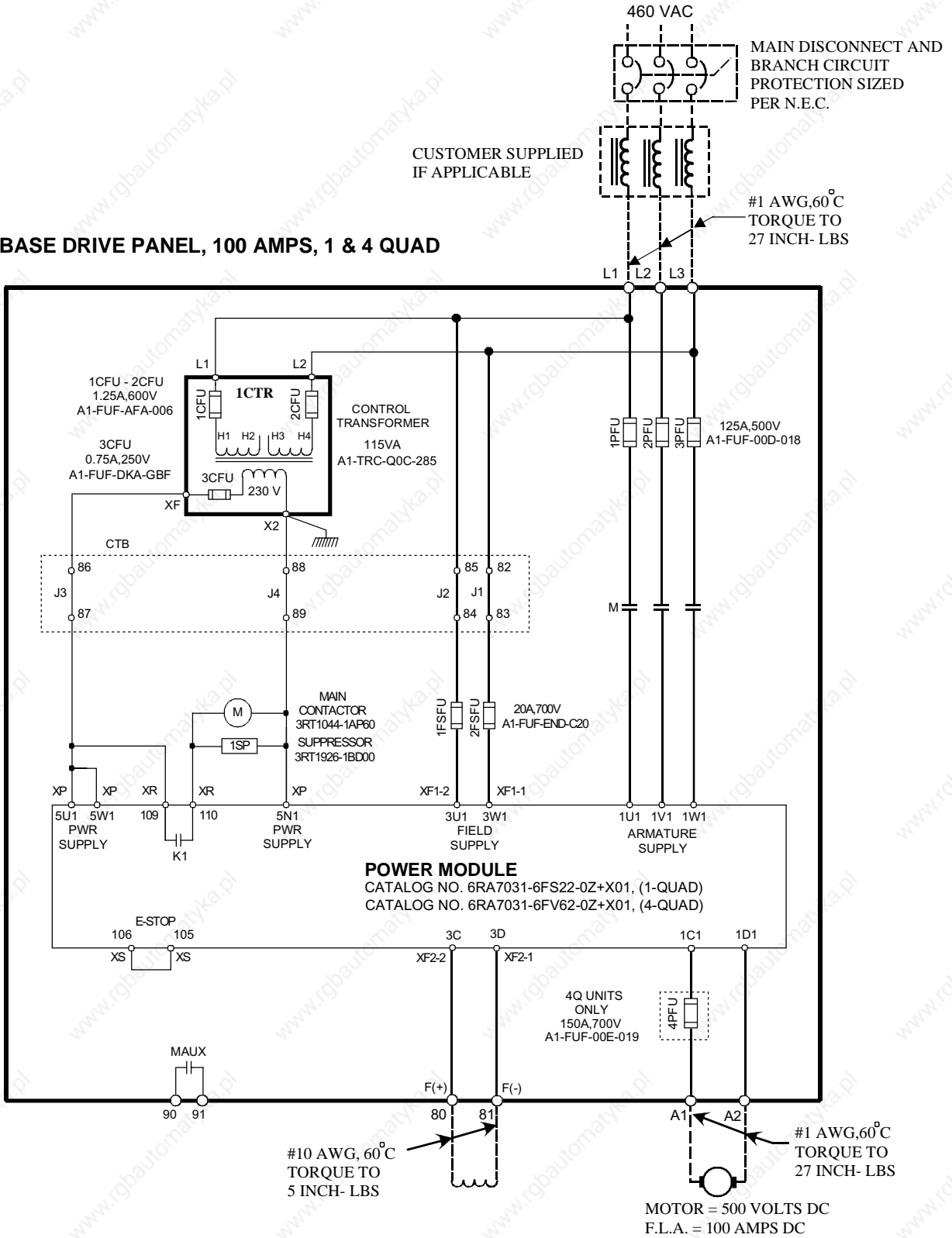

BASE DRIVE PANEL, 210 AMPS, 1 & 4 QUAD

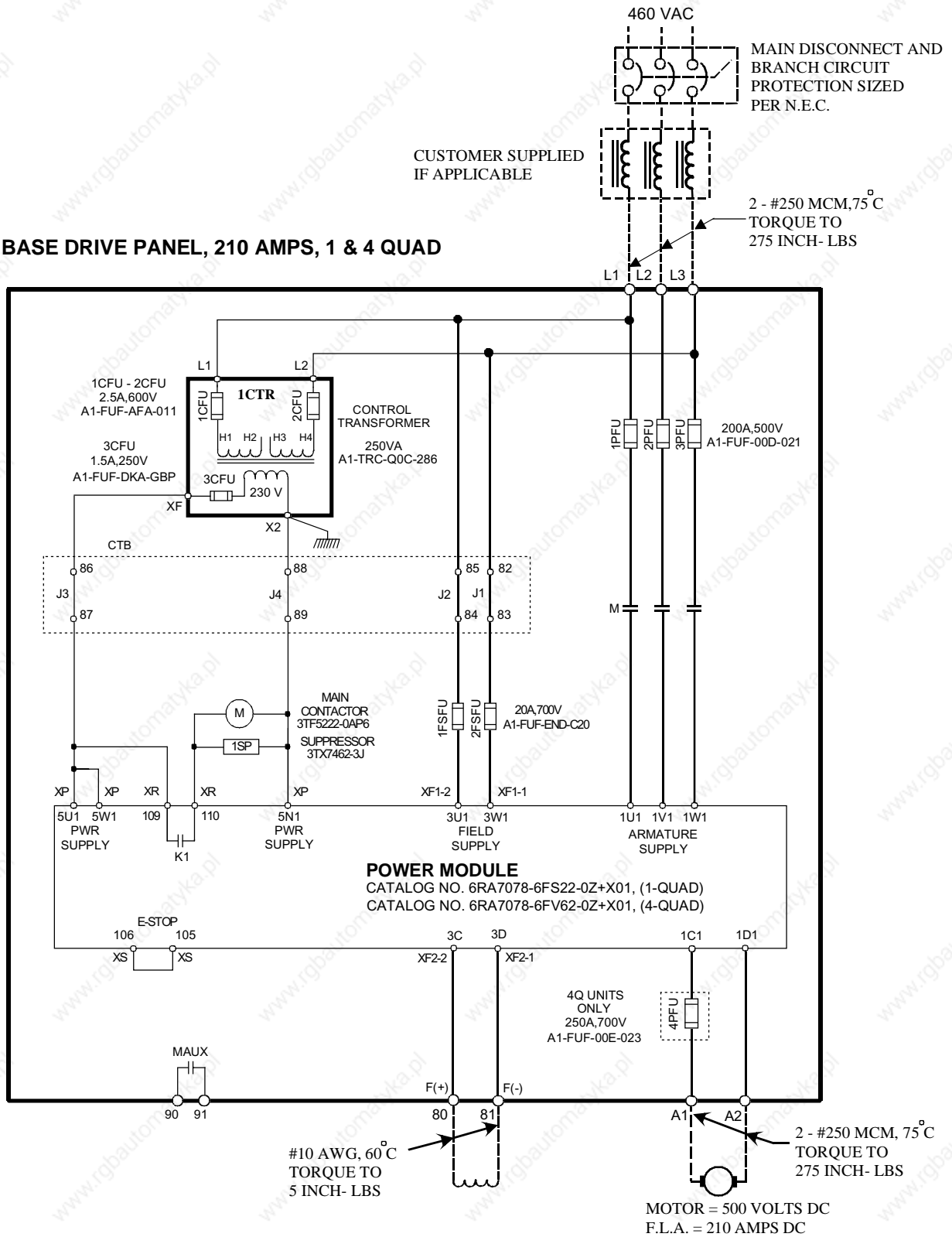

BASE DRIVE PANEL, 255 AMPS, 1 & 4 QUAD

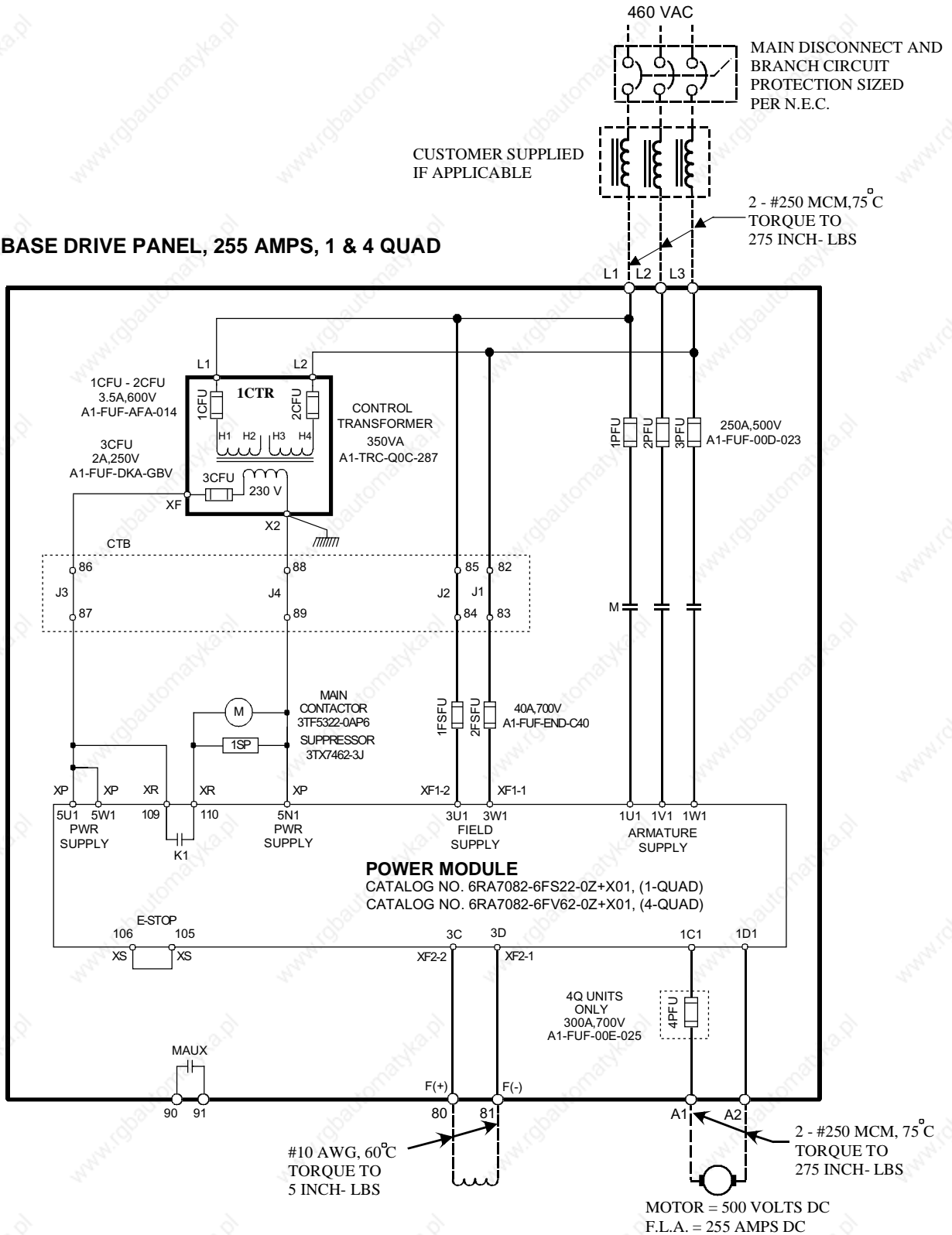

BASE DRIVE PANEL, 430 AMPS, 1 & 4 QUAD

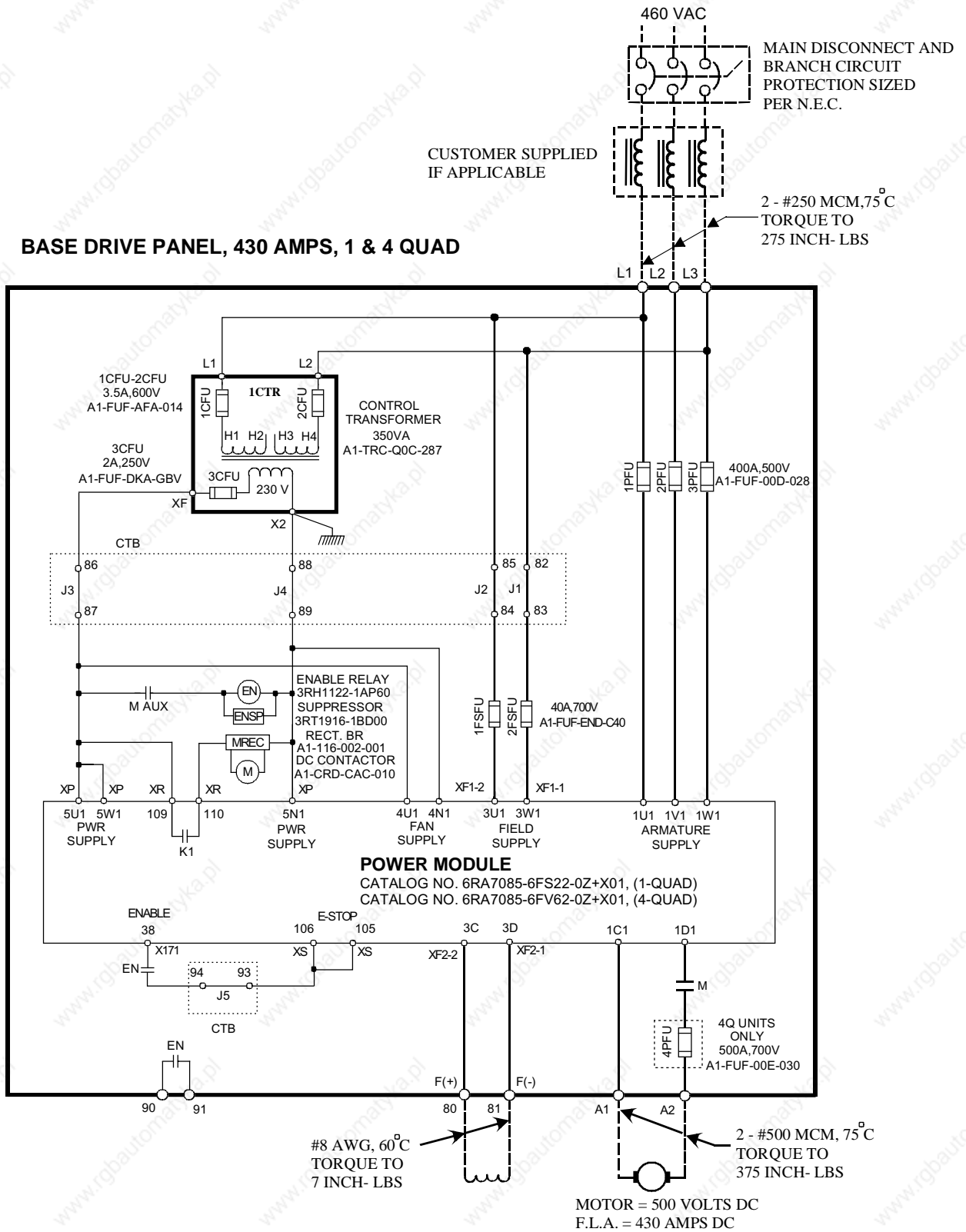

BASE DRIVE PANEL, 510 AMPS, 1 & 4 QUAD

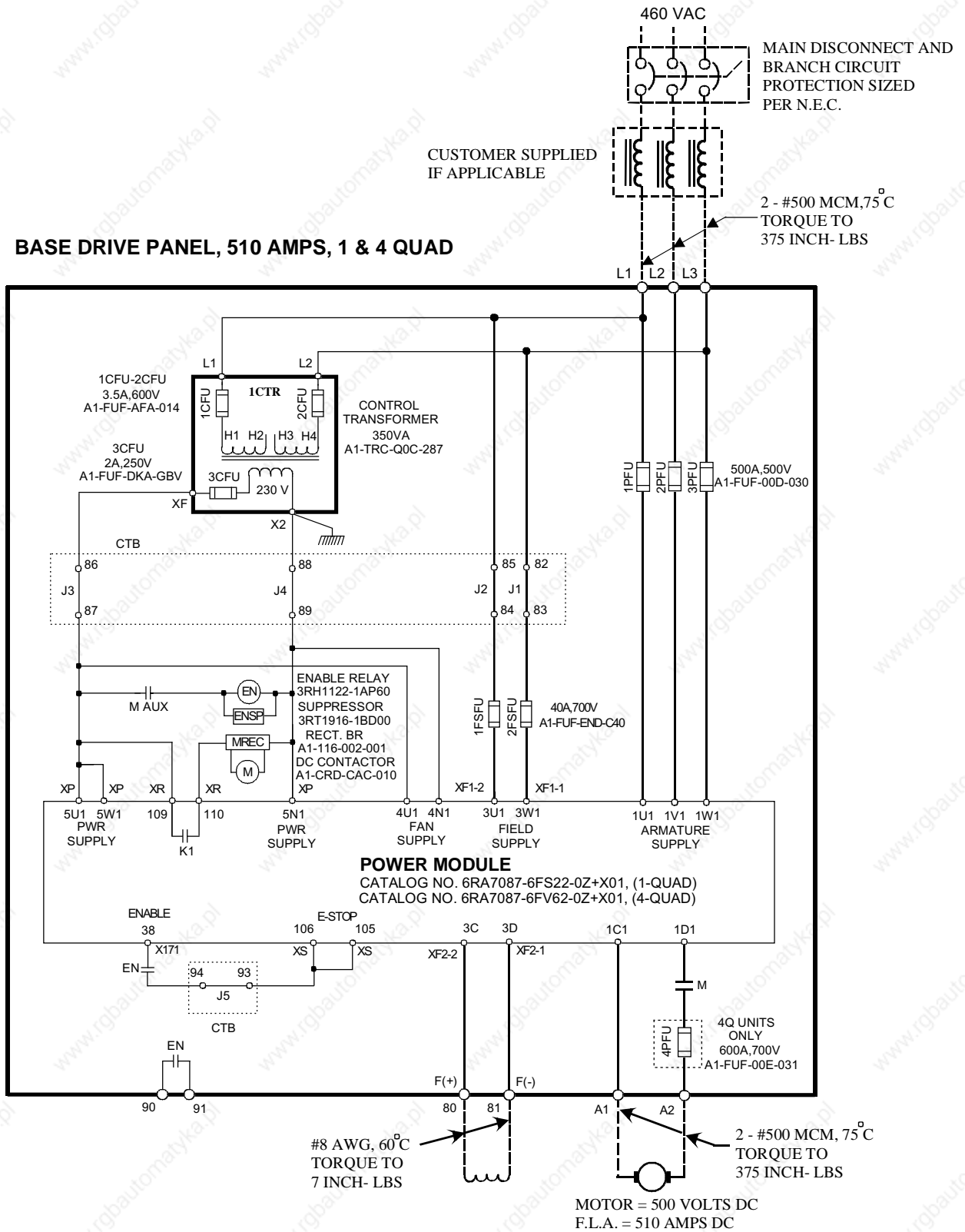

BASE DRIVE PANEL, 850 AMPS, 1 & 4 QUAD

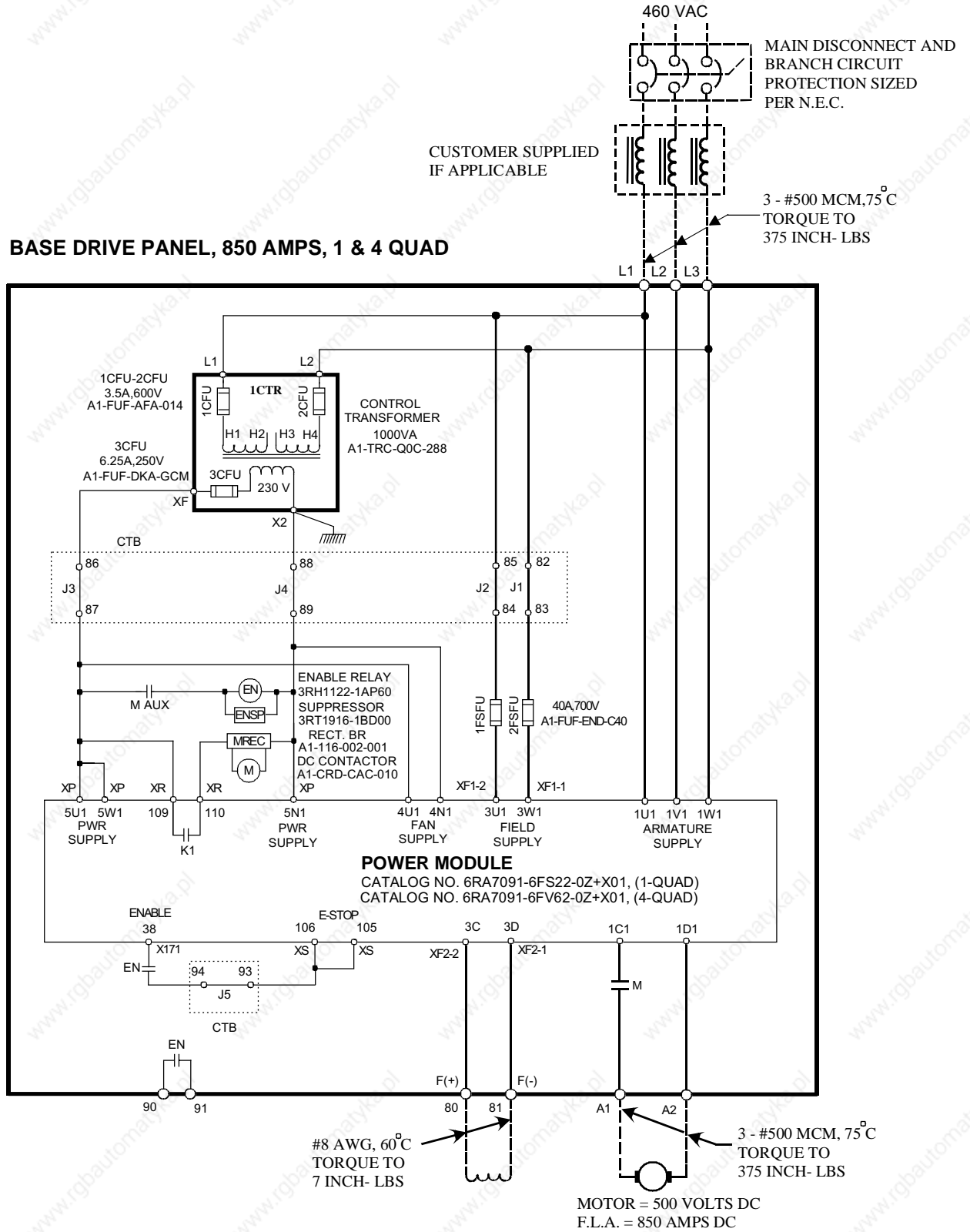

BASE DRIVE PANEL, 1180 AMPS, 1 & 4 QUAD

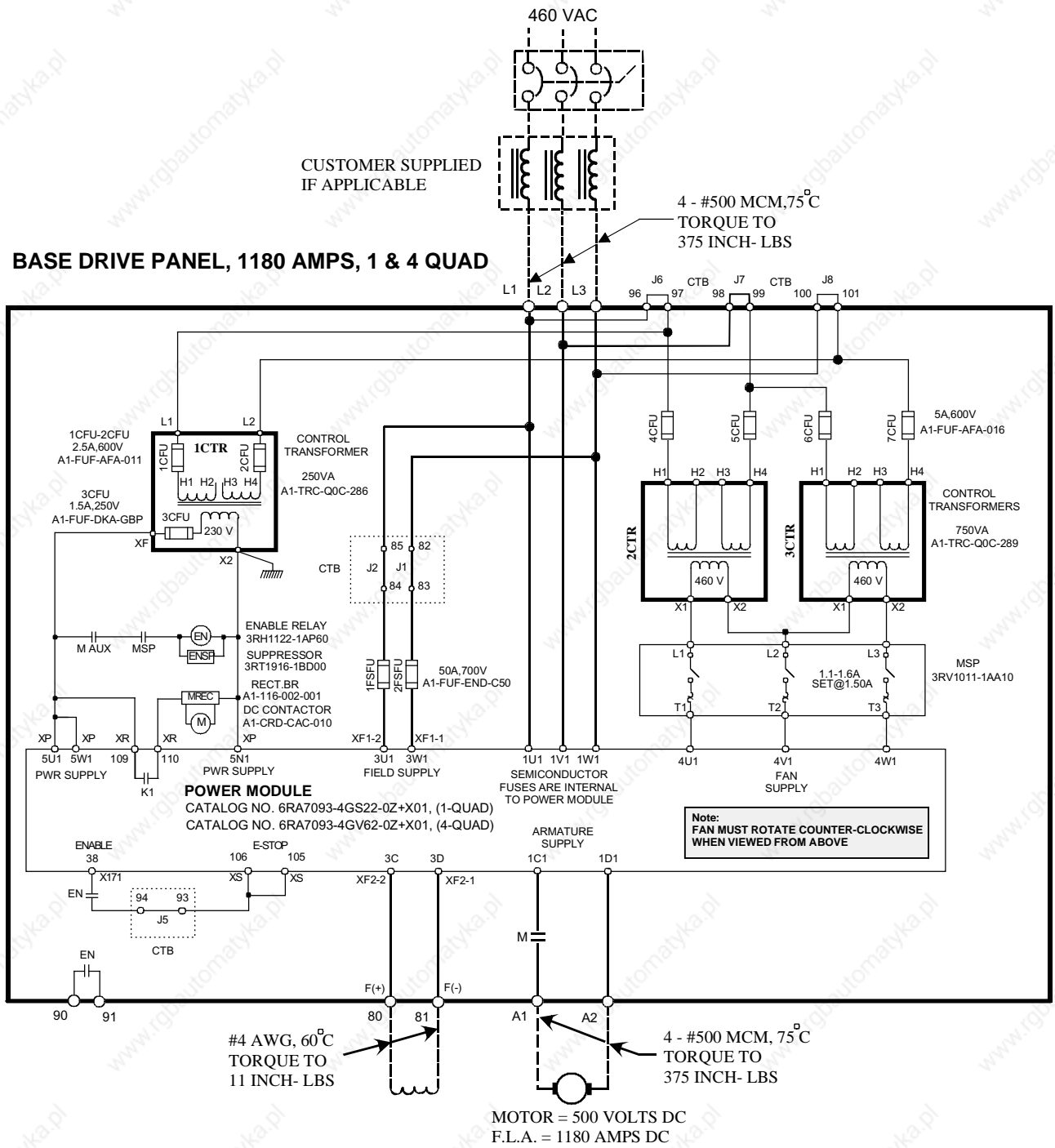

BASE DRIVE PANEL, 1660 AMPS, 1 & 4 QUAD

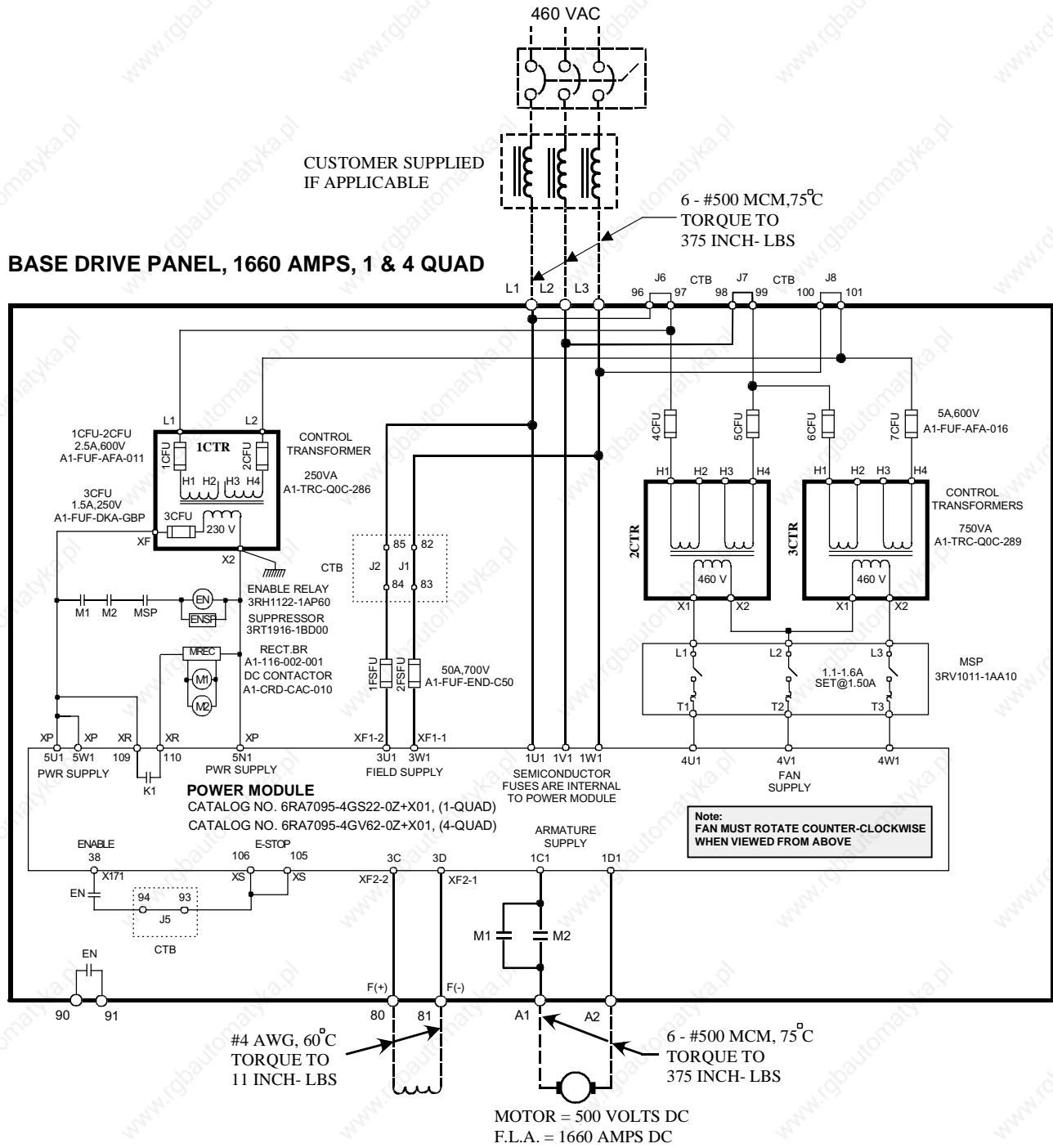

BASE DRIVE PANEL, 1680 AMPS, 1 & 4 QUAD

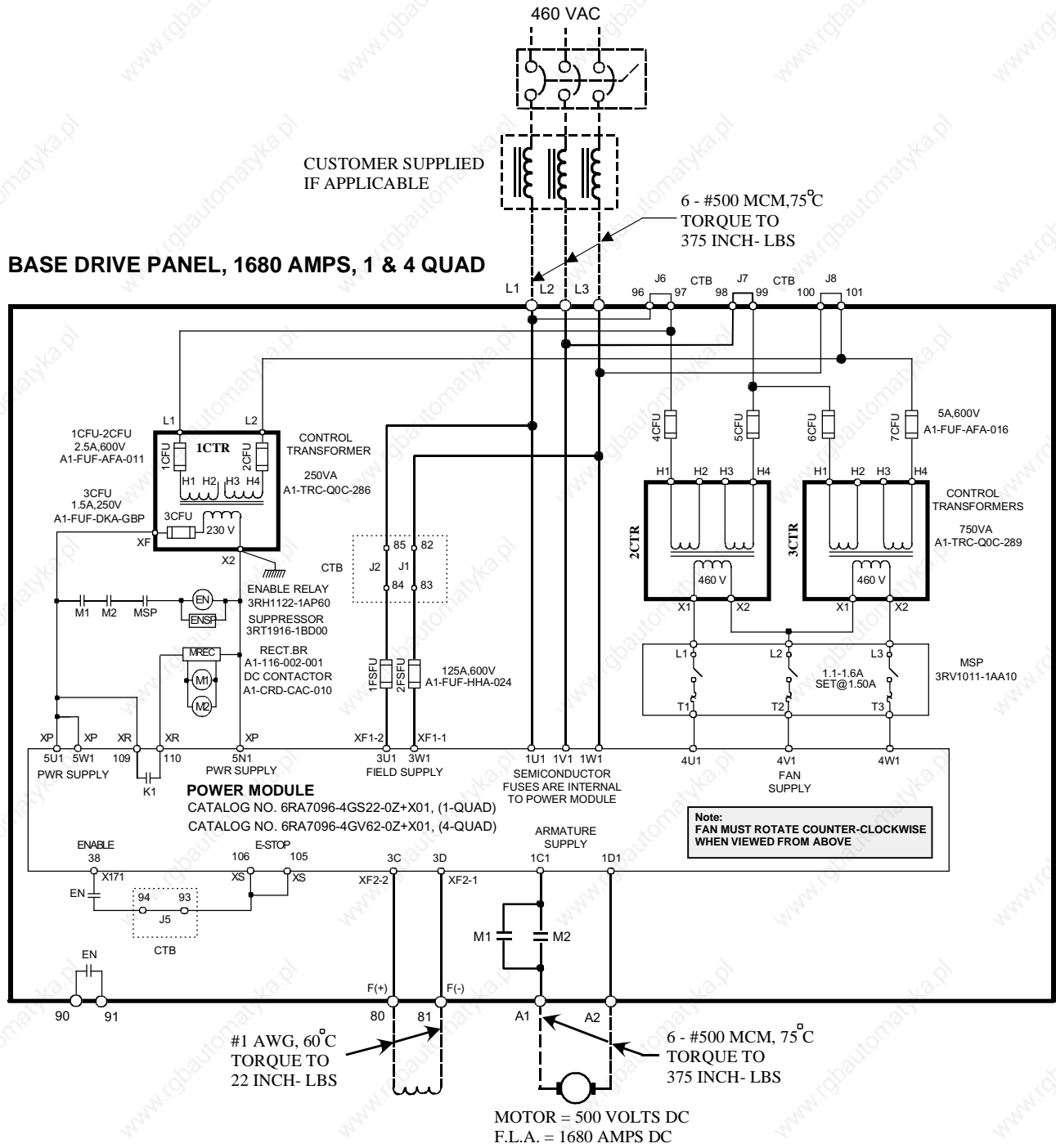

NOTES:

7.2 Control Connections CUD1

TYPICAL CONTROL CONNECTIONS

Also see Start-up 8.4.1 and 8.4.2

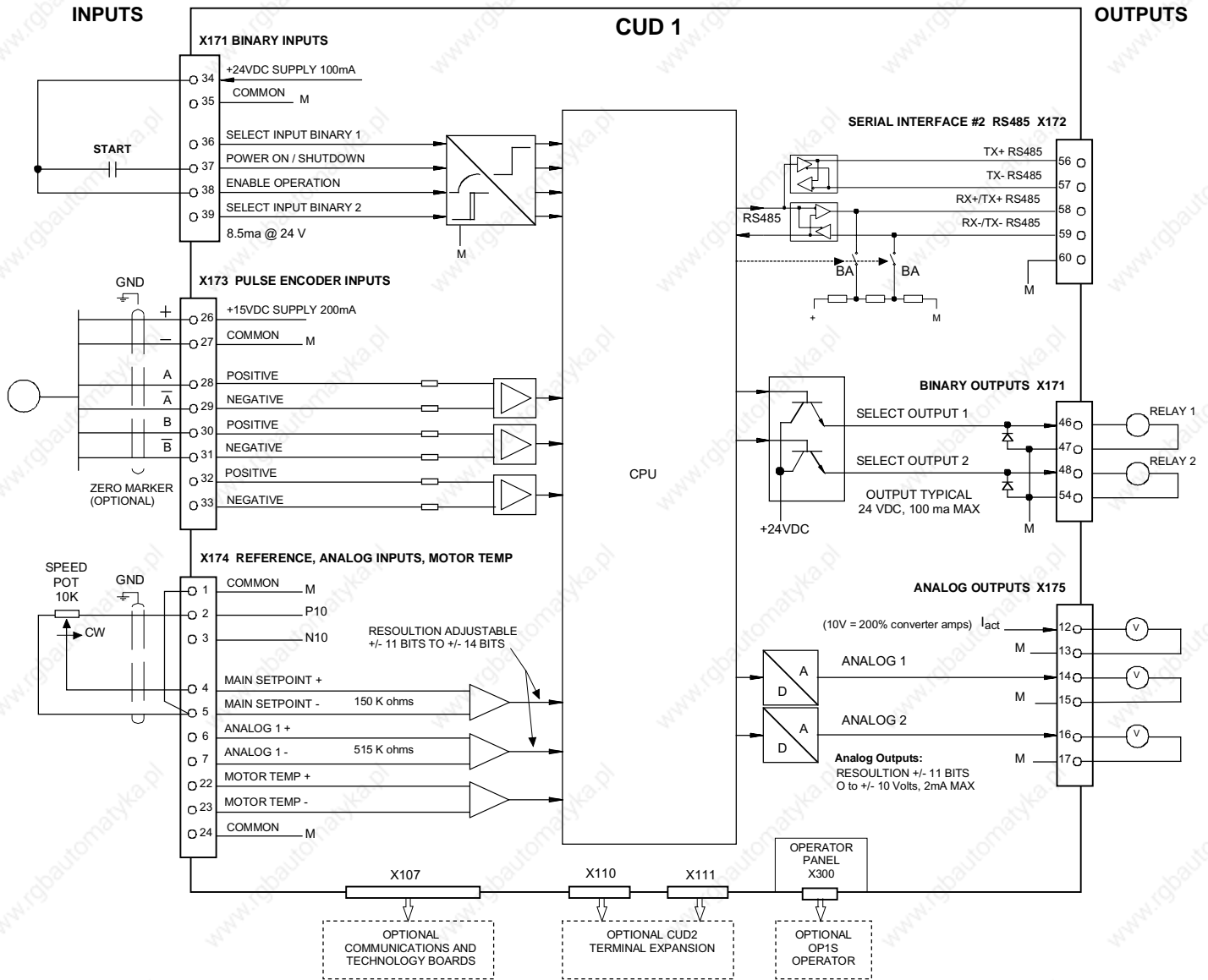

Terminal Locations CUD1

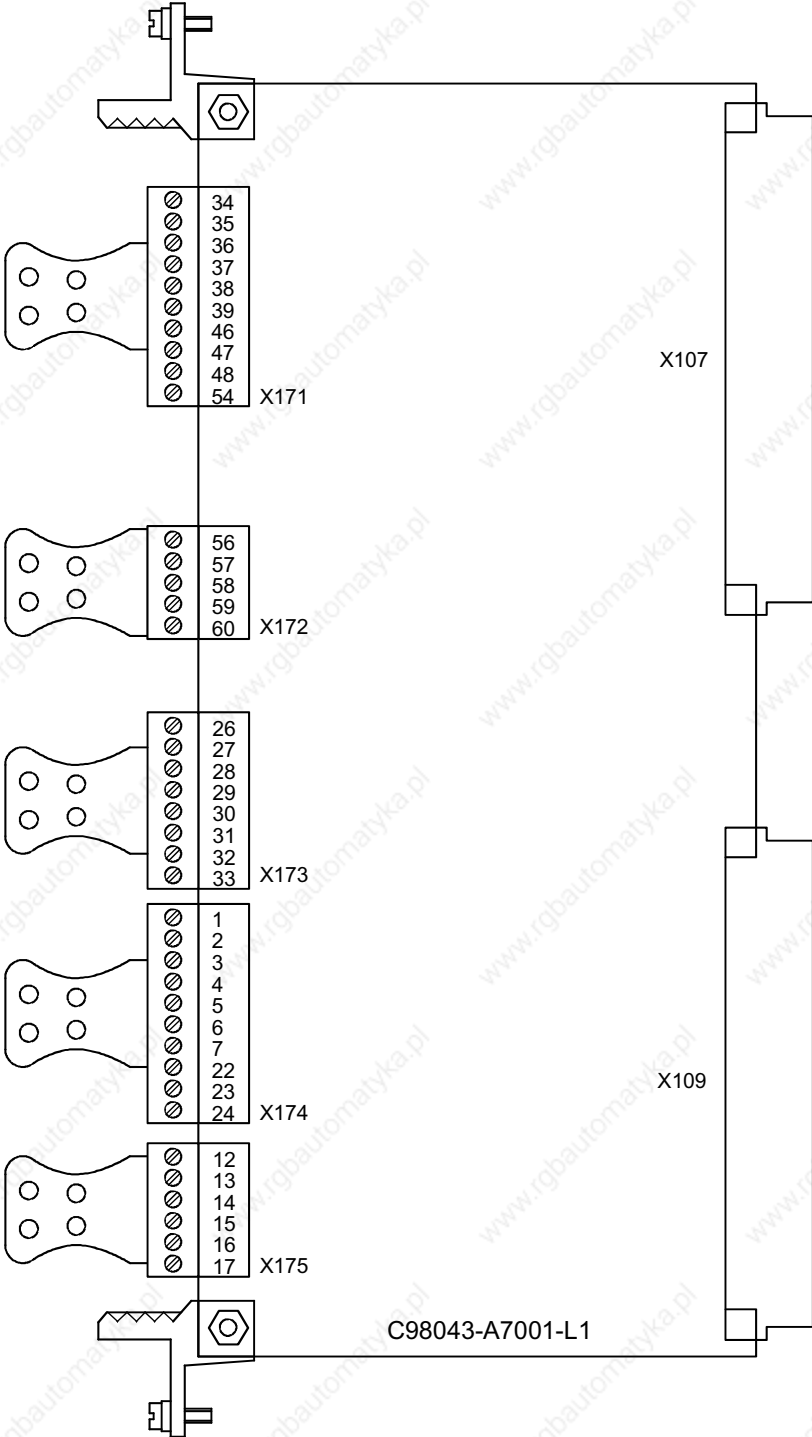

7.3 Control Connections CUD2

OPTIONAL CUD2 CONTROL CONNECTIONS

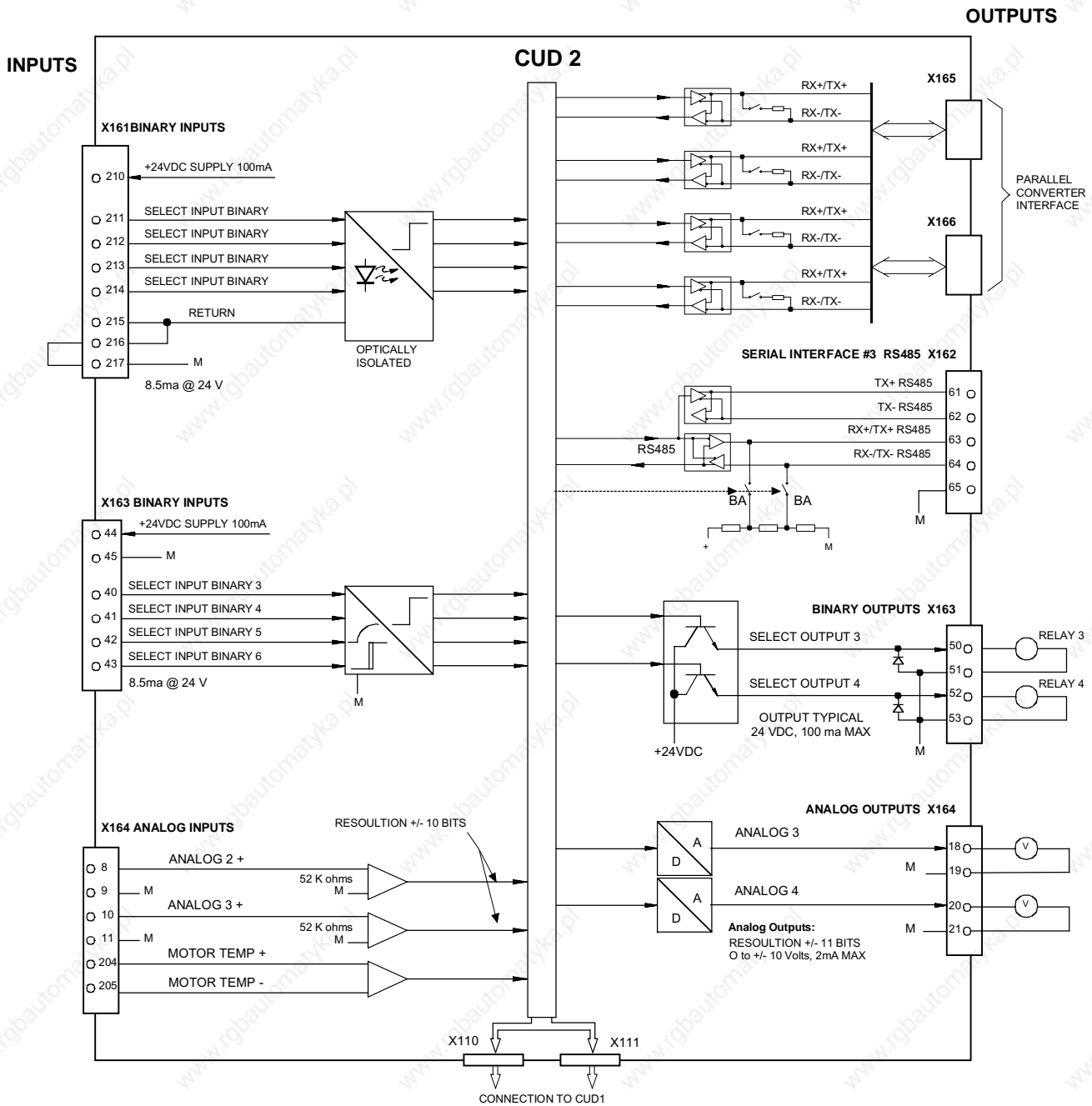

Terminal Locations CUD2

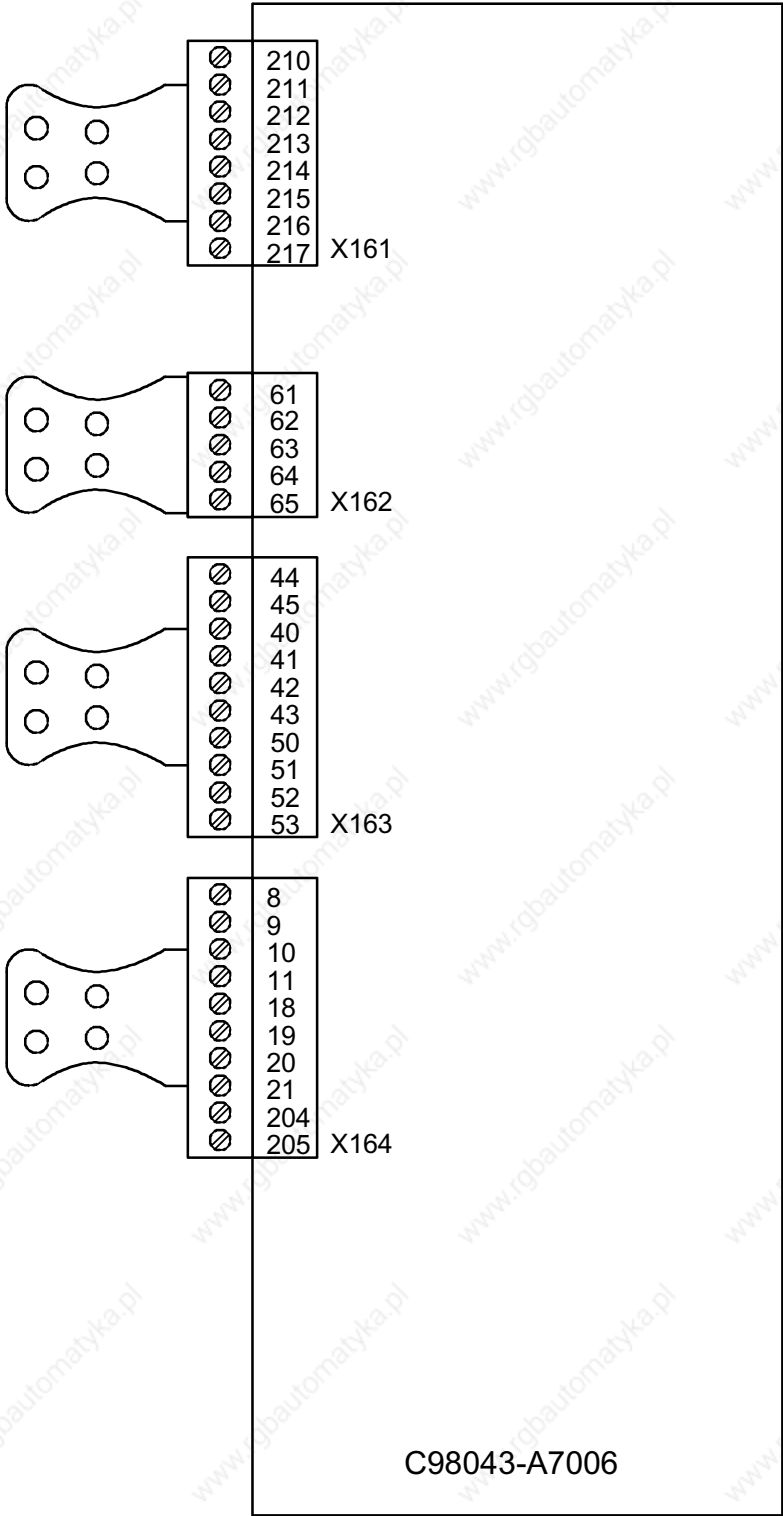

7.4 Description of Power/Control Terminals



WARNING



The Base Drive Panel might sustain serious or irreparable damage if connected incorrectly.

The power cables and/or busbars must be secured mechanically outside the converter in order to provide proper stress relief at the terminals.

Base Drive Panels are complete drive assemblies that include all semiconductor type fuses, main contactor, and a control transformer, ready to be connected and operated. All external connections to Base Drive Panels, including power connections are made with compression type terminals on the drive.

The user is responsible for installation of the motor, SIMOREG Base Drive Panel, transformer, and other devices in accordance with the National Electric Code and other applicable local codes that cover such items as wire size, protective grounding, disconnects, and short circuit protection. Depending on the rating, base drives can accommodate a range of cable sizes as indicated below.

Base Drive Panel Power Connections 15 to 100 Amp

RATING	CABLE RANGE	RECOMMENDED TORQUE
15 AMP L1, L2, L3, A1, A2, GND	#12 to #4 AWG	1.2 Nm (11 IN-LBS)
30 AMP L1, L2, L3, A1, A2, GND	#12 to #4 AWG	1.2 Nm (11 IN-LBS)
60 AMP L1, L2, L3, A1, A2, GND	#10 to #1 AWG	3 Nm (27 IN-LBS)
100 AMP L1, L2, L3, A1, A2, GND	#10 to #1 AWG	3 Nm (27 IN-LBS)

Base Drive Panel Power Connections 140 to 255 Amp

RATING	CABLE RANGE	RECOMMENDED TORQUE
140 AMP L1, L2, L3, A1, A2	2 CABLES PER CONNECTION #6 AWG to 250 MCM	31 Nm (275 IN-LBS)
210 AMP L1, L2, L3, A1, A2	2 CABLES PER CONNECTION #6 AWG to 250 MCM	31 Nm (275 IN-LBS)
255AMP L1, L2, L3, A1, A2	2 CABLES PER CONNECTION #6 AWG to 250 MCM	31 Nm (275 IN-LBS)
Ground Terminal 140, 210, 255 Amp	#8 to #2 AWG	5 Nm (45 IN-LBS)

Base Drive Panel Power Connections 430 to 1680 Amp

RATING	CABLE RANGE	RECOMMENDED TORQUE
430AMP L1, L2, L3 ----- A1, A2 -----	2 CABLES PER CONNECTION #6 AWG to 250 MCM (L1, L2, L3) ----- #6 AWG to 500 MCM (A1, A2) -----	31 Nm (275 IN-LBS) 43 Nm (375 IN-LBS)
510 AMP L1, L2, L3, A1, A2	2 CABLES PER CONNECTION #6 AWG to 500 MCM	43 Nm (375 IN-LBS)
850 AMP L1, L2, L3, A1, A2	3 CABLES PER CONNECTION #1/0 AWG to 500 MCM	43 Nm (375 IN-LBS)
1180 AMP L1, L2, L3, A1, A2	4 CABLES PER CONNECTION #1/0 AWG to 500 MCM	43 Nm (375 IN-LBS)
1660 / 1680 AMP L1, L2, L3, A1, A2	6 CABLES PER CONNECTION #1/0 AWG to 500 MCM	43 Nm (375 IN-LBS)
Ground Terminal 430 TO 850 Amp 1180/1660/1680 Amp	#2 to #4/0 AWG ----- #1/0 to 350 MCM -----	17 Nm (150 IN-LBS) 31 Nm (275 IN-LBS)

Base Drive Panel Control Connections, (CTB), 15 TO 1680 Amp

RATING	WIRE RANGE	RECOMMENDED TORQUE
15 TO 255 Amp CTB-80.....CTB-92	#18 to #10 AWG	0.55 Nm (5 IN-LBS)
430 TO 850 Amp CTB-80.....CTB-85 CTB-86.....CTB-95	#14 to #8 AWG ----- #18 to #10 AWG -----	0.8 Nm (7 IN-LBS) 0.55 Nm (5 IN-LBS)
1180 & 1660 Amp CTB-80.....CTB-85 CTB-86.....CTB-95	#12 to #4 AWG ----- #18 to #10 AWG -----	1.3 Nm (11 IN-LBS) 0.55 Nm (5 IN-LBS)
1680 Amp CTB-80.....CTB-85 CTB-86.....CTB-95	#10 to #1 AWG ----- #18 to #10 AWG -----	2.5 Nm (22 IN-LBS) 0.55 Nm (5 IN-LBS)

Motor Armature circuit

Function	Terminal	Connection values/Remarks	Possible settings
Armature supply AC input	L1 L2 L3	See technical data, section 5 for actual maximum current values.	P078
Ground PE conductor	⊕		
Armature circuit motor connection	A1 A2		P100 P101

Motor Field circuit

Function	Terminal	Connection values/Remarks	Possible settings
AC Supply connection	CTB 83 CTB 84	Single Phase 460 VAC See section 5 for current rating	P076 P078
Motor Field connection	CTB 80 + CTB 81 -	Rated DC voltage 300V	P102

Electronics power supply, main contactor, fans (if used) 15 to 850 amp

Function	Terminal	Connection values/Remarks	Possible settings
Incoming AC supply 230V (supplied by internal control transformer)	CTB 87 CTB 89	Single Phase, 230 VAC, (hot) (ground side)	

Current Requirement for Terminals 87, 89 if supplied from a separate source

15 amp to 100 amp base drive panels:	0.55 amps
140 and 210 amp base drive panels:	1.2 amps
255 to 510 amp base drive panels:	1.6 amps
850 amp base drive panel:	4.6 amps

Electronics power supply, main contactor, and fans 1180 to 1680 amps

Function	Terminal		Connection values/Remarks	Possible settings
Incoming AC supply 460 VAC, 3 Phase	CTB	97	Internally connected to incoming 460V supply	
	CTB	99		
	CTB	101		

Current Requirement for Terminals if supplied from a separate source

1180, 1660 and 1680 amp base drives: 2.5 amps at 460 VAC 3 phase

Note: Phase sequence is important for the fan direction of rotation. The fan must rotate counter-clockwise when viewed from above. If necessary, swap the L1 and L2 phase wiring at incoming supply to change the fan direction of rotation.

Remote relay Enable terminals: 430 amp to 1680 amp base drive panels

Function	Terminal		Connection values/Remarks	Possible settings
External enable (if used)	CTB	93	If a remote enable function is required using a relay contact, then remove jumper J5 and install a normally open low voltage contact at terminals 93 – 94.	
	CTB	94		

The 430 amp to 1680 amp Base Drive Panels use a DC contactor that is interlocked through the enable function at regulator terminals 34 and 38. This circuit is brought out to CBT terminals 93 and 94 to allow an easy point to add an external enable contact if required. A remote enable contact can be wired directly to terminals 34 and 38 of the regulator for Base Drive Panels rated 15 to 255 amps.

NOTES:

8 Start-Up

8.1 General safety information for start-up

NOTE

Before handling any boards (in particular, the A7001 electronics board), please make sure that your body is electrostatically discharged to protect electronic components against high voltages caused by electrostatic charges. The simplest way of doing this is to touch a conductive, grounded object (e.g. bare metal cabinet component immediately beforehand).

PCBs must not be allowed to come into contact with highly insulating materials (e.g. plastic foil, insulating tabletops or clothing made of synthetic fibers).

PCBs may only be set down on electrically conducting surfaces.



WARNING

Hazardous voltages and rotating parts (fans) are present in this electrical equipment during operation. Non-observance of the safety instructions can result in death, severe personal injury or substantial property damage.

Hazardous voltage may be present at the signaling relays in the customer's installation.

The units must not be connected to an AC supply with an earth-leakage ground detector since, in the event of a fault to ground, the fault current may contain a DC component that may either prevent or hinder a higher-level ground fault detector from tripping. In this case, all loads connected to this ground fault detector will not be protected.

Only qualified personnel who are thoroughly familiar with all safety notices contained in the operating instructions as well as erection, installation, operating and maintenance instructions should be allowed to work on these devices.



The successful and safe operation of this equipment is dependent on careful transportation, proper storage and installation as well as correct operation and maintenance.

The unit is at a hazardous voltage level even when the line contactor is open. The gating board (board mounted directly to lower part of housing) has many circuits at hazardous voltage levels. Before carrying out any maintenance or repair work, all Base Drive Panel power sources must be disconnected and locked out.

These instructions do not claim to list all of the measures required to ensure the safe and reliable operation of the converter. For special applications, additional, supplementary information or instructions might be required. If problems do occur and you feel in any way uncertain, please contact your local Siemens office or representative.

The use of unauthorized parts in the repair of this unit and handling of the equipment by unqualified personnel can give rise to hazardous conditions which may cause death, severe personal injury or substantial property damage. All safety notices contained in this instruction manual and attached to the converter itself must be carefully observed.

Please read the safety information given in Section 1 of this instruction manual.

8.2 Operator control panels

The basic converter is equipped with a simple operator panel (PMU) as standard. A user-friendly panel with plain text display (OP1S) can be connected as an option.

8.2.1 Simple operator control panel (PMU “Parameterization Unit“)

The simple operator control panel is mounted in the converter door and consists of a 5-digit, 7-segment display with three status display LED's and three parameterization keys.

All adjustments, settings and measurements that need to be undertaken for the purpose of start-up can be made on the simple control panel.

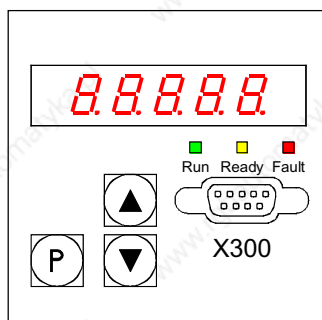

- **P key**
 - Switches over between **parameter number** (parameter mode), **parameter value** (value mode) and **index number** (index mode) on indexed parameters.
 - Acknowledges active fault messages.
 - P and RAISE keys to switch a fault message and alarm to the background to get access to the parameter mode.
 - P and LOWER key to switch a fault message and alarm from the background back to the foreground display on the PMU.
- **UP key (▲)**
 - Selects a higher parameter number in parameter mode. When the highest parameter number is displayed, the key can be pressed again to roll over to the lowest parameter number.
 - Increases the displayed parameter value in value mode.
 - Increases the index number in index mode (for indexed parameters)
 - If the DOWN key is pressed, then, also pressing the UP key will accelerate the DOWN adjustment process.
- **DOWN key (▼)**
 - Selects a lower parameter number in parameter mode. When the lowest parameter number is displayed, the key can be pressed again to roll over to the highest parameter number.
 - Decreases the displayed parameter value in value mode.
 - Decreases the index number in index mode (for indexed parameters)
 - If the UP key is pressed, then, also pressing the DOWN key will accelerate the UP adjustment process.

LED displays

Run green LED

LED illuminated ⇒ in “Torque direction active” state (MI, MII, M0).
(See parameter r000)

Ready yellow LED

LED illuminated ⇒ in “Ready” state (o1 .. o7).
(See parameter r000)

Fault red LED

LED illuminated ⇒ in “Fault signal present” state (o11)
(See parameter r000)

LED flashing ⇒ An alarm is active (see Faults and Alarms).

8.2.2 User-friendly operator control panel (OP1S)

The optional, user-friendly, operator control panel with plain text display (order no.: 6SE7090-0XX84-2FK0) can be mounted in the special location provided in the converter door or remotely mounted on the enclosure door. The OP1S connects to the basic converter interface SST1 at sub D connector X300.

Parameters can be selected directly through input of the parameter number by the keyboard of the OP1S. The following interrelationships apply:

	Displayed number	Number to be keyed in on OP1S
Basic converter parameter	rxxx, Pxxx	(0)xxx
	Uxxx, nxxx	2xxx
Technology board parameter	Hxxx, dxxx	1xxx
	Lxxx, cxxx	3xxx

For more information on the operation of the OP1S, refer to the power module operating instructions and the instructions that were provided with the OP1S.

8.3 Parameterization procedure

Parameterization is the process of changing or setting parameter values, activating converter functions, or displaying measured values with the operator panel.

Parameters for the basic converter are called P, r, U or n parameters.

Parameters for an optional supplementary board are called H, d, L or c parameters.

The basic unit parameters are displayed first on the PMU, followed by the technology board parameters (if such a board is installed). It is important not to confuse the parameters of the S00 technology software of the basic unit with the parameters of an optional supplementary board (T400).

Depending on how parameter P052 is set, only some parameter numbers are displayed.

8.3.1 Parameter types

Display parameters (r, n, d, and c), are used to display current quantities such as the main setpoint, armature voltage, feedback signals, outputs of controller, etc. The values of display parameters are read-only values and cannot be changed.

Setting parameters (P, U, H, L), are used to both display and change parameter quantities such as the rated motor current, thermal motor time constant, speed controller P gain, etc.

Indexed parameters (P, U, H, L), are used to both display and change several parameter values which are all assigned to the same parameter number but identified by the index number.

8.3.2 Parameterization on simple operator control panel

After the electronics supply voltage has been switched on, the PMU is either in the operational display state and indicating the current operating status of the SIMOREG 6RA70 (e.g. o7.0), or in the fault/alarm display state and indicating a fault or alarm (e.g. F021).

Drive operational states are described by parameter r000 whereas fault and alarm messages are described in the power module operating instructions in Section 10.

1. To enter the **parameter number level** from the operational display state (e.g. o7.0), press the P key and then the <Up> or <Down> key to select individual parameter numbers.
2. To enter the **parameter index levels** (for indexed parameters) from the parameter number level, press P again and then the <Up> or <Down> key to select individual indices. If you press P when a non-indexed parameter is displayed, you go directly to the parameter value level.
3. To reach the **parameter value level** from the parameter index level (for indexed parameters), press P again and the parameter value will be displayed.
4. On the **parameter value level**, you can change the setting of a parameter value by pressing the <Up> or <Down> key.

CAUTION!

Parameters can be altered only if the following conditions are fulfilled:

- The key code is set with P051 = 40.
- The converter is in the correct operational state. Some parameters are “off-line” and cannot be changed when the converter is in the “Run” or on-line state.
- The values of display parameters can not be changed (read only).

5. Manual shifting

If the 5 existing digits on the 7-segment display are not sufficient to display a parameter value, the display first shows just 5 digits (see Fig. 8.1). To indicate that more digits are concealed to the right or left of this “window”, the right-hand or left-hand digit flashes. By pressing the <P>+<Down> or <P>+<Up> key, you can shift the window over the remaining digits of the parameter value. As an orientation guide, the position of the right-hand digit within the overall parameter value is displayed briefly during manual shifting.

Example: Parameter value “208.173”

“208.17” is displayed when the parameter is selected. When the P and LOWER keys are pressed, “1” appears briefly followed by “08.173”, i.e. the right-hand digit 3 is the 1st position in the parameter value.

When the P and RAISE keys are pressed, “2” appears briefly followed by “208.17”, i.e. the right-hand digit 7 is the 2nd position in the parameter value.

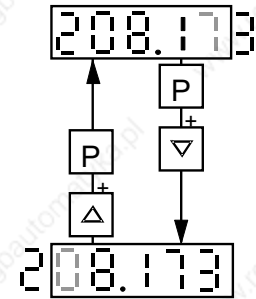
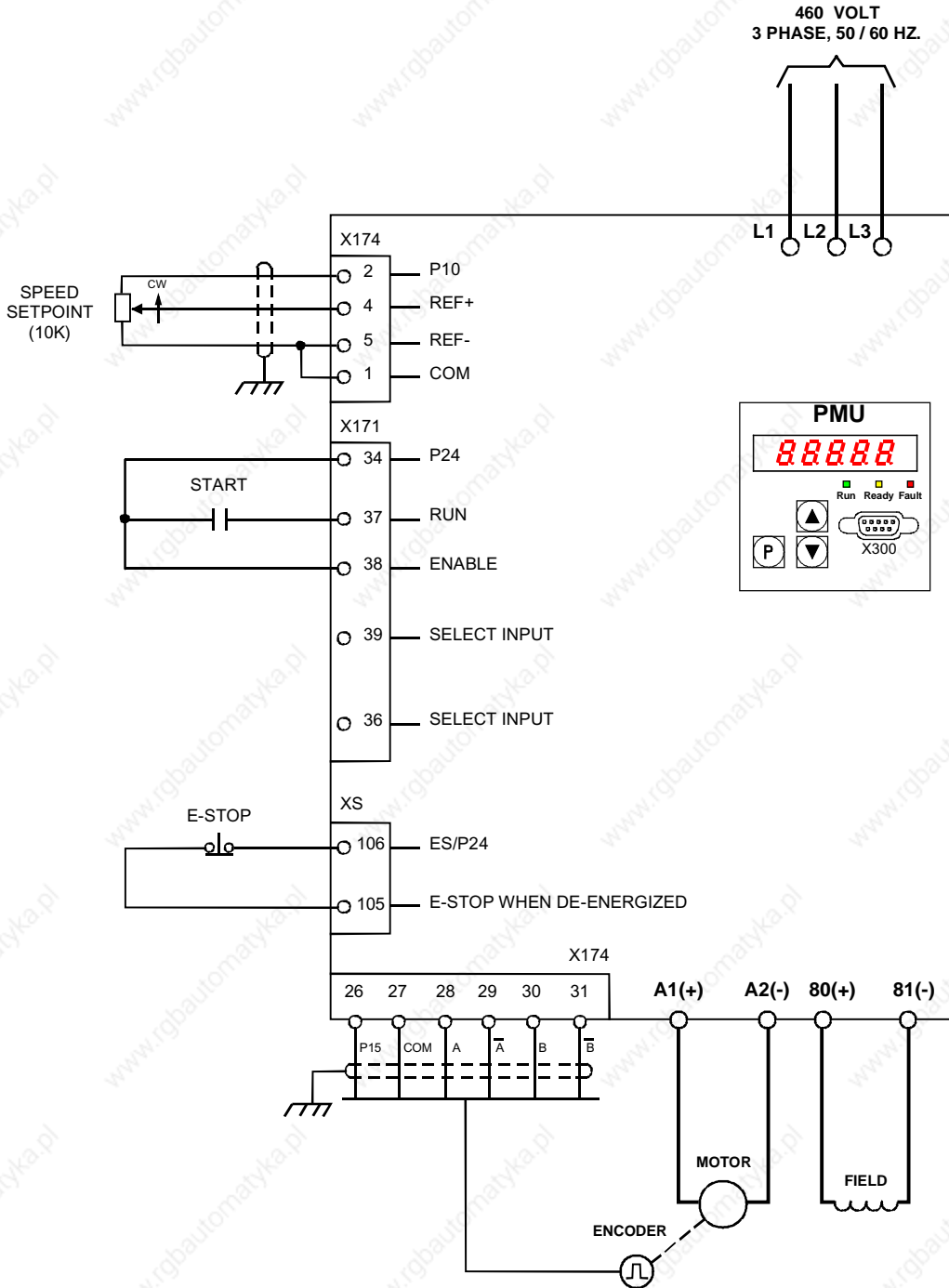

Fig. 8.1 Shifting the PMU display for parameter values with more than 4 digits

6. Press the P key to return to the parameter number level from the parameter value level.

8.4 Typical Connection Diagrams

8.4.1 Configured with Analog Speed Setpoint and Start/Stop Control by Contacts



8.4.2 Configured with Analog Speed Setpoint and Push-Button Start/Stop Control

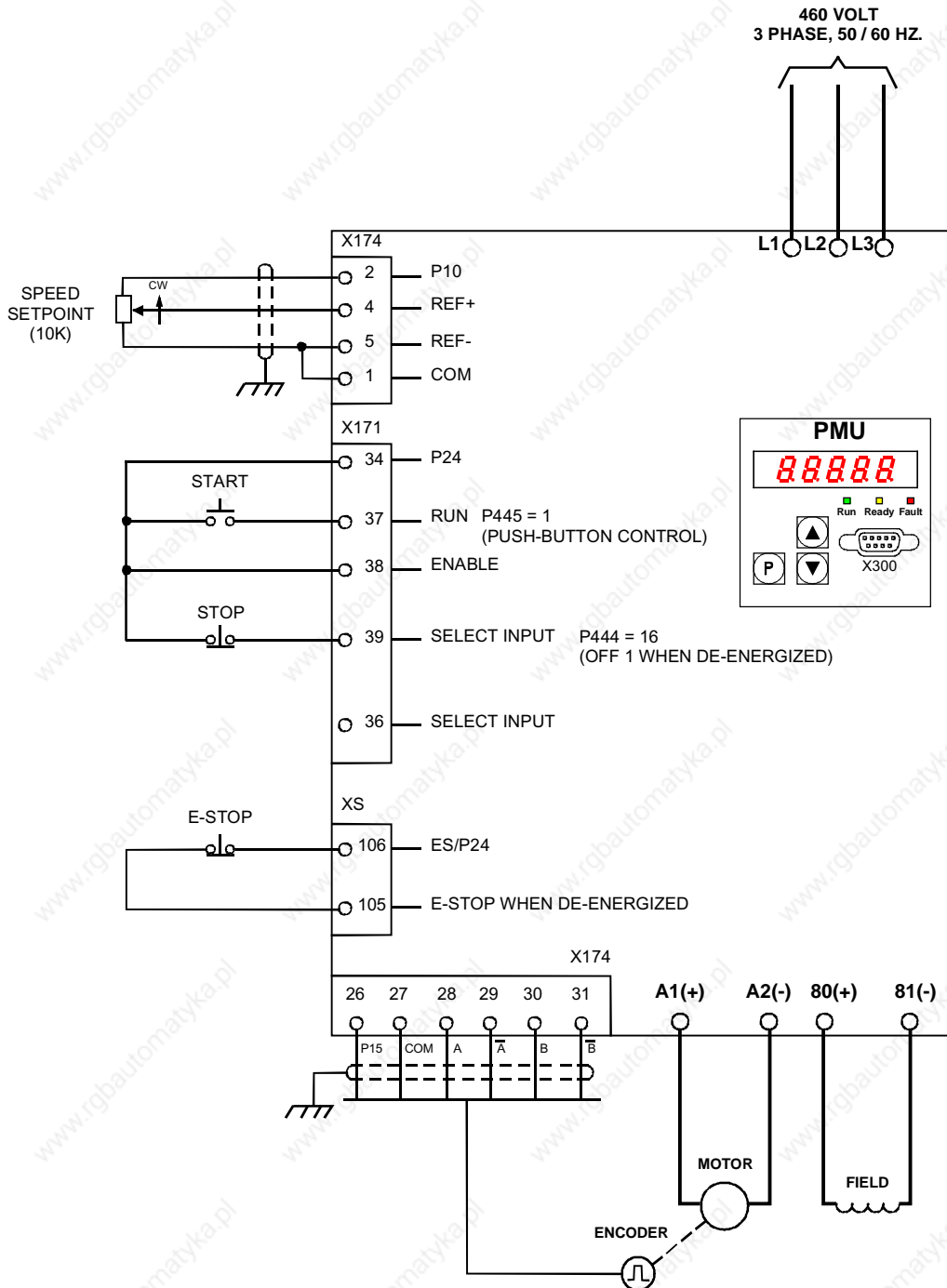

8.5 Reset to factory default values and adjust offsets

In order to start from a predefined set of parameter values, it is highly recommended that the “Restore to default” function be executed before a complete new start-up operation is begun.

NOTE

When the “Restore to default” function is activated, all parameters set for a specific installation are overwritten (deleted). If the old settings are to be retained they should be recorded before the default procedure is executed. The old settings can be read out and stored in a file using a PC and either the Quick Start or DriveMonitor PC program.

“Restore to default” must be followed by a completely new start-up operation since none of the application related parameters are set.

Execution of the default function:

1. Set parameter **P051 = 21**
2. When the “P” key is pressed the parameter values are reset to the factory value.
The parameter values are stored in non-volatile storage (EEPROM) so that they will still be available when the converter is switched off. This operation takes at least 5 s (but may also last several minutes). The number of the parameter currently being processed is displayed on the PMU during the process. The electronics power supply must remain powered up while this operation is in progress.
3. Field offset adjustments
Parameter P825.ii is automatically set (takes approx. 10 s) to provide proper calibration of the field converter rated current. The offset adjustment can also be activated as an individual function by means of parameter **P051 = 22**.

8.6 Start-up procedure



WARNING



The Base Drive Panel is at a hazardous voltage level even when the line contactor is open. The gating board (board mounted directly to lower part of housing) has many circuits at hazardous voltage levels.

Non-observance of the safety instructions given in this manual can result in death, severe personal injury or substantial property damage.

The following steps summarize the start-up procedure.

Always begin by defaulting the parameters back to the factory value as outlined in paragraph 8.5

Step	Procedure
1	Set P051 = 40 to gain access to change parameters
2	Set P067 = 5 for US rating. This parameter setting is mandatory on Base Drive Panels.
3	Set the actual operating AC supply voltage for the armature and field converters (P078)
4	Input motor data (P100, P101, P102, P114)
5	Select speed feedback method (P083) [analog tach, encoder, EMF voltage, custom]
6	Select field control and weakening (P081, P082)
7	Set current limits and ramp generator time (P171, P172, P303, P304, P305, P306)
8	Perform self tuning (P051 = 25, 26, 27, 28)
9	Set application specific parameters
10	Documentation of final parameter values

The following details explain how to do each of the above steps.

1 Access authorization

P051 . . . Key parameter

- 0 Parameter cannot be changed
- 40 Parameter can be changed

P052 . . . Selection of parameters to be displayed

- 0 Only parameters that are not set to default are visible
- 3 All parameters are visible

2 Adjustment of converter rated currents

Base Drive Panels are designed to continuously operate at the converter US rated current and then provide 150% overload current for 60 seconds. In order to meet this requirement it is mandatory that P067 be set to a value of 5. The IEC Class 1 rating provides a higher continuous current but has no overload capability. The fuses, contactor, power terminals, and power wiring used on base drives have been selected based on the US rating. Failure to set P067 on Base Drive Panels to the US rating may cause damage to Base Drive Panel components and void warranty.

Set parameter P067 = 5 “U.S. Rating“.

Set parameter P075 = 1 to allow dynamic overload capability.

3 Adjustment to actual converter supply voltage

P078.001 . . . Supply voltage for armature circuit (in volts)

P078.002 . . . Supply voltage for field circuit (in volts)

4 Input of motor data

The motor data as given on the motor rating plate must be entered in parameters P100, P101, P102 and P114.

P100 . . . Rated armature current (in amps)

P101 . . . Rated armature voltage (in volts)

P102 . . . Rated field current (in amps)

P114 . . . Thermal time constant of motor (in minutes). **If not known use the default 10-minute value.**

5 Actual speed sensing data

5.1 Operation with analog tachometer

P083 = 1: The actual speed is supplied from the “Main actual value” channel (K0013) (terminals XT.103, XT.104)

P741 Tachometer voltage at maximum speed (– 270,00V to +270,00V)

5.2 Operation with pulse encoder

P083 = 2: The actual speed is supplied by the pulse encoder (K0040)

P140 Selecting a pulse encoder type (pulse encoder types see below)
0 No encoder/"Speed sensing with pulse encoder" function not selected

- 1 **Pulse encoder type 1 (Normal selection)**
- 2 Pulse encoder type 1a (Special encoder)
- 3 Pulse encoder type 2 (Special encoder)
- 4 Pulse encoder type 3 (Special encoder)

1. Pulse encoder type 1

Encoder with two pulse tracks mutually displaced by 90° (with or without zero marker)

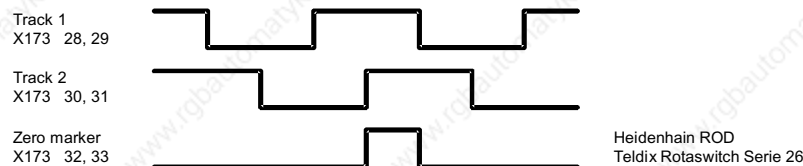

P141 Number of pulses of pulse encoder (in pulses/revolution)

P142 Matching to pulse encoder signal voltage

- 0 Pulse encoder outputs 5 V signals (requires separate 5V encoder supply voltage)
- 1 Pulse encoder outputs 15V signals (uses internal 15V encoder supply voltage)

CAUTION

Resetting parameter P142 to the alternative 5V setting does not switch over the supply voltage for the pulse encoder (terminals X173.26 and 27). Terminal X173.26 always supplies +15V. An external voltage supply must be provided for pulse encoders requiring a 5V supply.

P143 Setting the maximum operating speed for pulse encoder operation (in revolutions/minute). The speed set in this parameter corresponds to an actual speed (K0040) of 100%.

5.3 Operation without tachometer (EMF control)

P083 = 3: The actual speed is supplied from the "Actual EMF" channel (K0287), but scaled with P115.

P115 EMF at maximum speed (Note: EMF = Terminal voltage – IxR)
1.00% to 140.00% of rated converter supply voltage at r071.

5.4 Freely wired actual value

P083 = 4: The actual value input is defined with P609.

P609 Number of connector to which actual speed controller value is connected.

6 Field data

6.1 Field control

- P082 = 0: Internal field is not used and field functions are not used.
(e.g. with permanent-field motors)
- P082 = 1: The field is switched together with the line contactor
(field pulses are enabled/disabled when line contactor closes/opens)
- P082 = 2:** Automatic connection of standstill field set by P257 after a delay parameterized by P258,
after operating status o7 or higher has been reached
- P082 = 3: Field current permanently connected

6.2 Field weakening

- P081 = 0: No field weakening as a function of speed or EMF
- P081 = 1: Field weakening operation as a function of internal EMF control so that, in the field
weakening range, i.e. at speeds above motor base speed, the motor EMF is maintained
constant. Note: Rated EMF = Rated Terminal voltage – $I_{\text{rated}} \times R_{\text{armature}}$
 $EMF_{\text{setpoint}} \text{ (K289)} = P101 - P100 * P110.$

7 Selection of basic technological functions

7.1 Current limits

- P171 Motor current limit in torque direction I (in % of P100, default value = 100%)
US setting P171 = 150%
- P172 Motor current limit in torque direction II (in % of P100, default value = -100%)
US setting P172 = -150%

7.2 Ramp-function generator

- P303 Acceleration time 1 (in seconds, default value = 10)
- P304 Deceleration time 1 (in seconds, default value = 10)
- P305 Initial rounding 1 (in seconds, default value = 0)
- P306 Final rounding 1 (in seconds, default value = 0)



8 Execution of optimization runs



8.1 The unit must be in operating state o7.0 or o7.1 (enter SHUTDOWN!).



8.2 Select one of the following optimization runs in key parameter P051:

P051 = 25 Optimization run for precontrol and current controller for armature and field

P051 = 26 Speed controller optimization run

P051 = 27 Optimization run for field weakening

P051 = 28 Optimization run for compensation of friction moment and moment of inertia

Note: The optimization runs should be performed in the above order.



8.3 The SIMOREG converter switches to operating state o7.4 for several seconds and then to o7.0 or o7.1 and waits for the START command and ENABLE.

Enter the commands START and ENABLE.

The flashing of the decimal point in the operational status display on the PMU (simple operator control panel) indicates that an optimization run will be performed after the Start command.

If the start command is not given within 30 s, this waiting status is terminated and fault message F052 displayed.



8.4 As soon as the converter reaches operating status <o1.0 (RUN), the optimization run is executed. An activity display appears on the PMU, consisting of two 2-digit numbers, separated by a bar that moves up and down. These two numbers indicate (for SIEMENS personnel) the current status of the optimization run.

P051 = 25 Optimization run for precontrol and current controller for armature and field (process lasts approximately 40s).
The following parameters are set automatically: P110, P111, P112, P155, P156, P255, and P256.

NOTE

Permanent-field motors (and motors with an extremely high residual flux) must be mechanically locked during this optimization run.



WARNING



The set current limits are not effective during the current controller optimization run. 75% of the rated motor armature current flows for approximately 0.7s. Furthermore, individual current spikes of approximately 120% of the motor rated armature current are generated.

P051 = 26 **Speed controller optimization run** (process lasts approximately 6s).
The following parameters are set automatically: P225, P226 and P228.

Note:

The speed controller optimization run takes only the filtering of the actual speed controller value parameterized in P200 into account and, if P083=1, filtering of the main actual value parameterized in P745.

When $P200 < 20\text{ms}$, P225 (gain) is limited to a value of 30.00.

The speed controller optimization run sets P228 (speed setpoint filter) to the same value as P226, speed controller integration time, for the purpose of achieving an optimum control response to abrupt setpoint changes. In many process applications, it may be better to set $P228 = 0$ so that the actual speed follows the process setpoint with less delay.



WARNING



During the speed controller optimization run, the motor is accelerated at a maximum of 45% of its rated armature current. The motor may reach speeds of up to approximately 20% of maximum speed.

If field weakening is selected ($P081 = 1$), or if closed-loop torque control ($P170=1$) or torque limiting ($P169=1$) is selected or if a variable field current setpoint is applied the optimization run for field weakening must be run:

P051 = 27 **Optimization run for field weakening** (process lasts approx. 1min).
The following parameters are set automatically: P117 to P139, P275 and P276.

Note:

In order to determine the magnetization characteristic, the field current setpoint is reduced during the optimization run from 100% of the motor rated field current as set in P102 down to a minimum of 8%. The field current setpoint is limited to a minimum according to P103 by setting P103 to values $< 50\%$ of P102 for the duration of the run. This might be necessary in the case of uncompensated motors with a very high armature reaction.

The magnetizing characteristic is approximated linearly to 0, starting from the measuring point, at a minimum field current setpoint.

To execute this optimization run, the minimum motor field current, P103, must be parameterized to less than 50% of the rated motor field current (P102).



WARNING





During this optimization run, the motor accelerates to approximately 80% of rated motor speed (the armature voltage corresponds to maximum 80% of the rated motor armature voltage (P101)).

P051 = 28

Optimization run for compensation of friction moment and moment of inertia (if desired) (process lasts approx. 40s)

The following parameters are set automatically: P520 to P530, P540

	WARNING
	The motor accelerates up to maximum speed during this optimization run.

On completion of this run, the friction and inertia moment compensation function must be activated manually by setting P223=1.

When the operating mode is switched from current control to torque control with P170, the optimization run for friction and inertia moment compensation must be repeated.

Note:

The speed controller may not be parameterized as a pure P controller or as a controller with droop when this optimization run is executed.



8.5 At the end of the optimization run, P051 is displayed on the operator panel and the drive switches to operating state o7.2.

NOTE

In the case of motors with a limited travel path, the optimization run for field weakening (P051=27) may not be interrupted by the SHUTDOWN command until the 1st field weakening measuring point has been plotted. Likewise, the optimization run for the friction moment and moment of inertia compensation function (P051=28) may not be interrupted by SHUTDOWN until the measuring point at 10% of maximum speed has been determined. Premature interruption in both cases will lead to activation of fault message F052. When either of these optimization runs is restarted (P051=27 or P051=28), it will be continued at a more advanced position. In this way, the respective run can be completed in several stages, even if the travel path is limited.

Note:

The respective optimization run is executed completely after a restart if:

- a) a fault message is activated during the optimization run
- b) if the electronics supply is disconnected before the relevant optimization run is restarted
- c) if another function data set than the one before is selected or
- d) if another optimization run is started in-between.

The parameters of the function data set selected in each case are optimized.

While optimization runs are being executed, the function data set selection must not be changed or else a fault message will be activated.

NOTE

Optimization runs should be executed in the order listed above (precontrol and current controller, speed controller, and field weakening control, friction moment and moment of inertial compensation).

The determined parameters are dependent on the motor temperature. Values set automatically when the motor is cold can be used as effective defaults.

For highly dynamic drives, the optimization runs P051=25 should be repeated after the drive has been operated under load (i.e. when motor is warm).

Checking and possible fine adjustment of maximum speed

After the optimization runs have been executed, the maximum speed should be checked and if necessary adjusted to its final value. If it is necessary to change the maximum speed setting by more than about 10%, the control response of the speed control loop must be checked. It may be necessary to repeat the speed controller optimization run or re-optimize the controller manually.

The optimization runs for field weakening and friction motor and moment of inertial compensation must be repeated every time the maximum speed setting is changed.

9 Setting Application Functions

9.1 Starting the Drive

With factory defaults, the Base Drive Panel is automatically configured to enable the drive with terminal 38 at X171 and to start the drive with terminal 37 also at connector X171. The function of these terminals is fixed. With all other methods of starting the drive, terminals 37 and 38 act as permissive to start and must be energized to allow the selected method to start the drive.

Alternatively, the drive can be configured to start from the CUD1 serial ports at connectors X300 or X172, and from optional communication boards or serial port located on the optional CUD2 board.

If an alternative method of starting the drive is required, the source of the start command is selected with parameter P654. The normal choices are:

Source of Start Command	P654 =
Terminal 37 @ connector X171 (factory default setting)	B0001
Serial Interface 1, X300, USS protocol, Word 1, Bit 0	B2100
Serial Interface 2, X172, USS protocol, Word 1, Bit 0	B6100
Technology Board or First Communication Board, Word 1, Bit 0	B3100
Second Communication Board, Word 1, Bit 0	B8100
Serial Interface 3, CUD2 X162, USS protocol, Word 1, Bit 0	B9100

9.2 Speed Setpoint Selection

With factory defaults, the Base Drive Panel is automatically configured to get the speed reference from the main setpoint analog input at terminals 4 and 5 on connector X174. The default scaling provides, +10 volts at terminals 4 with respect to 5, equals 100% speed setpoint in the forward direction. If the input is -10 volts at terminals 4 with respect to 5 then -100% speed setpoint in the reverse direction is provided.

Alternatively, the drive can be configured receive the speed setpoint from the CUD1 serial ports at connectors X300 or X172, and from optional communication boards or serial port located on the optional CUD2 board.

If an alternative source of the speed setpoint is required, it can be set using parameter P433. The normal choices are:

Source of Speed Setpoint	P433 =
Main setpoint analog input (factory default setting)	K0011
Serial Interface 1, X300, USS protocol, Word 2	K2002
Serial Interface 2, X172, USS protocol, Word 2	K6002
Technology Board or First Communication Board, Word 2	K3002
Second Communication Board, Word 2	K8002
Serial Interface 3, CUD2 X162, USS protocol, Word 2	K9002

The speed setpoint can come from many other sources such as other analog inputs, other words in the serial protocols, MOP function, and other freely selectable function in the base drive software. The ultimate selection of the setpoint source depends on the application requirements. To use any other source, locate the connector number for the source and set P433 to that value.

9.3 Jog (Inching) Configuration

If the unit is not already running, a JOG command can be given to the unit to cause it to start and run at a pre-selected speed. When the JOG command is released the motor speed will come to zero and the unit will stop. Up to 8 jog speeds can be configured. If positive reference values are used, the motor will jog forward while negative reference values will jog the motor in reverse.

Sources for both the jog command and the jog setpoint need to be configured. The source of the Jog commands is selected using parameter P435, however the first two, Jog1 and Jog2, can also be set from the source selected with parameters P668 and P669 through the control word 1 bits 8 and 9.

The following tables show a few examples of how the Jog commands and setpoints can be configured. The source of the command and setpoint are completely independent for maximum flexibility.

Source of Jog Command	P435 =	Value
Terminal 36 @ connector X171 = Jog 1	Index .01	B0010
Terminal 39 @ connector X171 = Jog 2	Index .02	B0016
Serial Interface 1, X300, USS protocol, Word 1, Bit 8 = Jog 3	Index .03	B2108
Serial Interface 2, X172, USS protocol, Word 1, Bit 9 = Jog 4	Index .04	B6109
Technology Board or First Communication Board, Word 1, Bit 4 = Jog 5	Index .05	B3104
Second Communication Board, Word 1, Bit 5 = Jog 6	Index .06	B8105
Serial Interface 3, CUD2 X162, USS protocol, Word 1, Bit 3 = Jog 7	Index .07	B9107

If more than one source is selected for the same command, then the command will be issued when either one is issued. If more than one jog function is selected, then the selected jog setpoints are added together. This feature allows the available jog speeds to be greatly expanded using various jog combinations.

Source of Jog Setpoint	P436 =	Value
Analog select Input 1, terminals 6 to 7 @ connector X174 = Jog 1 setpoint	Index .01	K0015
Fixed Jog 2 setpoint from parameter P401	Index .02	K0401
Fixed Jog 3 setpoint from parameter P402	Index .03	K0402
Serial Interface 1, X300, USS protocol, Word 4 = Jog 4	Index .04	K2004
Serial Interface 2, X172, USS protocol, Word 5 = Jog 5	Index .05	K6005
Technology Board or First Communication Board, Word 3 = Jog 6	Index .06	K3003
Second Communication Board, Word 3 = Jog 7	Index .07	K8003
Serial Interface 3, CUD2 X162, USS protocol, Word 4 = Jog 8	Index .08	K9004

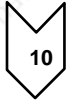

Documentation of setting values

- Save the parameter values using either Quick Start or the DriveMonitor PC program or
- Document parameters manually
If P052=0, only parameters that have been changed from the factory default are displayed. This makes it relatively easy to record the changed parameters.

NOTE

In the factory setting several fault codes are masked out with P820 and must be enabled if required.

NOTE

The 1180 amp, 1660 amp and 1680 units contain a three phase fan. Although the armature circuit is phase insensitive a check must be made to insure that the airflow in these units is from bottom to top. If the fan direction is incorrect, swap the L1 and L2 phase wiring at incoming supply once the unit has been de-energized. See drawings on pages 7-12 and 7-13.

NOTE

If the fan unit on the 1180 amp, 1660 amp and 1680 amp units become misaligned during shipment the fan housing can be re-aligned by loosening the front two mounting screws and re-aligning.

NOTES:

9 Faults and alarms

When a fault or alarm message is activated, it is displayed both on the simple operator control panel (PMU) and on the OP1S user-friendly operator control panel (see also Section 7.2, Operator control panels).

An alarm stops being displayed immediately the cause of the alarm signal has been eliminated.

A fault message must be cancelled by pressing the P key on the PMU or Reset key on the OP1S (panel must be in "Operational display" status) as soon as the cause has been eliminated.

NOTE

Setting parameters when fault or alarm message is active

On the PMU:

You can shift an active fault message or alarm "to the background" by pressing the P key and Higher key simultaneously on the PMU.

If you do not press any key on the PMU within a 30 s period, the fault message or active alarm in the background is automatically displayed again.

You can fetch a message back to the foreground earlier by pressing the P key and Lower key simultaneously on the PMU when the parameter number level is selected.

On the OP1S:

You can set parameters normally even if a fault message or alarm is active.

9.1 Fault messages

9.1.1 General information about faults

Fault message display:

On the PMU: F (fault) and a three-digit number. The red LED (Fault) lights up.

On the OP1S: On bottom line of operational display: The red LED (Fault) lights up.

Only one current fault message can be displayed at a time, i.e. other simultaneously active faults are ignored.

Many fault messages (see List of Fault Messages) can only be active in certain operating states.

The system responses to a fault are as follows:

- The armature current is reduced, the firing pulses are disabled and the SIMOREG unit switches to operating state o11.0 (fault)
- Fault message is displayed on the operator panel (PMU, OP1S)
- B0106 (= status word 1, bit 3) is set and B0107 cancelled (see also alarm bits for special faults such as undervoltage, overtemperature, external faults, etc.)
- The following parameters are refreshed:
 - r047 fault diagnostic memory
(The displayed values are decimal. For bit-serial evaluation, the values must be converted from decimal to binary notation, e.g. to be able to determine the relevant terminal in the case of F018)
 - r049 Fault time
 - r947 fault memory, see also r947 in Section 11, Parameter List
 - r949 fault value
(The displayed values are decimal. For bit-serial evaluation, the values must be converted from decimal to binary notation, e.g. to be able to determine the

relevant terminal in the case of F018)
P952 number of faults

A text is also displayed for each individual fault in parameter r951 (fault text list). These texts can, for example, be displayed on the OP1S.

If a fault is not acknowledged before the electronics supply voltage is switched off, then fault message F040 will be displayed when the supply is next switched on.

9.1.2 List of fault messages

NOTE

Further information about the causes of fault messages

When a fault message is activated, values providing more information about the fault cause are stored in parameter r047. Where the values can be interpreted by the user, they are included in the following list of fault messages.

The value in r047.001 is referred to as the "fault value". This is also stored in r949 which also contains the fault values belonging to older fault messages. The values in r047 are overwritten when the next fault message occurs.

Values for r047 which are not included in the list below can help a SIEMENS specialist to locate a fault cause. For this reason, all indices of parameter r047 should be read out whenever a fault message occurs, even if the meaning of the individual indices of parameter r047 is not specified for every fault message listed below.

Please note: Before you contact SIEMENS with any query regarding a fault message, please make a note of the contents of all indices of parameter r047.

Fault No.	Description	
	Cause as a function of fault value (r047.001, r949.001 or r949.009 with acknowledged error)	Further information (r047.002 to r047.016)

9.1.2.1 Supply faults

F001	Failure of electronics power supply (active in all operating states)	
	Failure of the electronics supply voltage (terminals 5U1, 5W1, 5N1) in "RUN" state for longer than the "restart" time set in parameter P086 or the electronics are operating on undervoltage.	
	Possible fault causes:	
	<ul style="list-style-type: none"> ◆ Line contactor has opened in "RUN" state ◆ Brief supply failure ◆ Supply voltage too low 	
	Fault value:	r047 Index 002 to 016:
	1 Electronics supply voltage in "RUN" has been interrupted for longer than setting in P086	i002 Duration of actual supply failure in 1/10 seconds
	2 Supply failure prewarning responds periodically	-
	3 Supply failure prewarning is active for longer than 1.28 s	-

Fault No.	Description	
	Cause as a function of fault value (r047.001, r949.001 or r949.009 with acknowledged error)	Further information (r047.002 to r047.016)
F004	<p>Phase failure in armature supply (active in operating states of ≤ o4)</p> <p>The supply voltage RMS value, calculated from the area of each supply half-wave (rectified average value * peak factor), must be greater than the response value for phase failure monitoring</p> $P078.001 * \frac{P353}{100\%}$ <p>The distance between two identical supply zero passages of a phase must not exceed 450 degrees. If one of these two conditions remains unfulfilled for longer than the "restart time" set in P086, a fault message is activated. After switch-on, the converter waits in operating states o4 and o5 together for a period not exceeding the setting in P089 for voltage to appear at the power terminals (and for field current) before activating the fault message.</p> <p>Possible fault causes:</p> <ul style="list-style-type: none"> ◆ Parameter P353 is incorrectly set ◆ Armature phase has failed ◆ Line contactor opened in operation ◆ Fuse has blown on three-phase side in armature circuit ◆ Fuse has blown in power section ◆ Interruption in a thyristor firing pulse cable (auxiliary cathodes at connectors X12, X14, X16 are voltage carriers). <p>Fault value:</p>	
	<ol style="list-style-type: none"> 1 Voltage failure has occurred in armature supply (1U1, 1V1, 1W1) (when P086=0) 2 Delay time set in parameter P089 has expired in operating state o4 3 Fuse has blown in power section 4 Voltage failure has lasted longer than period set in P086 (if this is >0) 6 The "Main contactor checkback" (control word 2 bit 31) [see also P691] did not switch to "1" before the time set in P095 ran out, or switched back to "0" during operation [V1.8 and later]. 	
F005	<p>Fault in the field circuit (active in operating states of ≤ o5)</p> <p>The line voltage RMS value calculated from the area of each network half-wave (rectification average value * peak factor) must be greater than the response value for phase failure monitoring</p> $P078.002 * \frac{P353}{100\%}$ <p>The distance between two identical network zero passages of the voltage for the field converter must not exceed 450 degrees.</p> <p>The actual field current K0265 equals < 50% of the required field current setpoint K0268 for more than 500ms. This monitoring function is effective only if the field current setpoint corresponds to >2% of the converter rated field current. [In SW 1.9 and later, the percentage (50%) and time (500ms) can be altered in P396 and P397 respectively]</p> <p>If one of the fault conditions described persists in operation (or ≤ o4) for longer than the "restart" time set in P086, the fault message is output.</p> <p>After the converter is switched on, it waits in operating state o5 for a period not exceeding the setting in P089 for the field supply voltage or sufficiently high field current before this fault message is activated.</p> <p>Monitoring for timeout as the field decays or builds up after initiation of field reversal (fault values 6 and 7) is not implemented until SW 1.7 and later.</p> <p>Possible fault causes</p> <ul style="list-style-type: none"> ◆ Threshold for phase failure (P353) set incorrectly ◆ Field phase failed ◆ Line contactor opened during operation ◆ Fuse blown in the field circuit ◆ Field current controller and/or field current precontrol not optimized or badly optimized (check P112, P253 to P256; possibly execute current controller optimization) ◆ Check P396 (field current monitoring threshold) and P397 (field current monitoring time) ◆ If the fault value is 6: Offset fault in the actual field current value sensing, relevant parameter: P825.i01-i03 (Offset depends on P076.i02) or P394, P395 (Threshold and hysteresis for message I_field < I_field_min) must be checked ◆ If the fault value is 7: Circuit for the "new" field direction is interrupted (e.g. because the contactor for "new" field direction does not pick up), P398, P399 (Threshold and hysteresis for message I_field < I_field_x) must be checked 	

Fault No.	Description	
	Cause as a function of fault value (r047.001, r949.001 or r949.009 with acknowledged error)	Further information (r047.002 to r047.016)
	Fault value: 1 Voltage failure occurred in the field supply (terminals 3U1 and 3W1) (if P086 = 0) 2 Delay time according to P089 elapsed in state o5.1 (waiting for voltage at the field power section) 3 Delay time according to P089 elapsed in state o5.0 (waiting until I _{field act} (K0265) is > 50% of the instantaneous field current setpoint K0268) [threshold settable in P396 as of SW 1.9] 4 After P086 > 0 has elapsed (time for automatic restart) in operating state ≤ o4: Voltage failure in the field supply or I _{field act} (K0265) < 50% I _{field set} (K0268) for longer than 500 ms [settable via P396 and P397 as of SW 1.9] 5 When P086 = 0 (no automatic restart) in operating state ≤ o4: I _{field act} (K0265) < 50% I _{field set} (K0268) for longer than 500 ms [settable via P396 and P397 as of SW 1.9] 6 If field reduction before field reversal, I _{field} ≤ I _{field_min} (P394) is not reached within 30 s 7 If field build-up after field reversal, I _{field} > I _{field_x} (P398) is not reached within 30 s	
F006	Undervoltage (active in operating states of ≤ o4) The voltage at terminals 1U1, 1V1 or 1W1 and 3U1, 3W1 is lower than the response threshold for longer than the "restart time" set in P086. Response threshold for armature supply voltage: $P078.001 * (1 + \frac{P351}{100\%})$ Response threshold for field supply voltage: $P078.002 * (1 + \frac{P351}{100\%})$ Possible fault causes <ul style="list-style-type: none"> ◆ Line undervoltage ◆ Monitoring values set too sensitively or incorrectly (P351, P078) Fault value: r047 Index 002 to 016:	
	1 Undervoltage has occurred	i002 Number of phase that has activated fault message 0 ... Phase UV 1 ... Phase VW 2 ... Phase WU 3 ... Phase field i003 Incorrect voltage value (normalized to 16384)
	4 Undervoltage persists for longer than time set in parameter P086 (if this is set to >0)	-
F007	Overvoltage (active in operating states of ≤ o4) The voltage at terminals 1U1, 1V1 or 1W1 and 3U1, 3W1 is higher than the response threshold (for longer than the "restart time" set in P086). Response threshold for armature supply voltage: $P078.001 * (1 + \frac{P352}{100\%})$ Response threshold for field supply voltage: $P078.002 * (1 + \frac{P352}{100\%})$ Possible fault causes <ul style="list-style-type: none"> ◆ Line overvoltage ◆ Monitoring values set too sensitively or incorrectly (P352, P078) 	

Fault No.	Description	
	Cause as a function of fault value (r047.001, r949.001 or r949.009 with acknowledged error)	Further information (r047.002 to r047.016)
	<p>NOTICE</p> <p>This monitoring function is deactivated in the delivery state. It can be activated via parameter P820.</p>	
	<p>Fault value: r047 Index 002 to 016:</p>	
	1 Overvoltage has occurred	002 Number of phase that has activated fault message 0....Phase UV 1....Phase VW 2....Phase WU 3....Phase field i003 Incorrect voltage value (normalized to 16384)
	4 Undervoltage persists for longer than time set in parameter P086 (if this is >0)	-
F008	<p>Line frequency less than the minimum line frequency acc. to parameter P363 (active in operating states of $\leq o5$)</p> <p>This fault message is activated if the line frequency is less than the minimum line frequency (for longer than the "restart time" set in parameter P086).</p> <p><u>Note:</u> Up to software version 1.7 the threshold for activation of the fault message (minimum line frequency) is 45Hz.</p> <p>Fault value:</p>	
	<p>1 Frequency of the armature supply < minimum line frequency</p> <p>2 Frequency of the field supply < minimum line frequency</p> <p>4 Line frequency less than the minimum line frequency for longer than set in parameter P086 (if >0)</p>	
F009	<p>Line frequency greater than the maximum line frequency acc. to parameter P364 (active in operating states of $\leq o5$)</p> <p>This fault message is activated if the line frequency is greater than the maximum line frequency (for longer than the "restart time" set in parameter P086).</p> <p><u>Note:</u> Up to software version 1.7 the threshold for activation of the fault message (maximum line frequency) is 65Hz</p> <p>Fault value:</p>	
	<p>1 Frequency of the armature supply > maximum line frequency</p> <p>2 Frequency of the field supply > maximum line frequency</p> <p>4 Line frequency greater than the maximum line frequency for longer than set in parameter P086 (if >0)</p>	

9.1.2.2 Interface error

F011	<p>Telegram failure at GSST1</p> <p>when P780 = 2:</p> <p>USS telegram failure at G-SST1 (active from the first receipt of a valid protocol in all operating states)</p> <p>After the receipt of the first valid protocol, no further telegrams have been received within the time period set in parameter P787.</p> <p>Possible fault causes</p> <ul style="list-style-type: none"> ◆ Cable break ◆ Error in USS master
-------------	--

Fault No.	Description	
	Cause as a function of fault value (r047.001, r949.001 or r949.009 with acknowledged error)	Further information (r047.002 to r047.016)
F012	<p>Telegram failure at GSST2</p> <p>when <u>P790 = 2</u>:</p> <p>USS telegram failure at G-SST2 (active from the first receipt of a valid protocol in all operating states)</p> <p>After the receipt of the first valid protocol, no further telegrams have been received within the time period set in parameter P797.</p> <p>Possible fault causes</p> <ul style="list-style-type: none"> ◆ Cable break ◆ Error in USS master <p>when <u>P790 = 4 or 5</u> and <u>P798 = 32 or 33</u>:</p> <p>Peer-to-peer telegram failure at G-SST2 (active in operating states of ≤ 06)</p> <p>After the receipt of the first valid protocol, no further telegrams have been received within the time period set in parameter P797.</p> <p>Possible fault causes</p> <ul style="list-style-type: none"> ◆ Interruption in connecting cable ◆ EMC interference on connecting cable ◆ P797 is set too low 	
F013	<p>Telegram failure at GSST3</p> <p>when <u>P800 = 2</u> and <u>P808 = 32 or 33</u>:</p> <p>USS telegram failure to G-SST3 (active from the first receipt of a valid protocol in all operating states)</p> <p>After the receipt of the first valid protocol, no further telegrams have been received within the time period set in parameter P807.</p> <p>Possible fault causes</p> <ul style="list-style-type: none"> ◆ Cable break ◆ Error in USS master <p>when <u>P800 = 4 or 5</u>:</p> <p>Peer-to-peer telegram failure at G-SST3 (active in operating states of ≤ 06)</p> <p>After the receipt of the first valid protocol, no further telegrams have been received within the time period set in parameter P807.</p> <p>Possible fault causes</p> <ul style="list-style-type: none"> ◆ Interruption in connecting cable ◆ EMC interference on connecting cable ◆ P807 is set too low 	
F014	<p>Telegram failure at paralleling interface (active when <u>U800 = 1 or 2</u> from the first receipt of a valid protocol in all operating states)</p> <p>After the receipt of the first valid protocol, no further telegrams have been received within the time period set in parameter U807.</p> <p>Possible fault causes</p> <ul style="list-style-type: none"> ◆ Interruption in connecting cable ◆ EMC interference on connecting cable ◆ U807 is set too low 	

Fault No.	Description	
	Cause as a function of fault value (r047.001, r949.001 or r949.009 with acknowledged error)	Further information (r047.002 to r047.016)
F015	Telegram failure on one SIMOLINK board (active when $U741 > 0$ as soon as the first valid telegram is received)	
	After receipt of one valid telegram, no further valid telegrams have arrived within the period set in parameter U741. Possible fault causes <ul style="list-style-type: none"> ◆ Break in connecting cable ◆ Parameter setting change during telegram exchange (for parameters see Section 11 "Configuration of SIMOLINK board) ◆ U741 is set to low 	
Fault value:		
1 Telegram failure on 1 st SLB 2 Reserved		
F016	Hardware fault on expansion board EB1	
	Fault value:	
1 Fault on first EB1 2 Fault on second EB1		
F017	Hardware fault on expansion board EB2	
	Fault value:	
1 Fault on first EB2 2 Fault on second EB2		
F018	Short circuit or overloading of binary outputs (active in all operating states)	
	Possible fault causes <ul style="list-style-type: none"> ◆ Short circuit or overload at terminals 46, 48, 50 or 52 and 26 or 34 	
Fault value: r047 Index 002 to 016:		
1 Short circuit or overload at binary outputs		i002 Bit 8 = 1: Overload at terminal 46 Bit 9 = 1: Overload at terminal 48 Bit 10 = 1: Overload at terminal 50 Bit 11 = 1: Overload at terminal 52 Bit 12 = 1: Overload at terminal 26 (15 V output) Bit 13 = 1: Overload at terminal 34, 44 and/or 210 (24 V output)
NOTICE This monitoring function is deactivated in the delivery state. It can be activated via parameter P820.		

9.1.2.3 External faults

F019	Fault message from free function block FB286 (active in all operating states)	
	Fault value:	
1 the binector wired via parameter U100 Index.005 is in the state log."1" 2 the binector wired via parameter U100 Index.006 is in the state log."1" 3 the binector wired via parameter U100 Index.007 is in the state log."1" 4 the binector wired via parameter U100 Index.008 is in the state log."1"		
F020	Fault message from free function block FB287 (active in all operating states)	
	Fault value:	
1 the binector wired via parameter U101 Index.005 is in the state log."1" 2 the binector wired via parameter U101 Index.006 is in the state log."1" 3 the binector wired via parameter U101 Index.007 is in the state log."1" 4 the binector wired via parameter U101 Index.008 is in the state log."1"		

Fault No.	Description	
	Cause as a function of fault value (r047.001, r949.001 or r949.009 with acknowledged error)	Further information (r047.002 to r047.016)
F021	External fault 1 (active in all operating states) Bit 15 in control word 1 was in the log. "0" state for longer than the time set in P360 index 001	
F022	External fault 2 (active in all operating states) Bit 26 in control word 2 was in the log. "0" state for longer than the time set in P360 index 002	
F023	Fault message from free function block FB2 (active in all operating states) Fault value: 1 the binector wired via parameter U100 Index.001 is in the state log."1" 2 the binector wired via parameter U100 Index.002 is in the state log."1" 3 the binector wired via parameter U100 Index.003 is in the state log."1" 4 the binector wired via parameter U100 Index.004 is in the state log."1"	
F024	Fault message from free function block FB3 (active in all operating states) Fault value: 1 the binector wired via parameter U101 Index.001 is in the state log."1" 2 the binector wired via parameter U101 Index.002 is in the state log."1" 3 the binector wired via parameter U101 Index.003 is in the state log."1" 4 the binector wired via parameter U101 Index.004 is in the state log."1"	

9.1.2.4 Fault messages from motor sensors

F025	Brush length too short (active in operating states of ≤ 03) When parameter P495=2 (binary sensing of brush length), fault message at log."0" signal (longer than 10s) at terminal 211 Possible fault causes ◆ Encoder for brush length has responded ◆ Open circuit in encoder cable
F026	Bearings in bad condition (active in operating states of ≤ 06) When parameter P496=2 (bearing condition sensing) fault message at log. "1" signal (longer than 2 s) at terminal 212 Possible fault causes ◆ Encoder for bearing condition has responded
F027	Air-flow monitoring of motor fan (active in operating states of < 06) When parameter P497=2 (air-flow monitoring), fault message at log "0" signal (longer than 40s) at terminal 213 Possible fault causes ◆ Encoder for fan monitoring has responded ◆ Open circuit in encoder cable
F028	Motor overtemperature (active in operating states of ≤ 06) When parameter P498=2 (thermostat connected), fault message at log. "0" signal (longer than 10s) at terminal 214 Possible fault causes ◆ Thermostat for monitoring motor temperature has responded ◆ Open circuit in encoder cable

Fault No.	Description	
	Cause as a function of fault value (r047.001, r949.001 or r949.009 with acknowledged error)	Further information (r047.002 to r047.016)
F029	Motor overtemperature (active in all operating states) Select via P493=2 or 3 (temperature sensor at terminals 22 / 23) or P494=2 or 3 (temperature sensor at terminals 204 / 205) <u>When parameter P490.01=1 (KTY84 at terminals 22 / 23) or P490.02=1 (KTY84 at terminals 204 / 205):</u> The fault message is activated if the motor temperature reaches or exceeds the value set in parameter P492. <u>When parameter P490.01=2, 3, 4 or 5 (PTC thermistor at terminals 22 / 23) or P490.02=2, 3, 4 or 5 (PTC thermistor at terminals 204 / 205):</u> The fault message is activated if the motor temperature reaches or exceeds the response value of the selected PTC thermistor. Fault value:	
	1	Fault activation through temperature sensor at terminals 22 / 23
	2	Fault activation through temperature sensor at terminals 204 / 205

9.1.2.5 Drive faults

NOTICE

The monitoring functions F031, F035, F036, and F037 are deactivated in the delivery state. They can be activated via parameter P820.

F030	Commutation failure or overcurrent has occurred (active in operating states of --, I, II) Possible error causes <ul style="list-style-type: none"> ◆ Mains voltage dip in regenerative feedback mode ◆ Current control loop not optimized 	
	Fault value: r047 Index 002 to 016:	
	1	The blocking voltage time area for the commutating thyristor pair was too small
	2	The current crest curve breaks upwards
	3	The maximum current value was higher than 250% of rated device current
	4	A paralleled SIMOREG DC Master has detected a commutation failure or overcurrent
		i002 Delay angle (K0100) in case of error
		i003 Actual EMF (K0287) in case of error
		i004 Trigger circuitry diagnostics (K0989) in case of error
		i005 Actual field current (K0265) in case of error
		i006 Number of pulses (K0105) in case of error
F031	Speed controller monitoring (active in operating states of --, I, II) The monitor responds when the difference between the connectors selected in P590 and P591 (factory setting: Setpoint/actual value difference of speed controller) exceeds the limit set in parameter P388 for longer than the time set in parameter P390. Possible fault causes <ul style="list-style-type: none"> ◆ Open control loop ◆ Controller not optimized ◆ P590 or P591 is not correctly parameterized 	

9.1.2.6 External faults

F033	Fault message from free function block FB4 (active in all operating states) Fault value:	
	1	the binector wired via parameter U102 Index.001 is in the state log."1"
	2	the binector wired via parameter U102 Index.002 is in the state log."1"
	3	the binector wired via parameter U102 Index.003 is in the state log."1"
	4	the binector wired via parameter U102 Index.004 is in the state log."1"

Fault No.	Description	
	Cause as a function of fault value (r047.001, r949.001 or r949.009 with acknowledged error)	Further information (r047.002 to r047.016)
F034	Fault message from free function block FB5 (active in all operating states)	
	Fault value:	
	1	the binector wired via parameter U103 Index.001 is in the state log."1"
	2	the binector wired via parameter U103 Index.002 is in the state log."1"
	3	the binector wired via parameter U103 Index.003 is in the state log."1"
	4	the binector wired via parameter U103 Index.004 is in the state log."1"

9.1.2.7 Drive faults

F035	<p>Drive is blocked (active in operating states of --, I, II)</p> <p>This monitoring function responds if the following conditions are fulfilled for longer than the period set in parameter P355:</p> <ul style="list-style-type: none"> ◆ Positive or negative torque or armature current limit ◆ The armature current is higher than 1% of the converter rated armature DC current ◆ The actual speed is less than 0.4% of maximum speed <p>Possible fault causes</p> <ul style="list-style-type: none"> ◆ Drive is blocked
F036	<p>No armature current is flowing (active in operating states of --, I, II)</p> <p>This monitoring function responds if the armature firing angle is at the rectifier stability limit for more than 500 ms and the armature current is less than 1% of the converter rated armature DC current.</p> <p>Possible fault causes</p> <ul style="list-style-type: none"> ◆ Armature circuit is open (e.g. DC fuses have blown, open circuit, etc.) ◆ Rectifier stability limit α_G (P150) is incorrectly set ◆ Drive is operating at α_G limit (e.g. due to supply undervoltage) ◆ EMF is too high because maximum speed setting is too high, refer to P083, P115, P143, P741) ◆ EMF is too high because field weakening is not selected (refer to P082) ◆ EMF is too high because field current is set too high (refer to P102) ◆ EMF is too high because transition speed for field weakening is set too high (refer to P101) ??
F037	<p>I²t motor monitor has responded (active in operating states of --, I, II)</p> <p>This monitoring function responds when an I²t value is reached which corresponds to the final temperature at 110% of the rated motor armature current.</p> <p>Possible fault causes</p> <ul style="list-style-type: none"> ◆ Parameter P114 is incorrectly set ◆ Drive has been operating for too long at >110% of rated motor armature current
F038	<p>Overspeed (active in operating states of --, I, II)</p> <p>This fault message is activated if the actual speed value (selected in P595) exceeds the positive (P380) or negative (P381) threshold by 0.5%.</p> <p>Possible fault causes</p> <ul style="list-style-type: none"> ◆ Lower current limit has been input ◆ Current-controlled operation ◆ P512, P513 are set too low ◆ Tachometer cable contact fault in operation close to maximum speed

Fault No.	Description	
	Cause as a function of fault value (r047.001, r949.001 or r949.009 with acknowledged error)	Further information (r047.002 to r047.016)
F039	<p>I²t power section monitor has responded (active in operating states of --, I, II)</p> <p>This monitoring function responds if the calculated I²t value of the power section reaches the permissible value for the power section concerned (see also P075).</p> <p>Possible fault causes</p> <ul style="list-style-type: none"> ◆ Drive has been operating at overload for too long ◆ Parameter P075 is incorrectly set ◆ Parameter P077 is incorrectly set 	
F040	<p>Electronics supply disconnected in active fault status (active in all operating states)</p> <p>This fault message is activated if the electronics power supply has been disconnected, even though a fault was displayed and not yet acknowledged.</p> <p>Possible fault causes</p> <ul style="list-style-type: none"> ◆ Not all fault messages have been acknowledged <p>Fault value:</p> <p>Last active fault message</p>	
F041	<p>Ambiguous selection of parameter set or ramp-function generator (active in all operating states)</p> <ul style="list-style-type: none"> ◆ While an optimization run is in progress, the function data set selection must not be changed. Fault F041 is displayed if another, different function data set is selected while an optimization run is being executed. ◆ Check whether ramp-function generator parameter set 1 or 2 or 3 (parameters P303 to P314) is clearly selected. If parameter sets 2 and 3 are selected simultaneously for more than 0.5s, then fault message F041 is displayed. While the parameter set selection is ambiguous, the system continues to apply the last clearly identified ramp-function generator parameters. <p>Possible fault causes</p> <ul style="list-style-type: none"> ◆ P676 or P677 (selection of binectors which determine the active function data set in control word 2, bits 16 and 17) is incorrectly set ◆ P637 or P638 (selection of binectors which determine ramp-function generator setting) is incorrectly set <p>Fault value:</p> <p>2 The selection of the function data set has been changed during an optimization run</p> <p>3 Ambiguous selection of ramp-function generator parameter set</p>	

Fault No.	Description						
	Cause as a function of fault value (r047.001, r949.001 or r949.009 with acknowledged error)	Further information (r047.002 to r047.016)					
F042	Tachometer fault (active in operating states of --, I, II)						
	<p>A check is performed every 20ms to ensure that $\frac{\text{Actual speed (K0179)}}{\text{Actual EMF (K0287)}}$ is > +5%</p> <p>If the check result is incorrect for 4 times in succession, the fault message is activated.</p> <p>The following rule applies: 100% actual speed = maximum speed 100% actual EMF = ideal average DC voltage at $\alpha \geq 0$, i.e. when the thyristor bridge is fully gated</p> <p>The ideal DC voltage average value at $\alpha = 0$ is $P078.001 * \frac{3 * \sqrt{2}}{\pi}$</p> <p>The monitoring function is effective only if the EMF > a % of $P078.001 * \frac{3 * \sqrt{2}}{\pi}$</p> <p>"a" is a percentage that can be set in parameter P357 (default setting 10%). The monitoring function is effective only if the armature current is > 2% of the converter rated DC current set in r072.002.</p> <p>Possible fault causes</p> <ul style="list-style-type: none"> ◆ Open circuit in tachometer or pulse encoder cable. ◆ Tachometer or pulse encoder cable incorrectly connected. ◆ Pulse encoder supply has failed. ◆ Polarity for actual speed value (P743) is incorrectly set. ◆ Armature circuit data (P110 und P111) are incorrectly set (execute current controller optimization run). ◆ Tachometer or pulse encoder defective ◆ Pulse encoder supply voltage is incorrectly set (P140) ◆ The field polarity is not reversed by the external hardware when the field is reversed. <p>Fault value: r047 Index 002 to 016:</p> <table border="1" style="width: 100%; border-collapse: collapse;"> <tr> <td style="width: 5%; text-align: center;">1</td> <td style="width: 45%;">Open circuit in tachometer or pulse encoder cable</td> <td style="width: 50%;">i002 Actual speed value (K0179) in case of fault</td> </tr> <tr> <td style="text-align: center;">2</td> <td>Polarity of tachometer or pulse encoder is incorrect</td> <td>i003 Actual EMF value (K0287) in case of fault</td> </tr> </table>		1	Open circuit in tachometer or pulse encoder cable	i002 Actual speed value (K0179) in case of fault	2	Polarity of tachometer or pulse encoder is incorrect
1	Open circuit in tachometer or pulse encoder cable	i002 Actual speed value (K0179) in case of fault					
2	Polarity of tachometer or pulse encoder is incorrect	i003 Actual EMF value (K0287) in case of fault					

Fault No.	Description	
	Cause as a function of fault value (r047.001, r949.001 or r949.009 with acknowledged error)	Further information (r047.002 to r047.016)
F043	EMF too high for braking operation (active in operating states of --, I, II) This fault message is activated if the following 5 conditions are fulfilled when a <u>torque direction reversal is requested</u> (selection of MI or MII): <ul style="list-style-type: none"> ◆ P272=0 (fault message is parameterized and not alarm + field weakening) ◆ A parameterized, additional, torque-free interval (P160 ≠ 0) has expired ◆ Parallel drive is ready for engagement of the new torque direction ◆ The absolute value of the <u>armature current (K0118)</u> requested in the new torque direction is <u>≥0.5% of P072</u> ◆ The <u>calculated firing angle (K0101)</u> for the armature current requested for the new torque direction is <u>≥165 degrees</u>. Possible fault causes <ul style="list-style-type: none"> ◆ No "speed-dependent field weakening" (P081=0) is parameterized even though operation in the field weakening range is needed for the requested maximum speed Note: In motor operation, it is possible to reach EMF values corresponding to the peak of the phase-to-phase supply voltage at a firing angle of $\alpha_G=30^\circ$ (rectifier stability limit P150) and low armature currents. ◆ Setpoint EMF for field weakening operation too high (parameter P101 is set too high) ◆ Supply voltage dip ◆ EMF controller or field current controller is not optimized, possibly resulting in excessive EMF on power-up. Fault value: r047 Index 002 to 016:	
	Calculated firing angle (armature) before limitation (K0101)	i002 Instantaneously measured actual EMF (K0287) i003 Armature current controller setpoint (K0118)
F044	A slave connected to the paralleling interface is not operating (active when <u>U800 = 1 or 2 and U806>10 (master)</u> after receipt of the first valid protocol in operating states --, I, II) Fault value:	
	1	A fault message is active on a slave
	2	A slave is not in operation (e.g. because its enable input is set to "0")
F046	Analog select input for main setpoint (terminals 4 and 5) faulty (active in operating states of ≤ o6) This fault message is activated when P700=2 (current input 4 to 20 mA) and an input current of less than 2mA is flowing. Possible fault causes <ul style="list-style-type: none"> ◆ Open circuit in supply cable ◆ P700 is incorrectly set 	
F047	Analog select input 1 (terminals 6 and 7) is faulty (active in operating states of ≤ o6) This fault message is activated when P710=2 (current input 4 to 20 mA) and an input current of less than 2mA is flowing. Possible fault causes <ul style="list-style-type: none"> ◆ Open circuit in supply cable ◆ P710 is incorrectly set 	

Fault No.	Description				
	Cause as a function of fault value (r047.001, r949.001 or r949.009 with acknowledged error)	Further information (r047.002 to r047.016)			
F048	Fault in measuring channel for digital speed sensing using pulse encoder (active in all operating states)				
	<p><u>1. Disturbances on encoder cables:</u> Faults on the encoder cables (transitions to 0 with a 1 signal or to 1 with a 0 signal) are signalled as a rotational direction change by the evaluation circuit. Frequent changes in rotational direction can occur only at speeds around 0. The fault message is activated if 10 consecutive pulse encoder signal evaluations identify "direction of rotation change" at a speed of ≥ 48 rev/min and an EMF > threshold (see below).</p> <p><u>2. Pulse encoder defective:</u> The fault message is activated if, at an EMF > threshold (see below) 10 consecutive pulse encoder signal evaluations identify "implausible characteristics" of these signals (i.e. frequent rotational direction changes, edges too close together, failure of an encoder cable or short circuit between two encoder cables).</p> <p>Possible fault causes</p> <ul style="list-style-type: none"> ◆ EMC-related interference on a pulse encoder signal (terminals 28 to 31) ◆ Pulse encoder defective ◆ Interruption in an encoder cable ◆ Short circuit between an encoder cable and the supply voltage or another encoder cable ◆ P110 or P111 is incorrectly set (resulting in incorrect calculation of EMF) <p>Note: When the speed encoder is operating correctly, signal sequences, which are characteristic of a faulty pulse encoder or disturbances on the pulse encoder cables, may occur continuously at the input terminals (e.g. continuous changes in rotational direction or short pulse intervals) at about 0 speed, e.g. as the result of slight oscillation around a bright/dark transition on the speed encoder disk.</p> <p>For this reason, fault F048 is not activated until the $EMF > 10\% \text{ of } P078.001 * \frac{3 * \sqrt{2}}{\pi}$.</p> <p>Fault value:</p> <table border="1"> <tr> <td>1</td> <td>Disturbances on encoder cables</td> </tr> <tr> <td>2</td> <td>Defective pulse encoder</td> </tr> </table>		1	Disturbances on encoder cables	2
1	Disturbances on encoder cables				
2	Defective pulse encoder				

9.1.2.8 Start-up faults

F050	Optimization run not possible (active in all operating states)			
	A fault has occurred during an optimization run.			
	<p>NOTE</p> <p>The contents of r047, Index 002 to 016, can provide specialists with more detailed information about fault causes. For this reason, please read out and document all the indices associated with this fault and pass them on when you contact Siemens for help.</p> <p>Fault value:</p> <table border="1"> <tr> <td>1</td> <td>Armature current is too low when $\alpha=30^\circ$ and EMF=0. (average armature current <75% of I_A, motor or <75% of I_A, rated) Possible cause: <ul style="list-style-type: none"> • Armature circuit interrupted • High-resistance load • P150 (Alpha G limit) has been set to excessively high value </td> </tr> <tr> <td>2</td> <td>It was not possible to determine the armature circuit resistance (P110) because the armature current was $\geq 37.5\%$ of P100 in fewer than 20 of the 150 firing cycles of the measuring phase. Possible cause: <ul style="list-style-type: none"> • Armature current of 37.5% of P100 (I_A, motor) is no longer possible (although a current of 75% of P100 was already flowing, maybe a fuse has blown). </td> </tr> </table>	1	Armature current is too low when $\alpha=30^\circ$ and EMF=0. (average armature current <75% of I_A , motor or <75% of I_A , rated) Possible cause: <ul style="list-style-type: none"> • Armature circuit interrupted • High-resistance load • P150 (Alpha G limit) has been set to excessively high value 	2
1	Armature current is too low when $\alpha=30^\circ$ and EMF=0. (average armature current <75% of I_A , motor or <75% of I_A , rated) Possible cause: <ul style="list-style-type: none"> • Armature circuit interrupted • High-resistance load • P150 (Alpha G limit) has been set to excessively high value 			
2	It was not possible to determine the armature circuit resistance (P110) because the armature current was $\geq 37.5\%$ of P100 in fewer than 20 of the 150 firing cycles of the measuring phase. Possible cause: <ul style="list-style-type: none"> • Armature current of 37.5% of P100 (I_A, motor) is no longer possible (although a current of 75% of P100 was already flowing, maybe a fuse has blown). 			

Fault No.	Description	
	Cause as a function of fault value (r047.001, r949.001 or r949.009 with acknowledged error)	Further information (r047.002 to r047.016)
3	<p>Armature current peaks are too small at $\alpha=30^\circ$ and EMF=0 (armature current peak value <50% of $I_{A, motor}$ or <50% of $I_{A, rated}$)</p> <p>Possible cause:</p> <ul style="list-style-type: none"> • Armature circuit inductance is too high (field supply from armature terminals) • P150 (Alpha G limit) has been set to excessively high value <p>Possible remedy:</p> <ul style="list-style-type: none"> • Reduce P100 ($I_{A, motor}$) while this optimization run is in progress 	
4	<p>The armature circuit inductance (P111) cannot be determined from the sampled values of the armature current and line voltage of the armature current crest last generated</p> <p>Possible cause:</p> <ul style="list-style-type: none"> • P100 ($I_{A, motor}$) or r072.i002 ($I_{A, rated}$) very much smaller than actual motor rated current of the armature • $L_A > 327.67\text{mH}$ (armature circuit inductance too large) • P100 ($I_{A, motor}$) very much smaller than r072.i002 ($I_{A, rated}$) • Armature circuit short-circuited 	
5	<p>Offset adjustment of actual field current sensing is not possible (value detected for P825 is outside permissible value range)</p> <p>Possible cause:</p> <ul style="list-style-type: none"> • Fault in actual field current sensing circuit (defective A7004 gating board or A7001 electronics board) 	
7	<p>The field circuit resistance (P112) is indeterminable (the actual field current does not reach the internally specified setpoint of 95% of P102 as a result of P112 variation)</p> <p>Possible cause:</p> <ul style="list-style-type: none"> • $R_A > 3276.7\Omega$ • Fault in actual field current sensing circuit (defective gating board or A7001 electronics board) • The command "Inject standstill field" is applied • P102 is set too high • A thyristor in the field bridge is not firing 	
8	<p>80% of rated EMF ($K287=P101 - P100 * P110$) cannot be reached within 15s (or maximum of the three set acceleration times)</p> <p>Possible cause:</p> <ul style="list-style-type: none"> • Acceleration time (P303, P307, P311) is set too low • P101 does not match the set maximum speed (U_A at $n_{max} < P101$) or setting for P102 is too low • The command "Ramp-function generator enable"=0 or "Ramp-function generator stop"=1 	
9	<p>Field current control loop is not stable enough to record field characteristics (30s after injection of internal field current setpoint, actual field current is deviating by more than (0.39% of P102 + 0.15 % of r073.002) from the setpoint)</p> <p>Possible cause:</p> <ul style="list-style-type: none"> • Field current controller or field current precontrol is not optimized or optimized badly (check P112, P253 to P256 or execute a current controller optimization run (P051=25)) 	
10	<p>Field characteristic is not uniform (i.e. in spite of field current setpoint reduction, the flux values of this measuring point calculated from EMF and actual speed are rising)</p> <p>Possible cause:</p> <ul style="list-style-type: none"> • High armature reaction and sharp load variations during recording of field characteristics • Field current controller or field current precontrol is not optimized or optimized badly (check P112, P253 to P256 or execute a current controller optimization run (P051=25)) 	
11	<p>A lower field current limit of $\geq 50\%$ of P102 ($I_{F, motor}$) is applied (for this reason, it is not possible to plot a minimum of 9 field weakening measuring points)</p> <p>Possible cause:</p> <ul style="list-style-type: none"> • $P103 \geq 50\%$ of P102 <p>Check P614 !</p>	

Fault No.	Description	
	Cause as a function of fault value (r047.001, r949.001 or r949.009 with acknowledged error)	Further information (r047.002 to r047.016)
12	<p>The drive has reached the positive torque limit even though the applied field current setpoint is still $\geq 50\%$ of P102 ($I_{F,motor}$)</p> <p>Possible cause:</p> <ul style="list-style-type: none"> Armature current is very "unsteady", e.g. due to high speed controller P gain setting in P225 (on drive with high integral-action time). In this case, setting a lower actual speed filtering value in P200 and execution of another speed controller optimization run (P051=26) may help. Check torque limits 	
13	<p>The drive has reached the positive armature current limit even through the applied field current setpoint is still $\geq 50\%$ of P102 ($I_{F,motor}$)</p> <p>Possible cause:</p> <ul style="list-style-type: none"> Armature current is very "unsteady", e.g. due to high speed controller P gain setting in P225 (on drive with high integral-action time). In this case, setting a lower actual speed filtering value in P200 and execution of another speed controller optimization run (P051=26) may help Check armature current limits 	
14	<p>The speed has changed by more than 12.5% at a constant speed setpoint even through the applied field current setpoint is still $\geq 50\%$ of P102 ($I_{F,motor}$)</p> <p>Possible cause: as for fault value 12</p>	
15	<p>The EMF setpoint is too small to plot a field characteristic</p> $EMF_{set} = U_A - I_{A,motor} * R_A = P101 - P100 * P110 < 10\% \text{ of } 1.35 * P078.i001$ <p>(e.g. P078.i001 = 400 V . . . minimum $EMF_{set} = 54 \text{ V}$)</p>	
16	Field weakening operation is not allowed in operation without a tachometer (P083=3)	
17	<p>The field current controller cannot be optimized because the field circuit time constant cannot be determined (actual field current does not decay after switch-off to below 0.95*initial value within approximately 1s or to below 0.8 * 0.95*initial values within approximately 2 s)</p> <p>Possible cause:</p> <ul style="list-style-type: none"> Setting in P103 is too high Field circuit inductance is too high Fault in actual field current sensing circuit (gating board or A7001 electronics board defective) Ratio r073.02 / P102 is too high (change P076.02 if necessary) 	
18	<p>Field weakening range is too wide, i.e. during power-up (at full field) to a speed setpoint of $+10\% n_{max}$, the EMK is $> 77\%$ of setpoint EMF ($P101 - P100 * P110$)</p> <p>Possible cause:</p> <ul style="list-style-type: none"> Maximum speed setting is incorrect Pulse encoder parameters are incorrect (P140 to P143) Parameters for tachometer adaptation are incorrect (P741) Setpoint EMF is not correct (P101, P100, P110) An excessively high load torque (in positive or negative direction, e.g. a suspended load) causes the drive to rotate, one of the armature current or torque limits may be parameterized too low 	
19	<p>A steady-state actual speed of $+10\%$, $+20\%$, $+30\%$. . . or $+100\%$ of the maximum speed cannot be reached within 3 minutes (or maximum value of the three set acceleration times) in speed-controlled operation (the speed setpoint/actual value difference averaged over 90 firing cycles must equal $< 0.1\% n_{max}$ for a specific time period)</p> <p>Possible cause:</p> <ul style="list-style-type: none"> Acceleration time is set too low (P303, P307, P311) Drive is blocked An excessively high load torque (in positive or negative direction, e.g. a suspended load) causes the drive to rotate, one of the armature current or torque limits may be parameterized too low Poor speed controller setting (P225, P226, P228) or speed controller is parameterized as pure P controller or with droop A band elimination filter (P201, P202 or P203, P204) is active Command "Ramp-function generator enable" =0 or "Ramp-function generator STOP" =1 is applied 	

Fault No.	Description	
	Cause as a function of fault value (r047.001, r949.001 or r949.009 with acknowledged error)	Further information (r047.002 to r047.016)
20	Current limit is too low (With speed controller optimization run: Less than 30% or 45% of P100 ($I_{A,motor}$) + the armature current required for zero speed, With optimization run for friction moment and moment of inertia compensation: Less than 20% of P100 ($I_{A,motor}$) + the armature current required for a steady-state speed corresponding to 10% of maximum speed)	
21	Field weakening range is too wide ($n_{act} < +7\% n_{max}$ produces $ EMF > 54\%$ setpoint EMF) (setpoint EMF= $K289 = P101 - P100 * P110$) Possible cause: <ul style="list-style-type: none"> • Maximum speed setting is incorrect • Pulse encoder parameters are incorrect (P140 to P143) • Parameters for tachometer adaptation are incorrect (P741) • Setpoint EMF is not correct (P101, P100, P110) • Caution: Even a high absolute negative actual speed value can produce an EMF of $> 54\%$ setpoint EMF 	
22	With speed controller optimization run: With an acceleration current equaling 20% or 30% of P100 ($I_{A,motor}$) + armature current required for zero speed or With optimization run for friction moment and moment of inertia compensation: With an acceleration current equaling the current required to achieve a steady-state speed of 10% of maximum speed + 20% of P100 ($I_{A,motor}$), the maximum speed cannot be reached within 45s +7% Possible cause: <ul style="list-style-type: none"> • Centrifugal mass is too large • Drive is blocked, heavily speed-dependent or excessively high load torque • "Active" load is attempting to maintain a certain speed Possible remedy: <ul style="list-style-type: none"> • Increase P100 while the optimization run is in progress in order to raise the applied acceleration current during optimization (during the speed controller optimization run, a maximum of 45% of $I_{A,motor}$ (+ armature current for zero speed) is applied as the armature current setpoint, $I_{A,motor}$ (P100) can thus be increased to 2.2 times the value at maximum without exceeding 100% $I_{A,motor}$ during optimization) 	
23	With speed controller optimization run: With an acceleration current equaling 20% or 30% of P100 ($I_{A,motor}$) + armature current required for zero speed or With optimization run for friction moment and moment of inertia compensation: With an acceleration current equaling the current required to achieve a steady-state speed of 10% of maximum speed + 20% of P100 ($I_{A,motor}$), the maximum speed or 100% of setpoint EMF cannot be reached within 90s +13% Possible cause: <ul style="list-style-type: none"> • Flywheel mass is too large • Drive is blocked, heavily speed-dependent or excessively high load torque • "Active" load is attempting to maintain a certain speed Possible remedy: <ul style="list-style-type: none"> • Increase P100 while the optimization run is in progress in order to raise the applied acceleration current during optimization (during the speed controller optimization run, a maximum of 45% of $I_{A,motor}$ (+ armature current for zero speed) is applied as the armature current setpoint, $I_{A,motor}$ (P100) can thus be increased to 2.2 times the value at maximum without exceeding 100% $I_{A,motor}$ during optimization) 	
24	With speed controller optimization run: The actual speed does not drop to below +2% of maximum speed or to below the speed threshold n_{min} set in P370 within 2 minutes With optimization run for field weakening: The actual speed does not drop to below +2% of maximum speed or to below the speed threshold n_{min} set in P370 within 10 minutes With optimization run for friction moment and moment of inertia compensation: The actual speed does not drop to below +2% of maximum speed or to below the speed threshold n_{min} set in P370 within 11 or 2 minutes Possible cause: <ul style="list-style-type: none"> • Single-quadrant drive coasts to a standstill too slowly 	

Fault No.	Description	
	Cause as a function of fault value (r047.001, r949.001 or r949.009 with acknowledged error)	Further information (r047.002 to r047.016)
25	<p>The average armature current required for the speed range from +7% to approximately +13% of maximum speed to cover the friction and/or steady-state load torque cannot be calculated</p> <p>Possible cause:</p> <ul style="list-style-type: none"> • Drive with very little friction or very small integral-action time and, as a result of the very short measuring time, computational inaccuracies during evaluation • Distorted or disturbed actual speed value • Large flywheel mass that is coupled to the drive via long shaft with high torsion, possibly via a coupling with large amount of play <p>Possible remedy:</p> <ul style="list-style-type: none"> • Reduce P100 for duration of the optimization run to decrease the acceleration current applied during optimization and thus to lengthen the measuring time 	
26	<p>Load torque too high ($n_{set}=0\% n_{max}$ results in $n_{ict} \geq 40\% n_{max}$) (actual speed value is averaged over 90 firing cycles, speed monitoring at $\geq 40\% n_{max}$ does not start for 1s after application of speed setpoint of $n_{set}=0$)</p> <p>Possible cause:</p> <ul style="list-style-type: none"> • An excessively high load torque (in a positive or negative direction, e.g. suspended load) causes the drive to rotate (the speed controller parameters are parameterized according to the factory setting during this run) • One of the armature current or torque limits is parameterized too low (the motor field may not be reaching full field strength fast enough with the result that the initial motor torque is too low) • Maximum speed setting is incorrect • Pulse encoder parameters are incorrect (P140 to P143) • Parameters for tachometer adjustment are not correct (P741) 	
27	<p>Load torque is too high ($n_{set}=0\% n_{max}$ results in $EMF \geq 100\%$ setpoint EMF) (EMF monitoring at $\geq (P101 - P100 * P110)$ does not start for 1 s after application of speed setpoint of $n_{set}=0$)</p> <p>Possible cause:</p> <ul style="list-style-type: none"> • An excessively high load torque (in a positive or negative direction, e.g. suspended load) causes the drive to rotate (the speed controller parameters are parameterized according to the factory setting during this run) • One of the armature current or torque limits is parameterized too low (the motor field may not be reaching full field strength fast enough with the result that the initial motor torque is too low) • Maximum speed setting is incorrect • Pulse encoder parameters are incorrect (P140 to P143) • Parameters for tachometer adjustment are not correct (P741) • Setpoint EMF settings are incorrect (P101, P100, P110) 	
28	<p>A steady-state actual speed corresponding to 0% of maximum speed cannot be reached within 0 s in speed-controlled operation (the speed setpoint/actual value difference averaged over 90 firing cycles must be $<1.0\% n_{max}$ for a total of 4s)</p> <p>Possible cause: As for fault value 26</p>	
29	<p>The calculated <u>armature circuit inductance is greater than 327.67 mH</u>, therefore <u>P111 = 327.67 mH has been set</u>. All other parameters (the current controller parameters P155 and P156 too) have been set correctly despite that. (For the real armature circuit inductance in mH, see r047.i010).</p> <p>Possible cause:</p> <ul style="list-style-type: none"> • e.g. field supply from the armature terminals 	
30	<p>The calculated <u>armature circuit inductance is greater than 327.67 mH</u> and the calculated <u>armature circuit resistance is greater than 32.767 Ω</u>, therefore <u>P111 = 327.67 mH and P110 = 32.767 Ω has been set</u>. All other parameters have also been set. However, the values of the current controller parameters P155 and P156 might differ from the optimum setting.</p> <p>Possible cause:</p> <ul style="list-style-type: none"> • e.g. field supply from the armature terminals 	

Fault No.	Description	
	Cause as a function of fault value (r047.001, r949.001 or r949.009 with acknowledged error)	Further information (r047.002 to r047.016)
31	The calculated armature circuit resistance is greater than 32.767 Ω , therefore P110 = 32.767 Ω has been set . All other parameters have also been set. Possibly the calculated P111 and therefore also the current controller parameters P155 and P156 have been distorted by the limitation in P110 . Possible cause: •e.g. field supply from the armature terminals	
	r047 Index 002: 1 Fault has occurred during optimization run for current controller and precontrol for armature and field (selected by means of P051=25) 2 Fault has occurred during optimization run for speed controller (selected through setting P051=26) 3 Fault has occurred during optimization run for field weakening (selected through setting P051=27) 4 Fault has occurred during internal offset adjustments (selected through P051=22) 5 Fault has occurred in optimization run for friction and moment of inertia compensation (selected through setting P051=28)	
F051	No optimization run when permanent memory is disabled (active in all operating states)	[V2.1 and later] If P051.001 is set to 0 (write access to permanent memory disabled), it is not possible to execute an optimization run.
F052	Optimization run aborted as a result of external cause (active in operating states of --, I, II) This fault message is activated when the converter ceases operating in the RUN state (state I, II or --) during an optimization run (and thus in response to every FAULT) or if the EMERGENCY STOP or SHUTDOWN command is applied. The optimization run is aborted. Only those parameters which had been fully optimized prior to activation of the fault message are altered. When the STANDSTILL command is applied, this fault message is <u>not</u> activated if the optimization run for field weakening is interrupted <u>after</u> the 1st field weakening measuring point has been recorded or, in the case of the optimization run for friction and moment of inertia compensation, <u>after</u> the measuring point at 10% maximum speed has been determined. In these cases, the run may be interrupted by STANDSTILL so as to be able to complete the run in several stages (by repeated restarts) for a limited travel path. Fault value:	r047 Index 002 to 016: i002=1 Fault has occurred during optimization run for current controller and precontrol for armature and field (selected by means of P051=25) i002=2 Fault has occurred during optimization run for speed controller (selected through setting P051=26) i002=3 Fault has occurred during optimization run for field weakening (selected through setting P051=27) i002=5 Fault has occurred in optimization run for friction and moment of inertia compensation (selected through setting P051=28)
	1 Run was aborted because converter is <u>no longer</u> operating in RUN mode 2 Run was aborted because EMERGENCY STOP command was applied (speed controller setpoint =0) 3 Run was aborted because STANDSTILL command was applied (ramp-function generator setpoint=0) 4 Operation has been aborted because P051 was changed during the optimization run 5 Run was aborted because SWITCH-ON command was not applied within 30 s of selection of optimization run 6 Operation has been aborted because the OPERATING ENABLE command was not entered within 1 minute of selection of the optimization run. 7 Operation has been aborted because converter was not in operating state < 07.2 15 s after selection of the optimization run with P051 = 25, 26, 27 or 28 (input of OFF1 command may have been forgotten)	

9.1.2.9 External faults

F053	Fault message from free function block FB288 (active in all operating states) Fault value: 1 the binector wired via parameter U102 Index.005 is in the state log."1" 2 the binector wired via parameter U102 Index.006 is in the state log."1" 3 the binector wired via parameter U102 Index.007 is in the state log."1" 4 the binector wired via parameter U102 Index.008 is in the state log."1"
F054	Fault message from free function block FB289 (active in all operating states) Fault value:

Fault No.	Description	
	Cause as a function of fault value (r047.001, r949.001 or r949.009 with acknowledged error)	Further information (r047.002 to r047.016)
1	the binector wired via parameter U103 Index.005 is in the state log."1"	
2	the binector wired via parameter U103 Index.006 is in the state log."1"	
3	the binector wired via parameter U103 Index.007 is in the state log."1"	
4	the binector wired via parameter U103 Index.008 is in the state log."1"	

9.1.2.10 Start-up faults

F055	<p>No field characteristic recorded (active in operating states of – –, I, II)</p> <p>Possible fault causes</p> <ul style="list-style-type: none"> ◆ The optimization run for field weakening (P051=27) has not yet been executed. <p>Fault value:</p>
	<p>1 P170 = 1 ("torque control") selected, but "no valid field characteristic has been recorded" (P117=0) yet</p> <p>2 P081 = 1 ("speed-dependent field weakening") selected, but "no valid field characteristic has been recorded" (P117=0) yet (P117=0)</p>
F056	<p>Important parameter is not set (active in operating states of ≤ o6)</p> <p>This fault message is activated if certain parameters are still set to 0.</p> <p>Fault value:</p>
	<p>1 Speed controller actual value selection in P083 is still set to 0</p> <p>2 Rated motor armature current in P100 is still set to 0.0</p> <p>3 Rated motor field current in P102 is still set to 0.00 (fault message only when P082 ≠ 0)</p> <p>4 Rated DC current of external field device is still set to 0.00 in U838 (error message if P082 ≥ 21 only)</p>
F058	<p>Parameter settings are not consistent (active in operating states of ≤ o6)</p> <p>Inconsistent values have been set in mutually dependent parameters.</p> <p>Fault value:</p>
	<p>2 The parameters for speed-dependent current limitation are not set correctly (the following applies: P105>P107 (I1>I2) and P104 < P106 (n1<n2))</p> <p>3 The field characteristic is not uniform</p> <p>4 The first threshold for P gain adaptation of the speed controller set in parameter P556 is higher than the second threshold setting in parameter P559</p> <p>4 P557 is set to greater than P560</p> <p>5 P558 is set to greater than P561</p> <p>7 If P083=1 (analog tachometer), then P746 may not equal 0 (main actual value is not connected)</p> <p>8 If P083=2 (pulse encoder), then P140 may not equal x0 (no pulse encoder installed)</p> <p>9 If P083=3 (EMF control) then P082 may not equal x1x (field weakening operation)</p> <p>10 P090 (stabilization time for supply voltage) ≥ P086 (time for automatic restart)</p> <p>11 P090 (stabilization time for supply voltage) ≥ P089 (waiting time in state o4 or o5)</p> <p>12 P445=1 is set (switch-on, shutdown and crawl act as a pushbutton) although no binector is parameterized as a shutdown button (P444=0)</p> <p>13 If P067 > 1, then P075 must also be > 0</p> <p>14 Parameter U673 > U674 (this setting is not permitted; see function diagram B152)</p> <p>15 Parameter P169 = 1 and P170 = 1 (impermissible setting)</p>
F059	<p>Technology option S00 is disabled/will be disabled soon (active in all operating statuses)</p>

Fault No.	Description	
	Cause as a function of fault value (r047.001, r949.001 or r949.009 with acknowledged error)	Further information (r047.002 to r047.016)
	Fault value:	
1	<p>Time credit for S00 = 0 hrs The technology option S00 for 500 operating hours no longer applies. The functions are now no longer available, but the parameter settings have been retained. If you wish to continue using technology option S00, please contact your nearest Siemens Sales Office to obtain the PIN number you will require to permanently enable this option. You will need to know the serial number of your SIMOREG DC Master. For further details, please refer to the description of parameters U977 and n978 in Chapter 11 of the Parameter List.</p>	
2	<p>Time credit S00 < 100 Std. The remaining time period of temporary enabling of technology option S00 is now less than 100 operating hours. The technology functions will not be available for much longer. If you wish to continue using technology option S00, please contact your nearest Siemens Sales Office to obtain the PIN number you will require to permanently enable this option. for permanent enabling of technology option S00. You will need to know the serial number of your SIMOREG DC Master. For further details, please refer to the description of parameters U977 and n978 in Chapter 11 of the Parameter List.</p>	
3	<p>S00 operation will not be possible if an SLB cycle time of < 1 ms is set Owing to the available capacity of the electronics board, it is <u>not</u> possible to operate the S00 technology option at the same time as a SIMOLINK bus with an extremely short cycle time (U746 < 1 ms). See also parameter U746.</p>	

Fault No.	Description
	<div style="display: flex; justify-content: space-between;"> <div style="width: 45%;">Cause as a function of fault value (r047.001, r949.001 or r949.009 with acknowledged error)</div> <div style="width: 45%;">Further information (r047.002 to r047.016)</div> </div>

9.1.2.11 Hardware faults

F061	<p>Fault message from thyristor check function (active in operating state o3)</p> <p>This fault message can be activated only if the thyristor check is activated via parameter P830.</p> <p>If "Thyristor defective" or "Thyristor unable to block" is signaled, then the relevant thyristor module must be replaced.</p> <p>Possible causes for irreparable damage to thyristors:</p> <ul style="list-style-type: none"> ◆ Interruption in snubber circuit ◆ Current controller and precontrol are not optimized (excessive current peaks) ◆ Inadequate cooling (e.g. fan is not operating, ambient temperature is too high, fan is rotating in wrong direction (incorrect phase sequence), inadequate air supply, heatsink is very dirty) ◆ Excessive voltage peaks in incoming supply system ◆ External short circuit or fault to ground (check armature circuit) <p>If "Thyristor unable to block" is signaled, the cause can generally be attributed to a firing circuit fault, rather than to a defective thyristor.</p> <p>Possible causes:</p> <ul style="list-style-type: none"> ◆ Firing pulse cable to relevant thyristor is interrupted ◆ Ribbon cable X101 or X102 is incorrectly inserted or interrupted ◆ Defective electronics or gating board ◆ Internal interruption in gating cable in thyristor module <p>The designations of the firing cables and associated thyristors can be found in Section 6.4 (power connections).</p> <p>Fault value:</p> <table border="1" style="width: 100%; border-collapse: collapse;"> <tr><td style="width: 20px; text-align: center;">1</td><td>Defective thyristor (short circuit in module V1, on 15A and 30 converters: V1 or V4)</td></tr> <tr><td style="text-align: center;">2</td><td>Defective thyristor (short circuit in module V2, on 15A and 30 converters: V2 or V5)</td></tr> <tr><td style="text-align: center;">3</td><td>Defective thyristor (short circuit in module V3, on 15A and 30 converters: V3 or V6)</td></tr> <tr><td style="text-align: center;">4</td><td>Defective thyristor (short circuit in module V4, on 15A and 30 converters: V4 or V1)</td></tr> <tr><td style="text-align: center;">5</td><td>Defective thyristor (short circuit in module V5, on 15A and 30 converters: V5 or V2)</td></tr> <tr><td style="text-align: center;">6</td><td>Defective thyristor (short circuit in module V6, on 15A and 30 converters: V6 or V3)</td></tr> <tr><td style="text-align: center;">8</td><td>Fault to ground in armature circuit</td></tr> <tr><td style="text-align: center;">9</td><td>I=0 message defective Possible fault cause • Defective A7001 electronics board</td></tr> <tr><td style="text-align: center;">11</td><td>Thyristor cannot be fired (X11)</td></tr> <tr><td style="text-align: center;">12</td><td>Thyristor cannot be fired (X12)</td></tr> <tr><td style="text-align: center;">13</td><td>Thyristor cannot be fired (X13)</td></tr> <tr><td style="text-align: center;">14</td><td>Thyristor cannot be fired (X14)</td></tr> <tr><td style="text-align: center;">15</td><td>Thyristor cannot be fired (X15)</td></tr> <tr><td style="text-align: center;">16</td><td>Thyristor cannot be fired (X16)</td></tr> <tr><td style="text-align: center;">17</td><td>2 or more thyristors (MI) cannot be fired Possible fault cause • Armature circuit interrupted</td></tr> <tr><td style="text-align: center;">21</td><td>Thyristor cannot be fired (X21)</td></tr> <tr><td style="text-align: center;">22</td><td>Thyristor cannot be fired (X22)</td></tr> <tr><td style="text-align: center;">23</td><td>Thyristor cannot be fired (X23)</td></tr> <tr><td style="text-align: center;">24</td><td>Thyristor cannot be fired (X24)</td></tr> <tr><td style="text-align: center;">25</td><td>Thyristor cannot be fired (X25)</td></tr> <tr><td style="text-align: center;">26</td><td>Thyristor cannot be fired (X26)</td></tr> <tr><td style="text-align: center;">27</td><td>2 or more thyristors (MII) cannot be fired</td></tr> </table>	1	Defective thyristor (short circuit in module V1, on 15A and 30 converters: V1 or V4)	2	Defective thyristor (short circuit in module V2, on 15A and 30 converters: V2 or V5)	3	Defective thyristor (short circuit in module V3, on 15A and 30 converters: V3 or V6)	4	Defective thyristor (short circuit in module V4, on 15A and 30 converters: V4 or V1)	5	Defective thyristor (short circuit in module V5, on 15A and 30 converters: V5 or V2)	6	Defective thyristor (short circuit in module V6, on 15A and 30 converters: V6 or V3)	8	Fault to ground in armature circuit	9	I=0 message defective Possible fault cause • Defective A7001 electronics board	11	Thyristor cannot be fired (X11)	12	Thyristor cannot be fired (X12)	13	Thyristor cannot be fired (X13)	14	Thyristor cannot be fired (X14)	15	Thyristor cannot be fired (X15)	16	Thyristor cannot be fired (X16)	17	2 or more thyristors (MI) cannot be fired Possible fault cause • Armature circuit interrupted	21	Thyristor cannot be fired (X21)	22	Thyristor cannot be fired (X22)	23	Thyristor cannot be fired (X23)	24	Thyristor cannot be fired (X24)	25	Thyristor cannot be fired (X25)	26	Thyristor cannot be fired (X26)	27	2 or more thyristors (MII) cannot be fired
1	Defective thyristor (short circuit in module V1, on 15A and 30 converters: V1 or V4)																																												
2	Defective thyristor (short circuit in module V2, on 15A and 30 converters: V2 or V5)																																												
3	Defective thyristor (short circuit in module V3, on 15A and 30 converters: V3 or V6)																																												
4	Defective thyristor (short circuit in module V4, on 15A and 30 converters: V4 or V1)																																												
5	Defective thyristor (short circuit in module V5, on 15A and 30 converters: V5 or V2)																																												
6	Defective thyristor (short circuit in module V6, on 15A and 30 converters: V6 or V3)																																												
8	Fault to ground in armature circuit																																												
9	I=0 message defective Possible fault cause • Defective A7001 electronics board																																												
11	Thyristor cannot be fired (X11)																																												
12	Thyristor cannot be fired (X12)																																												
13	Thyristor cannot be fired (X13)																																												
14	Thyristor cannot be fired (X14)																																												
15	Thyristor cannot be fired (X15)																																												
16	Thyristor cannot be fired (X16)																																												
17	2 or more thyristors (MI) cannot be fired Possible fault cause • Armature circuit interrupted																																												
21	Thyristor cannot be fired (X21)																																												
22	Thyristor cannot be fired (X22)																																												
23	Thyristor cannot be fired (X23)																																												
24	Thyristor cannot be fired (X24)																																												
25	Thyristor cannot be fired (X25)																																												
26	Thyristor cannot be fired (X26)																																												
27	2 or more thyristors (MII) cannot be fired																																												

Fault No.	Description	
	Cause as a function of fault value (r047.001, r949.001 or r949.009 with acknowledged error)	Further information (r047.002 to r047.016)
31	Thyristor unable to block (X11 or X21)	
32	Thyristor unable to block (X12 or X22)	
33	Thyristor unable to block (X13 or X23)	
34	Thyristor unable to block (X14 or X24)	
35	Thyristor unable to block (X15 or X25)	
36	Thyristor unable to block (X16 or X26)	

9.1.2.12 Internal faults

F062	Fault in parameter memory (active in all operating states)	
	Software monitoring of correct functioning of the EEPROM module (non-volatile memory) on the A7009 board. The EEPROM values contains all data which must be protected in the case of a power failure (i.e. parameter values and process data which must remain stored during power failures).	
	The following are monitored:	
	<ul style="list-style-type: none"> ◆ Connection between the A7001 electronics board and the EEPROM on the A7009 backplane wiring assembly ◆ Whether the parameter values stored on the EEPROM are within the permissible value range ◆ Whether data are being correctly stored on the EEPROM. For this purpose, values are read and checked for correctness after they are transferred to the module ◆ Whether the checksum of the non-volatile process data in the EEPROM is correct 	
Possible causes for all fault types: Excessive EMC-related interference is present (e.g. due to unprotected contactors, unshielded cables, loose shield connections)		
Fault value: r047 Index 002 to 016:		
1	Connection to EEPROM is faulty Possible fault causes <ul style="list-style-type: none"> • A7001 electronics board is defective • A7009 backplane wiring assembly is defective • Plug-in connection X109 is defective 	
2	Parameter value is outside permissible value range Possible fault causes <ul style="list-style-type: none"> • "Restore to default value" has never been executed with this software (e.g. after software replacement) • A7009 backplane wiring assembly is defective Possible remedy: <ul style="list-style-type: none"> • Acknowledge fault, execute "Restore to default value" and start up the drive again 	i002 Number of faulty parameter i003 Index of faulty parameter i004 Faulty parameter value
3	Parameter value cannot be stored on EEPROM Possible fault causes <ul style="list-style-type: none"> • A7001 electronics board is defective • A7009 backplane wiring assembly is defective • Plug-in connection X109 is defective 	i002 Address of fault memory location i003 Faulty value in EEPROM i004 Correct parameter value

Fault No.	Description	
	Cause as a function of fault value (r047.001, r949.001 or r949.009 with acknowledged error)	Further information (r047.002 to r047.016)
	11 Checksum of non-volatile data (part 1) is not correct 12 Checksum of non-volatile data (part 2) is not correct 13 Checksum of non-volatile data (part 3) is not correct 20 Checksum of configuring table of parameter values is not correct Possible fault causes <ul style="list-style-type: none"> Defective EEPROM "Restore to default value" has never been executed with this software (e.g. after software replacement) Possible remedy: <ul style="list-style-type: none"> Acknowledge fault, execute "Restore to default value" and start up the drive again! Check interference suppression measures and improve if necessary. 	i002 Calculate checksum i003 Checksum found in EEPROM
F063	Errors in compensation data of analog inputs and outputs (active in all operating states) This function monitors whether the factory-set compensation data for the analog inputs and outputs are plausible Possible fault cause: <ul style="list-style-type: none"> Defective A7001 or A7006 electronics board Fault value: r047 Index 002 to 016:	
	11 Incorrect number of words in compensation values for analog inputs and outputs of A7001	i002 Incorrect number of words
	12 Checksum error in compensation values for analog inputs and outputs of A7001	i002 Calculated checksum i003 Errored checksum
	13 Incorrect value among compensation values for analog inputs and outputs of A7001	i002 Incorrect value
	23 Incorrect value among compensation values for analog inputs and outputs of A7006	i002 Incorrect value
F064	Watchdog timer has initiated a reset (active in all operating states) An internal microprocessor hardware counter monitors whether the program for calculating the firing pulses runs at least once every 14 ms (program is executed on average every 2.7 to 3.3 ms). If this is not the case, the counter initiates a reset, F064 is then displayed. Possible fault causes <ul style="list-style-type: none"> A7001 electronics board is defective Excessive EMC-related interference is present (e.g. due to unprotected contactors, unscreened cables, loose shield connections) 	
F065	Illegal microprocessor status (active in all operating states) An internal microprocessor hardware function monitors the microprocessor for illegal operating states. Possible fault causes <ul style="list-style-type: none"> A7001 electronics board is defective Excessive EMC-related interference is present (e.g. due to unprotected contactors, unscreened cables, loose shield connections) 	
F067	Converter cooling faulty (active in operating states of ≤ 013) The heatsink temperature monitoring function is activated 6s after connection of the electronics supply. (The current heat sink temperature is indicated at parameter r013 and on connector K050)	

Fault No.	Description	
	Cause as a function of fault value (r047.001, r949.001 or r949.009 with acknowledged error)	Further information (r047.002 to r047.016)
	Fault value:	r047 Index 002 to 016:
	1 Heatsink temperature > permissible heatsink temperature	i002 Measured heatsink temperature (16384 .. 100°C)
	2 Heatsink temperature sensor is defective	i003 Measured ADC value
	3 Converter fan is defective	
F068	Analog measuring channel faulty (main setpoint, main actual value or analog select input) (active in all operating states) Hardware monitoring of measuring circuits Possible fault causes <ul style="list-style-type: none"> • A7001 module defective • Measuring circuit saturated (input voltage at terminals 4 and 5 or 6 and 7 higher than approx. 11.3V) 	
	Fault value:	
	1 Measuring channel for main setpoint / analog select input 1 faulty (terminals 4 and 5)	
	2 Measuring channel for main actual value faulty (terminals 103 and 104)	
	3 Measuring channel for analog select input 1 faulty (terminals 6 and 7)	
F069	MLFB data are faulty (active in all operating states) Possible fault causes <ul style="list-style-type: none"> ◆ Excessive EMC-related interference is present (e.g. due to unprotected contactors, unshielded cables, loose shield connections) ◆ A7009 backplane wiring assembly is defective 	
	Fault value:	r047 Index 002 to 016:
	1 MLFB code number (r070) = MLFB code number (r070) is illegal	i002 Incorrect MLFB code number
	2 MLFB data checksum error	-
	3 Works number checksum error	-
	4 Number of words of MLFB data is incorrect	-

9.1.2.13 Communication errors with supplementary boards

F070	SCB1: Serious initialization error (active in all operating states) SCB1 and SCI cannot power up correctly (see diagnostic parameter n697 for details) Fault value:	
	12 No connection to slave 1	
	22 No connection to slave 2	
F073	SCB1: Current below 4mA minimum value at analog input1 of slave 1 (active in all operating states) The cause of the fault may be a cable break	
F074	SCB1: Current below 4mA minimum value at analog input2 of slave 1 (active in all operating states) The cause of the fault may be a cable break	
F075	SCB1: Current below 4mA minimum value at analog input3 of slave 1 (active in all operating states) The cause of the fault may be a cable break	
F076	SCB1: Current below 4mA minimum value at analog input1 of slave 2 (active in all operating states) The cause of the fault may be a cable break	
F077	SCB1: Current below 4mA minimum value at analog input2 of slave 2 (active in all operating states) The cause of the fault may be a cable break	

Fault No.	Description	
	Cause as a function of fault value (r047.001, r949.001 or r949.009 with acknowledged error)	Further information (r047.002 to r047.016)
F078	SCB1: Current below 4mA minimum value at analog input3 of slave 2 (active in all operating states) The cause of the fault may be a cable break	
F079	SCB1: Telegram failure (active in all operating states) Check function of SCB1 (activity LEDs) and connection to SCI slaves (fiber optics)	
F080	Error in initialization of a CB/TB board Possible causes for fault values 1 and 6: <ul style="list-style-type: none"> ◆ CB/TB board is defective ◆ CB/TB board is not installed correctly ◆ CB/TB board is taking too long to run up (e.g. due to very complex TB configuration) 	
	Fault value (r949 index 001):	r047 index 002 to 016:
1	The "Heartbeat counter" of the CB/TB has not started to count within 20 s	i015 Code number of board: 1 TB or 1 st CB 2 2 nd CB
2	The product version of the installed CT/TB board is not compatible with the SIMOREG 6RA70 converter	i002 Code number of slot containing incompatible board: 2 Slot D 3 Slot E 4 Slot F 5 Slot G 6 CB when configuration includes TB
5	Parameters P918, U711 to U721 are not correctly set or not accepted after a change by means of U710 = 0 setting. (The meanings of these parameters are defined in the manual for the relevant CB board, see also function diagrams, Section 8, Sheets Z110 and Z111)	i015 Code number of board: 1 TB or 1 st CB 2 2 nd CB
6	The initialization run for a CB/TB board has not been completed within 40 s	i015 Code number of board: 1 TB or 1 st CB 2 2 nd CB
F081	CB/TB heartbeat error CB/TB has not incremented the monitoring counter for a period of 800 ms Possible causes of fault <ul style="list-style-type: none"> ◆ CB/TB board is defective ● CB/TB board is not correctly installed 	
F082	CB/TB message timeout or error in data exchange Possible causes of fault <ul style="list-style-type: none"> ◆ CB/TB PZD message timeout (with fault value 10) ◆ Excessive EMC-related interference (e.g. due to unprotected contactors, unscreened cables, loose screen connections) ◆ CB/TB board is defective ◆ CB/TB board is not correctly inserted 	
	Fault value (r949 index 001):	r047 Index 002 to 016:
1	Fault in alarm channel from CB to basic unit	i015 Code number of board: 1 TB or 1 st CB 2 2 nd CB
2	Fault in alarm channel from TB to basic unit	
3	Fault in fault channel from TB to basic unit	
5	Fault in parameter job channel from CB to basic unit	i015 Code number of board: 1 TB or 1 st CB 2 2 nd CB
6	Fault in parameter response channel from basic unit to CB	i015 Code number of board: 1 1 st TB or 1 st CB 2 2 nd CB
7	Fault in parameter job channel from TB to basic unit	

Fault No.	Description	
	Cause as a function of fault value (r047.001, r949.001 or r949.009 with acknowledged error)	Further information (r047.002 to r047.016)
8	Fault in parameter response channel from basic unit to TB	
10	CB/TB process data failure (message timeout period set in U722)	i015 Code number of board: 1 TB or 1 st CB 2 2 nd CB
11	Fault in parameter job channel from PMU to TB	
12	Fault in parameter response channel from TB to PMU	
15	Fault in setpoint channel from CB/TB to basic unit	i015 Code number of board: 1 TB or 1 st CB 2 2 nd CB
16	Fault in actual value channel from basic unit to CB/TB	i015 Code number of board: 1 TB or 1 st CB 2 2 nd CB

9.1.2.14 Fault messages from supplementary boards

F101 to F147	This group of fault messages is activated by supplementary boards Please refer to the operating manual of the relevant supplementary board for explanation of the fault messages and fault values
---------------------	--

9.2 Alarm messages

Alarm message display:

On the PMU: A (Alarm) and a three-digit number. The red LED (Fault) flashes.

On the OP1S: On the bottom line of the operational display. The red LED (Fault) flashes.

An alarm message cannot be acknowledged, but disappears automatically when the cause has been eliminated.

Several alarm messages can be active at the same time, these are then displayed in succession.

Many alarms (see List of Alarm Messages) can only be active in certain operating states.

The system responses to an alarm are as follows:

- Alarm message is displayed on the operator panel (PMU, OP1S)
- B0114 (= status word 1, bit 7) is set and B0115 is cancelled (see also special alarm bits in status word 2, e.g. for an external alarm, overload, etc.)
- The corresponding bit in one of the alarm words r953 (K9801) to r960 (K9808) is set

Alarm No.	Description
A015	Simolink start (active in all operating states) Although the board has been initialized, it cannot yet exchange telegrams (parameters have not yet been correctly configured on all nodes or the boards have not yet been linked via fiber optics to form a closed ring).
A018	Short circuit at binary outputs (active in all operating states) Hardware monitoring function to check for short circuit at one of the binary select outputs (see also F018 and r011).
A019	Alarm message from free function block FB256 (active in all operating states) The binector wired via parameter U104 Index.002 is in the state log."1"
A020	Alarm message from free function block FB257 (active in all operating states) The binector wired via parameter U105 Index.002 is in the state log."1"
A021	External alarm 1 (active in all operating states) Bit 28 in control word 2 was in the log. "0" state for longer than the time set in P360 index 003.
A022	External alarm 2 (active in all operating states) Bit 29 in control word 2 was in the log. "0" state for longer than the time set in P360 index 004.
A023	Alarm message from free function block FB6 (active in all operating states) The binector wired via parameter U104 Index.001 is in the state log."1"
A024	Alarm message from free function block FB7 (active in all operating states) The binector wired via parameter U105 Index.001 is in the state log."1"

Alarm No.	Description
A025	<p>Brush length too short (active in all operating states)</p> <p>When parameter P495=1 (binary sensing of brush length): Alarm in response to log. "0" signal (longer than 10s) at terminal 211</p> <p>Possible causes</p> <ul style="list-style-type: none"> ◆ Encoder for brush length has responded ◆ Interruption in encoder cable
A026	<p>Poor bearing condition (active in all operating states)</p> <p>When parameter P496=1 (bearing condition sensing): Alarm in response to log. "0" signal (longer than 2s) at terminal 212</p> <p>Possible causes</p> <ul style="list-style-type: none"> ◆ Encoder for bearing condition has responded
A027	<p>Air flow monitoring (active in operating states of < o6)</p> <p>When parameter P497=1 (air flow monitoring): Alarm in response to log. "0" signal (longer than 40s) at terminal 213</p> <p>Possible causes</p> <ul style="list-style-type: none"> ◆ Encoder for fan monitoring has responded ◆ Interruption in encoder cable
A028	<p>Motor overtemperature (active in all operating states)</p> <p>When parameter P498=1 (thermostat connected): Alarm in response to log. "0" signal (longer than 10s) at terminal 214</p> <p>Possible causes</p> <ul style="list-style-type: none"> ◆ Thermostat for monitoring motor temperature has responded ◆ Interruption in encoder cable
A029	<p>Motor overtemperature (active in all operating states)</p> <p>Selection via P493=1 or 3 (thermostat at terminals 22 / 23) or P494=1 or 3 (thermostat at terminals 204 / 205)</p> <p><u>When parameter P490.01=1 (KTY84 at terminals 22 / 23) or P490.02=1 (KTY84 at terminals 204 / 205):</u> The alarm is activated if the motor temperature reaches or exceeds the values set in parameter P492.</p> <p><u>When parameter P490.01=2, 3, 4 or 5 (PTC thermistor at terminals 22 / 23) or P490.02=2, 3, 4 or 5 (PTC thermistor at terminals 204 / 205):</u> The alarm is activated if the motor temperature reaches or exceeds the trip value of the selected PTC.</p>
A030	<p>Commutation failure or overcurrent has occurred (active in operating states of --, I, II)</p> <p>Possible error causes</p> <ul style="list-style-type: none"> ◆ Mains voltage dip in regenerative feedback mode ◆ Current control loop not optimized
A031	<p>Speed controller monitoring (active in operating states of --, I, II)</p> <p>The monitor responds when the difference between the connectors selected in P590 and P591 (factory setting: Setpoint/actual value difference of speed controller) exceeds the limit set in parameter P388 for longer than the time set in parameter P390.</p> <p>Possible causes</p> <ul style="list-style-type: none"> ◆ Control loop interrupted ◆ Controller is not optimized ◆ P590 or P591 is not correctly parameterized

Alarm No.	Description
A033	<p>Alarm message from free function block FB8 (active in all operating states)</p> <p>The binector connected via parameter U106 Index.001 is in the log. "1" state</p>
A034	<p>Alarm message from free function block FB9 (active in all operating states)</p> <p>The binector connected via parameter U107 Index.001 is in the log. "1" state</p>
A035	<p>Drive blocked (active in operating states of --, I, II)</p> <p>The monitoring function responds if the following conditions are fulfilled for longer than the time set in parameter P355:</p> <ul style="list-style-type: none"> ◆ Positive or negative torque or armature current limit reached ◆ Armature current is greater than 1% of converter rated armature DC current ◆ The actual speed value is less than 0.4% of maximum speed
A036	<p>No armature current can flow (active in operating states of --, I, II)</p> <p>This monitoring function responds if the armature firing angle is at the rectifier stability limit for more than 500 ms and the armature current is less than 1% of the converter rated armature DC current.</p>
A037	<p>I²t motor monitor has responded (active in operating states of --, I, II)</p> <p>The alarm is activated when the calculated I²t value of the motor reaches the value which corresponds to the final temperature at 100% of permissible continuous motor current (= P113*P100).</p>
A038	<p>Overspeed (active in operating states of --, I, II)</p> <p>The monitoring function responds if the actual speed value (selected in P595) exceeds the positive (P512) or negative (P513) threshold by 0.5%.</p> <p>Possible causes</p> <ul style="list-style-type: none"> ◆ Lower current limit has been input ◆ Current-controlled operation ◆ P512, P513 are set too low ◆ Tachometer cable contact fault in operation close to maximum speed
A039	<p>I²t value of power section too high (active in all operating states)</p> <p>This alarm is activated if the permissible I²t value for the relevant power section is reached. At the same time, the current limit is set to P077 * 100% of the converter rated DC current. This limit is not cancelled again until the setpoint drops below 100% of the converter rated DC current. See also Fault F039 and Parameter P075.</p>
A043	<p>Automatic field current reduction if EMF is too high in operation (active in operating states of --, I, II)</p> <p>This alarm is active only when parameter P272=1 and activated if the following equation applies to firing angle α (armature) before limitation (K101):</p> $\alpha > (\alpha_{\text{W}} \text{ (inverter stability limit acc. to P151) - 5 degrees) or , at a low (pulsating) current}$ $\alpha > (165 \text{ degrees} - 5 \text{ degrees})$ <p>The field is reduced simultaneously with A043, implemented through control of the armature firing angle to (α_{W} (or 165 degrees) - 5 degrees) using a P controller whose output reduces the EMF controller setpoint. For this reason, "Field current setpoint input through internal EMF control" (PO81=1) must be parameterized.</p> <p>When a change in torque direction is requested, both torque directions are inhibited until the calculated control angle (K101) is <165 degrees for the armature current requested in the new torque direction, i.e. until the field, and thus the EMF, have been reduced accordingly.</p> <p>See also parameter P082.</p>
A044	<p>An alarm is active on one slave connected to the paralleling interface (active in all operating states)</p>
A046	<p>Analog select input for main setpoint (terminals 4 and 5) faulty (active in operating states of ≤ o6)</p> <p>This alarm is activated when P700=2 (current input 4 to 20 mA) and the input current is less than 3mA.</p>
A047	<p>Analog select input 1 (terminals 6 and 7) faulty (active in operating states of ≤ o6)</p> <p>This alarm is activated when P710=2 (current input 4 to 20 mA) and the input current is less than 3mA.</p>

Alarm No.	Description
A049	SCB1: No SCI slave connected (active in all operating states)
A050	SCB1: Not all required SCI slaves are available (active in all operating states) The SCI slave required to perform the parameterized functions is not available
A053	Alarm message from free function block FB258 (active in all operating states) The binector connected via parameter U106 Index.002 is in the log. "1" state
A054	Alarm message from free function block FB259 (active in all operating states) The binector connected via parameter U107 Index.002 is in the log. "1" state
A059	Remaining time for temporary enabling of the S00 technology option is now less than 100 operating hours (active in all operating statuses) Remaining time for temporary enabling of the S00 technology option is now less than 100 operating hours. The functions will soon be unavailable. If you wish to continue using technology option S00, please contact to your nearest Siemens Regional Office for a PIN number for permanent enabling of technology option S00. You will need to know the serial number of your SIMOREG DC Master. For further details, please refer to the description of parameters U977 and n978 in Chapter 11 of the Parameter List.
A067	Converter cooling faulty (active in all operating states) The heatsink temperature is > 90 °C. The monitoring function is activated 6s after the electronics supply is connected. (The current heat sink temperature is indicated at parameter r013 and on connector K050)
A081 to A088	CB alarm of 1st CB (active in all operating states \leq o11) The meaning of these alarms depends on the type of board used. For further information, refer to Section 7.7, Start-Up of Optional Supplementary Boards, in the relevant board description.
A089 to A096	CB alarm of 2nd CB (active in all operating states \leq o11) The meaning of these alarms depends on the type of board used. For further information, refer to Section 7.7, Start-Up of Optional Supplementary Boards, in the relevant board description.
A097 to A128	TB alarms (active in operating states \leq o11) For more information about TECH BOARD alarms, please refer to Operating Instructions or Configuring Guide of the relevant board.

NOTES:

10 Parameter list

Overview

The Base Drive Panel Operating Instructions does not contain information about all available parameters. Only the parameters mentioned in this book are included. For a complete list of parameters please refer to power module Operating Instructions 6RX1700-0AD76.

Range of parameter numbers	Function
r000	Operating display
r001 - P050	General visualization parameters
P051 - r059	Access authorization levels
r060 - r065	Definition of SIMOREG DC MASTER converter
P067 - P079	Definition of SIMOREG DC MASTER power section
P080 - P098	Setting values for converter control
P100 - P139	Definition of motor
P140 - P148	Definition of pulse encoder, speed sensing using pulse encoder
P150 - P165	Closed-loop armature current control, auto-reversing stage, armature gating unit
P169 - P191	Current limitation, torque limitation
P192	Auto-reversing stage, armature gating unit
P200 - P236	Speed controller (further parameters for the speed controller P550 - P567)
P250 - P265	Closed-loop field current control, field gating unit
P272 - P284	Closed-loop EMF control
P295 - P319	Ramp-function generator
P320 - P323	Setpoint processing
P330	Ramp-function generator
P351 - P364	Setting values for monitoring functions and limits
P370 - P399	Setting values for limit-value monitors
P401 - P416	Settable fixed values
P421 - P428	Fixed control bits
P430 - P445	Digital setpoint input (fixed setpoint, inching and crawling setpoints)
P450 - P453	Position sensing with pulse encoder
P455 - P458	Connector selector switches
P460 - P473	Motorized potentiometer
P480 - P485	Oscillation
P490 - P498	Definition of "Motor interface"
P500 - P503	Configuring of torque shell input
P509 - P515	Speed limiting controller
P519 - P530	Friction compensation
P540 - P546	Compensation of moment of inertia (dv/dt injection)
P550 - P567	Speed controller (further parameters for the speed controller P200 - P236)
P580 - P583	Field reversal
P590 - P597	Input quantities for signals
P600 - P647	Configuring of closed-loop control
P648 - P691	Control word, status word
P692 - P698	Further configuring measures
P700 - P746	Analog inputs (main actual value, main setpoint, selectable inputs)
P749 - P769	Analog outputs
P770 - P778	Binary outputs
P780 - P819	Configuration of serial interfaces on basic converter
P820 - P821	Deactivation of monitoring functions
r824 - r829	Compensation values
P830	Thyristor diagnosis

Range of parameter numbers	Function
P831 - P899	Parameters for DriveMonitor and OP1S
P918 - P927	Profile parameters
r947 - P952	Fault memory
r953 - r960	Visualization parameters: Alarms
r964	Device identification
r967 - r968	Visualization parameters: Control and status word
P970 - r999	Resetting and storing parameters, list of existing and modified P and r parameters
U710 - n739	Configuration of supplementary boards in board locations 2 and 3
n980 - n999	List of existing and modified U and n parameters

Overview of abbreviations

Example:

PNU	Description	Value range [Unit] Steps	No. indices Factory setting Type	See Change (Access / Status)
P520 * 1) FDS 2) 8) 9) (G153) 10)	Friction at 0% speed Setting as % of converter rated DC current or converter rated torque	0.0 to 100.0 [%] 0.1% 4)	Ind: 4 FS=0.0 5) Type: O2 3)	P052 = 3 P051 ≥ 20 Online 6)

1) An * under the parameter number means that the parameter requires confirmation, i.e. the altered value does not take effect until the P key is pressed.

2) Abbreviation indicating that the parameter belongs to a data set (refers only to indexed parameters) (see Section 9.11 "Switch over parameter sets")

FDS Parameter belongs to the function data set (see Section 9.1, subsection "Data sets")

BDS Parameter belongs to the BICO data set (see Section 9.1, subsection "Data sets")

3) Specification of parameter type

O2 Unsigned 16-bit value

I2 Signed 16-bit value

O4 Unsigned 32-bit value

I4 Signed 32-bit value

V2 Bit-coded quantity

L2 Nibble-coded quantity

4) Setting steps for access via PKW mechanism

5) Factory setting

6) Minimum setting required (P052) to allow display of the relevant parameter

Minimum access level required (P051) to allow modification of the relevant parameter

Online: The parameter can be changed in all converter operating states

Offline: The parameter can only be changed in converter operating states of $\geq \alpha 1.0$

8)

S00 Parameter belongs to the technology software in the basic converter, S00 option

9) The "OP parameter number" (i.e. the number to be entered via the OP1S operator panel) is specified in brackets in the "PNU" column for all parameters which are not "P parameters" or "r parameters": e.g. (2010) under n010 or (2100) under U100.

10) The parameter is shown in the specified function diagram in Section 8 (here G153) in SIMOREG DC Master Operating Instructions (6RX1700-0AD76)

NOTES:

PNU	Description	Value range [Unit] Steps	No. indices Factory setting Type	See Change (Access / Status)
-----	-------------	--------------------------------	---	---------------------------------------

10.1 Operating status display

r000	<p>Operating status display</p> <p>Status display, fault and alarm messages</p> <p>Torque direction M0, MI or MII (=RUN)</p> <p>-- No torque direction active</p> <p>I Torque direction I active (MI)</p> <p>II Torque direction II active (MII)</p> <p>o1 Waiting for operating enable (=READY)</p> <p>o1.0 Brake release delay time running.</p> <p>o1.1 Waiting for operating enable at terminal 38.</p> <p>o1.2 Waiting for operating enable via binector (acc. to selection in P661) or control word, bit 3 (acc. to selection in P648)</p> <p>o1.3 Inching command cancellation delay time running.</p> <p>o1.4 Waiting for field to be reversed.</p> <p>o1.5 Waiting for cancellation of command "Brake by field reversal"</p> <p>o1.5 Waiting for operating enable from optimization run (the optimization run does not output the operating enable signal at the end until $n < n_{min}$ has been reached and SHUTDOWN input).</p> <p>o1.6 Waiting for cancellation of immediate pulse disable via binector (acc. to selection with P177) [SW 1.8 and later]</p> <p>o2 Wait for setpoint > P091.002</p> <p>o2.0 If $n-set$ (K0193) and $n-actual$ (K0166) are less than P091.002, the firing pulses are disabled and the drive goes into state o2.0. [SW 2.0 and later]</p> <p>o3 Test phase</p> <p>o3.0 Waiting for completion of thyristor check (selectable function).</p> <p>o3.1 Waiting for completion of line symmetry check.</p> <p>o3.2 Waiting for a DC contactor to pick up</p> <p>o3.3 Waiting for "Main contactor checkback" (control word 2 bit 31, see P691) [SW 1.8 and later]</p> <p>o4 Waiting for voltage (armature)</p> <p>o4.0 Waiting for voltage at power terminals 1U1, 1V1, 1W1 (the threshold set in parameters P351 and P353 must be exceeded, see also P078.001)</p> <p>o4.1 Waiting for fuse monitoring to signal OK [SW 1.7 and later]</p> <p>o5 Waiting for field current</p> <p>o5.0 Waiting until actual field current K0266 equals $> P396$ (FS=50% of field current setpoint K0275) and for "$I_{field\ extern} > I_{f\ min}$" (see P265).</p> <p>o5.1 Waiting for voltage at power terminals 3U1, 3W1 (the threshold set in parameters P351 and P353 must be exceeded, see also P078.002)</p> <div style="border: 1px solid black; padding: 5px; margin: 10px 0;"> <p>NOTE</p> <p>The converter dwells in states o4 and o5 for a maximum total delay time that is set in parameter P089. The appropriate fault message is output if the corresponding conditions are still not fulfilled at the end of this period.</p> </div> <p>o6 Wait status before the line contactor is closed</p> <p>o6.0 Waiting for auxiliaries to be switched on (delay in P093)</p> <p>o6.1 Waiting for a setpoint $\leq P091$ to be applied to the ramp-function generator input (K0193)</p> <p>o7 Waiting for switch-on command (=READY TO SWITCH ON)</p> <p>o7.0 Waiting for switch-on command via terminal 37.</p> <p>o7.1 Waiting for switch-on command via binector (acc. to selection in P654) or control word, bit 0 (acc. to selection in P648).</p> <p>o7.2 Waiting for cancellation of internal shutdown through input of an internal shutdown command or waiting for cancellation of command "Braking with field reversal"</p>		Ind: None Type: O2	P052 = 3
------	---	--	-----------------------	----------

PNU	Description	Value range [Unit] Steps	No. indices Factory setting Type	See Change (Access / Status)
	<p>o7.3 Waiting for completion of "Restore factory settings" operation.</p> <p>o7.4 Waiting for switch-on command before execution of an optimization run</p> <p>o7.5 Wait for completion of "Read in parameter set" operation.</p> <p>o7.6 Wait for completion of "Load MLFB" operation (performed at factory)</p> <p>o7.9 reserved for firmware download for optional supplementary modules [SW 2.0 and later]</p> <p>o8 Waiting for acknowledgement of starting lockout</p> <p>o8.0 Waiting for acknowledgement of starting lockout through input of SHUTDOWN command (OFF1).</p> <p>o8.1 Simulation operation active (see under U840) [SW1.7 and later]</p> <p>o9 Fast stop (OFF3)</p> <p>o9.0 Fast stop has been input via binector (acc. to selection in P658) or control word, bit 2 (acc. to selection in P648).</p> <p>o9.1 Fast stop has been input via binector (acc. to selection in P659).</p> <p>o9.2 Fast stop has been input via binector (acc. to selection in P660).</p> <p>o9.3 Fast stop is stored internally (memory can be reset by cancelling FAST STOP command and entering SHUTDOWN).</p> <p>o10 Voltage disconnection (OFF2)</p> <p>o10.0 Voltage disconnection has been input via binector (acc. to selection in P655) or control word, bit 1 (acc. to selection in P648).</p> <p>o10.1 Voltage disconnection has been input via binector (acc. to selection in P656).</p> <p>o10.2 Voltage disconnection has been input via binector (acc. to selection in P657).</p> <p>o10.3 E-Stop (safety shutdown) has been input via terminal 105 or 107</p> <p>o10.4 Wait for receipt of a valid telegram on G-SST1 (only if telegram failure time monitoring is set with P787 ≠ 0)</p> <p>o10.5 Waiting for receipt of a valid telegram on G-SST2 (only if telegram failure time monitoring is set with P797 ≠ 0)</p> <p>o10.6 Waiting for receipt of a valid telegram on G-SST3 (only if telegram failure time monitoring is set with P807 ≠ 0)</p> <p>o11 Fault</p> <p>o11.0 = Fxxx Fault message is displayed, red LED lights up.</p> <p>o12 Electronics initialization in progress</p> <p>o12.1 Basic converter electronics initialization in progress</p> <p>o12.2 Initialization of supplementary board in location 2 in progress</p> <p>o12.3 Initialization of supplementary board in location 3 in progress</p> <p>o12.9 Restructuring of parameters in non-volatile storage after software update (takes approx. 15s)</p> <p>o13 Software update in progress</p> <p>o13.0 Waiting for arrival of start command from HEXLOAD PC routine (press the DOWN key to abort this status and start a RESET)</p> <p>o13.1 Deletion of Flash EPROM in progress</p> <p>xxxxx Display of address currently being programmed</p> <p>o13.2 The Flash EPROM has been successfully programmed (a RESET is performed automatically after approx. 1 second)</p> <p>o13.3 Programming of the Flash EPROM has <u>failed</u> (press UP key to return to operating state o13.0)</p> <p>o14 Loading of boot sector in progress (this operation is performed only in factory)</p> <p>o15 Electronics not connected to voltage Dark display: Waiting for voltage at terminals 5U1, 5W1 (electronics supply voltage).</p>			

PNU	Description	Value range [Unit] Steps	No. indices Factory setting Type	See Change (Access / Status)
-----	-------------	--------------------------------	---	---------------------------------------

10.2 General visualization parameters

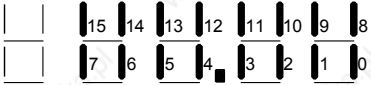
r001 (G113)	Display of terminals 4 and 5 (main setpoint)	-200.0 to 199.99 [%] 0.01%	Ind: None Type: I2	P052 = 3
r002 (G113)	Analog input, terminals 103 and 104 (main actual value)	-200.0 to 199.99 [%] 0.01%	Ind: None Type: I2	P052 = 3
r003 (G113)	Analog input, terminals 6 and 7 (selectable input 1)	-200.0 to 199.99 [%] 0.01%	Ind: None Type: I2	P052 = 3
r004 (G114)	Analog input, terminals 8 and 9 (selectable input 2)	-200.0 to 199.99 [%] 0.01%	Ind: None Type: I2	P052 = 3
r005 (G114)	Analog input, terminals 10 and 11 (selectable input 3)	-200.0 to 199.99 [%] 0.01%	Ind: None Type: I2	P052 = 3
r006 (G115)	Analog output, terminals 14 and 15 Display of output value <u>before</u> normalization and offset	-200.0 to 199.99 [%] 0.01%	Ind: None Type: I2	P052 = 3
r007 (G115)	Analog output, terminals 16 and 17 Display of output value <u>before</u> normalization and offset	-200.0 to 199.99 [%] 0.01%	Ind: None Type: I2	P052 = 3
r008 (G116)	Analog output, terminals 18 and 19 Display of output value <u>before</u> normalization and offset	-200.0 to 199.99 [%] 0.01%	Ind: None Type: I2	P052 = 3
r009 (G116)	Analog output, terminals 20 and 21 Display of output value <u>before</u> normalization and offset	-200.0 to 199.99 [%] 0.01%	Ind: None Type: I2	P052 = 3
r010 (G110)	<p>Display of status of binary inputs</p> <p>Representation on operator panel (PMU):</p>  <p>Segment ON: Corresponding terminal is activated (HIGH level is applied) Segment OFF: Corresponding terminal is not activated (LOW level is applied)</p> <p>Segment or bit</p> <ul style="list-style-type: none"> 0 Terminal 36 1 Terminal 37 (switch-on) 2 Terminal 38 (operating enable) 3 Terminal 39 4 Terminal 40 5 Terminal 41 6 Terminal 42 7 Terminal 43 8 Terminal 211 9 Terminal 212 10 Terminal 213 11 Terminal 214 12 Safety shutdown (E-Stop is applied) 1) 13 (not used) 14 (not used) 15 (not used) <p>1) The safety shutdown command is applied (segment dark) if</p> <ul style="list-style-type: none"> - terminal XS-105 is open (switch operation, see also Section 9) or - terminal XS-107 (Stop pushbutton) is opened briefly and terminal XS-108 (Reset pushbutton) is not yet activated (pushbutton operation, see also Section 9) 	Ind: None Type: V2	P052 = 3	

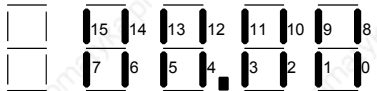
PNU	Description	Value range [Unit] Steps	No. indices Factory setting Type	See Change (Access / Status)
r011 (G112) (G117)	Display of status of binary outputs Representation on operator panel (PMU):  Segment ON: Corresponding terminal is activated (HIGH level is applied) or overloaded or short-circuited Segment OFF: Corresponding terminal is not activated (LOW level is applied) or not overloaded or not short-circuited Display of status of binary output terminals: Segment or bit 0 Terminal 46 1 Terminal 48 2 Terminal 50 3 Terminal 52 7 Terminal 109/110 (relay contact for line contactor) Display of overloading of binary outputs: Segment or bit 8 Terminal 46 9 Terminal 48 10 Terminal 50 11 Terminal 52 12 Terminal 26 (15V output) 13 Terminal 34, 44 and/or 210 (24V output)		Ind: None Type: V2	P052 = 3
r012 (G185)	Motor temperature Display of motor temperature when a KTY 84 temperature sensor is connected (P490.x=1). A value of "0" is always output in r012 when a PTC thermistor or no temperature sensor is installed. i001: Motor temperature 1 (sensor at terminals 22 / 23) i002: Motor temperature 2 (sensor at terminals 204 / 205)	-58 to +200 [°C] 1°C	Ind: 2 Type: I2	P052 = 3
r013	Heatsink temperature Display of heatsink temperature	-47 to +200 [°C] 1°C	Ind: None Type: I2	P052 = 3
r014	Temperature rise i001: Calculated motor temperature rise (see P114) i002: Calculated thyristor temperature rise (see P075)	0.0 to 200.0 [%] 0.1%	Ind: 2 Type: O2	P052 = 3
r015	Display of line voltage (armature) (generated as arithmetic rectification average, RMS value display applies to sinusoidal voltage, average over 3 line-to-line voltages)	0.0 to 2800.0 [V] 0.1V	Ind: None Type: O2	P052 = 3
r016	Display of line voltage (field) (generated as arithmetic rectification average, RMS value display applies to sinusoidal voltage)	0.0 to 800.0 [V] 0.1V	Ind: None Type: O2	P052 = 3
r017	Display of line frequency	0.00 to 120.00 [Hz] 0.01Hz	Ind: None Type: O2	P052 = 3
r018 (G163)	Display of firing angle (armature)	0.00 to 180.00 [degrees] 0.01degrees	Ind: None Type: O2	P052 = 3
r019 (G162)	Display of actual armature current The internal actual armature current value is displayed (arithmetic average over the last 6 current peaks in each case)	-400.0 to 400.0 [% of P100] 0.1% of P100	Ind: None Type: I2	P052 = 3
r020 (G162)	Display of the absolute value of armature current setpoint	0.0 to 300.0 [% of P100] 0.1% of P100	Ind: None Type: I2	P052 = 3
r021 (G160)	Display of torque setpoint after torque limitation Steps: $1 \pm 0.1\%$ of rated motor torque (=rated motor armature current (P100) * magnetic flux at rated motor field current (P102))	-400.0 to 400.0 [%] 0.1% (see column on left)	Ind: None Type: I2	P052 = 3

PNU	Description	Value range [Unit] Steps	No. indices Factory setting Type	See Change (Access / Status)
r022 (G160)	Display of torque setpoint before torque limitation Steps: $1 \pm 0.1\%$ of rated motor torque (=rated motor armature current (P100) * magnetic flux at rated motor field current (P102))	-400.0 to 400.0 [%] 0.1% (see column on left)	Ind: None Type: I2	P052 = 3
r023 (G152)	Display of speed controller setpoint/actual value deviation	-200.00 to 199.99 [%] 0.01%	Ind: None Type: I2	P052 = 3
r024 (G145)	Display of actual speed value from pulse encoder	-200.00 to 199.99 [%] 0.01%	Ind: None Type: I2	P052 = 3
r025 (G151)	Display of actual speed controller value	-200.0 to 199.99 [%] 0.01%	Ind: None Type: I2	P052 = 3
r026 (G152)	Display of speed controller setpoint	-200.0 to 199.99 [%] 0.01%	Ind: None Type: I2	P052 = 3
r027 (G136)	Display of ramp-function generator output	-200.00 to 199.99 [%] 0.01%	Ind: None Type: I2	P052 = 3
r028 (G136)	Display of ramp-function generator input	-200.00 to 199.99 [%] 0.01%	Ind: None Type: I2	P052 = 3
r029 (G135)	Display of main setpoint before limitation	-200.00 to 199.99 [%] 0.01%	Ind: None Type: I2	P052 = 3
r034 (G166)	Display of firing angle (field)	0.00 to 180.00 [degrees] 0.01degrees	Ind: None Type: O2	P052 = 3
r035 (G166)	Display of field current controller actual value	0.0 to 199.9 [% of P102] 0.1% of P102	Ind: None Type: O2	P052 = 3
r036 (G166)	Display of field current controller setpoint	0.0 to 199.9 [% of P102] 0.1% of P102	Ind: None Type: O2	P052 = 3
r037 (G165)	Display of actual EMF value	-1500.0 to 1500.0 [V] 0.1V	Ind: None Type: I2	P052 = 3
r038	Display of actual armature voltage value	-1500.0 to 1500.0 [V] 0.1V	Ind: None Type: I2	P052 = 3
r039 (G165)	Display of EMF setpoint This parameter displays the EMF setpoint which is applied as the control quantity in the field-weakening range. This value is calculated from: $U_{motor\ rated} - I_{motor\ rated} * RA (= P101 - P100 * P110)$	0.0 to 1500.0 [V] 0.1V	Ind: None Type: O2	P052 = 3

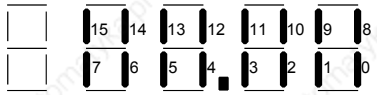
PNU	Description	Value range [Unit] Steps	No. indices Factory setting Type	See Change (Access / Status)
r040	Display of limitations: Representation on operator panel (PMU):  Segment ON: Corresponding limitation is reached Segment OFF: Corresponding limitation is not reached Segment or bit 0 α_W limit (field) reached (P251) 1 Negative current limit (field) reached (K0274) 2 α_W limit (armature) reached (α_W acc. to P151 for continuous current, 165° for discontinuous current) 3 Negative current limit (armature) reached (K0132) 4 Negative maximum speed reached (P513) Speed limiting controller responds (B0201) 5 Negative torque limit reached (B0203) 6 Neg. limitation at ramp generator output reached (K0182) 7 Neg. limitation at ramp generator input reached (K0197) 8 α_G limit (field) reached (P250) 9 Positive current limit (field) reached (K0273) 10 α_G limit (armature) reached (P150) 11 Positive current limit (armature) reached (K0131) 12 Positive maximum speed reached (P512) Speed limiting controller responds (B0201) 13 Positive torque limit reached (B0202) 14 Pos. limitation at ramp generator output reached (K0181) 15 Pos. limitation at ramp generator input reached (K0196) Note: This parameter has the same bit assignments as connector K0810.		Ind: None Type: V2	P052 = 3

Connector and binector displays				
r041 (G121)	High-resolution connector display: i001: Display of connector selected in P042.01 i002: Display of connector selected in P042.02 The display value is filtered with a time constant of 300ms (see Section 8, Sheet G121)	-200.00 to 199.99 [%] 0.01%	Ind: 2 Type: I2	P052 = 3
P042 * (G121)	High-resolution connector display: i001: Selection of connector to be displayed in r041.01 i002: Selection of connector to be displayed in r041.02 The display value is filtered with a time constant of 300ms (see Section 8, Sheet G121)	All connector numbers 1	Ind: 2 FS=0 Type: L2	P052 = 3 P051 = 40 Online
r043 (G121)	Connector display: i001: Display of connector selected in P044.01 i002: Display of connector selected in P044.02 i003: Display of connector selected in P044.03 i004: Display of connector selected in P044.04 i005: Display of connector selected in P044.05 i006: Display of connector selected in P044.06 i007: Display of connector selected in P044.07	-200.0 to 199.9 [%] 0.1%	Ind: 7 Type: I2	P052 = 3
P044 * (G121)	Connector display: i001: Selection of connector displayed in r043.01 i002: Selection of connector displayed in r043.02 i003: Selection of connector displayed in r043.03 i004: Selection of connector displayed in r043.04 i005: Selection of connector displayed in r043.05 i006: Selection of connector displayed in r043.06 i007: Selection of connector displayed in r043.07	All connector numbers 1	Ind: 7 FS=0 Type: L2	P052 = 3 P051 = 40 Online
r045 (G121)	Binector display: i001: Display of binector selected in P046.01 i002: Display of binector selected in P046.02 i003: Display of binector selected in P046.03 i004: Display of binector selected in P046.04	0 to 1	Ind: 4 Type: O2	P052 = 3

PNU	Description	Value range [Unit] Steps	No. indices Factory setting Type	See Change (Access / Status)
P046 * (G121)	Binector display: i001: Selection of binector displayed in r045.01 i002: Selection of binector displayed in r045.02 i003: Selection of binector displayed in r045.03 i004: Selection of binector displayed in r045.04	All binector numbers 1	Ind: 4 FS=0 Type: L2	P052 = 3 P051 = 40 Online
r047	Display of fault diagnostic memory Provides more detailed information about the cause of a fault after activation of a fault message (see Section 10). i001 Word 1 (fault value) i002 Word 2 ... i016 Word 16 (fault number)	0 to 65535 1	Ind: 16 Type: O2	P052 = 3
r048 (G189)	Hours run Display of time (hours) in which drive has been operating in states I, II or --. All times of \geq approx. 0.1 s are included in the count.	0 to 65535 [hours] 1 hour	Ind: None Type: O2	P052 = 3
r049 (G189)	Fault time Display of time at which the current fault, and the last 7 acknowledged faults, were activated. i001: Current fault hours i002: 1 st acknowledged fault hours i003: 2 nd acknowledged fault hours i004: 3 rd acknowledged fault hours i005: 4 th acknowledged fault hours i006: 5 th acknowledged fault hours i007: 6 th acknowledged fault hours i008: 7 th acknowledged fault hours	0 to 65535 [hours] 1 hour	Ind: 8 Type: O2	P052 = 3
P050 *	Language Language of plaintext display on optional OP1S operator panel and in DriveMonitor PC service routine 0: German 1: English 2: Spanish 3: French 4: Italian	0 to 4 1	Ind: None FS=0 Type: O2	P052 = 3 P051 \geq 0 Online

10.3 Access authorization levels

P051 *	Key parameters 0 No access authorization 6 Do not set (for use by DriveMonitor) 7 Do not set (for use by DriveMonitor) 9 Do not set (for use by DriveMonitor) 21 Restore factory settings All parameters are reset to their defaults (factory settings). Parameter P051 is then automatically reset to factory setting "40". 22 Execute internal offset compensation (see Section 7.4) 25 Optimization run for precontrol and current controller (armature and field) (see Section 7.5) 26 Optimization run for speed controller (see Section 7.5) 27 Optimization run for field weakening (see Section 7.5) 28 Optimization run for compensation of friction and moment of inertia (see Section 7.5) 29 Optimization run for the speed controller with an oscillating mechanical system (see Section 7.5) 40 Access authorization to parameter values for authorized service personnel	see column on left	Ind: None FS=40 Type: O2	P052 = 3 P051 \geq 0 Online
P052 *	Selection of display parameters 0 0 Display only parameters that are not set to original factory settings 1 Display only parameters for simple applications 3 Display all parameters used	0, 1, 3	Ind: None FS=3 Type: O2	P052 = 3 P051 \geq 0 Online

PNU	Description	Value range [Unit] Steps	No. indices Factory setting Type	See Change (Access / Status)
P053 *	<p>Control word for the permanent memory [SW 1.7 and later]</p> <p>Disabling or enabling write accesses to the permanent memory</p> <p>i001: Disabling or enabling write accesses to the <u>parameter memory</u></p> <p>0 Only save parameter P053 in the permanent memory; parameter changes are active immediately but the changed values are only stored temporarily and are lost when the electronics supply voltage is switched off</p> <p>1 Save all parameter values in the permanent memory</p> <p>i002: Disabling or enabling write accesses to the memory of the <u>nonvolatile process data</u></p> <p>0 Do not save nonvolatile process data in the permanent memory</p> <p>1 Save all nonvolatile process data in the permanent memory</p> <p>If the nonvolatile process data are not stored (P053.002=0), data are lost when the electronics supply of the SIMOREG DC Master is switched off, i.e. they have the value 0 after the electronics supply is switched on again:</p> <p>K0240: Setpoint of the motor potentiometer K0309: Motor heating K0310: Thyristor heating K9195: Output of the 1st tracking/storage element K9196: Output of the 2nd tracking/storage element</p>	0 to 1 1	Ind: 2 FS=1 Type: O2	P052 = 3 P051 = 0 on-line
P054	<p>OP1S – Background lighting</p> <p>0 ON continuously</p> <p>1 ON when panel is in use</p>	0, 1	Ind: None FS=0 Type: O2	P052 = 3 P051 ≥ 0 Online
P055 * (G175)	<p>Copy function data set</p> <p>This parameter allows parameter set 1, 2, 3 or 4 to be <u>copied</u> to parameter set 1, 2, 3 or 4. This function is applicable only to parameters with 4 indices in the function data set (see also Section 9.1, Data sets and Section 9.11, and Section 8, Sheet G175).</p> <p>0xy <u>Do nothing</u>, automatic resetting value at the end of a copy operation.</p> <p>1xy The contents of parameter set x (source data set, x=1, 2, 3 or 4) are <u>copied</u> to parameter set y (target data set, y=1, 2, 3 or 4) (parameter set x remains unchanged, the original contents of parameter set y are overwritten). x and y are the respective parameter set numbers (1, 2, 3 or 4) of the source and target parameter sets.</p> <p>The copy operation is started by switching P055 over into parameter mode when P055=1xy. During the copy operation, the numbers of the parameters being copied are displayed on the operator panel (PMU). At the end of the copy operation, P055 is reset to P055=0xy.</p>	011 to 143 1	Ind: None FS=012 Type: L2	P052 = 3 P051 = 40 Offline
r056 (G175)	Display of active function data set	1 to 4 1	Ind: None Type: O2	P052 = 3
P057 * (G175)	<p>Copy Bico data set</p> <p>This parameter allows parameter set 1 or 2 to be <u>copied</u> to parameter set 1 or 2. This function is applicable only to parameters with 2 indices in the Bico data set (see also Section 9.1, Data sets and Section 9.11, and Section 8, Sheet G175).</p> <p>0xy <u>Do nothing</u>, automatic resetting value at the end of a copy operation.</p> <p>1xy The contents of parameter set x (source data set, x=1 or 2) are <u>copied</u> to parameter set y (target data set, y=1 or 2) (parameter set x remains unchanged, the original contents of parameter set y are overwritten). x and y are the respective parameter set numbers (1 or 2) of the source and target parameter sets.</p> <p>The copy operation is started by switching P057 over into parameter mode when P057=1xy. During the copy operation, the numbers of the parameters being copied are displayed on the operator panel (PMU). At the end of the copy operation, P057 is reset to P057=0xy.</p>	011 to 121 1	Ind: None FS=012 Type: L2	P052 = 3 P051 = 40 Offline
r058 (G175)	Display of active Bico data set	1 to 2 1	Ind: None Type: O2	P052 = 3

PNU	Description	Value range [Unit] Steps	No. indices Factory setting Type	See Change (Access / Status)
r059	Display of operating state Meaning as for r000	0.0 to 14.5 0.1	Ind: None Type: O2	P052 = 3

10.4 Definition of SIMOREG DC MASTER converter

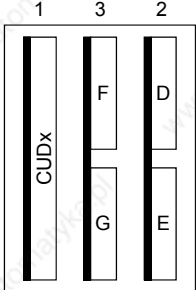
r060 (G101)	Software version Converter software release i001: CUD i002: Slot D (board location 2) i003: Slot E (board location 2) i004: Slot F (board location 3) i005: Slot G (board location 3)	0.0 to 9.9 0.1	Ind: 5 Type: O2	P052 = 3
r061 (G101)	Creation date of software i001: Year i002: Month i003: Day i004: Hour i005: Minute		Ind: 5 Type: O2	P052 = 3
r062 (G101)	Checksum i001: Converter firmware checksum i002: Boot sector checksum		Ind: 2 Type: L2	P052 = 3
r063 (G101)	Board code Identification code of boards mounted in locations 1 to 3 of electronics box.  <p>Arrangement of board locations 1 to 3 and slots D to G in electronics box</p> i001: Board in location 1 71: CUD1 72: CUD1 + CUD2 i002: Board in slot D (upper slot of location 2) 111: Pulse encoder board (SBP) [SW 1.8 and later] 131 to 139: Technology board 141 to 149: Communications board 151, 152, 161: Special board (EB1, EB2, SLB) i003: Board in slot E (lower slot of location 2) 111: Pulse encoder board (SBP) [SW 1.8 and later] 131 to 139: Technology board 141 to 149: Communications board 151, 152, 161: Special board (EB1, EB2, SLB) i004: Board in slot F (upper slot of location 3) 111: Pulse encoder board (SBP) [SW 1.8 and later] 141 to 149: Communications board 151, 152, 161: Special board (EB1, EB2, SLB) i005: Board in slot G (lower slot of location 3) 111: Pulse encoder board (SBP) [SW 1.8 and later] 141 to 149: Communications board 151, 152, 161: Special board (EB1, EB2, SLB)		Ind: 5 Type: O2	P052 = 3

PNU	Description	Value range [Unit] Steps	No. indices Factory setting Type	See Change (Access / Status)
r064 (G101)	<p>Board compatibility</p> <p>Compatibility identifier of boards in locations 1 to 3 of electronics box. The compatibility identifier is bit-coded. To ensure the compatibility of a board, it must have a "1" setting at the same bit location of the parameter value as the CUD (in location 1 / index i001).</p> <p>Indices: i001: Compatibility identifier of board in location 1 i002: Compatibility identifier of board in slot D i003: Compatibility identifier of board in slot E i004: Compatibility identifier of board in slot F i005: Compatibility identifier of board in slot G</p> <p>Example: Index Value Bit representation Compatible with CUD i001 253 0000 0000 1111 1101 i002 002 0000 0000 0000 0010 no i003 001 0000 0000 0000 0001 yes</p>		Ind: 5 Type: O2	P052 = 3
r065 (G101)	<p>Software identifiers</p> <p>Extended software version identifiers in locations 1, 2, and 3 of the electronics box</p> <p>Indices: i001: Software identifier of the board in location 1 i002: Software identifier of the board in slot D i003: Software identifier of the board in slot E i004: Software identifier of the board in slot F i005: Software identifier of the board in slot G</p>		Ind: 5 Type: O2	P052 = 3
P067 * (G101)	<p>Load class [SW1.8 and later]</p> <p>1 Load class DC I 2 Load class DC II 3 Load class DC III 4 Load class DC IV 5 US rating</p> <p>The load classes are described in Chapter 3.4.1.</p> <p>Depending on the load class selected, the device rated DC of the SIMOREG DC Master is reduced to a value of different magnitude to suit the power section and load class. The current value of the device rated DC is indicated in parameter r072.002.</p> <p>Notes: If the device rated DC is reduced via parameter P076.001, the lesser of the two values is active.</p> <p>If you set a value of > 1 in P067, you must ensure that the "Dynamic overload capability of power module" is enabled, i.e. a value of > 0 must be set in parameter P075.</p> <p>The SIMOREG DC Master does <u>not</u> monitor for compliance with the criteria of the load class set in parameter P067. If permitted by the power module, the unit can operate for overload periods in excess of those defined by the load class. The permissible overload period for the installed power module is always longer than the period defined for the load class. The SIMOREG DC Master <u>does</u> monitor the actual permissible overload period for the power module. See Section 9.15.</p>	1 to 5 1	Ind: None FS=1 Type: O2	P052 = 3 P051 = 40 off-line
r068 (G101)	<p>Options according to rating plate</p> <p>0 No option 1 Option L04 (low voltage, 85V) 2 Option K00 (terminal expansion) 3 L04 and K00</p>		Ind: None Type: O2	P052 = 3

PNU	Description	Value range [Unit] Steps	No. indices Factory setting Type	See Change (Access / Status)
r069 (G101)	<p>Serial number of SIMOREG DC Master converter</p> <p>i001: 1st and 2nd places of serial number i002: 3rd and 4th places of serial number i003: 5th and 6th places of serial number i004: 7th and 8th places of serial number i005: 9th and 10th places of serial number i006: 11th and 12th places of serial number i007: 13th and 14th places of serial number i008 to i015: 0 i016: Checksum for serial number</p> <p>The serial number ASCII code is displayed in this parameter. The number is output in plaintext on the OP1S panel.</p>		Ind: 16 Type: L2	P052 = 3
r070 (G101)	<p>MLFB (order number) of SIMOREG DC Master converter</p> <p>The corresponding MLFB is displayed in encoded form in this parameter. The MLFB is displayed in plaintext on the OP1S panel.</p>	0 to 120 1	Ind: None Type: O2	P052 = 3
r071 (G101)	<p>Converter rated supply voltage (armature)</p> <p>Converter rated supply voltage (armature) as specified on rating plate</p>	10 to 830 [V] 1V	Ind: None Type: O2	P052 = 3
r072 (G101)	<p>Converter rated DC current (armature)</p> <p>i001: Converter rated DC current (armature) as specified on rating plate (output DC current at power terminals 1C1 and 1D1) i002: Actual converter rated DC current (armature) according to setting in parameter P076.001 or P067</p>	0.0 to 6553.5 [A] 0.1A	Ind: 2 Type: O2	P052 = 3
r073 (G101)	<p>Converter rated DC current (field)</p> <p>i001: Converter rated DC current (field) as specified on rating plate (output DC current at power terminals 3C and 3D) i002: Actual converter rated DC current (field) as set in parameter P076.002</p>	0.00 to 100.00 [A] 0.01A	Ind: 2 Type: O2	P052 = 3
r074 (G101)	<p>Converter rated supply voltage (field)</p> <p>Converter rated supply voltage (field) as specified on rating plate</p>	10 to 460 [V] 1V	Ind: None Type: O2	P052 = 3
P075 * (G101) (G161)	<p>Control word for power section</p> <p>Selection of operating characteristics of thermal monitor (I²t monitoring) of power section (see also Section 9.16 "Dynamic overload capability of power section").</p> <p>The "Dynamic overload capability of the power module" allows the SIMOREG DC Master to operate for short periods on armature currents that are higher than the converter rated DC current specified on the rating plate (=r072.001).</p> <p>The permissible overload period is determined solely by the power module and the preceding operating history.</p> <p>The "thermal power module monitoring" function <u>does not</u> monitor operation in compliance with the load class criteria set in parameter P067. If permitted by the power module, the unit can operate for overload periods in excess of those defined by the load class.</p> <p>0 <u>Dynamic overload capability is not permitted</u> The armature current is limited to P077 * r072.001.</p> <p>1 <u>Dynamic overload capability is permitted, alarm A039</u> The armature current is limited to P077 * 1.8 * r072.001 as long as the calculated thyristor temperature does not exceed the permitted value. If the temperature exceeds the permitted value, the SIMOREG DC Master protects itself by reducing the current limit to P077 * r072.001. Alarm A039 is output at the same time. The armature current setpoint limit is not increased to P077 * 1.8 * r072.001 (alarm A039 also disappears) until the calculated thyristor temperature has dropped below the limit value again and the armature current setpoint is lower than the converter rated DC current (r072.001).</p> <p>2 <u>Dynamic overload capability is permitted, fault F039</u> The armature current is limited to P077 * 1.8 * r072.001 as long as the calculated thyristor temperature does not exceed the permitted value. Fault message F039 is output if the permissible temperature limit is exceeded.</p>	0 to 2 1	Ind: None FS=1 Type: O2	P052 = 3 P051 = 40 off-line

PNU	Description	Value range [Unit] Steps	No. indices Factory setting Type	See Change (Access / Status)
P076 * (G101)	<p>Reduction of converter rated DC current</p> <p>i001: Reduction of converter rated DC current (armature) i002: Reduction of converter rated DC current (field)</p> <p>For the purpose of achieving a close match between the converter and motor, the converter rated DC current is reduced to the value entered here.</p> <p>The current value of the device rated DC is indicated in parameter r072.002.</p> <p>The following values can be set: 10.0%, 20.0%, 33.3%, 40.0%, 50.0%, 60.0%, 66.6% 70.0%, 80.0%, 90.0% and 100.0%</p> <p><u>Note:</u> If a load class is selected in parameter P067 which causes a reduction in the converter rated DC current, then the lower of the two parameter setting values is effective.</p>	see column on left	Ind: 2 FS=100.0 Type: O2	P052 = 3 P051 = 40 Offline
P077 (G101) (G161)	<p>Total thermal reduction factor</p> <p>The factor set in this parameter effects a <u>reduction in the armature current limit</u> (as defined by the setting in P075).</p> <p>The converter must be derated in the following instances:</p> <ul style="list-style-type: none"> – Operation at high ambient temperatures: If the ambient temperature is higher than 45°C (on naturally air-cooled converters) or 35°C (on converters with forced air-cooling), the possible load capability of the converter decreases as a consequence of the maximum permissible thyristor junction temperature by percentage reduction "a" as specified in the table in Section 3.4, resulting in a temperature reduction factor of $k_{temp} = k1$ – Installation altitudes of over 1000m above sea level: In this case, the lower air density and thus less effective cooling reduce the possible load capability of the converter to the percentage load "b1" specified in the table in Section 3.4, resulting in an installation altitude reduction factor of $k_{altitude} = k2$ <p>P077 must be set as follows: $P077 = k_{temp} * k_{altitude}$</p> <p>Note: A general reduction in the converter rated DC current (through appropriate setting of parameter P076.001) can be included in this calculation.</p>	0.50 to 1.00 0.01	Ind: None FS=1.00 Type: O2	P052 = 3 P051 = 40 Offline
P078 (G101)	<p>Reduction of converter rated supply voltage</p> <p>i001: Rated input voltage converter armature i002: Rated input voltage converter field</p> <p>The rated voltage value of the power system actually used to supply the power section must be set in this parameter. This setting acts as the reference for the undervoltage, overvoltage and phase failure monitoring functions (see also P351, P352 and P353) as well as for connectors K0285 to K0289, K0291, K0292, K0301 K0302, K0303 and K0305</p> <div style="border: 1px solid black; padding: 5px; margin-top: 10px;"> <p>NOTE If a SIMOREG converter is operated at a rated input voltage that is lower than its rated supply voltage, then the rated DC voltage specified in the technical data (Section 3.4) cannot be reached !</p> </div>	i001: 10 to r071 i002: 10 to r074 [V] 1V	Ind: 2 FS= i001: r071 i002: 400V except when r071 = 460V then 460V Type: O2	P052 = 3 P051 = 40 Offline
P079 * (G163)	<p>Short pulses / long pulses, armature gating unit</p> <p>0 <u>Short pulses</u> (0.89 ms=approx. 16 degrees at 50 Hz) are output on the armature gating unit.</p> <p>1 <u>Long pulses</u> (pulse duration up to approx. 0.1 ms before next pulse) are output on the armature gating unit (e.g. required in cases where field is supplied via armature terminals).</p>	0 to 1 1	Ind: None FS=0 Type: O2	P052 = 3 P051 = 40 Offline

PNU	Description	Value range [Unit] Steps	No. indices Factory setting Type	See Change (Access / Status)
-----	-------------	--------------------------------	---	---------------------------------------

10.5 Setting values for converter control

P080 * (G140)	<p>Control word for brake control</p> <p>1 The brake is a <u>holding brake</u> When the "Operating enable" command is cancelled or when the "Voltage disconnection" or "E-Stop" command is input, the "Close brake" command is not input until $n < n_{min}$ (P370, P371) is reached.</p> <p>2 The brake is an <u>operating brake</u> When the "Operating enable" command is cancelled or when the "Voltage disconnection" or "E-Stop" command is input, the "Close brake" command is input immediately, i.e. while the motor is still rotating.</p>	1 to 2	Ind: None FS=1 Type: O2	P052 = 3 P051 = 40 Offline
P081 * (G165)	<p>EMF-dependent field weakening</p> <p>0 <u>No field-weakening operation as a function of speed or EMF</u> (100% of rated motor field current is applied constantly as the internal field current setpoint).</p> <p>1 <u>Field-weakening operation by internal closed-loop EMF control</u> to ensure that in field-weakening operation, i.e. at speeds above the motor rated speed (= "field-weakening activation limit speed"), the motor EMF is maintained constantly at the setpoint $EMF_{set} (K0289) = P101 - P100 * P110$ (field current setpoint is the product of the EMF controller output and the precontrol component determined by the actual speed according to the field characteristic).</p> <div style="border: 1px solid black; padding: 5px; margin-top: 10px;"> <p>NOTICE When P081=1, a valid field characteristic must be available (P117=1), otherwise the optimization run for field weakening (P051=27) must be executed.</p> </div>	0 to 1 1	Ind: None FS=0 Type: L2	P052 = 3 P051 = 40 Offline

PNU	Description	Value range [Unit] Steps	No. indices Factory setting Type	See Change (Access / Status)
P082 * (G166)	<p>Operating mode for field</p> <p>No field</p> <p>0 No field is used (e.g. in the case of permanent-field motors). The field gating pulses are disabled. Unlike all other cases, the motor flux (K0290) is <u>not</u> calculated according to the field characteristic (P120 to P139) as a function of the actual field current (K0265), but set to the value for 100% rated flux.</p> <p>Internal field power module</p> <p>1 The field is <u>switched with the line contactor</u> - this setting must be selected if the mains supplies for the field and armature power sections are connected or disconnected simultaneously (field gating pulses are enabled/disabled at the same time as the line contactor is closed/opened, the field current decays with the field time constant).</p> <p>2 Automatic injection of <u>standstill field</u> set in P257 after expiry of a time period set in P258, after converter has reached operating state o7 or higher.</p> <p>3 Field <u>ACTIVE</u> continuously.</p> <p>4 The field is switched with the "<u>Auxiliaries ON</u>" (B0251) signal</p> <p>External field power module (40.00A field)</p> <p>11 Board C98043-A7044 (40A field power module) is inserted at connector X102 on board C98043-A7002 or C98043-A7003. The <u>field is controlled as described in para. 1.</u></p> <p>12 As described in para. 11, but the field is controlled as described in para. 2.</p> <p>13 As described in para. 11, but the field is controlled as described in para. 3.</p> <p>14 As described in para. 11, but the field is controlled as described in para. 4.</p> <p>External field device</p> <p>21 An <u>external field device</u> is used. The setpoint for the external field device is supplied via connector K0268 (e.g. via an analog output or the peer-to-peer interface). The rated DC current of the external field device is set in parameter U838. This value is also displayed in parameter r073.001. P076.002 is inoperative. If the external field device supplies an actual field current signal, then this can be fed in at P612. If not, then P263 should be set to 1 or 2. If the external field device supplies an "I field < I field min" signal, then this can be fed in at P265. The <u>field is controlled</u> as described in <u>para. 1.</u></p> <p>22 As described in para. 21, but the field is controlled as described in para. 2.</p> <p>23 As described in para. 21, but the field is controlled as described in para. 3.</p> <p>24 As described in para. 21, but the field is controlled as described in para. 4.</p> <div style="border: 1px solid black; padding: 5px; margin-top: 10px;"> <p>NOTICE Even though changes to the parameter value from > 0 to = 0 are accepted in operating states of ≥ 01.0, they do not take effect until the converter reaches an operating state of ≥ 07.0. [Values 11 to 24 can be set only in SW 1.9 and later]</p> </div>	0 to 24 1	Ind: None FS=2 Type: O2	P052 = 3 P051 = 40 Offline

PNU	Description	Value range [Unit] Steps	No. indices Factory setting Type	See Change (Access / Status)
P083 * FDS (G151)	<p>Selection of actual speed value</p> <p>0 Actual speed value is not yet selected (fixed value 0%)</p> <p>1 Actual speed value supplied by "Main actual value" channel (K0013) (terminals XT.103, XT.104)</p> <p>2 Actual speed value supplied by "Actual speed from pulse encoder" channel (K0040)</p> <p>3 Actual speed value supplied by "Actual EMF" channel (K0287), but weighted with P115 (operation without tachometer)</p> <p>Note: The effectiveness of the overspeed monitoring function (see Section 8, function diagram G188) is restricted, since very high motor speeds can be reached if the EMF is utilized as the actual speed value when the <u>actual field current value is too low</u>.</p> <p>4 Actual speed value is wired up freely (selected in P609)</p>	0 to 4 1	Ind: 4 FS=0 Type: O2	P052 = 3 P051 = 40 Offline
P084 * (G160)	<p>Selection of closed-loop speed / current or torque control</p> <p>1 Operation under closed-loop speed control</p> <p>2 Operation under closed-loop current / torque control The setpoint supplied by the ramp-function generator output is input as a current or torque setpoint (speed controller is bypassed)</p>	1 to 2 1	Ind: None FS=1 Type: O2	P052 = 3 P051 = 40 Offline
P085	<p>Wait period after cancellation of inching command</p> <p>After an inching command has been cancelled, the drive dwells in operating state o1.3 for the time period set in this parameter with the controllers disabled, but the line contactor closed. This wait period does not commence until $n < n_{min}$ (P370, P371) is reached. If a new inching command is input within this period, then the drive switches to the next operating state (o1.2 or lower). However, if the time runs out without a new inching command being entered, then the line contactor drops out and the drive switches to operating state o7 (see also Section 9).</p>	0.0 to 60.0 [s] 0.1s	Ind: None FS=10.0 Type: O2	P052 = 3 P051 = 40 Online
P086	<p>Voltage failure period for automatic restart</p> <p>If the voltage fails (F001, F004) at one of the terminals 1U1, 1V1, 1W1, 3U1, 3W1, 5U1 or 5W1, or if it drops below a certain threshold (F006 undervoltage) or exceeds a certain threshold (F007 overvoltage), or its frequency is too low (F008 frequency < P363) or too high (F009 frequency > P364), or if the actual field current drops to below 50% of the field current setpoint for more than 0.5s (F005), then the corresponding fault message is activated only if the fault condition has not been eliminated within the "Automatic restart" period set in this parameter.</p> <p>The gating pulses and controllers are disabled while the fault conditions are present. The converter dwells in operating state o4 (in the case of armature line voltage fault) or o5 (in the case of field line voltage or field current fault) or in o13.</p> <p>Setting this parameter to 0.00s deactivates the "Automatic restart" function.</p> <p>NOTE: Setting values higher than 2.00s are effective only in relation to the voltages at terminals 1U1, 1V1, 1W1, 3U1 and 3W1. A "restart time" of 2.00 s is operative in this case for the voltage at terminals 5U1 and 5W1 (electronics power supply).</p>	0.00 to 10.00 [s] 0.01s	Ind: None FS=0.40 Type: O2	P052 = 3 P051 = 40 Online
P087 (G140)	<p>Brake release time</p> <p>-10.00 to -0.01 s The "Release brake" command is delayed in relation to enabling of the gating pulses for thyristors and controllers (i.e. operating state I, II or --) by the delay time set in this parameter. During this period, the motor rotates against the closed brake. This setting is useful, for example, for vertical loads.</p> <p>0.00 to +10.00 s When a "Switch-on" or "Inching" or "Crawling" command is input with "Operating enable", the drive dwells in operating state o1.0 for the delay period set in this parameter; the internal controller enabling signal, and thus enabling of the thyristor gating pulses, do not take effect until the delay period has elapsed so as to give the holding brake time to open.</p>	-10.00 to 10.00 [s] 0.01s	Ind: None FS=0.00 Type: I2	P052 = 3 P051 = 40 Online

PNU	Description	Value range [Unit] Steps	No. indices Factory setting Type	See Change (Access / Status)
P088 (G140) (G187)	Brake closing time When the "Switch-on" or "Inching" or "Crawling" command is cancelled, or when the "Switch-on" command is not applied, or when the "Fast stop" command is input, the internal controller disabling signal, and thus the thyristor gating pulse disabling signal, is not actually activated after $n < n_{min}$ has been reached until the time delay set in this parameter has elapsed. During this period, the drive continues to produce a torque (operating state I, II or –), so as to give the holding brake enough time to close.	0.00 to 10.00 [s] 0.01s	Ind: None FS=0.00 Type: O2	P052 = 3 P051 = 40 Online
P089	Maximum wait time for voltage to appear at power section When the line contactor has dropped out and the "Switch-on" or "Inching" or "Crawling" command is applied, the converter waits in operating states o4 and o5 for voltage to appear at the power section, for the actual field current value (K0265) to reach > 50% of the field current setpoint (K0268). The corresponding fault message is activated if no power section voltage and no field current is detected. This parameter specifies the maximum total delay period in which the drive may dwell in operating states o4 and o5 (response threshold for function which checks for voltage at power section, see parameter P353).	0.0 to 60.0 [s] 0.1s	Ind: None FS=2.0 Type: O2	P052 = 3 P051 = 40 Online
P090	Stabilization time for line voltage When the line contactor has dropped out and the "Switch-on" or "Inching" or "Crawling" command is applied, or after a phase failure has been detected in the armature or field mains supply with active "Automatic restart" function (P086>0), the converter dwells in operating state o4 and o5 until voltage appears at the power section. Line voltage is not assumed to be applied to the power terminals until the amplitude, frequency and phase symmetry have remained within the permissible tolerance for a period exceeding the setting in this parameter. The parameter applies to both the armature and field power connections. Caution: The setting in P090 must be lower than the settings in P086 (except when P086=0.0) and P089!	0.01 to 1.00 [s] 0.01s	Ind: None FS=0.02 Type: O2	P052 = 3 P051 = 40 Online
P091	Setpoint threshold i001: <u>Threshold for function "Switch on only if setpoint is low"</u> The converter can be switched on only if a setpoint $ K0193 \leq P091.001$ is applied to the ramp-function generator input. If the applied setpoint is higher, the converter dwells in state o6 after "switch-on" until the absolute setpoint value is $\leq P091.001$. i002: <u>Threshold for function "Automatic pulse disable if setpoint is low"</u> [SW 2.0 and later] If $ n-set $ ($ K0193 $) and $ n-act $ ($K0166$) are less than P091.002, the firing pulses are disabled and the drive goes into state o2.0.	0.00 to 199.99 [%] 0.01%	Ind: 2 FS= i001: 199.99 i002: 0.00 Type: O2	P052 = 3 P051 = 40 Online

PNU	Description	Value range [Unit] Steps	No. indices Factory setting Type	See Change (Access / Status)
P092 (G200)	<p>Delay times for field reversal</p> <p>These times are used to control a reversing contactor for reversing the field polarity on a 1-quadrant converter with field reversal.</p> <p>i001: <u>Delay time for the field reduction before opening of the current field contactor</u></p> <p>When field polarity reversal is initiated, the delay time set in P092.i001 elapsed after reaching I_{field} (K0265) < $I_{field\ min}$ (P394) before the current field contactor is opened.</p> <p>i002: <u>Delay time before actuation of the new field contactor</u> [only SW 1.7 and later]</p> <p>After opening the current field contactor the delay time set in P092.i002 elapsed before the field contactor for the "new" field direction is actuated (drop-out delay time of the contactor use is usually longer than the pick-up delay time).</p> <p>i003: <u>Delay time for enabling the field firing pulses</u> [only SW 1.7 and later]</p> <p>After actuation of the field contactor for the "new" field direction, the delay time acc. to P092.i003 elapses before the field firing pulses are enabled. This time must be longer than the pick-up delay time of the contactor used.</p> <p>i004: <u>Delay time after the field build-up before armature enable</u> [only SW 1.7 and later]</p> <p>After - directly following the field firing pulse enable - the actual field current value I_{field} in the "new" field direction has reached the value I_{field} (K0265) > $I_{field\ set}$ (K0268)*P398/100%, the delay time acc. to P092.i004 elapses. Then the internal (armature) "Operating enable of field reversal" is issued, i.e. the Stopping of the drive in operating state $\geq o1.4$ is canceled. This delay time permits waiting of the end of overshooting of the actual field current value and therefore overshooting of the EMF of the DC machine straight after the field current has been built up again, before the "armature operating enable" is issued. This is intended to prevent armature overcurrents due to excessive EMF during overshooting.</p>	0.0 to 10.0 [s] 0.1s	Ind: 4 FS= i001: 3.0 i002: 0.2 i003: 0.1 i004: 3.0 Type: O2	P052 = 3 P051 = 40 Online
P093	<p>Pick-up delay for line contactor</p> <p>Pick-up of the line contactor is delayed in relation to "Switch on auxiliaries" by the time delay set in this parameter.</p>	0.0 to 120.0 [s] 0.1s	Ind: None FS=0.0 Type: O2	P052 = 3 P051 = 40 Online
P094	<p>Switch-off delay for auxiliaries</p> <p>Switch-off of the auxiliaries is delayed in relation to dropout of the line contactor by the time delay set in this parameter.</p>	0.0 to 6500.0 [s] 0.1s	Ind: None FS=0.0 Type: O2	P052 = 3 P051 = 40 Online
P095	<p>Pick-up time for a contactor in the DC circuit</p> <p>If the DC output (terminals 1C1 and 1D1) is switched through to the motor via a contactor, and if this contactor is controlled by the "Relay for line contactor" (terminals 109 and 110), then the gating pulses may not be enabled until the contactor has safely picked up. For this purpose, it may be necessary to parameterize an additional delay time for the pick-up operation. The timer set in P095 commences during a pick-up operation when the converter reaches operating state o5. If the timer has still not run down by the time the converter exits state o4, then the converter dwells in state o3.2 until the timer has finished.</p> <p>During the time period set in P095, the "Main contactor checkback" signal must also switch to "1" if this function is activated (see P691). Otherwise the converter dwells in state o3.3 until the timer has finished and fault message F004 is then output with fault value 6.</p>	0.00 to 1.00 [s] 0.01s	Ind: None FS=0.00 Type: O2	P052 = 3 P051 = 40 Online
P096	<p>After-running time for the device fan [SW 1.6 and later]</p> <p>After the drive has been shut down (operating state ≥ 7.0 reached) the device fan continues to run until the power section has cooled down.</p> <p>With this parameter you can set the minimum duration for the after-running time.</p> <p>Note: If the field current is not switched off after the drive is shut down (see P082), the field current can prevent cooling of the power section. In this case, the equipment blower is never switched off.</p>	0.0 to 60.0 [min] 0.1min	Ind: None FS=4.0 Type: O2	P052 = 3 P051 = 40 on-line

PNU	Description	Value range [Unit] Steps	No. indices Factory setting Type	See Change (Access / Status)
P097 * (G166)	Response of field current to fault messages [SW 2.1 and later] 0 Field pulses are blocked when a fault message is activated 1 Field pulses are not blocked when a fault message is activated, but the field current setpoint cannot be increased above its current setting.	0 to 1 1	Ind: None FS=1 Type: O2	P052 = 3 P051 = 40 Online
P098 *	Contactors in DC circuit [SW 2.1 and later] 0 The DC circuit does <u>not</u> include a contactor 1 The DC circuit contains a contactor which is controlled by the "relay for the line contactor" (terminals 109 and 110). The values for the armature voltage U _a and for EMF (K0286, K0287, K0291, K0292, r037, r038) are set to 0% whenever B0124 = 0 (request main contactor not active). This is because the motor terminals are separated in this case from output terminals 1C and 1D of the SIMOREG DC Master and it is then impossible to measure the armature voltage U _a (or the EMF).	0 to 1 1	Ind: None FS=0 Type: O2	P052 = 3 P051 = 40 Online

10.6 Definition of motor

P100 * FDS (G165)	Rated motor armature current (acc. to motor rating plate) 0.0 Parameter not yet set	0.0 to 6553.0 [A] 0.1A	Ind: 4 FS=0.0 Type: O2	P052 = 3 P051 = 40 Offline
P101 * FDS (G165)	Rated motor armature voltage (acc. to motor rating plate) Notes: One of the functions of this parameter is to determine the point at which field-weakening operation commences. If possible, the rated motor armature voltage + the voltage drop in the motor feeder cable (for a current setting acc. to P100) should be set in P101.	10 to 2800 [V] 1V	Ind: 4 FS=400 Type: O2	P052 = 3 P051 = 40 Offline
P102 * FDS (G165)	Rated motor field current (acc. to motor rating plate) 0.00 Parameter not yet set	0.00 to 600.00 [A] 0.01A	Ind: 4 FS=0.00 Type: O2	P052 = 3 P051 = 40 Online
P103 * FDS (G165)	Minimum motor field current Note: P103 must be set to <50% of P102 to execute the optimization run for field weakening (P051=27).	0.00 to 100.00 [A] 0.01A	Ind: 4 FS=0.00 Type: O2	P052 = 3 P051 = 40 Offline
P104 * FDS (G161)	Speed n1 (acc. to motor rating plate) 1 st point (speed value) in speed-dependent current limitation. This parameter is used together with P105, P106, P107 and P108 to define the characteristic of the current limiting value as a function of actual speed.	1 to 10000 [rev/min] 1rev/min	Ind: 4 FS=5000 Type: O2	P052 = 3 P051 = 40 Offline
P105 * FDS (G161)	Armature current I1 (acc. to motor rating plate) 1 st point (current value) in speed-dependent current limitation. This parameter is used together with P104, P106, P107 and P108 to define the characteristic of the current limiting value as a function of actual speed.	0.1 to 6553.0 [A] 0.1A	Ind: 4 FS=0.1 Type: O2	P052 = 3 P051 = 40 Offline
P106 * FDS (G161)	Speed n2 (acc. to motor rating plate) 2 nd point (speed value) in speed-dependent current limitation. This parameter is used together with P104, P105, P107 and P108 to define the characteristic of the current limiting value as a function of actual speed.	1 to 10000 [rev/min] 1rev/min	Ind: 4 FS=5000 Type: O2	P052 = 3 P051 = 40 Offline
P107 * FDS (G161)	Armature current I2 (acc. to motor rating plate) 2 nd point (current value) in speed-dependent current limitation. This parameter is used together with P104, P105, P106 and P108 to define the characteristic of the current limiting value as a function of actual speed.	0.1 to 6553.0 [A] 0.1A	Ind: 4 FS=0.1 Type: O2	P052 = 3 P051 = 40 Offline

PNU	Description	Value range [Unit] Steps	No. indices Factory setting Type	See Change (Access / Status)
P108 * FDS (G161)	Maximum operating speed n3 When the speed-dependent current limitation is in use, the maximum speed which is defined by the selection of the actual speed source as set in P083, <u>must</u> be entered in this parameter: When P083=1 (analog tacho): Speed at which a tacho voltage as set in P741 is reached When P083=2 (pulse encoder): Same value as maximum speed set in P143 When P083=3 (operation without tacho): Speed at which EMF as set in P115 is reached	1 to 10000 [rev/min] 1rev/min	Ind: 4 FS=5000 Type: O2	P052 = 3 P051 = 40 Offline
P109 * FDS (G161)	Control word for speed-dependent current limitation 0 Speed-dependent current limitation is deactivated 1 Speed-dependent current limitation is activated	0 to 1 1	Ind: 4 FS=0 Type: O2	P052 = 3 P051 = 40 Offline
P110 FDS (G162) (G165)	Armature circuit resistance This parameter is set automatically during the optimization run for precontrol and current controller (armature and field) (P051=25).	0.000 to 32.767 [Ω] 0.001Ω	Ind: 4 FS=0.000 Type: O2	P052 = 3 P051 = 40 Online
P111 FDS (G162) (G165)	Armature circuit inductance This parameter is set automatically during the optimization run for precontrol and current controller (armature and field) (P051=25).	0.000 to 327.67 [mH] 0.01mH	Ind: 4 FS=0.00 Type: O2	P052 = 3 P051 = 40 Online
P112 FDS (G166)	Field circuit resistance This parameter is set automatically during the optimization run for precontrol and current controller (armature and field) (P051=25).	0.0 to 3276.7 [Ω] 0.1Ω	Ind: 4 FS=0.0 Type: O2	P052 = 3 P051 = 40 Online
P113 * FDS	Continuous current factor torque control / current control This parameter defines the current to be permitted as a continuous current by the I ² t motor monitoring function without activation of alarm message A037 or fault message F037. This current is the product of calculation P113 * P100.	0.50 to 2.00 0.01	Ind: 4 FS=1.00 Type: O2	P052 = 3 P051 = 40 Offline
P114 FDS	Thermal time constant of motor (see Section 9.15) 0.0 I ² t monitoring deactivated	0.0 to 80.0 [min] 0.1min	Ind: 4 FS=10.0 Type: O2	P052 = 3 P051 = 40 Online
P115 FDS (G151)	EMF at maximum speed in operation without tachometer This parameter is used to adjust the speed in cases where the internal actual EMF value is applied as the actual speed value. P115 defines the EMF which corresponds to maximum speed as a percentage of P078.001.	1.00 to 140.00 [% of P078.001] 0.01%	Ind: 4 FS=100.00 Type: O2	P052 = 3 P051 = 40 Online
P117 * FDS	Control word for field characteristic 0 No valid field characteristic has yet been recorded 1 Valid field characteristic (P118 to P139 valid) The parameter is set automatically during the field-weakening optimization run (P051=27).	0 to 1 1	Ind: 4 FS=0 Type: O2	P052 = 3 P051 = 40 Offline
P118 FDS (G165)	Rated EMF value EMF that is reached with a full field (according to parameter P102) and a speed as set in parameter P119. The parameter is set automatically during the field-weakening optimization run (P051=27) and specifies in this case the <u>setpoint EMF</u> in the field-weakening range. Note: As regards the closed-loop field-weakening control, only the ratio between P118 and P119 is relevant. The EMF setpoint in the field-weakening range is determined by (P101 – P100 * P110). When the setting in P100, P101 or P110 is changed subsequently, the field-weakening optimization run <u>need not be repeated</u> . However, P118 then no longer defines the setpoint EMF in the field-weakening range. When the setting in parameter P102 is changed subsequently, the field-weakening optimization run <u>must be repeated</u> , the same applies if the maximum speed setting is subsequently re-adjusted.	0 to 2800 [V] 1V	Ind: 4 FS=340 Type: O2	P052 = 3 P051 = 40 Offline

PNU	Description	Value range [Unit] Steps	No. indices Factory setting Type	See Change (Access / Status)
P119 FDS (G165)	<p>Rated speed</p> <p>Speed at which an actual EMF value as set in parameter P118 is reached at full field (according to parameter P102). This parameter is set automatically during the optimization run for field weakening (P051=27) and specifies in this case the <u>field-weakening activation limit speed</u>.</p> <p>Note: As regards the closed-loop field-weakening control, only the ratio between P118 and P119 is relevant. When the setting in P100, P101 or P110 is changed subsequently, the field-weakening optimization run <u>need not be repeated</u>. However, P119 then no longer defines the field-weakening activation limit speed. When the setting in parameter P102 is changed subsequently, the field-weakening optimization run <u>must be repeated</u>, the same applies if the maximum speed setting is subsequently re-adjusted.</p>	0.0 to 199.9 [%] 0.1%	Ind: 4 FS=100.0 Type: O2	P052 = 3 P051 = 40 Offline
<p>Magnetization characteristic (field characteristic)</p> <p>Parameters P120 to P139 determine the curve shape of the <u>magnetization characteristic</u> (field characteristic) in normalized representation (see example field characteristic below for further details).</p> <p>Note: When the setting in parameter P102 is changed subsequently, the field-weakening optimization run <u>must be repeated</u>, because this alters the degree of saturation and thus the shape of the magnetization characteristic. (When parameter P100, P101 or P110, or the maximum speed adjustment, is subsequently altered, the settings in P120 to P139 remain the same, but the values in P118 and/or P119 are changed).</p>				
r120 FDS (G165) (G166)	Field current for 0% motor flux (field characteristic, point no. 0)	0.0 [% of P102] 0.1% of P102	Ind: 4 Type: O2	P052 = 3
P121 FDS (G165) (G166)	Field current for 5% motor flux (field characteristic, point no. 1)	0.0 to 100.0 [%] 0.1% of P102	Ind: 4 FS=3.7 Type: O2	P052 = 3 P051 = 40 Offline
P122 FDS (G165) (G166)	Field current for 10% motor flux (field characteristic, point no. 2)	0.0 to 100.0 [% of P102] 0.1% of P102	Ind: 4 FS=7.3 Type: O2	P052 = 3 P051 = 40 Offline
P123 FDS (G165) (G166)	Field current for 15% motor flux (field characteristic, point no. 3)	0.0 to 100.0 [% of P102] 0.1% of P102	Ind: 4 FS=11.0 Type: O2	P052 = 3 P051 = 40 Offline
P124 FDS (G165) (G166)	Field current for 20% motor flux (field characteristic, point no. 4)	0.0 to 100.0 [% of P102] 0.1% of P102	Ind: 4 FS=14.7 Type: O2	P052 = 3 P051 = 40 Offline
P125 FDS (G165) (G166)	Field current for 25% motor flux (field characteristic, point no. 5)	0.0 to 100.0 [% of P102] 0.1% of P102	Ind: 4 FS=18.4 Type: O2	P052 = 3 P051 = 40 Offline
P126 FDS (G165) (G166)	Field current for 30% motor flux (field characteristic, point no. 6)	0.0 to 100.0 [% of P102] 0.1% of P102	Ind: 4 FS=22.0 Type: O2	P052 = 3 P051 = 40 Offline
P127 FDS (G165) (G166)	Field current for 35% motor flux (field characteristic, point no. 7)	0.0 to 100.0 [% of P102] 0.1% of P102	Ind: 4 FS=25.7 Type: O2	P052 = 3 P051 = 40 Offline
P128 FDS (G165) (G166)	Field current for 40% motor flux (field characteristic, point no. 8)	0.0 to 100.0 [% of P102] 0.1% of P102	Ind: 4 FS=29.4 Type: O2	P052 = 3 P051 = 40 Offline
P129 FDS (G165) (G166)	Field current for 45% motor flux (field characteristic, point no. 9)	0.0 to 100.0 [% of P102] 0.1% of P102	Ind: 4 FS=33.1 Type: O2	P052 = 3 P051 = 40 Offline
P130 FDS (G165) (G166)	Field current for 50% motor flux (field characteristic, point no. 10)	0.0 to 100.0 [% of P102] 0.1% of P102	Ind: 4 FS=36.8 Type: O2	P052 = 3 P051 = 40 Offline

PNU	Description	Value range [Unit] Steps	No. indices Factory setting Type	See Change (Access / Status)
P131 FDS (G165) (G166)	Field current for 55% motor flux (field characteristic, point no. 11)	0.0 to 100.0 [% of P102] 0.1% of P102	Ind: 4 FS=40.6 Type: O2	P052 = 3 P051 = 40 Offline
P132 FDS (G165) (G166)	Field current for 60% motor flux (field characteristic, point no. 12)	0.0 to 100.0 [% of P102] 0.1% of P102	Ind: 4 FS=44.6 Type: O2	P052 = 3 P051 = 40 Offline
P133 FDS (G165) (G166)	Field current for 65% motor flux (field characteristic, point no. 13)	0.0 to 100.0 [% of P102] 0.1% of P102	Ind: 4 FS=48.9 Type: O2	P052 = 3 P051 = 40 Offline
P134 FDS (G165) (G166)	Field current for 70% motor flux (field characteristic, point no. 14)	0.0 to 100.0 [% of P102] 0.1% of P102	Ind: 4 FS=53.6 Type: O2	P052 = 3 P051 = 40 Offline
P135 FDS (G165) (G166)	Field current for 75% motor flux (field characteristic, point no. 15)	0.0 to 100.0 [% of P102] 0.1% of P102	Ind: 4 FS=58.9 Type: O2	P052 = 3 P051 = 40 Offline
P136 FDS (G165) (G166)	Field current for 80% motor flux (field characteristic, point no. 16)	0.0 to 100.0 [% of P102] 0.1% of P102	Ind: 4 FS=64.9 Type: O2	P052 = 3 P051 = 40 Offline
P137 FDS (G165) (G166)	Field current for 85% motor flux (field characteristic, point no. 17)	0.0 to 100.0 [% of P102] 0.1% of P102	Ind: 4 FS=71.8 Type: O2	P052 = 3 P051 = 40 Offline
P138 FDS (G165) (G166)	Field current for 90% motor flux (field characteristic, point no. 18)	0.0 to 100.0 [% of P102] 0.1% of P102	Ind: 4 FS=79.8 Type: O2	P052 = 3 P051 = 40 Offline
P139 FDS (G165) (G166)	Field current for 95% motor flux (field characteristic, point no. 19)	0.0 to 100.0 [% of P102] 0.1% of P102	Ind: 4 FS=89.1 Type: O2	P052 = 3 P051 = 40 Offline

PNU	Description	Value range [Unit] Steps	No. indices Factory setting Type	See Change (Access / Status)
-----	-------------	--------------------------------	---	---------------------------------------

Example of a field characteristic

The example characteristic exhibits a sharper curvature (i.e. a lower degree of saturation) than the field characteristic produced by the factory setting.

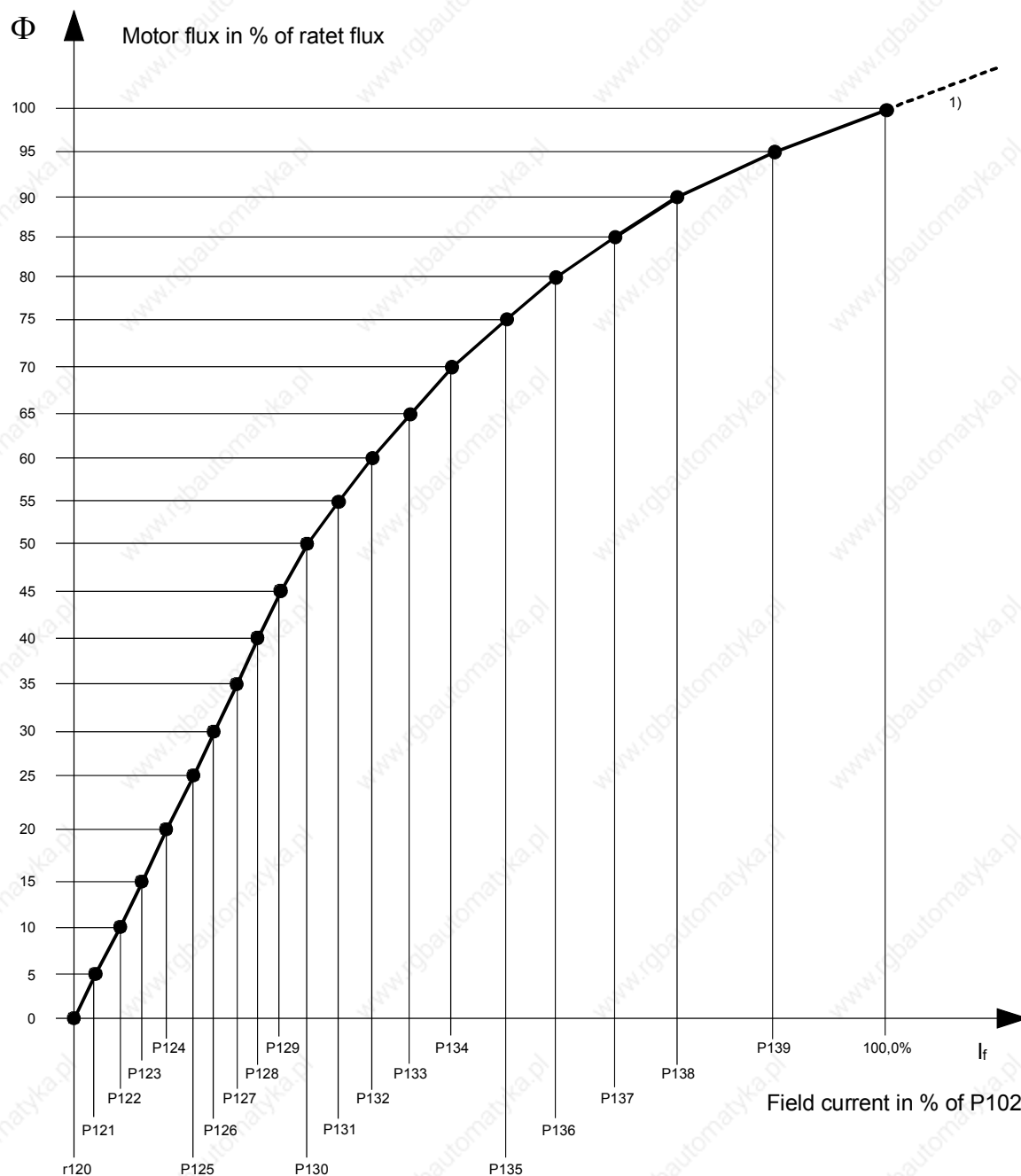

1) For actual field currents I_f of > 100% of P102, the characteristic is extended linearly for internal calculation of the motor flux.

PNU	Description	Value range [Unit] Steps	No. indices Factory setting Type	See Change (Access / Status)
-----	-------------	--------------------------------	---	---------------------------------------

10.7 Definition of pulse encoder, speed sensing using pulse encoder

The following types of pulse encoder can be used (type selection in P140):

1. Pulse encoder type 1

Encoder with two pulse tracks mutually displaced by 90° (with/without zero marker)

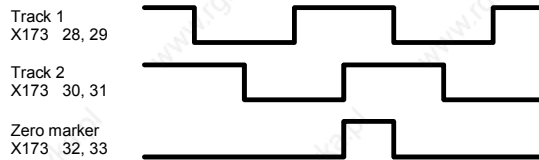

2. Pulse encoder type 1a

Encoder with two pulse tracks mutually displaced by 90° (with/without zero marker). The zero marker is converted internally to a signal in the same way as on encoder type 1.

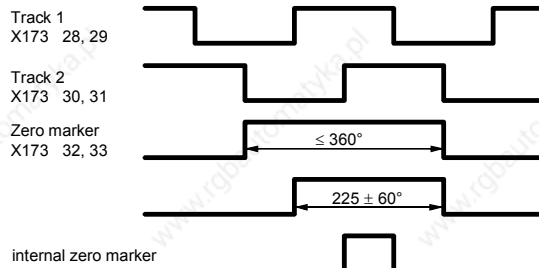

3. Pulse encoder type 2

Encoder with one pulse track per direction of rotation (with/without zero marker).

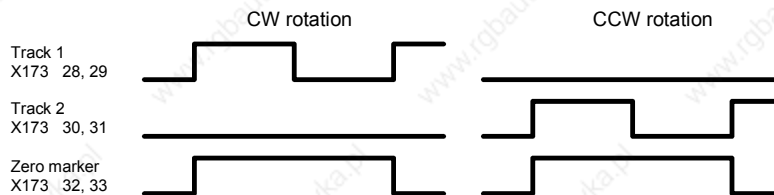

4. Pulse encoder type 3

Encoder with one pulse track and one output for direction of rotation (with/without zero marker).

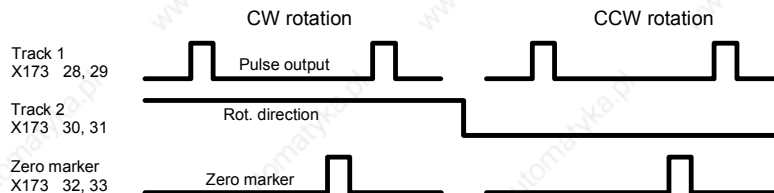

PNU	Description	Value range [Unit] Steps	No. indices Factory setting Type	See Change (Access / Status)
-----	-------------	--------------------------------	---	---------------------------------------

Notes on selecting a pulse encoder (number of pulses):

The lowest speed which can be measured by a pulse encoder is calculated with the following equation:

$$n_{min}[\text{rev} / \text{min}] = 21973 \cdot \frac{1}{X \cdot P141}$$

Formula applies with a nominal measuring time of 1 ms when P146=0 and P147=0

The following applies:

- X = 1 for 1x evaluation of pulse encoder signals (P144=0)
- 2 for 2x evaluation of pulse encoder signals (P144=1)
- 4 for 4x evaluation of pulse encoder signals (P144=2)
- see also "Single/multiple evaluation of encoder pulses"

Lower speeds are interpreted as n=0.

The frequency of the pulse encoder signals at terminals 28 and 29 or 30 and 31 must not be higher than 300 kHz.

The highest speed which can be measured by a pulse encoder is calculated with the following equation:

$$n_{max}[\text{rev} / \text{min}] = \frac{18000000}{P141}$$

When selecting a pulse encoder, therefore, it is important to ensure that the lowest possible speed $\neq 0$ is significantly higher than n_{min} and the highest possible speed does not exceed n_{max} .

$$IM >> \frac{21973}{X \cdot n_{min}[\text{rev} / \text{min}]}$$

Equations for selection of pulses per revolution IM of pulse encoder

$$IM \leq \frac{18000000}{n_{max}[\text{rev} / \text{min}]}$$

Single/multiple evaluation of encoder pulses:

The setting for single/multiple evaluation of encoder pulses is applicable for both the speed and position sensing functions.

- 1x evaluation: Only the rising edges of one pulse track are evaluated (applies to all encoder types).
- 2x evaluation: The rising and falling edges of one pulse track are evaluated (can be set for encoder types 1, 1a and 2).
- 4x evaluation: The rising and falling edges of both pulse tracks are evaluated (can be set for encoder types 1 and 1a)

See parameters P450 and P451 for position sensing function

P140 (G145)	Selection of pulse encoder type See beginning of this Section (11.8) for pulse encoder types 0 No encoder/"Speed sensing with pulse encoder" function not selected 1 Pulse encoder type 1 2 Pulse encoder type 1a 3 Pulse encoder type 2 4 Pulse encoder type 3	0 to 4 1	Ind: None FS=0 Type: O2	P052 = 3 P051 = 40 Offline
P141 (G145)	Number of pulses of pulse encoder	1 to 32767 [pulses/rev] 1 pulse/rev	Ind: None FS=500 Type: O2	P052 = 3 P051 = 40 Offline
P142 (G145)	Matching to pulse encoder signal voltage 0 Pulse encoder outputs 5 V signals 1 Pulse encoder outputs 15V signals Matching of internal operating points to signal voltage of incoming pulse encoder signals. CAUTION Resetting parameter P142 to the alternative setting <u>does not</u> switch over the supply voltage for the pulse encoder (terminals X173.26 and 27). Terminal X173.26 always supplies +15V. An external voltage supply is must be provided for pulse encoders requiring a 5V supply.	0 to 1 1	Ind: None FS=1 Type: O2	P052 = 3 P051 = 40 Offline

PNU	Description	Value range [Unit] Steps	No. indices Factory setting Type	See Change (Access / Status)
P143 FDS (G145)	Setting the maximum speed for pulse encoder operation The speed set in this parameter corresponds to an actual speed (K0040) of 100%.	1.0 to 6500.0 [rev/min] 0.1rev/min	Ind: 4 FS=500.0 Type: O4	P052 = 3 P051 = 40 Online

Control parameters for speed sensing with pulse encoder P144 to P147:

P144 and P147 determine the basic setting for actual speed sensing by means of pulse encoder (single or multiple evaluation of pulse encoder signals and nominal measuring time) and thus also define the lowest possible measurable speed (minimum speed).

P145 and P146 can be used in special cases to extend the measurable speed range down to even lower speeds, on the basis of the minimum speed defined by the settings in P144 and P147.

P144 * FDS (G145)	Multiple evaluation of encoder signals 0 <u>1x</u> evaluation of pulse encoder signals 1 <u>2x</u> evaluation of pulse encoder signals (for encoder types 1, 1a, 2) 2 <u>4x</u> evaluation of pulse encoder signals (for encoder types 1, 1a) Note: In contrast to the 1x evaluation method, 2x or 4x evaluation reduces the minimum measurable speed by a factor of 2 or 4 respectively, but may produce an "unsteady" actual speed value on encoders with unequal pulse/pause ratio or without an exact 90° displacement between encoder signals.	0 to 2 1	Ind: 4 FS=2 Type: O2	P052 = 3 P051 = 40 Offline
P145 * FDS (G145)	Automatic measuring range switchover for measurement of low speeds - switchover of multiple evaluation 0 <u>Automatic switchover of multiple evaluation</u> of pulse encoder signals OFF (i.e. P144 is always active) 1 <u>Automatic switchover of multiple evaluation</u> of pulse encoder signals ON (i.e. when P144 = 0, 2x evaluation is selected for low speeds and 4x evaluation for very low speeds. When P144 = 1, 4x evaluation is selected for low speeds) As opposed to P145 = 0, this setting reduces the minimum measurable speed by up to a factor of 4. Caution: Switching over the multiple evaluation method for encoder pulses also affects the <u>position sensing function</u> in the measuring channel. For this reason, this setting may not be used in conjunction with positioning operations. Connectors K0042 to K0044 are inoperative when P145 = 1.	0 to 1 1	Ind: 4 FS=0 Type: O2	P052 = 3 P051 = 40 Offline
P146 * FDS (G145)	Automatic measuring range switchover for measurement of low speeds - switchover of measuring time 0 Automatic switchover of measuring time OFF (i.e. P147 is always active) 1 Automatic switchover of measuring time ON This setting extends the measuring time for low speeds (based on the measuring time set in P147, i.e. when P147 = 0, the nominal measuring time is switched over to 2 ms for low speeds and to 4 ms for very low speeds. When P147 = 1, the nominal measuring time is switched over to 4 ms for low speeds) Caution: When P146=1, the minimum measurable speed can be reduced by up to a factor of 4 as opposed to a 0 setting. However, this setting results in a longer <u>actual speed sensing delay</u> in the extended minimum speed range.	0 to 1 1	Ind: 4 FS=0 Type: O2	P052 = 3 P051 = 40 Offline

PNU	Description	Value range [Unit] Steps	No. indices Factory setting Type	See Change (Access / Status)
P147 * FDS (G145)	<p>Nominal measuring time of pulse encoder signal evaluation</p> <p>0 Nominal measuring time 1 ms, gating-pulse-synchronized measurement</p> <p>1 Nominal measuring time 2 ms, gating-pulse-synchronized measurement (produces "steadier" actual speed value than setting 0)</p> <p>2 Nominal measuring time 4 ms, gating-pulse-synchronized measurement (for drives with high moment of inertia, produces "steadier" actual speed value than setting 0)</p> <p>12 Nominal measuring time 0.2 ms, asynchronous measurement</p> <p>13 Nominal measuring time 0.3 ms, asynchronous measurement</p> <p>... ..</p> <p>20 Nominal measuring time 1 ms, asynchronous measurement</p> <p><u>Note:</u> 12 to 20 Nominal measuring time 0.2 ms to 1 ms, asynchronous measurement for highly dynamic drives, reduces dead time in the actual speed value channel, but "less steady" actual speed value than achieved with setting 0 to 2 [can be set only in SW 1.9 and later]</p> <p><u>Notice:</u> When P147=1 or 2 the minimum measurable speed can be reduced by a factor of 2 or 4 respectively as opposed to 0 or 12 to 20. However, these settings increase the <u>actual speed sensing delay</u>. For this reason, P200 should be parameterized to at least 5ms <u>before</u> the optimization run for the speed controller is executed.</p>	0 to 20 1	Ind: 4 FS=0 Type: O2	P052 = 3 P051 = 40 Offline
P148 * FDS (G145)	<p>Pulse encoder monitoring function</p> <p>0 Pulse encoder monitoring OFF (activation of F048 in response to a defective pulse encoder is disabled)</p> <p>1 Pulse encoder monitoring ON (hardware monitoring of pulse encoder signals for implausible behaviour (i.e. frequent speed changes, distance between edges too short, encoder cable defect or short between two encoder cables) may cause activation of F048)</p>	0 to 1 1	Ind: 4 FS=1 Type: O2	P052 = 3 P051 = 40 Offline

10.8 Closed-loop armature current control, auto-reversing stage, armature gating unit

P150 FDS (G163)	<p>Alpha G limit (armature)</p> <p>Rectifier stability limit for firing angle of armature converter.</p>	0 to 165 [degrees] 1 degrees	Ind: 4 FS=5 / 30 (for 1Q / 4Q converters) Type: O2	P052 = 3 P051 = 40 Online
P151 FDS (G163)	<p>Alpha W limit (armature)</p> <p>Inverter stability limit for firing angle of armature converter.</p> <p>See also parameter P192 (Control word for Alpha W limit)</p>	120 to 165 [degrees] 1 degrees	Ind: 4 FS=150 Type: O2	P052 = 3 P051 = 40 Online
P152 * FDS (G163)	<p>Line frequency correction (armature)</p> <p>The internal line synchronization for the armature gating pulses derived from the power terminals (armature mains infeed) is averaged over the number of line periods set in this parameter. In operation on "weak" power supplies with unstable frequencies, for example, on a diesel-driven generator (isolated operation), this parameter must be set lower than for operation on "constant V/Hz" systems in order to achieve a higher frequency correction speed.</p>	1 to 20	Ind: 4 FS=20 Type: O2	P052 = 3 P051 = 40 Online
P153 * FDS (G162)	<p>Control word for the armature precontrol</p> <p>0 Armature precontrol disabled, output of the precontrol=165°</p> <p>1 Armature precontrol active</p> <p>2 Armature precontrol active but EMF influence only active on change in torque direction</p> <p>3 Armature precontrol active but without EMF influence., i.e. for precontrol, the EMF is assumed to be 0. (recommended setting for supplying large inductance from armature terminals, e.g. solenoids, field supply) [can only be set on SW 1.7 and later]</p>	0 to 3 1	Ind: 4 FS=1 Type: O2	P052 = 3 P051 = 40 off-line

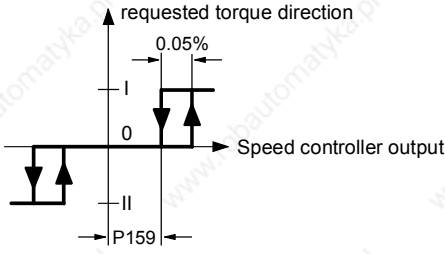
PNU	Description	Value range [Unit] Steps	No. indices Factory setting Type	See Change (Access / Status)
P154 * FDS (G162)	Set armature current controller I component to zero 0 Set controller I component to zero (i.e. to obtain pure P controller) 1 Controller I component is active	0 to 1 1	Ind: 4 FS=1 Type: O2	P052 = 3 P051 = 40 Offline
P155 FDS (G162)	Armature current controller P gain Proportional gain of armature current controller This parameter is automatically set during the optimization run for precontrol and current controller (armature and field) (P051=25). See also parameter P175	0.01 to 200.00 0.01	Ind: 4 FS=0.10 Type: O2	P052 = 3 P051 = 40 Online
P156 FDS (G162)	Armature current controller reset time This parameter is automatically set during the optimization run for precontrol and current controller (armature and field) (P051=25). See also parameter P176	0.001 to 10.000 [s] 0.001s	Ind: 4 FS=0,200 Type: O2	P052 = 3 P051 = 40 Online
P157 * FDS (G162)	Control word for current setpoint integrator 0 Reduced gearbox stressing The integrator is active only after a change in torque direction (acts as ramp-function generator for armature current setpoint only until the output reaches the setpoint at the integrator input for the 1 st time after a change in torque direction). 1 Current setpoint integrator The integrator is always active (acts as ramp-function generator for the armature current setpoint)	0 to 1 1	Ind: 4 FS=0 Type: O2	P052 = 3 P051 = 40 Offline
P158 FDS (G162)	Ramp-up time for current setpoint integrator (reduced gearbox stressing) Period of an acceleration ramp with a setpoint step change from 0% to 100% at r072.002. For older DC machines (i.e. unsuitable for steep rates of current rise), P157=1 and P158=0.040 must be set.	0.000 to 1.000 [s] 0.001s	Ind: 4 FS=0.000 Type: O2	P052 = 3 P051 = 40 Online
P159 FDS (G163)	Switchover threshold for auto-reversing stage (armature) 	0.00 to 100.00 [%] 0.01% of n controller output	Ind: 4 FS=0.01 Type: O2	P052 = 3 P051 = 40 Online
P160 FDS (G163)	Additional torque-free interval Additional torque-free interval for torque direction change in 4Q operation. It is particularly important to set this parameter to values of > 0 for converter armatures which supply large inductances (e.g. lifting solenoids).	0.000 to 2.000 [s] 0.001s	Ind: 4 FS=0.000 Type: O2	P052 = 3 P051 = 40 Online
P161 FDS (G163)	Additional Alpha W pulses with disabled second pulses Number of additional Alpha W pulses with disabled second pulses after detection of I=0 message prior to a change in torque direction. It is particularly important to set this parameter to values of > 0 for converter armatures which supply large inductances (e.g. lifting solenoids). These pulses cause the current to decay prior to a change in torque direction. When it drops below the thyristor holding current value, the current is suddenly chopped by the unfired second thyristor and the residual energy stored in the load inductor must be dissipated via a suppressor circuit (e.g. a varistor) to prevent the load inductor from producing a surge voltage. See also P179.	0 to 100 1	Ind: 4 FS=0 Type: O2	P052 = 3 P051 = 40 Online
P162 * FDS (G162)	EMF calculation method for armature precontrol 0 The EMF derived from the <u>measured</u> armature voltage is applied 1 The EMF derived from the <u>calculated</u> armature voltage is applied (the purpose of this setting is to prevent the occurrence of any low-frequency (< 15 Hz) armature current fluctuations)	0 to 1 1	Ind: 4 FS=1 Type: O2	P052 = 3 P051 = 40 Offline

PNU	Description	Value range [Unit] Steps	No. indices Factory setting Type	See Change (Access / Status)
P163 * FDS (G162)	EMF filtering method for armature precontrol 0 No filtering 1 Filtering element, filter time constant = approx. 10 ms (for use by works engineers only) 2 Averaging over the last 2 EMF values (for use by works engineers only) 3 Averaging over the last 3 EMF values	0 to 3 1	Ind: 4 FS=3 Type: O2	P052 = 3 P051 = 40 Offline
P164 * FDS (G162)	Set armature current controller P component to zero 0 Set controller P component to zero (i.e. to obtain pure I controller) 1 Controller P component is active	0 to 1 1	Ind: 4 FS=1 Type: O2	P052 = 3 P051 = 40 Offline
P165 * BDS (G163)	Select the binector to control the "Enable a torque direction for torque direction change" function 0 = Binector B0000 1 = Binector B0001 etc. Binector status = 0 ... Enable for M0 or MII 1 ... Enable for M0 or MI	All binector numbers 1	Ind: 2 FS=220 Type: L2	P052 = 3 P051 = 40 Offline

10.9 Current limitation, torque limitation

P169 * FDS (G160)	Select closed-loop torque / current control See parameter P170	0 to 1 1	Ind: 4 FS=1 Type: O2	P052 = 3 P051 = 40 Offline
P170 * FDS (G160)	Select closed-loop torque / current control <u>P169</u> <u>P170</u> 0 0 Closed-loop current control and current limitation 0 1 Closed-loop torque control with torque limitation (the torque setpoint is converted to a current setpoint: Current setpoint = torque setpoint / motor flux) Current limitation is active additionally 1 0 Closed-loop current control with torque limitation (the specified torque limit is converted to a current limit: Current limit = torque limit / motor flux) Current limitation is active additionally 1 1 Do not set! Note: A valid field characteristic (P117=1) must be available when P169 or P170=1. If one is not, the optimization run for field weakening (P051=27) must be executed. P263 determines the input quantity for the motor flux calculation.	0 to 1 1	Ind: 4 FS=0 Type: O2	P052 = 3 P051 = 40 Offline
P171 FDS (G160) (G161)	System current limit in torque direction I	0.0 to 300.0 [% of P100] 0.1% of P100	Ind: 4 FS=100.0 Type: O2	P052 = 3 P051 = 40 Online
P172 FDS (G160) (G161)	System current limit in torque direction II	-300.0 to 0.0 [% of P100] 0.1% of P100	Ind: 4 FS=-100.0 Type: I2	P052 = 3 P051 = 40 Online
P173 * BDS (G160)	Source for "Torque control / Current control" switchover [SW 1.9 and later] The binector selected here has the same effect as parameter P170. 0 = binector B0000 1 = binector B0001 etc.	All binector numbers 1	Ind: 2 FS=0 Type: L2	P052 = 3 P051 = 40 Offline
P175 * FDS (G162)	Source for variable P gain [SW 1.8 and later] The content of the selected connector acts as the P gain for the armature current controller after multiplication with P155.	All connector numbers 1	Ind: 4 FS=1 Type: L2	P052 = 3 P051 = 40 off-line

PNU	Description	Value range [Unit] Steps	No. indices Factory setting Type	See Change (Access / Status)
P176 * FDS (G162)	Source for variable Integration time [SW 1.8 and later] The content of the selected connector acts as the integration time for the armature current controller after multiplication with P156.	All connector numbers 1	Ind: 4 FS=1 Type: L2	P052 = 3 P051 = 40 off-line
P177 * BDS (G163)	Source for the command "no immediate pulse disable" [SW 1.8 and later] A low signal causes the armature firing pulses to be disabled immediately without waiting for the I=0 signal or without outputting alpha-W pulses for current reduction. The additional alpha-W pulses (acc. to parameter P161) are not output either. As long as this command is pending, it is not possible to fall below operating state o1.6. This command can be used, for example, if it is not a motor that is supplied by the SIMOREG DC Master but a field and the current is to be reduced via an external parallel-connected de-excitation resistance.	All binector numbers 1	Ind: 2 FS=1 Type: L2	P052 = 3 P051 = 40 off-line
P178 * BDS (G163)	Source for the command "fire all thyristors simultaneously" [SW 1.8 and later] Setting this command (high signal) causes all six thyristors of the thyristor bridge I to be fired continuously and simultaneously. Switchover to long pulses is automatic. This command is only active if no line voltage is applied to the armature power section .	All binector numbers 1	Ind: 2 FS=0 Type: L2	P052 = 3 P051 = 40 off-line
P179 FDS (G163)	Additional Alpha W pulses with disabled second pulses [SW 1.9 and later] Number of additional Alpha W pulses with disabled second pulses after detection of I=0 message prior to a change in torque direction. It is particularly important to set this parameter to values of > 0 for converter armatures which supply large inductances (e.g. lifting solenoids). These pulses cause the current to decay before a change in torque direction; the thyristors are fired in pairs to prevent sudden chopping, and the generation of a surge voltage by the load inductor, and the current drops below the thyristor holding current. When a change in torque direction is required, the current in the existing direction must be reduced. This is achieved in the following ways: If P179 > 0: 1) Alpha W pulses with <u>enabled</u> second pulses until the I=0 signal arrives 2) Additional Alpha W pulses with <u>enabled</u> second pulses (number as set in P179.F) 3) Additional Alpha W pulses with <u>disabled</u> second pulses (number as set in P161.F) 4) Additional torque-free interval (period as set in P160.F) If P179 = 0: 1) Alpha W pulses with <u>disabled</u> second pulses until the I=0 signal arrives 2) Additional Alpha W pulses with <u>disabled</u> second pulses (number as set in P161.F) 3) Additional torque-free interval (period as set in P160.F)	0 to 100 1	Ind: 4 FS=0 Type: O2	P052 = 3 P051 = 40 on-line
P180 FDS (G160)	Positive torque limit 1	-300.00 to 300.00 [%] 0.01% of rated motor torque	Ind: 4 FS=300.00 Type: I2	P052 = 3 P051 = 40 Online
P181 FDS (G160)	Negative torque limit 1	-300.00 to 300.00 [%] 0.01% of rated motor torque	Ind: 4 FS=-300.00 Type: I2	P052 = 3 P051 = 40 Online
P182 FDS (G160)	Positive torque limit 2 If "Torque limit switchover" is selected (state of binector selected in P694 =1) and the speed is higher than the threshold speed set in parameter P184, then torque limit 2 is activated in place of torque limit 1.	-300.00 to 300.00 [%] 0.01% of rated motor torque	Ind: 4 FS=300.00 Type: I2	P052 = 3 P051 = 40 Online
P183 FDS (G160)	Negative torque limit 2 If "Torque limit switchover" is selected (state of binector selected in P694 =1) and the speed is higher than the threshold speed set in parameter P184, then torque limit 2 is activated in place of torque limit 1.	-300.00 to 300.00 [%] 0.01% of rated motor torque	Ind: 4 FS=-300.00 Type: I2	P052 = 3 P051 = 40 Online

PNU	Description	Value range [Unit] Steps	No. indices Factory setting Type	See Change (Access / Status)
P184 FDS (G160)	Threshold speed for torque limits If "Torque limit switchover" is selected (state of binector selected in P694 =1) and the speed (K0166) is higher than the threshold speed set in parameter P184, then torque limit 2 (P182, P183) is activated in place of torque limit 1 (P180, P181).	0.00 to 120.00 [%] 0.01% of maximum speed	Ind: 4 FS=0.00 Type: O2	P052 = 3 P051 = 40 Online
P190 FDS (G162)	Filter time for setpoint for armature current precontrol [SW 1.9 and later] Filtering of the armature current setpoint at the input of the precontrol for the armature current controller. The purpose of this filter is to decouple the armature current precontrol from the armature current controller.	0 to 10000 [ms] 1ms	Ind: 4 FS=0 Type: O2	P052 = 3 P051 = 40 on-line
P191 FDS (G162)	Filter time for setpoint for armature current controller [SW 1.9 and later] Filtering of the armature current setpoint at the input of the armature current controller. The purpose of this filter is to decouple the armature current precontrol from the armature current controller.	0 to 10000 [ms] 1ms	Ind: 4 FS=0 Type: O2	P052 = 3 P051 = 40 on-line

10.10 Auto-reversing stage, armature gating unit

P192 * FDS (G163)	Control word for the Alpha W limit (armature) [as of SW 2.1] 0 <u>Continuous current:</u> Inverter stability limit for the delay angle of the armature converter (Alpha W) = value according to parameter P151 <u>Intermittent current:</u> Alpha W = 165° 1 Inverter stability limit for the delay angle of the armature converter (Alpha W) = value according to parameter P151	0 to 1 1	Ind: 4 FS=0 Type: O2	P052 = 3 P051 = 40 Online
----------------------------	---	-------------	----------------------------	---------------------------------

10.11 Speed controller

further parameters for the speed controller P550 - P567

Setting values for speed controller - actual value/setpoint processing				
P200 FDS (G152)	Filter time for actual speed controller value Filtering of the actual speed value by means of a PT1 element. This filter setting is taken into account by the speed controller optimization run (P051=26).	0 to 10000 [ms] 1ms	Ind: 4 FS=0 Type: O2	P052 = 3 P051 = 40 Online
P201 FDS (G152)	Band-stop 1: Resonant frequency	1 to 140 [Hz] 1Hz	Ind: 4 FS=1 Type: O2	P052 = 3 P051 = 40 Online
P202 FDS (G152)	Band-stop 1: Quality 0 Quality = 0.5 1 Quality = 1 2 Quality = 2 3 Quality = 3	0 to 3 1	Ind: 4 FS=0 Type: O2	P052 = 3 P051 = 40 Online
P203 FDS (G152)	Band-stop 2: Resonant frequency	1 to 140 [Hz] 1Hz	Ind: 4 FS=1 Type: O2	P052 = 3 P051 = 40 Online
P204 FDS (G152)	Band-stop 2: Quality 0 Quality = 0.5 1 Quality = 1 2 Quality = 2 3 Quality = 3	0 to 3 1	Ind: 4 FS=0 Type: O2	P052 = 3 P051 = 40 Online
P205 FDS (G152)	D element: Derivative-action time	0 to 1000 [ms] 1ms	Ind: 4 FS=0 Type: O2	P052 = 3 P051 = 40 Online
P206 FDS (G152)	D element: Filter time	0 to 100 [ms] 1ms	Ind: 4 FS=0 Type: O2	P052 = 3 P051 = 40 Online
r217 (G151)	Indication of the active droop of the speed controller [SW 1.7 and later]	0.0 to 10.0 [%] 0.1%	Ind: None Type: O2	P052 = 3

PNU	Description	Value range [Unit] Steps	No. indices Factory setting Type	See Change (Access / Status)
r218 (G151) (G152)	Indication of the active integration time of the speed controller [SW 1.7 and later]	0.010 to 10.000 [s] 0.001s	Ind: None Type: O2	P052 = 3
r219 (G151) (G152)	Display of effective P gain of speed controller	0.01 to 200.00 0.01	Ind: None Type: O2	P052 = 3

P221 FDS (G152)	Speed controller: Hysteresis for speed-dependent PI/P controller switchover [SW 1.9 and later] See P222 for further details.	0.00 to 100.00 [%] 0.01% of maximum speed	Ind: 4 FS=2.00 Type: O2	P052 = 3 P051 = 40 Online
P222 FDS (G152)	Speed controller: Speed-dependent switchover threshold for PI / P controller 0.00 Automatic switchover from PI to P controller deactivated. > 0.00 Depending on the actual speed (K0166), the PI controller switches over to a P controller if the speed drops below the threshold set in parameter P222. The integrator is not switched in again (with value of 0) until the actual speed is > P222 + P221. This function allows the drive to be stopped without overshoot using a zero setpoint with the controllers enabled. This function is active only if the binector selected in P698 is in the log. "1" state.	0.00 to 10.00 [%] 0.01% of maximum speed	Ind: 4 FS=0.00 Type: O2	P052 = 3 P051 = 40 Online

Setting values for speed controller

P223 * FDS (G152)	Control word for speed controller precontrol 0 Speed controller precontrol disabled 1 Speed controller precontrol acts as torque setpoint (is added to n controller output)	0 to 1 1	Ind: 4 FS=0 Type: O2	P052 = 3 P051 = 40 Offline
P224 * FDS (G152)	Control word for speed controller I component 0 Set controller I component to 0 (i.e. to achieve a pure P controller) 1 Controller I component is active The I component is stopped when a torque or current limit is reached 2 Controller I component is active The I component is stopped when a torque limit is reached 3 Controller I component is active The I component is stopped only when $\pm 199.99\%$ is reached	0 to 3 1	Ind: 4 FS=1 Type: O2	P052 = 3 P051 = 40 Offline
P225 FDS (G151)	Speed controller P gain See also setting values for "Speed controller adaptation" function (P550 to P559). This parameter is set automatically during the speed controller optimization run (P051=26).	0.10 to 200.00 0.01	Ind: 4 FS=3.00 Type: O2	P052 = 3 P051 = 40 Online
P226 FDS (G151)	Speed controller reset time This parameter is set automatically during the speed controller optimization run (P051=26).	0.010 to 10.000 [s] 0.001s	Ind: 4 FS=0,650 Type: O2	P052 = 3 P051 = 40 Online

Speed controller droop

Function: A parameterizable feedback loop can be connected in parallel to the I and P components of the speed controller (acts on summation point of setpoint and actual value).

P227 FDS (G151)	Speed controller droop A 10% speed droop setting causes a 10% deviation in the speed from the setpoint at a 100% controller output (100% torque or armature current setpoint) ("softening" of closed-loop control). See also P562, P563, P630 and P684	0.0 to 10.0 [%] 0.1%	Ind: 4 FS=0.0 Type: O2	P052 = 3 P051 = 40 Online
-----------------------	---	----------------------------	------------------------------	---------------------------------

P228 FDS (G152)	Filter time for speed setpoint Filtering of setpoint by means of a PT1 element. This parameter is automatically set to the same value as the speed controller reset time during the speed controller optimization run (P051=26). It may be useful to parameterize lower values when the ramp-function generator is in use.	0 to 10000 [ms] 1ms	Ind: 4 FS=0 Type: O2	P052 = 3 P051 = 40 Online
-----------------------	--	---------------------------	----------------------------	---------------------------------

PNU	Description	Value range [Unit] Steps	No. indices Factory setting Type	See Change (Access / Status)
P229 * FDS (G152)	Control of I component tracking for slave drive 0 On a slave drive, the I component of the speed controller is made to follow such that $M(\text{set}, n\text{conr.}) = M(\text{set}, \text{limit})$, the speed setpoint is set to the actual speed value 1 Tracking deactivated	0 to 1 1	Ind: 4 FS=0 Type: O2	P052 = 3 P051 = 40 Offline
P230 FDS (G152)	Setting period of speed controller integrator [SW 1.9 and later] After a positive edge at the binector set in P695, the integrator of the speed controller is set to the instantaneous value of the connector set in P631. If a time of > 0 is set on P230, this setting operation is not performed just once, but the speed controller integrator is set continually to the setting value for the parameterized time period.	0 to 10000 [ms] 1ms	Ind: 4 FS=0 Type: O2	P052 = 3 P051 = 40 on-line
P234 * FDS (G152)	Set speed controller P component to zero 0 Set controller P component to zero (i.e. to obtain a pure I controller) 1 Controller P component is active	0 to 1 1	Ind: 4 FS=1 Type: O2	P052 = 3 P051 = 40 Offline
P236 * FDS	Specifying the dynamic response of the speed control loop [SW 2.0 and later] The parameter value is used as the optimization criterion for the speed control loop. Note: Changes to this value do not take effect until the speed controller optimization run (P051 = 26, see Section 7.5) has been executed. Setting instructions: - For drives, for example, with gear backlash, optimization should be started with low dynamic response values (from 10%). - For drives with top synchronism and dynamic response requirements, values up to 100% should be used.	10 to 100 [%] 1	Ind: 4 FS=75 Type: O2	P052 = 3 P051 = 40 online

10.12 Closed-loop field current control, field gating unit

P250 FDS (G166)	Alpha G limit (field) Rectifier stability limit for firing angle of field converter	0 to 180 [degrees] 1 degree	Ind: 4 FS=0 Type: O2	P052 = 3 P051 = 40 Online
P251 FDS (G166)	Alpha W limit (field) Inverter stability limit for firing angle of field converter	0 to 180 [degrees] 1 degree	Ind: 4 FS=180 Type: O2	P052 = 3 P051 = 40 Online
P252 * FDS (G166)	Filtering of line frequency correction (field) The internal line synchronization for the field gating pulses derived from the field mains infeed terminals is filtered with this time constant. In operation on "weak" power supplies with unstable frequencies, for example, on a diesel-driven generator (isolated operation), the filter time constant must be set lower than for operation on "constant V/Hz" systems in order to achieve a higher frequency correction speed. Using the units position, the line synchronization function can be altered <u>additionally</u> as follows: When the parameter is set to an <u>uneven</u> number, the measured line zero crossings for line synchronization are subjected to an extra "filter", may improve performance in the case of difficulties with brief mains interruptions (e.g. power supply via sliding current collectors), but may only be set for constant V/Hz power supplies (not for weak isolated supply systems).	0 to 200 [ms] 1ms	Ind: 4 FS=200 Type: O2	P052 = 3 P051 = 40 Offline
P253 * FDS (G166)	Control word for field precontrol 0 Field precontrol disabled, precontrol output = 180° 1 Field precontrol active, output is dependent on field current setpoint, field line voltage, P112	0 to 1 1	Ind: 4 FS=1 Type: O2	P052 = 3 P051 = 40 Offline
P254 * FDS (G166)	Set field current controller I component to zero 0 Set controller I component to zero (i.e. to obtain pure P controller) 1 Controller I component is active	0 to 1 1	Ind: 4 FS=1 Type: O2	P052 = 3 P051 = 40 Offline
P255 FDS (G166)	Field current controller P gain This parameter is set automatically during the optimization run for precontrol and current controller (armature and field) (P051=25).	0.01 to 100.00 0.01	Ind: 4 FS=5.00 Type: O2	P052 = 3 P051 = 40 Online

PNU	Description	Value range [Unit] Steps	No. indices Factory setting Type	See Change (Access / Status)
P256 FDS (G166)	Field current controller reset time This parameter is set automatically during the optimization run for precontrol and current controller (armature and field) (P051=25).	0.001 to 10.000 [s] 0.001s	Ind: 4 FS=0,200 Type: O2	P052 = 3 P051 = 40 Online
P257 FDS (G166)	Standstill field Value to which the field current is reduced when "Automatic field current reduction" function is parameterized (by means of P082=2) or with signal-driven selection of "Standstill excitation" function (selected in P692).	0.0 to 100.0 [%] 0.1% of P102	Ind: 4 FS=0.0 Type: O2	P052 = 3 P051 = 40 Online
P258 FDS (G166)	Delay time with automatic field current reduction Delay after which the field current is reduced to the value set in parameter P257 with automatic or signal-driven "Field current reduction" function when the drive is stopped after operating state o7.0 or higher is reached.	0.0 to 60.0 [s] 0.1s	Ind: 4 FS=10.0 Type: O2	P052 = 3 P051 = 40 Online
P260 FDS (G166)	Filter time for setpoint for field current precontrol [SW 1.9 and later] Filtering of the field current setpoint at the input of the precontrol for the field current controller. The purpose of this filter is to decouple the field current precontrol from the field current controller.	0 to 10000 [ms] 1ms	Ind: 4 FS=0 Type: O2	P052 = 3 P051 = 40 on-line
P261 FDS (G166)	Filter time for setpoint for field current controller [SW 1.9 and later] Filtering of the field current setpoint at the input of the field current controller. The purpose of this filter is to decouple the field current precontrol from the field current controller.	0 to 10000 [ms] 1ms	Ind: 4 FS=0 Type: O2	P052 = 3 P051 = 40 on-line
P263 * FDS (G166)	Input quantity for motor flux calculation 0 The input quantity for the motor flux calculation is the <u>field current controller actual value according to P612 (K0265)</u> , to be used in connection with a fully compensated DC machine 1 The input quantity for the motor flux calculation is the <u>precontrol output for the EMF controller (K0293)</u> (exception: Field current controller setpoint (K0268) with active standstill field or with disabled field pulses), to be used in connection with a non-compensated DC machine. The EMF controller <u>must</u> be active when this setting is selected (EMF controller compensates the armature reaction). 2 The input quantity for the motor flux calculation is the field current controller setpoint (K0268). Advantage: Quantities derived from the setpoint are generally "steadier" than those derived from actual values.	0 to 2 1	Ind: 4 FS=1 Type: O2	P052 = 3 P051 = 40 Offline
P264 * FDS (G166)	Set field current controller P component to zero 0 Set controller P component to zero (i.e. to obtain pure I controller) 1 Controller P component is active	0 to 1 1	Ind: 4 FS=1 Type: O2	P052 = 3 P051 = 40 Offline
P265 * BDS (G167)	Source for selection of external field current monitoring signal [SW 1.9 and later] Selection of the binector to supply the field monitoring signal when an external field device is used. (status "1" = field current is o.k., If > If-min) The converter waits for this signal in state o5.0 as part of the power ON routine. If the signal disappears during operation, the drive is shut down with fault message F005, fault value 4. 0 = binector B0000 1 = binector B0001 etc.	All binector numbers 1	Ind: 2 FS=1 Type: L2	P052 = 3 P051 = 40 off-line

PNU	Description	Value range [Unit] Steps	No. indices Factory setting Type	See Change (Access / Status)
-----	-------------	--------------------------------	---	---------------------------------------

10.13 Closed-loop EMF control

P272 * (G165)	Operating mode of closed-loop EMF control 0 Fault message F043 ("EMF too high for braking operation") is active: If the EMF is too high when a <u>torque direction change is requested</u> (i.e. if the calculated firing angle (K0101) for the armature current in the new torque direction is > 165 degrees), both torque directions are disabled. If, at the same time, the absolute value of the armature current required in the new torque direction is > 0.5% of rated converter DC current (P072), fault message F043 is activated (see Section 10 for possible fault causes). 1 Alarm A043 and automatic field reduction if EMF is too high in braking operation. If the EMF is too high <u>in braking operation</u> (i.e. if the following applies to the armature firing angle α before limitation (K0101): $\alpha > (\alpha_W - 5 \text{ degrees})$), alarm A043 is activated (α_W is the inverter stability limit according to P151 or 165 degrees with a discontinuous armature current). The field is reduced with activation of A043. This field reduction is achieved by regulating the armature firing angle to $(\alpha_W - 5 \text{ degrees})$ by means of a P controller, whose output reduces the EMF controller setpoint. "Field weakening operation by internal closed-loop EMF control" (P081=1) must therefore be parameterized so that the field reduction can take effect. When a <u>torque direction change is requested</u> , both torque directions remain disabled until the field, and thus the EMF, have been reduced accordingly (i.e. until the calculated firing angle (K0101) for the armature current required in the new torque direction is <165 degrees).	0 to 1 1	Ind: None FS=0 Type: O2	P052 = 3 P051 = 40 Offline
P273 * FDS (G165)	Control word for EMF controller precontrol 0 EMF controller precontrol disabled, precontrol output = rated motor field current (P102) 1 EMF controller precontrol is active	0 to 1 1	Ind: 4 FS=1 Type: O2	P052 = 3 P051 = 40 Offline
P274 * FDS (G165)	Set EMF controller I component to zero 0 Set controller I component to zero (i.e. to obtain pure P controller) 1 Controller I component is active	0 to 1 1	Ind: 4 FS=1 Type: O2	P052 = 3 P051 = 40 Offline
P275 * FDS (G165)	EMF controller P gain This parameter is automatically set during the field weakening optimization run (P051=27).	0.10 to 100.00 0.01	Ind: 4 FS=0.60 Type: O2	P052 = 3 P051 = 40 Online
P276 * FDS (G165)	EMF controller reset time This parameter is automatically set during the field weakening optimization run (P051=27).	0.010 to 10.000 [s] 0.001s	Ind: 4 FS=0.200 Type: O2	P052 = 3 P051 = 40 Online
P277 * FDS (G165)	EMF controller droop	0.0 to 10.0 [%] 0.1%	Ind: 4 FS=0.0 Type: O2	P052 = 3 P051 = 40 Online
P280 FDS (G165)	Filter time for setpoint for EMF controller precontrol [SW 1.9 and later] Filtering of the EMF setpoint at the input of the EMF controller precontrol. The purpose of this filter is to decouple the EMF controller precontrol from the EMF controller.	0 to 10000 [ms] 1ms	Ind: 4 FS=0 Type: O2	P052 = 3 P051 = 40 on-line
P281 FDS (G165)	Filter time for setpoint for EMF controller [SW 1.9 and later] Filtering of the EMF setpoint at the input of the EMF controller. The purpose of this filter is to decouple the EMF controller precontrol from the EMF controller.	0 to 10000 [ms] 1ms	Ind: 4 FS=0 Type: O2	P052 = 3 P051 = 40 on-line
P282 FDS (G165)	Filter time for actual value for EMF controller [SW 1.9 and later] Filtering of actual EMF value at the input of the EMF controller.	0 to 10000 [ms] 1ms	Ind: 4 FS=0 Type: O2	P052 = 3 P051 = 40 on-line
P283 FDS (G165)	Filter time for actual value for EMF controller precontrol [SW 1.9 and later] Filtering of actual speed value at the input of the EMF controller precontrol. The purpose of this filter is to stabilize the EMF controller precontrol, even when the actual speed signal is unsteady or distorted by harmonics.	0 to 10000 [ms] 1ms	Ind: 4 FS=0 Type: O2	P052 = 3 P051 = 40 on-line

PNU	Description	Value range [Unit] Steps	No. indices Factory setting Type	See Change (Access / Status)
P284 * FDS (G165)	Set EMF controller P component to zero 0 Set controller P component to zero (i.e. to obtain pure I controller) 1 Controller P component is active	0 to 1 1	Ind: 4 FS=1 Type: O2	P052 = 3 P051 = 40 Offline

10.14 Ramp-function generator

(see also Section 8, Sheet G136 and Section 9 of Operating Instructions 6RX1700-0AD**)

See P639 and P640 for ramp-function generator setting parameters

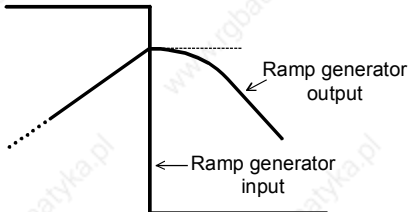
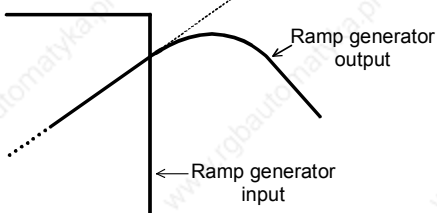
P295 FDS (G136)	<p>Mode for rounding the ramp-function generator [SW 1.9 and later]</p> <p>0 If the setpoint is reversed during ramp-up (or ramp-down), acceleration (deceleration) is aborted and initial rounding of the deceleration (acceleration) process begins immediately. The setpoint is not increased (decreased) any further, but the signal at the ramp-function generator output has a breakpoint (i.e. a step change in the acceleration rate).</p>  <p>1 If the setpoint is reversed during ramp-up or ramp-down, acceleration/deceleration gradually changes to deceleration/acceleration. The setpoint increases/decreases further, but there is <u>no breakpoint</u> in the signal at the generator output (i.e. there is no step change in the acceleration rate).</p> 	0 to 1 1	Ind: 4 FS=0 Type: O2	P052 = 3 P051 = 40 on-line
P296 FDS (G136)	<p>Ramp-down time of ramp generator with quick stop (OFF3) [SW 1.9 and later]</p> <p>When the "quick stop" command is issued, the drive must normally brake down to 0 speed along the current limit. If the mechanical design of the drive makes this option impermissible or undesirable, then a value of > 0 can be set here. In this case, the drive brakes along the deceleration ramp programmed here when the "quick stop" command is issued.</p> <p>see also parameter P330</p>	0.00 to 650.00 [s] 0.01 s	Ind: 4 FS=0.00 Type: O2	P052 = 3 P051 = 40 on-line
P297 FDS (G136)	<p>Lower transition rounding of ramp generator with quick stop (OFF3) [SW 1.9 and later]</p> <p>see also parameter P330</p>	0.00 to 100.00 [s] 0.01s	Ind: 4 FS=0.00 Type: O2	P052 = 3 P051 = 40 on-line
P298 FDS (G136)	<p>Upper transition rounding of ramp generator with quick stop (OFF3) [SW 1.9 and later]</p> <p>see also parameter P330</p>	0.00 to 100.00 [s] 0.01s	Ind: 4 FS=0.00 Type: O2	P052 = 3 P051 = 40 on-line

PNU	Description	Value range [Unit] Steps	No. indices Factory setting Type	See Change (Access / Status)
Limitation at ramp-function generator output (setpoint limiting)				
The effective limitations are: Upper limit: Minimum value of P300 and the four connectors selected with P632 Lower limit: Maximum value of P301 and the four connectors selected with P633 Note: The limiting values for both the positive and negative setpoint limits can have a positive or negative sign. The negative setpoint limit, for example, can therefore be parameterized to a positive value and the positive setpoint limit to a negative value.				
P300 FDS (G137)	Positive limitation at ramp-function generator output	-200.00 to 199.99 [%] 0.01%	Ind: 4 FS=100.00 Type: I2	P052 = 3 P051 = 40 Online
P301 FDS (G137)	Negative limitation at ramp-function generator output	-200.00 to 199.99 [%] 0.01%	Ind: 4 FS=-100.00 Type: I2	P052 = 3 P051 = 40 Online
P302 * FDS (G136)	Select ramp-function generator / ramp-up integrator mode 0 <u>Normal ramp-function generator operation:</u> Ramp-function generator setting 1 (P303 to P306) is applied. When a binary selectable input parameterized as "Ramp-function generator setting 2" (P307 to P310)" (selected in P637) or "Ramp-function generator setting 3" (P311 to P314)" (selected in P638), generator setting 2 or 3 is applied as appropriate. 1 <u>Ramp-up integrator operation:</u> When the setpoint is reached for the first time, ramp-function generator setting 1 is switched over to a ramp-up/down times = 0 2 <u>Ramp-up integrator operation:</u> When the setpoint is reached for the first time, ramp-function generator setting 1 is switched over to generator setting 2 (P307 to P310) 3 <u>Ramp-up integrator operation:</u> When the setpoint is reached for the first time, ramp-function generator setting 1 is switched over to generator setting 3 (P311 to P314)	0 to 3 1	Ind: 4 FS=0 Type: O2	P052 = 3 P051 = 40 Offline

Ramp-function generator parameter set 1 (see also parameter P330)				
P303 FDS (G136)	Ramp-up time 1	0.00 to 650.00 [s] 0.01s	Ind: 4 FS=10.00 Type: O2	P052 = 3 P051 = 40 Online
P304 FDS (G136)	Ramp-down time 1	0.00 to 650.00 [s] 0.01s	Ind: 4 FS=10.00 Type: O2	P052 = 3 P051 = 40 Online
P305 FDS (G136)	Lower transition rounding 1	0.00 to 100.00 [s] 0.01s	Ind: 4 FS=0.00 Type: O2	P052 = 3 P051 = 40 Online
P306 FDS (G136)	Upper transition rounding 1	0.00 to 100.00 [s] 0.01s	Ind: 4 FS=0.00 Type: O2	P052 = 3 P051 = 40 Online

Ramp-function generator parameter set 2 (see also parameter P330)				
Ramp-function generator parameter set 2 is selected via the binector parameterized in P637.				
P307 FDS (G136)	Ramp-up time 2	0.00 to 650.00 [s] 0.01s	Ind: 4 FS=10.00 Type: O2	P052 = 3 P051 = 40 Online
P308 FDS (G136)	Ramp-down time 2	0.00 to 650.00 [s] 0.01s	Ind: 4 FS=10.00 Type: O2	P052 = 3 P051 = 40 Online
P309 FDS (G136)	Lower transition rounding 2	0.00 to 100.00 [s] 0.01s	Ind: 4 FS=0.00 Type: O2	P052 = 3 P051 = 40 Online
P310 FDS (G136)	Upper transition rounding 2	0.00 to 100.00 [s] 0.01s	Ind: 4 FS=0.00 Type: O2	P052 = 3 P051 = 40 Online

Ramp-function generator parameter set 3 (see also parameter P330)				
Ramp-function generator parameter set 3 is selected via the binector parameterized in P638.				
P311 FDS (G136)	Ramp-up time 3	0.00 to 650.00 [s] 0.01s	Ind: 4 FS=10.00 Type: O2	P052 = 3 P051 = 40 Online

PNU	Description	Value range [Unit] Steps	No. indices Factory setting Type	See Change (Access / Status)
P312 FDS (G136)	Ramp-down time 3	0.00 to 650.00 [s] 0.01s	Ind: 4 FS=10.00 Type: O2	P052 = 3 P051 = 40 Online
P313 FDS (G136)	Lower transition rounding 3	0.00 to 100.00 [s] 0.01s	Ind: 4 FS=0.00 Type: O2	P052 = 3 P051 = 40 Online
P314 FDS (G136)	Upper transition rounding 3	0.00 to 100.00 [s] 0.01s	Ind: 4 FS=0.00 Type: O2	P052 = 3 P051 = 40 Online

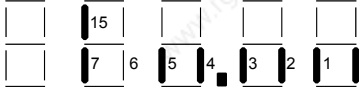
Displays				
r315 (G136)	Display of effective times i001: Display of effective ramp-up time i002: Display of effective ramp-down time i003: Display of effective lower transition rounding i004: Display of effective upper transition rounding	0.00 to 650.00 / 10.00 [s] 0.01s	Ind: 4 Type: O2	P052 = 3
r316 (G136)	Display of ramp-function generator status Mode of representation on operator panel (PMU):  Segment: 0 RFG enable 1 RFG start 2 Setpoint enable & /OFF1 3 Set RFG 4 RFG tracking 5 Bypass RFG 7 Ramp-down 15 Ramp-up		Ind: None Type: V2	P052 = 3

P317 * FDS (G136)	Ramp-function generator tracking 0 Ramp-function generator tracking is not active 1 Ramp-function generator tracking is active	0 to 1 1	Ind: 4 FS=0 Type: O2	P052 = 3 P051 = 40 Offline
P318 * FDS (G136)	Set ramp-function generator output This parameter determines how the ramp-function generator output is set at the commencement of a "Shutdown" process: 0 The ramp-function generator output is <u>not set</u> at the commencement of a "Shutdown" process" 1 At the commencement of "Shutdown", the output is set to the <u>actual speed value K0167</u> (actual speed value K0167 is "unfiltered") 2 At the commencement of "Shutdown", the output is set to the <u>actual speed value K0179</u> (value is filtered by PT1 in P200, other filters may also be active) (setting may not be used in conjunction with P205 > 0) During a "Shutdown" process, the limitation at the ramp-function generator output is not effective. P318 must be set to 1 or 2 to prevent any (temporary) excess speed during "Shutdown" when the generator output is limited.	0 to 2 1	Ind: 4 FS=0 Type: O2	P052 = 3 P051 = 40 Offline

P319 FDS (G136)	Delay time for enabling ramp-function generator [SW 1.5 and later]	0.00 to 10.00 [s] 0.01s	Ind: 4 FS=0.00 Type: O2	P052 = 3 P051 = 40 Online
-----------------------	---	-------------------------------	-------------------------------	---------------------------------

10.15 Setpoint processing

P320 FDS (G135)	Multiplier for main setpoint	-300.00 to 300.00 [%] 0.01%	Ind: 4 FS=100.00 Type: I2	P052 = 3 P051 = 40 Online
-----------------------	-------------------------------------	-----------------------------------	---------------------------------	---------------------------------

PNU	Description	Value range [Unit] Steps	No. indices Factory setting Type	See Change (Access / Status)
P321 FDS (G135)	Multiplier for additional setpoint	-300.00 to 300.00 [%] 0.01%	Ind: 4 FS=100.00 Type: I2	P052 = 3 P051 = 40 Online
P322 * FDS (G135)	Source for multiplier for main setpoint 0 = Connector K0000 1 = Connector K0001 etc.	All connector numbers 1	Ind: 4 FS=1 Type: L2	P052 = 3 P051 = 40 Offline
P323 * FDS (G135)	Source for multiplier for additional setpoint 0 = Connector K0000 1 = Connector K0001 etc.	All connector numbers 1	Ind: 4 FS=1 Type: L2	P052 = 3 P051 = 40 Offline

10.16 Ramp-function generator

P330 * FDS (G136)	Factor for ramp-function generator times [SW 2.1 and later] Selection of a factor for the values set in parameters P296, P297, P298, P303 to P314 and P542 (ramp-function generator times). 0 Factor = 1 1 Factor = 60 i.e. effective ramp-function generator times = values set in [minutes] instead of in [seconds]	0 bis 1 1	Ind: 4 WE=0 Typ: O2	P052 = 3 P051 = 40 off-line
----------------------------	--	--------------	---------------------------	-----------------------------------

10.17 Setting values for monitoring functions and limits

Setting values for monitoring functions				
P351 FDS	Threshold for undervoltage trip If the line voltage drops below a specific value (P078) and does not return to the permissible tolerance range within the "Restart time" set in P086, fault message F006 is activated. The drive dwells in operating state o4 or o5 while the line undervoltage persists.	-90 to 0 [%] Armature: 1% of P078.001 Field: 1% of P078.002	Ind: 4 FS=-20 Type: I2	P052 = 3 P051 = 40 Online
P352 FDS	Source for overvoltage trip If the line voltage exceeds a specific value (P078) and does not return to the permissible tolerance range within the "Restart time" set in P086, fault message F007 is activated.	0 to 99 [%] Armature: 1% of P078.001 Field: 1% of P078.002	Ind: 4 FS=20 Type: O2	P052 = 3 P051 = 40 Online
P353 FDS	Response threshold for phase failure monitoring If the line voltage drops below the permissible value in operating states of $\leq o4$ and does not return to an "acceptable" value within the "Restart time" set in P086, fault message F004 or F005 is activated. The drive dwells in operating state o4 or o5 for the period that the line voltage remains below the threshold and during the subsequent voltage stabilization period set in P090. <u>When a switch-on command is entered</u> , the converter dwells in operating states o4 and o5 for a maximum total delay period for both states set in P089 until the voltages in all phases exceed the threshold set in this parameter before fault message F004 or F005 is activated.	10 to 100 [%] Armature: 1% of P078.001 Field: 1% of P078.002	Ind: 4 FS=40 Type: O2	P052 = 3 P051 = 40 Online
P355 FDS	Stall protection time F035 is activated if the conditions for the "Stall protection" fault message are fulfilled for longer than the period set in P355. When P355=0.0, the "Drive blocked" monitoring function (F035) is deactivated and alarm A035 is likewise suppressed.	0.0 to 600.0 [s] 0.1s	Ind: 4 FS=0,5 Type: O2	P052 = 3 P051 = 40 Online
P357 FDS	Threshold for tachometer interruption monitoring F042 is suppressed if the actual EMF value is lower than the value set in P357. The setting is entered as a % of the ideal mean DC voltage value at $\alpha=0$, i.e. as a % of P078.001 * 1.35	10 to 70 [%] 1%	Ind: 4 FS=10 Type: O2	P052 = 3 P051 = 40 Online

PNU	Description	Value range [Unit] Steps	No. indices Factory setting Type	See Change (Access / Status)
P360 (G180) (G181)	Response delay for external faults and alarms The fault message or alarm is not activated on the converter until the appropriate input or corresponding control word bit (as selected in P675, P686, P688 or P689) has been in the LOW state for at least the time period set in this parameter (see also Section 8, Sheets G180 and G181). i001: Delay for external fault 1 i002: Delay for external fault 2 i003: Delay for external alarm 1 i004: Delay for external alarm 2	0 to 10000 [ms] 1ms	Ind: 4 FS=0 Type: O2	P052 = 3 P051 = 40 Online
P361 FDS	Delay time for the undervoltage monitoring [SW 1.7 and later] Activation of the fault message F006 (line undervoltage) is delayed by the time that can be set in this parameter. During this delay time firing pulses are output! Another time which is parameterized for automatic restarting (P086) only begins after the time set here has elapsed.	0 to 60000 [ms] 1ms	Ind: 4 FS=0 Type: O2	P052 = 3 P051 = 40 on-line
P362 FDS	Delay time for the overvoltage monitoring [SW 1.7 and later] Activation of the fault message F007 (line overvoltage) is delayed by the time that can be set in this parameter. During this delay time firing pulses are output! Another time which is parameterized for automatic restarting (P086) only begins after the time set here has elapsed.	0 to 60000 [ms] 1ms	Ind: 4 FS=10000 Type: O2	P052 = 3 P051 = 40 on-line
P363 FDS	Threshold for the minimum line frequency [SW 1.8 and later] If the line frequency falls below the value set here and does not rise above it again within the "restart" time set in P086, the fault message F008 is activated. As long as the line frequency is below the value set here, the drive is kept in operating state o4 or o5. [values < 45.0 Hz can be set in SW 1.9 and later] CAUTION Operation in the extended frequency range between 23 Hz and 110 Hz is available on request.	23.0 to 60.0 [Hz] 0.1 Hz	Ind: 4 FS=45.0 Type: O2	P052 = 3 P051 = 40 on-line
P364 FDS	Threshold for the maximum line frequency [SW 1.8 and later] If the line frequency rises above the value set here and does not fall below it again within the "restart" time set in P086, the fault message F009 is activated. As long as the line frequency is above the value set here, the drive is kept in operating state o4 or o5. CAUTION Operation in the extended frequency range between 23 Hz and 110 Hz is available on request.	50.0 to 110.0 [Hz] 0.1 Hz	Ind: 4 FS=65.0 Type: O2	P052 = 3 P051 = 40 on-line

10.18 Setting values for limit-value monitors

(see also Section 8, Sheet G187 and G188 of Operating Instructions 6RX1700-0AD**)

n < n_{min} signal				
P370 FDS (G187)	Speed threshold n_{min} Speed threshold for n < n _{min} limit-value monitor. Note: This threshold also affects the sequence of control operations for "Shutdown", "Fast stop", cancellation of the "Inching" or "Crawling" command, the "Braking with field reversal" function and the brake control operation (see Section 9).	0.00 to 199.99 [%] 0.01% of maximum speed	Ind: 4 FS=0,50 Type: O2	P052 = 3 P051 = 40 Online
P371 FDS (G187)	Hysteresis for n < n_{min} signal This value is added to the response threshold if n < n _{min} is active.	0.00 to 199.99 [%] 0.01% of maximum speed	Ind: 4 FS=0,50 Type: O2	P052 = 3 P051 = 40 Online
n < n_{comp} signal				

PNU	Description	Value range [Unit] Steps	No. indices Factory setting Type	See Change (Access / Status)
P373 FDS (G187)	Speed threshold n_{comp}. Speed threshold for $n < n_{comp}$. signal	0.00 to 199.99 [%] 0.01% of maximum speed	Ind: 4 FS=100.00 Type: O2	P052 = 3 P051 = 40 Online
P374 FDS (G187)	Hysteresis for $< n_{comp}$. signal ($n < n_{comp}$. signal) This value is added to the response threshold if $n < n_{comp}$. is active.	0.00 to 199.99 [%] 0.01% of maximum speed	Ind: 4 FS=3.00 Type: O2	P052 = 3 P051 = 40 Online
P375 FDS (G187)	OFF delay for $n < n_{comp}$. signal	0.0 to 100.0 [s] 0.1s	Ind: 4 FS=3.0 Type: O2	P052 = 3 P051 = 40 Online

Setpoint/actual value deviation 2				
P376 FDS (G187)	Permissible setpoint/actual value deviation 2 [SW 1.9 and later]	0.00 to 199.99 [%] 0.01% of maximum speed	Ind: 4 FD=3.00 Type: O2	P052 = 3 P051 = 40 on-line
P377 FDS (G187)	Hysteresis for setpoint/actual value deviation 2 signal [SW 1.9 and later] This value is added to the response threshold if a setpoint/actual value deviation signal is active	0.00 to 199.99 [%] 0.01% of maximum speed	Ind: 4 FS=1.00 Type: O2	P052 = 3 P051 = 40 on-line
P378 FDS (G187)	Response delay for setpoint/actual value deviation signal 2 [SW 1.9 and later]	0.0 to 100.0 [s] 0.1s	Ind: 4 FS=3.0 Type: O2	P052 = 3 P051 = 40 on-line

Overspeed				
P380 FDS (G188)	Maximum speed in positive direction of rotation	0.0 to 199.9 [%] 0.1% of maximum speed	Ind: 4 FS=120.0 Type: O2	P052 = 3 P051 = 40 Online
P381 FDS (G188)	Maximum speed in negative direction of rotation	-199.9 to 0.0 [%] 0.1% of maximum speed	Ind: 4 FS=-120.0 Type: I2	P052 = 3 P051 = 40 Online

Setpoint/actual value deviation 1				
P388 FDS (G187)	Permissible deviation between setpoint and actual value 1	0.00 to 199.99 [%] 0.01% of maximum speed	Ind: 4 FS=3.00 Type: O2	P052 = 3 P051 = 40 Online
P389 FDS (G187)	Hysteresis for setpoint/actual value deviation signal 1 This value is added to the response threshold if a setpoint/actual value deviation signal is active	0.00 to 199.99 [%] 0.01% of maximum speed	Ind: 4 FS=1.00 Type: O2	P052 = 3 P051 = 40 Online
P390 FDS (G187)	Response delay for setpoint/actual value deviation signal 1	0.0 to 100.0 [s] 0.1s	Ind: 4 FS=3.0 Type: O2	P052 = 3 P051 = 40 Online

$I_f < I_f \min$ signal				
P394 FDS (G188)	Field current threshold $I_f \min$ Field current threshold for $I_f < I_f \min$ limit-value monitor. Note: This threshold affects the sequence of control operations for the "Direction of rotation reversal using field reversal" and "Braking with field reversal" functions (see Section 9). The $I_f < I_f \min$ signal is connected to binector B0215, the actual value at field current controller input K0265 is applied as I_f . B0215 = 0 when K0265 > threshold set in P394 B0215 = 1 when K0265 < threshold set in P394 + hysteresis set in P395 0 → 1 transition takes place when K0265 < P394 1 → 0 transition takes place when K0265 > P394 + P395	0.00 to 199.99 [%] 0.01% of converter rated field DC current (r073.i02)	Ind: 4 FS=3.00 Type: O2	P052 = 3 P051 = 40 Online
P395 FDS (G188)	Hysteresis for $I_f < I_f \min$ signal This value is added to the response threshold if $I_f < I_f \min$ is active. (see also P394)	0.00 to 100.00 [%] 0.01% of converter rated field DC current (r073.i02)	Ind: 4 FS=1.00 Type: O2	P052 = 3 P051 = 40 Online

PNU	Description	Value range [Unit] Steps	No. indices Factory setting Type	See Change (Access / Status)
Field current monitoring				
Fault message F005 is activated if the actual field current (K0265) is lower than the percentage of the field current setpoint (K0268) set in P396 for longer than the time set in parameter P397.				
Note: Fault message F005 is only activated, however, if the field current setpoint is > 2% of the converter rated DC current of the field (r073.i02) ist.				
P396 FDS (G167)	Threshold for field current monitoring [SW 1.9 and later]	1 to 100 [%] 0.01% of setpoint at field current con- troller input (K0268)	Ind: 4 FS=50 Type: O2	P052 = 3 P051 = 40 on-line
P397 FDS (G167)	Field current monitoring time [SW 1.9 and later]	0.02 to 60.00 [s] 0.01s	Ind: 4 FS=0.50 Type: O2	P052 = 3 P051 = 40 on-line

I_f < I_{f x} signal				
P398 FDS (G188)	Field current threshold I_{f x} Setpoint-oriented field current threshold for I _f < I _{f x} limit-value monitor. Note: This threshold affects the sequence of control operations for the "Direction of rotation reversal using field reversal" and "Braking with field reversal" functions (see Section 9). The I _f < I _{f x} signal is connected to binector B0216, the actual value at field current controller input K0265 is applied as I _f . B0216 = 0 when K0265 > threshold set in P398 B0216 = 1 when K0265 < threshold set in P398 + hysteresis set in P399 0 → 1 transition takes place when K0265 < P398 1 → 0 transition takes place when K0265 > P398 + P399	0.00 to 199.99 [%] 0.01% of setpoint at field current controller input (K0268)	Ind: 4 FS=80.00 Type: O2	P052 = 3 P051 = 40 Online
P399 FDS (G188)	Hysteresis for I_f < I_{f x} signal This value is added to the response threshold if I _f < I _{f x} is active. (see also P398)	0.00 to 100.00 [%] 0.01% of converter rated field DC current (r073.i02)	Ind: 4 FS=1.00 Type: O2	P052 = 3 P051 = 40 Online

10.19 Settable fixed values

Function: The value set in the parameter is applied to the specified connector				
P401 FDS (G120)	K401 fixed value is applied to connector K0401	-199.99 to 199.99 [%] 0.01%	Ind: 4 FS=0.00 Type: I2	P052 = 3 P051 = 40 Online
P402 FDS (G120)	K402 fixed value is applied to connector K0402	-199.99 to 199.99 [%] 0.01%	Ind: 4 FS=0.00 Type: I2	P052 = 3 P051 = 40 Online
P403 FDS (G120)	K403 fixed value is applied to connector K0403	-199.99 to 199.99 [%] 0.01%	Ind: 4 FS=0.00 Type: I2	P052 = 3 P051 = 40 Online
P404 FDS (G120)	K404 fixed value is applied to connector K0404	-199.99 to 199.99 [%] 0.01%	Ind: 4 FS=0.00 Type: I2	P052 = 3 P051 = 40 Online
P405 FDS (G120)	K405 fixed value is applied to connector K0405	-199.99 to 199.99 [%] 0.01%	Ind: 4 FS=0.00 Type: I2	P052 = 3 P051 = 40 Online
P406 FDS (G120)	K406 fixed value is applied to connector K0406	-199.99 to 199.99 [%] 0.01%	Ind: 4 FS=0.00 Type: I2	P052 = 3 P051 = 40 Online
P407 FDS (G120)	K407 fixed value is applied to connector K0407	-199.99 to 199.99 [%] 0.01%	Ind: 4 FS=0.00 Type: I2	P052 = 3 P051 = 40 Online
P408 FDS (G120)	K408 fixed value is applied to connector K0408	-199.99 to 199.99 [%] 0.01%	Ind: 4 FS=0.00 Type: I2	P052 = 3 P051 = 40 Online
P409 FDS (G120)	K409 fixed value is applied to connector K0409	-199.99 to 199.99 [%] 0.01%	Ind: 4 FS=0.00 Type: I2	P052 = 3 P051 = 40 Online
P410 FDS (G120)	K410 fixed value is applied to connector K0410	-199.99 to 199.99 [%] 0.01%	Ind: 4 FS=0.00 Type: I2	P052 = 3 P051 = 40 Online

PNU	Description	Value range [Unit] Steps	No. indices Factory setting Type	See Change (Access / Status)
P411 FDS (G120)	K411 fixed value is applied to connector K0411	-199.99 to 199.99 [%] 0.01%	Ind: 4 FS=0.00 Type: I2	P052 = 3 P051 = 40 Online
P412 FDS (G120)	K412 fixed value is applied to connector K0412	-32768 to 32767 1	Ind: 4 FS=0 Type: I2	P052 = 3 P051 = 40 Online
P413 FDS (G120)	K413 fixed value is applied to connector K0413	-32768 to 32767 1	Ind: 4 FS=0 Type: I2	P052 = 3 P051 = 40 Online
P414 FDS (G120)	K414 fixed value is applied to connector K0414	-32768 to 32767 1	Ind: 4 FS=0 Type: I2	P052 = 3 P051 = 40 Online
P415 FDS (G120)	K415 fixed value is applied to connector K0415	-32768 to 32767 1	Ind: 4 FS=0 Type: I2	P052 = 3 P051 = 40 Online
P416 FDS (G120)	K416 fixed value is applied to connector K0416	-32768 to 32767 1	Ind: 4 FS=0 Type: I2	P052 = 3 P051 = 40 Online

10.20 Fixed control bits

Function: The value set in the parameter is applied to the specified binector				
P421 FDS (G120)	B421 fixed bit is applied to binector B0421	0 to 1 1	Ind: 4 FS=0 Type: O2	P052 = 3 P051 = 40 Online
P422 FDS (G120)	B422 fixed bit is applied to binector B0422	0 to 1 1	Ind: 4 FS=0 Type: O2	P052 = 3 P051 = 40 Online
P423 FDS (G120)	B423 fixed bit is applied to binector B0423	0 to 1 1	Ind: 4 FS=0 Type: O2	P052 = 3 P051 = 40 Online
P424 FDS (G120)	B424 fixed bit is applied to binector B0424	0 to 1 1	Ind: 4 FS=0 Type: O2	P052 = 3 P051 = 40 Online
P425 FDS (G120)	B425 fixed bit is applied to binector B0425	0 to 1 1	Ind: 4 FS=0 Type: O2	P052 = 3 P051 = 40 Online
P426 FDS (G120)	B426 fixed bit is applied to binector B0426	0 to 1 1	Ind: 4 FS=0 Type: O2	P052 = 3 P051 = 40 Online
P427 FDS (G120)	B427 fixed bit is applied to binector B0427	0 to 1 1	Ind: 4 FS=0 Type: O2	P052 = 3 P051 = 40 Online
P428 FDS (G120)	B428 fixed bit is applied to binector B0428	0 to 1 1	Ind: 4 FS=0 Type: O2	P052 = 3 P051 = 40 Online

10.21 Digital setpoint input (fixed setpoint, inching and crawling setpoints)

(see also Section 8, Sheets G127, G129 and G130 of Operating Instructions 6RX1700-0AD**)

Fixed setpoint				
Function: Up to 8 connectors can be selected in P431 indices .01 to .08. These can be applied as an additional fixed setpoint (K0204, K0209) via the binectors selected in P430, indices .01 to .08 (setpoint is applied when binector switches to log. "1" state). P432 indices .01 to .08 can be set to define for each setpoint individually whether the ramp-function generator must be bypassed on setpoint injection. If fixed setpoint injection is not selected, the connector set in P433 is applied to K0209.				
P430 * (G127)	Source for fixed-setpoint injection Selection of binector to control injection of the fixed setpoint ("1" state = fixed setpoint injected). 0 = binector B0000 1 = binector B0001 etc.	All binector numbers 1	Ind: 8 FS=0 Type: L2	P052 = 3 P051 = 40 Offline

PNU	Description	Value range [Unit] Steps	No. indices Factory setting Type	See Change (Access / Status)
P431 * (G127)	Source for fixed setpoint Selection of connector to be injected as the fixed setpoint 0 = connector K0000 1 = connector K0001 etc.	All connector numbers 1	Ind: 8 FS=0 Type: L2	P052 = 3 P051 = 40 Offline
P432 * (G127)	Source for selection of ramp-function generator bypass Selection as to whether or not ramp-function generator must be bypassed when the fixed setpoint is injected. The ramp-function generator is bypassed if the AND operation between the binector selected via an index of P430 and the setting in the same index of P432 produces a log. "1"	0 to 1 1	Ind: 8 FS=0 Type: O2	P052 = 3 P051 = 40 Offline
P433 * FDS (G127)	Source for standard setpoint Selection of the connector to be applied if fixed-setpoint injection is not selected 0 = connector K0000 1 = connector K0001 etc.	All connector numbers 1	Ind: 4 FS=11 Type: L2	P052 = 3 P051 = 40 Offline

Inching setpoint

Function: Up to 8 connectors can be selected in P436 indices .01 to .08. These can be applied as an inching setpoint (K0202, K0207) via the binectors selected in P435, indices .01 to .08 (setpoint is applied when binector switches to log. "1" state). P437 indices .01 to .08 can be set to define for each setpoint individually whether the ramp-function generator must be bypassed on setpoint injection. If more than one inching setpoint is injected, an output value corresponding to inching setpoint = 0% is applied.

If inching setpoint injection is not selected, the connector set in P438 is applied to K0207.

P435 * (G129)	Source for injection of inching setpoint Selection of binector to control injection of the inching setpoint ("1" state = inching setpoint injected). 0 = binector B0000 1 = binector B0001 etc.	All binector numbers 1	Ind: 8 FS=0 Type: L2	P052 = 3 P051 = 40 Offline
P436 * (G129)	Source for inching setpoint Selection of connector to be injected as the inching setpoint 0 = connector K0000 1 = connector K0001 etc.	All connector numbers 1	Ind: 8 FS=0 Type: L2	P052 = 3 P051 = 40 Offline
P437 * (G129)	Source for selection of ramp-function generator bypass Selection as to whether or not ramp-function generator must be bypassed when the inching setpoint is injected. The ramp-function generator is bypassed if the AND operation between the binector selected via an index of P435 and the setting in the same index of P437 produces a log. "1".	0 to 1 1	Ind: 8 FS=0 Type: O2	P052 = 3 P051 = 40 Offline
P438 * FDS (G129)	Source for standard setpoint Selection of the connector to be applied if inching-setpoint injection is not selected 0 = connector K0000 1 = connector K0001 etc.	All connector numbers 1	Ind: 4 FS=208 Type: L2	P052 = 3 P051 = 40 Offline

Crawling setpoint

Function: Up to 8 connectors can be selected in P441 indices .01 to .08. These can be applied as an additional crawling setpoint (K0201, K0206) via the binectors selected in P440, indices .01 to .08. P445 can be set to define whether the setpoint must be applied when the selected binectors have reached the log. "1" state (when P445=0) or in response to a 0 → 1 transition (when P445=1). When setpoint injection in response to a 0 → 1 transition is selected, the setpoint injection function is reset when the binector selected in P444 switches to the log. "0" state. P442 indices .01 to .08 can be set to define for each setpoint individually whether the ramp-function generator must be bypassed on setpoint injection.

If crawling setpoint injection is not selected, the connector set in P443 is applied to K0206.

P440 * (G130)	Source for injection of crawling setpoint Selection of binector to control injection of the crawling setpoint. 0 = binector B0000 1 = binector B0001 etc.	All binector numbers 1	Ind: 8 FS=0 Type: L2	P052 = 3 P051 = 40 Offline
-------------------------	--	---------------------------	----------------------------	----------------------------------

PNU	Description	Value range [Unit] Steps	No. indices Factory setting Type	See Change (Access / Status)
P441 * (G130)	Source for crawling setpoint Selection of connector to be injected as the crawling setpoint 0 = connector K0000 1 = connector K0001 etc.	All connector numbers 1	Ind: 8 FS=0 Type: L2	P052 = 3 P051 = 40 Offline
P442 * (G130)	Source for selection of ramp-function generator bypass Selection as to whether or not ramp-function generator must be bypassed when the crawling setpoint is injected. The ramp-function generator is bypassed if the AND operation between the binector selected via an index of P440 and the setting in the same index of P442 produces a log. "1".	0 to 1 1	Ind: 8 FS=0 Type: O2	P052 = 3 P051 = 40 Offline
P443 * FDS (G130)	Source for standard setpoint Selection of the connector to be applied if crawling-setpoint injection is not selected 0 = connector K0000 1 = connector K0001 etc.	All connector numbers 1	Ind: 4 FS=207 Type: L2	P052 = 3 P051 = 40 Offline
P444 * BDS (G130)	Source for standstill command Selection of the binector to control the standstill operation (OFF1) or resetting of crawling setpoint injection when P445=1 (log. "0" state = reset). 0 = binector B0000 1 = binector B0001 etc.	All binector numbers 1	Ind: 2 FS=0 Type: L2	P052 = 3 P051 = 40 Offline
P445 * (G130)	Selection of level/edge for switch-on/crawling Selection to define whether ON command must be input via terminal 37 and the crawling setpoint injected in response to a log. "1" level or to a 0 → 1 transition 0 ON with log. "1" state at terminal 37 and injection of crawling setpoint with binectors selected in P440 in log. "1" state 1 ON in response to 0 → 1 transition at terminal 37 and injection of crawling setpoint in response to 0 → 1 transition of binectors selected in P440 With this setting, the ON command or injection command for the crawling setpoint is stored. The memory is reset when the binector selected in P444 switches to the log. "0" state.	0 to 1 1	Ind: None FS=0 Type: O2	P052 = 3 P051 = 40 Offline

10.22 Position sensing with pulse encoder

See parameters P140 to P148 for pulse encoder definition and monitoring				
P450 * FDS (G145)	Resetting of position counter 0 Reset position counter OFF 1 Reset position counter with zero marker 2 Reset position counter with zero marker when LOW signal is applied to terminal 39 3 Reset position counter when LOW signal is applied to terminal 39 Note: Counter resetting with P450 = 2 and 3 is executed in the hardware and is not affected by how the binectors controlled by terminal 39 are interconnected	0 to 3 1	Ind: 4 FS=1 Type: O2	P052 = 3 P051 = 40 Offline
P451 * FDS (G145)	Position counter hysteresis 0 Hysteresis for rotational direction reversal OFF 1 Hysteresis for rotational direction reversal ON (the first pulse encoder input pulse after a change in rotational direction is not counted)	0 to 1 1	Ind: 4 FS=0 Type: O2	P052 = 3 P051 = 40 Offline
P452 * BDS (G145)	Source for "Reset position counter" command [SW 1.9 and later] Selection of binector to control resetting of the position counter . 0 = binector B0000 1 = binector B0001 etc.	All binector numbers 1	Ind: 2 FS=0 Type: L2	P052 = 3 P051 = 40 off-line

PNU	Description	Value range [Unit] Steps	No. indices Factory setting Type	See Change (Access / Status)
P453 * BDS (G145)	Source for "Enable zero marker counter" command [SW 1.9 and later] Selection of binector to control enabling of the zero marker counter 0 = binector B0000 1 = binector B0001 etc.	All binector numbers 1	Ind: 2 FS=1 Type: L2	P052 = 3 P051 = 40 off-line

10.23 Connector selector switches

(see also Section 8, Function Diagram Sheet G124 of Operating Instructions 6RX1700-0AD**)

P455 * (G124)	Source for inputs of connector selector switch 1 [SW 1.9 and later] Selection of connectors for the input signals for connector selector switch 1. 0 = connector K0000 1 = connector K0001 etc.	All connector numbers 1	Ind: 3 FS=0 Type: L2	P052 = 3 P051 = 40 off-line
P456 * (G124)	Source for control of connector selector switch 1 [SW 1.9 and later] Selection of binectors to control connector selector switch 1. 0 = binector B0000 1 = binector B0001 etc.	All binector numbers 1	Ind: 2 FS=0 Type: L2	P052 = 3 P051 = 40 off-line
P457 * (G124)	Source for inputs of connector selector switch 2 [SW 1.9 and later] Selection of connectors for the input signals for connector selector switch 2. 0 = connector K0000 1 = connector K0001 etc.	All connector numbers 1	Ind: 3 FS=0 Type: L2	P052 = 3 P051 = 40 off-line
P458 * (G124)	Source for control of connector selector switch 2 [SW 1.9 and later] Selection of binectors to control connector selector switch 2. 0 = binector B0000 1 = binector B0001 etc.	All binector numbers 1	Ind: 2 FS=0 Type: L2	P052 = 3 P051 = 40 off-line

10.24 Motorized potentiometer

(see also Section 8, Sheet G126 of Operating Instructions 6RX1700-0AD**)

P460 * FDS (G126)	Control word for motorized potentiometer ramp-function generator 0 The motorized potentiometer ramp generator is bypassed in Automatic mode (same effect as for P462 and P463 = 0.01, i.e. the generator output is made to follow the automatic setpoint without delay) 1 Motorized potentiometer ramp generator is active in Manual and Automatic modes	0 to 1 1	Ind: 4 FS=1 Type: O2	P052 = 3 P051 = 40 Offline
P461 * FDS (G126)	Source for setpoint in Automatic mode Selection of the connector to be applied as the Automatic setpoint to the ramp-function generator in the motorized potentiometer 0 = connector K0000 1 = connector K0001 etc.	All connector numbers 1	Ind: 4 FS=0 Type: L2	P052 = 3 P051 = 40 Offline
P462 FDS (G126)	Ramp-up time for motorized potentiometer	0.01 to 300.00 [s] 0.01s	Ind: 4 FS=10.00 Type: O2	P052 = 3 P051 = 40 Online
P463 FDS (G126)	Ramp-down time for motorized potentiometer	0.01 to 300.00 [s] 0.01s	Ind: 4 FS=10.00 Type: O2	P052 = 3 P051 = 40 Online

PNU	Description	Value range [Unit] Steps	No. indices Factory setting Type	See Change (Access / Status)
P464 FDS (G126)	Time difference for dy/dt Setting of <u>dt</u> for the output of dy/dt at a connector, i.e. on K0241 the change in the output quantity (K0240) is output within the time set in P464, multiplied by the factor set in P465 (unit of time setting is [s] if P465=0 or [min] if P465=1) Example: - The ramp-function generator is currently ramping up with a ramp-up time of P462=5s, i.e. a ramp-up operation from y=0% to y=100% takes 5s. - A time difference dt of P464=2s is set. - => A dy/dt of 40% appears at connector K0241 since the dy within the set dt of 2 s equals (2s/5s)*100%.	0.01 to 300.00 [s] 0.01s	Ind: 4 FS=10.00 Type: O2	P052 = 3 P051 = 40 Online
P465 * FDS (G126)	Factor of expansion for motorized potentiometer The effective ramp-up time, ramp-down time or time difference for dy/dt is the product of the time setting in parameter P462, P463 and P464 respectively, multiplied by the factor set in this parameter. 0 Parameters P462, P463 and P464 are multiplied by a <u>factor of 1</u> 1 Parameters P462, P463 and P464 are multiplied by a <u>factor of 60</u>	0 to 1 1	Ind: 4 FS=0 Type: O2	P052 = 3 P051 = 40 Online
P466 * FDS (G126)	Source for motorized potentiometer setting value Selection of the connector to be injected as the motorized potentiometer setting value 0 = connector K0000 1 = connector K0001 etc.	All connector numbers 1	Ind: 4 FS=0 Type: L2	P052 = 3 P051 = 40 Offline
P467 FDS (G126)	Motorized potentiometer starting value Starting value of motorized potentiometer after ON when P473 = 0	-199.9 to 199.9 [%] 0.1%	Ind: 4 FS=0.0 Type: I2	P052 = 3 P051 = 40 Online
P468 FDS (G126)	Setpoint for "Raise motorized potentiometer" Motorized potentiometer manual operation: Setpoint for "Raise motorized potentiometer"	-199.99 to 199.99 [%] 0.01%	Ind: 4 FS=100.00 Type: I2	P052 = 3 P051 = 40 Online
P469 FDS (G126)	Setpoint for "Lower motorized potentiometer" Motorized potentiometer manual operation: Setpoint for "Lower motorized potentiometer"	-199.99 to 199.99 [%] 0.01%	Ind: 4 FS=-100.00 Type: I2	P052 = 3 P051 = 40 Online
P470 * BDS (G126)	Source for clockwise/counter-clockwise switchover Selection of binector to control " Clockwise/counter-clockwise switchover " ("0" state = clockwise). 0 = binector B0000 1 = binector B0001 etc.	All binector numbers 1	Ind: 2 FS=0 Type: L2	P052 = 3 P051 = 40 Offline
P471 * BDS (G126)	Source for manual/automatic switchover Selection of binector to control " Manual/automatic switchover " ("0" state = manual). 0 = binector B0000 1 = binector B0001 etc.	All binector numbers 1	Ind: 2 FS=0 Type: L2	P052 = 3 P051 = 40 Offline
P472 * BDS (G126)	Source for set motorized potentiometer Selection of binector to control " Set motorized potentiometer " ("0" to "1" transition = set motorized potentiometer). 0 = binector B0000 1 = binector B0001 etc.	All binector numbers 1	Ind: 2 FS=0 Type: L2	P052 = 3 P051 = 40 Offline
P473 * FDS (G126)	Storage of output value 0 <u>No storage of output value:</u> The output is set to 0 in all operating states of >o5. The starting point after ON is determined by P467 (MOP starting value). 1 <u>Non-volatile storage of output value:</u> The output value remains stored in all operating states and after voltage disconnection or failure. The last value stored is output again after voltage recovery/reconnection.	0 to 1 1	Ind: 4 FS=0 Type: O2	P052 = 3 P051 = 40 Offline

PNU	Description	Value range [Unit] Steps	No. indices Factory setting Type	See Change (Access / Status)
-----	-------------	--------------------------------	---	---------------------------------------

10.25 Oscillation

<p>Function: Parameters P480 to P483 define the waveshape of a rectangular signal (oscillation setpoint K0203). The value set in P480 determines the signal level for the time period set in P481 and the value set in P482 the signal level for the time period set in P483.</p> <p>Oscillation: Selected in P485. The free-running rectangular signal is switched through to the output K0208.</p>				
P480 FDS (G128)	Oscillation setpoint 1	-199.9 to 199.9 [%] 0.1% of maximum speed	Ind: 4 FS=0,5 Type: I2	P052 = 3 P051 = 40 Online
P481 FDS (G128)	Oscillation time 1	0.1 to 300.0 [s] 0.1s	Ind: 4 FS=0.1 Type: O2	P052 = 3 P051 = 40 Online
P482 FDS (G128)	Oscillation setpoint 2	-199.9 to 199.9 [%] 0.1% of maximum speed	Ind: 4 FS=-0,4 Type: I2	P052 = 3 P051 = 40 Online
P483 FDS (G128)	Oscillation time 2	0.1 to 300.0 [s] 0.1s	Ind: 4 FS=0.1 Type: O2	P052 = 3 P051 = 40 Online
P484 * FDS (G128)	Source for standard setpoint Selection of connector to be injected as the output value when the "Oscillation" function is not selected 0 = connector K0000 1 = connector K0001 etc.	All connector numbers 1	Ind: 4 FS=209 Type: L2	P052 = 3 P051 = 40 Offline
P485 * BDS (G128)	Source for oscillation selection Selection of binector to control activation of the "Oscillation" function (log. "1" state = oscillation active) 0 = binector B0000 1 = binector B0001 etc.	All binector numbers 1	Ind: 2 FS=0 Type: L2	P052 = 3 P051 = 40 Offline

10.26 Definition of "Motor interface"

(see also Section 8, Sheets G185 and G186 of Operating Instructions 6RX1700-0AD**)

<p>CAUTION! The encoders for measurement and monitoring of the brush length, bearing condition, air flow and motor temperature must be safely isolated from the power circuit.</p>				
P490 * (G185)	Selection of temperature sensor for analog monitoring of motor temperature i001: Temperature sensor at terminals 22 / 23; i002: Temperature sensor at terminals 204 / 205; Settings: 0 No temperature sensor 1 KTY84 2 PTC thermistor with R=600Ω 1) 3 PTC thermistor with R=1200Ω 1) 4 PTC thermistor with R=1330Ω 1) 5 PTC thermistor with R=2660Ω 1) 1) PTC thermistor according to DIN 44081 / 44082 with specified R at rated response temperature, 1330Ω on Siemens motors (setting 4 must be selected). When a PTC thermistor is selected as the temperature sensor, it is not necessary to set parameters P491 and P492 (alarm and trip temperatures). These two temperatures are predetermined by the type of PTC thermistor installed. Whether an alarm or fault is output when the operating point of the PTC thermistor is reached depends on how the relevant input is parameterized (P493.F or P494.F).	0 to 5 1	Ind: 2 FS=0 Type: O2	P052 = 3 P051 = 40 Offline
P491 FDS (G185)	Analog monitoring of motor temperature: Alarm temperature Operative only when P490.x=1.	0 to 200 [°C] 1°C	Ind: 4 FS=0 Type: O2	P052 = 3 P051 = 40 Online

PNU	Description	Value range [Unit] Steps	No. indices Factory setting Type	See Change (Access / Status)
P492 FDS (G185)	Analog monitoring of motor temperature: Trip temperature Operative only when P490.x=1.	0 to 200 [°C] 1°C	Ind: 4 FS=0 Type: O2	P052 = 3 P051 = 40 Online
P493 * FDS (G185)	Motor temperature analog 1 (temperature sensor at terminals 22 / 23): Tripping of alarm or fault message Motor temperature grasped with KTY84 0 Monitoring deactivated 1 Alarm (A029) at temperature > P491 2 Fault message (F029) at temperature > P492 3 Alarm (A029) at temperature > P491 and fault message (F029) at temperature > P492 Motor temperature grasped with PTC thermistor 0 Monitoring deactivated 1 Alarm message (A029) when operating point of PTC thermistor is reached 2 Fault message (F029) when operating point of PTC thermistor is reached 3 Illegal setting	0 to 3 1	Ind: 4 FS=0 Type: O2	P052 = 3 P051 = 40 Offline
P494 * FDS (G185)	Motor temperature analog 2 (temperature sensor at terminals 204 / 205): Tripping of alarm or fault message Motor temperature grasped with KTY84 0 Monitoring deactivated 1 Alarm (A029) at temperature > P491 2 Fault message (F029) at temperature > P492 3 Alarm (A029) at temperature > P491 and fault message (F029) at temperature > P492 Motor temperature grasped with PTC thermistor 0 Monitoring deactivated 1 Alarm message (A029) when operating point of PTC thermistor is reached 2 Fault message (F029) when operating point of PTC thermistor is reached 3 Illegal setting	0 to 3 1	Ind: 4 FS=0 Type: O2	P052 = 3 P051 = 40 Offline
P495 * FDS (G186)	Brush length sensing: Tripping of alarm or fault message 0 No brush length sensing (terminal 211 is not scanned) 1 Binary brush length sensing (terminal 211 is scanned) Alarm (A025) in response to 0 signal 2 Binary brush length sensing (terminal 211 is scanned) Fault message (F025) in response to 0 signal	0 to 2 1	Ind: 4 FS=0 Type: O2	P052 = 3 P051 = 40 Offline
P496 * FDS (G186)	Bearing condition: Tripping of alarm or fault message 0 No bearing condition sensing (terminal 212 is not scanned) 1 Bearing condition sensing (terminal 212 is scanned) Alarm (A026) in response to 1 signal 2 Bearing condition sensing (terminal 212 is scanned) Fault message (F026) in response to 1 signal	0 to 2 1	Ind: 4 FS=0 Type: O2	P052 = 3 P051 = 40 Offline
P497 * FDS (G186)	Air flow: Tripping of alarm or fault message 0 No air flow monitoring (terminal 213 is not scanned) 1 Air flow monitoring (terminal 213 is scanned) Alarm (A027) in response to 0 signal 2 Air flow monitoring (terminal 213 is scanned) Fault message (F027) in response to 0 signal	0 to 2 1	Ind: 4 FS=0 Type: O2	P052 = 3 P051 = 40 Offline
P498 * FDS (G186)	Temperature switch: Tripping of alarm or fault message 0 No temperature switch connected (terminal 214 is not scanned) 1 Temperature switch connected (terminal 214 is scanned) Alarm (A028) in response to 0 signal 2 Temperature switch connected (terminal 214 is scanned) Fault message (F028) in response to 0 signal	0 to 2 1	Ind: 4 FS=0 Type: O2	P052 = 3 P051 = 40 Offline

PNU	Description	Value range [Unit] Steps	No. indices Factory setting Type	See Change (Access / Status)
-----	-------------	--------------------------------	---	---------------------------------------

10.27 Configuring of torque shell input

P500 * BDS (G160)	Source for torque setpoint for slave drive Selection of the connector to be injected as the torque setpoint for a slave drive 0 = connector K0000 1 = connector K0001 etc.	All connector numbers 1	Ind: 2 FS=170 Type: L2	P052 = 3 P051 = 40 Offline
P501 * BDS (G160)	Source for additional torque setpoint Selection of connector to be injected as the additional torque setpoint 0 = connector K0000 1 = connector K0001 etc.	All connector numbers 1	Ind: 2 FS=0 Type: L2	P052 = 3 P051 = 40 Offline
P502 * (G152)	Source for value to be added to speed controller output Selection of connector to be injected as the value to be added to the speed controller output (in addition to friction and moment of inertia compensation) 0 = connector K0000 1 = connector K0001 etc.	All connector numbers 1	Ind: None FS=0 Type: L2	P052 = 3 P051 = 40 Offline
P503 FDS (G160)	Multiplier for torque setpoint in slave mode	-300.00 to 300.00 [%] 0.01%	Ind: 4 FS=100.00 Type: I2	P052 = 3 P051 = 40 on-line

10.28 Speed limiting controller

(see also Section 8, Sheet G160 of Operating Instructions 6RX1700-0AD**)

The output of the speed limiting controller comprises a positive (K0136) and a negative (K0137) torque limit. These limits are applied to the torque limitation				
P509 * (G160)	Source for input quantity (n-act) of speed limiting controller 0 = connector K0000 1 = connector K0001 etc.	All connector numbers 1	Ind: None FS=167 Type: L2	P052 = 3 P051 = 40 Offline
P510 * (G160)	Source for pos. torque limit of speed limiting controller Selection of the connector to be injected as the limit value for torque limitation 1 0 = connector K0000 1 = connector K0001 etc.	All connector numbers 1	Ind: None FS=2 Type: L2	P052 = 3 P051 = 40 Offline
P511 * (G160)	Source for neg. torque limit of speed limiting controller Selection of the connector to be injected as the limit value for torque limitation 2 0 = connector K0000 1 = connector K0001 etc.	All connector numbers 1	Ind: None FS=4 Type: L2	P052 = 3 P051 = 40 Offline
P512 FDS (G160)	Maximum speed in positive direction of rotation	0.0 to 199.9 [%] 0.1% of rated speed	Ind: 4 FS=105.0 Type: O2	P052 = 3 P051 = 40 Online
P513 FDS (G160)	Maximum speed in negative direction of rotation	-199.9 to 0.0 [%] 0.1% of rated speed	Ind: 4 FS=-105.0 Type: I2	P052 = 3 P051 = 40 Online
P515 FDS (G160)	P gain of speed limiting controller	0.10 to 200.00 0.01	Ind: 4 FS=3.00 Type: O2	P052 = 3 P051 = 40 Online

PNU	Description	Value range [Unit] Steps	No. indices Factory setting Type	See Change (Access / Status)
-----	-------------	--------------------------------	---	---------------------------------------

10.29 Friction compensation

(see also Section 8, Sheet G153 of Operating Instructions 6RX1700-0AD**)

Parameters P520 to P530 are the armature current and torque setpoint required for a stationary input signal (factory setting: speed controller actual value K0179) of 0%, 10% to 100% of the maximum value (in steps of 10%). These parameters are intermediate points along the friction curve. Depending on P170 (0 or 1) they are either an armature current or a torque setpoint and are set automatically when the friction and moment of inertia compensation (P051=28) are optimized. P520 is then set to 0.0%.

The intermediate points are interpolated linearly during which the output of the friction compensation assumes the sign of the input signal. P530 is specified by the friction compensation even for input signals >100% of the maximum signal.

During operation in both directions we recommend leaving P520 at 0.0% in order to avoid armature current vibration at 0% of the input signal.

P519 * (G153)	Source for input signal of the friction compensation [SW 2.0 and later] Selection of the input signals that are added and led to the input of the friction compensation. i001 Input signal, with sign i002 Input signal with absolute value generator Settings: 0 = Connector K0000 1 = Connector K0001 etc.	All connector numbers 1	Ind: 2 FS= i001: 179 i002: 0 Type: L2	P052 = 3 P051 = 40 offline
P520 FDS (G153)	Friction at 0% speed Setting as % of converter rated DC current or rated torque	0.0 to 100.0 [%] 0.1%	Ind: 4 FS=0.0 Type: O2	P052 = 3 P051 = 40 Online
P521 FDS (G153)	Friction at 10% speed Setting as % of converter rated DC current or rated torque	0.0 to 100.0 [%] 0.1%	Ind: 4 FS=0.0 Type: O2	P052 = 3 P051 = 40 Online
P522 FDS (G153)	Friction at 20% speed Setting as % of converter rated DC current or rated torque	0.0 to 100.0 [%] 0.1%	Ind: 4 FS=0.0 Type: O2	P052 = 3 P051 = 40 Online
P523 FDS (G153)	Friction at 30% speed Setting as % of converter rated DC current or rated torque	0.0 to 100.0 [%] 0.1%	Ind: 4 FS=0.0 Type: O2	P052 = 3 P051 = 40 Online
P524 FDS (G153)	Friction at 40% speed Setting as % of converter rated DC current or rated torque	0.0 to 100.0 [%] 0.1%	Ind: 4 FS=0.0 Type: O2	P052 = 3 P051 = 40 Online
P525 FDS (G153)	Friction at 50% speed Setting as % of converter rated DC current or rated torque	0.0 to 100.0 [%] 0.1%	Ind: 4 FS=0.0 Type: O2	P052 = 3 P051 = 40 Online
P526 FDS (G153)	Friction at 60% speed Setting as % of converter rated DC current or rated torque	0.0 to 100.0 [%] 0.1%	Ind: 4 FS=0.0 Type: O2	P052 = 3 P051 = 40 Online
P527 FDS (G153)	Friction at 70% speed Setting as % of converter rated DC current or rated torque	0.0 to 100.0 [%] 0.1%	Ind: 4 FS=0.0 Type: O2	P052 = 3 P051 = 40 Online
P528 FDS (G153)	Friction at 80% speed Setting as % of converter rated DC current or rated torque	0.0 to 100.0 [%] 0.1%	Ind: 4 FS=0.0 Type: O2	P052 = 3 P051 = 40 Online
P529 FDS (G153)	Friction at 90% speed Setting as % of converter rated DC current or rated torque	0.0 to 100.0 [%] 0.1%	Ind: 4 FS=0.0 Type: O2	P052 = 3 P051 = 40 Online
P530 FDS (G153)	Friction at 100% speed and higher Setting as % of converter rated DC current or rated torque	0.0 to 100.0 [%] 0.1%	Ind: 4 FS=0.0 Type: O2	P052 = 3 P051 = 40 Online

PNU	Description	Value range [Unit] Steps	No. indices Factory setting Type	See Change (Access / Status)
-----	-------------	--------------------------------	---	---------------------------------------

10.30 Compensation of moment of inertia (dv/dt injection)

(see also Section 8, Sheet G153 of Operating Instructions 6RX1700-0AD**)

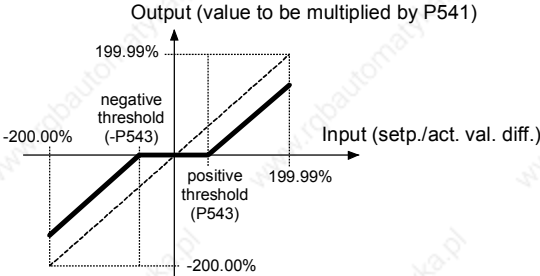
P540 FDS (G153)	Acceleration time The acceleration time is the time that would be needed to accelerate the drive from 0% to 100% of maximum speed (with no friction) at 100% converter rated DC current (armature) and 100% rated motor field current (i.e. 100% flux). It is a measure of the moment of inertia on the motor shaft. This parameter is set automatically during the optimization run for friction and moment of inertia compensation (P051=28).	0.00 to 650.00 [s] 0.01s	Ind: 4 FS=0.00 Type: O2	P052 = 3 P051 = 40 Online
P541 FDS (G153)	P gain of acceleration Proportional gain for "SAD-dependent acceleration" function (see also parameter P543)	0.00 to 650.00 0.01	Ind: 4 FS=0.00 Type: O2	P052 = 3 P051 = 40 Online
P542 FDS (G136)	Time difference for dy/dt of ramp-function generator Ramp-function generator: Setting of dt for the output of dy/dt at a connector, i.e. at K0191, the change in the output quantity of the ramp-function generator (K0190) is output within the period set in P542 Example: - The ramp-function generator is currently ramping up with a ramp-up time of P311=5s, i.e. a ramp-up operation from y=0% to y=100% takes 5s. - A time difference dt of P542=2s is set. - \Rightarrow A dy/dt of 40% appears at connector K0191 since the dy within the set dt of 2 s equals $(2s/5s)*100\%$. (see also parameter P330)	0.01 to 300.00 [s] 0.01s	Ind: 4 FS=0.01 Type: O2	P052 = 3 P051 = 40 Online
P543 FDS (G153)	Threshold for SAD-dependent acceleration With respect to the SAD-dependent acceleration function, only the component of the speed controller setpoint/actual value difference which has an absolute value in excess of the threshold set in this parameter is switched through (see also parameter P541). 	0.00 to 100.00 [%] 0.01% of maximum speed	Ind: 4 FS=0.00 Type: O2	P052 = 3 P051 = 40 Online
P546 FDS (G153)	Filter time for compensation of moment of inertia	0 to 10000 [ms] 1ms	Ind: 4 FS=0 Type: O2	P052 = 3 P051 = 40 Online

PNU	Description	Value range [Unit] Steps	No. indices Factory setting Type	See Change (Access / Status)
-----	-------------	--------------------------------	---	---------------------------------------

10.31 Speed controller

(see also Section 8, Sheet G151 of Operating Instructions 6RX1700-0AD**)

further parameters for the speed controller P200 - P236

Speed controller adaptation

The parameters of the speed controller (Kp, Tn, droop) can be altered as a function of any connector to adapt the speed controller optimally to a changing controlled system.

The diagrams below show the active P gain, the active Integration time and the active droop depending on the value of the set connector.

Adaptation of the P gain:

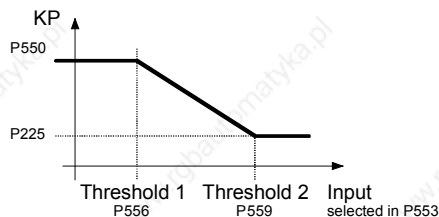

Adaptation of the integration time:

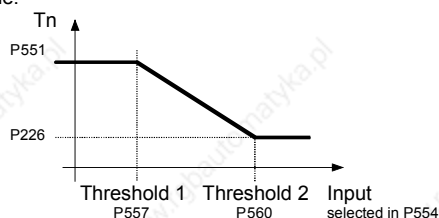

Adaptation of the droop:

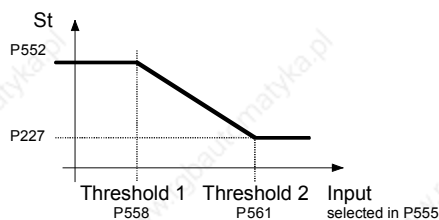

For parameter pairs P225/P550, P226/P551 and P227/P552 all values can be set completely mutually independently, e.g., P550 does not have to be greater than P225. The above diagrams show only the effect of the individual parameters.

Threshold 1 must always be set smaller than threshold 2, otherwise the fault message F058 is activated.

P550 FDS (G151)	P gain in the adaptation range Value of Kp, if Influencing quantity ≤ Threshold 1	0.10 to 200.00 0.01	Ind: 4 FS=3.00 Type: O2	P052 = 3 P051 = 40 on-line
P551 FDS (G151)	Integration time in the adaptation range [SW 1.7 and later] Value of Tn, if Influencing quantity ≤ Threshold 1	0.010 to 10.000 [s] 0.001s	Ind: 4 FS=0.650 Type: O2	P052 = 3 P051 = 40 on-line
P552 FDS (G151)	Droop in the adaptation range [SW 1.7 and later] Value of droop, if Influencing quantity ≤ Threshold 1	0.0 to 10.0 [%] 0.1%	Ind: 4 FS=0.0 Type: O2	P052 = 3 P051 = 40 on-line
P553 * FDS (G151)	Source for the Influencing quantity of the Kp adaptation Selection of which connector is connected at the influencing quantity for adaptation of the n controllers P gain 0 = connector K0000 1 = connector K0001 etc.	All connector numbers 1	Ind: 4 FS=0 Type: L2	P052 = 3 P051 = 40 off-line
P554 * FDS (G151)	Source for the Influencing quantity of the Tn-adaptation [SW 1.7 and later] Selection of which connector is connected at the influencing quantity for adaptation of the n controllers integration time 0 = connector K0000 1 = connector K0001 etc.	All connector numbers 1	Ind: 4 FS=0 Type: L2	P052 = 3 P051 = 40 off-line

PNU	Description	Value range [Unit] Steps	No. indices Factory setting Type	See Change (Access / Status)
P555 * FDS (G151)	Source for the Influencing quantity of the droop adaptation [SW 1.7 and later] Selection of which connector is connected at the influencing quantity for adaptation of the n controllers droop 0 = Connector K0000 1 = Connector K0001 etc.	All connector numbers 1	Ind: 4 FS=0 Type: L2	P052 = 3 P051 = 40 off-line
P556 FDS (G151)	Adaptation n controller P gain: Threshold 1	0.00 to 100.00 [%] 0.01%	Ind: 4 FS=0.00 Type: O2	P052 = 3 P051 = 40 on-line
P557 FDS (G151)	Adaptation n controller integration time: Threshold 1 [SW 1.7 and later]	0.00 to 100.00 [%] 0.01%	Ind: 4 FS=0.00 Type: O2	P052 = 3 P051 = 40 on-line
P558 FDS (G151)	Adaptation n controller droop: Threshold 1 [SW 1.7 and later]	0.00 to 100.00 [%] 0.01%	Ind: 4 FS=0.00 Type: O2	P052 = 3 P051 = 40 on-line
P559 FDS (G151)	Adaptation n controller P gain: Threshold 2	0.00 to 100.00 [%] 0.01%	Ind: 4 FS=0.00 Type: O2	P052 = 3 P051 = 40 on-line
P560 FDS (G151)	Adaptation n controller integration time: Threshold 2 [SW 1.7 and later]	0.00 to 100.00 [%] 0.01%	Ind: 4 FS=0.00 Type: O2	P052 = 3 P051 = 40 on-line
P561 FDS (G151)	Adaptation n controller droop: Threshold 2 [SW 1.7 and later]	0.00 to 100.00 [%] 0.01%	Ind: 4 FS=0.00 Type: O2	P052 = 3 P051 = 40 on-line

Drehzahlregler - Begrenzung der Statik

P562 FDS (G151)	Positive speed droop limitation	0.00 to 199.99 [%] 0.01%	Ind: 4 FS=100.00 Type: O2	P052 = 3 P051 = 40 Online
P563 FDS (G151)	Negative speed droop limitation	-199.99 to 0.00 [%] 0.01%	Ind: 4 FS=-100.00 Type: I2	P052 = 3 P051 = 40 Online

Speed controller optimization for drives with oscillating mechanical system

On drives with oscillating mechanical components, it can be useful to optimize the speed controller using optimization run P051=29. The frequency response of the controlled system for frequencies from 1 Hz to 100 Hz is recorded during optimization.

The drive is first accelerated up to a base speed (P565, FS=20%). A sinusoidal speed setpoint with low amplitude (P566, FS=1%) is then injected. The frequency of this supplementary setpoint is incremented in 1 Hz steps from 1 Hz up to 100 Hz. An average per frequency is calculated over a parameterizable number of current peaks (P567, FS=300).

P565	Base speed for frequency response recording [SW 1.9 and later]	1.0 to 30.0 [%] 0.1%	Ind: None FS=20.0 Type: O2	P052 = 3 P051 = 40 on-line
P566	Amplitude for frequency response recording [SW 1.9 and later]	0.01 to 5.00 [%] 0.01%	Ind: None FS=1.00 Type: O2	P052 = 3 P051 = 40 on-line
P567	Number of current peaks for frequency response recording [SW 1.9 and later] While the frequency response is being recorded, an average over the number of current peaks set here is calculated for each measuring frequency. High values improve the result, but extend the measuring time. When P567 = 1000, the frequency response recording takes about 9 minutes.	100 to 1000 1	Ind: None FS=300 Type: O2	P052 = 3 P051 = 40 on-line

PNU	Description	Value range [Unit] Steps	No. indices Factory setting Type	See Change (Access / Status)
-----	-------------	--------------------------------	---	---------------------------------------

10.32 Field reversal

(see also Section 9 of Operating Instructions 6RX1700-0AD**)

P580 * BDS (G200)	Source for selection of "Direction of rotation reversal using field reversal" Selection of binector to control the "Direction of rotation reversal using field reversal" function 0 = binector B0000 1 = binector B0001 etc. Signal 0: Positive field direction is selected (B0260 = 1, B0261 = 0), actual speed value is not inverted Signal 1: Negative field direction is selected (B0260 = 0, B0261 = 1), actual speed value is inverted	All binector numbers 1	Ind: 2 FS=0 Type: L2	P052 = 3 P051 = 40 Offline
P581 * BDS (G200)	Source for selection of "Braking with field reversal" Selection of binector to control the "Braking with field reversal" function 0 = binector B0000 1 = binector B0001 etc. Signal change 0→1: Reversal of field direction (causes braking); When n<n-min is reached, the original field direction is selected again. The drive switches to state o7.2	All binector numbers 1	Ind: 2 FS=0 Type: L2	P052 = 3 P051 = 40 Offline
P582 * BDS (G200)	Source for selection of "Field reversal" [SW 1.9 and later] Selection of binector to control "Field reversal" function 0 = binector B0000 1 = binector B0001 etc. Signal 0: Positive field direction is selected (B0260 = 1, B0261 = 0) Signal 1: Negative field direction is selected (B0260 = 0, B0261 = 1)	All binector numbers 1	Ind: 2 FS=0 Type: L2	P052 = 3 P051 = 40 off-line
P583 * (G200)	Source for actual speed signal for field reversal logic [SW 1.9 and later] Selection of connector to be used as actual speed value for the field reversal logic. 0 = binector B0000 1 = binector B0001 etc.	All connector numbers 1	Ind: None FS=167 Type: L2	P052 = 3 P051 = 40 off-line

10.33 Input quantities for signals

(see also Section 8, Sheet G187 and G188 of Operating Instructions 6RX1700-0AD**)

P590 * (G187)	Source for setpoint of "nset = nact signal 1" Setpoint/actual value deviation signal: Selection of connector to be injected as input quantity "nset" for the setpoint/actual value deviation signal. 0 = connector K0000 1 = connector K0001 etc.	All connector numbers 1	Ind: None FS=174 Type: L2	P052 = 3 P051 = 40 Offline
P591 * (G187)	Source for actual value of "n-set = n-act signal 1" Setpoint/actual value deviation signal: Selection of connector to be injected as input quantity "nact" for the setpoint/actual value deviation signal. 0 = connector K0000 1 = connector K0001 etc.	All connector numbers 1	Ind: None FS=167 Type: L2	P052 = 3 P051 = 40 Offline

PNU	Description	Value range [Unit] Steps	No. indices Factory setting Type	See Change (Access / Status)
P592* (G187)	Source for actual value of "n < n_{comp} signal" n < n _{comp} signal: Selection of connector to be injected as input quantity (n) for the n < n _{comp} signal. 0 = connector K0000 1 = connector K0001 etc.	All connector numbers 1	Ind: None FS=167 Type: L2	P052 = 3 P051 = 40 Offline
P593* (G187)	Source for actual value of "n < n_{min} signal" n < n _{min} signal: Selection of connector to be injected as input quantity (n) for the n < n _{min} signal. 0 = connector K0000 1 = connector K0001 etc.	All connector numbers 1	Ind: None FS=167 Type: L2	P052 = 3 P051 = 40 Offline
P594* (G188)	Source for input quantity of "Polarity signal" Polarity signal of speed setpoint: Selection of connector to be injected as input quantity "n _{set} " for the polarity signal of the speed setpoint. 0 = connector K0000 1 = connector K0001 etc.	All connector numbers 1	Ind: None FS=170 Type: L2	P052 = 3 P051 = 40 Offline
P595* (G188)	Source for actual value of "Overspeed signal" Overspeed signal: Selection of connector to be injected as input quantity "n _{act} " for the overspeed signal. 0 = connector K0000 1 = connector K0001 etc.	All connector numbers 1	Ind: None FS=167 Type: L2	P052 = 3 P051 = 40 Offline
P596* (G187)	Source for setpoint of "nset = nact signal 2" [SW 1.9 and later] Setpoint/actual value deviation signal: Selection of connector to be injected as input quantity "n _{set} " for the setpoint/actual value deviation signal. 0 = connector K0000 1 = connector K0001 etc.	All connector numbers 1	Ind: None FS=174 Type: L2	P052 = 3 P051 = 40 off-line
P597* (G187)	Source for actual value of "nset = nact signal 2" [SW 1.9 and later] Setpoint/actual value deviation signal: Selection of connector to be injected as input quantity "n _{act} " for the setpoint/actual value deviation signal. 0 = connector K0000 1 = connector K0001 etc.	All connector numbers 1	Ind: None FS=167 Type: L2	P052 = 3 P051 = 40 off-line

10.34 Configuring of closed-loop control

Setting values for configuring of torque shell				
P600* (G163)	Source for gating unit input (armature) i001 to i004: Selects which connectors are applied as the gating unit input (armature) . All four values are added. Settings: 0 = connector K0000 1 = connector K0001 etc.	All connector numbers 1	Ind: 4 FS= i001: 102 i002: 0 i003: 0 i004: 0 Typ: L2	P052 = 3 P051 = 40 off-line

PNU	Description	Value range [Unit] Steps	No. indices Factory setting Type	See Change (Access / Status)
P601* (G160) (G161) (G162)	<p>Source for armature current controller setpoint</p> <p>i001,i002 Speed limiting controller: Selection of connectors to be injected as input quantities for the speed limiting controller. Both values are added.</p> <p>i003,i004 Current limitation: Selection of connectors to be injected as armature current controller setpoint (before current limitation). Both values are added.</p> <p>i005,i006 Current control: [SW 1.8 and later] Selection of which connectors are connected as the armature current controller setpoint (before current controller). The two values are added. The magnitude is formed from the value selected with index 6.</p> <p>Settings: 0 = connector K0000 1 = connector K0001 etc.</p>	All connector numbers 1	Ind: 6 FS= i001: 141 i002: 0 i003: 134 i004: 0 i005: 125 i006: 0 Type: L2	P052 = 3 P051 = 40 Offline
P602* (G162)	<p>Source for armature current controller actual value</p> <p>Selection of connector to be injected as armature current controller actual value</p> <p>0 = connector K0000 1 = connector K0001 etc.</p>	All connector numbers 1	Ind: None FS=117 Type: L2	P052 = 3 P051 = 40 Offline
P603* (G161)	<p>Source for variable current limit in torque direction I</p> <p>i001..i004 Selection of connector to be injected as <u>variable</u> current limit in torque direction I Normalization: +100% corresponds to P100*P171</p> <p>i005 Selection of connector to be injected as current limit in torque direction I with <u>Fast Stop or Shutdown</u> Normalization: +100% corresponds to P100*P171</p> <p>i006 Selection of connector to be injected as <u>variable</u> current limit in torque direction I Normalization: +100% corresponds to r072.002 [can be set in SW 1.9 and later]</p> <p>i007 Selection of connector to be injected as current limit in torque direction I with <u>Emergency Stop or Shutdown</u> Normalization: +100% corresponds to r072.002 [can be set in SW 1.9 and later]</p> <p>Settings: 0 = connector K0000 1 = connector K0001 etc.</p>	All connector numbers 1	Ind: 7 FS= i001: 1 i002: 1 i003: 1 i004: 1 i005: 1 i006: 2 i007: 2 Type: L2	P052 = 3 P051 = 40 Offline

PNU	Description	Value range [Unit] Steps	No. indices Factory setting Type	See Change (Access / Status)
P604 * (G161)	<p>Source for variable current limit in torque direction II</p> <p>i001..i004 Selection of connector to be injected as <u>variable</u> current limit in torque direction II Normalization: -100% corresponds to P100*P172</p> <p>i005 Selection of connector to be injected as current limit in torque direction II with <u>Fast Stop or Shutdown</u> Normalization: -100% corresponds to P100*P172</p> <p>i006 Selection of connector to be injected as <u>variable</u> current limit in torque direction II Normalization: -100% corresponds to r072.002 [can be set in SW 1.9 and later]</p> <p>i007 Selection of connector to be injected as current limit in torque direction II with <u>Emergency Stop or Shutdown</u> Normalization: -100% corresponds to r072.002 [can be set in SW 1.9 and later]</p> <p>Settings: 0 = connector K0000 ... 8 = connector K0008 9 = value as set in parameter P603.ixx * (-1) 10 = connector K0010 etc.</p>	All connector numbers 1	Ind: 7 FS=9 Type: L2	P052 = 3 P051 = 40 Offline
P605 * (G160)	<p>Source for variable positive torque limit</p> <p>Torque limitation: Selection of connectors to be injected as the variable positive torque limit</p> <p>i001..i004 Normalization: 100% of the connector value corresponds to the positive system torque limit according to $I_a=P171$ and $I_f = P102$</p> <p>i005 Normalization: 100% of the connector value corresponds to the positive torque limit according to $I_a=r072.002$ and $I_f = P102$ [can be set in SW 1.9 and later]</p> <p>0 = connector K0000 1 = connector K0001 etc.</p>	All connector numbers 1	Ind: 5 FS=2 Type: L2	P052 = 3 P051 = 40 Offline
P606 * (G160)	<p>Source for variable negative torque limit</p> <p>Torque limitation: Selection of connectors to be injected as the variable negative torque limit</p> <p>i001..i004 Normalization: 100% of the connector value corresponds to the negative system torque limit according to $I_a=P172$ and $I_f = P102$</p> <p>i005 Normalization: 100% of the connector value corresponds to the negative torque limit according to $I_a=r072.002$ and $I_f = P102$ [can be set in SW 1.9 and later]</p> <p>0 = connector K0000 ... 8 = connector K0008 9 = value as set in parameter P605 * (-1) 10 = connector K0010 etc.</p>	All connector numbers 1	Ind: 5 FS=9 Type: L2	P052 = 3 P051 = 40 Offline
P607 * BDS (G160)	<p>Source for torque setpoint for master drive</p> <p>Torque limitation: Selection of connector to be injected as the torque setpoint for a master drive</p> <p>0 = connector K0000 1 = connector K0001 etc.</p>	All connector numbers 1	Ind: 2 FS=148 Type: L2	P052 = 3 P051 = 40 Offline

PNU	Description	Value range [Unit] Steps	No. indices Factory setting Type	See Change (Access / Status)
Speed controller				
P609 * (G151)	Source for actual speed controller value Selection of connector to be injected as the actual speed controller value when P083=4 0 = connector K0000 1 = connector K0001 etc.	All connector numbers 1	Ind: None FS=0 Type: L2	P052 = 3 P051 = 40 Offline
Setting values for configuring of closed-loop field and EMF control				
P610 * (G166)	Source for gating unit input (field) Selection of connector to be applied to the gating unit input (field) 0 = connector K0000 1 = connector K0001 etc.	All connector numbers 1	Ind: None FS=252 Type: L2	P052 = 3 P051 = 40 Offline
P611 * (G165)	Source for field current controller setpoint Limitation at EMF controller output: Selection of connectors to be injected as the field current controller setpoint . The connectors selected in the four indices are added. 0 = connector K0000 1 = connector K0001 etc.	All connector numbers 1	Ind: 4 FS= i001: 277 i002: 0 i003: 0 i004: 0 Type: L2	P052 = 3 P051 = 40 Offline
P612 * (G166)	Source for actual field current controller value Selection of connectors to be injected as the field current controller actual value . The two values are added. 0 = connector K0000 1 = connector K0001 etc.	All connector numbers 1	Ind: 2 FS= i001: 266 i002: 0 Type: L2	P052 = 3 P051 = 40 Offline
P613 * (G165)	Source for variable field current setpoint upper limit Limitation at EMF controller output Selection of connector to be injected as the variable field current setpoint upper limit i001..i004 Normalization: 100% of the connector value corresponds to the rated excitation current of the motor (P102) i005 Normalization: 100% of the connector value corresponds to the actual converter rated DC current (field) (r073.002) [can be set in SW 1.9 and later] 0 = connector K0000 1 = connector K0001 etc.	All connector numbers 1	Ind: 5 FS=1 Type: L2	P052 = 3 P051 = 40 Offline
P614 * (G165)	Source for variable field current setpoint lower limit Limitation at EMF controller output Selection of connector to be injected as the variable field current setpoint lower limit i001..i004 Normalization: 100% of the connector value corresponds to the minimum excitation current of the motor (P103) i005 Normalization: 100% of the connector value corresponds to the actual converter rated DC current (field) (r073.002) [can be set in SW 1.9 and later] 0 = connector K0000 1 = connector K0001 etc.	All connector numbers 1	Ind: 5 FS=1 Type: L2	P052 = 3 P051 = 40 Offline

PNU	Description	Value range [Unit] Steps	No. indices Factory setting Type	See Change (Access / Status)
P615 *	Source for EMF controller setpoint Selection of connectors to be injected as the EMF controller setpoint . The connectors selected in the four indices are added. 0 = connector K0000 1 = connector K0001 etc.	All connector numbers 1	Ind: 4 FS= i001: 289 i002: 0 i003: 0 i004: 0 Type: L2	P052 = 3 P051 = 40 Offline
P616 *	Source for actual EMF controller value Selection of connector to be injected as the actual EMF controller value 0 = connector K0000 1 = connector K0001 etc.	All connector numbers 1	Ind: None FS=286 Type: L2	P052 = 3 P051 = 40 Offline

Configuring of injection of acceleration value

P619 *	Source for acceleration injection value Selection of connector to be applied as the acceleration injection value 0 = connector K0000 1 = connector K0001 etc.	All connector numbers 1	Ind: None FS=191 Type: L2	P052 = 3 P051 = 40 Offline
-----------	---	----------------------------	---------------------------------	----------------------------------

Speed controller

Speed controller, setpoint/actual value deviation

Function:

The connectors selected in parameters P621 and P622 are added and those selected in P623 and 624 subtracted

P620 *	Source for speed controller setpoint/actual value deviation Selection of connector to be injected as the control deviation 0 = connector K0000 1 = connector K0001 etc.	All connector numbers 1	Ind: None FS=165 Type: L2	P052 = 3 P051 = 40 Offline
P621 *	Source for speed controller setpoint 0 = connector K0000 1 = connector K0001 etc.	All connector numbers 1	Ind: None FS=176 Type: L2	P052 = 3 P051 = 40 Offline
P622 *	Source for speed controller setpoint 0 = connector K0000 1 = connector K0001 etc.	All connector numbers 1	Ind: None FS=174 Type: L2	P052 = 3 P051 = 40 Offline
P623 *	Source for actual speed controller value 0 = connector K0000 1 = connector K0001 etc.	All connector numbers 1	Ind: None FS=179 Type: L2	P052 = 3 P051 = 40 Offline
P624 *	Source for actual speed controller value 0 = connector K0000 1 = connector K0001 etc.	All connector numbers 1	Ind: None FS=0 Type: L2	P052 = 3 P051 = 40 Offline

Speed controller: Filtering of setpoint and actual value, band-stop filters

P625 *	Source for speed controller setpoint Selection of connector to be injected as the input signal for speed setpoint filtering 0 = connector K0000 1 = connector K0001 etc.	All connector numbers 1	Ind: 4 FS=170 Type: L2	P052 = 3 P051 = 40 Offline
P626 *	Source for actual speed controller value Selection of connector to be injected as the input signal for actual speed value filtering 0 = connector K0000 1 = connector K0001 etc.	All connector numbers 1	Ind: 4 FS=167 Type: L2	P052 = 3 P051 = 40 Offline

PNU	Description	Value range [Unit] Steps	No. indices Factory setting Type	See Change (Access / Status)
P627 * (G152)	Source for input of D element Selection of connector to be injected as the input signal for the D element 0 = connector K0000 1 = connector K0001 etc.	All connector numbers 1	Ind: None FS=178 Type: L2	P052 = 3 P051 = 40 Offline
P628 * (G152)	Source for input of band-stop filter 1 Selection of connector to be injected as the input signal for band-stop filter 1 0 = connector K0000 1 = connector K0001 etc.	All connector numbers 1	Ind: None FS=179 Type: L2	P052 = 3 P051 = 40 Offline
P629 * (G152)	Source for band-stop filter 2 Selection of connector to be injected as the input signal for band-stop filter 2 0 = connector K0000 1 = connector K0001 etc.	All connector numbers 1	Ind: None FS=177 Type: L2	P052 = 3 P051 = 40 Offline
Speed controller droop				
P630 * (G151)	Source for influencing quantity for speed droop Selection of connector to be injected as the influencing quantity 0 = connector K0000 1 = connector K0001 etc.	All connector numbers 1	Ind: None FS=162 Type: L2	P052 = 3 P051 = 40 Offline
Setting the speed controller I component				
Function: When the binector selected in P695 switches state from log. "0" to log. "1", the I component of the speed controller is set to the value of the connector selected in P631. With this function it is possible, to use the same signal (binector) to control controller enabling commands and setting of the I component.				
P631 * (G152)	Source for setting value for speed controller integrator Selection of connector to be injected as the setting value for the I component 0 = connector K0000 1 = connector K0001 etc.	All connector numbers 1	Ind: None FS=0 Type: L2	P052 = 3 P051 = 40 Offline
Setting values for configuring the setpoint processing function and ramp-function generator				
Limitation at ramp-function generator output (setpoint limitation)				
(see also Section 8, Sheet G136 of Operating Instructions 6RX1700-0AD**)				
The effective limitations are:				
Upper limit: Minimum value of P300 and the four connectors selected with P632				
Lower limit: Maximum value of P301 and the four connectors selected with P633				
Note: The limiting values for both the positive and negative setpoint limits can have a positive or negative sign. The negative setpoint limit, for example, can therefore be parameterized to a positive value and the positive setpoint limit to a negative value.				
P632 * (G137)	Source for variable positive limitation at ramp-function generator output Selection of connectors to be injected at the variable positive limitation at the ramp-function generator output (setpoint limitation). 0 = connector K0000 1 = connector K0001 etc.	All connector numbers 1	Ind: 4 FS=1 Type: L2	P052 = 3 P051 = 40 Offline
P633 * (G137)	Source for variable negative limitation at ramp-function generator output Selection of connectors to be injected at the variable negative limitation at the ramp-function generator output (setpoint limitation). 0 = connector K0000 ... 8 = connector K0008 9 = value as set in parameter P632 * (-1) 10 = connector K0010 etc.	All connector numbers 1	Ind: 4 FS=9 Type: L2	P052 = 3 P051 = 40 Offline

PNU	Description	Value range [Unit] Steps	No. indices Factory setting Type	See Change (Access / Status)
P634 * (G137)	Source for limitation input at ramp-function generator output Selection of connectors which must be added up to provide the limitation input at the ramp-function generator output (setpoint limitation). 0 = connector K0000 1 = connector K0001 etc.	All connector numbers 1	Ind: 2 FS= i001: 190 i002: 0 Type: L2	P052 = 3 P051 = 40 Offline
P635 * FDS (G135)	Source for ramp-function generator setpoint Selection of connector to be injected as the ramp-function generator setpoint 0 = connector K0000 1 = connector K0001 etc.	All connector numbers 1	Ind: 4 FS=194 Type: L2	P052 = 3 P051 = 40 Offline
P636 * (G136)	Source for reduction signal for ramp-function generator times Selection of connector to be injected as the reduction signal for the ramp-function generator times i001 acts on ramp-up and ramp-down time (P303, P304) i002 acts on lower and upper transition roundings (P305, P306) i003 acts on ramp-up time (P303) i004 acts on ramp-down time (P304) i005 acts on lower transition rounding (P305) i006 acts on upper transition rounding (P306) 0 = connector K0000 1 = connector K0001 etc.	All connector numbers 1	Ind: 6 FS=1 Type: L2	P052 = 3 P051 = 40 Offline
P637 * BDS (G136)	Source for selection of "Ramp-function generator setting 2" Selection of binector to control switchover to "Ramp-function generator setting 2" . With a log. "1" signal at the binector, ramp-function generator parameter set 2 (P307 - P310) is selected. This function has a higher priority than the ramp-up integrator function. 0 = binector B0000 1 = binector B0001 etc.	All binector numbers 1	Ind: 2 FS=0 Type: L2	P052 = 3 P051 = 40 Offline
P638 * BDS (G136)	Source for selection of "Ramp-function generator setting 3" Selection of binector to control switchover to "Ramp-function generator setting 3" . With a log. "1" signal at the binector, ramp-function generator parameter set 3 (P311 - P314) is selected. This function has a higher priority than the ramp-up integrator function. 0 = binector B0000 1 = binector B0001 etc.	All binector numbers 1	Ind: 2 FS=0 Type: L2	P052 = 3 P051 = 40 Offline
P639 * (G136)	Source for the ramp-function generator setting values Selection of the connectors that are connected as the ramp-function generator setting values . i001 Setting value for the ramp-function generator output in state log. "1" of the binector selected via P640 i002 Setting value for the ramp-function generator output if the drive is not in state "Operating" (B0104=0) and the binector selected via P640 is in state log. "0" [i002 only available with SW 1.6 and later] 0 = Connector K0000 1 = Connector K0001 etc.	All connector numbers 1	Ind: 2 FS=167 Type: L2	P052 = 3 P051 = 40 ≥off-line
P640 * BDS (G136)	Source for selection of "Set ramp-function generator" Selection of binector to control the "Set ramp-function generator" function 0 = binector B0000 1 = binector B0001 etc.	All binector numbers 1	Ind: 2 FS=0 Type: L2	P052 = 3 P051 = 40 Offline

PNU	Description	Value range [Unit] Steps	No. indices Factory setting Type	See Change (Access / Status)
P641 * BDS (G136)	Source for selection of "Bypass ramp-function generator" Selection of binector to control the " Bypass ramp-function generator " function 0 = binector B0000 1 = binector B0001 etc.	All binector numbers 1	Ind: 2 FS=0 Type: L2	P052 = 3 P051 = 40 Offline
P642 * (G135)	Source for variable positive limitation of main setpoint Selection of connectors to be injected at the variable positive limitation of the main setpoint . The lowest value in each case of the connectors selected via the 4 indices is applied as the limit. Note: Negative values at the selected connectors result in a negative maximum value at the output of the limitation. 0 = connector K0000 1 = connector K0001 etc.	All connector numbers 1	Ind: 4 FS=2 Type: L2	P052 = 3 P051 = 40 Offline
P643 * (G135)	Source for variable negative limitation of main setpoint Selection of connectors to be injected at the variable negative limitation of the main setpoint . The lowest value in each case of the connectors selected via the 4 indices is applied as the limit. Note: Positive values at the selected connectors result in a positive minimum value at the output of the limitation. 0 = connector K0000 ... 8 = connector K0008 9 = value as set in parameter P642 * (-1) 10 = connector K0010 etc.	All connector numbers 1	Ind: 4 FS=9 Type: L2	P052 = 3 P051 = 40 Offline
P644 * FDS (G135)	Source for main setpoint Selection of connector to be injected as the main setpoint 0 = connector K0000 1 = connector K0001 etc.	All connector numbers 1	Ind: 4 FS=206 Type: L2	P052 = 3 P051 = 40 Offline
P645 * FDS (G135)	Source for additional setpoint Selection of connector to be injected as an additional setpoint 0 = connector K0000 1 = connector K0001 etc.	All connector numbers 1	Ind: 4 FS=0 Type: L2	P052 = 3 P051 = 40 Offline
P646 * BDS (G136)	Source for enable signal for ramp-up integrator switchover Selection of binector to control enabling of the ramp-function integrator switchover function . 0 = binector B0000 1 = binector B0001 etc.	All binector numbers 1	Ind: 2 FS=1 Type: L2	P052 = 3 P051 = 40 Offline
P647 * BDS (G136)	Source for enable signal for ramp-function generator tracking [SW 2.1 and later] Selection of binector to control enabling of the ramp-function generator tracking function . 0 = binector B0000 1 = binector B0001 etc.	All binector numbers 1	Ind: 2 FS=1 Type: L2	P052 = 3 P051 = 40 Offline

PNU	Description	Value range [Unit] Steps	No. indices Factory setting Type	See Change (Access / Status)
-----	-------------	--------------------------------	---	---------------------------------------

10.35 Control word, status word

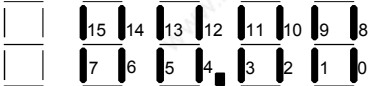
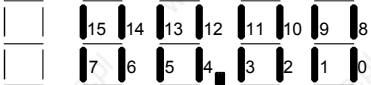
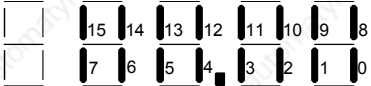
Selection of sources of control words 1 and 2				
P648 * BDS (G180)	Source for control word 1 Selection of connector to act as the source for control word 1. 0 = connector K0000 ... 8 = connector K0008 9 = parameters P654 to P675 are effective (every individual bit of control word 1 is input by a binector) 10 = connector K0010 etc.	All connector numbers 1	Ind: 2 FS=9 Type: L2	P052 = 3 P051 = 40 Offline
P649 * BDS (G181)	Source for control word 2 Selection of connector to act as the source for control word 2. 0 = connector K0000 ... 8 = connector K0008 9 = parameters P676 to P691 are effective (every individual bit of control word 2 is input by a binector) 10 = connector K0010 etc.	All connector numbers 1	Ind: 2 FS=9 Type: L2	P052 = 3 P051 = 40 Offline
Display of control words 1 and 2				
r650 (G180)	Display of control word 1 Mode of representation on operator panel (PMU):  Segments 0 to 15 correspond to bits 0 to 15 of the control word Segment ON: Corresponding bit is in log. "1" state Segment OFF: Corresponding bit is in log. "0" state		Ind: None Type: V2	P052 = 3
r651 (G181)	Display of control word 2 Mode of representation on operator panel (PMU):  Segments 0 to 15 correspond to bits 16 to 31 of the control word Segment ON: Corresponding bit is in log. "1" state Segment OFF: Corresponding bit is in log. "0" state		Ind: None Type: V2	P052 = 3
Display of status words 1 and 2				
r652 (G182)	Display of status word 1 Mode of representation on operator panel (PMU):  Segments 0 to 15 correspond to bits 0 to 15 of the status word Segment ON: Corresponding bit is in log. "1" state Segment OFF: Corresponding bit is in log. "0" state		Ind: None Type: V2	P052 = 3

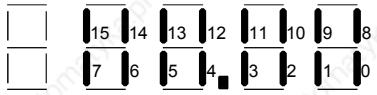
PNU	Description	Value range [Unit] Steps	No. indices Factory setting Type	See Change (Access / Status)
r653 (G183)	Display of status word 2 Mode of representation on operator panel (PMU):  Segments 0 to 15 correspond to bits 16 to 31 of the status word Segment ON: Corresponding bit is in log. "1" state Segment OFF: Corresponding bit is in log. "0" state		Ind: None Type: V2	P052 = 3

The following parameters are used to select the binectors (some of which are gated with one another or with other signals) to be applied to the individual bits of the control word.

The settings of all these parameters are as follows:

- 0 = binector B0000
- 1 = binector B0001
- etc.

The functions and logic operations are also shown on Sheets G180 and G181 in Section 8 of Operating Instructions 6RX1700-0AD**.

Control word 1

P654 * BDS (G130)	Source for control word 1, bit0 (0=OFF1, 1=ON; ANDed with terminal 37)	All binector numbers 1	Ind: 2 FS=1 Type: L2	P052 = 3 P051 = 40 Offline
P655 * BDS (G180)	1st source for control word 1, bit1 (0=OFF2; ANDed with 2 nd and 3 rd sources for bit1)	All binector numbers 1	Ind: 2 FS=1 Type: L2	P052 = 3 P051 = 40 Offline
P656 * BDS (G180)	2nd source for control word 1, bit1 (0=OFF2; ANDed with 1 st and 3 rd sources for bit1)	All binector numbers 1	Ind: 2 FS=1 Type: L2	P052 = 3 P051 = 40 Offline
P657 * BDS (G180)	3rd source for control word 1, bit1 (0=OFF2; ANDed with 1 st and 2 nd sources for bit1)	All binector numbers 1	Ind: 2 FS=1 Type: L2	P052 = 3 P051 = 40 Offline
P658 * BDS (G180)	1st source for control word 1, bit2 (0=OFF3=Fast stop; ANDed with 2 nd and 3 rd sources for bit2)	All binector numbers 1	Ind: 2 FS=1 Type: L2	P052 = 3 P051 = 40 Offline
P659 * BDS (G180)	2nd source for control word 1, bit2 (0=OFF3=Fast stop; ANDed with 1 st and 3 rd sources for bit2)	All binector numbers 1	Ind: 2 FS=1 Type: L2	P052 = 3 P051 = 40 Offline
P660 * BDS (G180)	3rd source for control word 1, bit2 (0=OFF3=Fast stop; ANDed with 1 st and 2 nd sources for bit2)	All binector numbers 1	Ind: 2 FS=1 Type: L2	P052 = 3 P051 = 40 Offline
P661 * BDS (G180)	Source for control word 1, bit3 (0=pulse disable, 1=enable; ANDed with terminal 38)	All binector numbers 1	Ind: 2 FS=1 Type: L2	P052 = 3 P051 = 40 Offline
P662 * BDS (G180)	Source for control word 1, bit4 (0=set ramp-function generator to zero, 1=enable ramp-function generator)	All binector numbers 1	Ind: 2 FS=1 Type: L2	P052 = 3 P051 = 40 Offline
P663 * BDS (G180)	Source for control word 1, bit5 (0=ramp-function generator stop, 1=ramp-function generator start)	All binector numbers 1	Ind: 2 FS=1 Type: L2	P052 = 3 P051 = 40 Offline
P664 * BDS (G180)	Source for control word 1, bit6 (0=enable setpoint, 1=disable setpoint)	All binector numbers 1	Ind: 2 FS=1 Type: L2	P052 = 3 P051 = 40 Offline
P665 * BDS (G180)	1st source for control word 1, bit7 (0→1 transition=acknowledge; ORed with 2 nd and 3 rd sources for bit7)	All binector numbers 1	Ind: 2 FS=0 Type: L2	P052 = 3 P051 = 40 Offline

PNU	Description	Value range [Unit] Steps	No. indices Factory setting Type	See Change (Access / Status)
P666 * BDS (G180)	2nd source for control word 1, bit7 (0→1 transition=acknowledge; ORed with 1 st and 3 rd sources for bit7)	All binector numbers 1	Ind: 2 FS=0 Type: L2	P052 = 3 P051 = 40 Offline
P667 * BDS (G180)	3rd source for control word 1, bit7 (0→1 transition=acknowledge; ORed with 1 st and 2 nd sources for bit7)	All binector numbers 1	Ind: 2 FS=0 Type: L2	P052 = 3 P051 = 40 Offline
P668 * BDS (G180)	Source for control word 1, bit8 (1=inching bit0)	All binector numbers 1	Ind: 2 FS=0 Type: L2	P052 = 3 P051 = 40 Offline
P669 * BDS (G180)	Source for control word 1, bit9 (1=inching bit1)	All binector numbers 1	Ind: 2 FS=0 Type: L2	P052 = 3 P051 = 40 Offline
P671 * BDS (G180)	Source for control word 1, bit11 (0=pos. direction of rotation disabled, 1=pos. direction of rotation enabled)	All binector numbers 1	Ind: 2 FS=1 Type: L2	P052 = 3 P051 = 40 Offline
P672 * BDS (G180)	Source for control word 1, bit12 (0= neg. direction of rotation disabled, 1= neg. direction of rotation enabled)	All binector numbers 1	Ind: 2 FS=1 Type: L2	P052 = 3 P051 = 40 Offline
P673 * BDS (G180)	Source for control word 1, bit13 (1=raise motorized potentiometer)	All binector numbers 1	Ind: 2 FS=0 Type: L2	P052 = 3 P051 = 40 Offline
P674 * BDS (G180)	Source for control word 1, bit14 (1=lower motorized potentiometer)	All binector numbers 1	Ind: 2 FS=0 Type: L2	P052 = 3 P051 = 40 Offline
P675 * BDS (G180)	Source for control word 1, bit15 (0=external fault, 1=no external fault)	All binector numbers 1	Ind: 2 FS=1 Type: L2	P052 = 3 P051 = 40 Offline

Control word 2				
P676 * BDS (G181)	Source for control word 2, bit16 (select function data set bit 0)	All binector numbers 1	Ind: 2 FS=0 Type: L2	P052 = 3 P051 = 40 Offline
P677 * BDS (G181)	Source for control word 2, bit17 (select function data set bit 1)	All binector numbers 1	Ind: 2 FS=0 Type: L2	P052 = 3 P051 = 40 Offline
P680 * BDS (G181)	Source for control word 2, bit20 (select fixed setpoint 0)	All binector numbers 1	Ind: 2 FS=0 Type: L2	P052 = 3 P051 = 40 Offline
P681 * BDS (G181)	Source for control word 2, bit21 (select fixed setpoint 1)	All binector numbers 1	Ind: 2 FS=0 Type: L2	P052 = 3 P051 = 40 Offline
P684 * BDS (G181)	Source for control word 2, bit24 (0=n controller speed droop disabled, 1=enabled)	All binector numbers 1	Ind: 2 FS=1 Type: L2	P052 = 3 P051 = 40 Offline
P685 * BDS (G181)	Source for control word 2, bit25 (0=n controller disabled, 1=n controller enabled)	All binector numbers 1	Ind: 2 FS=1 Type: L2	P052 = 3 P051 = 40 Offline
P686 * BDS (G181)	Source for control word 2, bit26 (0=external fault 2, 1=no external fault 2)	All binector numbers 1	Ind: 2 FS=1 Type: L2	P052 = 3 P051 = 40 Offline
P687 * BDS (G181)	Source for control word 2, bit27 (0=master drive, speed control, 1=slave drive, torque control)	All binector numbers 1	Ind: 2 FS=0 Type: L2	P052 = 3 P051 = 40 Offline
P688 * BDS (G181)	Source for control word 2, bit28 (0=external alarm 1, 1=no external alarm 1)	All binector numbers 1	Ind: 2 FS=1 Type: L2	P052 = 3 P051 = 40 Offline

PNU	Description	Value range [Unit] Steps	No. indices Factory setting Type	See Change (Access / Status)
P689 * BDS (G181)	Source for control word 2, bit29 (0=external alarm 2, 1=no external alarm 2)	All binector numbers 1	Ind: 2 FS=1 Type: L2	P052 = 3 P051 = 40 Offline
P690 * (G181)	Source for control word 2, bit30 (0=select Bico data set 1, 1=select Bico data set 2)	All binector numbers 1	Ind: None FS=0 Type: L2	P052 = 3 P051 = 40 Offline
P691 * BDS (G181)	Source for control word 2, Bit31 [SW 1.8 and later] Main contactor checkback signal: (0 = main contactor dropped out, 1 = main contactor picked up) This control input is intended as a means of looping an auxiliary contact of the main contactor into the device control. During the Power ON routine, this signal must switch to "1" within the time period set in P095. If it does not, or it disappears during operation, fault message F004 with fault value 6 is activated. P691 = 0: Bit 31 of control word 2 is inoperative. (This setting of P691 is always active, regardless of whether control word 2 is input in word mode [P649 = 9] or bit mode [P649 <> 9]) P691 = 1: Bit 31 of control word 2 is inoperative. (This setting of P691 is active only when control word 2 is input in bit mode, i.e. when P649 <> 9)	All binector numbers 1	Ind: 2 FS=0 Type: L2	P052 = 3 P051 = 40 Offline

10.36 Further configuring measures

P692 * BDS (G166)	Source for selection of injection of standstill field Selection of binector to control injection of the standstill field ("0" state = inject standstill field) Note: The delay time set in P258 is not effective when this function is active. 0 = binector B0000 1 = binector B0001 etc.	All binector numbers 1	Ind: 2 FS=0 Type: L2	P052 = 3 P051 = 40 Offline
P693 * BDS (G165)	Source for selection of enabling command for EMF controller Selection of binector which is to control enabling of the EMF controller 0 = binector B0000 1 = binector B0001 etc.	All binector numbers 1	Ind: 2 FS=1 Type: L2	P052 = 3 P051 = 40 Offline
P694 * BDS (G160)	Source for selection of enabling command for "Torque limit switchover" Selection of binector which is to control enabling of the "Torque limit switchover" function (1=enable, see also Sheet G160 in Section 8 of Operating Instructions 6RX1700-0AD** and P180 to P183) 0 = binector B0000 1 = binector B0001 etc.	All binector numbers 1	Ind: 2 FS=0 Type: L2	P052 = 3 P051 = 40 Offline
P695 * BDS (G152)	Source for selection of "Set speed controller I component" function Selection of binector to control the "Set I component" function 0 = binector B0000 1 = binector B0001 etc. When the binector selected in P695 switches from log. "0" to log. "1", the I component of the speed controller is set to the value of the connector selected in P631. With this function it is possible, for example, to use the same signal (binector) to control controller enabling commands and setting of the I component.	All binector numbers 1	Ind: 2 FS=0 Type: L2	P052 = 3 P051 = 40 Offline

PNU	Description	Value range [Unit] Steps	No. indices Factory setting Type	See Change (Access / Status)
P696 * BDS (G152)	Source for selection of "Stop speed controller I component" function Selection of binector to control the "Stop I component" function 0 = binector B0000 1 = binector B0001 etc. When the binector selected in P696 changes to the log. "1" state, the I component of the speed controller is stopped.	All binector numbers 1	Ind: 2 FS=0 Type: L2	P052 = 3 P051 = 40 Offline
P697 * BDS (G153)	Source for selection of enabling of dv/dt injection Selection of binector to control enabling of dv/dt injection (state "1" = enable) 0 = binector B0000 1 = binector B0001 etc.	All binector numbers 1	Ind: 2 FS=1 Type: L2	P052 = 3 P051 = 40 Offline
P698 * BDS (G152)	Source for selection of enabling command for speed-dependent speed controller PI / P function switchover Selection of binector to control enabling of the speed-dependent PI / P controller switchover function (see also P222) 0 = binector B0000 1 = binector B0001 etc.	All binector numbers 1	Ind: 2 FS=1 Type: L2	P052 = 3 P051 = 40 Offline

10.37 Analog inputs (main actual value, main setpoint, selectable inputs)

(see also Section 8, Sheets G113 and G114 of Operating Instructions 6RX1700-0AD**)

Analog input terminals 4 / 5 (main setpoint)				
P700 * (G113)	Signal type of "Main setpoint" analog input 0 = Voltage input 0 to ±10 V 1 = Current input 0 to ±20 mA 2 = Current input 4 to 20 mA	0 to 2 1	Ind: None FS=0 Type: O2	P052 = 3 P051 = 40 Offline
P701 FDS (G113)	Normalization of "Main setpoint" analog input This parameter specifies the percentage value which is generated for an input voltage of 10V (or an input current of 20mA) at the analog input. The following generally applies: For voltage input: $P701 [\%] = 10 V * \frac{Y}{X}$ X .. Input voltage in volts Y .. % value which is generated for input voltage X With current input: $P701 [\%] = 20 mA * \frac{Y}{X}$ X .. Input current in mA Y .. % value which is generated for input current X	-1000.0 to 1000.0 [%] 0.1%	Ind: 4 FS=100.0 Type: I2	P052 = 3 P051 = 40 Online
P702 (G113)	Offset for "Main setpoint" analog input	-200.00 to 199.99 [%] 0.01%	Ind: None FS=0.00 Type: I2	P052 = 3 P051 = 40 Online
P703 * (G113)	Mode of signal injection at "Main setpoint" analog input 0 = Injection of signal with sign 1 = Injection of absolute value of signal 2 = Injection of signal with sign, inverted 3 = Injection of absolute value of signal, inverted	0 to 3 1	Ind: None FS=0 Type: O2	P052 = 3 P051 = 40 Offline
P704 * (G113)	Source for selection of sign reversal at "Main setpoint" analog input Selection of binector to control sign reversal at the analog input ("1" state = reverse sign) 0 = binector B0000 1 = binector B0001 etc.	All binector numbers 1	Ind: None FS=0 Type: L2	P052 = 3 P051 = 40 Offline
P705 (G113)	Filtering time for "Main setpoint" analog input Note: Hardware filtering of approximately 1 ms is applied as standard.	0 to 10000 [ms] 1ms	Ind: None FS=0 Type: O2	P052 = 3 P051 = 40 Online

PNU	Description	Value range [Unit] Steps	No. indices Factory setting Type	See Change (Access / Status)																				
P706 * (G113)	Source for enabling of "Main setpoint" analog input Selection of binector to control enabling of the analog input ("1" state = enabled) 0 = binector B0000 1 = binector B0001 etc.	All binector numbers 1	Ind: None FS=1 Type: L2	P052 = 3 P051 = 40 Offline																				
P707 * (G113)	Resolution of "Main setpoint" analog input The voltage applied to the analog input is converted to a digital value (A/D conversion) for further processing. The method used calculates an average value of the input voltage over a specific measuring time. The A/D conversion process produces a scale for the voltage range of 0 to ± 10V, the number of steps (divisions) along this scale can be set in P707 (i.e. the smallest possible differentiable change in the input voltage (quantization) can be set in this parameter). The number of scale steps or intervals is referred to as "Resolution". The resolution is normally specified in bits: ± 11 bits means 2 * 2048 scale divisions ± 12 bits means 2 * 4096 scale divisions ± 13 bits means 2 * 8192 scale divisions ± 14 bits means 2 * 16384 scale divisions The following applies: The higher the resolution, the longer the averaging time and thus also the delay period between the application of an analog step change and the earliest possible moment of availability of the digital value for further processing. For this reason, it is important to find a compromise between the resolution and delay period. <table border="1" style="margin-left: 40px;"> <thead> <tr> <th>Param. value</th> <th>Resolution better than</th> <th>Quantization</th> <th>Delay period</th> </tr> </thead> <tbody> <tr> <td>11</td> <td>± 11 bits</td> <td>4.4 mV</td> <td>0.53 ms</td> </tr> <tr> <td>12</td> <td>± 12 bits</td> <td>2.2 mV</td> <td>0.95 ms</td> </tr> <tr> <td>13</td> <td>± 13 bits</td> <td>1.1 mV</td> <td>1.81 ms</td> </tr> <tr> <td>14</td> <td>± 14 bits</td> <td>0.56 mV</td> <td>3.51 ms</td> </tr> </tbody> </table> If the analog input is operating as a current input (0 to 20 mA or 4 to 20 mA), the above applies analogously.	Param. value	Resolution better than	Quantization	Delay period	11	± 11 bits	4.4 mV	0.53 ms	12	± 12 bits	2.2 mV	0.95 ms	13	± 13 bits	1.1 mV	1.81 ms	14	± 14 bits	0.56 mV	3.51 ms	11 to 14 [Bit] 1 bit	Ind: None FS=12 Type: O2	P052 = 3 P051 = 40 Offline
Param. value	Resolution better than	Quantization	Delay period																					
11	± 11 bits	4.4 mV	0.53 ms																					
12	± 12 bits	2.2 mV	0.95 ms																					
13	± 13 bits	1.1 mV	1.81 ms																					
14	± 14 bits	0.56 mV	3.51 ms																					

Analog input terminals 6 / 7 (analog selectable input 1)				
P710 * (G113)	Signal type of "Analog selectable input 1" 0 = Voltage input 0 to ±10 V 1 = Current input 0 to ±20 mA 2 = Current input 4 to 20 mA	0 to 2 1	Ind: None FS=0 Type: O2	P052 = 3 P051 = 40 Offline
P711 FDS (G113)	Normalization of "Analog selectable input 1" This parameter specifies the percentage value which is generated for an input voltage of 10V (or an input current of 20mA) at the analog input. The following generally applies: For voltage input: $P711 [\%] = 10 V * \frac{Y}{X}$ X .. Input voltage in volts Y .. % value which is generated for input voltage X With current input: $P711 [\%] = 20 mA * \frac{Y}{X}$ X .. Input current in mA Y .. % value which is generated for input current X	-1000.0 to 1000.0 [%] 0.1%	Ind: 4 FS=100.0 Type: I2	P052 = 3 P051 = 40 Online
P712 (G113)	Offset for "Analog selectable input 1"	-200.00 to 199.99 [%] 0.01%	Ind: None FS=0.00 Type: I2	P052 = 3 P051 = 40 Online
P713 * (G113)	Mode of signal injection at "Analog selectable input 1" 0 = Injection of signal with sign 1 = Injection of absolute value of signal 2 = Injection of signal with sign, inverted 3 = Injection of absolute value of signal, inverted	0 to 3 1	Ind: None FS=0 Type: O2	P052 = 3 P051 = 40 Offline

PNU	Description	Value range [Unit] Steps	No. indices Factory setting Type	See Change (Access / Status)
P714 * (G113)	Source for selection of sign reversal at "Analog selectable input 1" Selection of binector to control sign reversal at the analog input ("1" state = reverse sign) 0 = binector B0000 1 = binector B0001 etc.	All binector numbers 1	Ind: None FS=0 Type: L2	P052 = 3 P051 = 40 Offline
P715 (G113)	Filtering time for "Analog selectable input 1" Note: Hardware filtering of approximately 1 ms is applied as standard.	0 to 10000 [ms] 1ms	Ind: None FS=0 Type: O2	P052 = 3 P051 = 40 Online
P716 * (G113)	Source for enabling of "Analog selectable input 1" Selection of binector to control enabling of the analog input ("1" state = enabled) 0 = binector B0000 1 = binector B0001 etc.	All binector numbers 1	Ind: None FS=1 Type: L2	P052 = 3 P051 = 40 Offline
P717 * (G113)	Resolution of "Analog selectable input 1" See P707	10 to 14 [Bit] 1 bit	Ind: None FS=12 Type: O2	P052 = 3 P051 = 40 Offline

Analog input terminals 8 / 9 (analog selectable input 2)

P721 FDS (G114)	Normalization of "Analog selectable input 2" This parameter specifies the percentage value which is generated for an input voltage of 10V (or an input current of 20mA) at the analog input. The following generally applies: For voltage input: $P721 [\%] = 10 V * \frac{Y}{X}$ X .. Input voltage in volts Y .. % value which is generated for input voltage X With current input: $P721 [\%] = 20 mA * \frac{Y}{X}$ X .. Input current in mA Y .. % value which is generated for input current X	-1000.0 to 1000.0 [%] 0.1%	Ind: 4 FS=100.0 Type: I2	P052 = 3 P051 = 40 Online
P722 (G114)	Offset for "Analog selectable input 2"	-200.00 to 199.99 [%] 0.01%	Ind: None FS=0.00 Type: I2	P052 = 3 P051 = 40 Online
P723 * (G114)	Mode of signal injection at "Analog selectable input 2" 0 = Injection of signal with sign 1 = Injection of absolute value of signal 2 = Injection of signal with sign, inverted 3 = Injection of absolute value of signal, inverted	0 to 3 1	Ind: None FS=0 Type: O2	P052 = 3 P051 = 40 Offline
P724 * (G114)	Source for selection of sign reversal at "Analog selectable input 2" Selection of binector to control sign reversal at the analog input ("1" state = reverse sign) 0 = binector B0000 1 = binector B0001 etc.	All binector numbers 1	Ind: None FS=0 Type: L2	P052 = 3 P051 = 40 Offline
P725 (G114)	Filtering time for "Analog selectable input 2" Note: Hardware filtering of approximately 1 ms is applied as standard.	0 to 10000 [ms] 1ms	Ind: None FS=0 Type: O2	P052 = 3 P051 = 40 Online
P726 * (G114)	Source for enabling of "Analog selectable input 2" Selection of binector to control enabling of the analog input ("1" state = enabled) 0 = binector B0000 1 = binector B0001 etc.	All binector numbers 1	Ind: None FS=1 Type: L2	P052 = 3 P051 = 40 Offline

PNU	Description	Value range [Unit] Steps	No. indices Factory setting Type	See Change (Access / Status)
Analog input terminals 10 / 11 (analog selectable input 3)				
P731 FDS (G114)	Normalization of "Analog selectable input 3" This parameter specifies the percentage value which is generated for an input voltage of 10V (or an input current of 20mA) at the analog input. The following generally applies: For voltage input: $P731 [\%] = 10 V * \frac{Y}{X}$ X .. Input voltage in volts Y .. % value which is generated for input voltage X With current input: $P731 [\%] = 20 mA * \frac{Y}{X}$ X .. Input current in mA Y .. % value which is generated for input current X	-1000.0 to 1000.0 [%] 0.1%	Ind: 4 FS=100.0 Type: I2	P052 = 3 P051 = 40 Online
P732 (G114)	Offset for "Analog selectable input 3"	-200.00 to 199.99 [%] 0.01%	Ind: None FS=0.00 Type: I2	P052 = 3 P051 = 40 Online
P733 * (G114)	Mode of signal injection at "Analog selectable input 3" 0 = Injection of signal with sign 1 = Injection of absolute value of signal 2 = Injection of signal with sign, inverted 3 = Injection of absolute value of signal, inverted	0 to 3 1	Ind: None FS=0 Type: O2	P052 = 3 P051 = 40 Offline
P734 * (G114)	Source for selection of sign reversal at "Analog selectable input 3" Selection of binector to control sign reversal at the analog input ("1" state = reverse sign) 0 = binector B0000 1 = binector B0001 etc.	All binector numbers 1	Ind: None FS=0 Type: L2	P052 = 3 P051 = 40 Offline
P735 (G114)	Filtering time for "Analog selectable input 3" Note: Hardware filtering of approximately 1 ms is applied as standard.	0 to 10000 [ms] 1ms	Ind: None FS=0 Type: O2	P052 = 3 P051 = 40 Online
P736 * (G114)	Source for enabling of "Analog selectable input 3" Selection of binector to control enabling of the analog input ("1" state = enabled) 0 = binector B0000 1 = binector B0001 etc.	All binector numbers 1	Ind: None FS=1 Type: L2	P052 = 3 P051 = 40 Offline

Analog input terminals 103 / 104 (main actual value)				
P741 FDS (G113)	Normalization for "Main actual value" Rated value of input voltage at n_{max} (=tachometer voltage at maximum speed) This parameter defines the maximum speed when P083=1.	-270.00 to 270.00 [V] 0.01V	Ind: 4 FS=60.00 Type: I2	P052 = 3 P051 = 40 Online
P742 (G113)	Offset for "Main actual value" analog input	-200.00 to 199.99 [%] 0.01%	Ind: None FS=0.00 Type: I2	P052 = 3 P051 = 40 Online
P743 * (G113)	Mode of signal injection at "Main actual value" analog input 0 = Injection of signal with sign 1 = Injection of absolute value of signal 2 = Injection of signal with sign, inverted 3 = Injection of absolute value of signal, inverted	0 to 3 1	Ind: None FS=0 Type: O2	P052 = 3 P051 = 40 Offline
P744 * (G113)	Source for selection of sign reversal at "Main actual value" analog input Selection of binector to control sign reversal at the analog input ("1" state = reverse sign) 0 = binector B0000 1 = binector B0001 etc.	All binector numbers 1	Ind: None FS=0 Type: L2	P052 = 3 P051 = 40 Offline
P745 (G113)	Filtering time for "Main actual value" analog input Note: Hardware filtering of approximately 1 ms is applied as standard.	0 to 10000 [ms] 1ms	Ind: None FS=0 Type: O2	P052 = 3 P051 = 40 Online

PNU	Description	Value range [Unit] Steps	No. indices Factory setting Type	See Change (Access / Status)
P746* (G113)	Source for enabling of "Main actual value" analog input Selection of binector to control enabling of the analog input ("1" state = enabled) 0 = binector B0000 1 = binector B0001 etc.	All binector numbers 1	Ind: None FS=1 Type: L2	P052 = 3 P051 = 40 Offline

10.38 Analog outputs

(see also Section 8, Sheets G115 and G116 of Operating Instructions 6RX1700-0AD**)

Analog output terminals 12 / 13 (actual current display)				
P749* (G115)	Control word for terminal 12 (actual current display) 0 Output with correct sign (positive voltage: Current in torque direction MI) (negative voltage: Current in torque direction MII) 1 Output of absolute value (positive voltage only) 2 Output with sign, inverted (positive voltage: Current in torque direction MII) (negative voltage: Current in torque direction MI) 3 Output of absolute value, inverted (negative voltage only)	0 to 3 1	Ind: None FS=0 Type: O2	P052 = 3 P051 = 40 Online

Analog output terminals 14 / 15				
P750* (G115)	Source for output value at analog output 1 Selection of connector whose value is to applied to the analog output 0 = connector K0000 1 = connector K0001 etc.	All connector numbers 1	Ind: None FS=0 Type: L2	P052 = 3 P051 = 40 Online
P751* (G115)	Mode of signal injection at analog output 1 0 = Injection of signal with correct sign 1 = Injection of absolute value of signal 2 = Injection of signal with sign, inverted 3 = Injection of absolute value of signal, inverted	0 to 3 1	Ind: None FS=0 Type: O2	P052 = 3 P051 = 40 Online
P752 (G115)	Filtering time for analog output 1	0 to 10000 [ms] 1ms	Ind: None FS=0 Type: O2	P052 = 3 P051 = 40 Online
P753 (G115)	Normalization of analog output 1 $y[V] = x * \frac{P753}{100\%}$ x = Normalization input (corresponds to filtering output) y = Normalization output (corresponds to output voltage at analog output with offset = 0)	-200.00 to 199.99 [V] 0.01V	Ind: None FS=10.00 Type: I2	P052 = 3 P051 = 40 Online
P754 (G115)	Offset for analog output 1	-10.00 to 10.00 [V] 0.01V	Ind: None FS=0.00 Type: I2	P052 = 3 P051 = 40 Online

Analog output terminals 16 / 17				
P755* (G115)	Source for output value at analog output 2 Selection of connector whose value is to applied to the analog output 0 = connector K0000 1 = connector K0001 etc.	All connector numbers 1	Ind: None FS=0 Type: L2	P052 = 3 P051 = 40 Online
P756* (G115)	Mode of signal injection at analog output 2 0 = Injection of signal with correct sign 1 = Injection of absolute value of signal 2 = Injection of signal with sign, inverted 3 = Injection of absolute value of signal, inverted	0 to 3 1	Ind: None FS=0 Type: O2	P052 = 3 P051 = 40 Online
P757 (G115)	Filtering time for analog output 2	0 to 10000 [ms] 1ms	Ind: None FS=0 Type: O2	P052 = 3 P051 = 40 Online

PNU	Description	Value range [Unit] Steps	No. indices Factory setting Type	See Change (Access / Status)
P758 (G115)	Normalization of analog output 2 $y[V] = x * \frac{P758}{100 \%}$ x = Normalization input (corresponds to filtering output) y = Normalization output (corresponds to output voltage at analog output with offset = 0)	-200.00 to 199.99 [V] 0.01V	Ind: None FS=10.00 Type: I2	P052 = 3 P051 = 40 Online
P759 (G115)	Offset for analog output 2	-10.00 to 10.00 [V] 0.01V	Ind: None FS=0.00 Type: I2	P052 = 3 P051 = 40 Online

Analog output terminals 18 / 19

P760 * (G116)	Source for output value at analog output 3 Selection of connector whose value is to be applied to the analog output 0 = connector K0000 1 = connector K0001 etc.	All connector numbers 1	Ind: None FS=0 Type: L2	P052 = 3 P051 = 40 Online
P761 * (G116)	Mode of signal injection at analog output 3 0 = Injection of signal with correct sign 1 = Injection of absolute value of signal 2 = Injection of signal with sign, inverted 3 = Injection of absolute value of signal, inverted	0 to 3 1	Ind: None FS=0 Type: O2	P052 = 3 P051 = 40 Online
P762 (G116)	Filtering time for analog output 3	0 to 10000 [ms] 1ms	Ind: None FS=0 Type: O2	P052 = 3 P051 = 40 Online
P763 (G116)	Normalization of analog output 3 $y[V] = x * \frac{P763}{100 \%}$ x = Normalization input (corresponds to filtering output) y = Normalization output (corresponds to output voltage at analog output with offset = 0)	-200.00 to 199.99 [V] 0.01V	Ind: None FS=10.00 Type: I2	P052 = 3 P051 = 40 Online
P764 (G116)	Offset for analog output 3	-10.00 to 10.00 [V] 0.01V	Ind: None FS=0.00 Type: I2	P052 = 3 P051 = 40 Online

Analog output terminals 20 / 21

P765 * (G116)	Source for output value at analog output 4 Selection of connector whose value is to be applied to the analog output 0 = connector K0000 1 = connector K0001 etc.	All connector numbers 1	Ind: None FS=0 Type: L2	P052 = 3 P051 = 40 Online
P766 * (G116)	Mode of signal injection at analog output 4 0 = Injection of signal with correct sign 1 = Injection of absolute value of signal 2 = Injection of signal with sign, inverted 3 = Injection of absolute value of signal, inverted	0 to 3 1	Ind: None FS=0 Type: O2	P052 = 3 P051 = 40 Online
P767 (G116)	Filtering time for analog output 4	0 to 10000 [ms] 1ms	Ind: None FS=0 Type: O2	P052 = 3 P051 = 40 Online
P768 (G116)	Normalization of analog output 4 $y[V] = x * \frac{P768}{100 \%}$ x = Normalization input (corresponds to filtering output) y = Normalization output (corresponds to output voltage at analog output with offset = 0)	-200.00 to 199.99 [V] 0.01V	Ind: None FS=10.00 Type: I2	P052 = 3 P051 = 40 Online
P769 (G116)	Offset for analog output 4	-10.00 to 10.00 [V] 0.01V	Ind: None FS=0.00 Type: I2	P052 = 3 P051 = 40 Online

PNU	Description	Value range [Unit] Steps	No. indices Factory setting Type	See Change (Access / Status)
-----	-------------	--------------------------------	---	---------------------------------------

10.39 Binary outputs

(see also Section 8, Sheet G112 of Operating Instructions 6RX1700-0AD**)

P770 * (G112) (G200)	Control word for binary selectable outputs i001: 0 Binary selectable output at terminal 46 is not inverted 1 Binary selectable output at terminal 46 is inverted i002: 0 Binary selectable output at terminal 48 is not inverted 1 Binary selectable output at terminal 48 is inverted i003: 0 Binary selectable output at terminal 50 is not inverted 1 Binary selectable output at terminal 50 is inverted i004: 0 Binary selectable output at terminal 52 is not inverted 1 Binary selectable output at terminal 52 is inverted	0 to 1 1	Ind: 4 FS=0 Type: O2	P052 = 3 P051 = 40 Online
P771 * (G112) (G200)	Source for output value at binary output 1 Selection of binector to be injected at binary selectable output, terminal 46 0 = binector B0000 1 = binector B0001 etc.	All binector numbers 1	Ind: None FS=0 Type: L2	P052 = 3 P051 = 40 Online
P772 * (G112) (G200)	Source for output value at binary output 2 Selection of binector to be injected at binary selectable output, terminal 48 0 = binector B0000 1 = binector B0001 etc.	All binector numbers 1	Ind: None FS=0 Type: L2	P052 = 3 P051 = 40 Online
P773 * (G112)	Source for output value at binary output 3 Selection of binector to be injected at binary selectable output, terminal 50 0 = binector B0000 1 = binector B0001 etc.	All binector numbers 1	Ind: None FS=0 Type: L2	P052 = 3 P051 = 40 Online
P774 * (G112)	Source for output value at binary output 4 Selection of binector to be injected at binary selectable output, terminal 52 0 = binector B0000 1 = binector B0001 etc.	All binector numbers 1	Ind: None FS=0 Type: L2	P052 = 3 P051 = 40 Online
P775 (G112) (G200)	Delay for output value at binary output 1 The logic level at the binary selectable output changes only if the internal signal level remains constant for the set delay period (internal signal level changes which do not last as long as this delay period are not switched through to the output)	0 to 10000 [ms] 1ms	Ind: None FS=0 Type: O2	P052 = 3 P051 = 40 Online
P776 (G112) (G200)	Delay for output value at binary output 2 The logic level at the binary selectable output changes only if the internal signal level remains constant for the set delay period (internal signal level changes which do not last as long as this delay period are not switched through to the output)	0 to 10000 [ms] 1ms	Ind: None FS=0 Type: O2	P052 = 3 P051 = 40 Online
P777 (G112)	Delay for output value at binary output 3 The logic level at the binary selectable output changes only if the internal signal level remains constant for the set delay period (internal signal level changes which do not last as long as this delay period are not switched through to the output)	0 to 10000 [ms] 1ms	Ind: None FS=0 Type: O2	P052 = 3 P051 = 40 Online
P778 (G112)	Delay for output value at binary output 4 The logic level at the binary selectable output changes only if the internal signal level remains constant for the set delay period (internal signal level changes which do not last as long as this delay period are not switched through to the output)	0 to 10000 [ms] 1ms	Ind: None FS=0 Type: O2	P052 = 3 P051 = 40 Online

PNU	Description	Value range [Unit] Steps	No. indices Factory setting Type	See Change (Access / Status)
-----	-------------	--------------------------	----------------------------------	------------------------------

10.40 Configuration of serial interfaces on basic converter

G-SST 1 (RS485 / RS232 on X300) (see also Section 8, Sheet G170 and Section 9 of Operating Instructions 6RX1700-0AD**)				
P780 * (G170)	Selection of protocol for G-SST1 basic converter interface 0 Setting has no function 2 USS protocol for factory purposes 8 For internal factory test purposes	0, 2, 8, 9 1	Ind: None FS=2 Type: O2	P052 = 3 P051 = 40 Offline
P781 * (G170)	Number of process data for G-SST1 <u>When P780 = 0 or 9 is selected:</u> Parameter is irrelevant <u>When USS protocol (P780=2) is selected:</u> Number of PZD elements 0 No process data are expected or sent in the USS protocol 1...16 Number of process data words in USS protocol (same number applies to transmission and receipt) The received PZD elements (1 to max. 16) are available at connectors (K2001 to K2016) and, in some cases, bit-serially at binectors for "internal wiring" purposes. The PZD elements to be transmitted (1 to max. 16) are selected in parameters P784.01 to P784.16.	0 to 16 1	Ind: None FS=2 Type: O2	P052 = 3 P051 = 40 Offline
P782 * (G170)	Length of parameter jobs for G-SST1 This parameter is effective only when P780=2 (USS protocol). 0 <u>No PKW data</u> are expected or sent in the USS protocol. 3, 4 <u>3 or 4 PKW data words</u> are expected in the USS protocol and 3 or 4 PKW data words are also sent (for transmission of parameter values). 127 Number of PKWs is determined by the telegram length	0, 3, 4, 127 1	Ind: None FS=127 Type: O2	P052 = 3 P051 = 40 Offline
P783 * (G170)	Baud rate for G-SST1 1 300 baud 2 600 baud 3 1200 baud 4 2400 baud 5 4800 baud 6 9600 baud 7 19200 baud 8 38400 baud 9 56700 baud 11 93750 baud 13 187500 baud	1 to 13 1	Ind: None FS=6 Type: O2	P052 = 3 P051 = 40 Offline
P784 * (G170)	Source for transmit data for G-SST1 Selection of connectors to be transferred as transmit data to the USS master via USS interface 1. i001: Selection for word 1 i002: Selection for word 2 ... i016: Selection for word 16 Applicable settings: 0 = connector K0000 1 = connector K0001 etc.	All connector numbers 1	Ind: 16 FS= i001: 32 i002: 167 i003: 0 i004: 33 i005-i016: 0 Type: L2	P052 = 3 P051 = 40 Offline
P785 (G170)	Options for G-SST1 i001: 0 = Bus terminator OFF 1 = Bus terminator ON i002: 0 = Bit 10 of the 1 st receive word does <u>not</u> function as "Control by PLC". 1 = Bit 10 of the 1 st receive word does function as "Control by PLC", i.e. when bit 10 = 0, all other bits of the 1 st receive word, as well as receive words 2 to 16, are <u>not</u> written to connectors K2001 to K2016, or to binectors B2100 to B2915. All these connectors and binectors retain their old values.	0 to 1 1	Ind: 2 FS=0 Type: O2	P052 = 3 P051 = 40 Offline

PNU	Description	Value range [Unit] Steps	No. indices Factory setting Type	See Change (Access / Status)
P786 * (G170)	USS bus address for G-SST1 This parameter is functional only when P780=2 (USS protocol). Address via which the unit can be addressed in USS bus operation.	0 to 30 1	Ind: None FS=0 Type: O2	P052 = 3 P051 = 40 Offline
P787 (G170)	Telegram failure time for G-SST1 The failure time set in this parameter is valid when setting P780=2 (USS protocol) is selected. 0.000 No time monitoring 0.001...65.000 Time which may elapse between the receipt of two telegrams addressed to the unit before a fault message is activated. Fault message F011 is activated if no valid telegram is received within this time period. Note: The telegram monitoring function is active • from the receipt of the first error-free telegram after connection of the electronics power supply • from the receipt of the first error-free telegram after the telegram monitor has responded (i.e. monitoring timeout).	0.000 to 65.000 [s] 0.001s	Ind: None FS=0.000 Type: O2	P052 = 3 P051 = 40 Offline
P788 * (G170)	Source for activation of F011 Selection of binector which will activate fault message F011 when it switches to log. "1" 2030 = binector B2030 2031 = binector B2031	2030, 2031	Ind: None FS=2030 Type: L2	P052 = 3 P051 = 40 Offline
r789 (G170)	Diagnostic information for G-SST1 Free-running counter, overflow at 65535 i001: Number of <u>error-free</u> telegrams i002: Number of <u>errored</u> telegrams: Byte frame, parity, overrun or BCC error i003: Number of byte frame errors i004: Number of overrun errors i005: Parity error i006: STX error: Start interval before STX not observed, telegram residual transfer time not observed, delay time of LGE character too long, erroneous STX, i.e. ≠ 02 i007: Violation of telegram residual transfer time i008: Block check error i009: Incorrect telegram length: With P782=3 or 4 only: The length of the received telegram is ≠ P781 + P782 (Note: If the received values are correct, they will be processed even when this error has been detected) i010: Timeout error: No valid telegram has been received for a period exceeding the setting in P787. After the occurrence of a timeout error, this counter is not activated again until the next valid telegram is received.		Ind: 10 Type: O2	P052 = 3

G-SST 2 (RS485 on X172) (see also Section 8, Sheets G171 and G173 and Section 9 of Operating Instructions 6RX1700-0AD**))

P790 * (G171) (G173)	Selection of protocol for G-SST2 basic converter interface 0 Setting has no function 2 USS protocol 5 "Peer-to-peer" communication 9 For internal factory test purposes	0, 2, 5, 9 1	Ind: None FS=0 Type: O2	P052 = 3 P051 = 40 Offline
--------------------------------------	--	-----------------	-------------------------------	----------------------------------

PNU	Description	Value range [Unit] Steps	No. indices Factory setting Type	See Change (Access / Status)
P791 * (G171) (G173)	<p>Number of process data for G-SST2</p> <p><u>When P790 = 0 or 9 is selected:</u> Parameter is irrelevant</p> <p><u>When USS protocol (P790=2) is selected:</u> Number of PZD elements</p> <p>0 No process data are expected or sent in the USS protocol</p> <p>1...16 Number of process data words in USS protocol (same number applies to transmission and receipt) The received PZD elements (1 to max. 16) are available at connectors (K6001 to K6016) and, in some cases, bit-serially at binectors for "internal wiring" purposes. The PZD elements to be transmitted (1 to max. 16) are selected in parameters P794.01 to P794.16.</p> <p><u>When peer-to-peer (P790= 5) is selected:</u> Number of transferred words</p> <p>0 Illegal setting</p> <p>1...5 Number of transferred words</p> <p>6...16 Illegal setting</p>	0 to 16 1	Ind: None FS=2 Type: O2	P052 = 3 P051 = 40 Offline
P792 * (G171)	<p>Length of parameter jobs for G-SST2</p> <p>This parameter is effective only when P790=2 (USS protocol).</p> <p>0 No <u>PKW data</u> are expected or sent in the USS protocol.</p> <p>3, 4 <u>3 or 4 PKW data words</u> are expected in the USS protocol and 3 or 4 PKW data words are also sent (for transmission of parameter values).</p> <p>127 Number of PKWs is determined by the telegram length</p>	0, 3, 4, 127 1	Ind: None FS=127 Type: O2	P052 = 3 P051 = 40 Offline
P793 * (G171) (G173)	<p>Baud rate for G-SST2</p> <p>1 300 baud</p> <p>2 600 baud</p> <p>3 1200 baud</p> <p>4 2400 baud</p> <p>5 4800 baud</p> <p>6 9600 baud</p> <p>7 19200 baud</p> <p>8 38400 baud</p> <p>9 56700 baud</p> <p>11 93750 baud</p> <p>13 187500 baud</p>	1 to 13 1	Ind: None FS=6 Type: O2	P052 = 3 P051 = 40 Offline
P794 * (G171) (G173)	<p>Source for transmit data for G-SST2</p> <p>Selection of connectors to be transferred as <u>transmit data</u> via basic converter interface 2</p> <p><u>When USS protocol (P790=2) is selected:</u></p> <p>i001: Selection for word 1</p> <p>i002: Selection for word 2</p> <p>...</p> <p>i016: Selection for word 16</p> <p><u>When peer-to-peer (P790=5) is selected:</u></p> <p>i001: Selection for word 1</p> <p>i002: Selection for word 2</p> <p>...</p> <p>i005: Selection for word 5</p> <p>i006: Not used</p> <p>...</p> <p>i016: Not used</p> <p>Applicable settings:</p> <p>0 = connector K0000</p> <p>1 = connector K0001</p> <p>etc.</p>	All connector numbers 1	Ind: 16 FS= i001: 32 i002: 167 i003: 0 i004: 33 i005-i016: 0 Type: L2	P052 = 3 P051 = 40 Offline

PNU	Description	Value range [Unit] Steps	No. indices Factory setting Type	See Change (Access / Status)												
P795 (G171) (G173)	<p>Options for G-SST2</p> <p>i001: 0 = Bus terminator OFF 1 = Bus terminator ON</p> <p>i002: 0 = Bit 10 of the 1st receive word does <u>not</u> function as "Control by PLC". 1 = Bit 10 of the 1st receive word does function as "Control by PLC", i.e. when bit 10 = 0, all other bits of the 1st receive word, as well as receive words 2 to 16, are <u>not</u> written to connectors K6001 to K6016, or to binectors B6100 to B6915. All these connectors and binectors retain their old values.</p>	0 to 1 1	Ind: 2 FS=0 Type: O2	P052 = 3 P051 = 40 Offline												
P796 *(G171)	<p>USS bus address for G-SST2</p> <p>This parameter is functional only when P790=2 (USS protocol). Address via which the unit can be addressed in USS bus operation.</p>	0 to 30 1	Ind: None FS=0 Type: O2	P052 = 3 P051 = 40 Offline												
P797 (G171) (G173)	<p>Telegram failure time for G-SST2</p> <p>The failure time set in this parameter is valid when setting P790=2 (USS protocol) or P790=5 (peer-to-peer) is selected.</p> <p>0.000 No time monitoring 0.001...65.000 Time which may elapse between the receipt of two telegrams addressed to the unit before a fault message is activated.</p> <p>Fault message F012 is activated if no valid telegram is received within this time period.</p> <p>Note: The telegram monitoring function is active</p> <ul style="list-style-type: none"> from the receipt of the first error-free telegram after connection of the electronics power supply from the receipt of the first error-free telegram after the telegram monitor has responded (i.e. monitoring timeout). <p>Since the telegram transfer time is dependent on the set baud rate, the following minimum setting values for P797 are recommended:</p> <table border="0"> <tr> <td>Baud rate as set in P793:</td> <td>Recommended minimum value for P797:</td> </tr> <tr> <td>300 baud</td> <td>0.520s</td> </tr> <tr> <td>600 baud</td> <td>0.260s</td> </tr> <tr> <td>1200 baud</td> <td>0.140s</td> </tr> <tr> <td>2400 baud</td> <td>0.080s</td> </tr> <tr> <td>≥ 4800 baud</td> <td>0.040s</td> </tr> </table> <p>Note: If the "Automatic restart" function is selected (P086>0) on the peer-to-peer communication partner, then only a parameter setting of P797>P086 (on the communication partner) is meaningful.</p>	Baud rate as set in P793:	Recommended minimum value for P797:	300 baud	0.520s	600 baud	0.260s	1200 baud	0.140s	2400 baud	0.080s	≥ 4800 baud	0.040s	0.000 to 65.000 [s] 0.001s	Ind: None FS=0.000 Type: O2	P052 = 3 P051 = 40 Offline
Baud rate as set in P793:	Recommended minimum value for P797:															
300 baud	0.520s															
600 baud	0.260s															
1200 baud	0.140s															
2400 baud	0.080s															
≥ 4800 baud	0.040s															
P798 *(G171) (G173)	<p>Source for activation of F012</p> <p>Selection of binector which will activate fault message F012 when it switches to log. "1"</p> <p>6030 = binector B6030 6031 = binector B6031</p>	6030, 6031	Ind: None FS=6030 Type: L2	P052 = 3 P051 = 40 Offline												

PNU	Description	Value range [Unit] Steps	No. indices Factory setting Type	See Change (Access / Status)
r799 (G171) (G173)	Diagnostic information for G-SST2 Free-running counter, overflow at 65535 i001: Number of <u>error-free</u> telegrams i002: Number of <u>errored</u> telegrams: Byte frame, parity, overrun or BCC error i003: Number of byte frame errors i004: Number of overrun errors i005: Parity error i006: STX error: Start interval before STX not observed, telegram residual transfer time not observed, delay time of LGE character too long, erroneous STX, i.e. ≠ 02 i007: Violation of telegram residual transfer time (USS prot. only) i008: Block check error i009: Incorrect telegram length: With P792=3 or 4 only: The length of the received telegram is ≠ P791 + P792 (Note: If the received values are correct, they will be processed even when this error has been detected) i010: Timeout error: No valid telegram has been received for a period exceeding the setting in P797. After the occurrence of a timeout error, this counter is not activated again until the next valid telegram is received.		Ind: 10 Type: O2	P052 = 3

G-SST 3 (RS485 on X162) (see also Section 8, Sheets G172 and G174 and Section 9 of Operating Instructions 6RX1700-0AD**)				
P800 * (G172) (G174)	Selection of protocol for G-SST3 basic converter interface 0 Setting has no function 2 USS protocol 5 "Peer-to-peer" communication 9 For internal factory test purposes	0, 2, 5, 9 1	Ind: None FS=0 Type: O2	P052 = 3 P051 = 40 Offline
P801 * (G172) (G174)	Number of process data for G-SST3 <u>When P800 = 0 or 9 is selected:</u> Parameter is irrelevant <u>When USS protocol (P800=2) is selected:</u> Number of PZD elements 0 No process data are expected or sent in the USS protocol 1...16 Number of process data words in USS protocol (same number applies to transmission and receipt) The received PZD elements (1 to max. 16) are available at connectors (K6001 to K6016) and, in some cases, bit-serially at binectors for "internal wiring" purposes. The PZD elements to be transmitted (1 to max. 16) are selected in parameters P804.01 to P804.16. <u>When peer-to-peer (P800= 5) is selected:</u> Number of transferred words 0 Illegal setting 1...5 Number of transferred words 6...16 Illegal setting	0 to 16 1	Ind: None FS=2 Type: O2	P052 = 3 P051 = 40 Offline
P802 * (G172)	Length of parameter jobs for G-SST3 This parameter is effective only when P800=2 (USS protocol). 0 <u>No PKW data</u> are expected or sent in the USS protocol. 3, 4 <u>3 or 4 PKW data words</u> are expected in the USS protocol and 3 or 4 PKW data words are also sent (for transmission of parameter values). 127 Number of PKWs is determined by the telegram length	0, 3, 4, 127 1	Ind: None FS=127 Type: O2	P052 = 3 P051 = 40 Offline

PNU	Description	Value range [Unit] Steps	No. indices Factory setting Type	See Change (Access / Status)
P803 * (G172) (G174)	Baud rate for G-SST3 1 300 baud 2 600 baud 3 1200 baud 4 2400 baud 5 4800 baud 6 9600 baud 7 19200 baud 8 38400 baud 9 56700 baud 11 93750 baud 13 187500 baud	1 to 13 1	Ind: None FS=13 Type: O2	P052 = 3 P051 = 40 Offline
P804 * (G172) (G174)	Source for transmit data for G-SST3 Selection of connectors to be transferred as <u>transmit data</u> via basic converter interface 3 <u>When USS protocol (P800=2) is selected:</u> i001: Selection for word 1 i002: Selection for word 2 ... i016: Selection for word 16 <u>When peer-to-peer (P800=5) is selected:</u> i001: Selection for word 1 i002: Selection for word 2 ... i005: Selection for word 5 i006: Not used ... i016: Not used Applicable settings: 0 = connector K0000 1 = connector K0001 etc.	All connector numbers 1	Ind: 16 FS= i001: 32 i002: 167 i003: 0 i004: 33 i005-i016: 0 Type: L2	P052 = 3 P051 = 40 Offline
P805 (G172) (G174)	Options for G-SST3 i001: 0 = Bus terminator OFF 1 = Bus terminator ON i002: 0 = Bit 10 of the 1 st receive word does <u>not</u> function as "Control by PLC". 1 = Bit 10 of the 1 st receive word does function as "Control by PLC", i.e. when bit 10 = 0, all other bits of the 1 st receive word, as well as receive words 2 to 16, are <u>not</u> written to connectors K9001 to K9016, or to binectors B9100 to B9915. All these connectors and binectors retain their old values.	0 to 1 1	Ind: 2 FS=0 Type: O2	P052 = 3 P051 = 40 Offline
P806 * (G172)	USS bus address for G-SST3 This parameter is functional only when P800=2 (USS protocol). Address via which the unit can be addressed in USS bus operation.	0 to 30 1	Ind: None FS=0 Type: O2	P052 = 3 P051 = 40 Offline

PNU	Description	Value range [Unit] Steps	No. indices Factory setting Type	See Change (Access / Status)										
P807 (G172) (G174)	<p>Telegram failure time for G-SST3</p> <p>The failure time set in this parameter is valid when setting P800=2 (USS protocol) or P800=5 (peer-to-peer) is selected.</p> <p>0.000 No time monitoring 0.001...65.000 Time which may elapse between the receipt of two telegrams addressed to the unit before a fault message is activated.</p> <p>Fault message F013 is activated if no valid telegram is received within this time period.</p> <p>Note: The telegram monitoring function is active</p> <ul style="list-style-type: none"> from the receipt of the first error-free telegram after connection of the electronics power supply from the receipt of the first error-free telegram after the telegram monitor has responded (i.e. monitoring timeout). <p>Since the telegram transfer time is dependent on the set baud rate, the following minimum setting values for P807 are recommended:</p> <p>Baud rate as set in P803: Recommended minimum value for P807:</p> <table> <tr> <td>300 baud</td> <td>0.520s</td> </tr> <tr> <td>600 baud</td> <td>0.260s</td> </tr> <tr> <td>1200 baud</td> <td>0.140s</td> </tr> <tr> <td>2400 baud</td> <td>0.080s</td> </tr> <tr> <td>≥ 4800 baud</td> <td>0.040s</td> </tr> </table> <p>Note: If the "Automatic restart" function is selected (P086>0) on the peer-to-peer communication partner, then only a parameter setting of P807>P086 (on the communication partner) is meaningful.</p>	300 baud	0.520s	600 baud	0.260s	1200 baud	0.140s	2400 baud	0.080s	≥ 4800 baud	0.040s	0.000 to 65.000 [s] 0.001s	Ind: None FS=0.000 Type: O2	P052 = 3 P051 = 40 Offline
300 baud	0.520s													
600 baud	0.260s													
1200 baud	0.140s													
2400 baud	0.080s													
≥ 4800 baud	0.040s													
P808 * (G172) (G174)	<p>Source for activation of F013</p> <p>Selection of binector which will activate fault message F013 when it switches to log. "1"</p> <p>9030 = binector B9030 9031 = binector B9031</p>	9030, 9031	Ind: None FS=9030 Type: L2	P052 = 3 P051 = 40 Offline										
r809 (G172) (G174)	<p>Diagnostic information for G-SST3</p> <p>Free-running counter, overflow at 65535</p> <p>i001: Number of <u>error-free</u> telegrams i002: Number of <u>errored</u> telegrams: Byte frame, parity, overrun or BCC error i003: Number of byte frame errors i004: Number of overrun errors i005: Parity error i006: STX error: Start interval before STX not observed, telegram residual transfer time not observed, delay time of LGE character too long, erroneous STX, i.e. ≠ 02 i007: Violation of telegram residual transfer time (USS prot. only) i008: Block check error i009: Incorrect telegram length: With PP802=3 or 4 only: The length of the received telegram is ≠ P801 + P802 (Note: If the received values are correct, they will be processed even when this error has been detected) i010: Timeout error: No valid telegram has been received for a period exceeding the setting in P807. After the occurrence of a timeout error, this counter is not activated again until the next valid telegram is received.</p>		Ind: 10 Type: O2	P052 = 3										

PNU	Description	Value range [Unit] Steps	No. indices Factory setting Type	See Change (Access / Status)
r810 (G170)	Receive data on G-SST1 Display of data received via USS interface 1 i001: Display process data word 1 ... i016 Display process data word 16 i017: Display parameter data word 1 ... i020: Display parameter data word 4		Ind: 20 Type: L2	P052 = 3
r811 (G170)	Transmit data on G-SST1 Display of the data to be transmitted via USS interface 1 i001: Display process data word 1 ... i016 Display process data word 16 i017: Display parameter data word 1 ... i020: Display parameter data word 4		Ind: 20 Type: L2	P052 = 3
r812 (G171) (G173)	Receive data on G-SST2 <u>When USS protocol (P790=2) is selected:</u> Display of data received via USS interface 2 i001: Display process data word 1 ... i016 Display process data word 16 i017: Display parameter data word 1 ... i020: Display parameter data word 4 <u>When peer-to-peer (P790=5) is selected:</u> Display of data received via peer-to-peer interface 2 i001: Receive data word 1 ... i005 Receive data word 5 i006: Not used ... i020 Not used		Ind: 20 Type: L2	P052 = 3
r813 (G171) (G173)	Transmit data on G-SST2 <u>When USS protocol (P790=2) is selected:</u> Display of the data to be transmitted via USS interface 2 i001: Display process data word 1 ... i016 Display process data word 16 i017: Display parameter data word 1 ... i020: Display parameter data word 4 <u>When peer-to-peer (P790=5) is selected:</u> Display of the data to be transmitted via peer-to-peer interface 2 i001: Transmit data word 1 ... i005 Transmit data word 5 i006: Not used ... i020 Not used		Ind: 20 Type: L2	P052 = 3

PNU	Description	Value range [Unit] Steps	No. indices Factory setting Type	See Change (Access / Status)
r814 (G172) (G174)	<p>Receive data on G-SST3</p> <p><u>When USS protocol (P800=2) is selected:</u> Display of data received via USS interface 3</p> <p>i001: Display process data word 1 ... i016 Display process data word 16 i017: Display parameter data word 1 ... i020: Display parameter data word 4</p> <p><u>When peer-to-peer (P800=5) is selected:</u> Display of data received via peer-to-peer interface 3</p> <p>i001: Receive data word 1 ... i005 Receive data word 5 i006: Not used ... i020 Not used</p>		Ind: 20 Type: L2	P052 = 3
r815 (G172) (G174)	<p>Transmit data on G-SST3</p> <p><u>When USS protocol (P800=2) is selected:</u> Display of the data to be transmitted via USS interface 3</p> <p>i001: Display process data word 1 ... i016 Display process data word 16 i017: Display parameter data word 1 ... i020: Display parameter data word 4</p> <p><u>When peer-to-peer (P800=5) is selected:</u> Display of the data to be transmitted via peer-to-peer interface 3</p> <p>i001: Transmit data word 1 ... i005 Transmit data word 5 i006: Not used ... i020 Not used</p>		Ind: 20 Type: L2	P052 = 3

Peer-to-peer interfaces: Enable transmission and receipt of telegrams:				
If transmission on a peer-to-peer interface is disabled, the associated output drivers are connected to high impedance. If reception is disabled on a peer-to-peer interface, then the telegram failure monitoring function is deactivated.				
P816 (G173)	Peer-to-peer 2: Source for data reception enabling command 0 = binector B0000 1 = binector B0001 etc.	All binector numbers 1	Ind: None FS=1 Type: L2	P052 = 3 P051 = 40 Offline
P817 (G173)	Peer-to-peer 2: Source for data transmission enabling command 0 = binector B0000 1 = binector B0001 etc.	All binector numbers 1	Ind: None FS=1 Type: L2	P052 = 3 P051 = 40 Offline
P818 (G174)	Peer-to-peer 3: Source for data reception enabling command 0 = binector B0000 1 = binector B0001 etc.	All binector numbers 1	Ind: None FS=1 Type: L2	P052 = 3 P051 = 40 Offline
P819 (G174)	Peer-to-peer 3: Source for data transmission enabling command 0 = binector B0000 1 = binector B0001 etc.	All binector numbers 1	Ind: None FS=1 Type: L2	P052 = 3 P051 = 40 Offline

PNU	Description	Value range [Unit] Steps	No. indices Factory setting Type	See Change (Access / Status)
-----	-------------	--------------------------------	---	---------------------------------------

10.41 Deactivation of monitoring functions

 WARNING If monitoring functions are deactivated, there may be a risk to the safety of operating personnel or of substantial property damage if a fault or error actually occurs!				
P820 *	Deactivation of fault messages The numbers of all fault messages to be deactivated must be entered in this parameter. Fault numbers can be entered in any order. 0 must be entered for any unused indices of the parameter. Factory setting: i001 = 7 (overvoltage) i002 = 18 (short circuit at binary outputs) i003 = 31 (monitoring of speed controller) i004 = 35 (drive blocked) i005 = 36 (armature current cannot flow) i006 = 37 (I ² t motor monitoring function has responded) i007 to i099 = 0	0 to 147 1	Ind: 99 FS= see column on left Type: O2	P052 = 3 P051 = 40 Online
P821 *	Deactivation of alarms The numbers of all alarm messages to be deactivated must be entered in this parameter. Alarm numbers can be entered in any order. 0 must be entered for any unused indices of the parameter.	0 to 147 1	Ind: 99 FS= 0 Type: O2	P052 = 3 P051 = 40 Online

10.42 Compensation values

r824	A7006 compensation values These data contain compensation values for the analog section of electronics board A7006	0 to 65535 1	Ind: 10 Type: O2	P052 = 3
P825	Offset compensation for actual field current channel These data contain compensation values for the actual field current sensing function. They are automatically set during "Restore factory settings" (P051=21) and during the automatic offset compensation run (P051=22).	13000 to 25000 1	Ind: 3 FS=19139 Type: O2	P052 = 3 P051 = 40 Online
P826 (G163)	Correction of natural commutation timing If there is a variation in the armature current peak value (in spite of a constant firing angle), it can be corrected by offsetting the firing angle reference time of the appropriate line phase in parameter P826. One line phase (UV, UW, VW, VU, WU, WV) is assigned to each parameter index (i001 to i006). Increasing the parameter setting by a value of 1 corresponds to an increase of 1.333 µs in the firing angle (0.024 degrees at 50Hz line frequency), consequently reducing the armature current peak in the appropriate line phase. P826 is automatically set during the optimization run for precontrol and current controller (armature and field) (P051=25) (only when U800=0; when U800=1 or 2, parameters P826.001 to 006 are set to 0). Caution: Even an asymmetrical system causes variations in the magnitude of armature current peaks. However, the system asymmetry may also change.	-100 to 100 * 1.333 [µs] 1.333µs	Ind: 6 FS=0 Type: I2	P052 = 3 P051 = 40 Online
r827	Internal diagnosis i001: Number of write access operations to EEPROM i002: Number of Page-Write access operations to EEPROM i003: Counter for DUAL-PORT RAM timeouts	0 to 65535 1	Ind: 3 Type: O2	P052 = 3
r828	MLFB data These data contain details about the power section design (model)	0 to 65535 1	Ind: 16 Type: O2	P052 = 3
r829	A7001 compensation values These data contain compensation values for the analog section of electronics board A7001	0 to 65535 1	Ind: 68 Type: O2	P052 = 3

PNU	Description	Value range [Unit] Steps	No. indices Factory setting Type	See Change (Access / Status)
-----	-------------	--------------------------------	---	---------------------------------------

10.43 Thyristor diagnosis

P830 *	Control word for thyristor diagnosis	0 to 3 1	Ind: None FS=0 Type: O2	P052 = 3 P051 = 40 Offline
	<p>0 Thyristor check function deactivated</p> <p>1 Thyristors are checked on initial SWITCH-ON or INCHING command after connection of the electronics supply voltage.</p> <p>2 Thyristors are checked on every SWITCH-ON or INCHING command.</p> <p>3 Thyristors will be checked on the next SWITCH-ON or INCHING command. Parameter P830 is set to 0 if no fault is detected.</p> <p>Note: The thyristor check function may not be activated (setting P830=0 must be selected)</p> <ul style="list-style-type: none"> – when the "Enable a torque direction for torque direction change by parallel drive" function is in use (see also parameter P165) or – when the converter is used to supply large inductances (e.g. field supply from armature terminals, supply of lifting solenoids, etc.). 			

10.44 Parameters for DriveMonitor and OP1S

P831 to r849	Parameters for the Trace function of DriveMonitor These parameters are settings for the data exchange between DriveMonitor and the SIMOREG converter. They must <u>not</u> be changed!			P052 = 3
r850 to P899	Parameters for the OP1S These parameters are settings for the data exchange between OP1S and the SIMOREG converter. They must <u>not</u> be changed!			P052 = 3

10.45 Profile parameters

P918 (Z110) (Z111)	CB bus address Protocol-dependent bus address for communication boards Note: The validity of the bus address is monitored by the communication board. (Bus addresses 0 to 2 are reserved for Master stations on PROFIBUS boards and must not therefore be set for other purposes). If the value is not accepted by the COM BOARD, fault F080 is displayed with fault value 5	0 to 200 1	Ind: 2 FS=3 Type: O2	P052 = 3 P051 = 40 Offline
P927 * (G170) (G171) (G172) (Z110) (Z111)	Parameterization enable Enabling of interfaces for parameterization. A parameter value can only be altered via an enabled interface. 0: None 1: Communications board (CB) 2: Parameterizing unit (PMU) 4: G-SST1 serial interface and OP1S 8: Reserved 16: Technology board (TB) 32: G-SST2 serial interface 64: G-SST3 serial interface Setting information: Every interface has a numeric code. The number for one specific interface, or the sum of various numbers assigned to several interfaces, must be entered in this parameter in order to enable the relevant interface(s) for use as a parameterization interface. Example: Factory setting value 6 (=4+2) means that the PMU and G-SST1 interfaces are enabled for parameterization purposes.	0 to 127 1	Ind: None FS=6 Type: V2	P052 = 3 P051 = 40 Offline

PNU	Description	Value range [Unit] Steps	No. indices Factory setting Type	See Change (Access / Status)
-----	-------------	--------------------------	----------------------------------	------------------------------

10.46 Fault memory

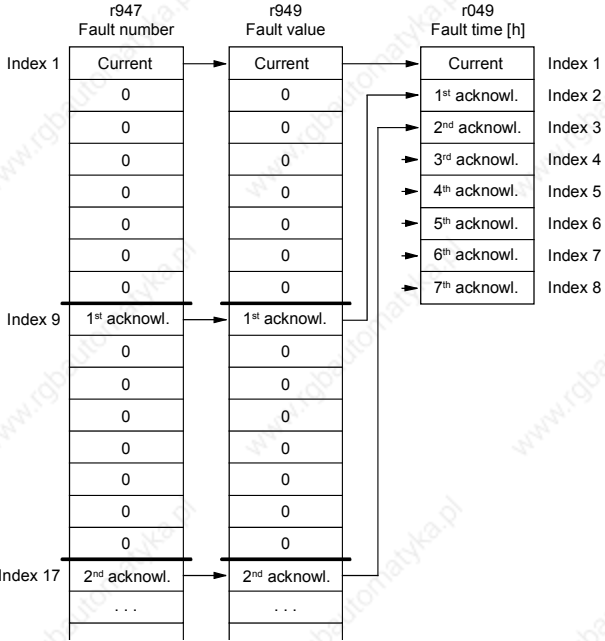
<p>r947 (G189)</p>	<p>Fault memory</p> <p>Display of fault messages generated in response to recent faults. A <u>fault value</u> and <u>fault time</u> is assigned to each <u>fault number</u> (see Section 10 for details of fault numbers and fault values). The interrelationship between the associated parameters is shown in the diagram below.</p> <p>The <u>fault numbers</u> of the last (maximum 8) fault events are stored under the indices of parameter P947. r947.001 displays the fault number of the current (still not acknowledged) fault, index 9 displays the number of the most recent acknowledged fault, index 17 the fault number of the second most recent acknowledged fault, etc. An entry of "0" means that no "earlier" fault has occurred. Since only one fault message can be stored with respect to any fault event on the SIMOREG 6RA70, only indices 1, 9, 17, 25, 33, 41, 49 and 57 are relevant.</p> <p>A <u>fault value</u> is assigned to each fault number in the corresponding index of parameter r949. This provides further information about the nature of the fault.</p> <p>In addition, the <u>fault time</u> (the current reading of the hours run counter as the fault occurred (r048)), is stored for each fault in r049. The data for the current (not yet acknowledged) fault are stored as the "Hours run counter reading" in index 1. The data for earlier, already acknowledged faults are stored under the following indices.</p>  <p>Plaintext information about the fault numbers is available under the corresponding index of parameter r951.</p>		<p>Ind: 64 Type: O2</p>	<p>P052 = 3</p>
<p>r949 (G189)</p>	<p>Fault value</p> <p>Fault value of faults, allows more detailed diagnosis for a variety of parameters. The fault values are stored in the same indices as the associated fault numbers (r947) - see parameter r947.</p>		<p>Ind: 64 Type: O2</p>	<p>P052 = 3</p>
<p>r951</p>	<p>Fault text</p>	<p>0 to 65535 1</p>	<p>Ind: 101 Type: O2</p>	<p>P052 = 3</p>
<p>P952</p>	<p>Number of faults</p> <p>Settings:</p> <ul style="list-style-type: none"> 0 Deletes the entire fault memory (r947, r949 and r049) by resetting to 0 Note: P952 cannot be reset while a fault is pending >0 Display of the faults stored in the fault memory (r947, r949 and r049) 	<p>0 to 65535 1</p>	<p>Ind: None FS=0 Type: O2</p>	<p>P052 = 3 P051 = 40 Offline</p>

PNU	Description	Value range [Unit] Steps	No. indices Factory setting Type	See Change (Access / Status)
-----	-------------	--------------------------------	---	---------------------------------------

10.47 Visualization parameters: Alarms

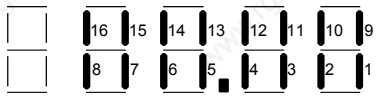
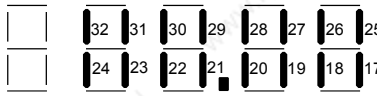
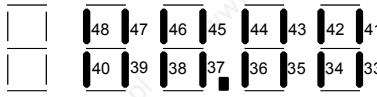
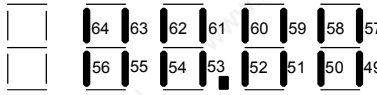
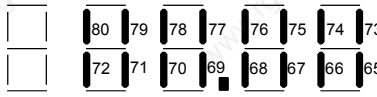
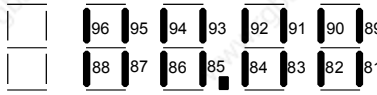
r953	Alarm parameter 1 Display of active alarms in bit-coded form (A001 to A016). If one of the alarms between 1 and 16 is generated, the corresponding segment in the display lights up.  See Section 10.2 for meaning of individual alarms.		Ind: None Type: V2	P052 = 3
r954	Alarm parameter 2 Display of active alarms in bit-coded form (A017 to A032). If one of the alarms between 17 and 32 is generated, the corresponding segment in the display lights up.  See Section 10.2 for meaning of individual alarms		Ind: None Type: V2	P052 = 3
r955	Alarm parameter 3 Parameter alarms 3 If one of the alarms between 33 and 48 is generated, the corresponding segment in the display lights up. 		Ind: None Type: V2	P052 = 3
r956	Alarm parameter 4 Parameter alarms 4 If one of the alarms between 49 and 64 is generated, the corresponding segment in the display lights up. 		Ind: None Type: V2	P052 = 3
r957	Alarm parameter 5 Parameter alarms 5 If one of the alarms between 65 and 80 is generated, the corresponding segment in the display lights up.. 		Ind: None Type: V2	P052 = 3
r958	Alarm parameter 6 Parameter alarms 6 (CB alarms) If one of the alarms between 81 and 96 is generated, the corresponding segment in the display lights up. 		Ind: None Type: V2	P052 = 3

PNU	Description	Value range [Unit] Steps	No. indices Factory setting Type	See Change (Access / Status)
r959	Alarm parameter 7 Parameter alarms 7 (TB alarms 1) If one of the alarms between 97 and 112 is generated, the corresponding segment in the display lights up. 		Ind: None Type: V2	P052 = 3
r960	Alarm parameter 8 Parameter alarms 8 (TB alarms 2) If one of the alarms between 113 and 128 is generated, the corresponding segment in the display lights up. 		Ind: None Type: V2	P052 = 3

10.48 Device identification

r964	Parameters for device identification on the PROFIBUS [SW 2.0 and later] Display parameters to support overview and diagnosis of all nodes on the PROFIBUS-DP during and after commissioning (coding according to PROFIBUS profile V3) <ul style="list-style-type: none"> i001: Display of the manufacturer of the SIMOREG DC Master 6RA70 : SIEMENS = 42 i002: Display of device type: SIMOREG DC Master 6RA70 = 4110 i003: Display of the software version of the SIMOREG DC Master 6RA70 (see r060.001) i004: Display of year of generation of the software of the SIMOREG DC Master 6RA70: y y y y (see r061.001) i005: Display of the month and day of generation of the software of the SIMOREG DC Master 6RA70: d d m m (see r061.003 and r061.002) i006: Display of the controlled axes of the SIMOREG DC Master 6RA70: 1 	0 to 65535 1	Ind: 6 Type: O2	P052 = 1
------	---	-----------------	--------------------	----------

10.49 Visualization parameters: Control and status word

r967	Display of control word 1 Visualization parameter for control word 1 (bits 0-15) Identical to r650 (control word 1)		Ind: None Type: V2	P052 = 3
r968	Display of status word 1 Visualization parameter for status word 1 (bits 0 - 15) Identical to r652 (status word 1)		Ind: None Type: V2	P052 = 3

10.50 Resetting and storing parameters, list of existing and modified P and r parameters

P970 *	Restore factory setting Reset parameters to factory setting (default) <ul style="list-style-type: none"> 0: Parameter reset: All parameters are reset to their original values (factory setting). This parameter is then automatically reset to 1. 1: No parameter reset Note: Function can also be selected by setting P051=21.	0 to 1 1	Ind: None FS=1 Type: O2	P052 = 3 P051 = 40 Offline
-----------	--	-------------	-------------------------------	----------------------------------

PNU	Description	Value range [Unit] Steps	No. indices Factory setting Type	See Change (Access / Status)
P971 *	EEPROM transfer Transfer of parameter values from RAM to EEPROM on switchover from 0 to 1. It takes approximately 15s to process all values. The PMU remains in value mode for this period.	0 to 1 1	Ind: None FS=0 Type: O2	P052 = 3 P051 = 40 Offline
r980	List of existing parameter numbers, start Visualization parameter for displaying the first 100 parameter numbers in the P or r parameter range (0 to 999). The parameter numbers are listed in ascending sequence. Repetition of a number over several indices means that there are no further parameter numbers in the 0 to 999 range. The list is continued at the parameter whose number is displayed under index 101. See also r989		Ind: 101 Type: O2	P052 = 3
r981	List of existing parameter numbers, continuation See r980.		Ind: 101 Type: O2	P052 = 3
r982	List of existing parameter numbers, continuation See r980.		Ind: 101 Type: O2	P052 = 3
r983	List of existing parameter numbers, continuation See r980.		Ind: 101 Type: O2	P052 = 3
r984	List of existing parameter numbers, continuation See r980.		Ind: 101 Type: O2	P052 = 3
r985	List of existing parameter numbers, continuation See r980.		Ind: 101 Type: O2	P052 = 3
r986	List of existing parameter numbers, continuation See r980.		Ind: 101 Type: O2	P052 = 3
r987	List of existing parameter numbers, continuation See r980.		Ind: 101 Type: O2	P052 = 3
r988	List of existing parameter numbers, continuation See r980.		Ind: 101 Type: O2	P052 = 3
r989	List of existing parameter numbers, continuation Continuation of the list can be found under index 101. Please note: 860 = r860 (TECH BOARD installed) 2980 = r980 See also r980.		Ind: 101 Type: O2	P052 = 3
r990	List of modified parameter numbers, start Visualization parameter for displaying the first 100 modified parameters in the P or r parameter range (0 to 999). The parameter numbers are listed in ascending sequence. Repetition of a number over several indices means that there are no further modified parameters in the 0 to 999 range. The list is continued at the parameter whose number is displayed under index 101. See also r999.		Ind: 101 Type: O2	P052 = 3
r991	List of modified parameter numbers, continuation See r990.		Ind: 101 Type: O2	P052 = 3
r992	List of modified parameter numbers, continuation See r990.		Ind: 101 Type: O2	P052 = 3
r993	List of modified parameter numbers, continuation See r990.		Ind: 101 Type: O2	P052 = 3
r994	List of modified parameter numbers, continuation See r990.		Ind: 101 Type: O2	P052 = 3
r995	List of modified parameter numbers, continuation See r990.		Ind: 101 Type: O2	P052 = 3
r996	List of modified parameter numbers, continuation See r990.		Ind: 101 Type: O2	P052 = 3

PNU	Description	Value range [Unit] Steps	No. indices Factory setting Type	See Change (Access / Status)
r997	List of modified parameter numbers, continuation See r990.		Ind: 101 Type: O2	P052 = 3
r998	List of modified parameter numbers, continuation See r990.		Ind: 101 Type: O2	P052 = 3
r999	List of modified parameter numbers, continuation Continuation of the list can be found under index 101. Please note: 2990 = n990 See also r990.		Ind: 101 Type: O2	P052 = 3

NOTES:

11 Simplified block diagrams

Basic functions

	Page
Sheet 1 Legend	11-2
Sheet 2 Speed Setpoint System	11-3
Sheet 3 Speed Control & Current Limit.....	11-4
Sheet 4 Armature Current Control	11-5
Sheet 5 EMF & Field Current Control	11-6
Sheet 6 USS Interface 1 (X300)	11-7
Sheet 7 USS Interface 2 (X172)	11-8
Sheet 8 Peer to Peer Interface (X172).....	11-9
Sheet 9 Data Exchange CB / TB to Base (PZD)	11-10
Sheet 10 Control Word 1.....	11-11
Sheet 11 Control Word 2.....	11-12
Sheet 12 Status Word 1	11-13
Sheet 13 Status Word 2.....	11-14
Sheet 14 Signals	11-15

NOTE

The simplified block diagrams do not show all details or functions. Please refer to Operating Instructions 6RX1700-0AD76 if additional detail or functions are required including S00 functions and accessory boards.

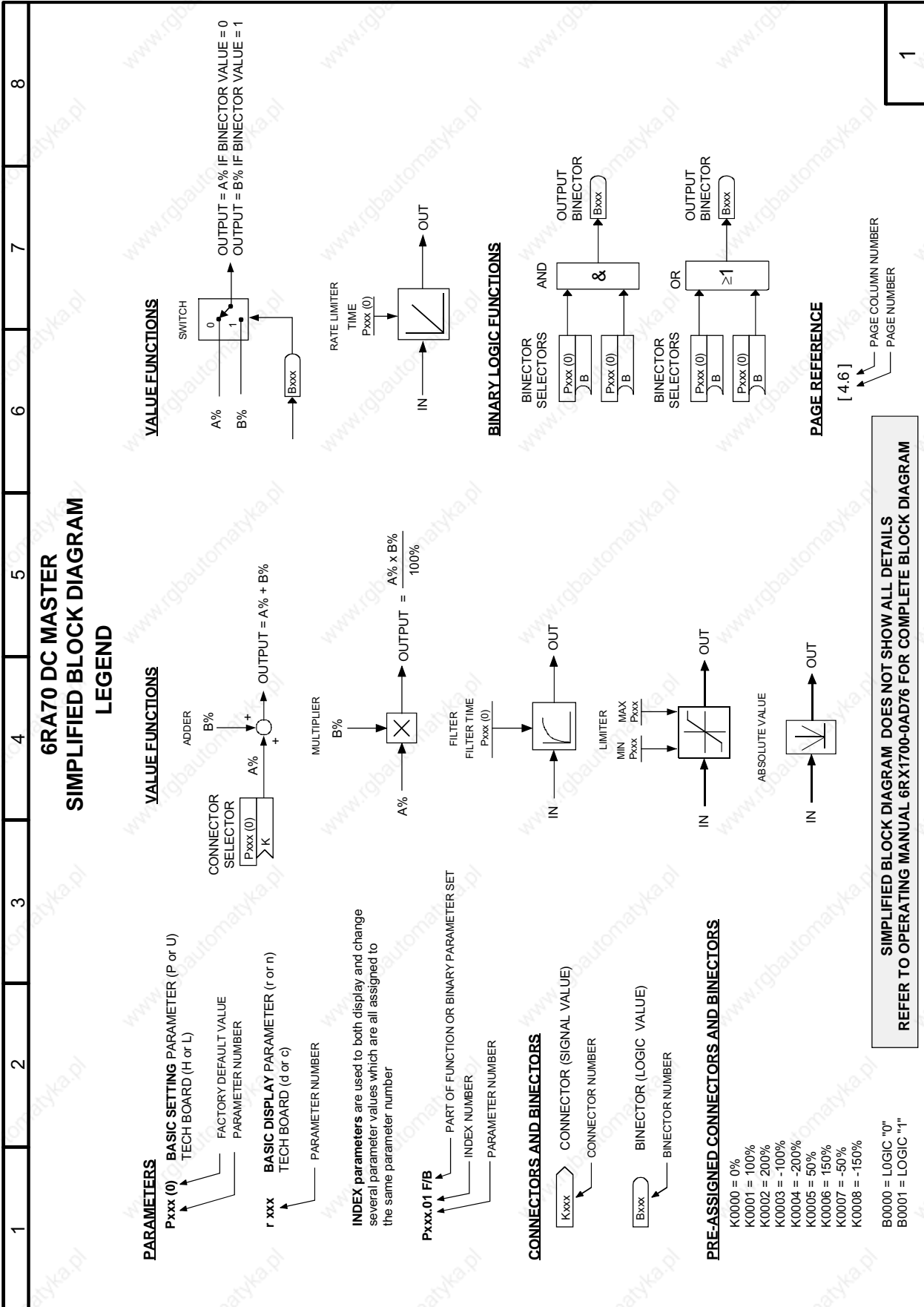

**SIMPLIFIED BLOCK DIAGRAM DOES NOT SHOW ALL DETAILS
REFER TO OPERATING MANUAL 6RX1700-0AD76 FOR COMPLETE BLOCK DIAGRAM**

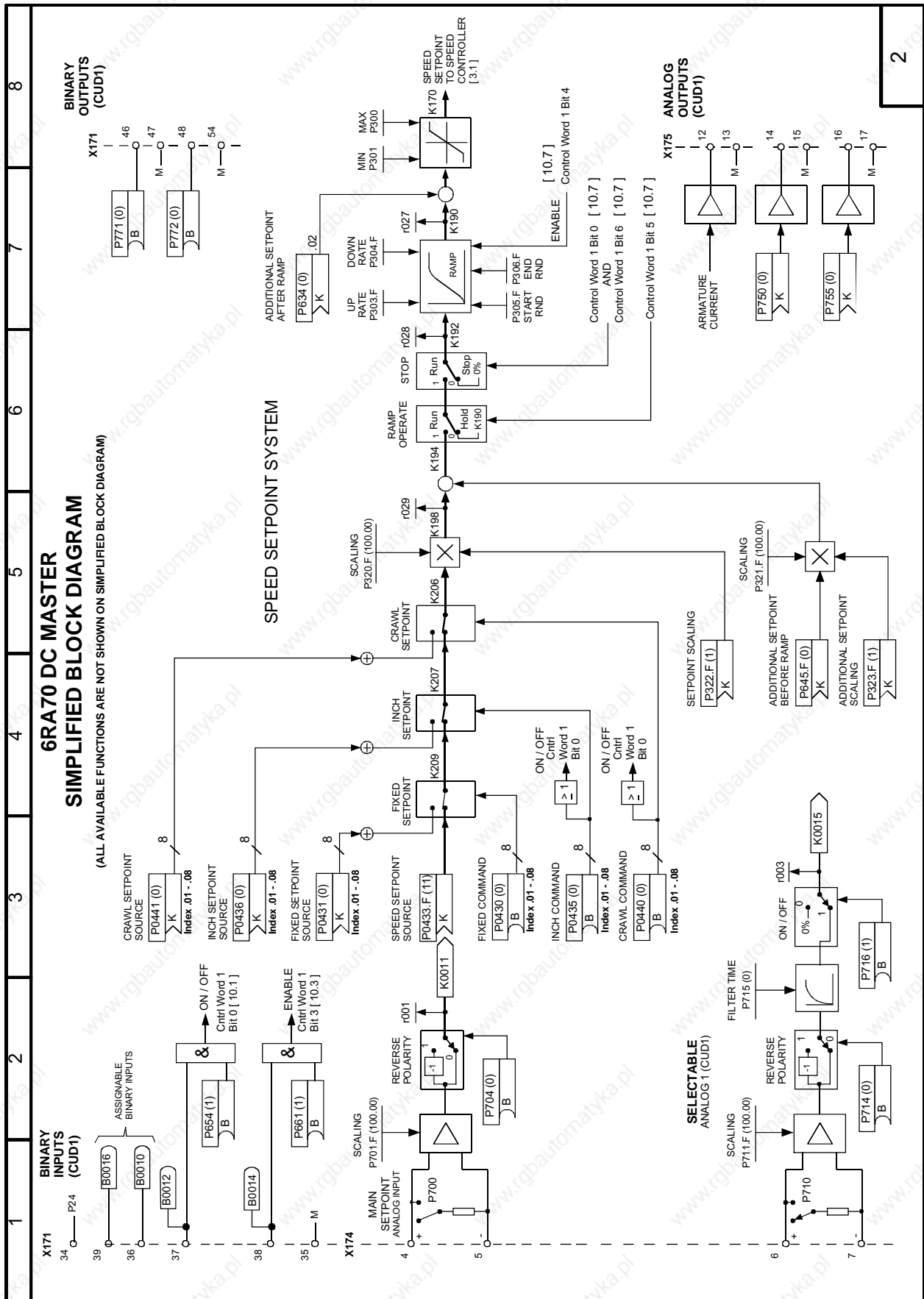

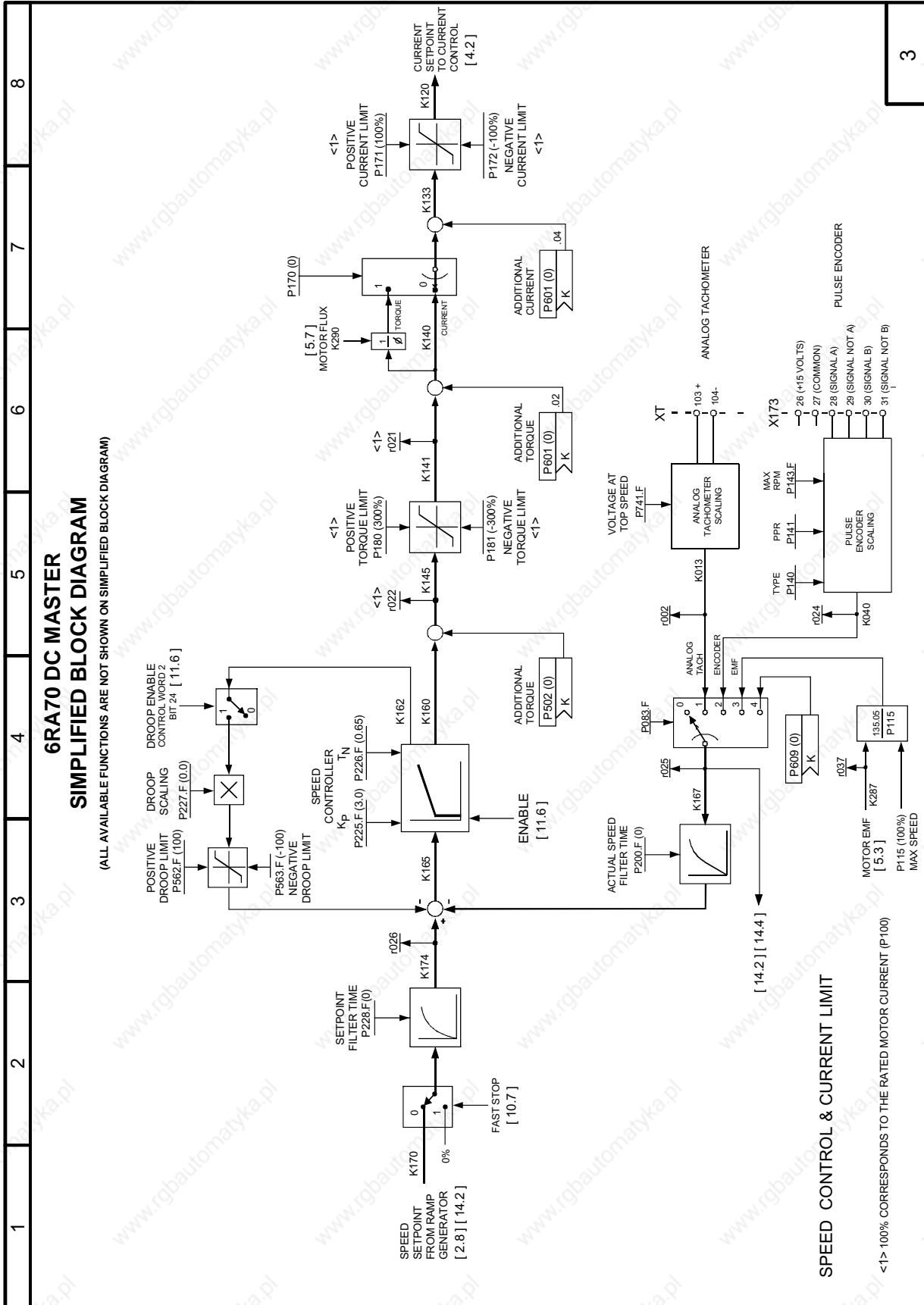

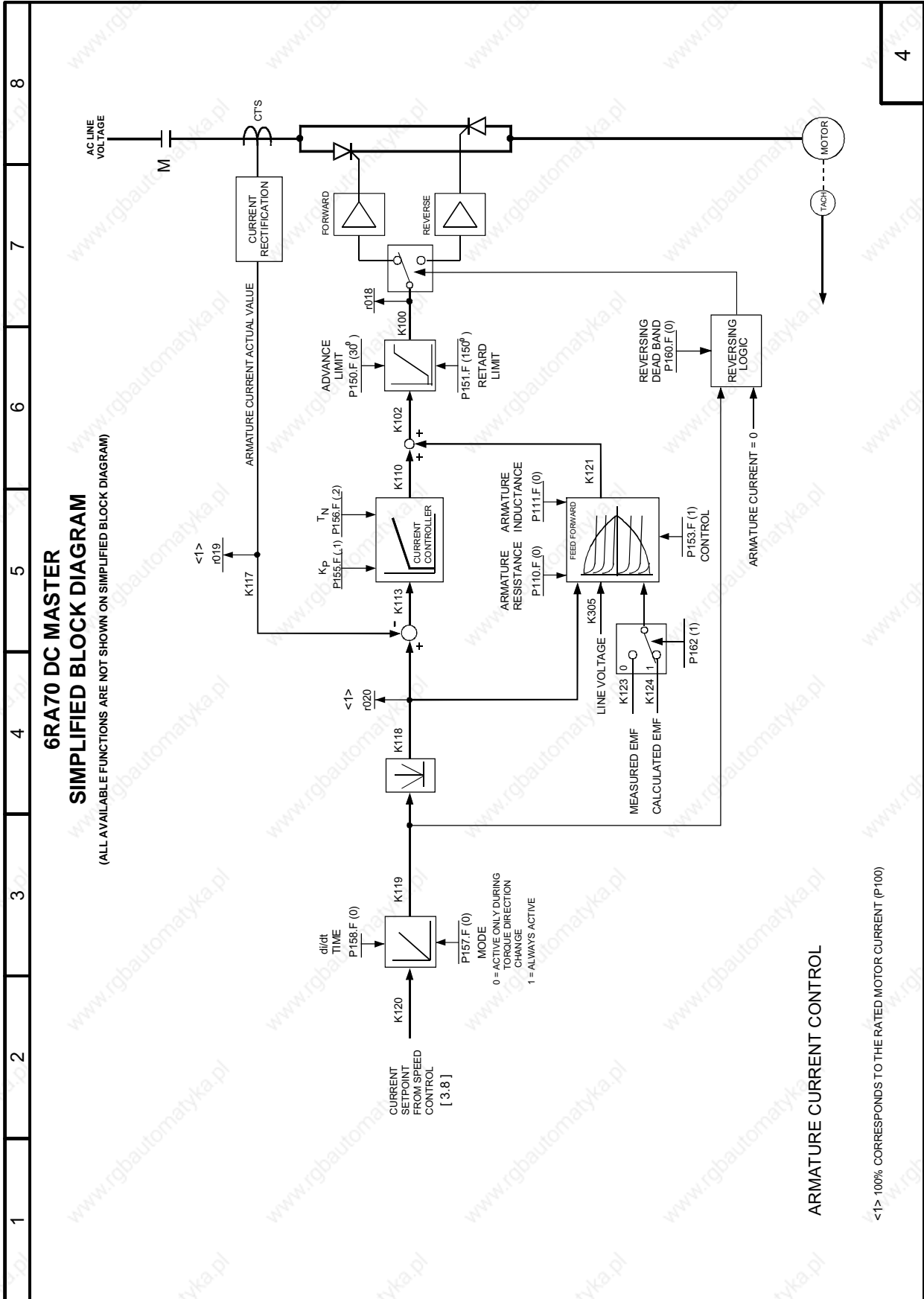

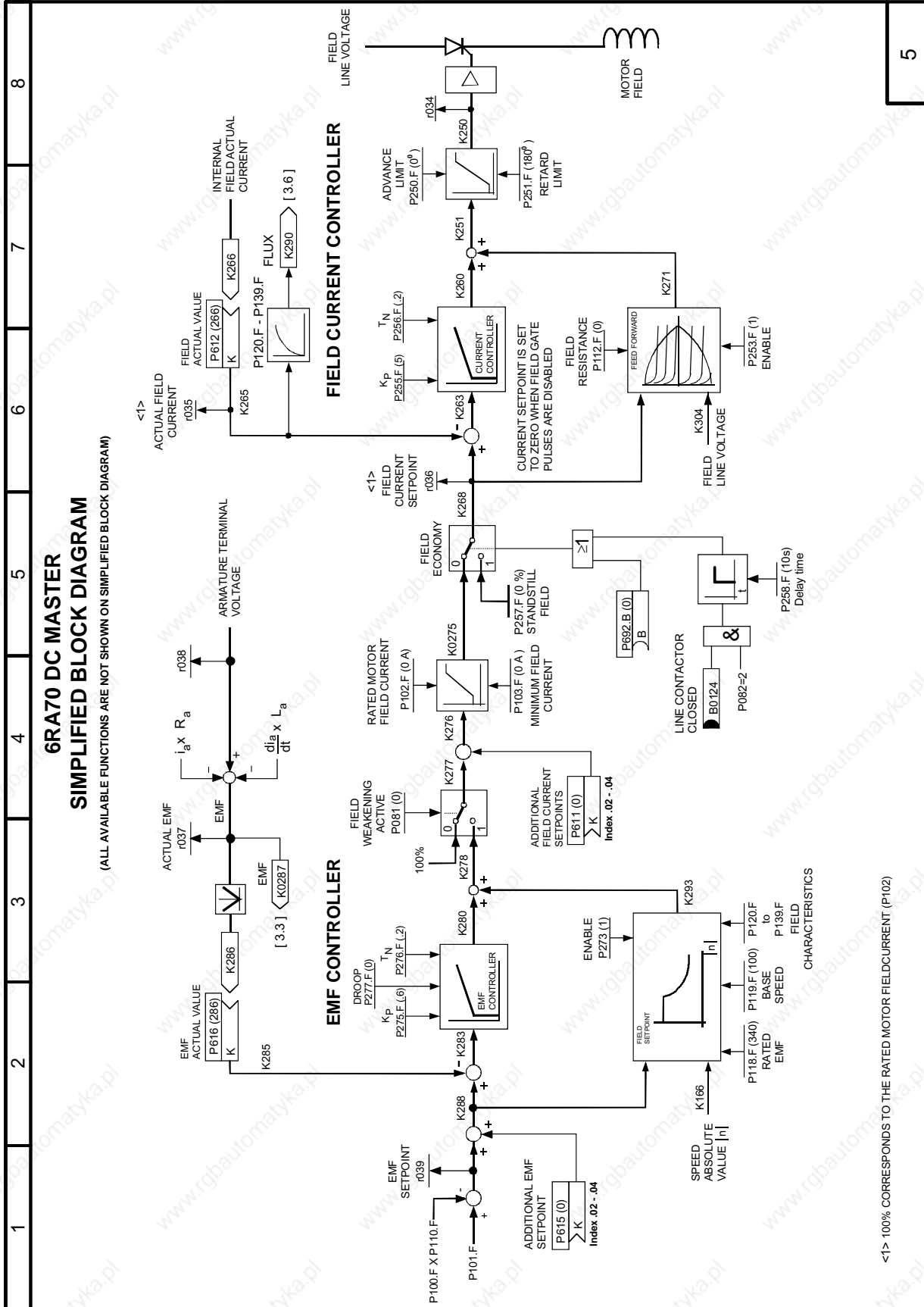

<1> 100% CORRESPONDS TO THE RATED MOTOR FIELD CURRENT (P102)

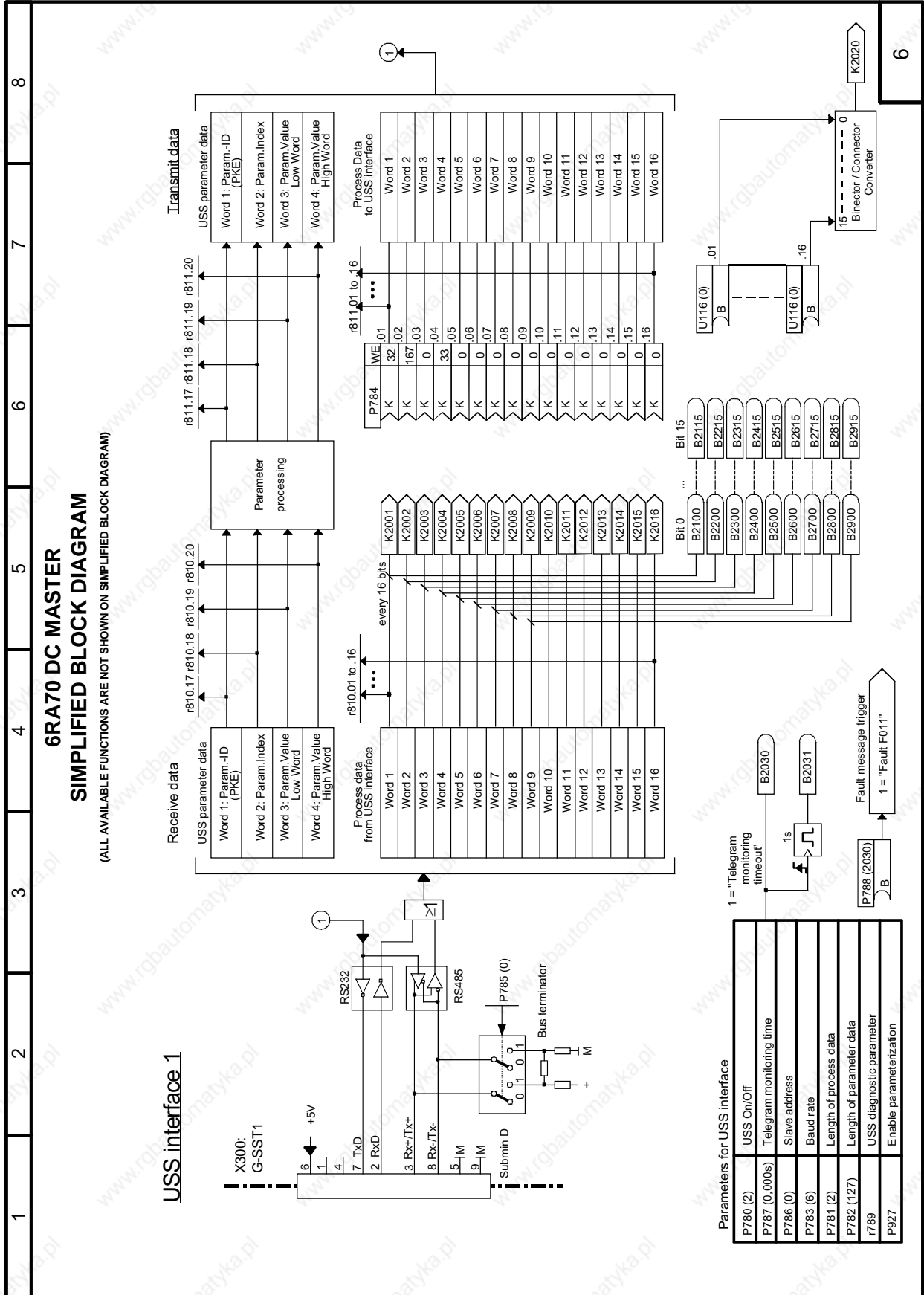

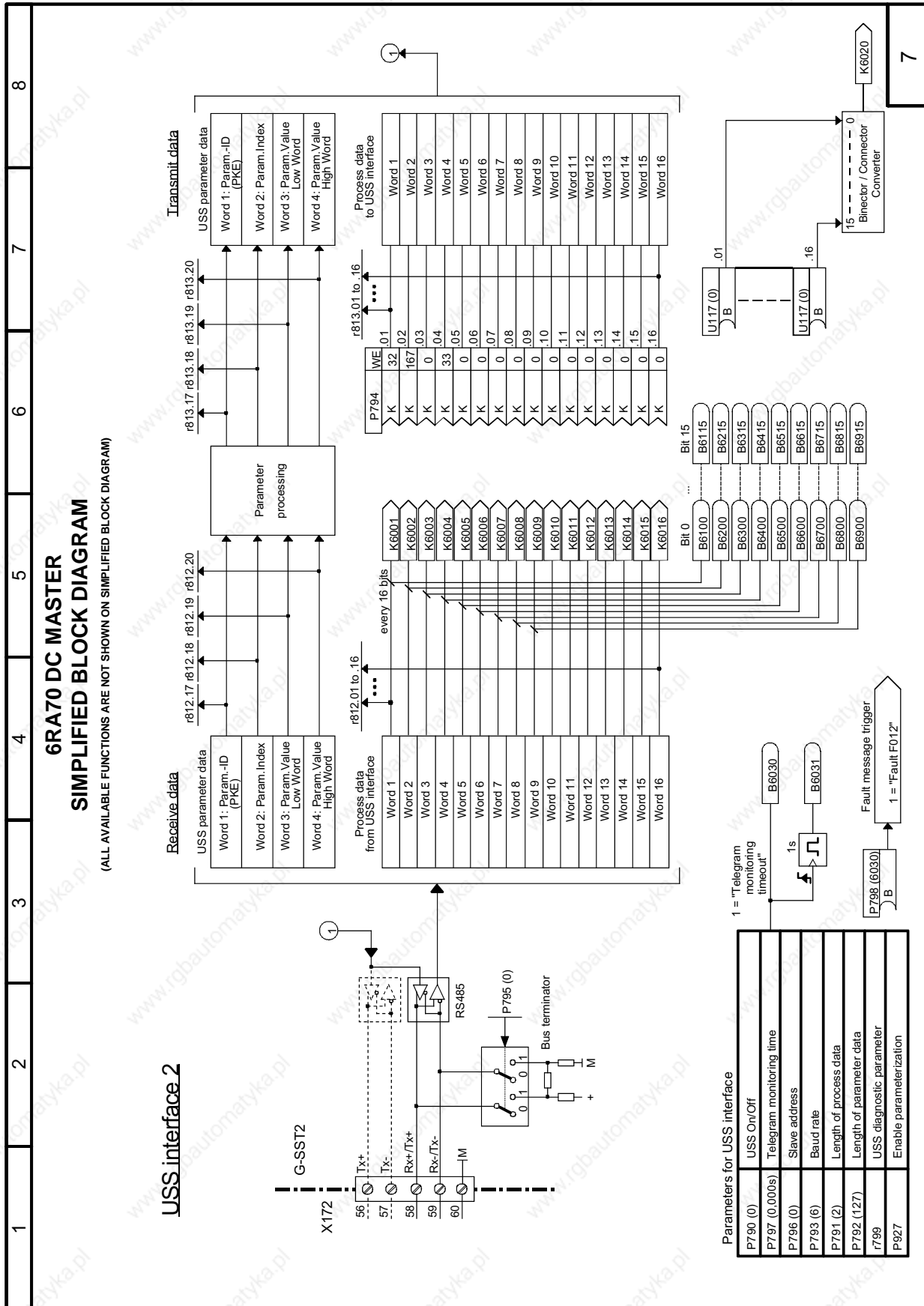

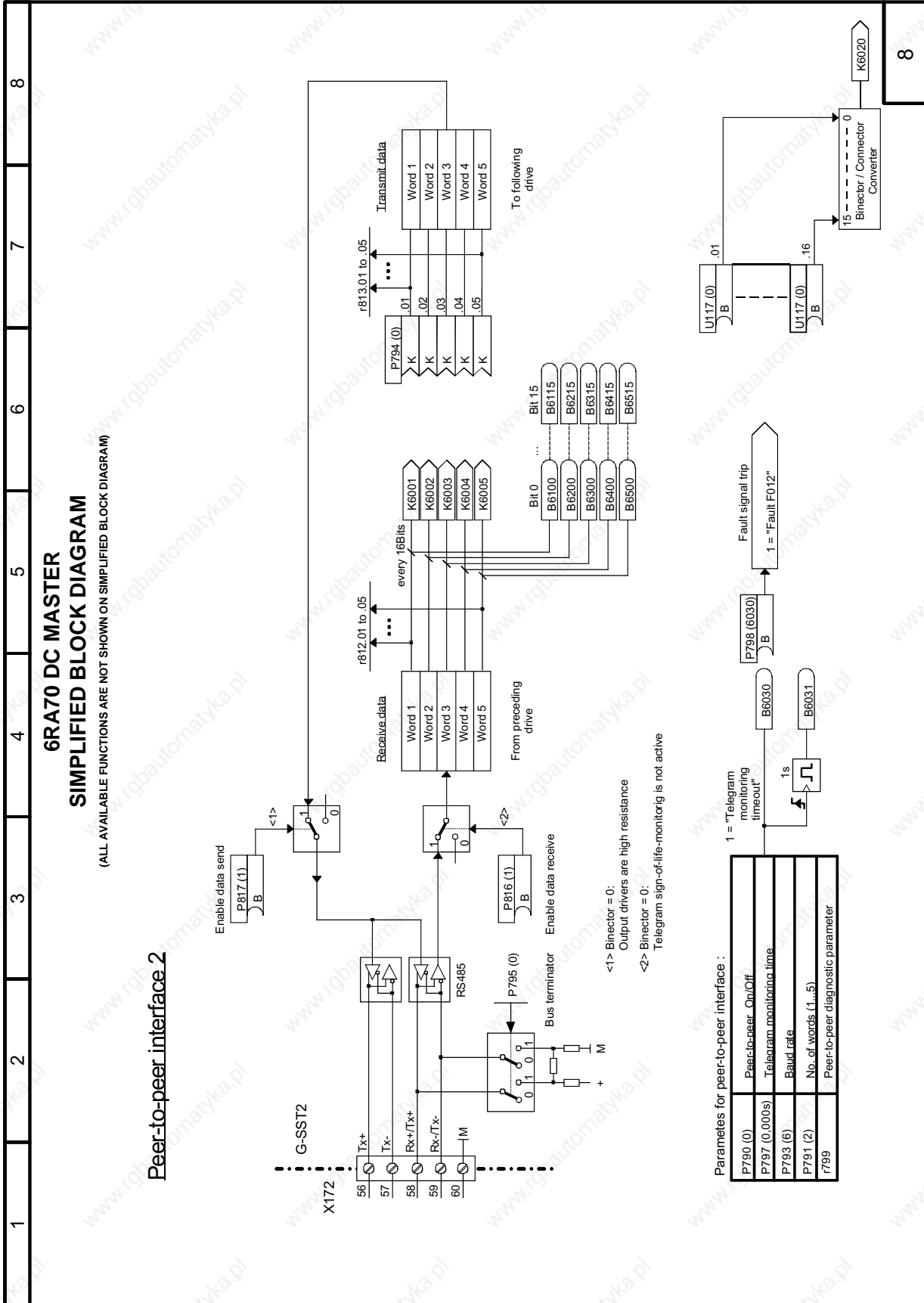

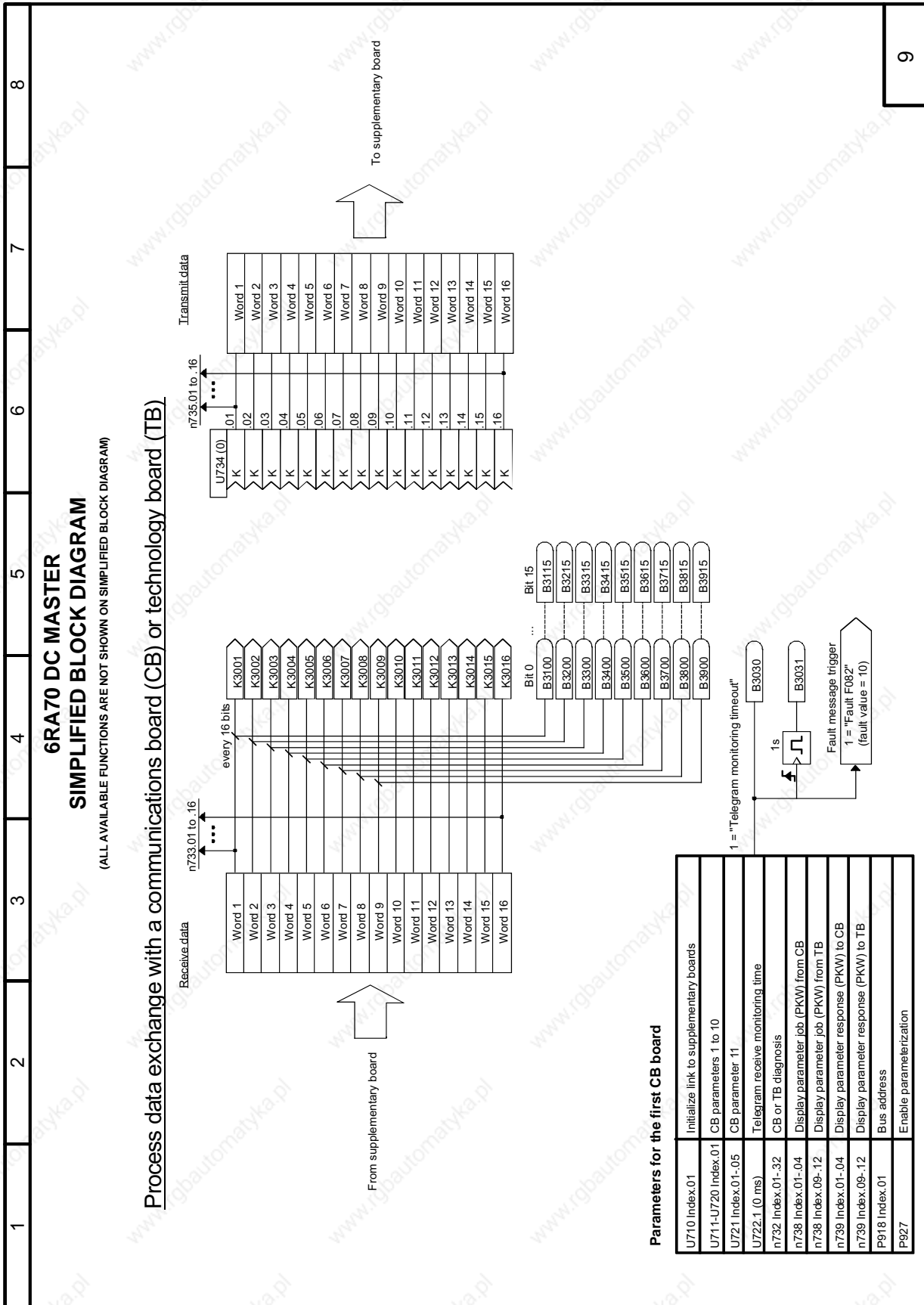

9

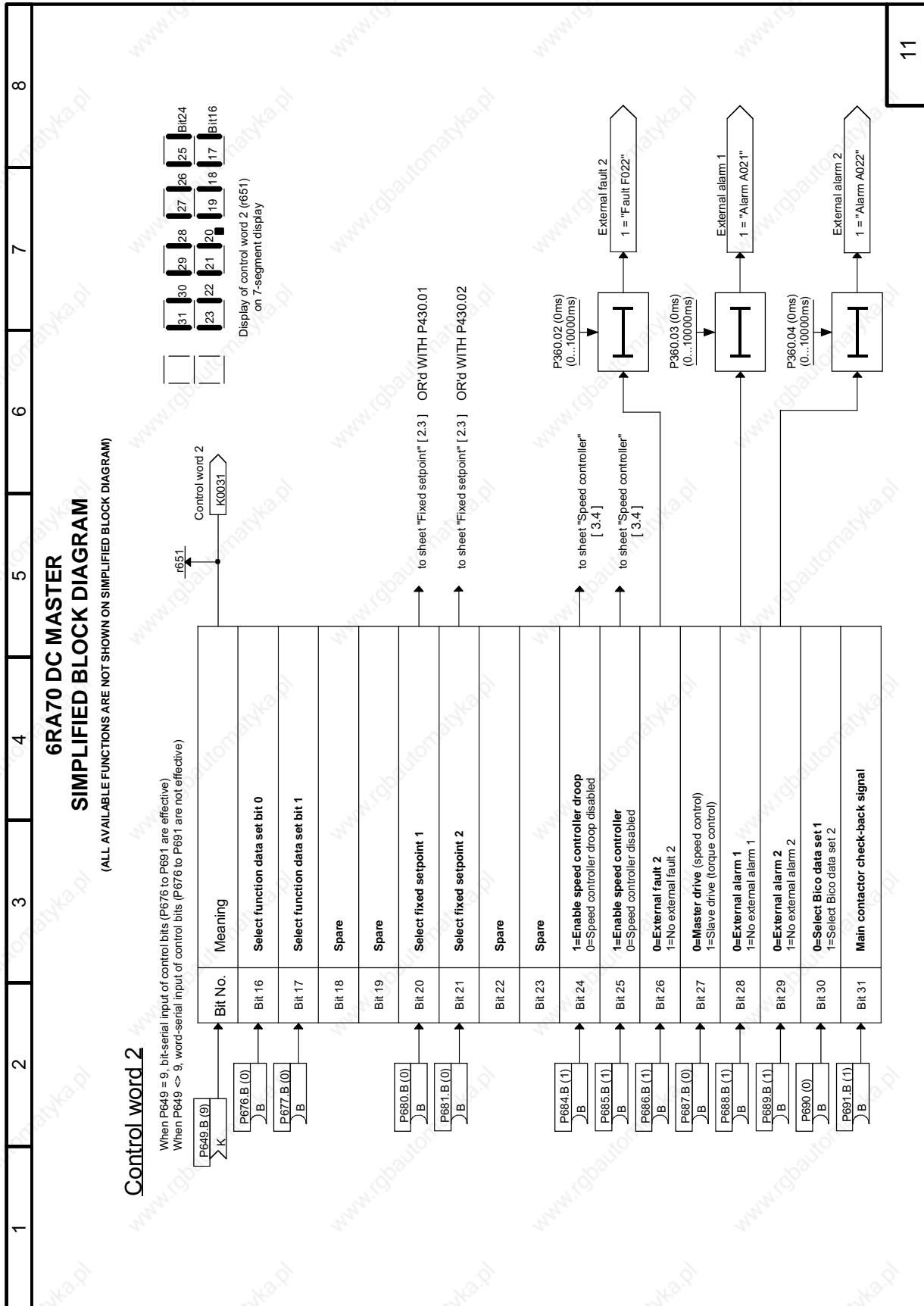

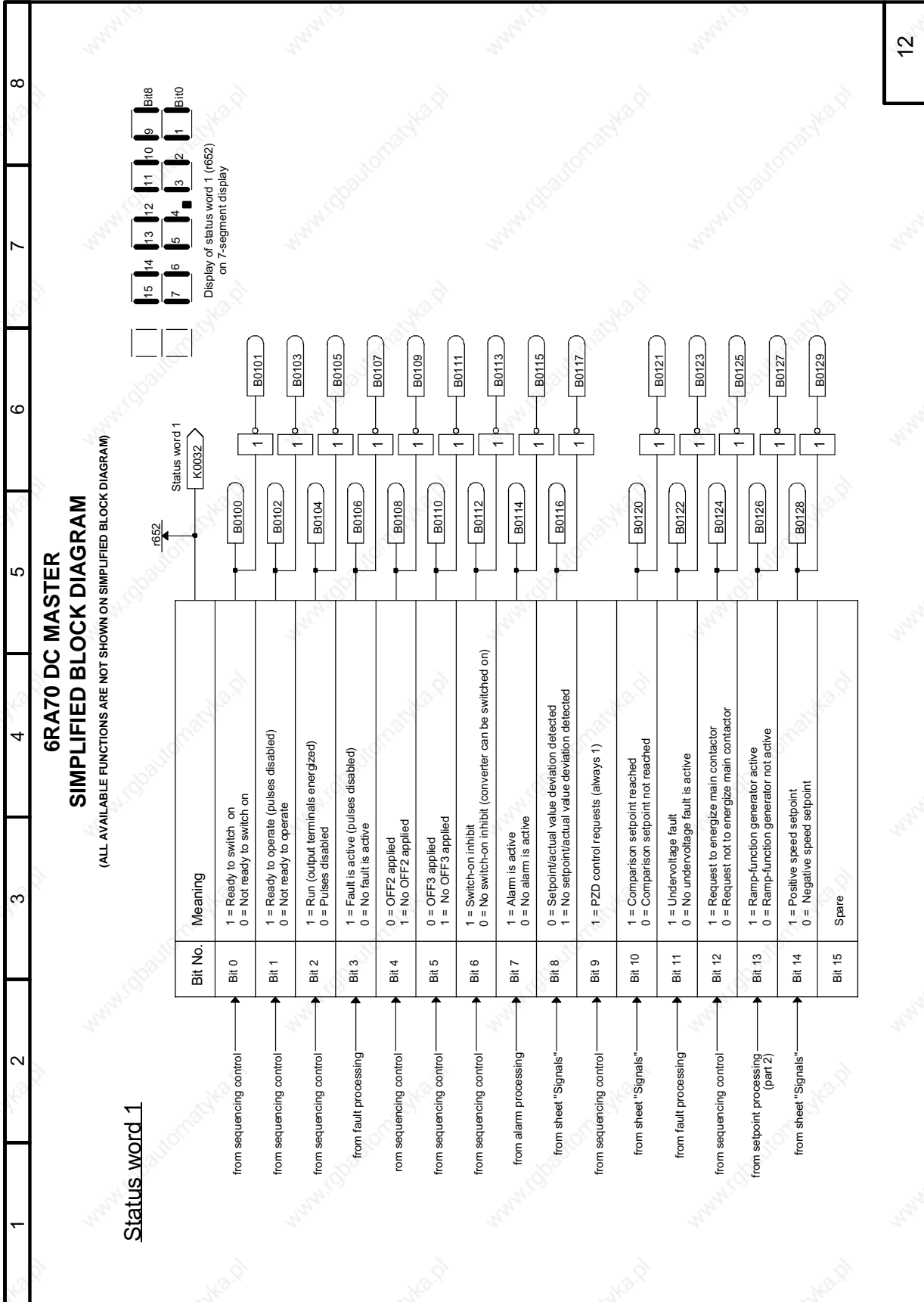

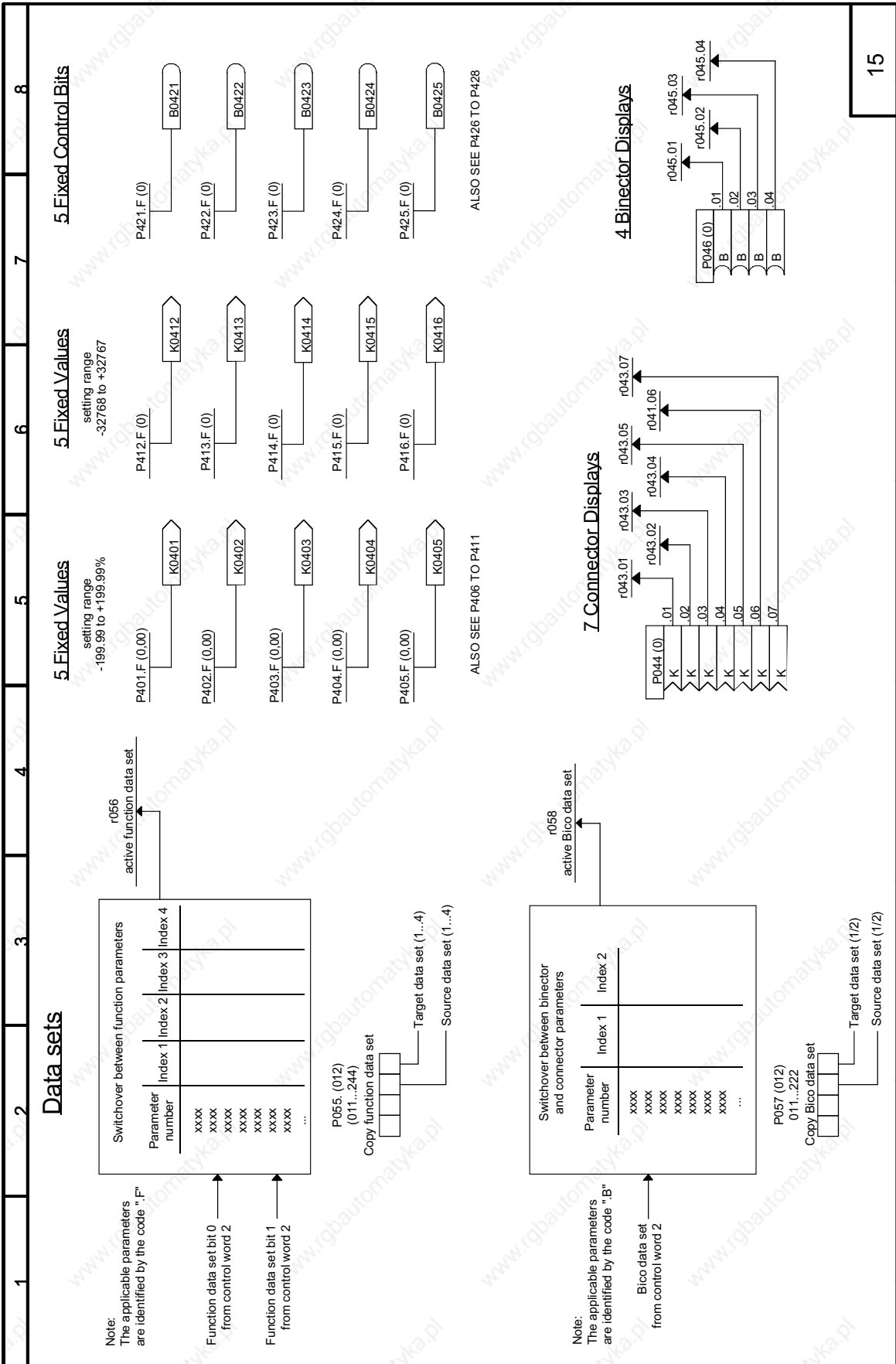

Siemens Energy & Automation, Inc.

3333 Old Milton Parkway
Alpharetta, GA 30005

1-800-964-4114

seainfo@sea.siemens.com

www.sea.siemens.com/drives

© 2004 Siemens Energy & Automation, Inc.

The Siemens logo and SIMOREG are registered trademarks of Siemens AG. Product names mentioned may be trademarks or registered trademarks of their respective companies. Specifications are subject to change without notice.

Order Number DCOM-80011-1500-08045SS Printed in USA.