

# SIEMENS

## SIMODRIVE 650

### Transistor PWM Inverters for Three-Phase Main Spindle Drives Software Release 14

Instruction Manual

Edition 08.91

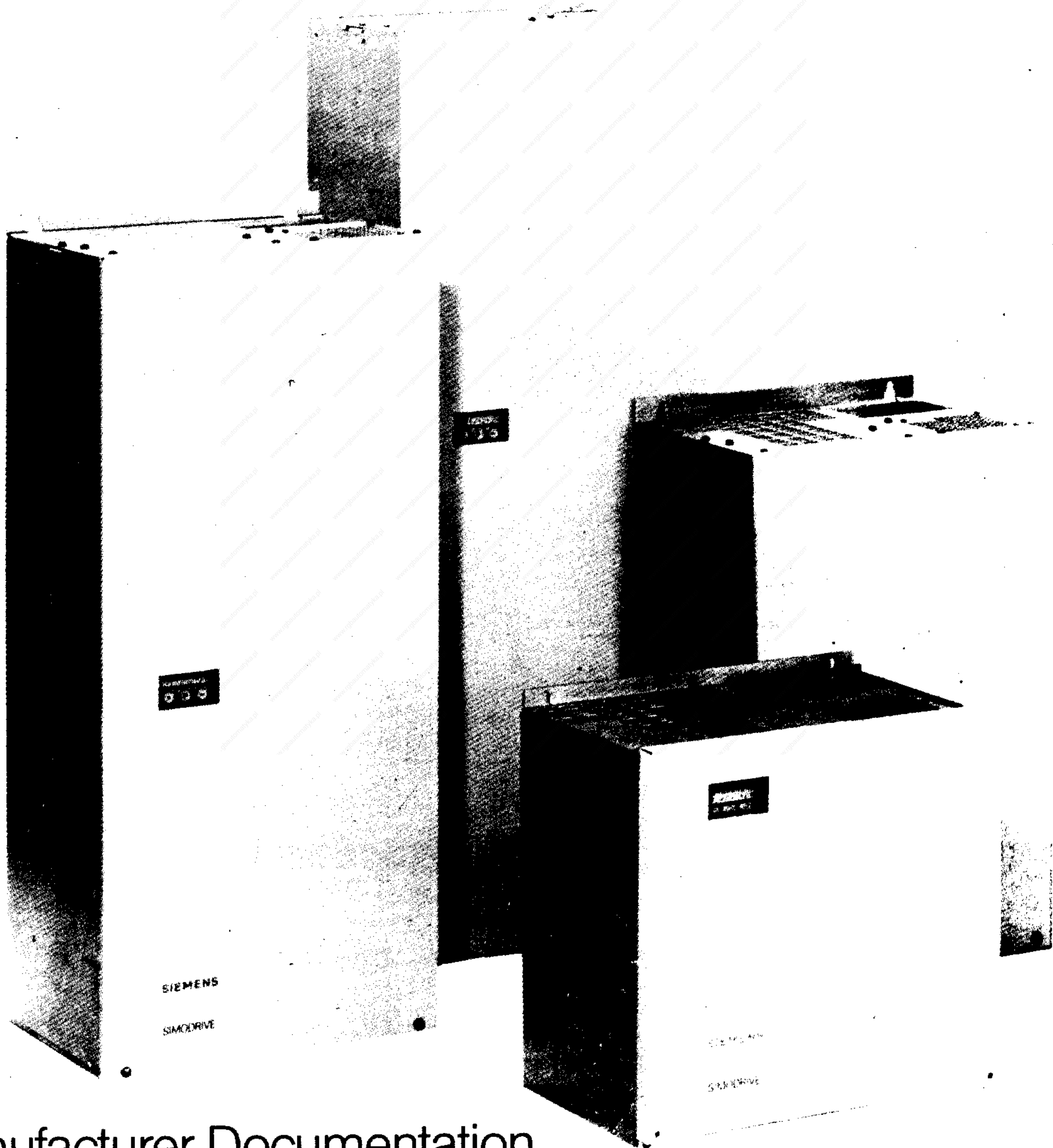

Manufacturer Documentation

# **SIMODRIVE 650**

## **Transistor PWM Inverters for Three-Phase Main Spindle Drives**

**Instruction Manual**

**Manufacturer-Documentation**

**Valid for Software Release 14**

**Edition 08.91**

# SIMODRIVE® Documentation

## Printing history

Status code in the "Remarks" column:

- A** . . . New documentation.
- B** . . . Unrevised reprint with new Order No.
- C** . . . Revised edition with new status.  
If factual changes have been made on the page since the last edition, this is indicated by a new edition coding in the header on that page.

<b>Edition</b>	<b>Order No.</b>	<b>Remarks</b>
08.91	6SC6501-0AA76 (GWE 462.500.9600.76 Jg)	<b>C</b>

Other functions not described in this documentation might be executable in the control. This does not, however, represent an obligation to supply such functions with a new control or when servicing.

This publication was produced on the Siemens 5800 Office System  
Subject to change without prior notice

The reproduction, transmission or use of this document or contents is not permitted without express written authority. Offenders will be liable for damages. All rights, including rights created by patent grant or registration of a utility model or design, are reserved.

© Siemens AG 1989 All Rights Reserved

## Preliminary Remarks

**The SIMODRIVE unit must not be connected to a supply system with ELCBs (permitted according to DIN VDE 0160, Section 6.5).**

**In compliance with DIN VDE 0160/05.88, all SIMODRIVE units are subject to a high-voltage test at the time of routine testing. If the electrical equipment of machine tools is subject to a high voltage test, all connections must be removed (permissible according to DIN VDE 0113 Part 1, Section 13.2). This measure prevents sensitive electronic components from being damaged.**

**When operational, protection against direct contact is provided in a form to allow the unit to be used in enclosed electrical equipment rooms (DIN VDE 0558 Part 1, Section 5.4.3.2.4.)**

**The circuit diagrams in this manual are block diagrams and do not necessarily represent the actual circuit design.**

**The parameter information refers to software release 14.**

Associated wiring manual: 6SC6501-0BA00

This Instruction Manual is also available in the following languages:

French  
Italian

Order No.: 6SC6501-0AA77  
6SC6501-0AA72



### CAUTION

The boards contain components which are sensitive to electrostatic discharge. The human body must be electrically discharged before an electronic board is touched. This can be simply done by touching a conductive, grounded object immediately beforehand (e.g. bare metal cubicle components, socket outlet protective conductor contact).

***This Instruction Manual does not claim to cover all equipment details or versions for every conceivable operational situation or application.***

***If further information is required or if special problems occur which are not described in enough detail for your particular application, please contact your local Siemens office.***

***The contents of this Instruction Manual are not part of an earlier or an existing agreement, confirmation or legal contract and also doesn't modify this. The actual purchase agreement represents the complete responsibility of Siemens AG. The only warranty accepted by Siemens AG is the warranty agreed between the parties in the contract. The contractual warranty conditions are neither modified or changed by the contents of this Instruction Manual.***

# Safety Information

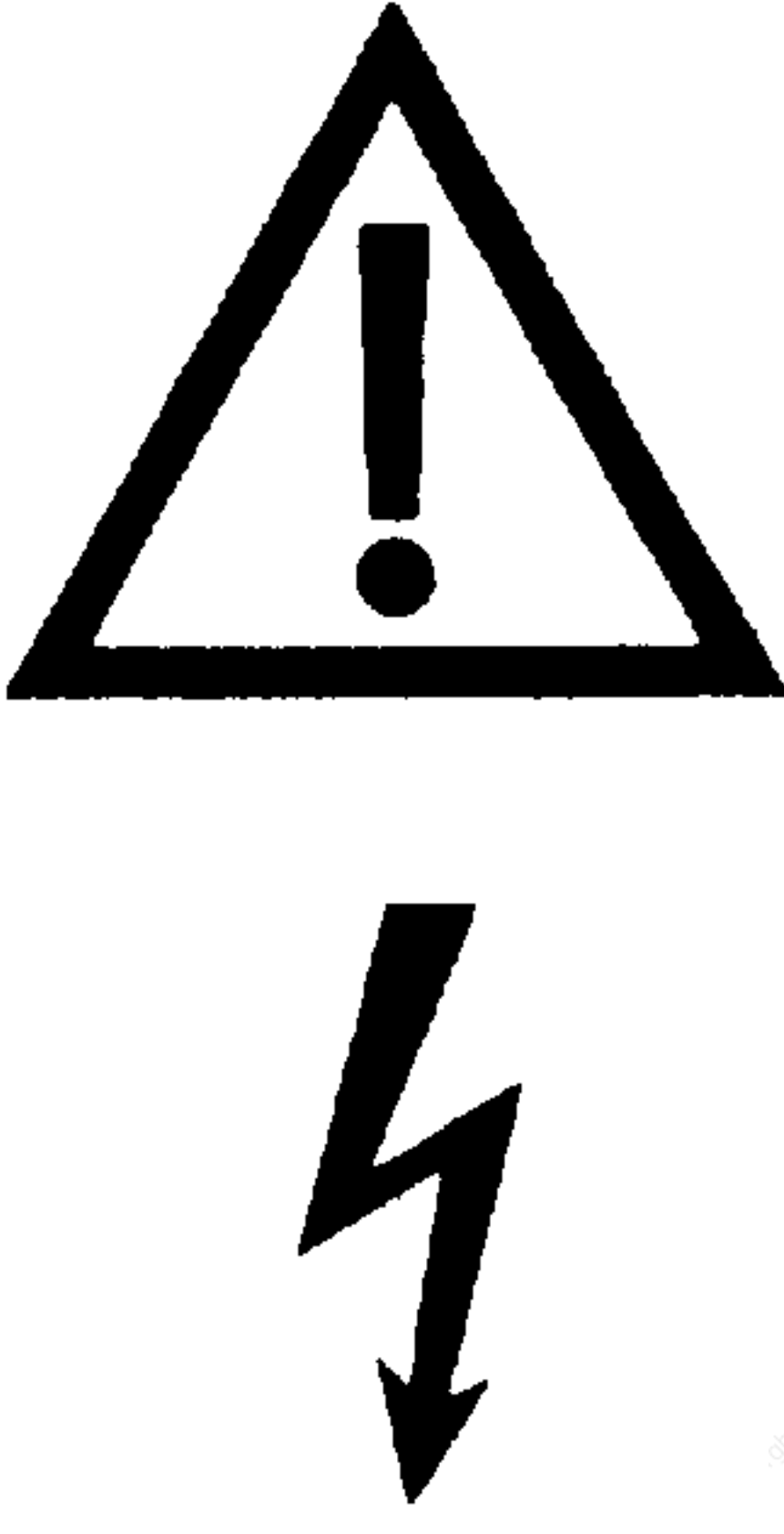
<b>WARNING</b>	
	<p>Hazardous voltages are present in this electrical equipment during operation.</p> <p>Non-observance of the safety instructions can result in severe personal injury or property damage.</p> <p>Only qualified personnel should work on or around the equipment after first becoming thoroughly familiar with all warning and safety notices and maintenance procedures contained herein.</p> <p>The successful and safe operation of this equipment is dependent on proper handling, installation, operation and maintenance.</p>

## Definitions

- **Qualified personnel**

For the purpose of this Instruction Manual and product labels, a "Qualified person" is someone who is familiar with the installation, construction and operation of the equipment and the hazards involved. He or she must have the following qualifications:

1. Trained and authorized to energize, de-energize, clear, ground and tag circuits and equipment in accordance with established safety procedures.
2. Trained in the proper care and use of protective equipment in accordance with established safety procedures.
3. Trained in rendering first aid

- **DANGER**

For the purpose of this Instruction Manual and product labels, "Danger" indicates death, severe personal injury or substantial property damage will result if proper precautions are not taken.

- **WARNING**

For the purpose of this Instruction Manual and product labels, "Warning" indicates death, severe personal injury or substantial property damage can result if proper precautions are not taken.

- **CAUTION**

For the purpose of this Instruction Manual and product labels, "Caution" indicates minor personal injury or property damage can result if proper precautions are not taken.

- **NOTE**

For the purpose of this Instruction Manual, "Note" indicates information about the product or the respective part of the Instruction Manual which is essential to highlight.

**Product Description**

---

1

**Installation**

---

2

**Start-Up**

---

3

**Faults**

---

4

**Maintenance**

---

5

**Appendix**

---

6

# Contents

	Page
<b>1</b>	<b>Product Description</b> ..... 1-1
1.1	Application ..... 1-1
1.2	Mode of operation ..... 1-1
1.3	Technical data ..... 1-2
1.4	Options ..... 1-5
<b>2</b>	<b>Installation</b> ..... 2-1
2.1	Mounting ..... 2-1
2.2	Connecting-up ..... 2-1
2.2.1	Motor-PWM inverter connecting cable ..... 2-3
2.2.2	Terminals ..... 2-4
2.2.3	Relay functions ..... 2-5
2.2.4	Connector locations ..... 2-6
<b>3</b>	<b>Start-up</b> ..... 3-1
3.1	Operator control and display elements ..... 3-1
3.2	Operator control and parameter displays ..... 3-2
3.3	Parameter grouping ..... 3-3
3.3.1	Operating display ..... 3-4
3.3.1.1	Significance of the first digit ..... 3-4
3.3.1.2	Significance of the second digit ..... 3-4
3.3.1.3	Significance of the third digit ..... 3-5
3.3.1.4	Significance of the fourth digit ..... 3-6
3.3.1.5	Significance of the fifth digit ..... 3-7
3.3.1.6	Significance of the sixth digit ..... 3-7
3.3.2	Measured value and status displays ..... 3-8
3.3.3	Analog outputs ..... 3-9
3.3.4	Speed settings ..... 3-10
3.3.5	Ramp-function generator settings ..... 3-10
3.3.6	Speed monitoring settings ..... 3-11
3.3.7	Speed control settings ..... 3-11
3.3.8	Torque limits ..... 3-12
3.3.9	Key and control words ..... 3-12



3.3.10	Settings for NC auxiliary function M19 (oriented spindle stop) .....	3-14
3.3.11	Settings for motor data and cable resistance .....	3-15
3.3.12	Assignment and normalization of the D/A converters and measuring sockets .....	3-16
3.3.13	Settings for the DC link voltage, forming the DC link capacitors .....	3-20
3.3.14	Assigning the terminal functions .....	3-20
3.3.15	Matching the converter and motor data .....	3-22
3.3.16	Software release .....	3-26
3.3.17	P-100 operating display .....	3-27
3.3.18	Parameters for options A73, A74 and A75 .....	3-27
3.3.19	Oscillation setpoints .....	3-27
3.3.20	Motor data .....	3-28
3.3.21	Selectable relay function .....	3-28
3.3.22	Pre-control .....	3-28
3.3.23	Damping element .....	3-29
3.3.24	Motor data for the delta connection .....	3-29
3.3.25	Relay function assignments .....	3-29
3.3.26	Synchronizing controller gain .....	3-30
3.4	Start-up instructions .....	3-31
3.4.1	Start-up of the M19 NC auxiliary function .....	3-38
3.4.2	AC main spindle drive as slave drive .....	3-40
3.4.3	Star-delta motors .....	3-43
3.4.3.1	Connecting diagram .....	3-43
3.4.3.2	Circuit and function description .....	3-44
3.4.3.3	Example of a star - delta changeover .....	3-44
3.4.3.4	Handling setting parameters P-83 to P-86, P-241 to P-243 .....	3-44
3.4.3.5	C-axis operation .....	3-45
3.4.3.6	Speed controller .....	3-45
<b>4</b>	<b>Faults</b> .....	4-1
4.1	Fault display .....	4-1
4.2	Faults after switch-on .....	4-1
4.3	Faults after controller enable .....	4-2
4.4	Fault signal list .....	4-5
4.5	Fault acknowledgement .....	4-6
4.6	Selecting the operator control interface .....	4-6
4.7	Diagnostic aids .....	4-6
4.7.1	Measuring sockets and LEDs .....	4-7
4.7.2	Transistor diagnostic parameters .....	4-7
4.7.3	Fault flags .....	4-8
4.7.4	Speed actual value fault counter .....	4-8
4.7.5	Minimum/maximum value memory (from software release 09) .....	4-8
4.7.6	Voltage-frequency (U/f) open-loop control .....	4-8

<b>5</b>	<b>Maintenance</b> .....	5-1
5.1	Inspection and servicing .....	5-1
5.1.1	Maintenance of the E45 external heat dissipation option .....	5-1
5.1.2	Technical data of the fan motors, option E45 .....	5-1
5.2	Software replacement and initialization .....	5-2
5.3	Spare parts .....	5-3
<b>6</b>	<b>Appendix</b> .....	6-1
6.1	Block diagram .....	6-1
6.2	Connecting diagram .....	6-3
6.3	Circuit diagrams .....	6-5
6.4	Dimension drawings .....	6-33
6.4.1	Inverter dimension drawings .....	6-33
6.4.2	E45, external heat dissipation option .....	6-38
6.4.3	E55, connecting flange option .....	6-42
6.5	Location of the interfaces .....	6-44
6.6	Overview of the setting parameters .....	6-46
6.7	Parameter list .....	6-47
6.8	Setting and check data .....	6-53
6.9	ECB instructions .....	6-61
6.10	Standards and specifications .....	6-62

# 1 Product description

## 1.1 Application

SIMODRIVE 650 transistor PWM inverters are used together with 1PH5/6 AC induction motors for machine tool main spindle drives.

They control the drive speed in 4-quadrant operation and fulfill the highest demands regarding dynamic control performance.

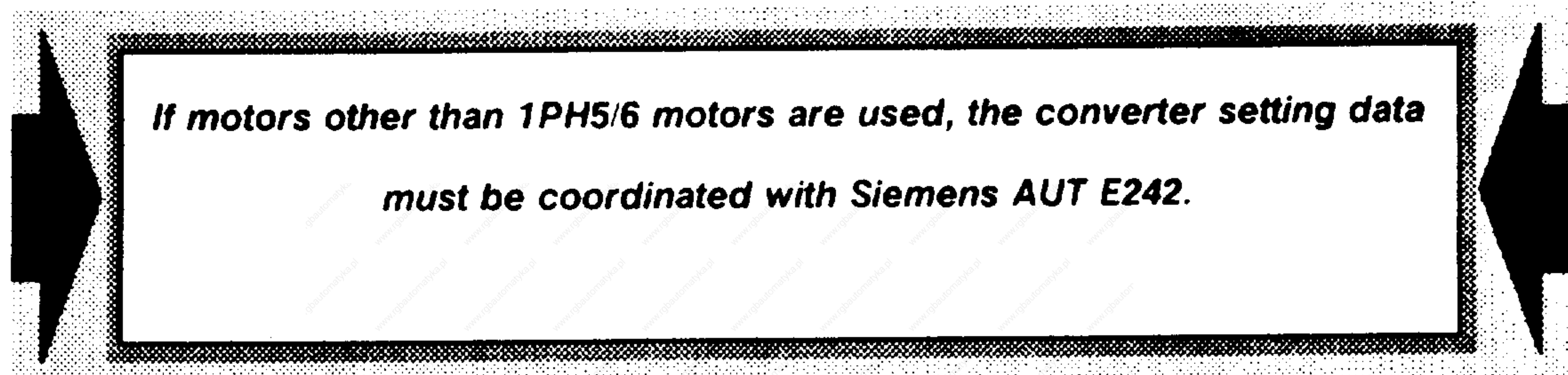

## 1.2 Mode of operation

The open-loop and closed-loop control of the AC main spindle drive is digital. It consists of the closed-loop speed controller with ramp-function generator and stored field weakening characteristic as well as a secondary torque control loop and the open-loop control system for the inverter and the sequence control.

The open-loop control system receives a torque-proportional signal. Together with the inverter, it precisely generates the frequency, amplitude and phase of the motor voltage to provide the demanded torque and magnetic field taking into account the torque and field limits (field-oriented operation). Thus, the induction motor can be controlled just like a DC motor with armature control and field weakening (Transvektor closed-loop control).

The inverter output voltages are PWM modulated with sinusoidal arithmetic average values corresponding to an AC three-phase voltage.

An encoder mounted on the motor shaft is used to sense the actual speed.

The main spindle drive inverter is supplied with 600 V DC (closed-loop voltage control with secondary current closed-loop control), generated by a 6-pulse thyristor converter and a transistor controller (step-up controller). For regenerative braking, the thyristor converter firing angle is set to 150° and the transistor controller injects PWM modulated energy back into the supply system, overcoming the inverter voltage of the thyristor bridge.

1 Product description  
1.3 Technical data

**1.3 Technical data**

Supply voltage  
Rated frequency  
Output voltage  
Output current

Output frequency  
Efficiency at rated operation  
DC link voltage  
Pulse frequency  
Power loss

Permissible output as a function of the ambient temperature

Permissible storage temperature  
Cooling type  
Installation altitude

3-ph. AC 380 V, - 10 %\*)/ + 15 %  
50/60 Hz  
3-ph. AC 430 V  
20A to 200A, depending on the inverter module used (refer to Table 1.1)  
0 to 300 Hz  
approx. 97 %  
600 V DC  
variable up to 1.8 kHz  
Refer to Fig. 1.1

Temperature	Permissible output
≤ 40 °C	$P_{max}$
> 40 °C - 45 °C	$0.88 \times P_{max}$
> 45 °C - 50 °C	$0.76 \times P_{max}$
> 50 °C - 55 °C	$0.62 \times P_{max}$

- 25 °C to + 85 °C  
Forced cooling  
The specified loading values refer to installation altitudes up to 1000 m above sea level. For installation altitudes exceeding 1000 m, the loading values must be reduced in accordance with the diagram below.

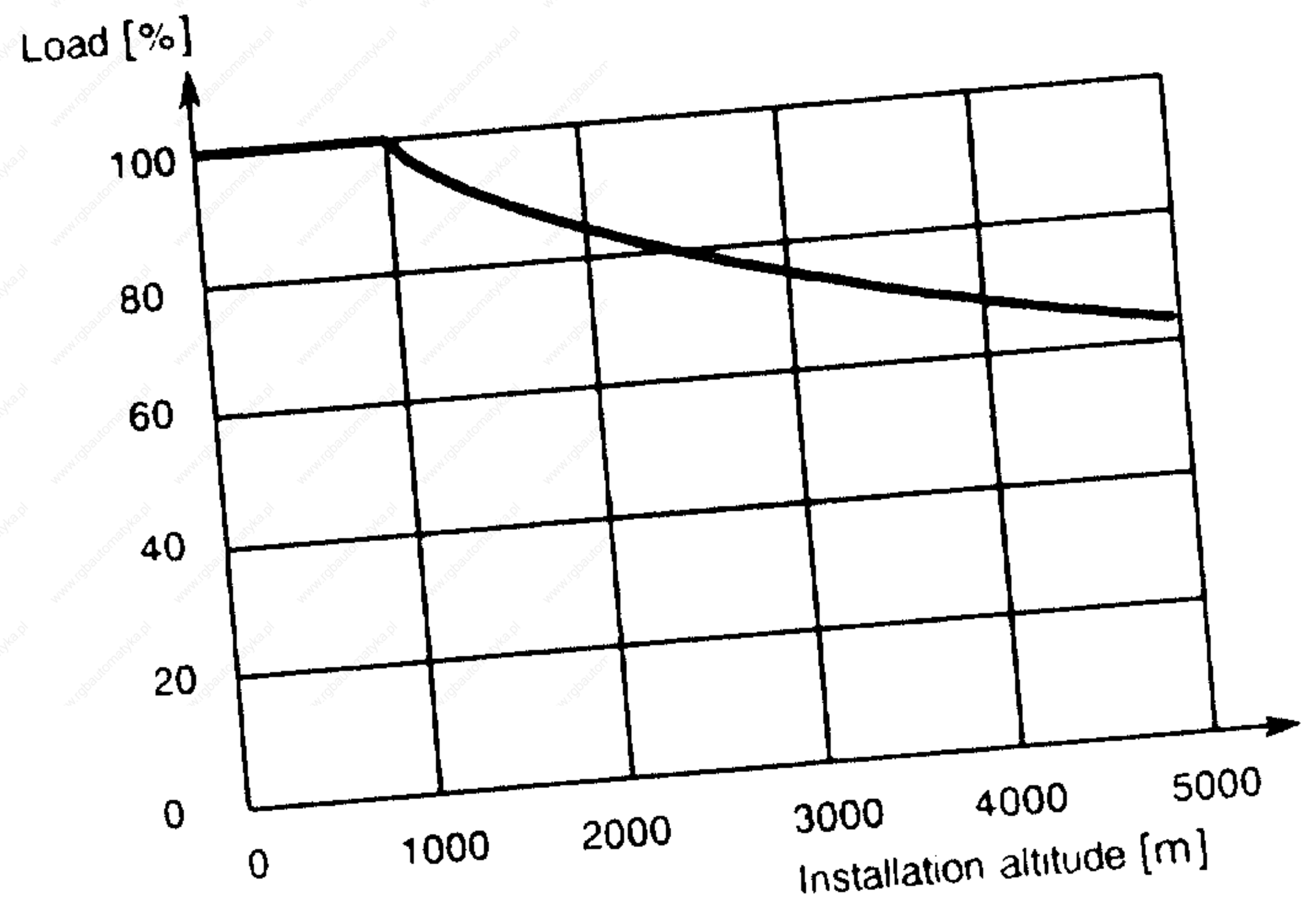

Fig. 1.1 Derating for installation altitudes > 1000 m above sea level

\*) DIN VDE 0160 specifies that the internal undervoltage monitoring must not respond to the following supply voltage waveform:  
For a supply voltage of 90% of the rated voltage, the supply voltage can dip by 20% of the peak value for 1 ms every 3.3 ms.

PWM inverter	6SC6502	6SC6503	6SC6504	6SC6506	6SC6508	6SC6512	6SC6520
Input current							
- at rated voltage	18 A	27 A	36 A	54 A	72 A	108 A	180 A
- at undervoltage	22 A	30 A	41 A	62 A	82 A	123 A	205 A
Output current	20 A	30 A	40 A	60 A	85 A	120 A <sup>*)</sup>	200 A
Apparent output power	15 kVA	22 kVA	30 kVA	45 kVA	60 kVA	90 kVA	150 kVA
Max. power loss	400 W	550 W	750 W	1100 W	1500 W	2300 W	3300 W
Input fusing	45 A	45 A	45 A (63 A)*	80 A	2 x 45 A (2x63A)*	160 A	315 A
Weight, approx.	40 kg	40 kg	55 kg	55 kg	70 kg	90 kg	225 kg

Table 1.1 PWM inverter data

The following minimum values must be maintained when selecting a matching transformer:

PWM inverter	6SC6502	6SC6503	6SC6504	6SC6506	6SC6508	6SC6512	6SC6520
$S_{\text{transformer min.}}$	14 kVA	21 kVA	28 kVA	41 kVA	55 kVA	82 kVA	136 kVA
$u_k \text{ max.}$	3 %	3 %	3 %	3 %	3 %	3 %	3 %

Table 1.2 Minimum values of the matching transformer

<sup>\*)</sup> From version A onwards

<sup>\*\*)</sup> 120 A for duty type S1 (continuous duty)

140 A for duty type S6-60% (10 min. cycle duration)

150 A for duty type S6-40% (10 min. cycle duration)

1 Product description  
 1.3 Technical data

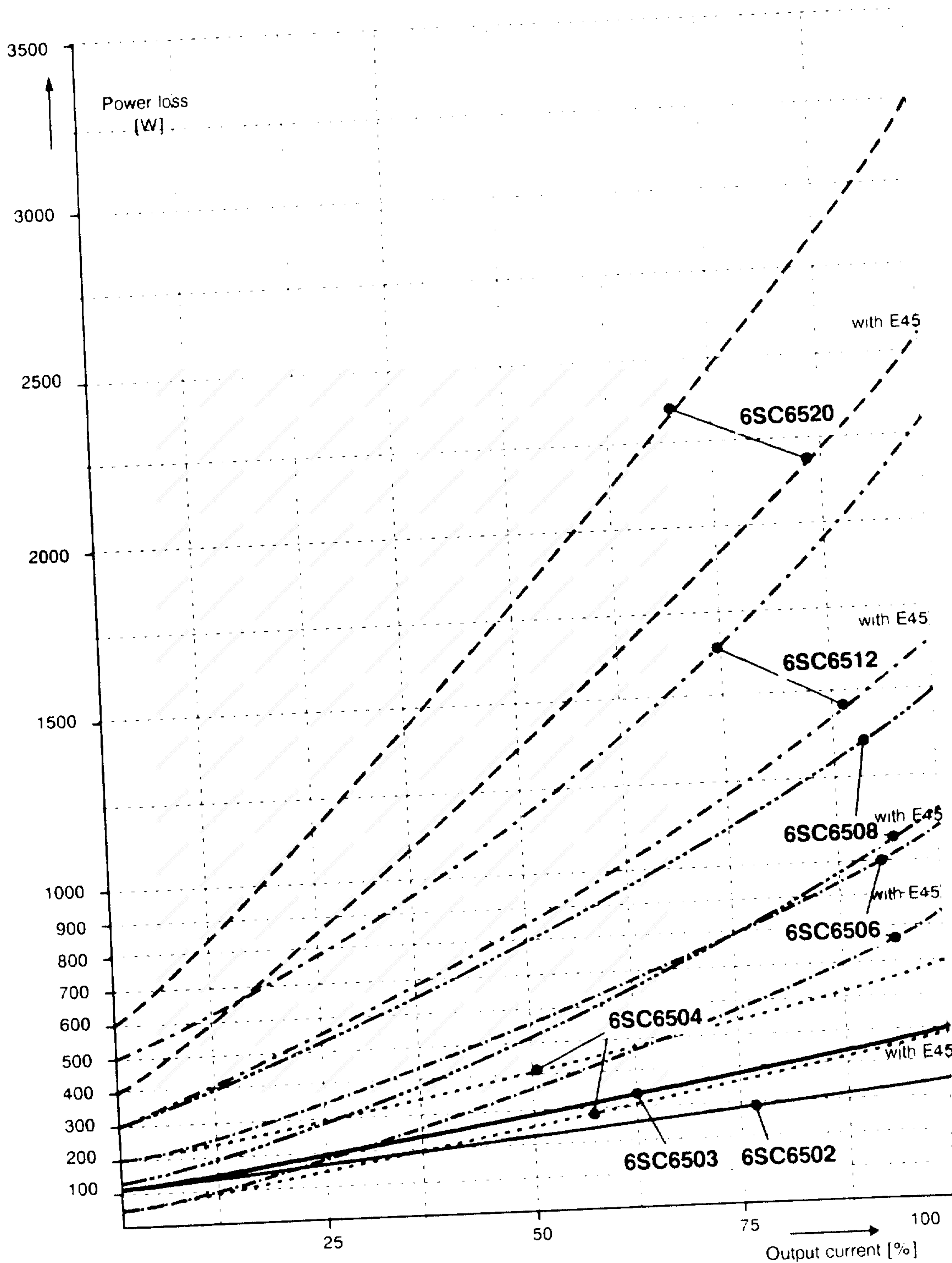

Fig. 1.2 Max. power loss at rated voltage as a function of the output current and with option E45 (external heat dissipation)  
 (The difference between both converter characteristics corresponds to the heat which is not dissipated)

## 1.4 Options

### A73 C-axis feed control

In this mode, the main spindle motor is controlled in the lower speed range (approx. 0.01 up to 300 RPM) like a feed motor. A high-resolution speed actual value sensing is necessary on the motor.

Option: Tandem encoder 1024/18000 pulses/revolution.

Positioning using a numerical control with this equipment is then possible to approx.  $\pm 0.01^\circ$ . This value is dependent on the machine tool as well as the higher-level position control loop.

### A74 Spindle positioning (without NC)

Accurate main spindle positioning and position holding is necessary for tool changing and workpiece measurement. If this function is not available in the CNC control, it can be realized with the required accuracy of  $0.1^\circ$  in various positions from the position control loop, using the "spindle positioning" option. The position sensing can be realized using an encoder mounted on the spindle or from an encoder in the motor with external zero mark (e.g. Bero proximity switch).

Position setpoint input is realized using the standard parameter input or externally through a 16-bit parallel interface.

Two positions with different  $K_v$  factors can be selected. One of these positions can be approached from 4 gearbox stages.

### A75 Feed closed-loop control for C axis and spindle positioning

Both options (A73 and A74) are located on a PC board.

### E45 External heat dissipation

With this equipment, the cooling air circuit for the inverter module is separated from the inside of the machine tool cubicle for 6SC6504, 6SC6506, 6SC6508, 6SC6512 and 6SC6520 converters. The inverter module heat loss must, in this case, not be taken into account when calculating the heat dissipating measures for the cubicle.

Further, the cooling air is filtered. The incorporated standard filter element filters-out particles having a diameter  $> 5 \mu\text{m}$ .

### E55 Connecting flange for option E45

The equipment consists of connecting flanges on the cooling air circuit for the inverter module of units 6SC6504, 6SC6506, 6SC6508 and 6SC6512. This allows the inverter module heat loss to be dissipated through a separate cooling air circuit at the installation.

6SC6520 units are always supplied with a connecting flange.

## 2 Installation

### 2.1 Mounting

The PWM inverters are designed for vertical mounting in cubicles or machine racks. They should be mounted with the supply and motor connections towards the bottom.

The mounting dimensions and position of the retaining points should be taken from the dimension drawings.

It should be ensured that the cooling air intake and discharge are not restricted; a free space of 100 mm must be available above and below the units. The units should be mounted so that they are protected from conductive dust deposits and vapors.

### 2.2 Connecting-up

The units should be connected-up according to the connecting diagram. Setpoint and actual value cables should be screened and routed separately from the load connecting cables and contactor control cables. The screen conductors should be directly connected to the unit grounding bar. The control cables for the input/output board should be routed separately from the contactor control cables.

A grounded supply must be used. SIMODRIVE units must not be connected to supplies with ELCBs. It should be ensured that the supply and the connection between the PWM inverter and motor has a clockwise phase sequence. The motor cables should be twisted with the ground cable, or a 4-core cable with ground conductor should be used. The ground cables of the supply and motor feeder must be connected together at the grounding bar or at the grounding stud of the equipment. Electronic component faults in the installation can occur if the motor is not correctly grounded.

**A contactor must be installed between the AC motor and PWM converter if the user requires electrical isolation between the AC motor and the voltage source for safety reasons.**

**The control must be designed so that this contactor is only switched under a zero-current condition i.e. at pulse inhibit (terminal 63 not energized). Further, terminal 63 should be additionally interlocked with an auxiliary contact of the auxiliary contactor.**

**A delayed-dropout contactor should be used as auxiliary contactor so that the buffer time of the PWM inverter is bridged even when the supply fails. The auxiliary contactor must bridge the maximum response time of terminal 63 (pulse enable) of 40 ms. For a DC-operated contactor (3TB4.17-0B), this can be achieved by using a free-wheeling diode (3TX6406-0H) for the contactor coil.**

A 16-core screened cable must be used to connect the motor encoder to the inverter (Section 2.2.1). The encoder cable screen must be connected with the electronics ground at the grounding bar after the insulation has been removed. In order to prevent a ground current loop, the encoder cable screen must not be connected to the motor connector housing. The screen must be connected to pin H of the connector. Thus, the internal screen of the encoder electronics is connected with the encoder cable screen, and thus with the electronics ground. The NC PWM inverter connection to ground should be as short as possible (minimum cable cross-section, 10 mm<sup>2</sup>). The electronics ground is connected to PE (housing) in order to provide the shortest possible path for the capacitive current between the inverter module and electronics to PE. The connection is provided on the rear-panel wiring between connector X1 and the housing (Figs. 6.1a, 6.2c, 6.3c, 6.4c).



2 Installation  
2.2 Connecting up

If the complete electrical equipment of a machine tool is subject to a high-voltage test, then it is absolutely essential that all SIMODRIVE connections are removed. If this is not done, the electrical and electronic unit components could be destroyed.

In operation, the covers must be firmly screwed into place in order to ensure a reliable ground connection.

The encoder cable between the motor and PWM inverter is available as pre-assembled cable.



### 2.2.1 Motor-PWM inverter connecting cable

Connector at the SIMODRIVE 650 unit  
U1-X131

Connector at the 1PH5/6 motor

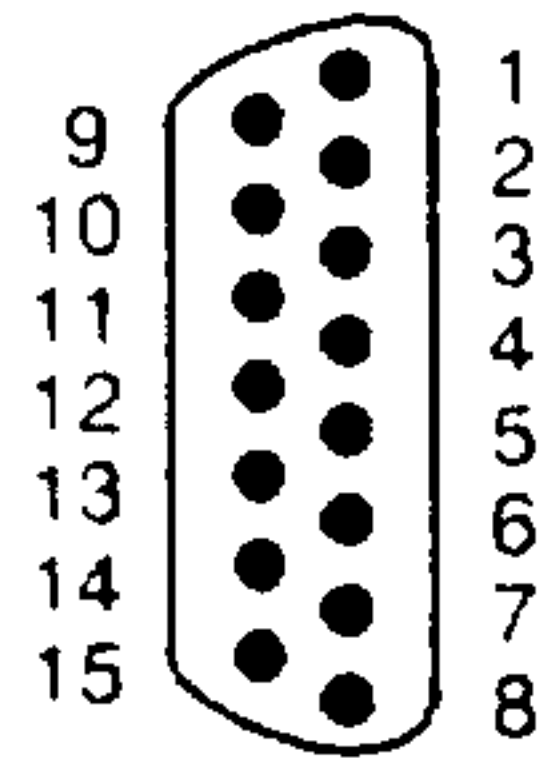

Order No. (machine readable order designation):  
 Connector 6ZY1075-0AA00  
 Cable entry 6ZY1076-0AA00  
 Mounting plate 6SY9070  
 Latch 6SY9071

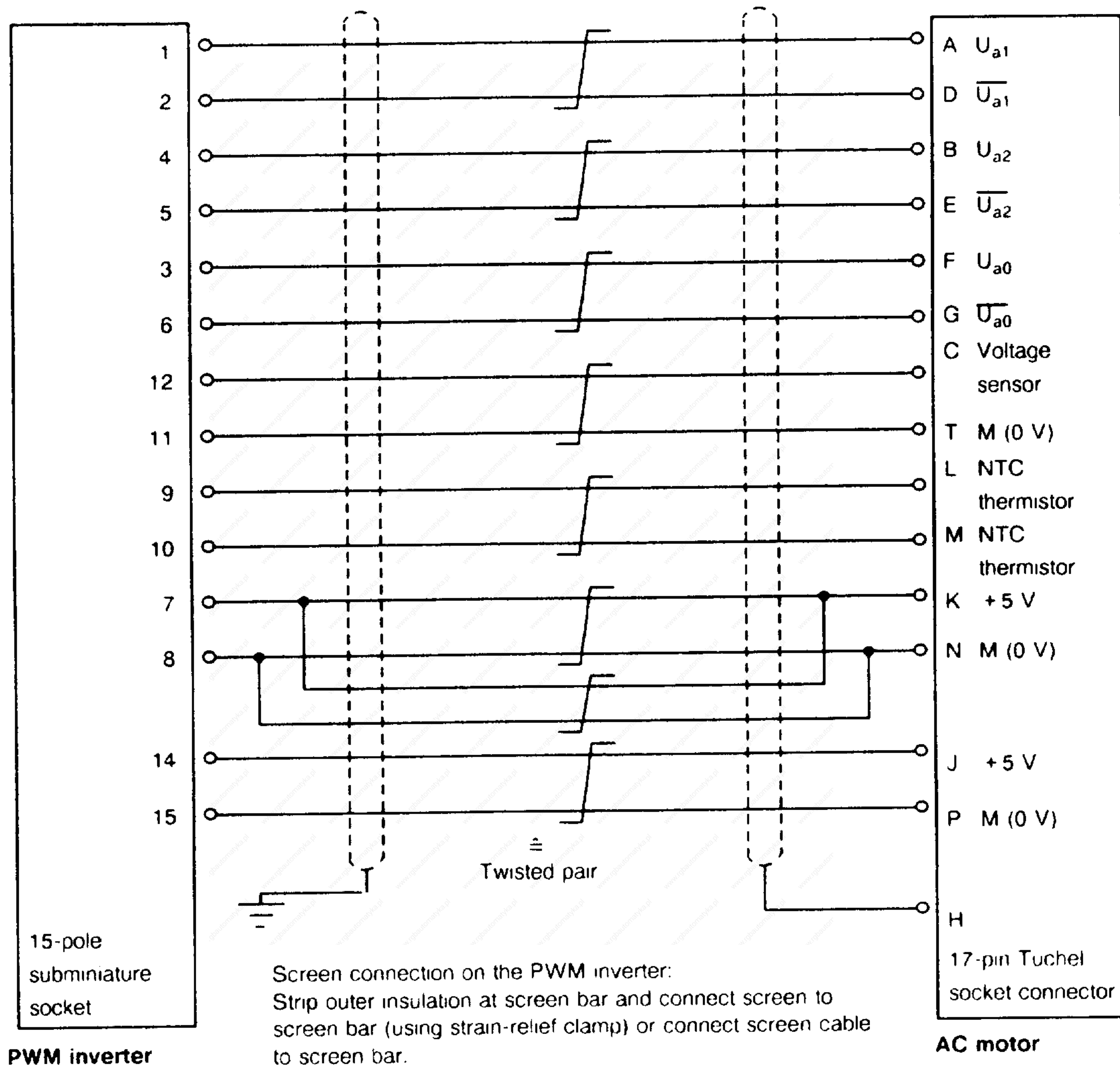
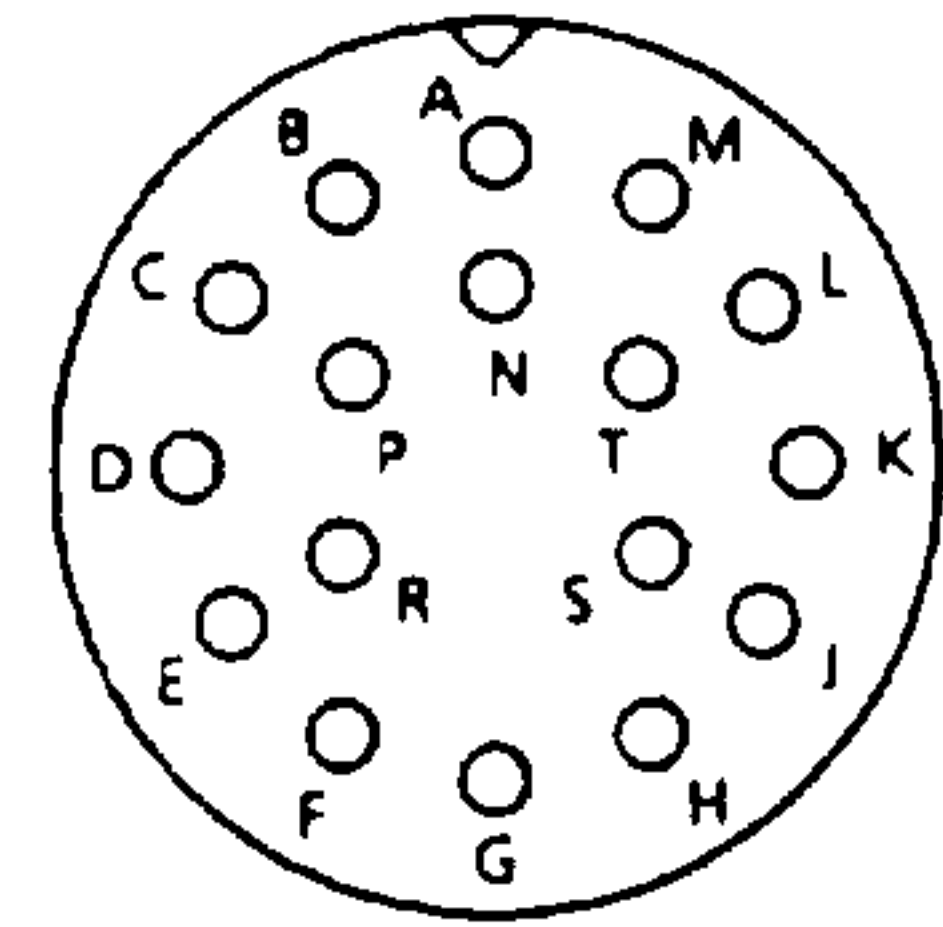

Encoder cable  $8 \times 2 \times 0.18 \text{ mm}^2$  screened, with twisted pairs with connectors Order No. 6FC9348-0A.  
 By the meter, without connector Order No. 6FC9343-0AA

Fig. 2.1 Encoder cable connection

## 2 Installation

## 2.2.1 Motor-PWM inverter connecting cable

## 2.2.2 Terminals

Board connector, pin	Terminal number	Signal level: **)	Function	Type	Description
U1- X111.1 X111.2 X111.3 X111.4 X111.5 X111.6	56 14 15 24 8 67		$n_{set 1 (+)}$ $n_{set 1 (-)}$ M $n_{set 2 (+)}$ $n_{set 2 (-)}$ -	I I O I I	Speed setpoint 1 (+/- 10 Volt) Ground Speed setpoint 2 (+/- 10 Volt) Unassigned
X111.7 X111.8 X111.9 X111.10 X111.11 X111.12	75 76 16 77 18 78	$10 V = n_{max}$ (P-29) $10 V = M_{dmax}$ (P-39, etc.) $5V = P_{nMotor}$	$ n_{act} $ display Reference potential $ M_{dmax} $ or $ P_{max} $ displ. Reference potential P Reference potential	O O O O O O	Analog output for connecting a meter- refer to Section 3.3 (D/A conv. 1) (D/A conv. 1) (D/A conv. 2) (D/A conv. 2) (D/A conv. 3) (D/A conv. 3)
X111.13 X111.14 X111.15	47 69 46	+ 10 V 0 - 10 V	P10 M N10	O O O	Reference voltages for speed setpoint input (max. 10 mA)
U1- X121.1 X121.2	9 19	+ 18 V	P24 Ex / 100 mA M24 Ex	O O/I	The auxiliary voltage is derived from the DC link voltage, and is thus only available after the DC link has been charged.
X121.3	63	H	Pulse enable	I	If P24 is withdrawn from term. 63, pulses are inhibited (drive coasts down)
X121.4	64	H	Controller enable	I	When P24 is applied to terminal 64, the pulses for the power transistors and the controller are enabled. The drive is brought to standstill with the selected ramp-down time (P-17) when P24 is removed (L signal).
X121.5	81	L	Ramp-function generator, fast stop	I	If P24 is withdrawn from terminal 81, $n_{set}$ is immediately set to zero.
X121.6	62	H	$T_{ramp} = 0$	I	The ramp-function generator is bypassed when P24 is applied to terminal 62.
X121.7	111	H	Torque limiting	I	Additional torque limiting is initiated when term. 111 is activated.
X121.8	60	H	Oscillation	I	An oscillating setpoint is injected for gear changing.
X121.9 X121.10 X121.11	117 *) 118 *) 119	H H H	Gearstage preselection	I	The controller parameters etc. are changed over via these terminals.
X121.12	*) 158	H	Torque control	I	Torque control is selected instead of speed control when terminal 158 is activated.
X121.13	*) R	H	Reset	I	Remote acknowledgement

For a + 24 V ( $\hat{=}$  High) input voltage, the control inputs have a current drain of 12 mA per terminal.

\*) Refer to Section 3.3.14 for multi-function inputs

\*) H: + 18 V to + 30 V, L: 0 V to + 2 V

## 2.2.3 Relay functions

Board connector, pin	Terminal number	Switching voltage		Contact	Function
		AC	DC		
G02- X141.6 X141.5 X141.4	216	60 V	30 V	NC	<b>Relay <math>n_{act} &lt; n_x</math>.</b> The relay drops-out when $n_{act} > n_x$ . This can be selected via P-23 to P-26 (dependent on the gearbox stage, in RPM). This relay can be optionally changed-over to other functions (refer to P-53 and P-185 to P-189)
	214	60 V	30 V	M	
	215	60 V	30 V	NO	
G02- X141.9 X141.8 X141.7	210	60 V	30 V	NC	<b>Relay motor overtemperature alert (motor).</b> The relay drops-out when an overtemperature condition occurs or a sensor fails. It can be selected via P-63 (°C). The drive is shutdown approx. 4 minutes later.  <b>Relay <math>M_d &gt; M_{dx}</math>.</b> The relay drops-out when $M_d > M_{dx}$ . The setting via P-47 is referred to the actual torque limiting and is suppressed for $n_{set}$ changes.
	208	60 V	30 V	M	
	209	60 V	30 V	NO	
G02- X141.1 X141.2 X141.3	109	60 V	30 V	NO	
	108	60 V	30 V	M	
	110	60 V	30 V	NC	
G02- X131.8 X131.9 X131.10	127	60 V	30 V	NO	<b>Relay <math>n_{set} = n_{act}</math>.</b> The relay pulls-in when $n_{set} = n_{act}$ , within the tolerance band selected via P-27. Load-induced speed fluctuations do no influence the relay.  <b>Ready/fault relay</b> Can be preselected via P-53 refer to Section 3.3.9 for explanations
	126	60 V	30 V	M	
	128	60 V	30 V	NC	
G02- X131.4 X131.3 X131.2 X131.1	74	60 V	30 V	NC	<b>Relay <math>n_{act} &lt; n_{min}</math>.</b> The relay pulls-in when $n_{act} < n_{min}$ . Can be selected via P-21.
	73.1*)	60 V	30 V	M	
	73.2*)	60 V	30 V	M	
	72	60 V	30 V	NO	
G02- X131.7 X131.6 X131.5	116	60 V	30 V	NC	
	114	60 V	30 V	M	
	115	60 V	30 V	NO	

Table 2.1. Connector pin assignment of the G02 central board (conductor cross-section: 0.25 - 1.5 mm<sup>2</sup>)

The relays drop-out under fault conditions. This must be taken into account when designing the external matching control.

\*) Terminals 73.1 and 73.2 are connected together through a 0 Ω resistor.

2 Installation  
 2.2.4 Connector locations

2.2.4 Connector locations

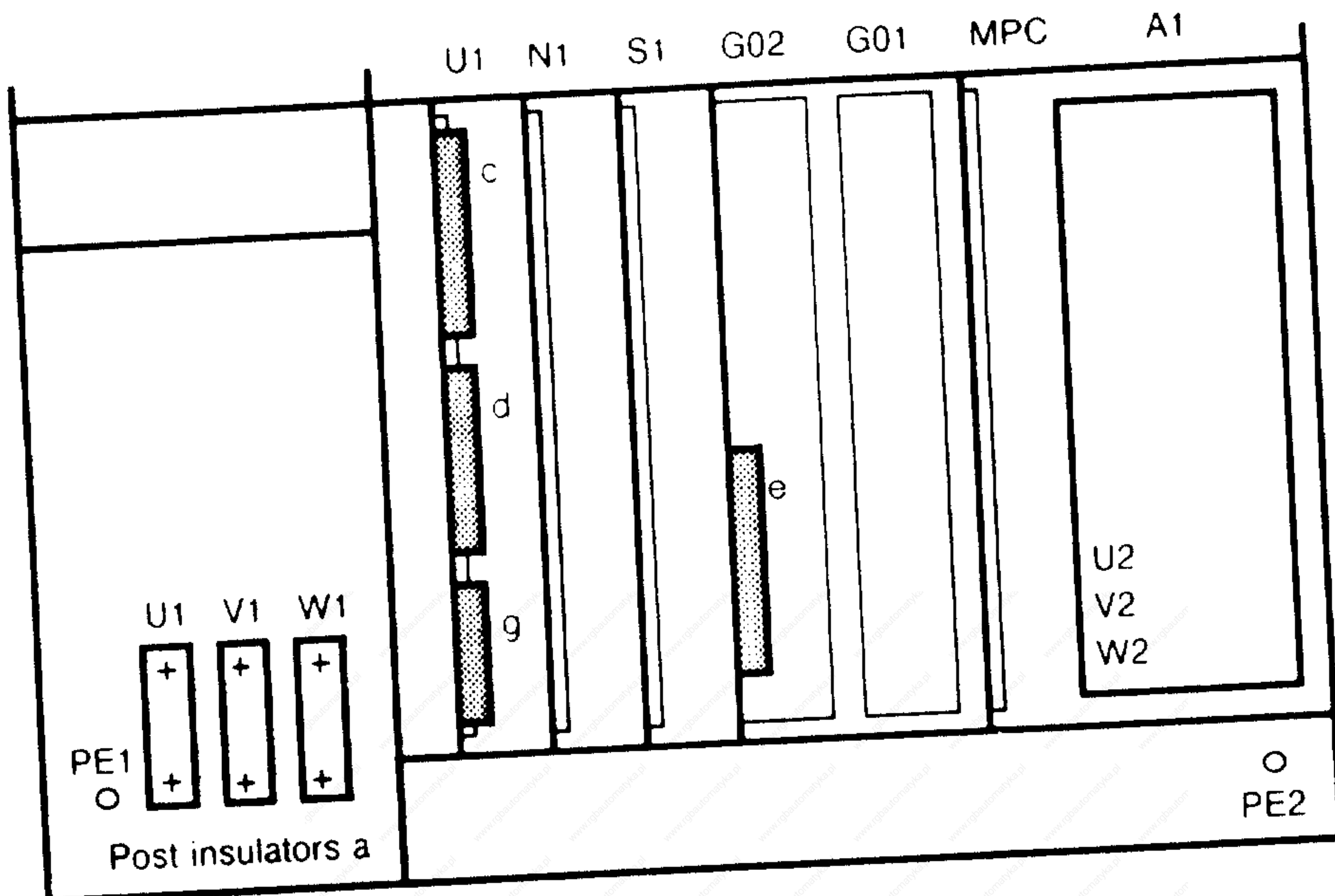

Fig. 2.2 Connector locations for transistor PWM inverters 6SC6502 and 6SC6503

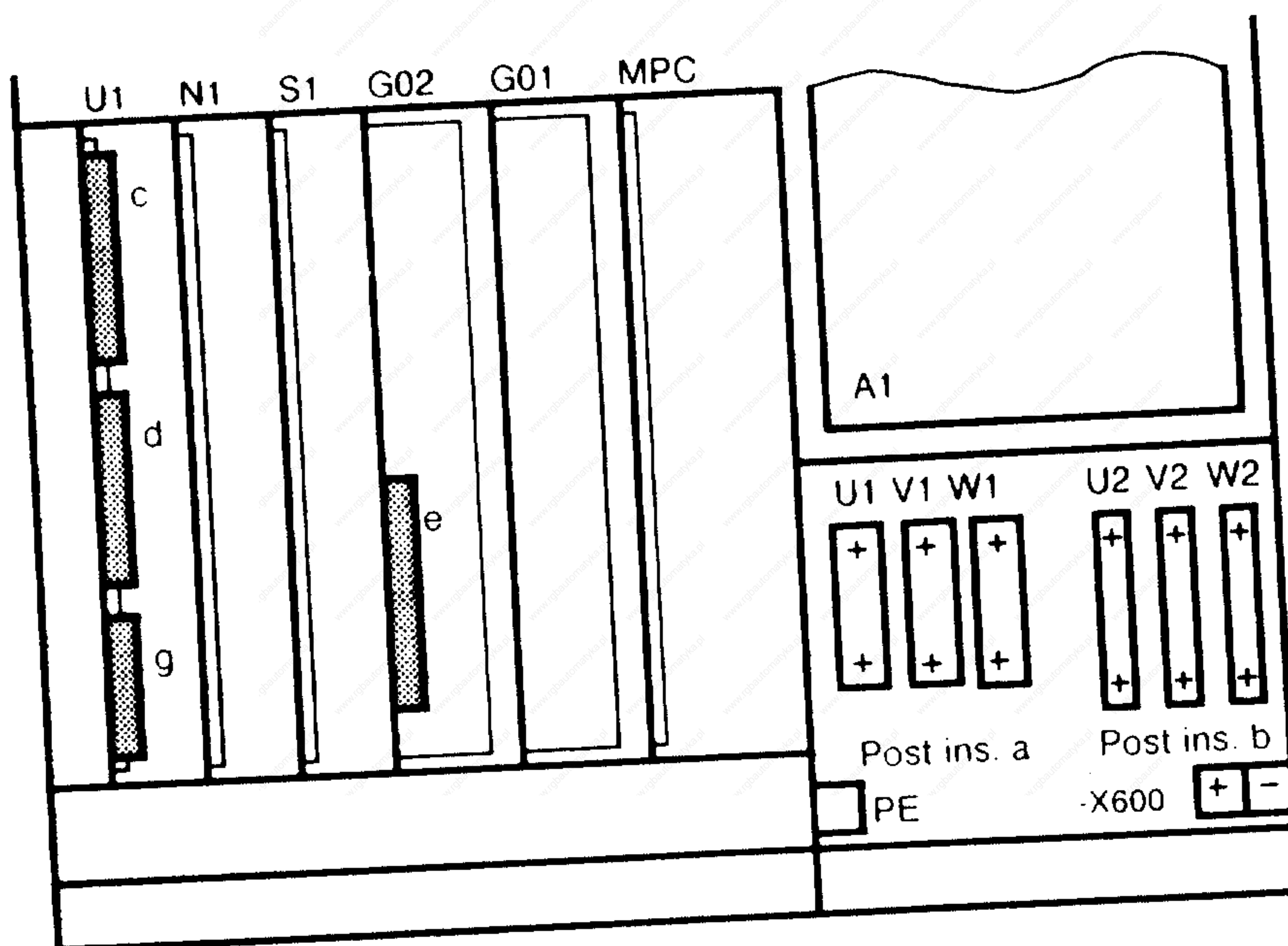

Fig. 2.3 Connector locations for transistor PWM inverters 6SC6504, 6SC6506 and 6SC6508

- |                                   |                   |
|-----------------------------------|-------------------|
| U1 = I/O board                    | c = X111          |
| N1 = Controller board             | d = X121          |
| S1 = Option                       | e = X131 and X141 |
| G02 = Central board               | g = X231          |
| G01 = Power supply                |                   |
| MPC = Option                      |                   |
| A1 = Gating board/inverter module |                   |

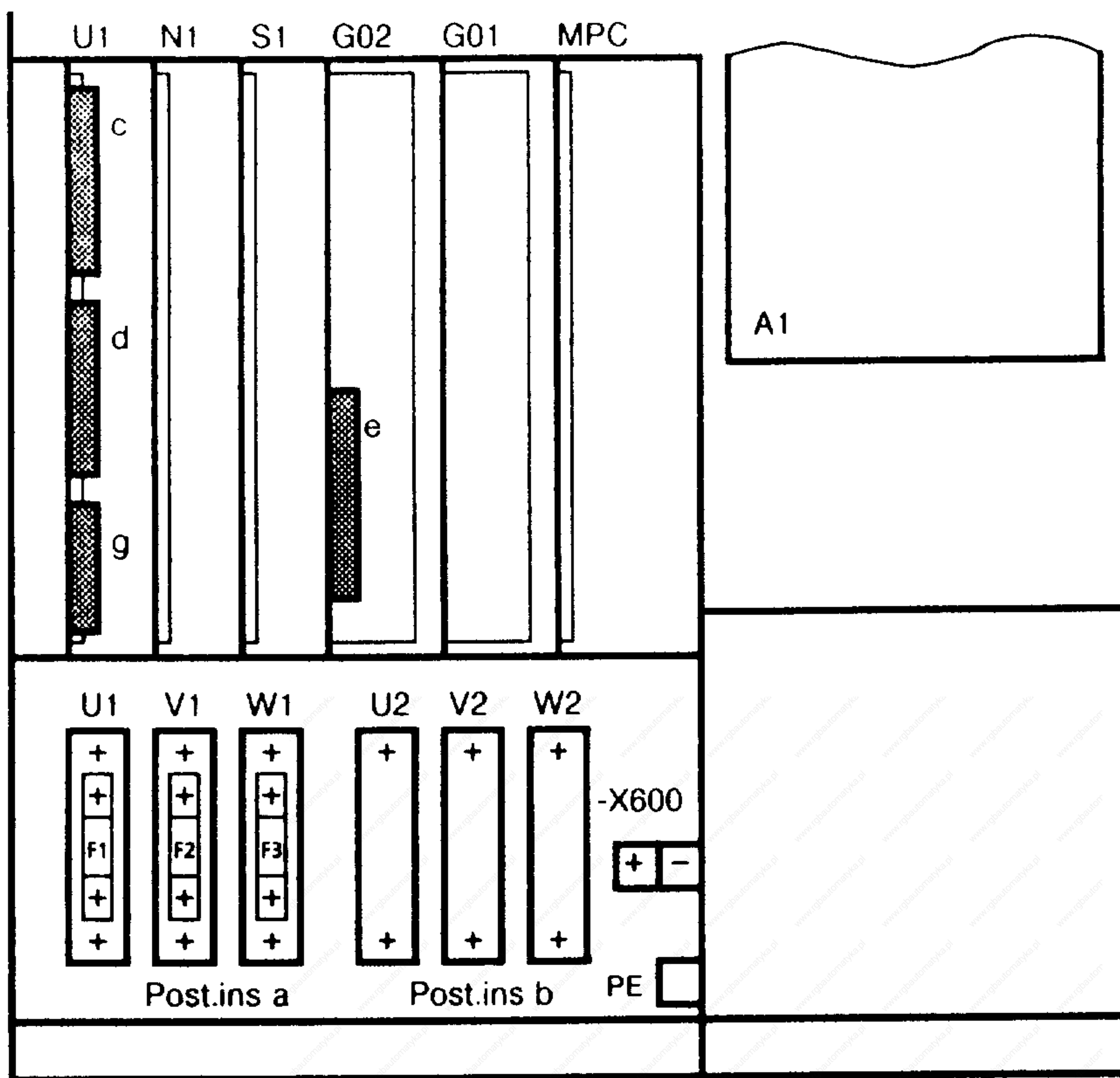

Fig.2.4 Connector locations for transistor PMW inverter 6SC6512

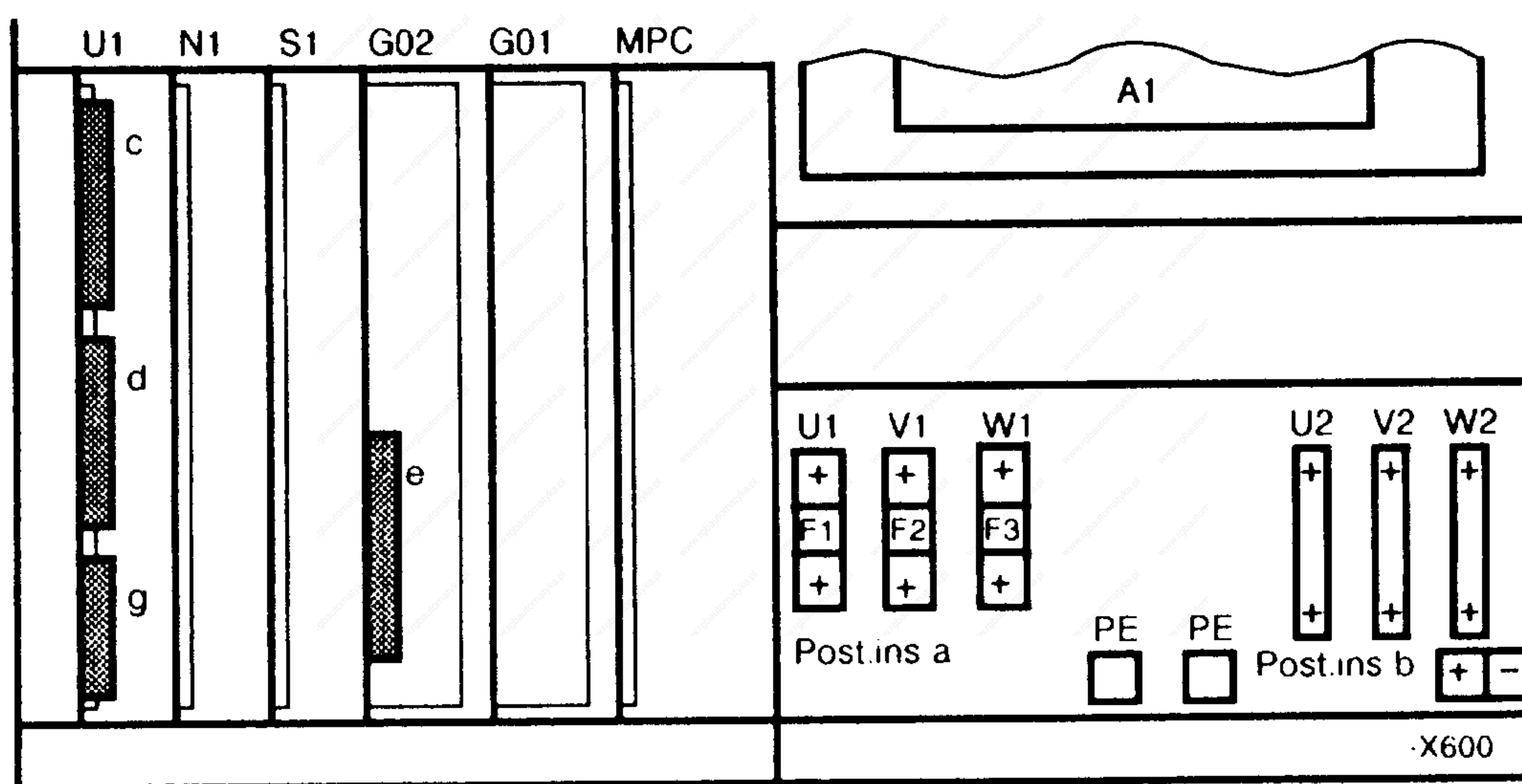



Fig.2.5 Connector locations for transistor PMW inverter 6SC6520

- U1 = I/O board
- N1 = Controller board
- S1 = Option
- G02 = Central board
- G01 = Power supply
- MPC = Option
- A1 = Gating board/inverter module

- c = X111
- d = X121
- e = X131 and X141
- g = X231

### 3 Start-up

<b>WARNING</b>	
	<p>Perfect, safe and reliable operation of this equipment is dependent on proper handling, installation, operation and maintenance.</p> <p>Non-observance of the safety instructions can result in severe personal injury or property damage.</p>
	<p>The board contains components which can be destroyed by electrostatic discharge. The human body must be electrically discharged before touching electronic boards. This can be simply done by touching a conductive, grounded object immediately beforehand (e.g. bare metal cubicle components, socket outlet protective conductor contact).</p>

#### 3.1 Operator control and display elements

The control and display system consists of three keys and one display (six-digit, 7-segment display).

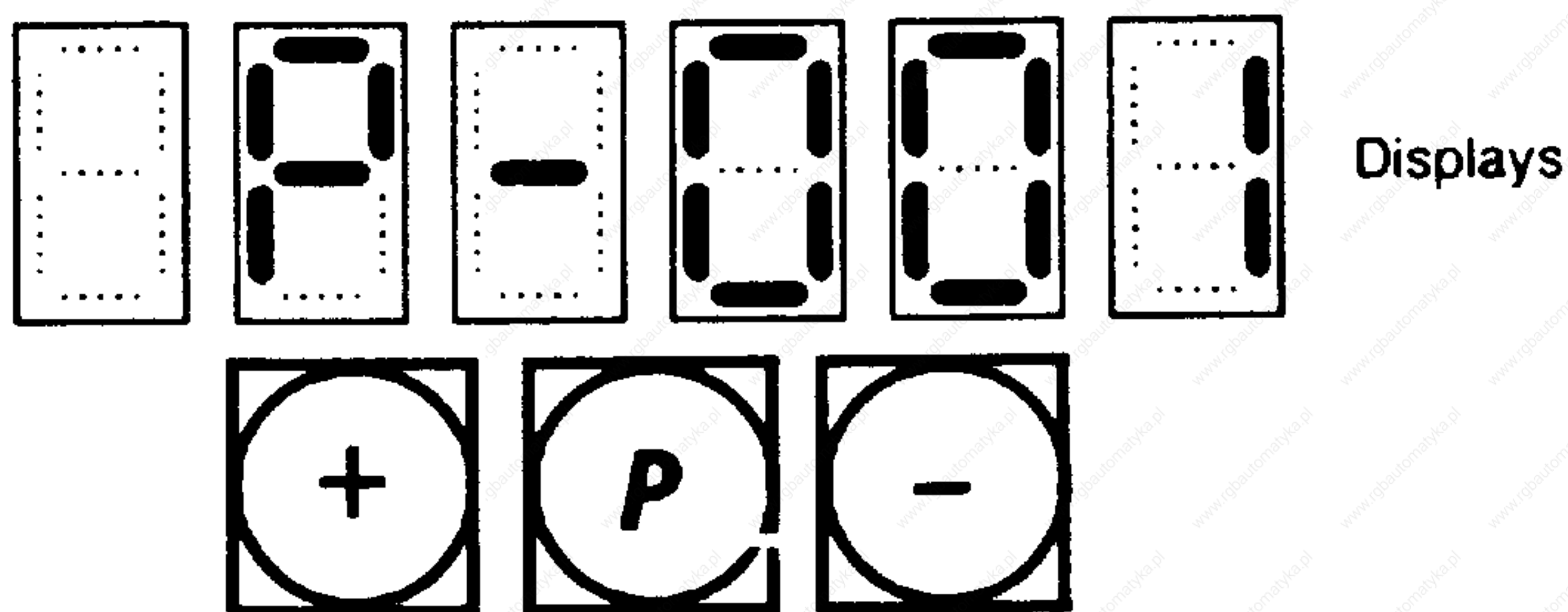

Fig. 3.1 Display board H1

The parameter setting values can be selected and changed via the display and operating and fault messages indicated.

Key	Function
"P"	Changeover parameter number to parameter value or parameter value to parameter number
" + "	Increase parameter number or parameter value
" - "	Decrease parameter number or parameter value
" + " and "P"	Fast change of the parameter number or the parameter value in the positive direction
" - " and "P"	Fast change of the parameter number or the parameter value in the negative direction

Key	Function
"P"	Fault acknowledgement with the controller inhibited
" + "	Proceed to the next fault message if several fault messages are available
" - "	Brief changeover (approx. one minute) into the operator control mode

Table 3.1 Function of the keys in the operator control mode      Table 3.2 Fct. of keys in the fault display mode

## 3 Start-up

## 3.2 Operator control and parameter displays

### 3.2 Operator control and parameter displays

The write protection (P-51) must first be cancelled before a displayed parameter value can be changed. This is realized by setting parameter P-51 to hexadecimal value 0004H. The parameter value can be increased by pressing the "+" key. The change is indicated in the display. The value is decreased by depressing the "-" key.

The parameter display can be switched between parameter number and the actual value of the selected parameter using the "P" key.

The values at the last digit are changed by "1" by briefly depressing the "+" or "-" keys. The rate of change of the displayed value increases the longer the key is depressed. The rate of change of the parameter values can be increased by a factor of 16 by simultaneously depressing the "P" key and the "+" or "-" key.

Example: Parameter P-32 (speed controller integral-action time) has to be changed from 512 ms to 70 ms.

1. Depress the "P" key to display the parameter number.
2. Depress the "-" or "+" key to select parameter P-51 (write protection).
3. Depress the "P" key to display the parameter value.
4. Depress the "+" key to select hexadecimal value 0 0 0 4 H.
5. Depress the "P" key to display the parameter number.
6. Depress the "-" key to select parameter P-32.
7. Depress the "P" key to display the parameter value.  
512 is displayed ( $\hat{=}$  512 ms).
8. Depress the "-" key to change this value to 70 ( $\hat{=}$  70 ms).

The change is immediately effective but is not stored.

The example shows that parameters are set in physical quantities. The setting range can be pre-programmed per software. In the example above, the integral-action time can be set between 5 ms and 6000 ms, in a minimum of 1 ms increments ( $\hat{=}$  0.2 ‰). The values are either displayed in decimal or in hexadecimal format. For hexadecimal display, the letter "H" is inserted at the last display digit. Leading zeros are not suppressed.

If the hexadecimal format is selected, a decimal point is inserted at the last digit when the parameter number is displayed. Limit values (maximum/minimum) are stored in the software for decimal value changes, which means that a parameter can only be changed within the stored limits.

With just a few exceptions (e.g. P-110, P-115, P-116 etc.) parameter changes become immediately effective via the RAM memory. If the setting is to be stored, parameter P-52 (EEPROM write) must be set to 0 0 0 1 H. 0.0.0.0.H re-appears in parameter P-52 after the value has been written into the EEPROM. In order to transfer the setting into the EEPROM, the write protection must also be cancelled in the hardware. This is realized by opening the write protection jumper S1 on control board N1.



### 3.3 Parameter grouping

The parameters in brackets are displays, while all other parameters can be changed after writing into parameter P-51.

The parameters are subdivided into the following groups:

- Operating display (refer to Section 3.3.1) (P-00)
- Measured value and status displays (refer to Section 3.3.2) (P-01 to P-11)  
(P-201 to P-208)
- Analog outputs (refer to Section 3.3.3) P-12, P-13
- Speed settings (refer to Section 3.3.4) P-14, P-15
- Ramp-function generator settings (refer to Section 3.3.5) P-16 to P-18
- Speed monitoring settings (refer to Section 3.3.6) (P-20) to P-29
- Speed control settings (refer to Section 3.3.7) P-31 to P-38
- Torque limit values (refer to Section 3.3.8) P-39 to P-50
- Key and control words (refer to Section 3.3.9) P-51 to P-53,  
P-90, P-151,  
P-152, P-251
- Settings for the M19 NC auxiliary function  
(refer to Section 3.3.10) P-54 to P-62  
P-253, P-254
- Settings for motor data and cable resistance  
(refer to Section 3.3.11) P-63 to P-65  
P-81, P-82
- Assignment and normalization of the D/A converter and  
measuring sockets (refer to Section 3.3.12) P-66 to P-69  
P-76 to P-80
- DC link voltage settings,  
forming the DC link capacitors (refer to Section 3.3.13) P-74, P-75
- Assigning the terminal functions (refer to Section 3.3.14) P-83 to P-86  
(P-30)
- Matching the converter and motor data (refer to Section 3.3.15) P-94 to P-98
- Software release (refer to Section 3.3.16) (P-99), (P-199)
- Operating display (expanded with option functions)  
(refer to Section 3.3.17) (P-100)
- C-axis settings (refer to Operating Instructions 6SC6501-0AC00) (P-101) to P-119  
P-157 to P-159  
P-195, P-239
- Positioning settings  
(refer to Operating Instructions 6SC6501-0AD00) P-120 to P-150  
P-249
- Oscillation settings (refer to Section 3.3.19) P-154 to P-156
- Motor data (refer to Section 3.3.20) P-160 to P-177
- Selectable relay functions (refer to Section 3.3.21) P-185 to P-189
- Pre-control (refer to Section 3.3.22) P-190
- Damping element (refer to Section 3.3.23) P-196 to P-198
- Motor data for delta connection (refer to Section 3.3.24) P-220 to P-237
- Relay function assignments (refer to Section 3.3.25) P-241 to P-243
- Synchronizing controller gain (refer to 3.2.26) P-252

### 3.3.1 Operating display

(P-00) The parameter value for parameter 0 indicates the unit operating status.

#### 3.3.1.1 Significance of the first digit



The first digit from the left is not driven in the operating display and remains dark.

#### 3.3.1.2 Significance of the second digit

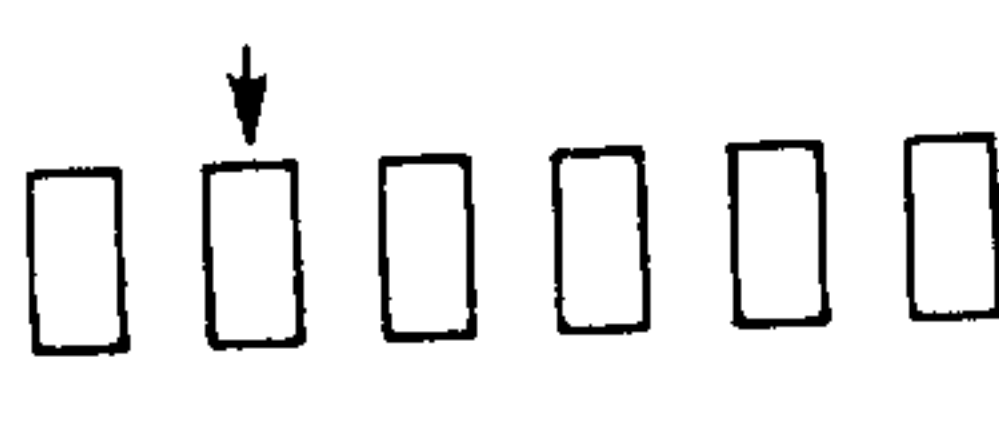

The statuses of the relay functions are indicated in the second digit from the left after the DC link charging has been completed.

The individual display segments are assigned as follows to the relay functions:

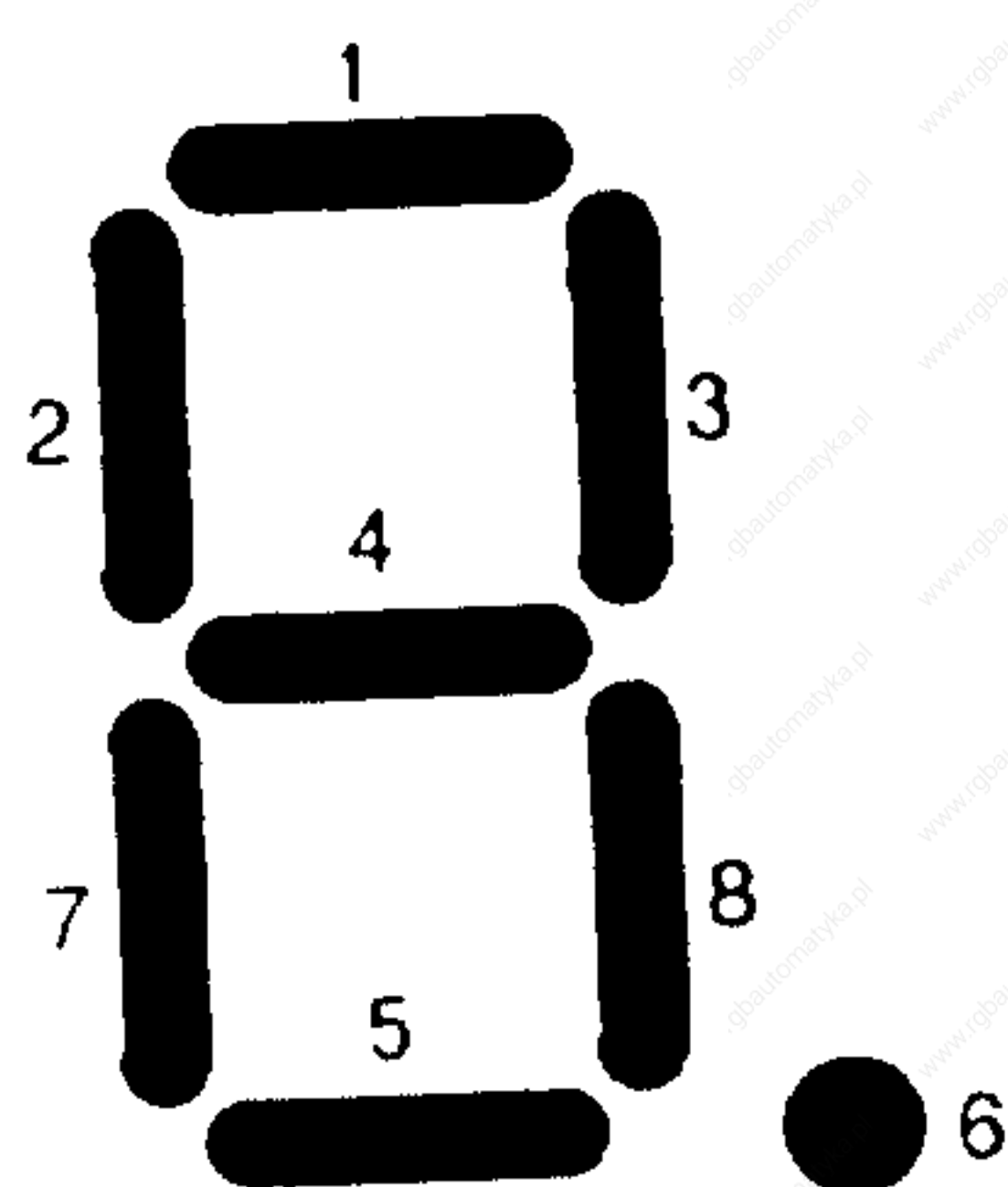

Segment	Significance	Response value in the parameter
1	$n_{act} < n_x^*)$	P-23, P-24, P-25, P-26
2	$M_d > M_{dx}^*)$	P-47
3	Motor overtemperature alert	P-63
4	$n_{set} = n_{act}$	P-27
5	$n_{act} < n_{min}^*)$	P-21
6	Ready/fault	P-53
7	Position limit value 1 reached (option A74)	P-144
8	Position limit value 2 reached (option A74)	P-145

The individual segments are lit when the associated relay signal is active, i.e. the relay has pulled-in.

\*) From software release 12, the function of this relay can be changed over (refer to P-241 to P-243).

## 3.3.1.3 Significance of the third digit

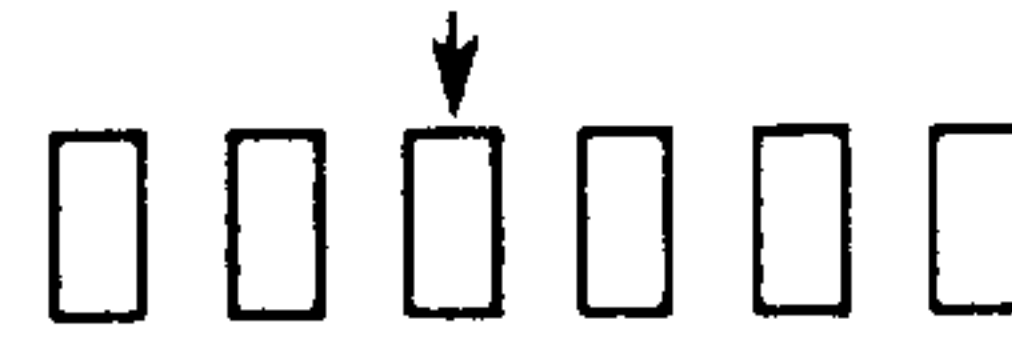

Symbols with the following significance are inserted here:

Symbol	
	: The unit is in a wait condition The progression condition is displayed at the next digit.
	: All enable signals are available, speed control is preselected.
	: All enable signals are available, torque control is preselected.
	: All enable signals are available, M19 control is selected.
	: All enable signals are available, U/f open-loop control
	: All enable signals are available, speed control in the C-axis mode is preselected.
	: Holding brake in the C-axis mode
	: All enable signals are available, position control is selected.

3 Start-up  
 3.3.1 Operating displays

### 3.3.1.4 Significance of the fourth digit

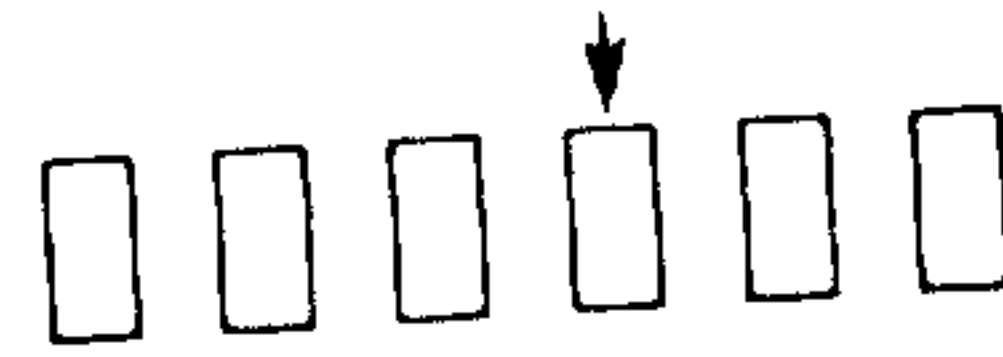

The progression conditions are displayed at the fourth digit from left before the motor starts.

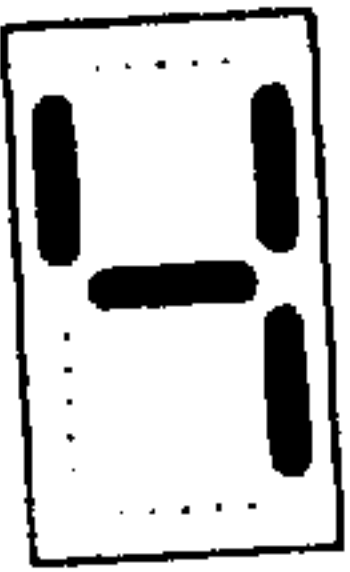
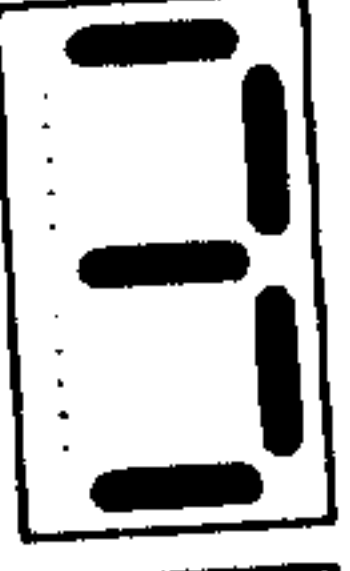
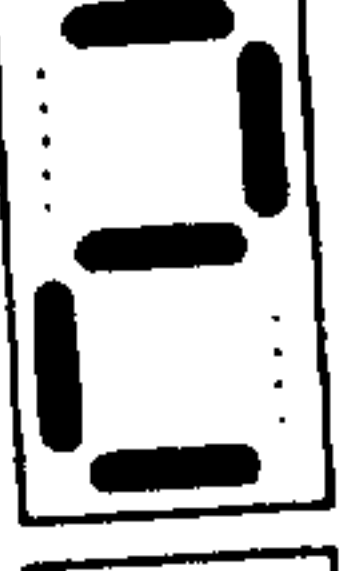
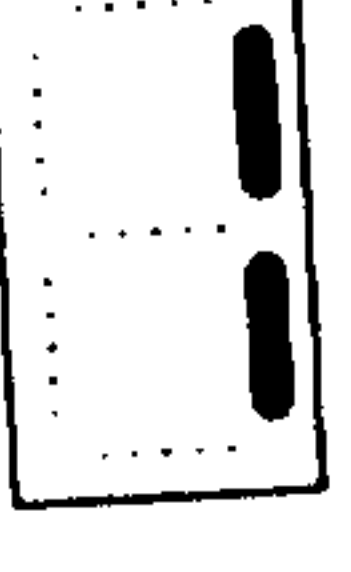
- Symbol
-  : Enable signal for supply gating unit missing
  -  : DC link still not charged
  -  : Pulse enable signal missing (terminal 63)
  -  : Control enable signal missing (terminal 64)
  -  : Ramp-function generator enable signal missing (terminal 81)

When these conditions are fulfilled, the torque direction demanded from the closed-loop control is indicated at the fourth digit:

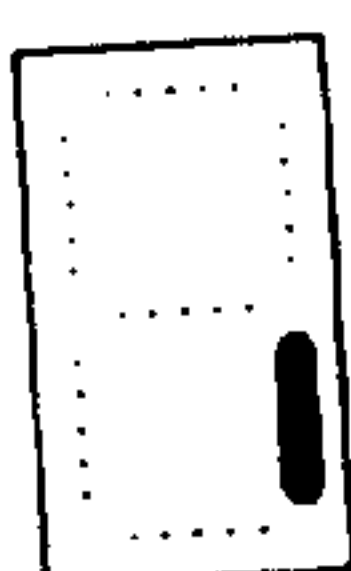
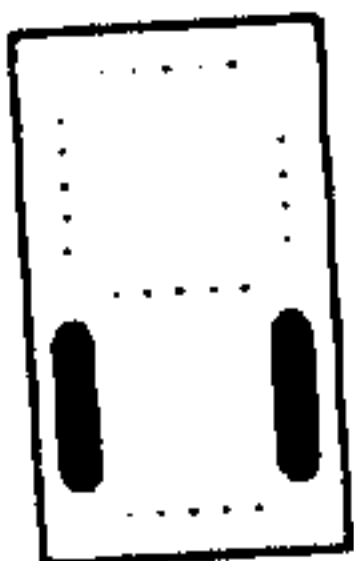
- Symbol
-  : Motor operation
  - or
  -  : Generator operation

### 3.3.1.5 Significance of the fifth digit

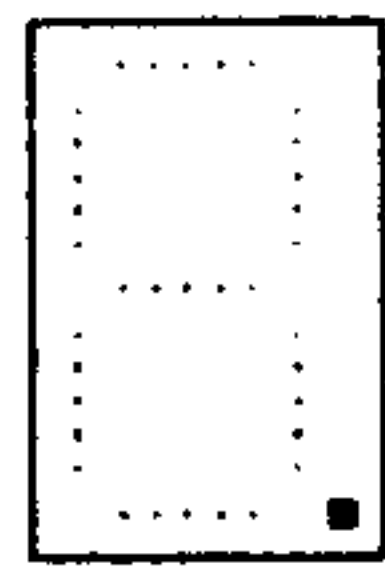

: Damping element is activated (P-196, P-197, P-198)

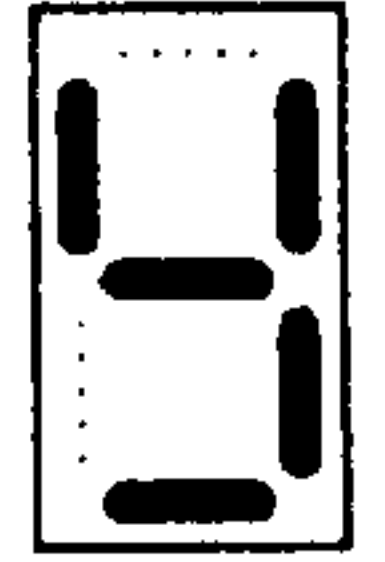

: Star connection is selected

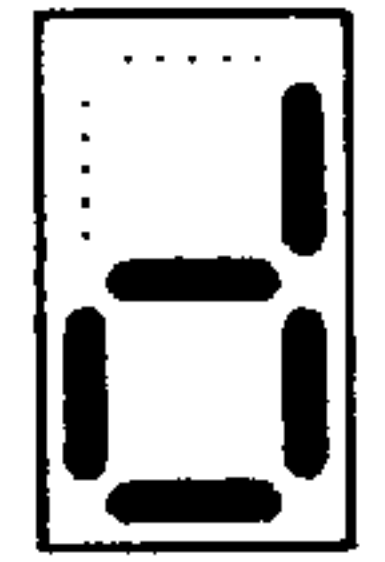

: Delta connection is selected

} When using star-delta motors

### 3.3.1.6 Significance of the sixth digit

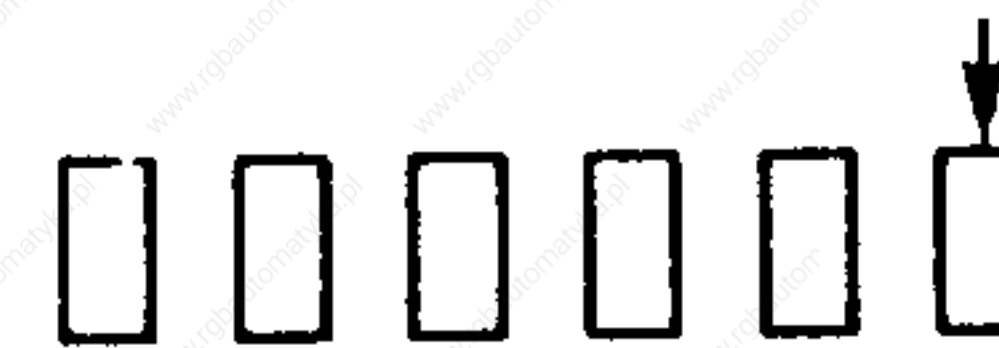

The sixth digit from the left indicates the preselected gearbox stage. A "1" is inserted if a gearbox stage is not available or has not been selected.

Symbol

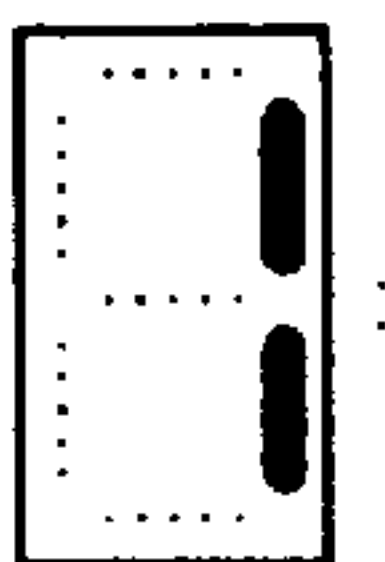

: Terminals 117, 118 and 119 are not activated (gearbox stage 1)



: Terminal 117 is activated (gearbox stage 2)

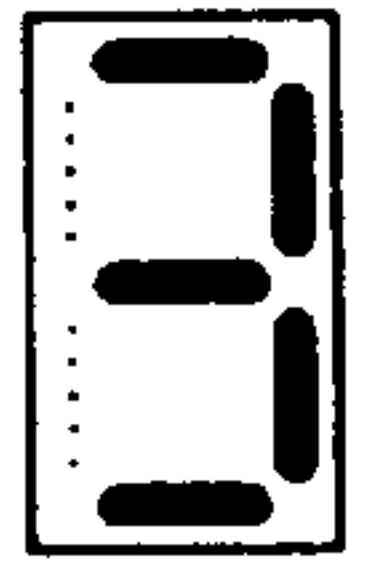

: Terminal 118 is activated (gearbox stage 3)

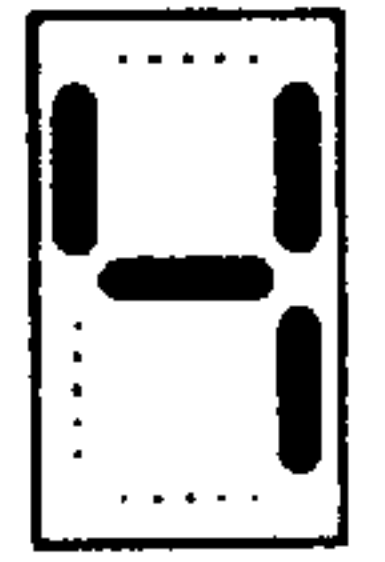

: Terminal 119 is activated (gearbox stage 4, P-83 = 1)

3 Start-up  
3.3.2 Measured value and status displays

### 3.3.2 Measured value and status displays

The following displays are assigned to parameters P-01 to P-11:

P-01  
to  
P-11

Parameter	Display	Units	Format
P-01	Speed setpoint	%	- 100.0 - + 100.0
P-02	Speed actual value	RPM	- 16000 - + 16000
P-03	Torque-generating current components	%	-180.0 - + 180.0
P-04	$M_d/M_{dmax}$ or above $n_{rated} P/P_{max}$ (P-39)	%	0 - + 100.0
P-05	Motor frequency	Hz	0 - + 300.0
P-06	DC link voltage	V	0 - + 660
P-07	DC link current	A	- 300 - + 300
P-08	DC link power	kW	- 160.0 - + 160.0
P-09	Supply frequency	Hz	0 - + 100.0
P-10	Stator temperature	°C	0 - + 150
P-11	Status of the binary inputs	Hex	

Example for P-11: All terminals are activated, operator control keys are not actuated.

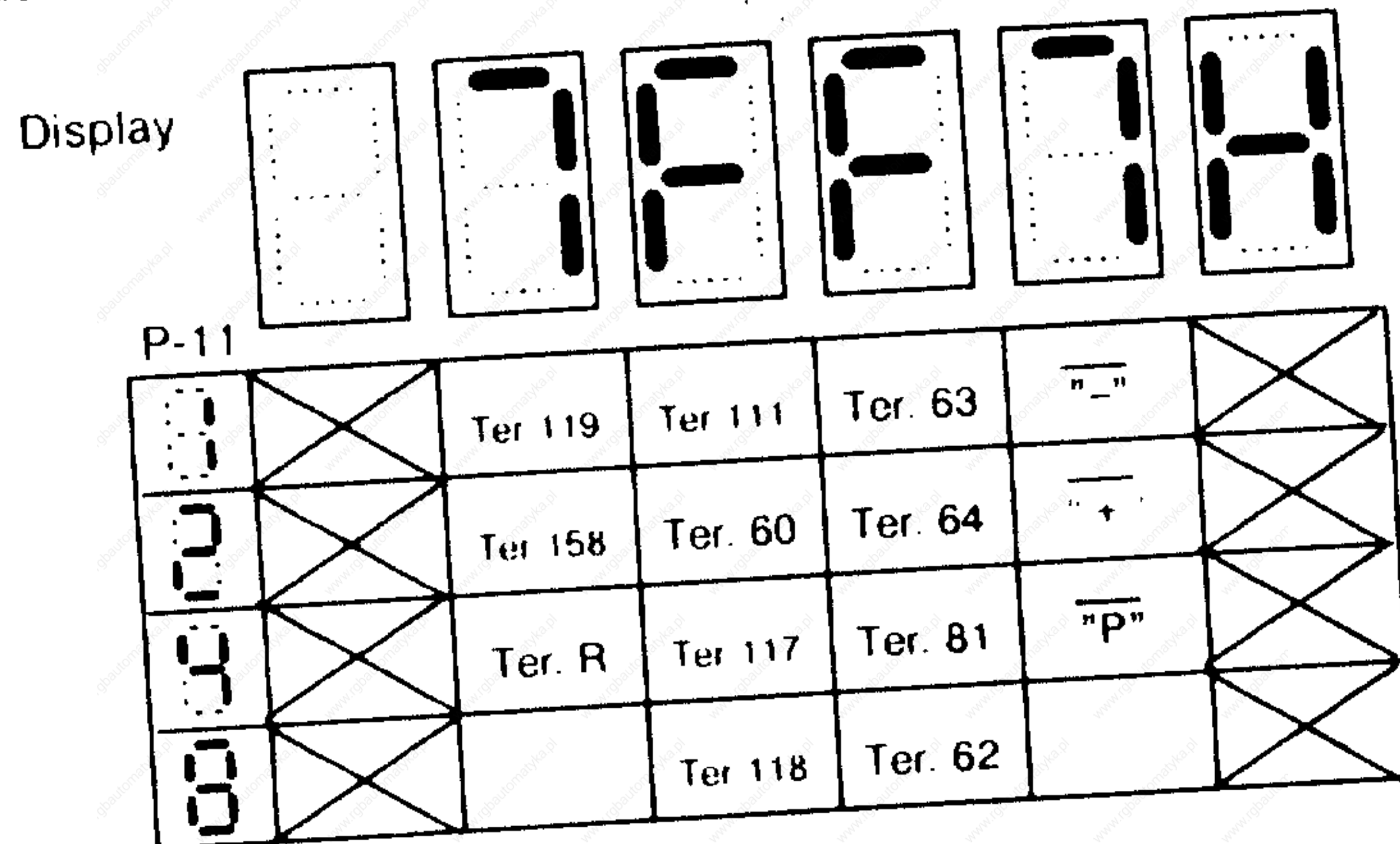

P-201  
to  
P-208

Parameter	Display	Units	Format
P-201	Position setpoint	Dec	0 - 64000
P-202	Position actual value	Dec	0 - 64000
P-203	Position setpoint	Hex	0000 - FFFF
P-204	Unassigned	-	-
P-205	Motor frequency	[Hz]	0 - 750
P-206	Motor voltage (phase-to-phase)	[V]	0 - 450
P-207	Pulse frequency	[Hz]	0 - 1650
P-208	Pulse/motor frequency ratio	[1]	

### 3.3.3 Analog outputs

The analog output voltages at terminals 75 and 16 can be finely adjusted via parameters P-12 and P-13. For a 100.0% setting (50%), 10 V (5 V) is output for the maximum values [ $n_{\max}$  (P-29);  $M_{d\max}$ , or  $P_{\max}$  (P-39, P-46)].

**P-12** Fine normalization of the D/A converter  
|Speed actual value| (address 272 - terminal 75/76) - 200.0 % - + 300.0 %

The fine normalization is only valid if: P-66 = 0 2 7 2 H  
P-67 = 0 0 0 0 H

The speed actual value is output via terminals 75/76 (D/A converter 1/address 272). The maximum value of +10 V is output when the maximum speed, which is set via P/29, is reached, and P-12 is 100%. The output voltage to the customer's measuring instrument can be adapted using P-12 ( $\pm 10$  V). The polarity can also be reversed (e.g. P-12 to -80.0%, the output signal at maximum speed (P-29) at terminals 75/76 is then - 8.0 V)

**P-13** Fine normalization of the D/A converter  
| $M_d/M_{d\max}$ | or | $P/P_{\max}$ | (address 274 - terminal 16/77) - 200.0 % - + 300.0 %

The fine normalization is only valid if: P-68 = 0 2 7 4 H  
P-69 = 0 0 0 0 H

The main spindle motor utilization is displayed with the voltage output via terminal 16/77 (D/A converter 2/address 274). In this case, the motor torque is used from  $n = 0$  up to rated speed to calculate the motor utilization, and above rated speed, the motor output. The actual torque limits (P-39 to P-46) are taken into account. The voltage output via terminal 16/76 to the connected measuring instrument can be matched using parameter P-13. In this case, +10 V is output when +100% is entered into parameter P-13 and the motor torque or the motor output has reached the actual effective limit (P-39 to P-46).

The analog output 3, terminal 18/78 (D/A converter 3/address 31E) indicates the motor rated power ( $P_{n\text{motor}}$ ) 5 V, and cannot be finely normalized.

### 3.3.4 Speed settings

- P-14** Normalization  $n_{set}$  ( $\hat{=}$  tacho-adjustment) - 250.0 % - + 250.0 ‰  
 With parameter P-14, the speed can be set which should be attained with the  $\pm 10$  V analog input voltage. At  $n_{set} = 10$  V and P-14 = 100 ‰, 4 x rated speed ( $n_{rated}$ ) is reached, if P-29  $\geq 4 \cdot n_{rated}$ .  
 The sign of parameter P-14 defines the motor direction of rotation:  
 +  $\hat{=}$  Clockwise rotation for positive speed setpoint  
 -  $\hat{=}$  Counter-clockwise rotation for positive speed setpoint

- P-15** Offset correction of the  $n_{set}$  input ( $\hat{=}$  drift compensation) 0 0 0 0 H  
 e.g. positive correction value 0 0 2 F H  
 negative correction value F F D 0 H  
 The hexadecimal format is used here in order to permit fine adjustment of the setting .

- P-113** Speed setpoint channel selection  
 The speed setpoint can be controlled via terminals 56/14 or 24/8 of the I/O board. These setpoint inputs can be switched with P-113.

P-113 setting	Terminal	
	56/14	24/8
0	off	off
1	on	off
2	off	on
3	on	on

### 3.3.5 Ramp-function generator settings

The ramp-up and ramp-down times of the ramp-function generator can be separately adjusted via parameters P-16 and P-17.

- P-16** Ramp-up time (from  $n = 0$  to  $n_{max}$ ) 0.00 - 32.00 s
- P-17** Ramp-down time (from  $n_{max}$  to  $n = 0$ ) 0.00 - 32.00 s
- P-18** Degree of rounding-off (0  $\hat{=}$  no rounding-off) 0 - 10



### 3.3.6 Speed monitoring settings

<b>P-21</b>	Response value of the $n_{act} < n_{min}$ relay		0 - 6300 RPM
<b>P-22</b>	Response value of the internal $n_{min}$ sensing in order to brake the drive smoothly. When speed $n_{min}$ is reached, the drive is switched to a no-torque condition and coasts down with the kinetic energy. This $n_{min}$ threshold is <b>not</b> identical with the response value of the $n_{min}$ relay but can however be set to the same value.		0 - 1500 RPM
<b>P-23</b>	Response value of the $n_{act} < n_x$ relay	Gearbox stage 1	0 - 16000 RPM
<b>P-24</b>	Response value of the $n_{act} < n_x$ relay	Gearbox stage 2 (term. 117)	0 - 16000 RPM
<b>P-25</b>	Response value of the $n_{act} < n_x$ relay	Gearbox stage 3 (term. 118)	0 - 16000 RPM
<b>P-26</b>	Response value of the $n_{act} < n_x$ relay	Gearbox stage 4 (term. 119)	0 - 16000 RPM
<b>P-27</b>	Response value of the $n_{act} = n_{set}$ relay. The tolerance bandwidth of $n_{set} = n_{act}$ response value can be entered via P-27. This percentage value is referred to the rated speed.		0.1 % - 11.0 %
<b>P-29</b>	Maximum motor speed setting (speed limiting)	4-pole motors: 2-pole motors:	0 - 11500 RPM 0 - 20100 RPM

### 3.3.7 Speed control settings

The speed controller has a PI characteristic, which is separately adjustable for four gearbox stages.

<b>P-31</b>	Speed controller gain	Gearbox stage 1	0.0 - 120.0
<b>P-32</b>	Speed controller integral-action time	Gearbox stage 1	5 - 6000 ms
<b>P-33</b>	Speed controller gain	Gearbox stage 2 (term. 117)	0.0 - 120.0
<b>P-34</b>	Speed controller integral-action time	Gearbox stage 2 (term. 117)	5 - 6000 ms
<b>P-35</b>	Speed controller gain	Gearbox stage 3 (term. 118)	0.0 - 120.0
<b>P-36</b>	Speed controller integral-action time	Gearbox stage 3 (term. 118)	5 - 6000 ms
<b>P-37</b>	Speed controller gain	Gearbox stage 4 (term. 119)	0.0 - 120.0
<b>P-38</b>	Speed controller integral-action time	Gearbox stage 4 (term. 119)	5 - 6000 ms

### 3.3.8 Torque limits

The limit setting is referred to the motor rated torque in the constant torque range. When the rated speed is exceeded, i.e. in the constant power range, the torque limiting is referred to the actual operating point. For example, when set to 100%, the rated torque is the maximum torque up to rated speed. When the rated speed is exceeded, the torque limit characteristic decreases as a function of  $1/n$ , which reaches the rated output.

The lowest setting is always effective if several limits are active.

<b>P-39</b>	1st torque limit Absolute torque limit	0.0 - 180.0 %
<b>P-40</b>	Limit for braking operation in % of the maximum motor torque (can be reduced by limiting).	0 - 100 %
<b>P-41</b>	2nd torque limit Torque limiting, which can be activated via terminal 111, and (possibly) P-50 .	0.0 - 180.0 %
<b>P-42</b>	Torque limit setting, which briefly limits the speed controller output after changing over from motor to generator operation.	25 - 80 %
<b>P-43</b>	Duration of the torque limit of P-42	40 - 200 ms
<b>P-44</b>	Torque limit for gearbox stage 2 (term. 117)	0.0 - 180.0 %
<b>P-45</b>	Torque limit for gearbox stage 3 (term. 118)	0.0 - 180.0 %
<b>P-46</b>	Torque limit for gearbox stage 4 (term. 119)	0.0 - 180.0 %
<b>P-47</b>	$M_d > M_{dx}$ relay The setting refers to the actual torque limit.	0.0 - 100.0 %
<b>P-48</b>	Normalization $M_{dset}^*$ )	- 250.0 - + 250.0 %
<b>P-49</b>	Offset correction $M_{dset}^*$ )	0 0 0 0 H
<b>P-50</b>	Changeover speed from the 1st to the 2nd torque limit, if terminal 111 is activated. The 2nd torque limit is active, if terminal 111 is activated, <b>and</b> the changeover speed of P-50 is exceeded.	0 - 11500 RPM

### 3.3.9 Key and control words

<b>P-51,</b> <b>P-151</b> <b>P-251</b>	Key word for the ability to change parameters (write protection is cancelled by writing into P-51). The contents are initialized with 0 0 0 0 H when the unit is switched-on.  By writing 0 0 0 4 H into P-51, write protection, e.g. for parameters P-12 to P-79, P-83 to P-85 etc. is cancelled.	0 0 0 0 H
<b>P-52,</b> <b>P-152</b>	By setting P-52 to 0 0 0 <u>1</u> H, the EEPROM is overwritten with the contents of the EEPROM duplicate in the RAM when the hardware write protection is cancelled (write protection jumper S1 on the control board N1 must be open). LED3 is lit (Section 3.3.12).	0 0 0 0 H

\*) Only effective in the open-loop control torque mode (terminal 158) (refer to Section 3.5.2)

**P-53** Various control functions can be selected and changed by setting bit patterns in the P-53 command parameter. These entries can be combined with each other.

If the least significant bit (bit 0) is not set, the "ready" relay pulls-in if a fault is not present, pulse and controller enable signals are available and the motor is magnetized. 0 0 0 0 H

If the least significant bit (bit 0) is set, the relay pulls-in when no fault is present. 0 0 0 1 H

When bit 3 is set, the setpoint input via the select terminals is enabled (P-83 to P-85) (Section 3.3.14). 0 0 0 8 H

When bit 5 is set, an additional fault acknowledgement is initiated when a change is made from controller enable to controller inhibit with DC link voltage available. 0 0 2 0 H

When bit 6 is set, fault signal F-01 and F02 are automatically acknowledged after voltage return if controller enable is not available. 0 0 4 0 H

When bit 7 is set, the DC link controller is already enabled when the AC main spindle drive has pulse enable (only relevant for SIMODRIVE 690). 0 0 8 0 H

If bit 8 is not set, a setpoint input < 6 RPM is evaluated as 0 RPM. 0 0 0 0 H

If bit 8 is set, a setpoint can be continuously input down to speed 0 0 1 0 0 H

If bit 9 is set, a changeover is made from the n<sub>x</sub> relay function to the selectable relay function (P-185 to P-189). 0 2 0 0 H

If several bits are set, the appropriate combination should be added in hexadecimal form, e.g.:

Set bits 0, 6, 7 and 8  $\hat{=}$   
0 0 0 1 H + 0 0 4 0 H + 0 0 8 0 H + 0 1 0 0 H = 0 1 C 1 H

0	0	0	1
0	0	4	0
0	0	8	0
0	1	0	0
0	1	C	1

**(P-90) Control parameters**

0 0 0 0 H

The following functions can be selected:

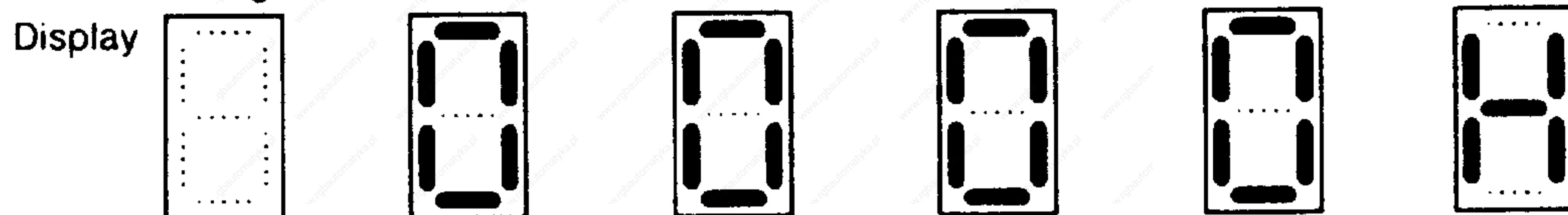

0				1 $\hat{=}$ integrator inhibit (speed controller) selected in M19 operation (P-62)	Parameter format 0 $\hat{=}$ Hex display 1 $\hat{=}$ Dec display	
1				1 $\hat{=}$ write protection cancelled for change in RAM	1 $\hat{=}$ error message "F-15" is suppressed	
2						
3						
4						

### 3.3.10 Settings for NC auxiliary function M19 (oriented spindle stop)

The settings for the NC auxiliary function M19, which are relevant for optimizing the spindle positioning and controlled standstill operation, are located in this parameter area (also refer to Section 3.4.1).

The functions of this parameter are only switched-in when the "M19 operation" signal is available at the assigned terminal, which is in turn selectable via parameters P-83 to P-85 (assignment of the terminal functions).

<b>P-54</b>	Speed setpoint normalization factor for M19 operation. This normalization factor is selected especially for spindle positioning via the NC if the speed limit, entered in P-56, is fallen below. The entered normalization factor must have the same sign as for P-14.	- 200.0 % - + 250.0 %
<b>P-55</b>	Offset correction of the speed setpoint channel in M19 operation. The correction, entered via P-15 is effective when this operating mode is not selected (also refer to Section 3.3.4).	0 0 0 0 H
<b>P-56</b>	Speed changeover point of the setpoint normalization factor. When the entered speed is fallen below, the normalization factor deposited in P-54 becomes effective.	0 - 8000 RPM
<b>P-57</b>	P gain of the internal position controller. Normalization 0 1 0 0 H corresponds to $V_P = 1$ .	0 0 0 0 H
<b>P-58</b>	Gain of the speed actual value evaluation for M19-operation.	1 - 10
<b>P-59</b>	Position bandwidth of the speed setpoint channel in M19 operation. Input of the positioning window in increments (+ / -).	0 0 0 0 H
<b>P-60</b>	Monitoring time ("in position") for switching-in the internal position controller. The selected monitoring time runs in P-60 when the entered position bandwidth (P-59) is reached and is no longer left. The internal position controller is switched-in after this time has expired.	0.0 - 16.0 s
<b>(P-61)</b>	Output of the internal position controller	0 0 0 0 H
<b>P-62</b>	Speed actual value threshold for switching-in the I component of the speed controller. The integrator inhibit for M19 operation is activated by setting the switching bit 2461 0 H in parameter P-90. The I component is switched-in again when the absolute value of the speed entered in P-62 is fallen below.	0-3000 RPM
<b>P-253</b>	Limit value for the speed actual value generated from the rotor angle. When the speed actual value exceeds the value in P-253, the standard speed actual value generation is selected.	0 0 0 0 H
<b>P-254</b>	Shutdown threshold M19 The internal position controller is disabled when the speed setpoint exceeds the value in P-254.	0 0 0 0 H

### 3.3.11 Settings for motor data and cable resistance

All motor type-specific data required for the control are automatically transferred with the motor code number (refer to Section 3.3.15). Here, it is only possible (and necessary) to set a lower maximum motor temperature and cable resistance.

- P-63** Maximum motor temperature 0 - 150 °C  
 When the set temperature is exceeded, the "motor overtemperature alert" relay signal is realized after approx. 30 s, and after 4 minutes, fault message F-14.
- P-64** Fixed motor temperature 0 - 150 °C  
 When a temperature other than 0°C is entered here, then the measured temperature is not used for calculation, but the specified temperature, and the motor temperature monitoring is no longer operational.
- P-65** Cable resistance 0 - 9999 mΩ  
 The cable resistance to be calculated of a phase of the feeder between the motor and the converter is entered here.
- P-82** Magnetization integration time

P-82	Integration time
6	200 ms
7	400 ms
8	800 ms
9	1600 ms
10	3200 ms

### 3.3.12 Assignment and normalization of the D/A converters and measuring sockets

Measuring sockets are provided on the processor board as diagnostic aids. These measuring sockets are driven from D/A converters, which can be freely assigned via parameters.

The D/A assignment to the data to be measured is realized by entering the associated RAM address into parameters P-66, P-68 or P-76. The address assignment can be taken from a "list of variables".

Measuring socket  $I_D^*$  is permanently assigned to the DC link current setpoint and cannot be changed.

The contents of the associated addresses are normalized via parameters P-67, P-69 and P-77.

Normalization is realized by shifting the selected data values to the left. 15 x shifting operations to the left are possible (setting parameter to 0 0 0 F, hexadecimal format).

The D/A converters have an 8-bit resolution. Only the most significant byte is evaluated for a word. If 7 FH is available at the D/A converter, +10 V analog is output and for 8 0 H, -10 V. For D/A converter 3, the H byte is output at the lefthand measuring socket, and the L byte at the righthand measuring socket.

The H byte and the L byte of the address specified in parameter P-76 are output at terminal 18/78 of the input/output board.

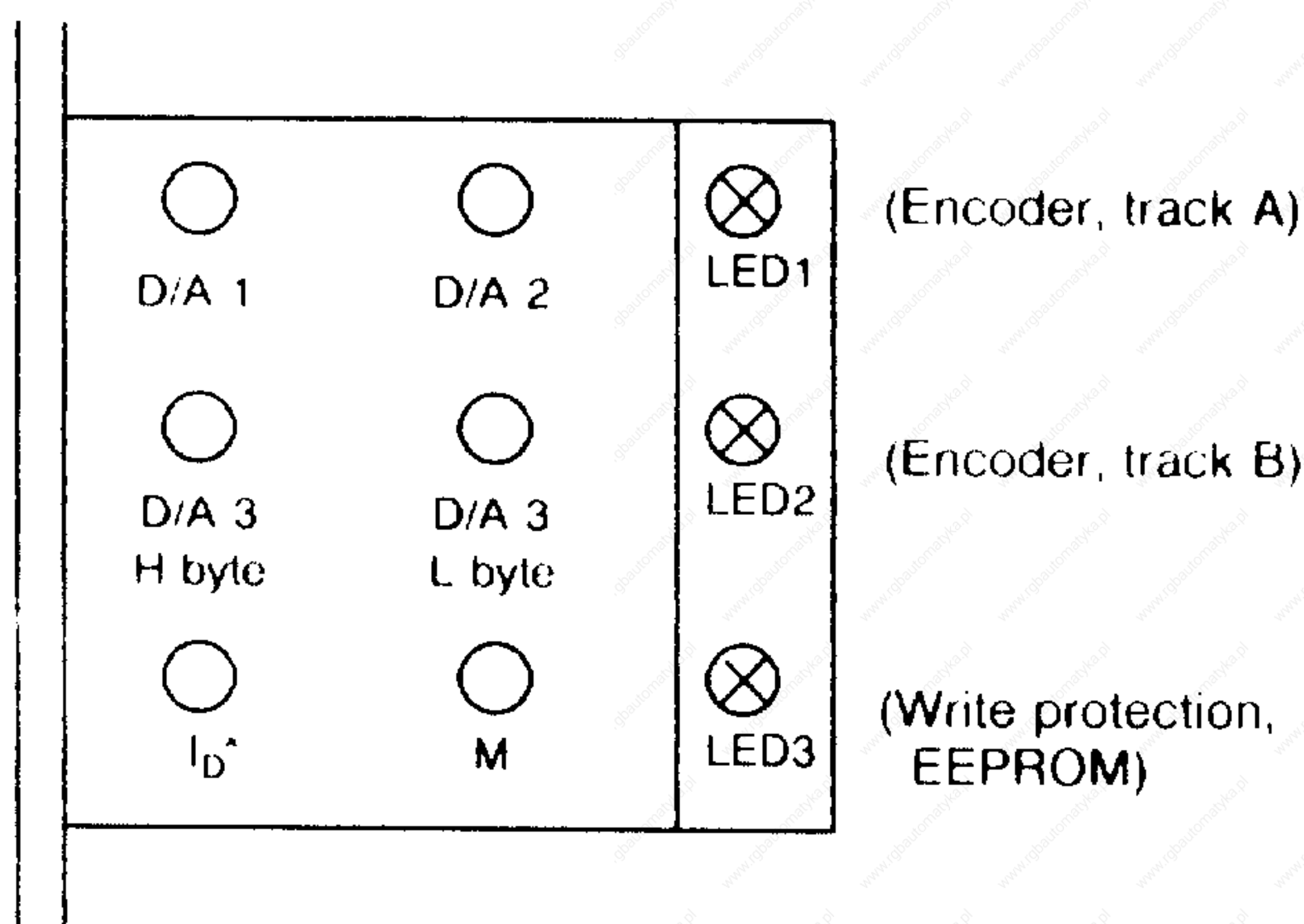

Fig. 3.2 Location of the measuring sockets and LEDs in the front panel of control board N1

*The analog outputs of the input/output board are connected in parallel with those of the CPU (D/A converter 1 to D/A converter 3). Thus, it should be ensured that when operational the addresses of those quantities which are to be displayed on external instruments are stored in P-66, P-68 and P-76.*

<b>P-66</b>	Assignment of D/A converter 1 (RAM address: 0 2 7 2 H $\hat{=}$  n <sub>act</sub>   *)	0 0 0 0 H
<b>P-67</b>	Normalization of D/A converter 1 (shift to the left)	0 0 0 0 H
<b>P-68</b>	Assignment of D/A converter 2 (RAM address: 0 2 7 4 H $\hat{=}$  M <sub>d</sub> /M <sub>dmax</sub>   for n ≤ n <sub>rated</sub>  P/P <sub>max</sub>   for n > n <sub>rated</sub> *)	0 0 0 0 H
<b>P-69</b>	Normalization of D/A converter 2 (shift to the left)	0 0 0 0 H
<b>P-76</b>	Assignment of D/A converter 3 (RAM address: 0 3 1 E H $\hat{=}$ P <sub>act</sub> *)	0 0 0 0 H
<b>P-77</b>	Normalization of D/A converter 3 (shift to the left)	0 0 0 0 H
<b>P-78</b>	Offset of D/A converter 1	0 0 0 0 H
<b>P-79</b>	Offset of D/A converter 2	0 0 0 0 H
<b>P-80</b>	Offset of D/A converter 3	0 0 0 0 H

#### Example:

Speed actual value measurement as analog quantity

The address of the "speed actual value" data word is entered into parameter P-66. The internal speed actual value normalization is 1500 RPM  $\hat{=}$  1 0 0 0 H.

When a normalization entry of 0 0 0 1 H is made into parameter P-67, the data word to be output is shifted 1 digit to the left (multiplied by 2). This means that the bit pattern 2 0 H is available at the D/A converter at a speed of 1500 RPM (2 x 1 0 0 0 H = 2 0 0 0 H, only the most significant byte is output, i.e. 2 0 H).

This corresponds to an analog output voltage of

$$20 \text{ H} \times \frac{10 \text{ V}}{7 \text{ F H}} = 32 \times \frac{10 \text{ V}}{127} = 2.5 \text{ V}$$

\*) *Factory setting*

*An overflow protection is programmed for address 0 2 7 2 H (n<sub>act</sub>), 0 2 7 4 H (M<sub>d</sub> or P) and 0 2 E A H (M<sub>d</sub>). This overflow protection however is only effective, when no left shift is entered in parameters P-67, P-69 and P-77, and no offset correction in parameters P-78, P-79 and P-80.*

Illustrating the analog output signal via a D/A converter with various normalizations using as an example,  $n_{act}$  (acceleration from 0 - 1500 RPM).

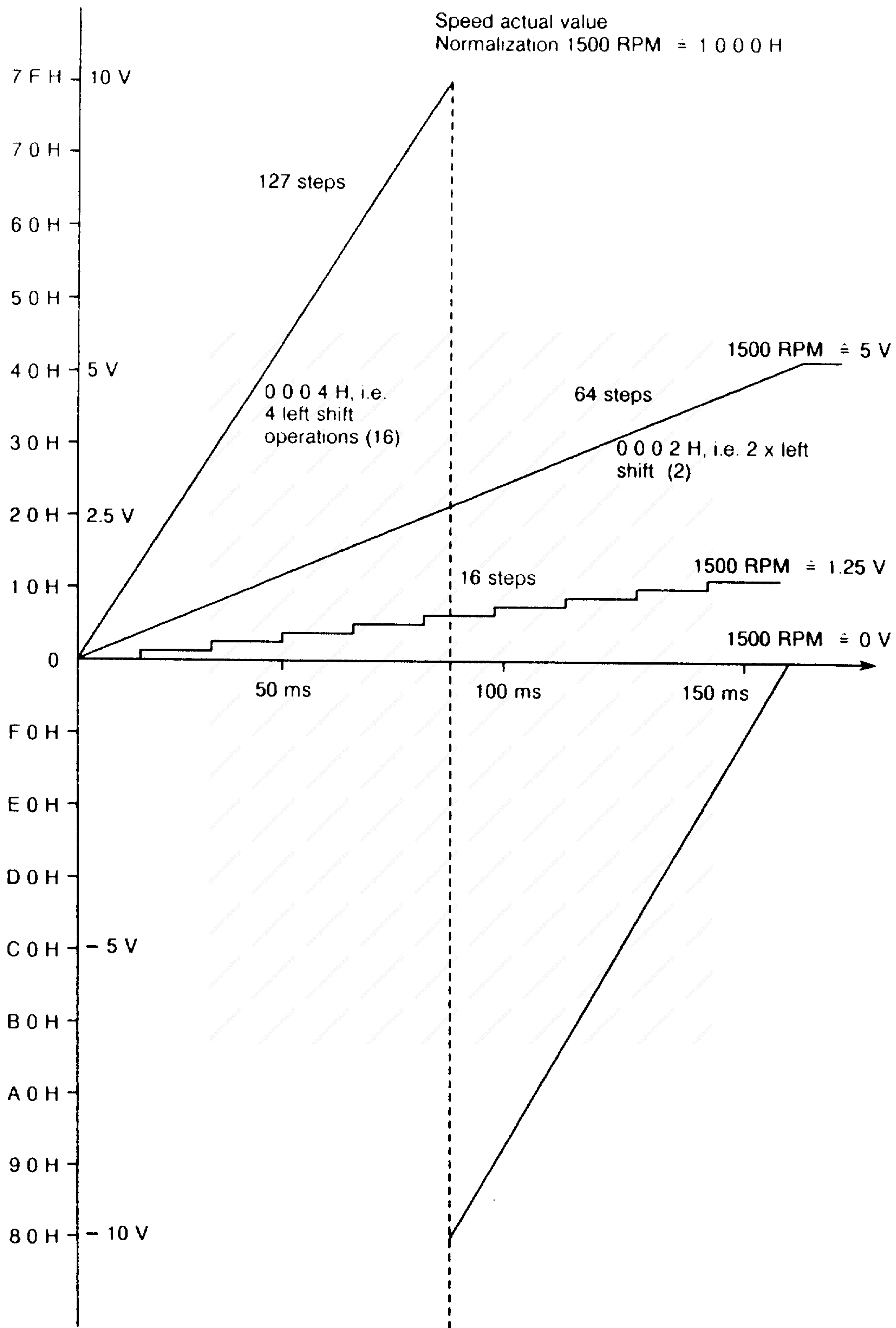



Assignment list for the D/A converter (measuring sockets):  
(speed controller optimization values)

Value	Address, hexadecimal	Normalization, hexadecimal	Input value	Output value
$n_{\text{set}}$ before ramp- function generator	0 3 4 A H	0 0 0 1 H 0 0 0 0 H	4 0 0 0 H $\hat{=}$ 10 V 4 0 0 0 H $\hat{=}$ 10 V	10 V 5 V
$n_{\text{set}}$ after ramp- function generator	0 3 7 4 H	0 0 0 1 H 0 0 0 0 H	4 0 0 0 H $\hat{=}$ 10 V 4 0 0 0 H $\hat{=}$ 10 V	10 V 5 V
$ n_{\text{act}} $	0 C 5 2 H	0 0 0 1 H 0 0 0 0 H	4 0 0 0 H $\hat{=}$ 6000 RPM 4 0 0 0 H $\hat{=}$ 6000 RPM	10 V 5 V
$M_{\text{dset}}$	0 4 0 2 H	0 0 0 1 H 0 0 0 0 H	4 0 0 0 H $\hat{=}$ 100 % 4 0 0 0 H $\hat{=}$ 100 %	10 V 5 V

Additional addresses of variables for diagnostics (list of variables)

0 2 E A H	Torque
0 3 1 4 H	Magnetization current setpoint
0 3 1 6 H	Active current setpoint (torque setpoint, C axis)
0 3 1 8 H	Absolute stator current setpoint
0 3 1 E H	Power
0 3 2 2 H	Current setpoint, phase R
0 3 2 4 H	Current setpoint, phase S
0 3 4 4 H	Slip frequency setpoint
0 4 0 2 H	Torque setpoint
0 4 4 0 H	Rotor flux setpoint
0 7 4 E H	Speed setpoint (C axis)
0 9 4 0 H	Speed setpoint
0 3 7 4 H	Speed setpoint after the ramp-function generator
0 3 5 2 H	Speed actual value
0 D 3 4 H	Speed actual value for U/f open-loop control
0 3 8 0 H	Angle between stator voltage and rotor flux axis
0 3 8 2 H	Angle between stator voltage and stator axis
0 3 8 C H	Angle between stator axis and rotor axis (position actual value)
0 7 5 0 H	Speed actual value (C axis)
0 8 0 A H	DC link voltage
0 8 3 C H	Firing angle, supply-side gating unit
0 8 A 4 H	DC link voltage (smoothed)
0 3 4 C H	Synchronization controller output
0 8 7 0 H	Motor/generator operation
0 C 8 8 H	Position controller output (M19)

By writing 0 0 0 1 H into parameter P-184, the converter is switched-over from speed closed-loop control to U/f open-loop control. In this mode, operation is also possible with faulty actual values, by using the stored voltage/frequency characteristic.

### 3.3.13 Settings for the DC link voltage forming the DC link capacitors

**P-74** DC link voltage 570 - 600 V

The DC link voltage can be changed via this parameter.  
Factor setting, from software release 14 onwards: 600 V (previously 575 V)

**P-75** Forming 0 0 0 0 H

The DC link capacitors should be formed when fault message F-42 appears when the converter is first switched-on after a long storage time, or when the line fuses blow.

0 0 0 1 H should be entered into parameter P-75, and loaded into the EEPROM with P-52.

The forming sequence should be taken from Section 3.4.

### 3.3.14 Assigning the terminal functions

**P-83** The terminals can be assigned various functions per software via 0 0 0 0 H  
**to** parameters P-83 to P-86. The function of the selected terminal is  
**P-86** displayed via P-13 (refer to Section 3.3.6).

- P-83 Terminal 119
- P-84 Terminal 158
- P-85 Terminal R
- P-86 Terminal 118

The following functions can be assigned to the terminals:

Display		<p>Gearbox stage 4</p> <p>Torque open-loop control</p> <p>Remote acknowledgement</p> <p>M19 operation</p> <p>Gearbox stage 3</p> <p>Delta connection for operation with a star-delta motor</p>
---------	--	--

Display

						Unassigned
						Only clockwise rotation
						Only counter-clockwise rotation
						$n_{set} = 0$
						Speed controller, integrator inhibit

The "only clockwise rotation", "only counter-clockwise rotation" and " $n_{set} = 0$ " settings can only be activated, when the appropriate enable signal is provided with P-53, i.e. bit 3 is set (0 0 0 8 H).

The following basic setting is set in the factory:

- P-83 0 0 0 1 H  $\hat{=}$  Gearbox stage 4
- P-84 0 0 0 2 H  $\hat{=}$  Torque open-loop control
- P-85 0 0 0 4 H  $\hat{=}$  Remote acknowledgement ("reset")
- P-86 0 2 0 0 H  $\hat{=}$  Gearbox stage 3

**Example:**

If M19 operation function is to be selected via terminal 158, parameter P-84 must be changed to 0 0 0 8 H.

**(P-30)** Displaying the functions set via terminals 119, 158 and R (P-83 to P-86). These are only displayed, when the corresponding function is set and the terminal is activated.

Display

--	--	--	--	--	--









































--	--	--	--	--

### 3.3.15 Matching the converter and motor data

**P-94** DC link capacitance in  $\mu\text{F}$  0 - 30000  $\mu\text{F}$   
 The available DC link capacity must **only** be matched for combination units (SIMODRIVE 690).

The associated converter and motor data are selected with parameters P-95, P-96 and P-98, and transferred from the EPROM into the RAM and EEPROM when 0 0 0 1 H is written into P-97 (in the EEPROM).

**P-95** Matching the converter data 1 - 14

PWM converter	Code number parameter P-95
6SC6502	6
6SC6503	8
6SC6504	3
6SC6506	13*)
6SC6508	2
6SC6512	4
6SC6520	14

***If a new code number, which is different than the original code number, is to be entered into P-95 or P-96, this must be realized via the "initialization" function (P-97), so that the appropriate data sets are transferred.***

**P-97** Initialization (also refer to Section 5.2) 0 0 0 0 H

**P-98** Encoder pulses per motor revolution 256 - 32000

\*) For 6SC6506-4AA00/01 converters, code number 1 must be entered.

**Example:**

P-95 is displayed after the converter is switched-on. This indicates that initialization is required. The converter type must be entered into parameter P-95, the motor type into P-96, and the number of encoder pulses per motor revolution, into P-98 (Section 3.4).

0 0 0 1 H should then be written into parameter P-97 so that the selected type data is transferred from the EPROM into the RAM and EEPROM. In this case, the write protection jumper S1 on the control board N1 must be opened (cancels the hardware write protection).

**P-96 Matching the motor data\*)**

101 - 175

AC motor	Output [kW]	Rated speed [RPM]	Code No. parameter P-96	PWM converter at n x overload capability			
				1.0	1.2	1.4	1.6
1PH5101-4CF4	3	1500	101	6SC6502	6SC6502	6SC6502	6SC6502
1PH5101-4CG4	4	2000	114	6SC6502	6SC6502	6SC6502	6SC6502
1PH5104-4CF4	4.5	1500	102	6SC6502	6SC6502	6SC6502	6SC6502
1PH5104-4CG4	6	2000	115	6SC6502	6SC6502	6SC6502	6SC6502
1PH5106-4CF4	6	1500	112	6SC6502	6SC6503	6SC6503	6SC6503
1PH5107-4CF4	6.5	1500	103	6SC6502	6SC6502	6SC6503	6SC6503
1PH5107-4CG4	8.5	2000	116	6SC6502	6SC6503	6SC6503	6SC6503
1PH5107-2CH4	8	3000	121	6SC6502	6SC6503	6SC6503	6SC6503
1PH5107-4CZ4	12	3000	123	6SC6503	6SC6503	6SC6504	6SC6504
1PH5108-4CF4	7.5	1500	113	6SC6503	6SC6503	6SC6503	-
1PH5109-4CG4 **)	11	2000	127	6SC6503	6SC6503	6SC6504	6SC6504
1PH5131-4CF4	9	1500	104	6SC6503	6SC6504	6SC6504	6SC6504
1PH5131-4CG4	12	2000	117	6SC6503	6SC6503	6SC6504	6SC6504
1PH5137-4CF0	15	1500	130	6SC6504	-	-	-
1PH5137-4CF4	15	1500	105	6SC6506	6SC6506	6SC6506	6SC6506
1PH5137-4CG4	20	2000	111	6SC6506	6SC6506	6SC6506	6SC6508
1PH5137-2CH4	18	3000	109	6SC6506	6SC6506	6SC6506	6SC6508
1PH5138-4CF4	18	1500	110	6SC6506	6SC6506	6SC6506	6SC6508
1PH5138-4CG4	24	2000	118	6SC6506	6SC6506	6SC6508	6SC6508
1PH5161-4CF0	20	1500	131	6SC6506	6SC6506	-	-
1PH5161-4CF4	20	1500	106	6SC6506	6SC6508	6SC6508	6SC6508
1PH5161-4CG4	26	2000	119	6SC6506	6SC6508	6SC6508	6SC6508
1PH5167-4CF4 (82A)	34	1500	107	6SC6508	6SC6512	6SC6512	6SC6512
1PH5167-4CF4 (86A)	34	1500	122	6SC6508	6SC6512	6SC6512	6SC6512
1PH5167-4CF4 (90A)	34	1500	125	6SC6512	6SC6512	6SC6512	-
1PH5167-4CG4	43	2000	120	6SC6508	6SC6512	6SC6512	-
1PH5167-4CF5	34	1500	132	6SC6512	6SC6512	6SC6512	6SC6512
1PH5167-4CG5	43	2000	133	6SC6512	6SC6512	6SC6512	6SC6512
1PH5167-4CZ4	22	950	124	6SC6508	6SC6508	6SC6508	-
1PH6186-4CB4	30.8	700	126	6SC6508	6SC6508	6SC6508	-

\*) The converter settings must be agreed upon with Siemens AUT E243 if motors are used which are not listed in this table.

\*\*) Up to software release 11, code No. 123; in software release 12, no code No.; from software release 13, code No. 127.

## 3.3.15 Matching the converter and motor data

## Motor data from software release 14 onwards \*)

1PH6206-4CB4	32	500	183	6SC6512	6SC6512	(6SC6512)	(6SC6512)
1PH6186-4CB4	22	500	184	6SC6508	6SC6508	6SC6508	6SC6512

## Motor data from software release 14 onwards: Y - Δ motors \*)

1PH6186-4CB8	22	500/1250	208	6SC6506	6SC6508	6SC6508	6SC6508
1PH206-4CB8	32	500/1250	210	6SC6508	6SC6512	6SC6512	6SC6512

\*) If motors are used which are not listed in these tables, then this must be coordinated with AUT E242

## P-96 Matching motor data (continued) \*\*)

AC motor	Output [kW]	Rated speed [RPM]	Code No. parameter P-96	PWM converter at n x overload capability				Max. speed [RPM]	
				1.0	1.2	1.4	1.6		
1PH6101-4CF4	3.7	1500	141	6SC6502	6SC6502	6SC6502	6SC6502	9000	
1PH6101-4CG4	4.7	2000	142	6SC6502	6SC6502	6SC6502	6SC6503		
1PH6103-4CF4	5.5	1500	143	6SC6502	6SC6502	6SC6503	6SC6503		
1PH6103-4CG4	7.0	2000	144	6SC6502	6SC6503	6SC6503	6SC6503		
1PH6105-4CF4	7.5	1500	145	6SC6503	6SC6503	6SC6503	6SC6504		
1PH6105-4CG4	9.5	2000	146	6SC6503	6SC6503	6SC6504	6SC6504		
1PH6107-4CC4	5.0	750	171	6SC6503	6SC6503	6SC6504	6SC6504		
1PH6107-4CF4	9.0	1500	147	6SC6503	6SC6503	6SC6504	6SC6504		
1PH6107-4CG4	11.5	2000	148	6SC6503	6SC6504	6SC6504	6SC6506		
1PH6131-4CF4	9	1500	149	6SC6503	6SC6504	6SC6504	6SC6504		8000
1PH6131-4CG4	12	2000	150	6SC6504	6SC6504	6SC6504	6SC6506		
1PH6133-4CB4	4.25	500	172	6SC6503	6SC6503	6SC6504	6SC6504		
1PH6133-4CB8	4.25	650/1250	200	6SC6502	6SC6502	6SC6504	6SC6504		
1PH6133-4CF0	11	1500	151	6SC6503	6SC6504	6SC6504	6SC6504		
1PH6133-4CF4	11	1500	152	6SC6504	6SC6504	6SC6506	6SC6506		
1PH6133-4CG0	14.5	2000	180	6SC6504	6SC6504	6SC6506	6SC6506		
1PH6133-4CG4	14.5	2000	153	6SC6504	6SC6506	6SC6506	6SC6506		
1PH6135-4CF0	15	1500	154	6SC6504	6SC6506	6SC6506	6SC6506		
1PH6135-4CF4	15	1500	155	6SC6506	6SC6506	6SC6506	6SC6506		
1PH6135-4CG4	20	2000	156	6SC6506	6SC6506	6SC6508	6SC6508		
1PH6137-4CB4	7.5	500	173	6SC6506	6SC6506	6SC6506	6SC6508	8000	
1PH6137-4CB8	7.5	650/1250	202	6SC6503	6SC6503	6SC6504	6SC6504		
1PH6137-4CF4	18.5	1500	157	6SC6506	6SC6506	6SC6508	6SC6508		
1PH6137-4CG0	24	2000	181	6SC6506	6SC6506	6SC6508	6SC6508		
1PH6137-4CG4	24	2000	158	6SC6506	6SC6508	6SC6508	6SC6508		
1PH6138-4CF0	22	1500	159	6SC6506	6SC6506	6SC6508	6SC6508		
1PH6138-4CF4	22	1500	160	6SC6508	6SC6508	6SC6508	6SC6512		
1PH6138-4CG4	28	2000	161	6SC6508	6SC6508	6SC6512	6SC6512		
1PH6161-4CF0	22	1500	162	6SC6506	6SC6508	6SC6508	6SC6508		6500 6500 (8000) *)
1PH6161-4CF4	22	1500	163	6SC6508	6SC6508	6SC6508	6SC6512		
1PH6161-4CG4	28	2000	164	6SC6508	6SC6508	6SC6512	6SC6512		
1PH6163-4CB4	11.5	500	174	6SC6508	6SC6508	6SC6512	6SC6512		
1PH6163-4CB8	11.5	700/1250	204	6SC6504	6SC6506	6SC6506	6SC6506		
1PH6163-4CF0	30	1500	165	6SC6508	6SC6512	6SC6512	6SC6512		
1PH6163-4CF4	30	1500	166	6SC6512	6SC6512	6SC6512	6SC6512		
1PH6163-4CG4	38	2000	167	6SC6512	6SC6512	6SC6512	6SC6512		
1PH6167-4CB4	14.5	500	175	6SC6508	6SC6512	6SC6512	6SC6512		
1PH6167-4CB8	14.5	650/1250	206	6SC6506	6SC6506	6SC6506	6SC6506		
1PH6167-4CF0	37	1500	168	6SC6508	6SC6512	6SC6512	6SC6512		
1PH6167-4CF4	37	1500	169	6SC6512	6SC6512	6SC6512	6SC6512		
1PH6167-4CG0	45	2000	182	6SC6508	6SC6512	6SC6512	6SC6512		
1PH6167-4CG4	45	2000	170	6SC6512	6SC6512	6SC6512	6SC6512		
1PH6186-4CE4	42	1250	108	6SC6508	6SC6512	6SC6512	6SC6512	5000	
1PH6186-4CF4	50	1500	139	6SC6512	6SC6512	6SC6512	6SC6512	(7000) *)	
1PH6206-4CE4	63	1250	128 (1.3)	6SC6512	6SC6512	6SC6520	6SC6520	5000	
1PH6206-4CF4	76	1500	140	6SC6520	6SC6520	6SC6520	6SC6520	(7000) *)	

\*) Special version with higher-quality bearings

\*\*) The converter setting data must be coordinated with Siemens AUT E242 if motors are used which are not listed in this table.

### 3.3.16 Software release

The software release is designated in the last two digits of the number on the control board EPROM (also refer to Section 4.2). Parameters P-99 and P-199 indicate the software release date.

**(P-99)** Control software release date

**(P-199)** Gating unit software release date

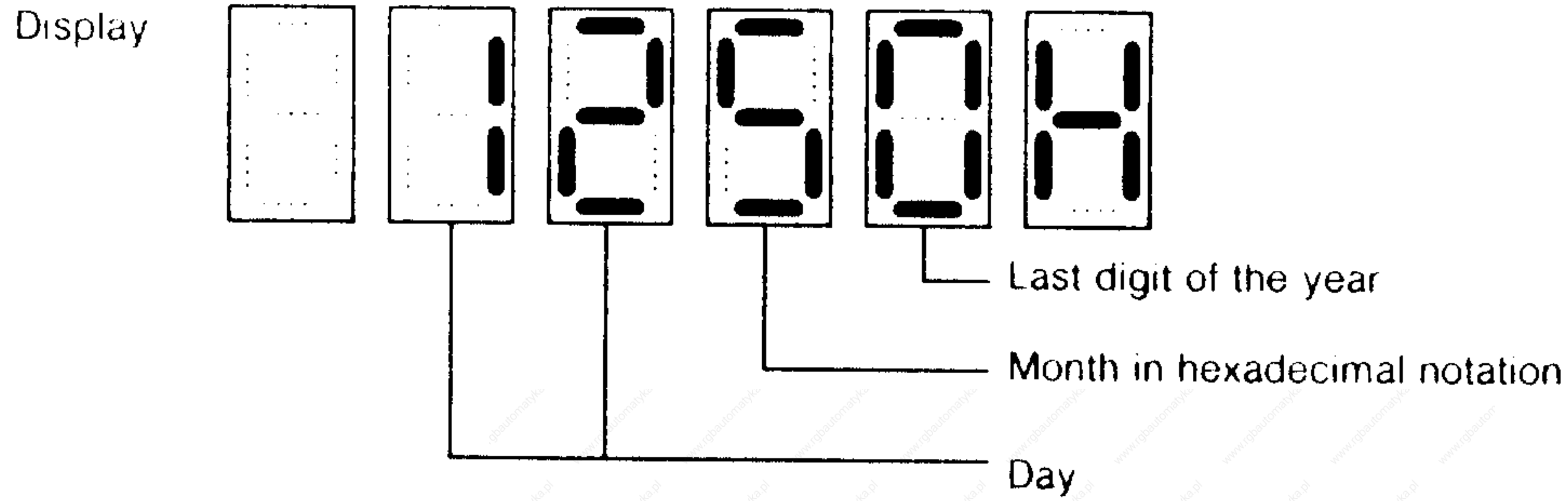

Overview of the software releases:

Control software		Gating unit software	
Release	Display in P-99	Release	Display in P-199
03	0AEB (04. 87)		
04	1987		
05	3158		
06	2788		
07	07A8		
08	0839		
09	0979		
10	1099		
11	11b9	04	0429
12	1250	05	0540
13	1311	05	0540
14	1461	05	0540



### 3.3.17 P-100 operating display

(P-100) The P-100 operating display is identical with P-00 up to the 5th digit. The following symbols are inserted at the 5th digit for positioning operation.

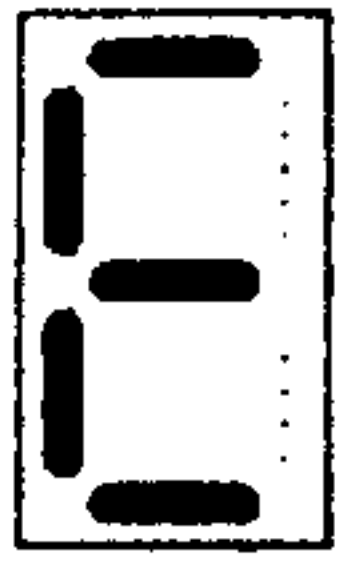

Position value is externally input (terminal 517 at L potential).

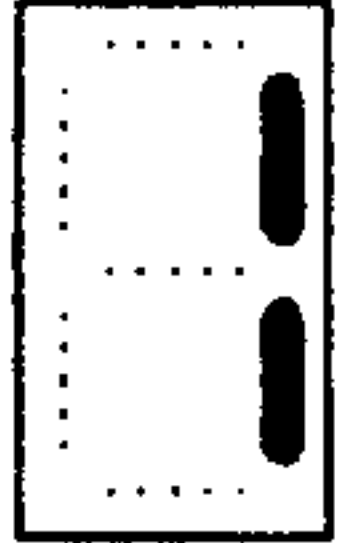

Position 1 is input from the internally stored value (P-121 to P-124) (terminal 512 → H and terminal 517 → H).

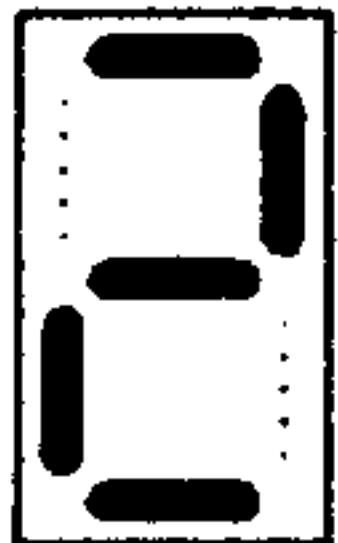

Position 2 is input from the internally stored value (P-125) (terminals 512, 517 and 516 → H).

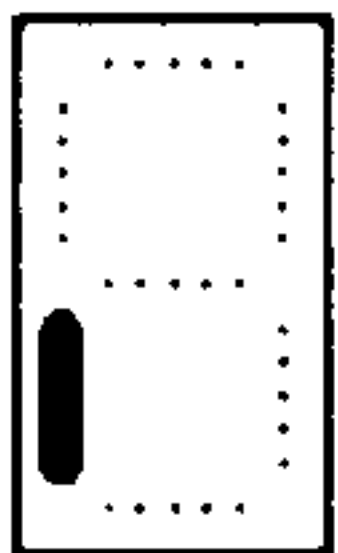

The following is selected: Incremental progression by the value set in parameter P-127 (terminals 512, 517 and 513 → H).

### 3.3.18 Parameter for options A73, A74 and A75

Parameters P-101 to P-150, P-157 to P-159, P-195, P-239 and P-249 are used for the options A73-feed control for C axis, A74 spindle positioning and A75 feed control for C axis and spindle positioning. They are described in the Instruction Manual of the option boards.

Order No. for A73: 6SC6501-0AC00  
for A74: 6SC6501-0AD00  
for A75: 6SC6501-0AE00

### 3.3.19 Oscillation setpoints

**P-154** Oscillation setpoint 1 0 0 0 0 H

**P-155** Oscillation setpoint 2 0 0 0 0 H

Hexadecimal format is used for the setting  
Normalization: Rated speed  $\hat{=}$  1 0 0 0 H

**P-156** Oscillation time interval 0.01 - 60.00

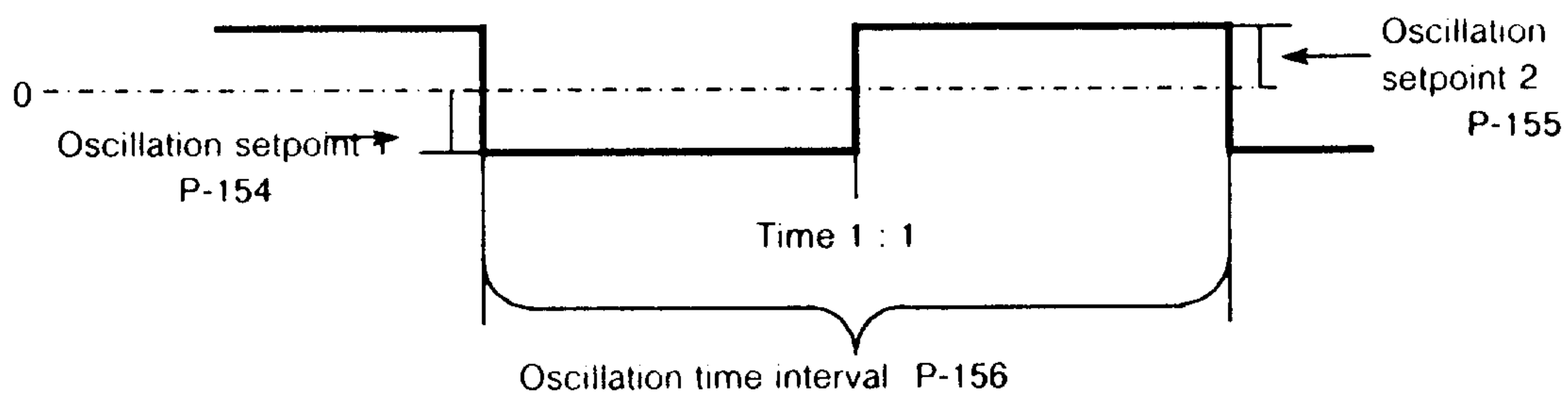

### 3.3.20 Motor data

**P-160** The data for motor types not stored and motors from other manufacturers can be entered via parameters P-160 to P-176. If a motor is not included in the list in Section 3.3.15, then it can be entered using parameters P-160 to P-176. When parameter P-177 is then set to 1, motor data is calculated from parameters P-160 to P-176 and stored. Code No. 99 is then displayed in P-96.

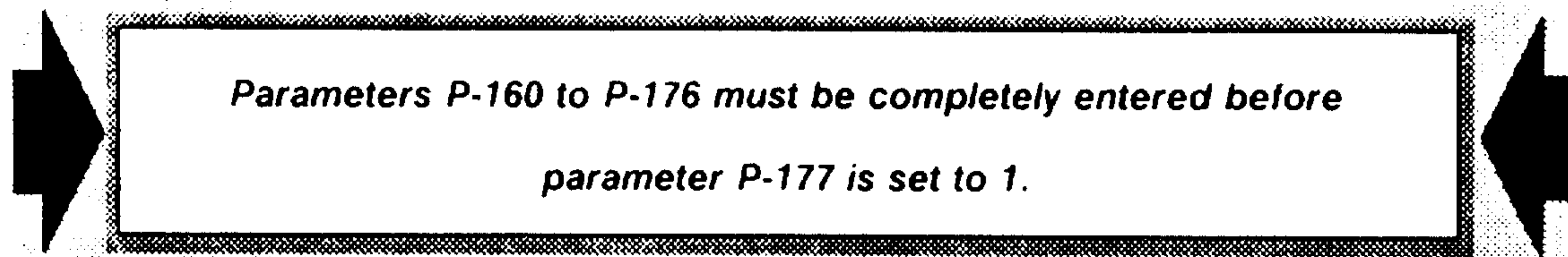

**P-176** Torque reduction (from software release 12, input in RPM) 0 - 10 000 RPM

The speed cut-in point for reducing  $M_d$  is defined, taking into account the motor stability limit, using P-176. A change of the parameter contents is first effective after a system reset (supply OFF-ON).

The parameter contents need not be changed if the motor type was loaded via P-96.

**P-180** Flux reduction 25 - 100 %

The flux can be reduced via P-180. This allows the motor noise to be reduced to approx. 125 Hz motor frequency. The flux reduction however results in a higher current at the same torque. The  $M_d$  limit (P-39 etc.) must be reduced to prevent the converter from being overloaded.

### 3.3.21 Selectable relay function

The  $n_x$  relay function can be changed over to a selectable relay function by writing into bit 9 of P-53 (0  $\geq$  0 0 H).

The following settings are possible via parameters P-185 to P-189.

<b>P-185</b>	Selection of the address to be monitored	0 0 0 0 H
<b>P-186</b>	Response value of the monitored address	0 0 0 0 H
<b>P-187</b>	Relay pull-in delay	0.00 - 10.00 s
<b>P-188</b>	Relay drop-out delay	0.00 - 10.00 s
<b>P-189</b>	Response value hysteresis	0 0 0 0 H

### 3.3.22 Pre-control

**P-190** The DC link is pre-controlled dependent on the motor load. Parameter P-190 defines the pre-control value. 0.1 - 10.0

0.1 = lowest pre-control value  
10.0 = highest pre-control value

### 3.3.23 Damping element

A damping element can be switched into the frequency input channel for the AC drive via parameters P-196 to P-198. System-specific gearbox noise can be reduced or even prevented with the optimized damping element.

<b>P-196</b>	Control flag for the damping element	
	Damping element is not operational	0 0 0 0 H
	Damping element is calculated into the frequency channel	0 0 0 4 H
<b>P-197</b>	Resonant frequency	50.0 - 100.0 Hz
	The frequency of the measured torsional vibration must be entered in this parameter	
<b>P-198</b>	Damping constant	0.01 - 0.38
	The damping effect is defined via this parameter	

### 3.3.24 Motor data for the delta connection

Motor data for the delta connection are displayed and can be modified for special motors via parameters P-220 to P-236 (refer to Section 6.8). If motor data is changed in this parameter area, code No. 98 is displayed in P-96.











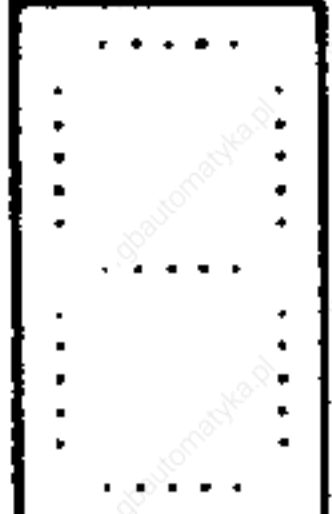

















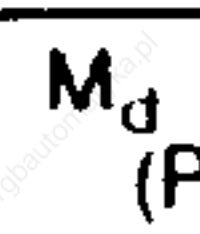

### 3.3.25 Relay function assignments

The functions of three relays can be freely programmed via parameters P-241 to P-243.

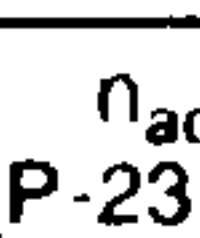
The following parameter assignment is defined.

<b>P-241</b>	Relay, terminals 108, 109, 110	( $M_d > M_{dx}$ relay)
<b>P-242</b>	Relay, terminals 214, 215, 216	( $n_{act} < n_x$ relay)
<b>P-243</b>	Relay, terminals 114, 115, 116	( $n_{act} < n_{min}$ relay)

The following functions can be assigned

Display							
				free	Star contactor on (Y-Δ circuit)		
				$M_d > M_{dx}$ (P-47)	Delta contactor on (Y-Δ circuit)		
				free	$n_{act} < n_x$ (P-23 to P-26)		
				free	free	$n_{act} < n_{min}$ (P-21)	

The factory presetting is

**P-241** 0 0 2 0 H

**P-242** 0 0 4 0 H

**P-243** 0 0 0 8 H

Relay function  $M_d > M_{dx}$

Relay function  $n_{act} < n_x$

Relay function  $n_{act} < n_{min}$

### 3.3.26 Synchronizing controller gain

#### P-252 Synchronizing controller gain

1 - 4

For several motor types, when reversing with low external moments of inertia (at max.  $M_d$ ), there is no smooth constant zero cross-over (brief "sticking" in the vicinity of 0 speed). The reversing characteristics are improved and the "M19 operation" has an improved running-in characteristic by increasing the synchronizing controller gain [change parameter value from 3 (factory setting) to 2].

## 3.4 Start-up instructions

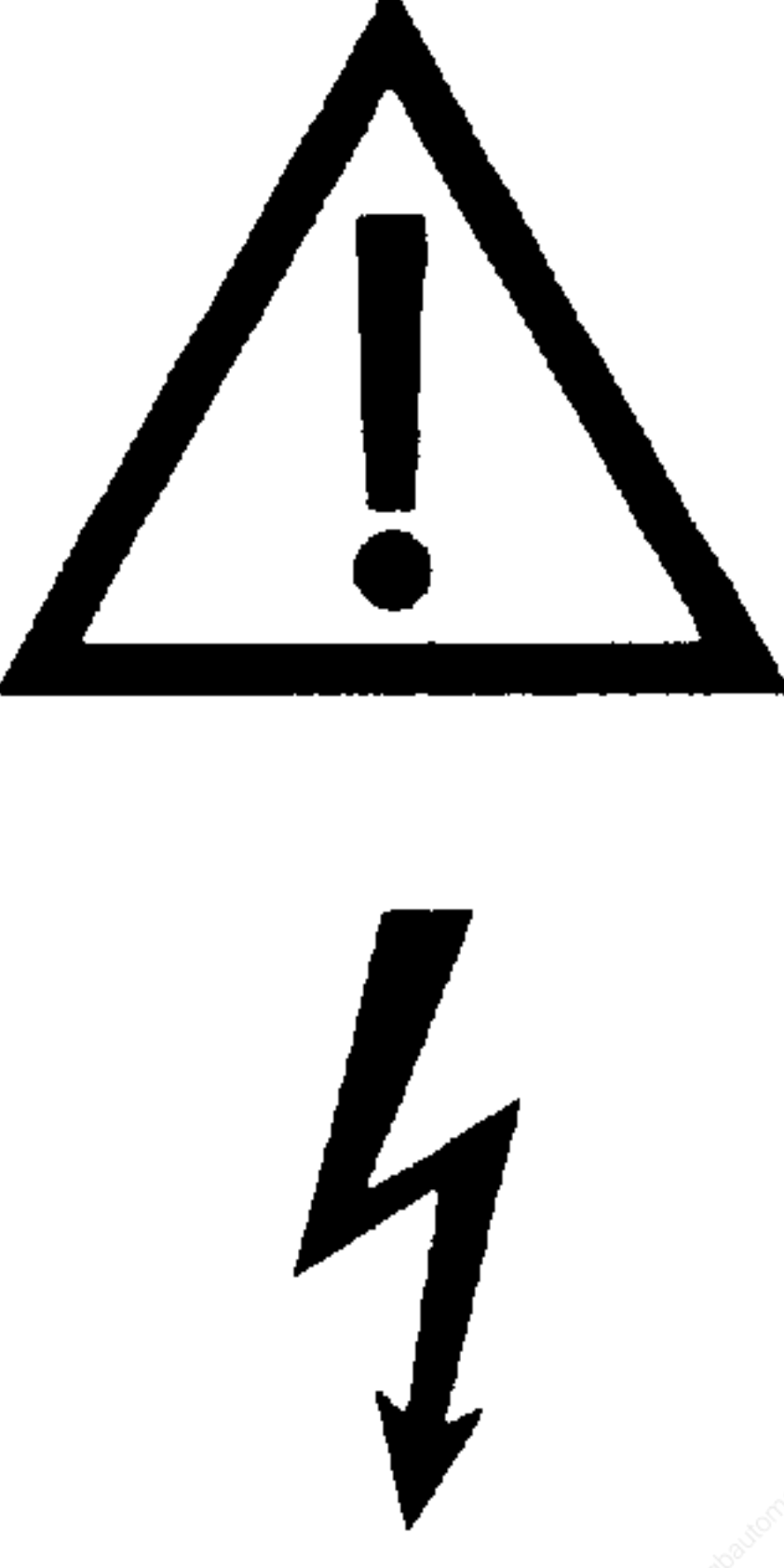
<b>WARNING</b>	
	<p>Safe and reliable operation of the units is only guaranteed when they are mounted, installed and started-up by qualified personnel taking into account the safety notes in this Instruction Manual.</p> <p>A high voltage is still available even after the unit has been switched-off (approx. 4 minutes) as a result of the DC link capacitors.</p> <p>When carrying-out work with the unit open it should be noted that live components are exposed.</p> <p>Even with the motor stationary, equipment components can still be live.</p> <p>Only qualified personnel should carry-out work on the equipment.</p>

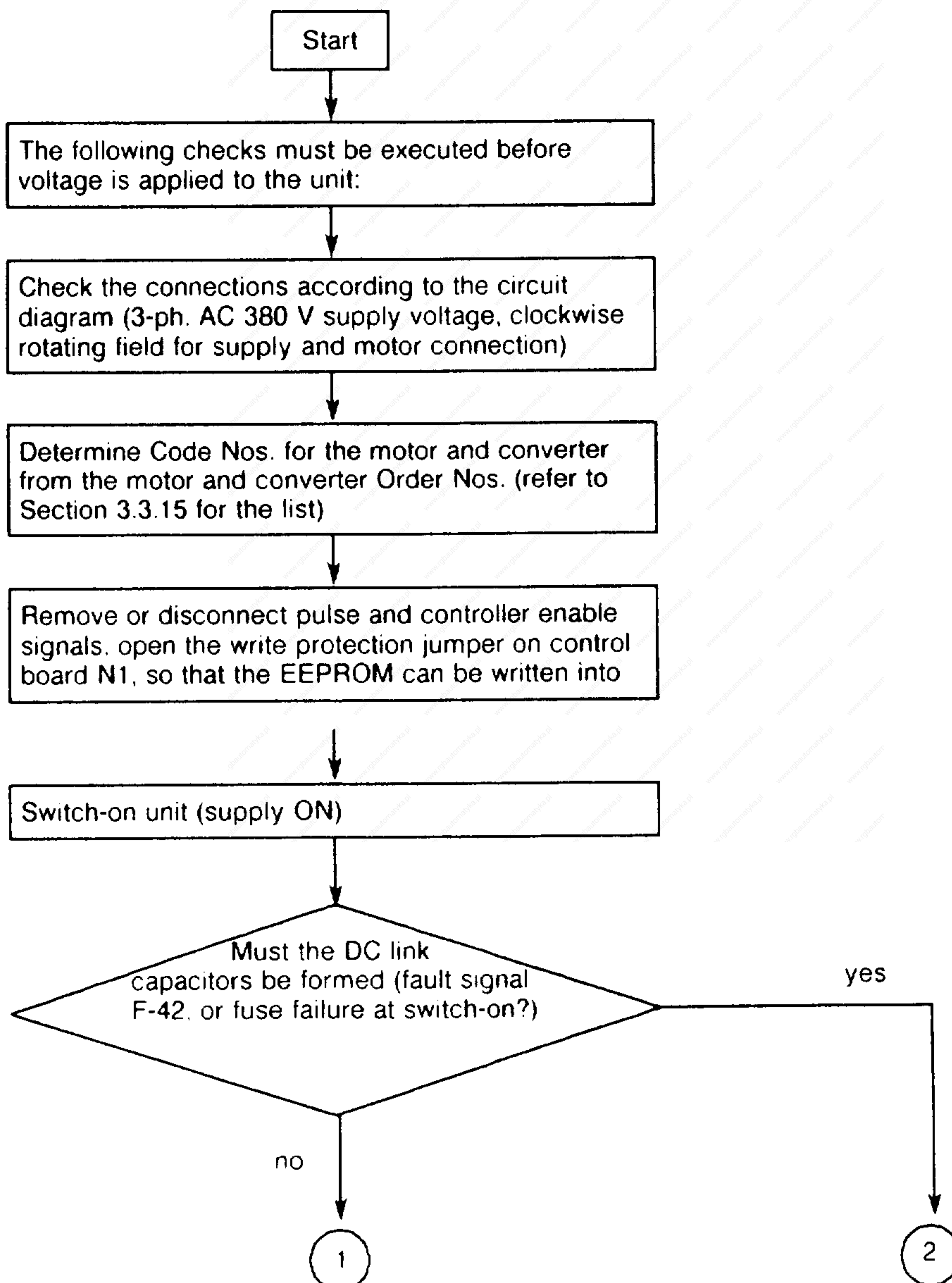

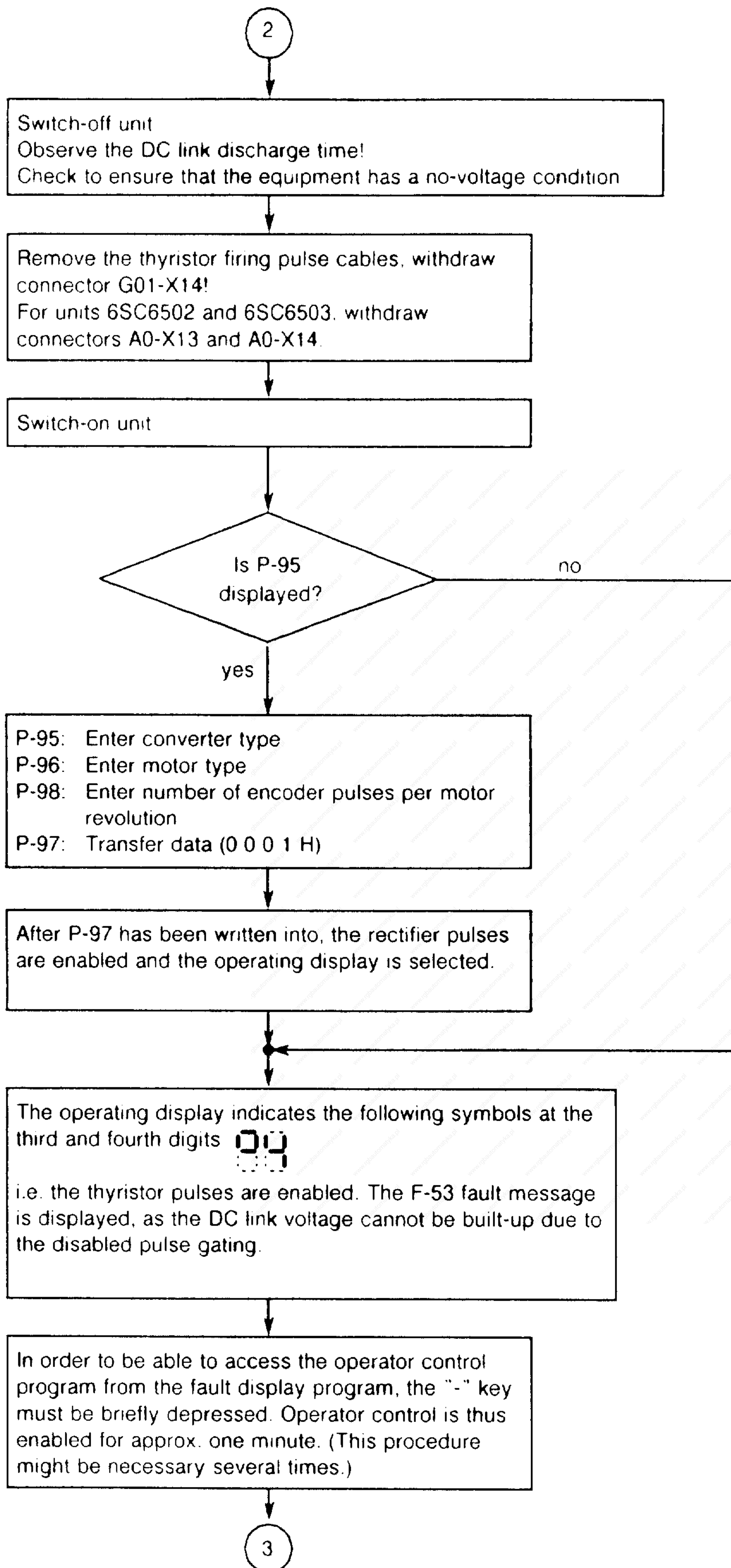

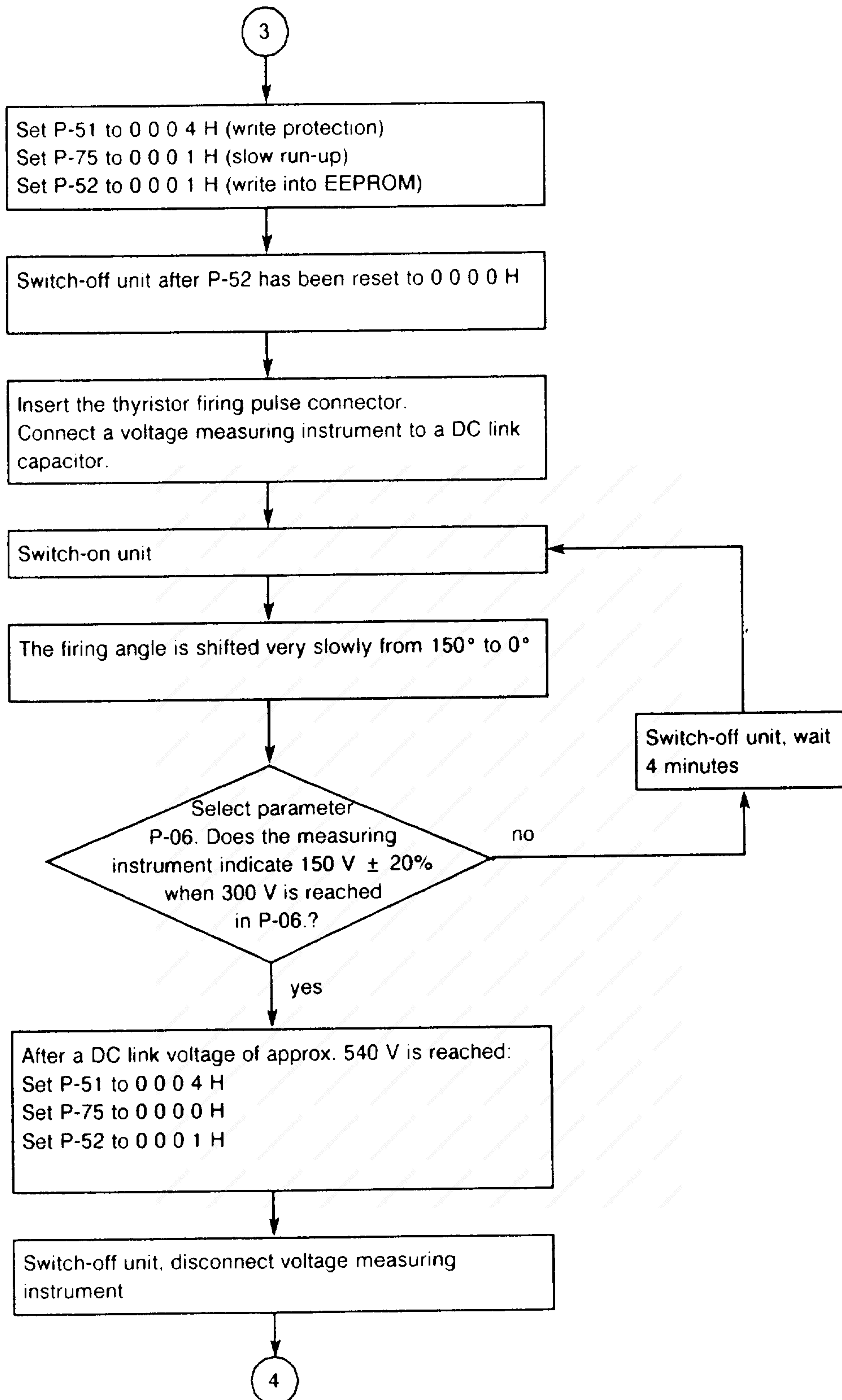

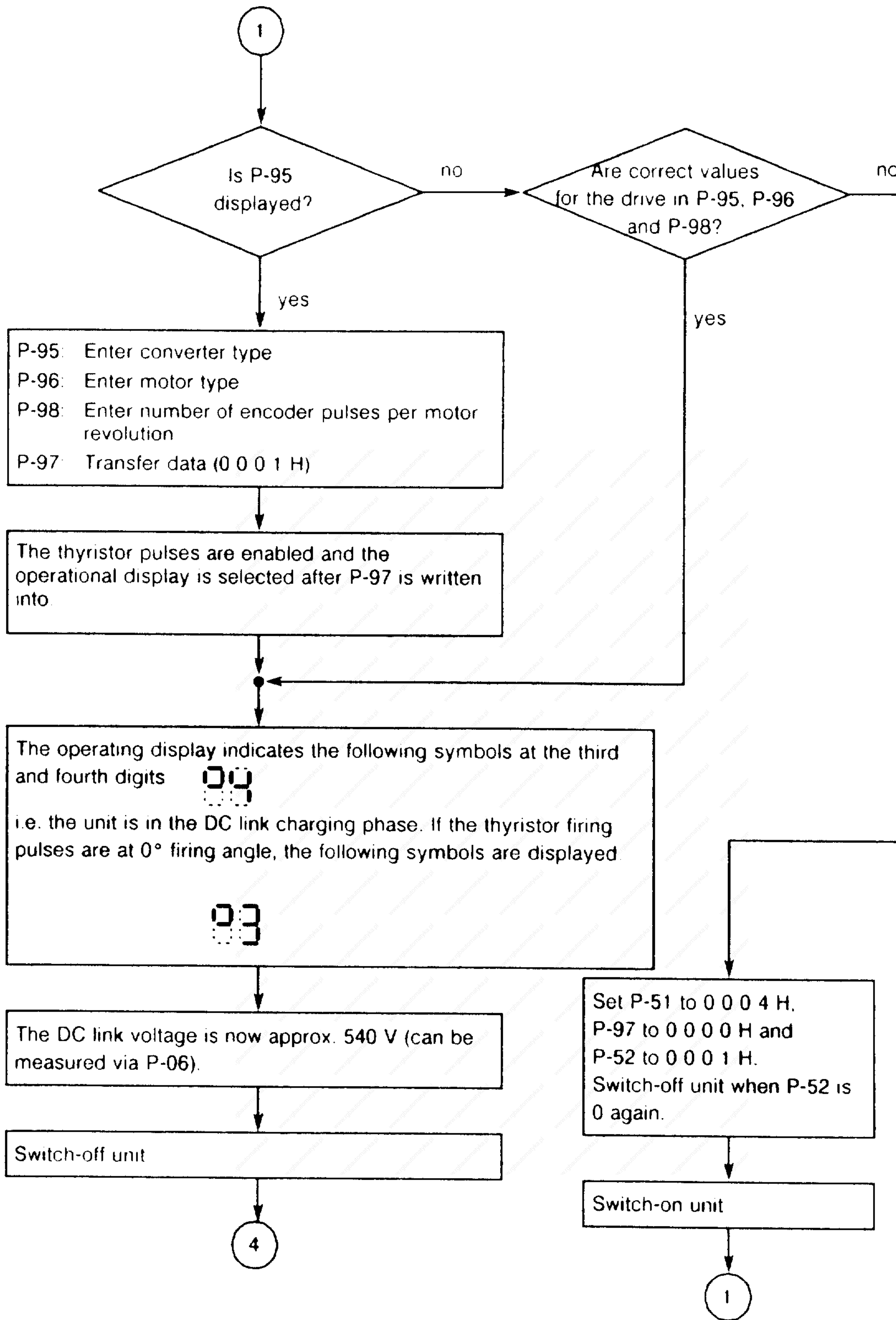



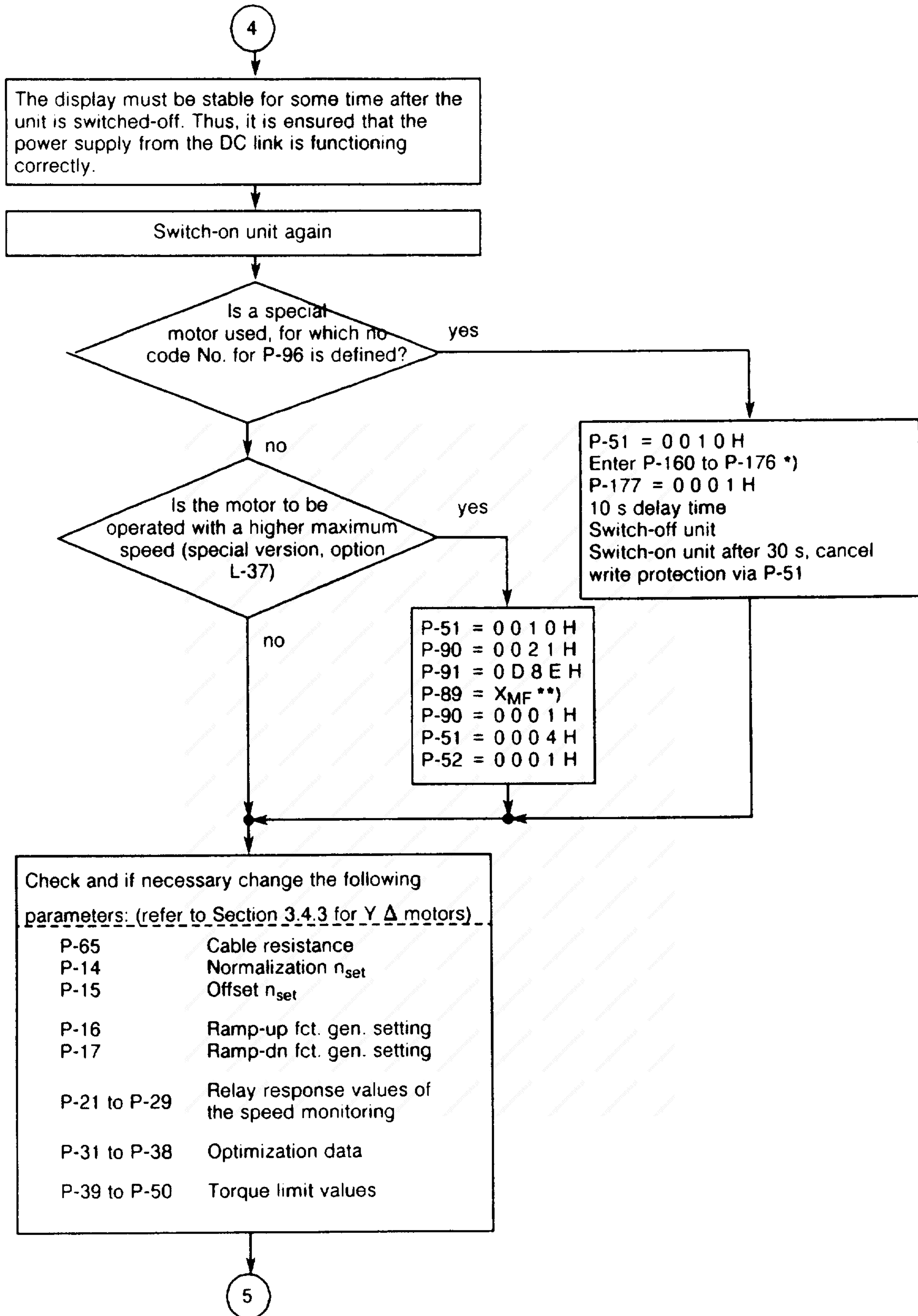

\*) The converter settings must be coordinated with Siemens AUT E242, if a special motor version is entered via P-160 to P-176

$$X_{MF} = \frac{n_{max} \times \text{pole pair No.}}{3000} \times 12 \times 1000 H \leq 7FFFH$$

$n_{max}$  in RPM  
 $X_{MF}$  = switch-off value, motor frequency

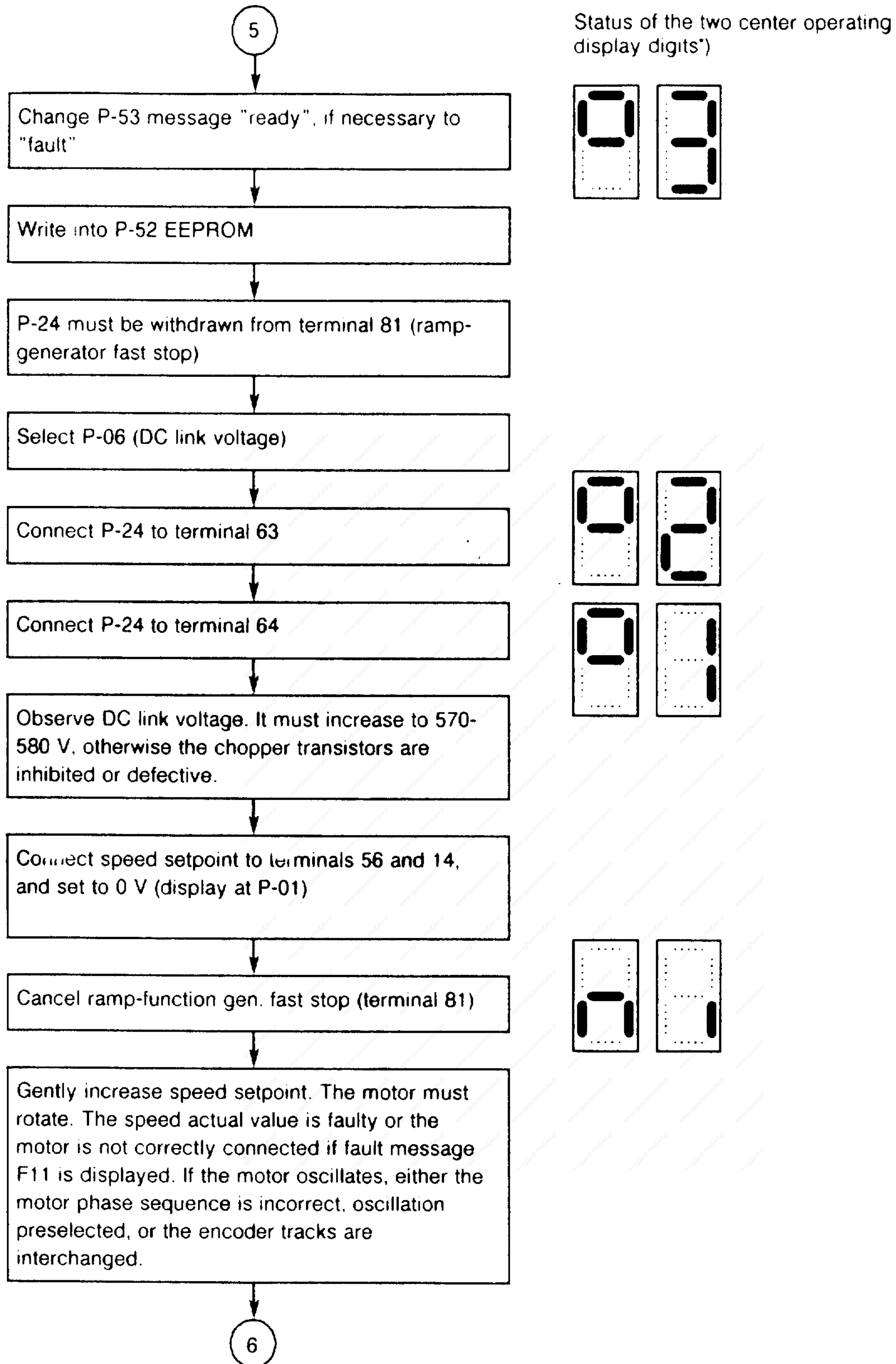

\*) Symbols refer to Section 3.3.1

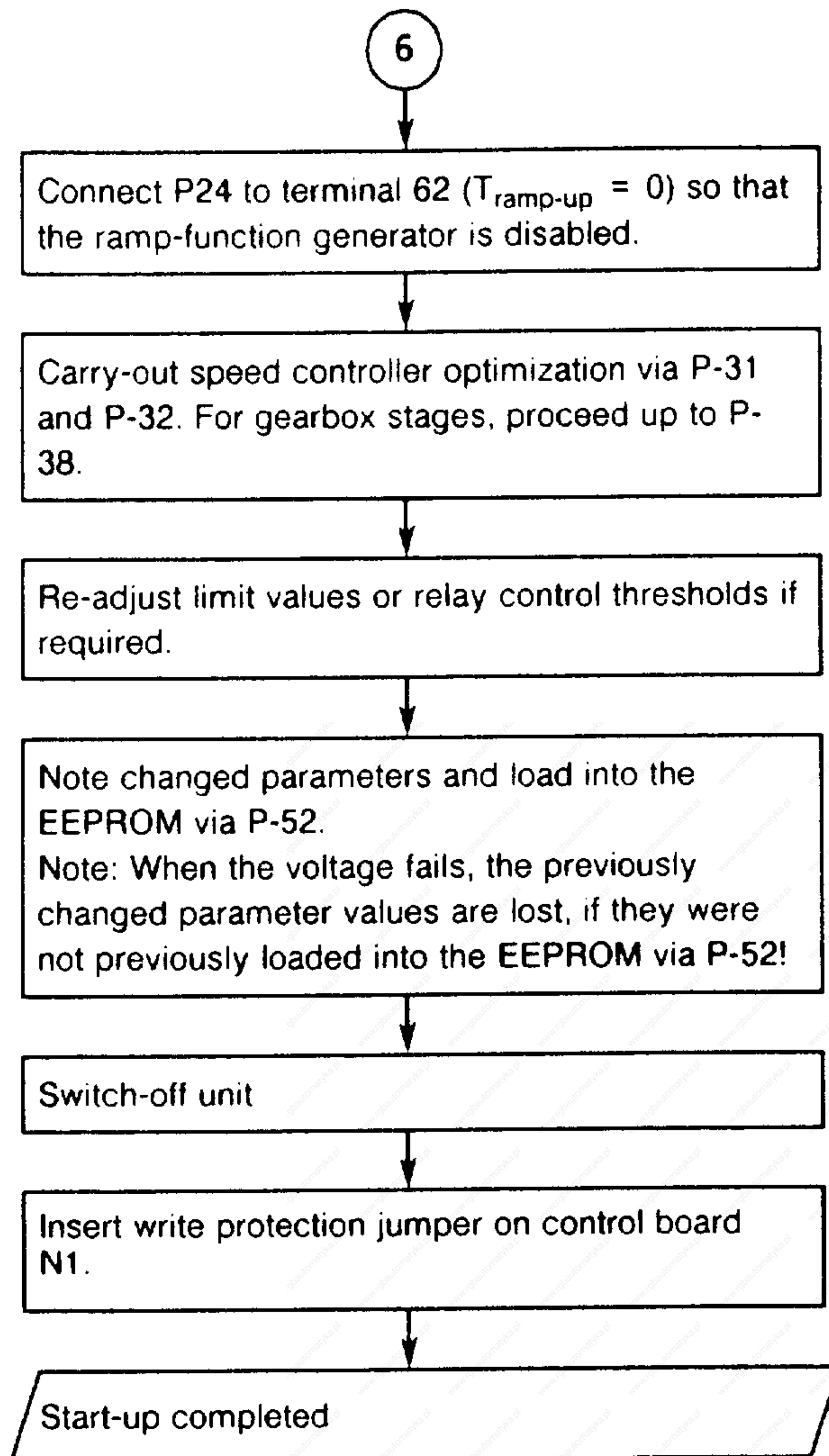

### 3.4.1 Start-up of the M19 NC auxiliary function

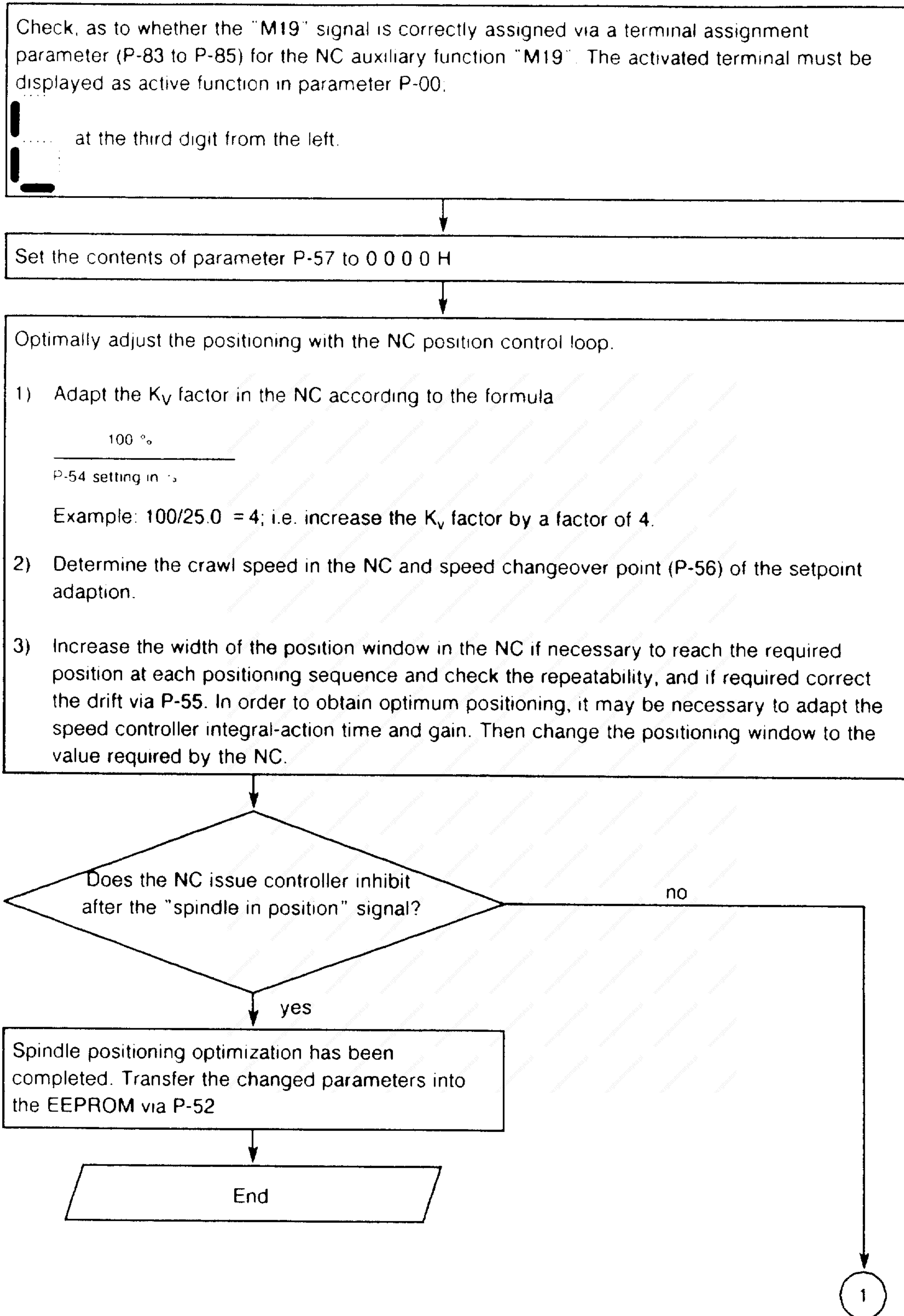

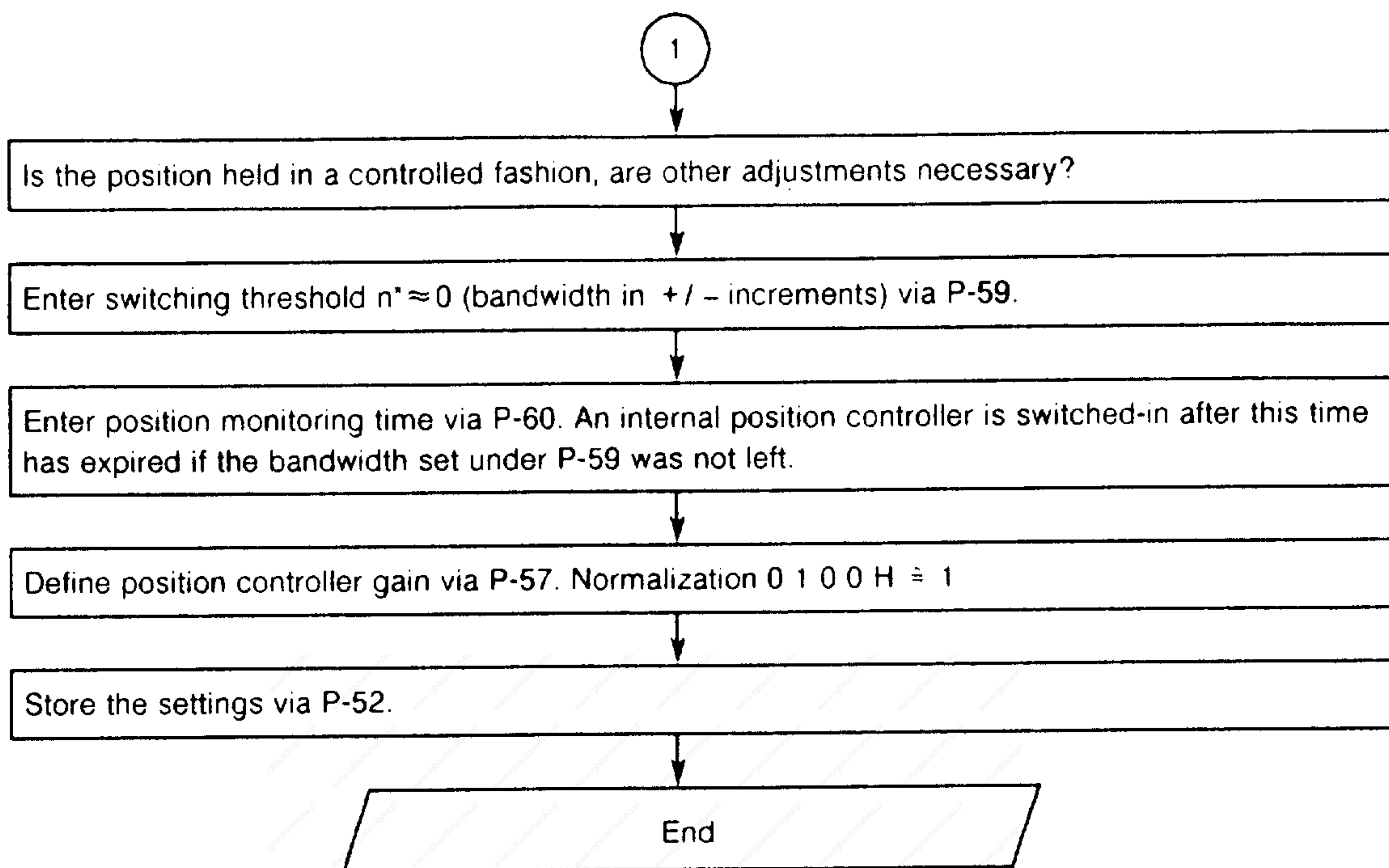

### 3.4.2 AC main spindle drive as slave drive

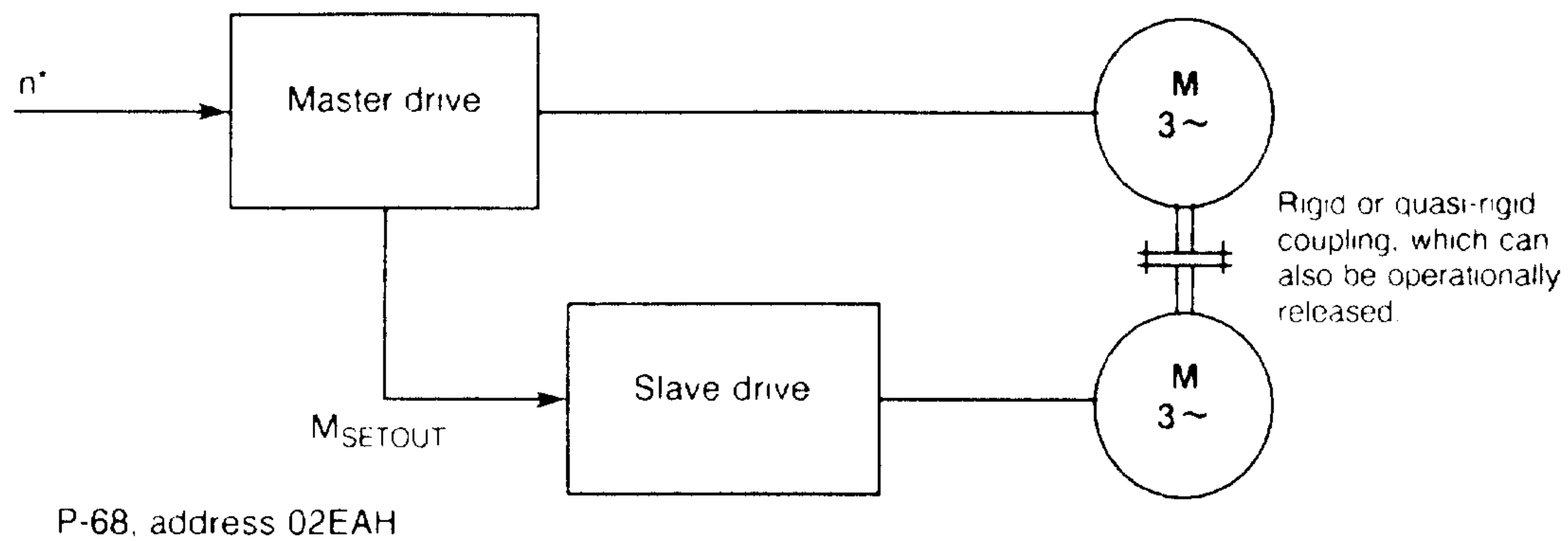

Fig. 3.4 Block circuit diagram of the slave drive

- Rigid drive coupling

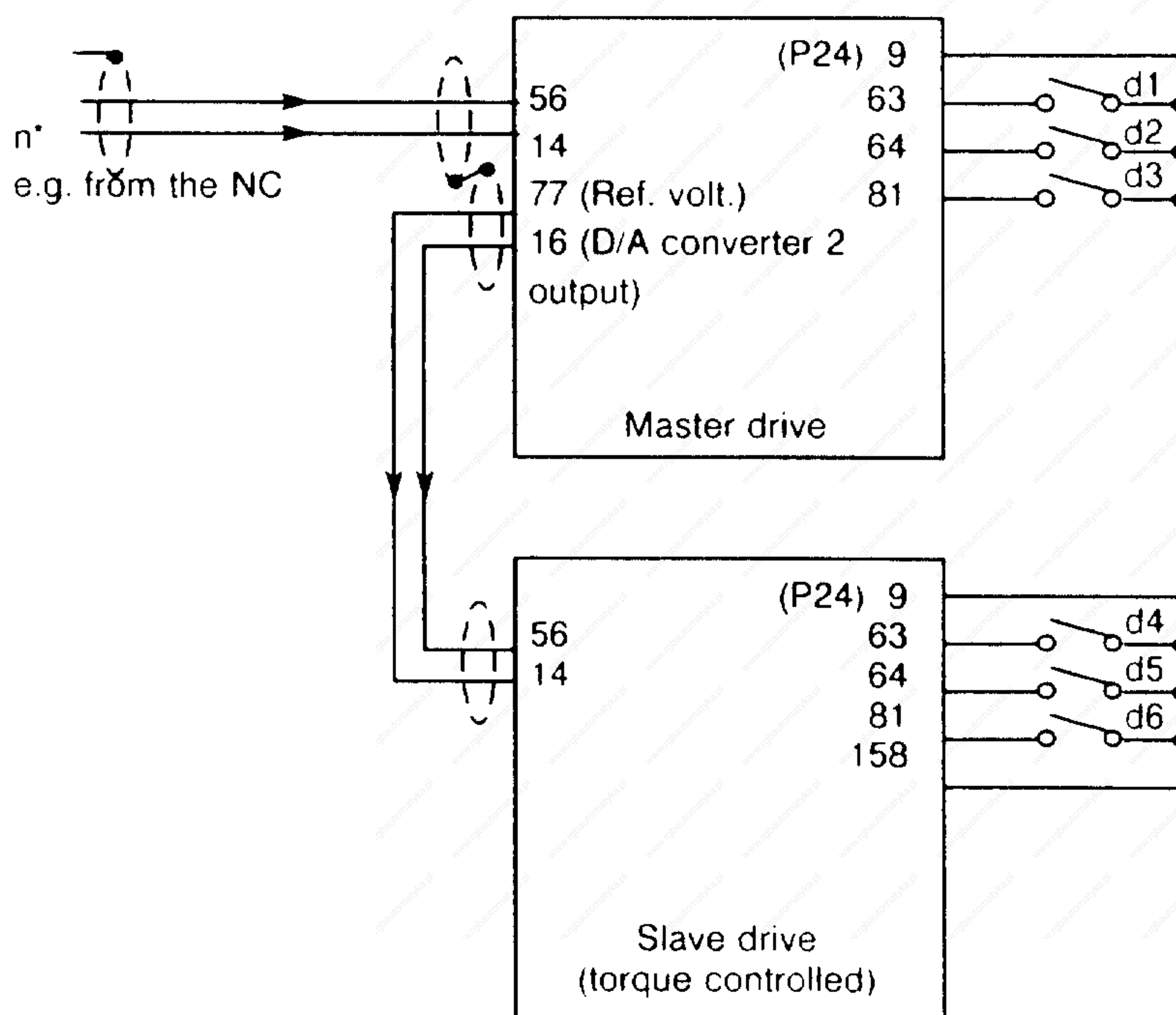

Fig. 3.5 Control logic wiring when the drives are rigidly coupled



## 3.4.2 AC main spindle drive as slave drive

Relay D7 switches the slave drive from speed control to torque control. Both motors must be mechanically coupled (checkback signal) before changeover is possible.

Individual speed-control must only be possible if the motors are not coupled. This operating mode must be selected via terminal 64, i.e. the speed setpoint must be connected to both drives. The drive, which should not run, does **not** receive a controller enable signal.

To couple the drives, terminals 78 and 18 can be used at the master drive instead of 77 and 16. This coupling is then in finer stages (higher resolution).

- **Parameter settings**

Parameter P-68 with the address 0 2 E A H must be written into so that the torque setpoint is available at terminals 16 and 77 of the input/output board of the master drive. Using parameter P-69 it can be determined, using shifting, as to which voltage is available at which specific torque. When zero is entered for parameter P-69, +5 V is available at terminals 16 and 76 at motor rated torque (if P-13 is set to 100%). It is possible to finely adjust this output value and sign reversal via parameter P-13.

When the slave drive is switched to torque control, parameters P-48 and P-49 are still effective. Torque adaption can be realized with P-48 (corresponds to P-14 in speed-controlled operation), and the torque drift can be compensated with P-49 (corresponds to P-15 in speed-controlled operation). Parameter P-49 is not suitable for compensating frictional forces. P-48 and P-49 are not effective in speed-controlled operation.

When using terminals 78 and 18, parameters P-76 and P-77 must be written into instead of parameters P-68 and P-69.



### 3.4.3 Star-delta motors

Star-delta motors permit a wider constant power range. At low speeds, the motor is operated in the star connection (high torque) and at higher speeds, in the delta connection (high breakdown torque). Changeover is also possible during operation. The changeover command (star/delta) must be issued externally (similar to a gearbox stage changeover).

#### 3.4.3.1 Connecting diagram

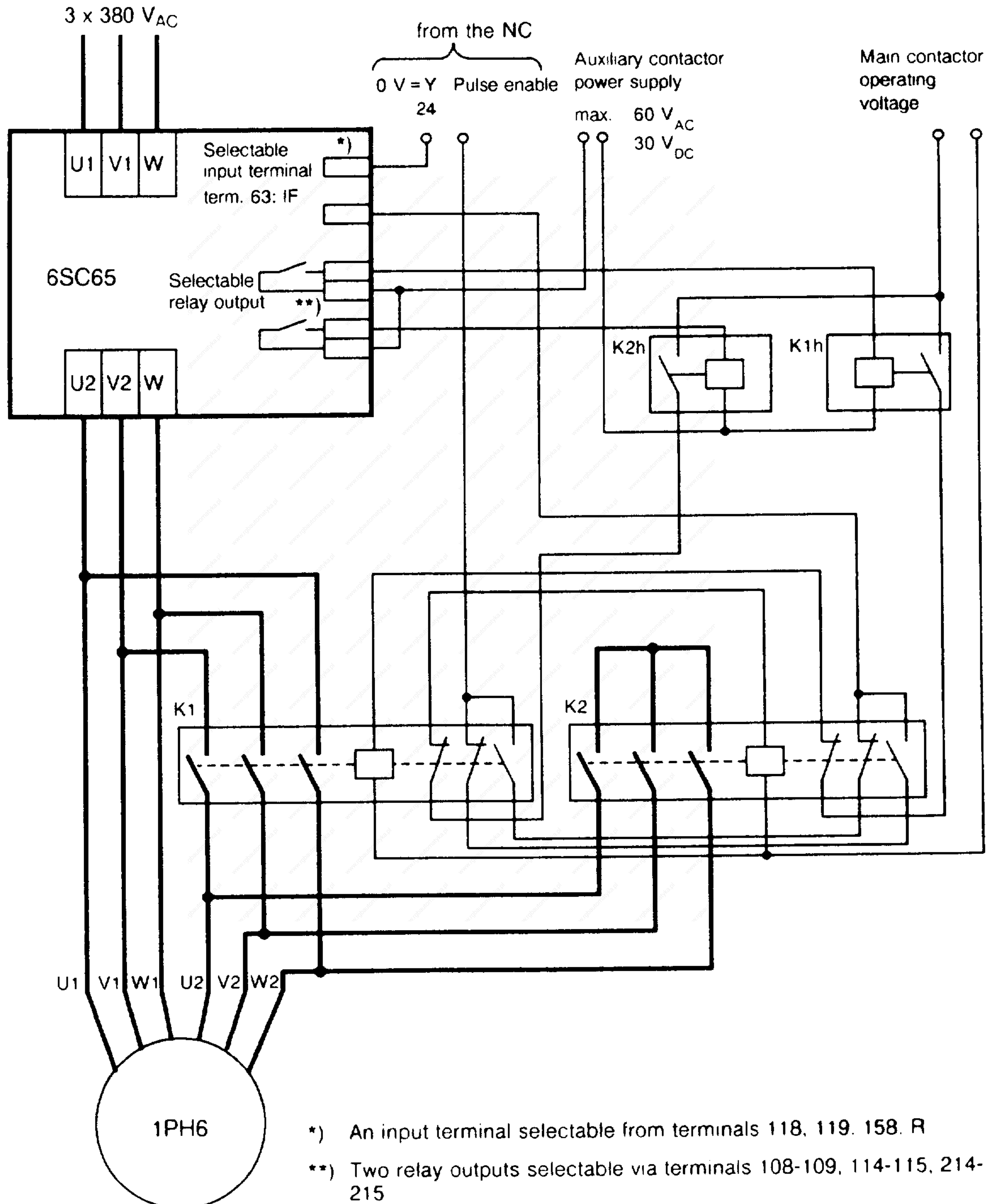

Fig. 3.7 Connecting diagram for star-delta changeover

### 3.4.3.2 Circuit and function description

The changeover from star to delta contactor is realized by selecting one of the freely selectable input terminals 118, 119, 158 or R, per software. Auxiliary contactor K2h, and star contactor K2 are pulled-in when "0 V" is connected to the programmed terminal via a freely programmable relay output ( $n_{act} < n_{min}$ ;  $n_{act} > n_x$  or  $M_d > M_{dx}$ ).

"24V" signal level causes auxiliary contactor K1h and delta contactor K1 to be pulled-in through an additional relay.

Contactors K1 and K2 are interlocked for safety reasons in addition to software interlocking to prevent inadmissible switching operations.

The changeover from star to delta operation should be realized at 1250 RPM (delta connection operating point). The maximum speed is reached in the delta connection (6500/8000 RPM); whereby in the star connection, the maximum attainable speed is approximately 6.5 x rated speed (at  $n_N = 650$  RPM,  $n_{max} 4300$  RPM). A changeover command from star to delta operation and from delta to star operation is interlocked per software at speeds  $> 3000$  RPM, as above 3000 RPM up to  $n_{max}$ , no demagnetizing or magnetizing sequences can be initiated.

### 3.4.3.3 Example of a star-delta changeover

1. After the changeover request has been de-bounced (rising edge  $Y/\Delta$ ), the drive is switched to a current-free condition and thus torque-free using internal pulse cancellation. The speed decreases (the motor coasts down) and the flux decays with the rotor time constant according to an exponential function.
2. The "star contactor off" and "delta contactor on" control signals are output via relay outputs.
3. The inverter pulses are enabled, the motor magnetized and the speed controller enabled after the contactor switching time and the flux decay time have expired (approx. 3 rotor time constants).  
Changeover times in the range of one to two seconds can be expected for the described procedure.

### 3.4.3.4 Handling setting parameters P-83 to P-86, P-241 to P-243

Two motor data fields are necessary (P-160 to P-176, P-220 to P-236), for the star-delta motors to take into account saturation effects.

Motor numbers above 200 are provided for listed motors (refer to the Appendix). In this case, the even motor number represents the data field for the star connection, and the following uneven number, the data field for the delta connection. At initialization, only even motor numbers can be entered.

As before, parameter range 160 to 176 is available for the star connection for entering data from another motor manufacturer. The delta data can be entered in the newly created parameter area 220 to 236. Transfer is realized with parameter 177 (star) and 237 (delta). Star-delta motors have the code number 98.

If a motor with the Code No. 98 or  $\geq 200$  is loaded in parameter 96, then Y/ $\Delta$  operation is identified. The command for selecting the  $\Delta$  connection must be entered through one of the select terminals (118, 119, 158, R) via parameters P-83 to P-86 (the  $\Delta$  connection is selected by setting bits  $2^6 = 400H$ ). The Y circuit is automatically selected if this selection is not activated.

The relay control selection for the star and delta contactors must be realized via the relay function parameters P-241 to P-243. The relays can be assigned the following functions using different parameters settings.

Setting code	Function
0001	Star connection
0002	Delta connection
0008	$n_{act} < n_{min}$
0020	$M_d > M_{dx}$
0040	$n_{act} < n_x$

After initialization, the parameters are preset as follows:

**P- 241** 0 0 2 0 H  $M_d > M_{dx}$  relay (terminals 108 - 110)  
**P- 242** 0 0 4 0 H  $n_{act} < n_x$  relay (terminals 114 - 116)  
**P- 243** 0 0 0 8 H  $n_{act} < n_{min}$  relay (terminals 114 - 116)

Example of the parameter setting for Y- $\Delta$  operation before the "first start" for pulse and controller inhibit.

**P- 86** 0 4 0 0 H (Select  $\Delta$  operation via terminal 118)  
**P- 241** 0 0 0 2 H (Select  $\Delta$  contactor via terminals 108-110)  
**P- 242** 0 0 0 1 H (Select Y contactor via terminals 214-216)

Parameter P00 indicates at the second digit from the right, a "y" for star and "d" for delta to identify as to whether star or delta operation has been selected.

### 3.4.3.5 C-axis operation

C-axis operation is only possible in the star connection. The terminal request "C axis" has priority over the "delta" request.

If C-axis operation is selected in the delta connection and the speed is greater than zero, the drive brakes to zero speed. A changeover is then made to the star connection and C-axis operation is initiated.

### 3.4.3.6 Speed controller

The P gain and integral-action time are automatically adapted for both star and delta connections.

In order to prevent instability using the initialized values, the proportional gain for the star connection is internally reduced by a factor of four.

Separate controller setting and torque limits for star and delta operation can be achieved by simultaneous selection of a gearbox stage terminal.

## 4 Faults

### 4.1 Fault display

When a fault occurs, the fault program is selected per software instead of the operator control program. The fault is indicated by the following flashing symbols:

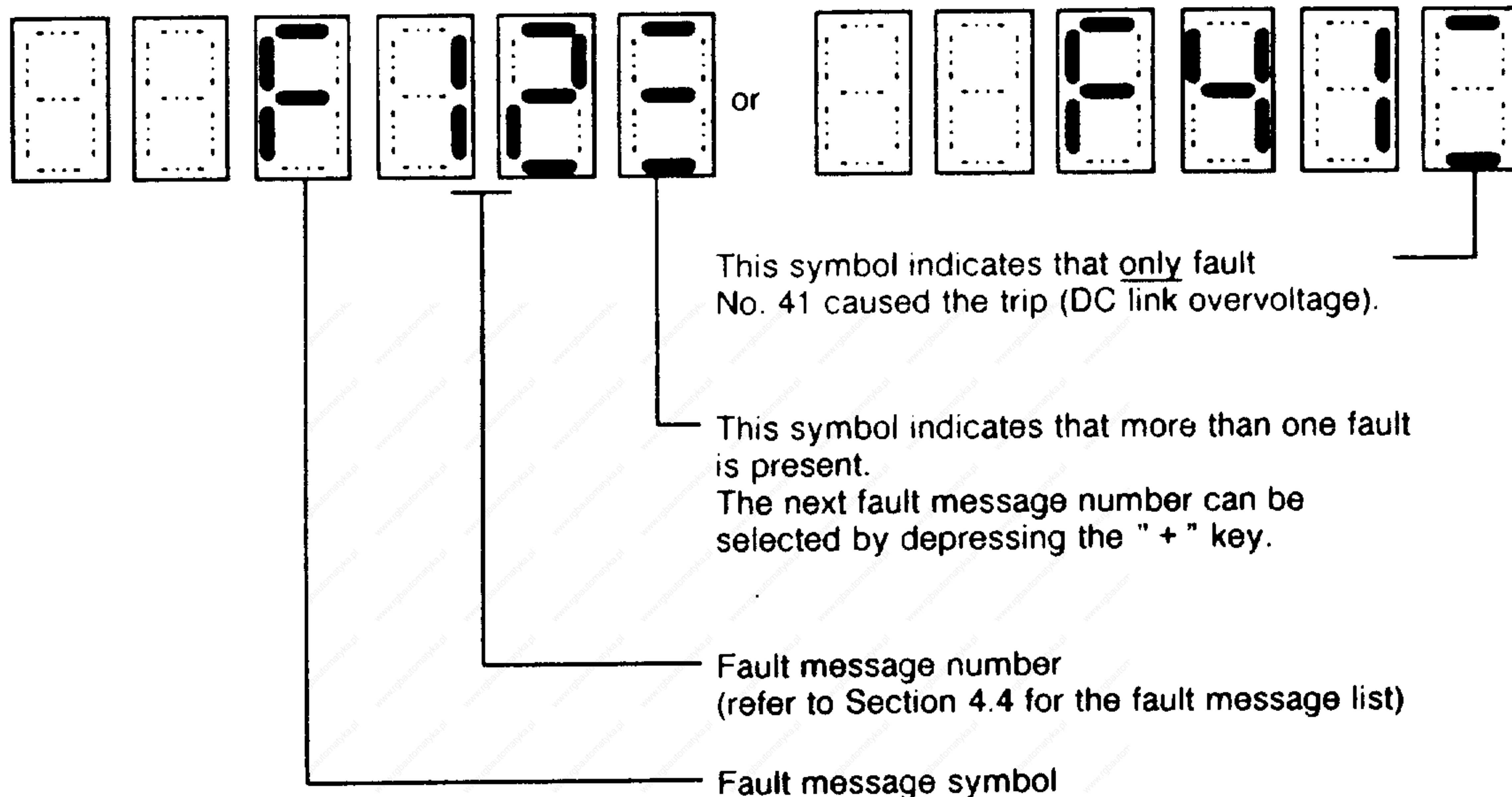

### 4.2 Faults after switch-on

When the operating display LED remains dark after switch-on, this can involve the following faults:

- Motor protection circuit-breaker not switched-in
- At least two phases missing
- At least two incoming fuses have blown
- Power supply fuses on the gating board A0 in the infeed/regen. feedback unit blown \*)
- The connection between the display board H1 and control board N1 faulted
- 5 V power supply faulted
- Control board N1 defective

The following faults might have occurred when all display LEDs (8.8.8.8.8.) are lit after the unit is switched-on:

- Defective control board N1
- EPROM on the control board N1 incorrectly inserted or defect
- No input/output board initializing pulse

### 4.3 Faults after controller enable

The motor phase sequence is incorrect (2 phase connections interchanged) if the motor has a maximum speed of 10 RPM at a setpoint input  $n^* > 0.2$  V, or the motor oscillates (oscillation not preselected) at  $n^* < 0.2$  V.

\*) only for 6SC6502 and 6SC6503

## 4.4 Fault signal list

For fault finding, the equipment should be checked in the sequence in which it is listed.

Fault signal	Fault	Cause
<b>F-01</b>	Supply fault	<ul style="list-style-type: none"> <li>- Pulse cable U4-X117→G02-X117 not inserted *)</li> <li>- Phase missing</li> <li>- Fuse F1, F2 or F3 blown</li> <li>- Fuse F4, F5 or F6 on A0 blown *)</li> <li>- A0 defective or not correctly inserted *)</li> <li>- U1 defective or not correctly inserted</li> <li>- N1 defective or not correctly inserted</li> </ul>
<b>F-02</b>	Incorrect phase sequence	<ul style="list-style-type: none"> <li>- Incorrect supply phase sequence (supply connection)</li> </ul>
<b>F-11</b>	Speed controller is at its limit, speed actual value missing	<ul style="list-style-type: none"> <li>- Motor encoder connector not inserted</li> <li>- Connecting cable to the encoder interrupted</li> <li>- Defective encoder</li> <li>- Defective ribbon cable or cable not correctly inserted</li> <li>- Motor ground not connected</li> <li>- Motor not connected or phase missing</li> <li>- Motor rotor blocked</li> <li>- U1 defective</li> <li>- Gating unit - EPROMs defective</li> <li>- Defective power supply for the gating or gating board</li> <li>- DC link fuse blown</li> </ul>
<b>F-12</b>	Inverter overcurrent	<ul style="list-style-type: none"> <li>- Incorrect motor/converter assignment</li> <li>- Short-circuit/ground fault at the converter/motor</li> <li>- Defective current sensor, U12, U13</li> <li>- Ribbon cable defective or not correctly inserted</li> <li>- U1 defective</li> <li>- N1 defective</li> <li>- <math>M_d</math> limit set too high (e.g. P-39)</li> <li>- Defective inverter transistor</li> </ul>
<b>F-14</b>	Motor overtemperature	<ul style="list-style-type: none"> <li>- Motor overloaded</li> <li>- Motor current too high, e.g. due to incorrect motor data in P-96</li> <li>- Defective PTC thermistor (motor)</li> <li>- Defective motor fan</li> <li>- U1 defective</li> <li>- Motor winding short-circuit</li> </ul>
<b>F-15 ***)</b>	Converter overtemperature	<ul style="list-style-type: none"> <li>- Converter overloaded (incorrect motor/converter assignment)</li> <li>- Ambient temperature too high</li> <li>- Fan failed</li> <li>- Defective PTC thermistor</li> <li>- Motor protection circuit-breaker Q1 or Q2 tripped**)</li> </ul>
<b>F-19</b>	Temperature sensor interrupted	<ul style="list-style-type: none"> <li>- NTC thermistor defective (motor)</li> <li>- Sensor connection interrupted</li> <li>- Temperature below - 20 °C</li> <li>- U1 defective</li> </ul>

\*) Only for 6SC6502 and 6SC6503

\*\*) For converters 6SC6504/06/08/12/20 from June 1990.

\*\*) Fault signal F15 can be suppressed via P-19 (refer to Section 3.3.9).

Fault signal	Fault	Cause
F-40	Internal power supply faulted	<ul style="list-style-type: none"> <li>- P15</li> <li>- P10 missing or</li> <li>- N10REF faulted</li> <li>- P5</li> <li>- P24</li> <li>- G01 defective</li> <li>- G02 defective</li> <li>- U1 defective</li> <li>- Ground fault, motor phase (low-ohmic &lt; 10 kΩ)</li> </ul>
F-41	DC link overvoltage	<ul style="list-style-type: none"> <li>- DC link capacitors defective</li> <li>- Temporary supply overvoltage</li> <li>- Defective voltage sensing on A0*), or G01, or U1</li> <li>- Incorrect motor/converter assignment</li> <li>- Supply failure during regenerative operation</li> <li>- Sporadic fault due to the encoder or encoder cable</li> <li>- Defective diode V9 of V10**) or chopper module V1 (+ V11****), V5 (+ V55****)</li> <li>- Direct ground fault, motor phase</li> <li>- Motor breakdown torque exceeded (P-176 too large)</li> <li>- Thyristor defective</li> </ul>
F-42	DC link overcurrent	<ul style="list-style-type: none"> <li>- Converter overloaded</li> <li>- A0 defective *)</li> <li>- Current transformer U11 defective</li> <li>- Chopper transistors V1 (+ V11****), V5 (+ V55****) defective</li> <li>- Thyristor defective</li> <li>- Short-circuit in the DC link</li> <li>- U1 defective</li> <li>- N1 defective</li> <li>- Power section ground fault (V1-V8)</li> <li>- Motor breakdown torque exceeded (P-176 too large)</li> <li>- Motor ground fault</li> </ul>
F-48****)		
F-51	DC link overvoltage	<ul style="list-style-type: none"> <li>- N1 defective, otherwise as for fault message F-41</li> <li>- U1 defective</li> </ul>
F-52	DC link undervoltage	<ul style="list-style-type: none"> <li>- Temporary supply dip</li> <li>- A0 defective *)</li> <li>- G01 (G02*) defective</li> <li>- U1 defective</li> </ul>
F-53	Charge fault (DC link)	<ul style="list-style-type: none"> <li>- Thyristor firing pulses removed A0-X13, -X14 *)</li> <li>- A0 defective *)</li> <li>- G02 defective *)</li> <li>- G01 defective</li> <li>- U1 defective</li> <li>- N1 defective</li> <li>- DC link capacitors defective</li> </ul>

\*) Only for 6SC6502 and 6SC6503

\*\*) Only for 6SC6512 and 6SC6520

\*\*\*) Fault signal F-48 is omitted from software release 09 onwards

\*\*\*\*) Only for 6SC6520

## 4.4 Fault signal list

Fault signal	Fault	Cause
<b>F-54</b>	Supply fault	<ul style="list-style-type: none"> <li>- 45 Hz &gt; supply frequency &gt; 65 Hz</li> <li>- High supply frequency fluctuations</li> <li>- Supply synchronizing voltage missing</li> <li>- A0 defective *)</li> <li>- U1 defective</li> <li>- N1 defective</li> </ul>
<b>F-55</b>	Erroneous setpoint calculation	<ul style="list-style-type: none"> <li>- Values entered in the EEPROM exceed the limit values (initialization necessary)</li> </ul>
<b>F-56**)</b>	Supply frequency timer failed	<ul style="list-style-type: none"> <li>- N1 defective</li> <li>- U1 defective</li> <li>- G01 defective</li> </ul>
<b>F-57</b>	Frequency sensing in the PLL circuit faulted	<ul style="list-style-type: none"> <li>- N1 defective</li> </ul>
<b>F-61</b>	Maximum motor frequency exceeded	<ul style="list-style-type: none"> <li>- Excessive motor frequency input from the control processor</li> <li>- Excessive maximum motor speed entered in P-29</li> </ul>
<b>F-64</b>	Gating unit EPROM incorrect or defective	<ul style="list-style-type: none"> <li>- EPROMs D76 and D78 on N1 defective</li> </ul>
<b>F-71</b>	EPROM sumcheck error L byte, control processor	<ul style="list-style-type: none"> <li>- EPROM D82 on N1 defective</li> </ul>
<b>F-72</b>	EPROM sumcheck error H byte, control processor	<ul style="list-style-type: none"> <li>- EPROM D80 on N1 defective</li> </ul>
<b>F-73</b>	EPROM sumcheck error L byte, gating unit processor	<ul style="list-style-type: none"> <li>- EPROM D78 on N1 defective</li> </ul>
<b>F-74</b>	EPROM sumcheck error H byte, gating unit processor	<ul style="list-style-type: none"> <li>- EPROM D76 on N1 defective</li> </ul>
<b>F-75</b>	EEPROM sumcheck error	<ul style="list-style-type: none"> <li>- Memory error in the EEPROM (initialization required)</li> <li>- EEPROM D74 defective</li> </ul>
<b>F-77</b>	Initializing pulse missing	<ul style="list-style-type: none"> <li>- Control board N1 not correctly inserted</li> <li>- Input/output U1 not correctly inserted</li> <li>- U1 defective</li> </ul>
<b>F-78</b>	On/off program processing time exceeded	<ul style="list-style-type: none"> <li>- EEPROM D74 error (Initialization required or EEPROM must be replaced)</li> </ul>
<b>F-81</b>	DC link overvoltage	<ul style="list-style-type: none"> <li>- G02 defective</li> <li>- A0 defective *)</li> <li>- U1 defective</li> </ul>

\*) Only for 6SC6502 and 6SC6503

\*\*) Fault signal not available from software release 12 (refer to Section 4.7.3)

Fault signal	Fault	Cause
F-91	No-load voltage greater than the rated voltage	} Motor data incorrectly entered. New entry necessary
F-92	Rated flux less than the flux at f = 125 Hz	
F-93	2nd transition frequency less than 1st trans. freq.	
F-94	2nd transition frequency less than rated frequency	
F-P1	Unattainable position setpoint	
F-P2	Zero mark missing	

## 4.5 Fault acknowledgement

Faults can be acknowledged as follows:

- **Parameter key**

By depressing the parameter key with controller inhibit. Both outside displays are switched dark during acknowledgement. A return is made to the operator control program after acknowledgment if no additional fault is present.

- **Remote acknowledgement 1**

With the change from controller enable (terminal 64) to controller inhibit with DC link voltage available.

This type of acknowledgement is only effective when 0 0  $\geq$  0 H is set in parameter P-53.

- **Remote acknowledgement 2**

When controller inhibit is available and terminal "R" (reset) is activated.

- **Automatic acknowledgement of fault messages F-01 and F-02**

After brief voltage failures, whereby the electronics power supply is buffered from the DC link, fault messages F-01 and F-02 can be automatically acknowledged by appropriately setting bit 6 in parameter P-53 (refer to Section 3.3.9) at controller inhibit.

- **Switch-off**

Switch the unit off and on again.



4.6 Selecting the operator control interface

### 4.6 Selecting the operator control interface

The operator control program is returned to by depressing the parameter key after acknowledgement has been made with the controller inhibit function. Acknowledgement using this function can be identified with the non-flashing fault display.

When a fault is present, the operator control program can be selected for approx. one minute by briefly depressing the "-" key.

### 4.7 Diagnostic aids

#### 4.7.1 Measuring sockets and LEDs

Measuring sockets and LEDs, as additional diagnostic aids, are available on the control and input output board in addition to the display.

The functions of the LEDs and the use of the control board measuring sockets (refer to Fig. 4.2) are described in Section 3.3.12.

The following values can be measured via the input/output board sockets:

- $I_R$  : Motor current in phase R
- $I_S$  : Motor current in phase S
- $I_T$  : Motor current in phase T
- $I_D$  : DC link current

Converter	$I_R, I_S, I_T$	$I_D$
6SC6502	5 V $\hat{=}$ 45 A	10 V $\hat{=}$ 75 A
6SC6503	5 V $\hat{=}$ 70 A	10 V $\hat{=}$ 75 A
6SC6504	5 V $\hat{=}$ 90 A	10 V $\hat{=}$ 90 A
6SC6506*)	5 V $\hat{=}$ 140 A	10 V $\hat{=}$ 140 A
6SC6508	5 V $\hat{=}$ 180 A	10 V $\hat{=}$ 180 A
6SC6512	5 V $\hat{=}$ 333 A	10 V $\hat{=}$ 333 A
6SC6520	5 V $\hat{=}$ 500 A	10 V $\hat{=}$ 500 A

- $I_{WR}$  : Absolute motor current  
Rectification of the actual values of the three phase currents ( $I_R/I_S/I_T$ )
- M : Reference potential

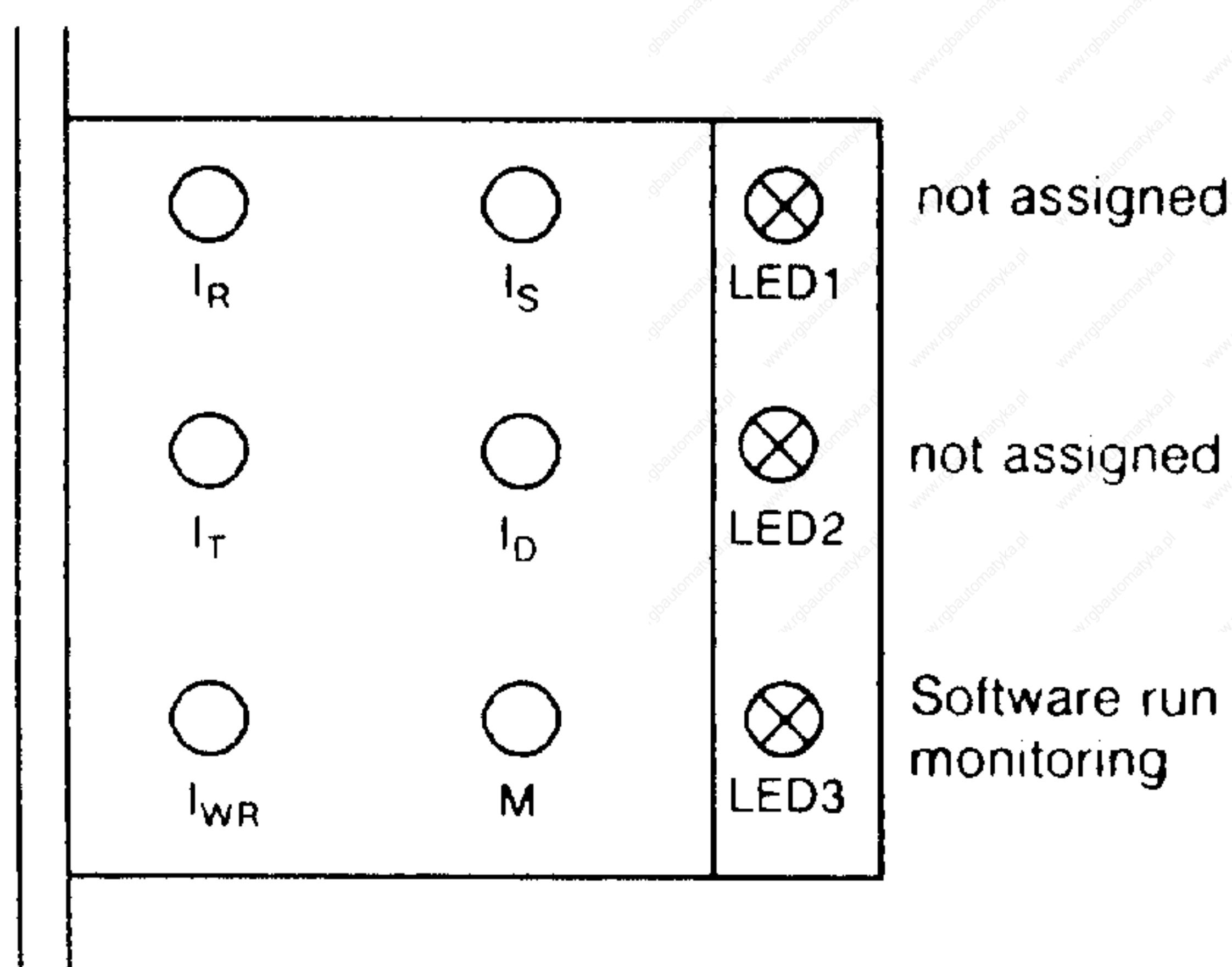

Fig. 4.1 Location of the measuring sockets in the front panel of input/output board U1

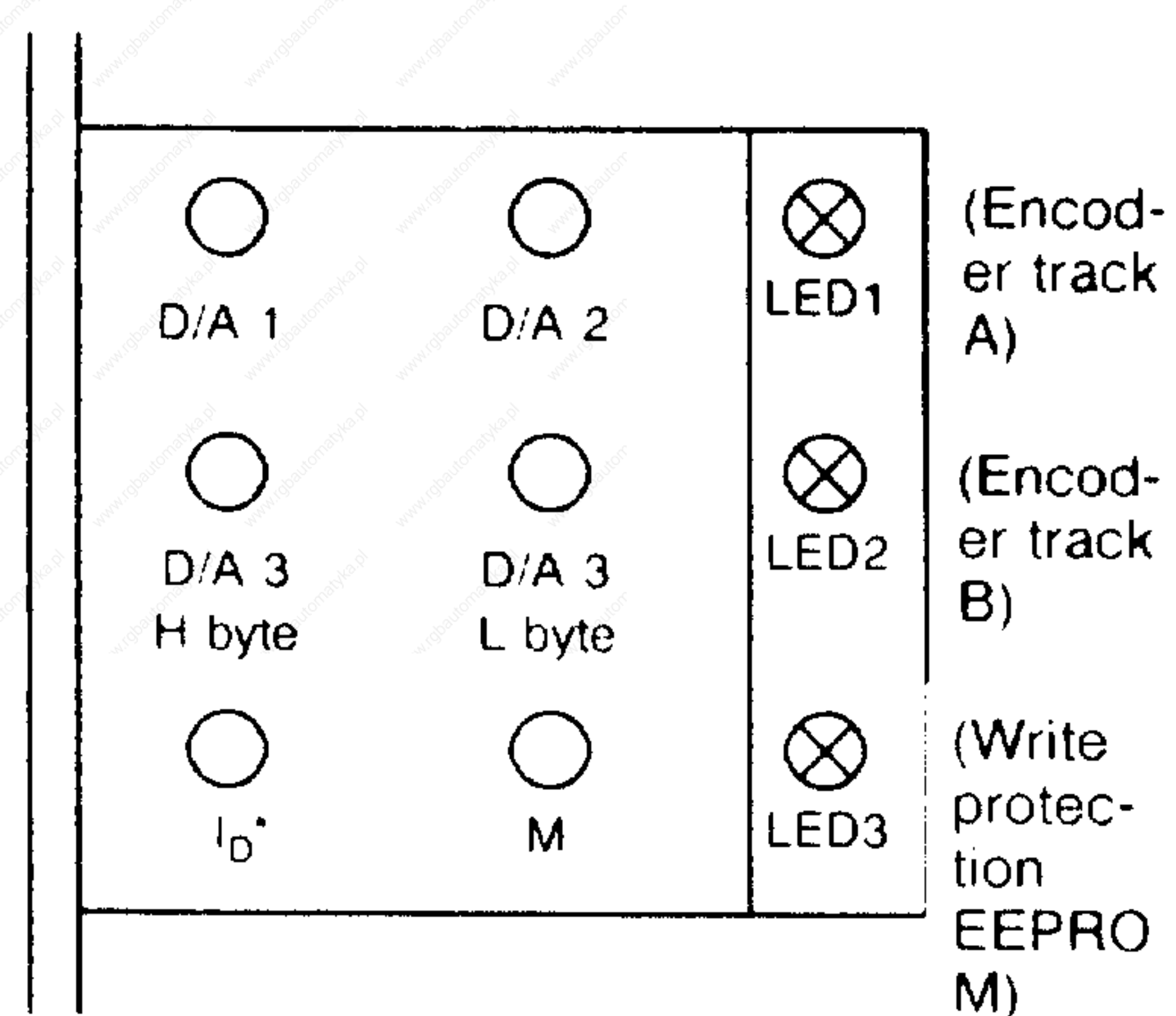

Fig. 4.2 Location of the measuring sockets in the front panel of control board N1

\*) For converters 6SC6506-4AA00.01: 5 V  $\hat{=}$  180 A | 10 V  $\hat{=}$  180

## 4.7.2 Transistor diagnostic parameters

**(P-70)** The transistor diagnostic parameter P70 is available for transistor monitoring. Parameter contents which are not equal to 0 0 0 0 H can be caused by the following:

Gating board A1 defective  
Power supply for A1 missing  
Transistor in the inverter module defective  
Input/output board U1 defective

When a transistor monitoring function responds, the parameter contents change from 0 0 0 0 H into the appropriate transistor value.

Phase U2	0 0 0 1 H	Transistor V2 (+ V22**) (module V2)*) faulted
	0 0 0 2 H	Transistor V6 (+ V66**) (module V2)*) faulted
Phase V2	0 0 0 4 H	Transistor V3 (+ V33**) (module V3)*) faulted
	0 0 0 8 H	Transistor V7 (+ V77**) (module V3)*) faulted
Phase W2	0 0 1 0 H	Transistor V4 (+ V44**) (module V4)*) faulted
	0 0 2 0 H	Transistor V8 (+ V88**) (module V4)*) faulted
Chopper	0 0 4 0 H	Transistor V1 (+ V1**) faulted
	0 0 8 0 H	Transistor V5 (+ V5**) faulted
	0 0 F F H	A1 power supply missing

The parameter contents are reset to 0 0 0 0 H when a fault is acknowledged or by switching the unit off and on again.

If several transistor monitoring functions have responded simultaneously, then other parameter contents are possible.

## 4.7.3 Fault flags

**(P-28)** Fault signals are stored in P-28 which do not lead to shutdown (pulse inhibit)

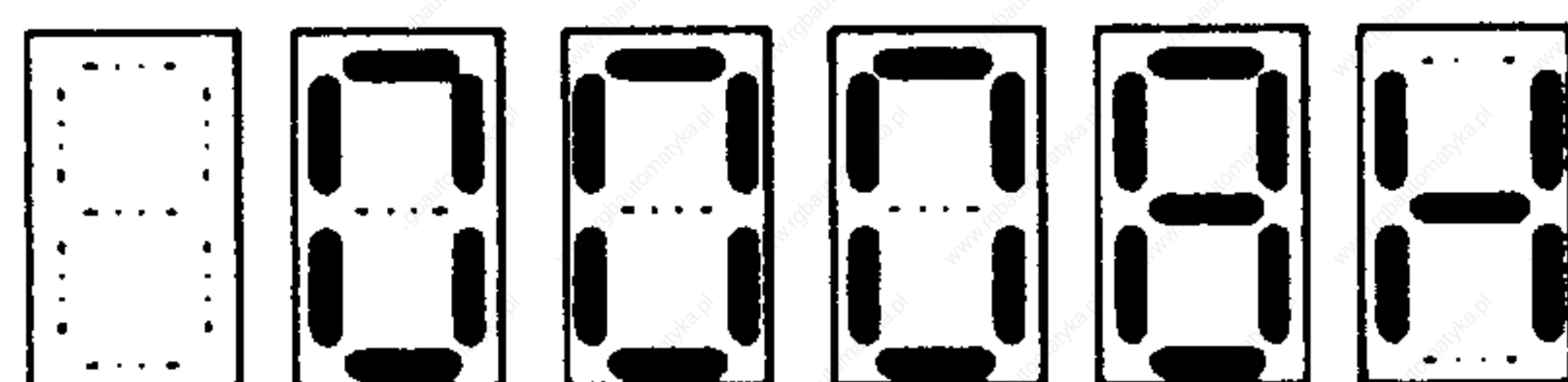

Calibration error in the DC link voltage actual value sensing

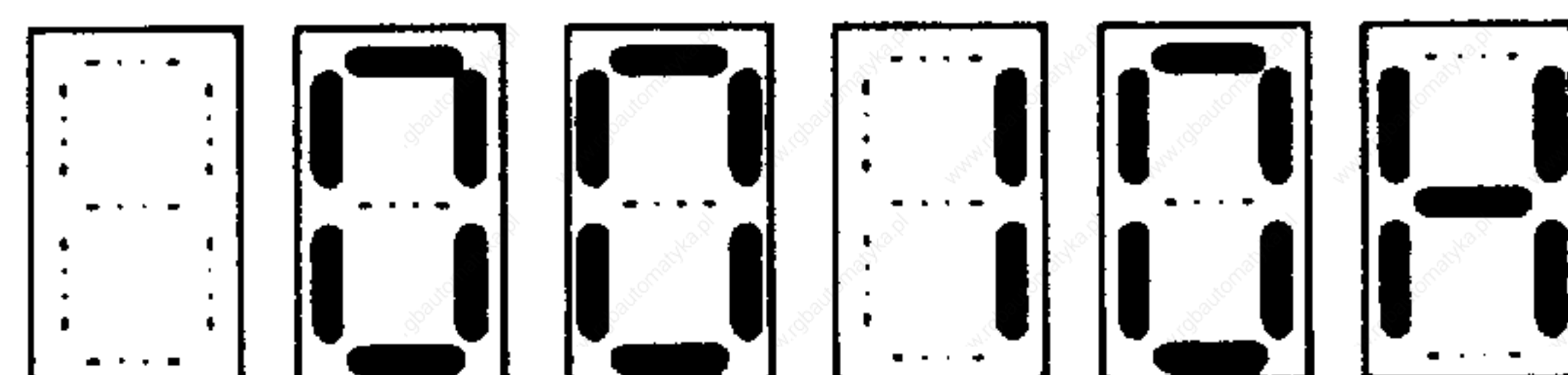

P-24 V external power supply faulted

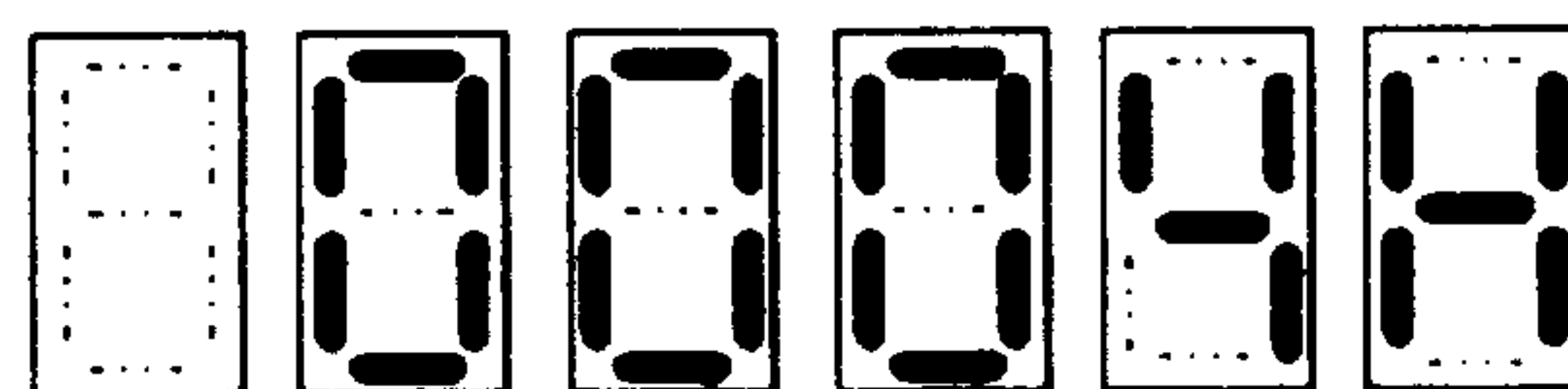

Fault identification with the supply frequency sensing (previously "F-56")

\*) Only valid for 6SC6502 to 6SC6506

\*\*) Only valid for 6SC6520

#### 4.7.4 Speed actual value fault counter

**P-20** Parameter P-20 is used for speed sensing monitoring.

The contents of P-20 is increased by 1 if a speed difference of approx. 100 RPM is identified within the sampling time (3ms).

Sporadic counting by a few increments is insignificant as the speed controller is not influenced.

If the contents of P-20 are continuously increased by several increments, a significant fault level is present.

The causes can be:

- Encoder screen not grounded (refer to Section 2.2.1)
- Defective encoder
- The power supply M potential (electronics ground) is not connected to PE (housing) (refer to Section 2.2).
- Motor ground is not connected to the converter

#### 4.7.5 Minimum/maximum value memory (from software release 09)

Parameters P-181, P-182 and P-183 are available for monitoring several variables (RAM data cells).

**P-181** Address of the variable to be monitored.

The parameter contents can be stored in the EEPROM.

**P-182** Minimum value

**P-183** Maximum value

The memory function is re-started by changing the address in parameter P-181 and re-entering the original address.

#### 4.7.6 Voltage-frequency (U/f) open-loop control

**P-184** U/f open-loop control is selected if this parameter is set to 0 0 0 1 H. It is indicated via P-00, 3rd digit.

The speed actual values (address 0 D 3 4 H from software release 08 onwards) and the inverter current actual values can be checked in this operating mode.



Symbol



**Note:**

- 1) Speed setpoint steps with low ramp-up time (P-16, P-17) lead to fault signals (F-41).
- 2) Terminal 62 (TH = 0) is ineffective.
- 3) The setpoint is also controlled via the selected ramp (P-17) when using terminal 81.
- 4) With the same setpoint voltage, the same speed is not set as in the speed closed-loop control mode.
- 5) The speed actual value must be positive for a positive speed setpoint (indicated via P-02 from software release 09 onwards). The motor phase sequence must be changed if this is not the case.
- 6) The parameter should only be changed in the controller inhibit mode, otherwise the setpoint input will be erroneous.

## 5 Maintenance

<b>WARNING</b>	
 	<p>This electrical equipment contains hazardous voltages.</p> <p>Death, severe bodily injury or material damage can occur if this equipment is not correctly handled.</p> <p>Please observe and follow the Servicing Instructions for the equipment specified in this section and on the product itself.</p> <p>Only appropriately qualified personnel should service the equipment.</p> <p>Before carrying out any work on the equipment it should be disconnected from the supply, locked-out against re-closure and grounded.</p> <p>Even after the equipment has been switched-off, a dangerous voltage is available for approx. 4 minutes as a result of the DC link capacitors.</p> <p>Even when the motor is stationary equipment components can still be live.</p>

### 5.1 Inspection and service

The converter is maintenance-free when the specifications and instructions given in Section 2.1 are observed.

If the equipment becomes dirty, it is recommended that it is cleaned with dry, oil-free compressed air to prevent flashover and restricted cooling.

#### 5.1.1 Maintenance of the E45 external heat dissipation option

- Operation and maintenance of the standard filter element.  
The intervals for cleaning the filter element are dependent on the degree of pollution, but however should not exceed 3 months. The element must be cleaned if dust deposits etc. restrict the cooling airflow, as otherwise the unit will be shutdown with fault F-15 (overtemperature).
- The filter element can be cleaned as follows:  
Rinse-out using water (up to approx. 40 °C = 104 °F, if necessary using a gentle detergent). The filter can also be cleaned by beating it, vacuuming or blowing out with compressed air. For greasy dust deposits the element can be cleaned in gasoline or in warm water with a grease dissolving solution. The element should not be wrung-out or exposed to powerful water jets!  
The element can be used a multiple number of times when carefully handled: depending on the cooling air quality, up to 10 x.

## 5.1.1 Maintenance of the E45 external heat dissipation option

## 5.1.2 Technical data of the fan motors, option E45

Technical data of the fan motors

Converter types	6SC6504	6SC6508/6SC6512/6SC6520
Supply voltage	2x380V	3x380V
Frequency	50/60Hz	50/60Hz
Power consumption	40W	300W
Current consumption	0.25A	0.49A
Speed	2760 RPM at 50 Hz	2500 RPM
Noise level	49 dB(A) at 50 Hz	78 dB(A)
Flow rates	350 m <sup>3</sup> h at 50 Hz 395 m <sup>3</sup> h at 60 Hz	410 m <sup>3</sup> h

**Attention:**

The fan motor and the converter must be put on voltage.

## 5.2 Software replacement and initialization

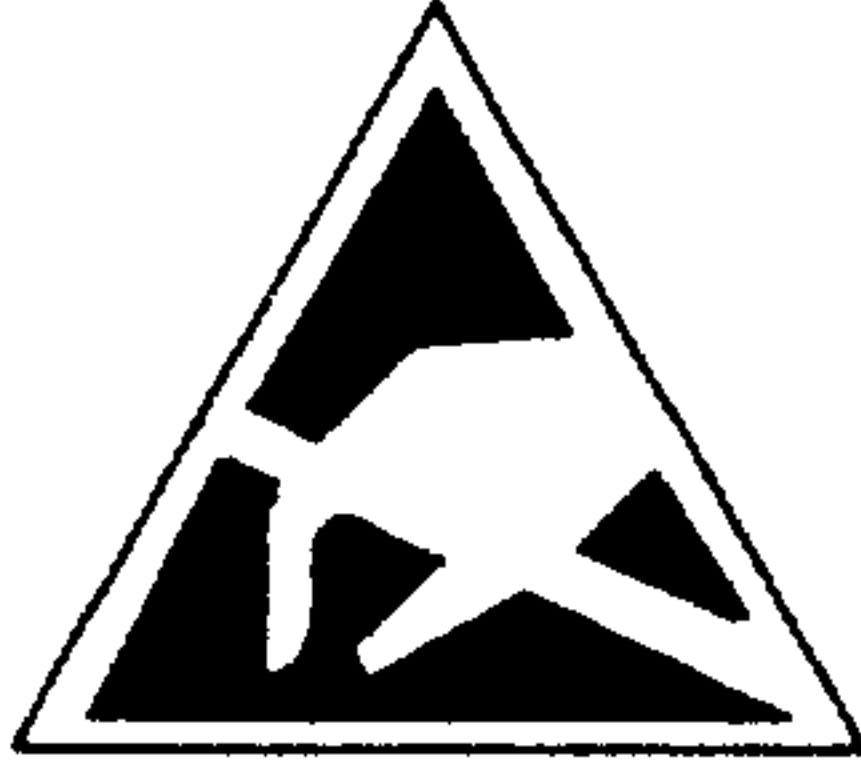
	<b>CAUTION</b>
	<p>The boards contain components which can be destroyed by electrostatic discharge. The human body must be electrically discharged before touching any electronic board. This can be simply done by touching a conductive grounded object immediately beforehand (e.g. bare metal cubicle components, socket outlet protective conductor contact).</p> <p>The ECB instructions should be observed (Section 6.9).</p>

The EPROM slot and the software release are coded in the number on the control board EPROMs.

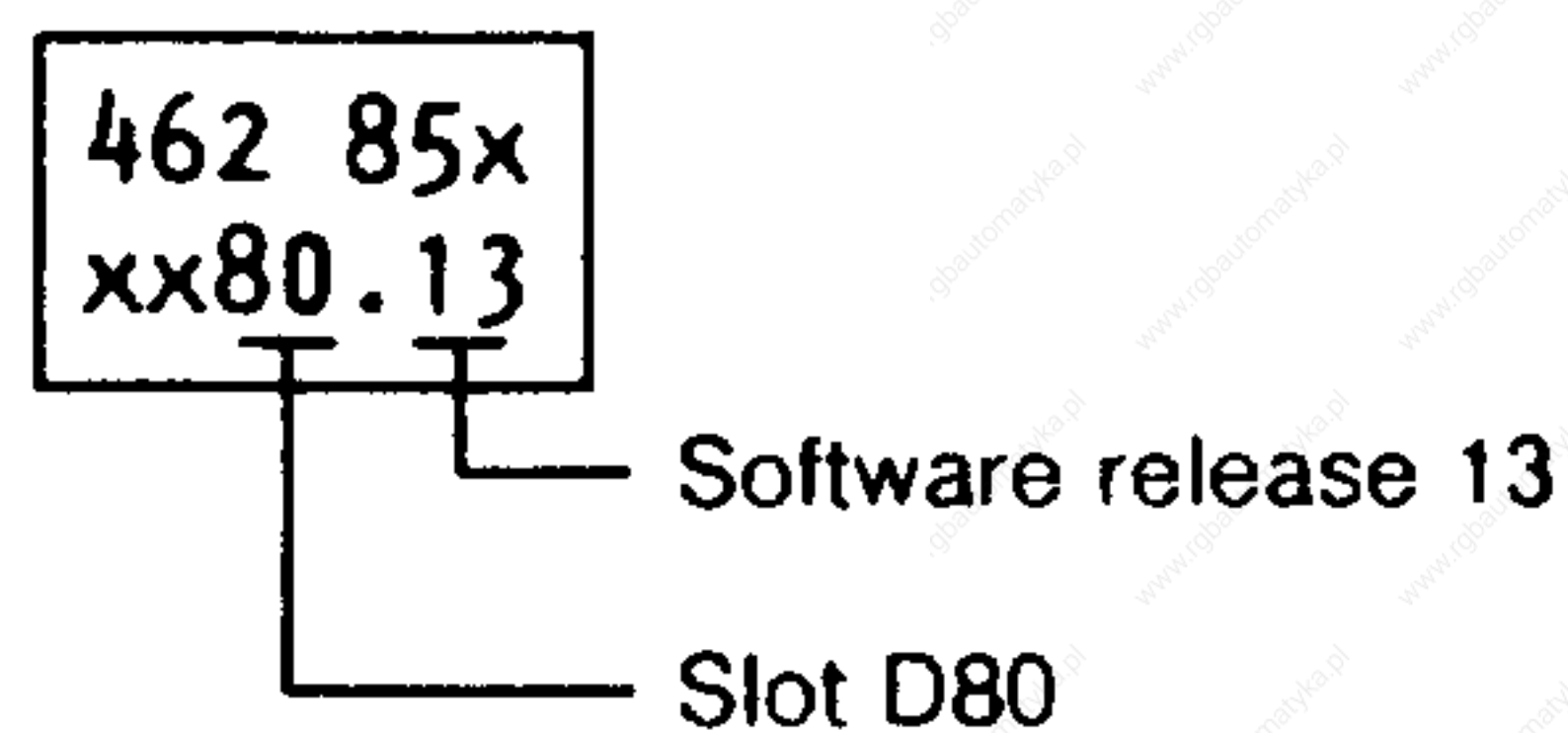

The following procedure must be adhered to when replacing older EPROMs with more recent software releases or at initialization:

1. Open the write protection jumper S1 on control board N1 (LED3 is lit when S1 is open).
2. Note all changed setting data (P-12 to P-98, P-220 to P-243, P-249, P-254), and when using the C axis or positioning (board S1), also P-105 to P-150, P-157, P-158 and P-195.
- 3.\*) Set parameters
  - P-51 to 0 0 0 4 H
  - P-97 to 0 0 0 0 H and
  - P-52 to 0 0 0 1 H.
- 4.\*) Switch-off the unit after 0 0 0 0 H has automatically been written into P-52.
5. Replace the EPROM (2 for the gating unit and control processor) (only when replacing the software).
6. Switch-on the unit after inserting the control board. P-95 must be displayed.
7. Carry out initialization with pulse and controller inhibit
  - P-95 Load converter code number
  - P-96 Load motor code number;  
if special encoders are used with an encoder pulse number  $\neq$  1024 increments per revolution, then also set
  - P-98 and
  - P-97 to 0 0 0 1 H (converter then responds with the operating display)
8. Set P-51 to 0 0 0 4 H. Re-enter the value noted under point 2 and store P-52 with 0 0 0 1 H.
9. Re-insert write protection jumper S1. The converter is now ready for operation.

\*) Not required for software replacement from software release 10 onwards (closed-loop control software)

### 5.3 Spare parts

These spare parts can be ordered from Siemens Erlangen ANL A434 ED  
(Telex: 62921-273 si d)  
(Fax: 09131-720002)  
(Tel: 09131-732429)

Designation	for PWM inverter	Mounting location	Order No.
Transistor module 2DI50Z-100 (FUJ.) 2DI75ZA-100 (FUJ.) 2DI100Z-100 (FUJ.) 2DI150Z-100 (FUJ.) 1DI200Z-100 (FUJ.) 1DI300G-100 (FUJ.)	6SC6502-4AA02 6SC6503-4AA02 6SC6504-4AA02 6SC6506-4AA02 6SC6508-4AA02 6SC6512/20-4AA02	LT LT LT LT LT LT	6SY9076 6SY9052 6SY9077 6SY9078 6SY9080 6SY9040
Chopper module 1DI75F-100 1DI75E-100 1DI150GF-100 1DI150GE-100	6SC6502/03-4AA02 6SC6502/03-4AA02 6SC6504/06/08-4AA02 6SC6504/06/08-4AA02	LT LT LT LT	6SY9054 6SY9055 6SY9033 6SY9034
Thyristor module 2 x 25 A/1600 V 2 x 25 A/1600 V 2 x 40 A/1600 V 2 x 65 A/1600 V MTT 95 A 16 N MTT 120 A 16 N SKKT 131/16D	6SC6502/03/04/06-4AA02 6SC6502-4AA02 Version A 6SC6504-4AA02 Version A 6SC6506/08-4AA02 Version A 6SC6512-4AA02 6SC6512-4AA02 Version A 6SC6520-4AA02	LT LT LT LT LT LT LT	6QX5095 6QX5095 C67067-A2803-A206 C67067-A2800-A208 C67067-A2836-A206 6SY9466 6QX5328
Diode module SKKD 160 A, 1000 V MDD72 A 15 F SKKE 340F12	6SC6508/12-4AA02 6SC6504/06-4AA02 6SC6520-4AA02	LT LT LT	6ZY1005-0AA00 6ZY1006-0AA00 6SY9443
Transducer ZKB464/202-250A ZKB 464/010-H2	6SC6502/03/04/06/08/12-4AA02 6SC6520-4AA02	LT LT	6ZY1023-1AA00 6ZY1022-0AA00
Compact inverter module	6SC6502-4AA02 6SC6503-4AA02	A1 A1	6SC6502-0AF01 6SC6503-0AF02
Transistor gating board	6SC6502/03-4AA02 6SC6504-4AA02 6SC6506-4AA02 6SC6508-4AA02 6SC6512-4AA02 6SC6520-4AA02	A0 A1 A1 A1 A1 A1	6SC6503-0AD03 6SC6504-0AA02 6SC6506-0AA02 6SC6508-0AA02 6SC6512-0AA02 6SC6520-0AA02
Control board *) with software	6SC6502/03/04/06/08/12/20-4AA02	N1	6SC6500-0NA44
Display board	6SC6502/03/04/06/08/12/20-4AA02	H1	6SC6500-0UB02
Input/output board	6SC6502/03/04/06/08/12/20-4AA02	U1	6SC6500-0UC01
Power supply G01	6SC6502/03-4AA02 6SC6504/06/08/12/20-4AA02	G01 G01	6SC6100-0GC11 6SC6100-0GC10
Central board G02	6SC6502/03/04/06/08/12/20-4AA02	G02	6SC6100-0GE01
Thermo switch		LT	6ZY1021-0AA00
Fan QLK45/0018 W2S130-AA19-01/380 V W2S107-AA15-16/115 V G2D180-BD02-07/380 V D2D133-BE02-07/380 V	6SC6502/03/20-4AA02 6SC6504/06-4AA02/Opt. E45 6SC6504/06/08/12-4AA02 6SC6512-4AA02/Opt. E45 6SC6508-4AA02	E1/A1 E1/Opt. E45 E2,E3 E1/Opt. E45 E1	6SY9036 6ZY1018-0AA00 6ZY1055-0AA00 6ZY1056-0AA00 6SY9038

\*) Effective immediately, the 6SC6500-0NA04 control board will only be supplied with complete software; thus, the machine readable order designation changes (Order No.) to 6SC6500-0NA43 (with software release 13).

Designation	for PWM inverter	Mounting location	Order No.
6000 µF / 350 V capacitor	6SC65..	ZK	6ZY1073-0AA00
0.1 µF / 500 V capacitor	6SC65..	U1, V1, W1	B25839-A6104-M
0.022 µF / 250 V (Y) capacitor	6SC6502/03/04/06/08/12/20-4AA02	LT	B81121-C-B147
Fuse			
30 A 700 V	6SC6502/03-4AA02	ZK	6ZY1011-0AA00
30 A 700 V	6SC6502-4AA02 Version A	ZK	6ZY1011-0AA00
40 A 660 V	6SC6504-4AA02	ZK	6ZY1012-0AA00
45 A 660 V	6SC6502/03/04/08-4AA02	U1, V1, W1	6ZY1008-0AA00
45 A 660 V	6SC6502-4AA02 Version A	U1, V1, W1	6ZY1008-0AA00
63 A 660 V	6SC6504/08-4AA02 Version A	U1, V1, W1	6SY9465
63 A 660 V	6SC6504-4AA02 Version A	ZK	6ZY1013-0AA00
63 A 660 V	6SC6506-4AA02	ZK	6ZY1013-0AA00
80 A 660 V	6SC6506-4AA02	U1, V1, W1	6ZY1010-0AA00
80 A 660 V	6SC6506-4AA02 Version A	U1, V1, W1	6ZY1010-0AA00
100 A 660 V	6SC6506-4AA02 Version A	ZK	6ZY1014-0AA00
100 A 660 V	6SC6508-4AA02	ZK	6ZY1014-0AA00
125 A 660 V	6SC6508-4AA02 Version A	ZK	6SY9130
160 A 660 V	6SC6512-4AA02	U/V/W1 + ZK	6ZY1023-0AA00
160 A 660 V	6SC6512-4AA02 Version A	U1, V1, W1	6ZY1023-0AA00
250 A 660 V	6SC6512-4AA02 Version A	ZK	6ZY1013-1AA00
315 A 660 V	6SC6520-4AA02	U/V/W1 + ZK	6ZY1003-1AA00
Option			
A73 (Feed control for C axis)	6SC6502/03/04/06/08/12/20-4AA02	S1	6SC6500-0BB01
A74 (Spindle positioning)	6SC6502/03/04/06/08/12/20-4AA02	S1	6SC6500-0BC01
A75 (Feed control for C axis and spindle positioning)	6SC6502/03/04/06/08/12/20-4AA02	S1	6SC6500-0BA01
Connecting accessories for			
A73 (6SC6500-0BB01)	6SC6502/03/04/06/08/12/20-4AA02	S1	6SC6101-0SA22
A74 (6SC6500-0BC01)	6SC6502/03/04/06/08/12/20-4AA02	S1	6SC6101-0SA21
A75 (6SC6500-0BA01)	6SC6502/03/04/06/08/12/20-4AA02	S1	6SC6101-0SA21
(6SC6500-0BA00)		S1	6SC6101-0SA18
Transformer 3x380/115 V, 75 VA		LT	6ZY1016-0AA00
Fuse element G19408F 0.8 A/500 V	6SC6502/03-4AA02	ER	6ZY1015-0AA00
Weidmuller connector set (supplied loose)	6SC65..		6SC6500-1AA01
15-pin connector	6SC6502/03/04/06/08/12/20-4AA02	U1-X111	6SY9063
13-pin connector	6SC6502/03/04/06/08/12/20-4AA02	U1-X121	6SY9062
15-pin connector	6SC6502/03/04/06/08/12/20-4AA02	U1-X131	6ZY1075-0AA00
with access.: Connector cable entry		U1-X131	6ZY1076-0AA00
Connector mounting plate		U1-X131	6SY9070
Connector holding bracket		U1-X131	6SY9071
7-pin connector	6SC6502/03/04/06/08/12/20-4AA02	S1-X111	6SY9060
9-pin connector	6SC6502/03/04/06/08/12/20-4AA02	S1-X112	6SY9061
25-pin connector	6SC6502/03/04/06/08/12/20-4AA02	S1-X113	V42254-A1115-
with access.: Connector cable entry		S1-X113	B225
Connector mounting plate		S1-X113	6SY9072
Connector holding bracket		S1-X113	6SY9070
15-pin connector	6SC6502/03/04/06/08/12/20-4AA02	S1-X114	6SY9071
with access.: Connector cable entry		S1-X114	V42254-A111-A315
Connector mounting plate		S1-X114	6ZY1076-0AA00
Connector holding bracket		S1-X114	6SY9070
9-pin connector	6SC6502/03/04/06/08/12/20-4AA02	G02-X141	6SY9071
10-pin connector	6SC6502/03/04/06/08/12/20-4AA02	G02-X131	6SC6101-0XC14 6SC6101-0XC13



Designation		for PWM inverter	Mounting location	Order No.
Filter element		6SC6504/06/08/12/20-4AA02	Opt. E45	8MR1191-0AD *)
Control software	D80/D82	6SC6502/03/04/06/08/12/20-4AA02	N1	6SC6580-0AB14
Gating unit software	D76/D78	6SC6502/03/04/06/08/12/20-4AA02	N1	6SC6581-0AB05
Control software **)	D80/D82	6SC6502/03/04/06/08/12/20-4AA02	N1	6SC6580-0AB04
Gating unit software **)	D76/D78	6SC6502/03/04/06/08/12/20-4AA02	N1	6SC6581-0AB03
Supply gating unit software	D73	6SC6502/03/04/06/08/12/20-4AA02	N1 (.02)	6SC6582-0AB02
Supply gating unit software	D73	6SC6502/03/04/06/08/12/20-4AA02	N1 (.04)	6SC6582-0AB03
Software (control + gating unit)		6SC6502/03/04/06/08/12/20-4AA02	N1	6SC6580-1BC01
EEPROM	D74 (X2804)	6SC6502/03/04/06/08/12/20-4AA02	N1	6SC6584-0AB00

\*) Should be ordered from Pfaffenburg, Papenstr. 29-33, 2000 Hamburg 76

\*\*) Closed-loop control 04 and gating unit 03 software releases must be used when using the C-axis option with squarewave encoder (90000 increments per revolution)

Confidential - Not for Distribution  
 Verwendungsbeschränkung: Dieses Dokument ist ausschließlich für den internen Gebrauch der Siemens AG bestimmt. Die Weitergabe an Dritte ist ohne schriftliche Genehmigung der Siemens AG untersagt. Alle Rechte vorbehalten. Siemens AG, München, 1988.

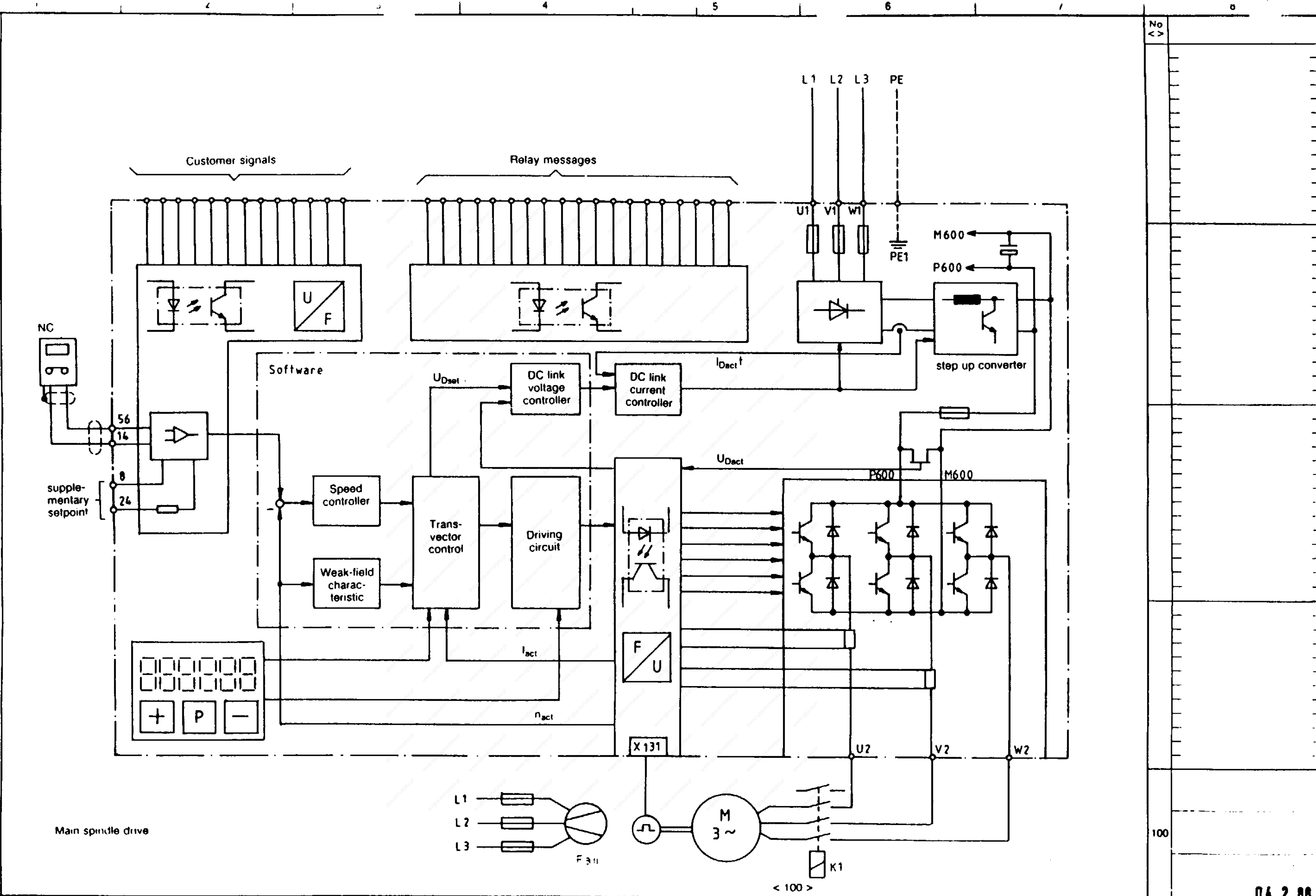

Date: 12.88		Siemens AG		Block diagram 6SC65		AUT E241		3GE.462.500.9600.00 SU a		Blatt 1	
Drawn: Franke Sc		Bereich Energietechnik		Circuit diagram		100		04.2.88		1 R	
Checked: 3.2.88		Continuum Erlangen									

### 6.2 Connecting diagram

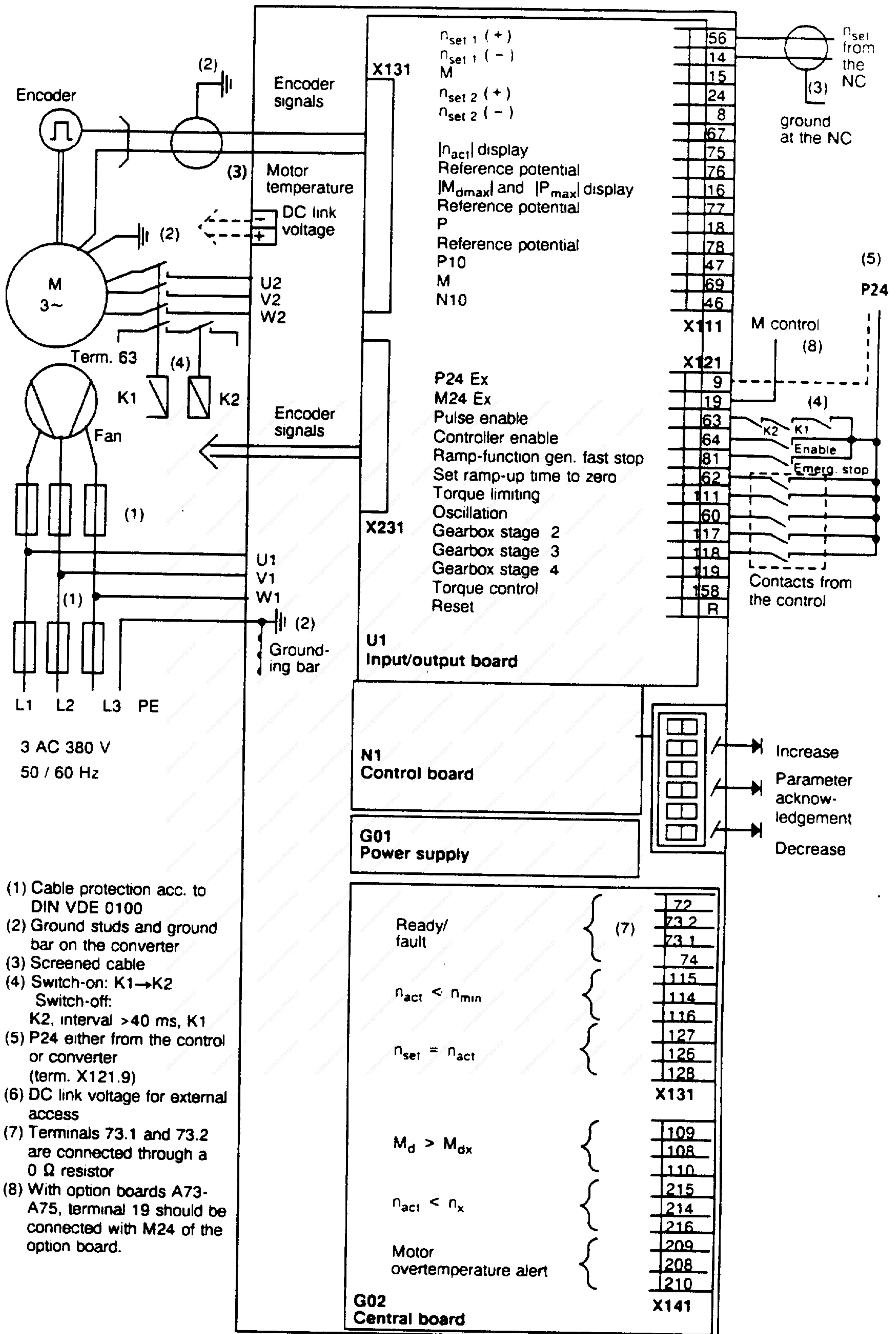

U3 Backplane wiring 462 500.9096.00

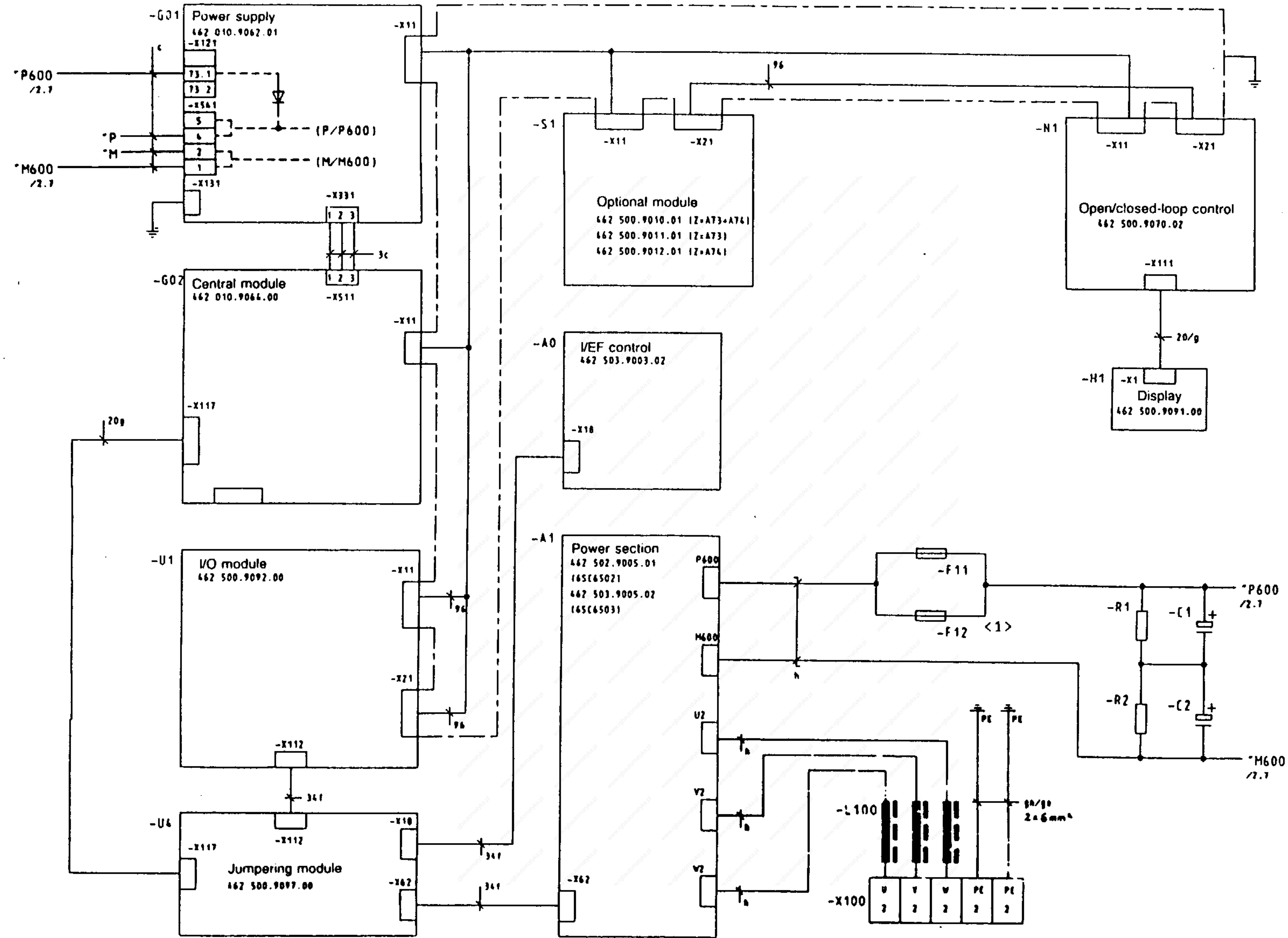

No.	<>
1	From version A - F12 not mounted by 20 A-devices (-F11 only)
a	SK 0.5
b	NGAF 0.75
c	NGAF 1.5 Twisted pairs
e	Ribbon cable LIY 0.5
f	FL1-Y-34x1x0,09
g	FL1-Y-20x1x0,09
h	NGAF6
i	0.5 mm <sup>2</sup> Short-circuit-proof
j	NGAF 0.5
100	
	29.06.89

Weitergabe sowie Herstellung dieser Unterlagen, Ver-  
 wertung und Mitteilung ihrer Inhalte nicht gestattet, soweit  
 nicht ausdrücklich angegeben. Zur Deckung der Ver-  
 pflichtung an Siemens AG, alle Rechte vorbehalten, insbe-  
 sondere für den Fall der Patentierung oder Verleghung.

MULTA-Anlagen-Nr.: 1230 462502940002  
 Standard-Nr.:

Datum: 03.11.87		Siemens AG		SIMODRIVE		AUT E 2141	
1	188962	15.01.90 DM	Bearb. FRANK/SC	Bereich Energietechnik		3GE.462 502.9400.02 SP 1	
2	188970	17.03.90 DS	Gepr. STEINIGER	Gerätewerk Erlangen		Blatt 1	
Zust.	Änderung	Datum	Name	Urspr./Ers. 1/Ers. 0	20A/30A		7 Bl.

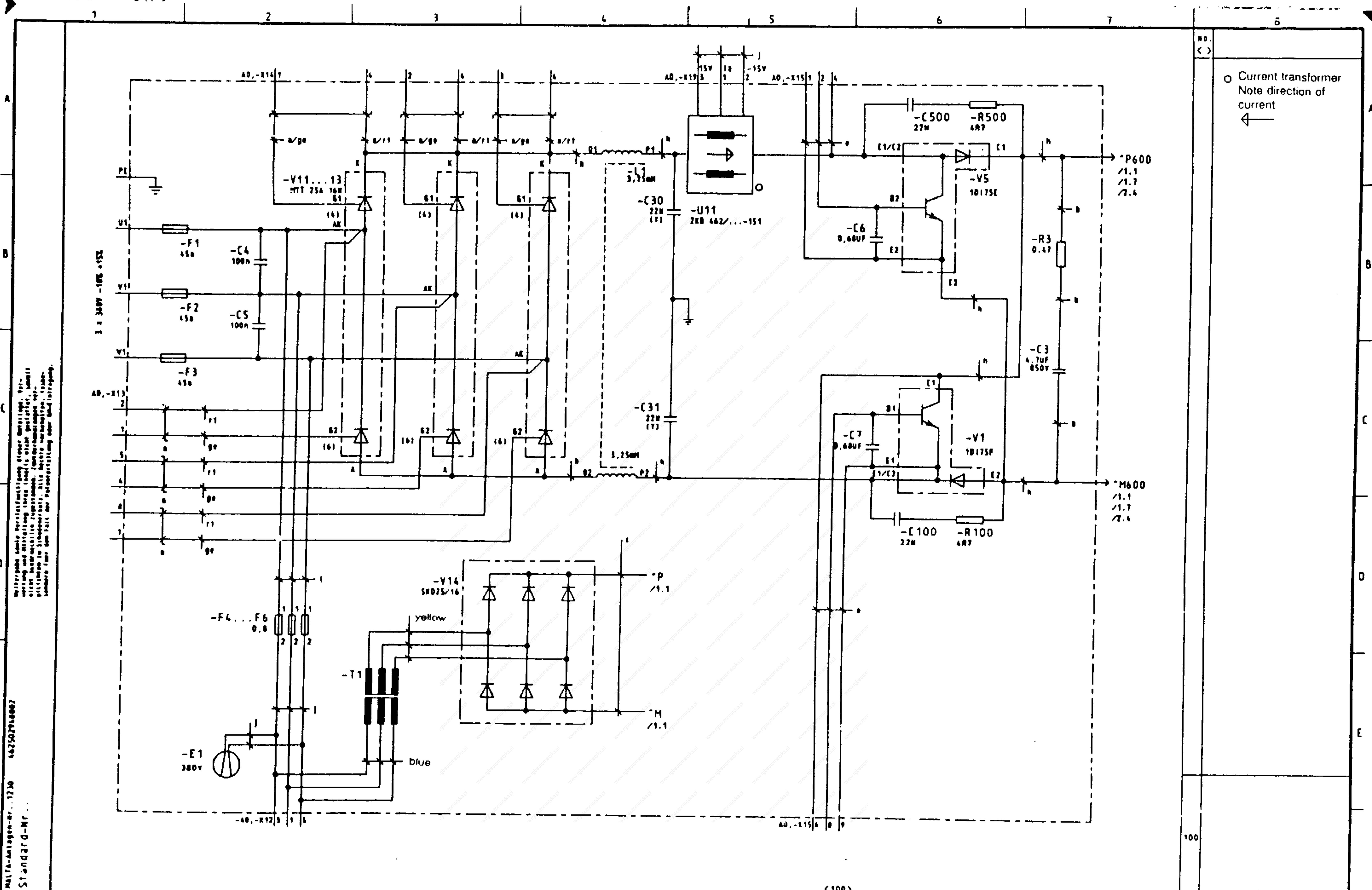

Weitergabe sowie Herstellung dieser Bauteile, Vervielfältigung und Montage sind nur für den bestimmungsgemäßen Gebrauch zulässig. Jegliche Nachverarbeitungen sind ohne schriftliche Genehmigung der Siemens AG Erlangen-Nürnberg, alle Rechte vorbehalten. Insbesondere ist der Nachbau der Bauteile durch Dritte untersagt.

MALTA-Anlagen-Nr. 1230 46250296002  
 Standard-Nr.

No. <>  
 ○ Current transformer  
 Note direction of current  
 ←

N	100942	15.01.90 DM	Datum	03.11.87	Siemens AG Bereich AUF Gerätewerk Erlangen	SIMODRIVE AC main spindle drive 20A/30A	AUT E 2:41	3GE 462 502.9400 02 SP h	Blatt 2
B	100470	12.03.90 DS	Bearb.	FRANKE/SE					
I	100451	09.02.90 DS	Gepr.	STEINIGWEG					
Zust	Änderung	Datum	Name	Norm	12.12.87 01	Urspr./Ers. 1/Ers. 0			

Mit dieser Schaltung ist die Ausführung dieser Vorrichtung, die  
 Herstellung dieser Vorrichtung nicht gestattet, somit  
 nicht weiterverbreitet, kopiert, verändert, weiterver-  
 breitet zu erlauben. Alle Rechte vorbehalten. In-  
 schließend für den Fall der Patenterteilung vorbehalten.

Matr.-Anlagen-Nr.: 1331 482506940002  
 Standard-Nr.:

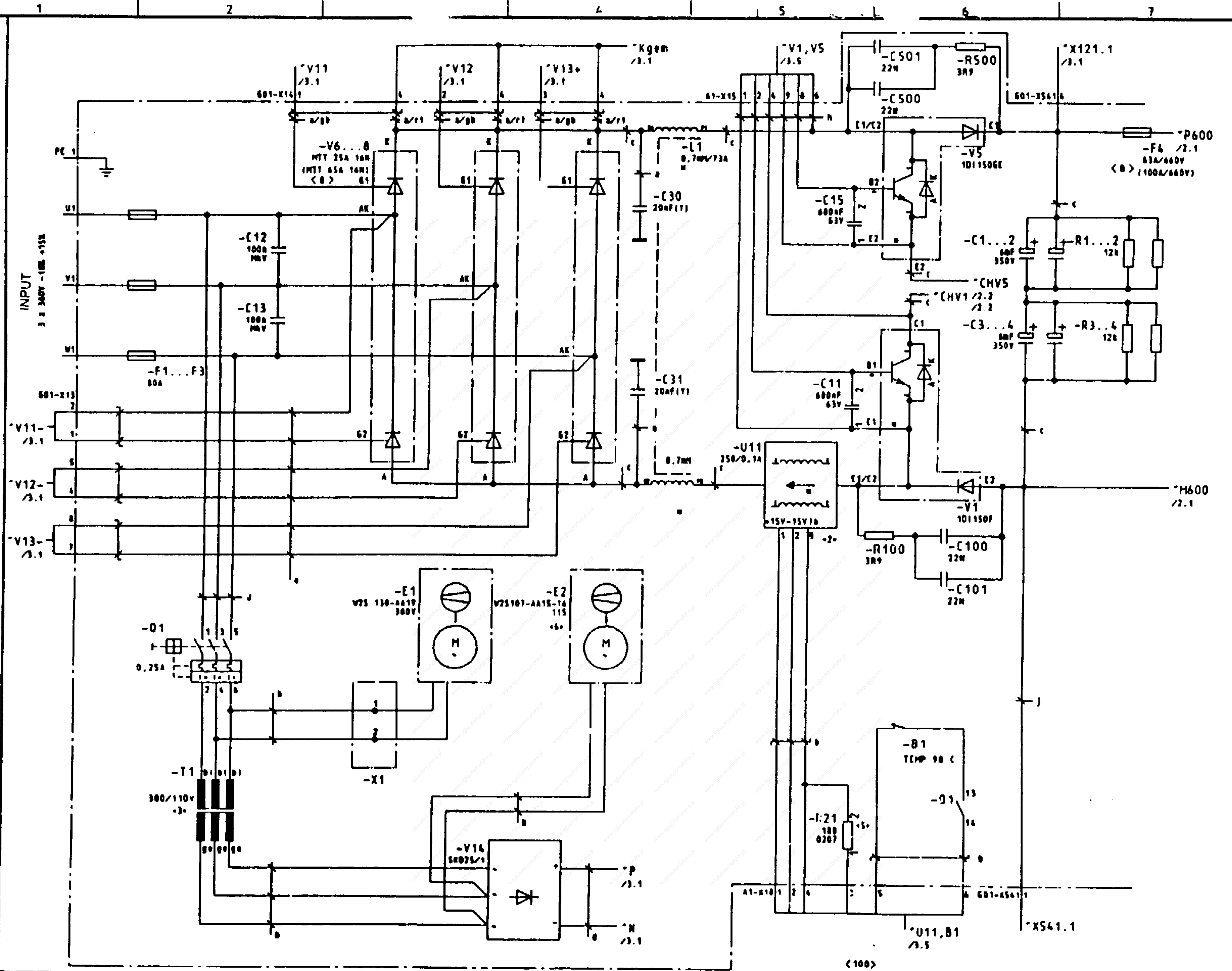

- No. < >
- 2 Current transformer  
Note direction of current  
← and single primary turn
  - 3 Shielded cables gn/ye  
cut + insulate
  - 5 Resistor mounted  
on connector
  - 6 Air flow direction: past  
struts to room atmosphere
  - 7 In basic accessory set  
482 000.7516.01 SL
  - 8 From version A:  
- F4 = 100 A  
- V6...8 = (64 A/16N)
- a sk 0,5 ?  
Short-circuit-proof
- b 0,5 ?
- c 2x MAGAF4
- d L17yB 0,5 ?  
Short-circuit-proof
- e L17CY 2 + 0,75x4,2
- f FLI-Y-34 + 1x 0,09
- g FLI-Y-20 + 1 + 0,09
- h 6x0,5
- j MAGAF1,5
- k MAGAF6

Date: 08.12.87		Drawn: ZANDRAN/SC		Siemens AG		SIMODRIVE	
No: 108902		Date: 15.01.88		Bereich AUT		AC main spindle drive	
Zust: Änderung		Date: 23.02.88 01		Gerätevers. Erlangen		Power section 60 A	
1		2		3		4	
AUT E 2141		3GE.462 506.9400 02 SP g		191		191	

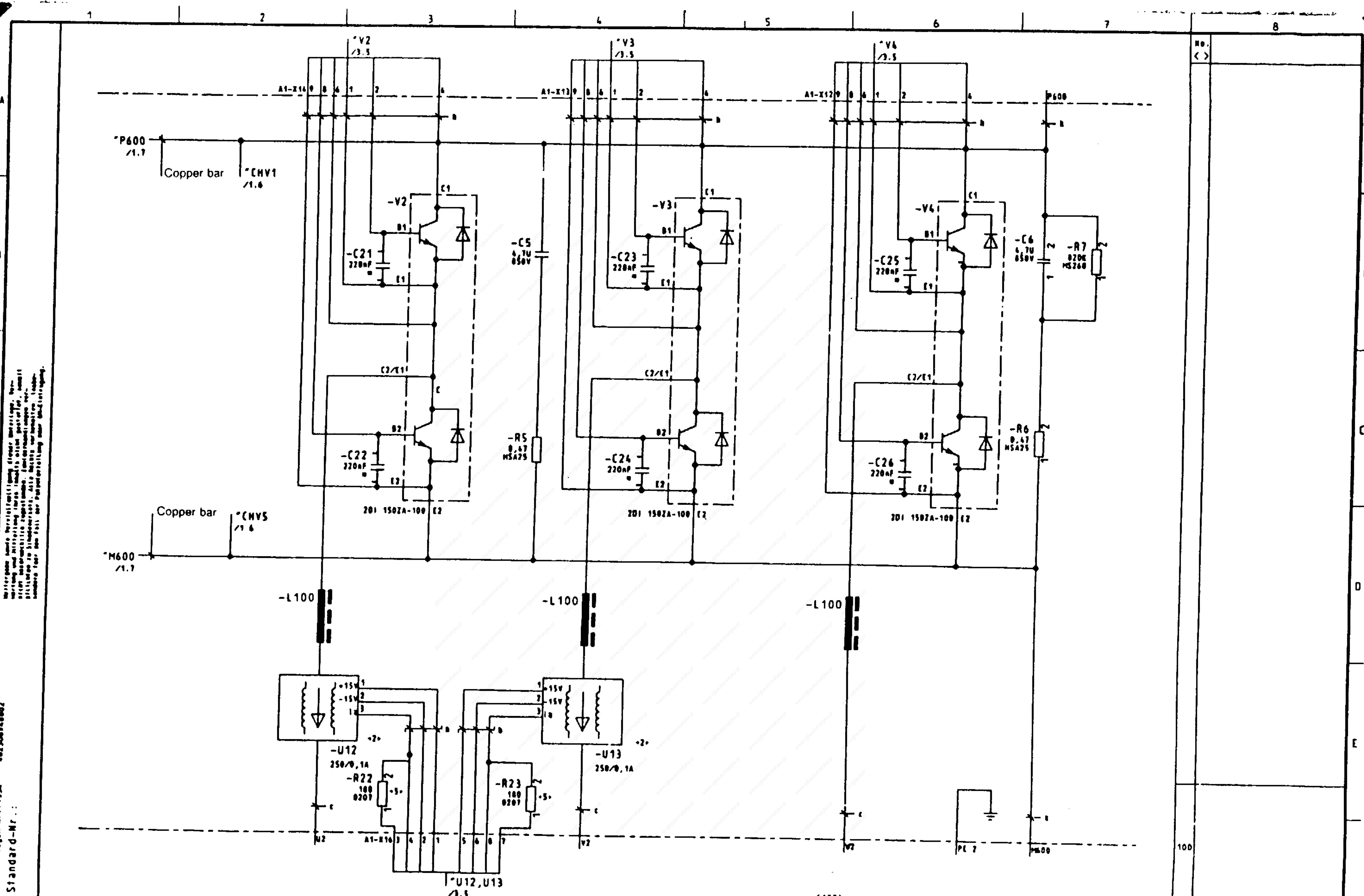

Mitgeben beim Verfertigen dieser Montage, bei  
 Montage und Montage nach dem Posten für, damit  
 die Montage in die richtige Richtung erfolgt.  
 Sonstige für den Fall der Reparatur der Montage.

MLT-Anlagen-Nr.: 13M 442506740002  
 Standard-Nr.:

			Datum	08.12.07					
0	111619	07.07.99	DM	Bearb.	ZAMORAN/SC				
0	108962	15.01.99	DM	Gepr.	STEINIGEWEG				
Zust	konform	Datum	Norm	Norm	22.02.00 01	Urspr./Ers. 1./Ers. d.			

**Siemens AG**  
 Bereich Energietechnik  
 Gerätewerk Erlangen

SIMODRIVE  
 AC main spindle drive  
 Power section 60 A

AUT E2422 3GE.462 506.9400.02 SP e Blatt 2

Weitergabe sowie Vervielfältigung dieser Unterlagen, Ver-  
 wertung und Mitteilung ihres Inhalts ist nicht gestattet, soweit  
 nicht ausdrücklich gestattet. Zuwiderhandlungen ver-  
 pflichten zu Schadensersatz. Alle Rechte vorbehalten. Inbe-  
 sondere zum Fall der Patentverletzung oder Verletzung.

MALTA-Anlagen-Nr. 333 46250694002  
 SY 3759 2-1

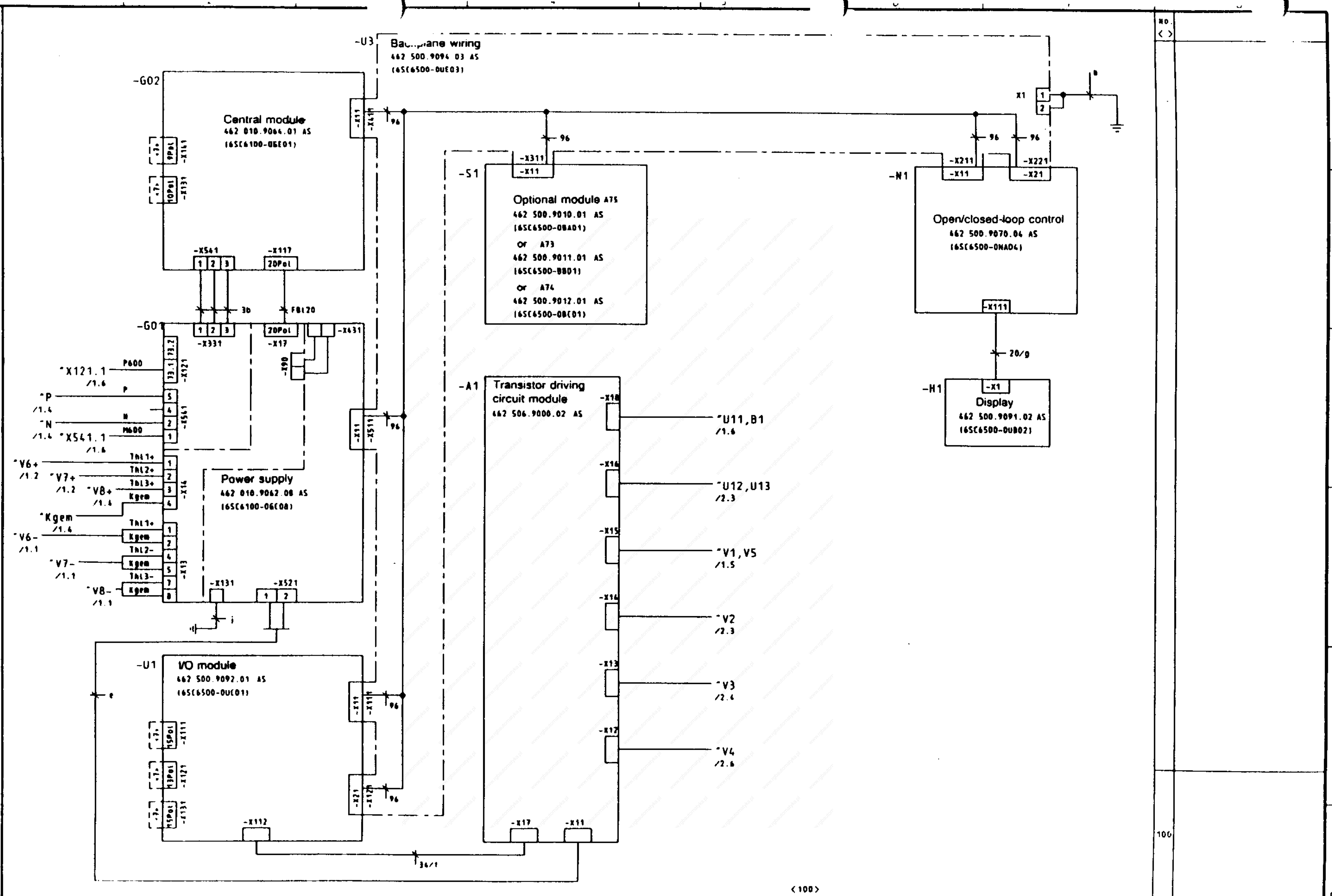

1	2	3	4	5	6	7	8
112466	02.09.87	09	Beard	ZAMORAK/SC	Siemens AG	SIMODRIVE	
112466	09.02.90	05	Gepr.	STEINIGEWIG	Bereich AUT	AC main spindle drive	
112466				STEINIGEWIG	Gerätewerk Erlangen	60 A	
			Urspr	Ers 1	Ers 2		
						AUT E2422	3GE 462 506 9400 52 SP e
							Blatt 3
							81



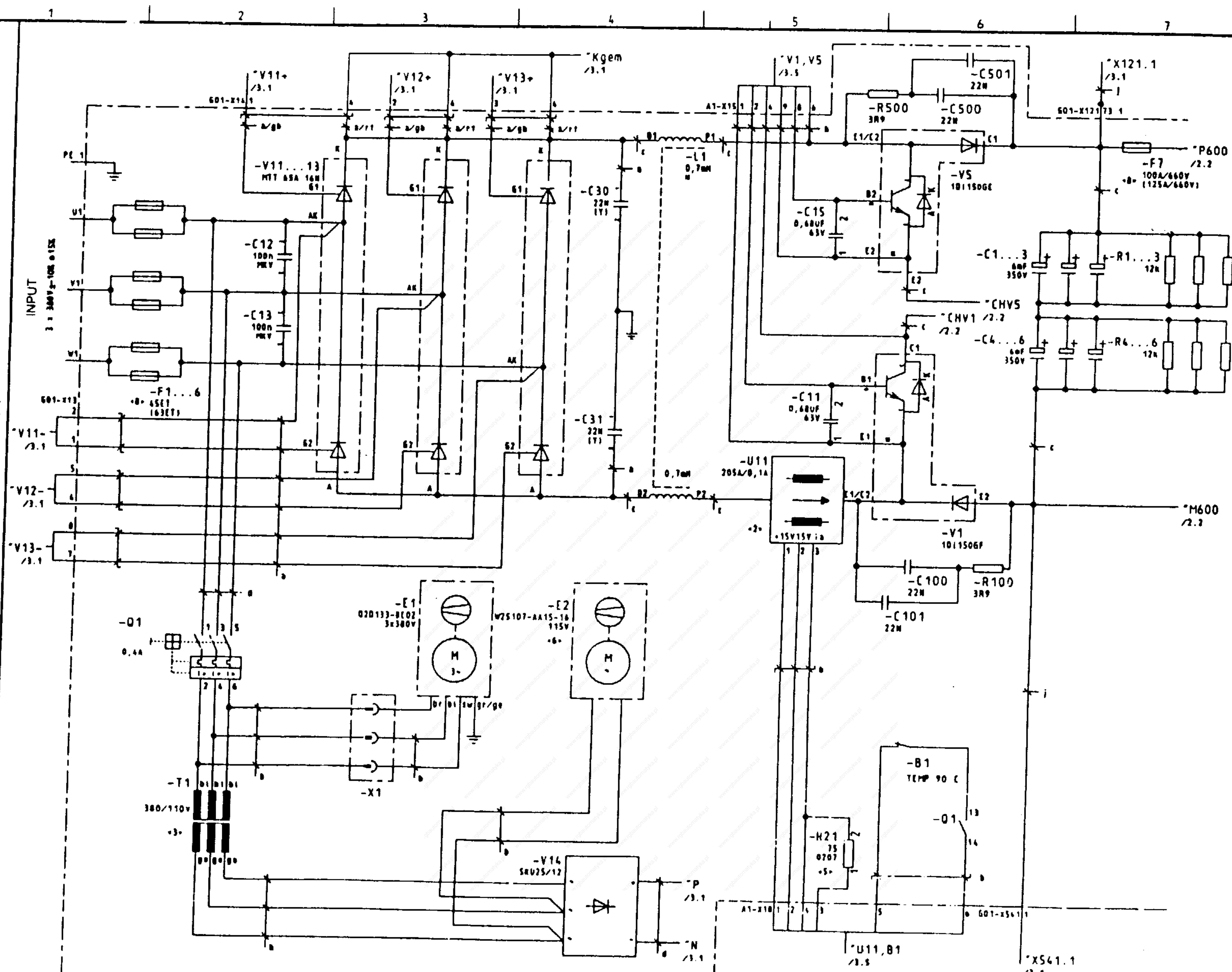

Weitergabe sowie Vervielfältigung dieses Dokuments, Ver-  
 breitung und Mitteilung (auch auszugsweise) sind ohne schriftliche  
 Erlaubnis der Siemens AG ausdrücklich untersagt. Insbesondere ist  
 die Weitergabe oder Vervielfältigung dieses Dokuments für den Fall der  
 Weitergabe oder Vervielfältigung durch Dritte untersagt.

Melldaten-Nr. 1476 44250890002  
 Standard-Nr.

- |         |   |
|---------|---|
| No.     | <>  |
| 2       | Current transformer<br>Note direction of current<br>← and single primary turn |
| 3       | Shielded cables gr/ye<br>cut + insulate                                       |
| 5       | Resistor mounted<br>on connector  |
| 6       | Air flow direction: past<br>struts to room atmosphere                         |
| 7       | In basic accessory set<br>462 000.7516.01 SL                                  |
| 8       | From version A:<br>- F7 = 125 A/660 V<br>- F1...6 = 63 A/660 V                |
| a       | 18 x 0,5<br>Short-circuit-proof   |
| b       | 0,75 <sup>2</sup>   |
| c       | NAGAF16   |
| d       | 117x8 0,5 <sup>2</sup><br>Short-circuit-proof                                 |
| e       | 117x7 2 x 0,75x4,2  |
| f       | Fli-Y-34 x 1 x 0,09   |
| g       | Fli-Y-20 x 1 x 0,09   |
| h       | 6 x 0,5   |
| j       | NAGAF1,5  |
| k       | NAGAF10   |
| 22 2 91 |   |

Müller-Bloger-Nr. 1476 44250890002		Standard-Nr.		Datum 27.01.88		Siemens AG		SIMODRIVE		AUT E 2141		3GE.462.508.9400.02 SP n	
Nr.	104461	20.07.87	DM	Beard.	ZANDRAK/SC	Bereich AUT		AC main spindle drive		AUT E 2141		3GE.462.508.9400.02 SP n	
Nr.	138462	15.01.87	DM	Gepr.	STEINIGWEG	Gerätewerk Erlangen		Power section 80 A		AUT E 2141		3GE.462.508.9400.02 SP n	
Zust.	sendung	Datum	Name	Norm	22.02.88 01	Urspr. Ers. 1/Ers. 6				AUT E 2141		3GE.462.508.9400.02 SP n	

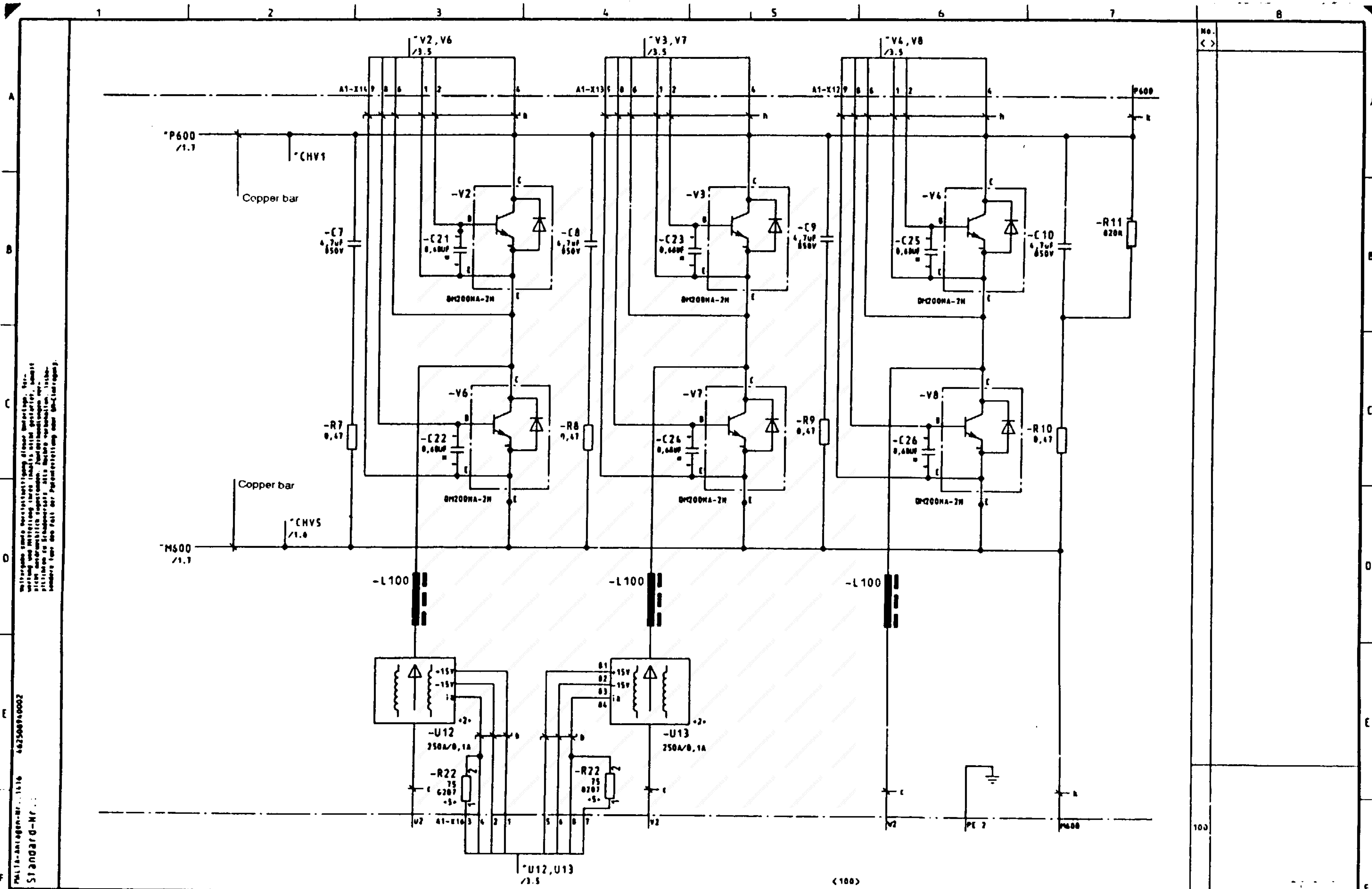

Mit dieser und der Montageanleitung, dem Schaltplan, den  
 Zeichnungen und den technischen Zeichnungen sind alle  
 notwendigen Informationen für die Montage und den  
 Betrieb des Antriebs zur Verfügung gestellt. Insbesondere  
 sind die Sicherheitsvorschriften zu beachten.

M11A-Anlagen-Nr.: 1516 462508940002  
 STANDARD-Nr.:

Datum		27.01.88		Siemens AG		SIMODRIVE		AC main spindle drive		AUT E 2141		3GE.462.508.9400.02.SP.d		Blatt 2	
Bezeichnet		ZAMORAK/SC		Bereich		Energietechnik		Power section 80 A							
Gezeichnet		STEINIGEWIG		Urspr./Ers./Erg.											
Geprüft		22.02.88 81													

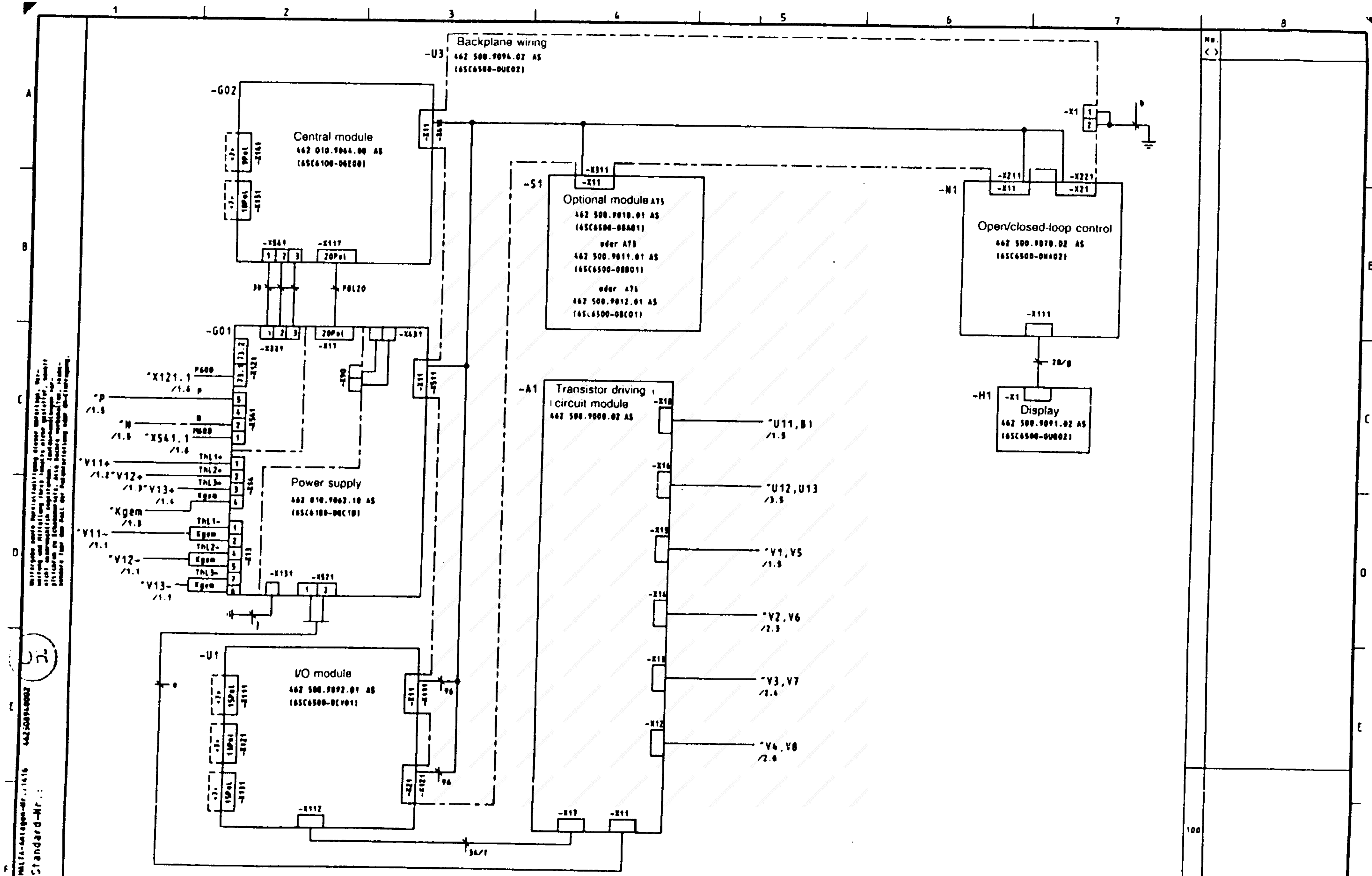

Die Bauteile sind, soweit nicht anders angegeben, in der Ausführung der letzten Revision zu beschreiben. Alle Bauteile sind in der Ausführung der letzten Revision zu beschreiben.

MALTA-Anlagen-Nr.: 1416  
 Standard-Nr.: 4625094002

Datum: 22.01.88		Gepr. v. ZAMRAK/SC		Siemens AG		SIMODRIVE		AUT		3GE.462.508.9400.02 SP d		Blatt 3-	
Gepr. v. STEINIGER		Gepr. v. STEINIGER		Bereich AUT		AC main spindle drive		Beraufwerk Erlangen		AUT E241		Blatt 3-	
Gepr. v. STEINIGER		Gepr. v. STEINIGER		Beraufwerk Erlangen		Power section 80 A		Beraufwerk Erlangen		AUT E241		Blatt 3-	
Gepr. v. STEINIGER		Gepr. v. STEINIGER		Beraufwerk Erlangen		Power section 80 A		Beraufwerk Erlangen		AUT E241		Blatt 3-	

22.02.90

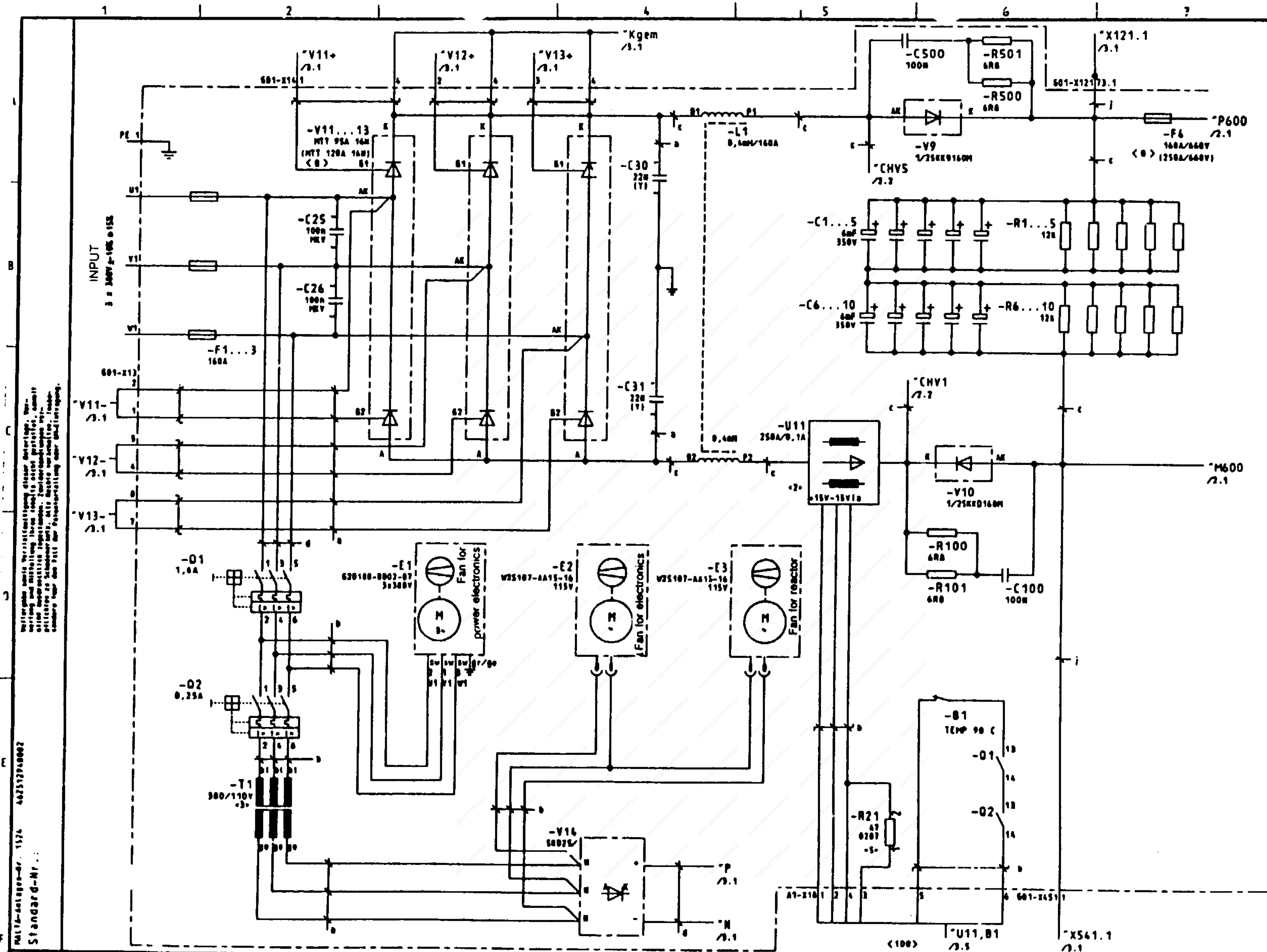

Wichtige Maße, Veranschauligung der Bauelemente, Verdrahtung und Montagehinweise sind in den Zeichnungen und in den zugehörigen Unterlagen zu entnehmen. Die Bauelemente sind in der Liste der Ersatzteile angegeben.

ML1A-401ger-Mr. 1574 4625729.0002  
 Standard-Mr.

- |   |   |
|---|---|
| 1 | Do no interchange   |
| 2 | Current transformer<br>Note direction of current<br>← and single primary turn |
| 3 | Shielded cables gr/ye<br>cut + insulate                                       |
| 4 | Resistor mounted<br>on connector  |
| 5 | Air flow direction: past<br>struts to room atmosphere                         |
| 7 | In basic accessory set<br>462 000.7516.01 st                                  |
| 8 | From version A<br>- F4 = 250 A/660 V<br>- V11...13 = 120 A/1800 V             |
| a | 1 x 0,5<br>Short-circuit-proof  |
| b | 0,75 <sup>2</sup>   |
| c | MAGAF35 oder 2x16   |
| d | 1 L1YB 0,5 <sup>2</sup><br>Short-circuit-proof                                |
| e | 1 L1YCY 2 x 0,75=4,2  |
| f | 1 F11-Y-3L x 1 x 0,09   |
| g | 1 F11-Y-20 x 1 x 0,09   |
| h | h 6 x 0,5   |
| i | 1 L1YCY 1x0,75<br>Shielded cable  |
| j | MAGAF 1,5   |
| k | MAGAF16   |

Datum 22.07.00 Beauf. ZANDORF/SC 1 111610 02.07.9900 Supp. STEINIGER Zust. Änderung Datum Name Norm 02.03.00 B1 Urspr. / Ers. 1. / Ers. 0.		<b>Siemens AG</b> Bereich AUT Gerätewerk Erlangen		SIMODRIVE AC main spindle drive Power section 120 A		AUT E2422 3GE.462.512.9400.02 SP N		14.7.01 1+ 3 Bl.	
---	--	---	--	---	--	------------------------------------	--	------------------------	--

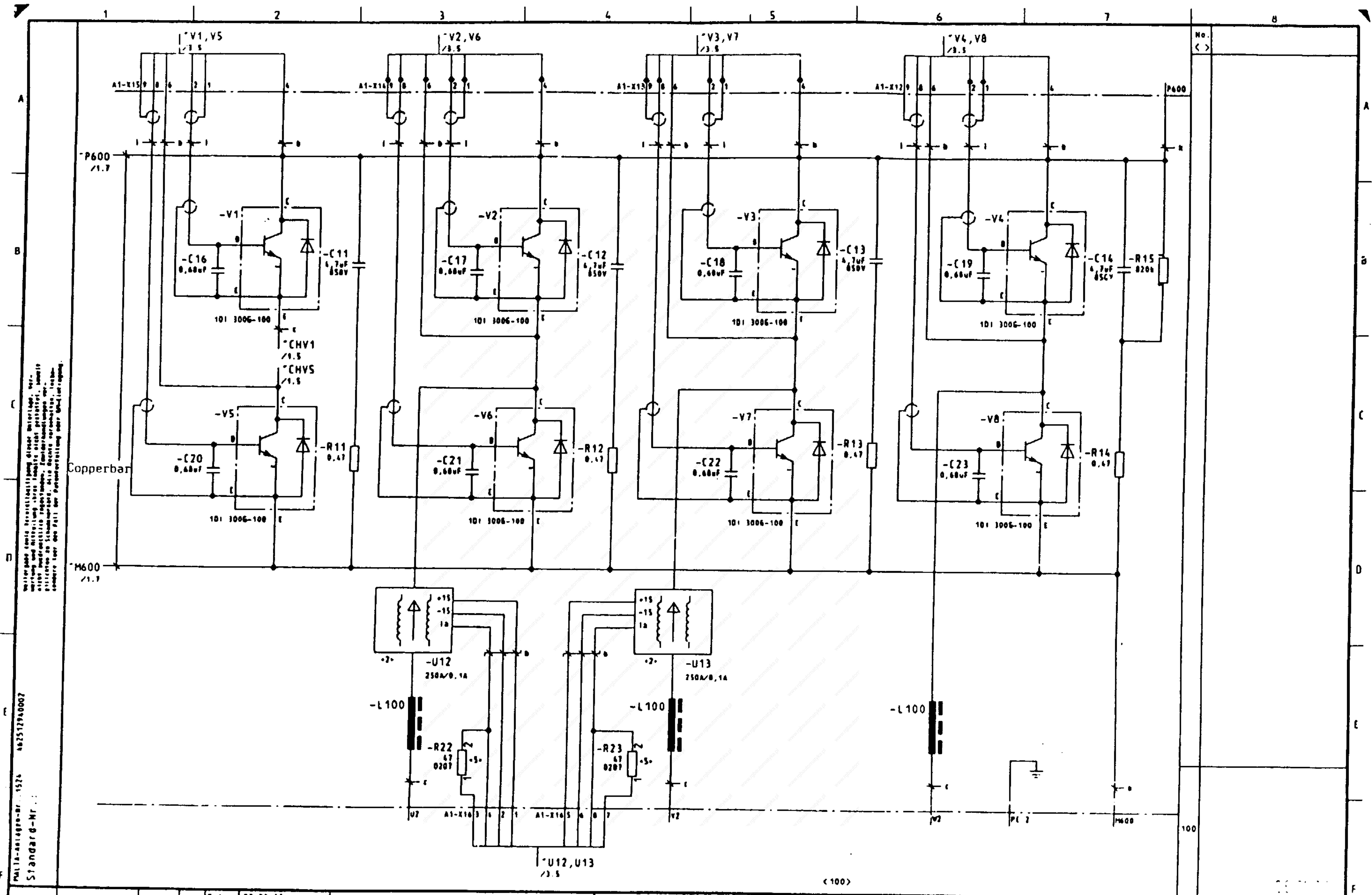

Wichtig: Diese Bauelemente sind als Ersatzteile zu beschaffen. Die Montage und die Art der Verbindung ist in der Montageanleitung zu beachten. Die Bauelemente sind in der Montageanleitung zu beschaffen. Die Bauelemente sind in der Montageanleitung zu beschaffen.

Palla-Anlagen-Nr. 1526  
 4251294007  
 Standard-Nr.:

Datum 27.02.88 Bearb. ZAMORAK/SC		Datum 15.01.91 Bearb. ZAMORAK/SC		Datum 20.12.89 Bearb. STEINIGLWEG		Datum 02.06.88 Bearb. BI		Urspr./Ers. 1./Ers. d.			
Siemens AG Bereich Energietechnik Geratewerk Erlangen				SIMODRIVE AC main spindle drive Power section 120 A				AUT E 2141 3GE.462.512.9400.02 SP e		Blatt 2 Bl.	

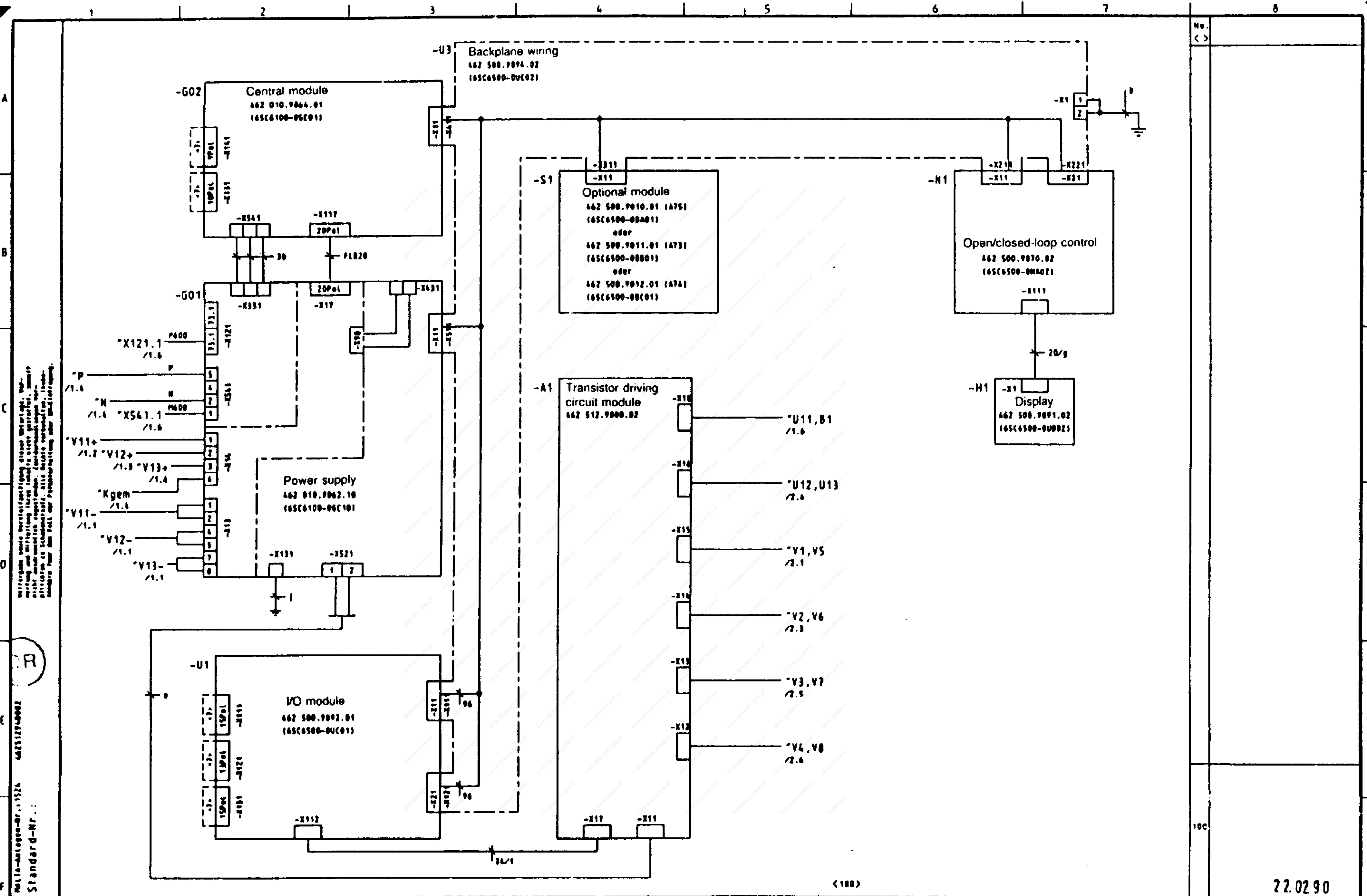

Mit diesem Schema wird die Verdrahtung dieses Antriebs, der  
 mit dem Motor über einen 120 A-Stecker verbunden ist, dargestellt.  
 Die Anschlüsse sind nach dem Typ der Fehlersuche für den  
 Motor zu wählen.

Multimeter-Nr. 11524 4425129-0002  
 Standard-Nr.:

Datum 22.02.88		Siemens AG		SIMODRIVE		AUT E241		3GE.462.512.9400.02 SP		Blatt 3-		
0	100451	09.02.9005	Geord. ZANDRAK/SC	Bereich AUT		AC main spindle drive				01		
0	0094*	22.01.9005	Gepr. STEINIGER	Gerätewerk Erlangen		Power section 120 A						
Zust.	Änderung	Datum	Nr.	Nr.	Grupp./Ztr. f./Ztr. 8							

22.02.90

<100>

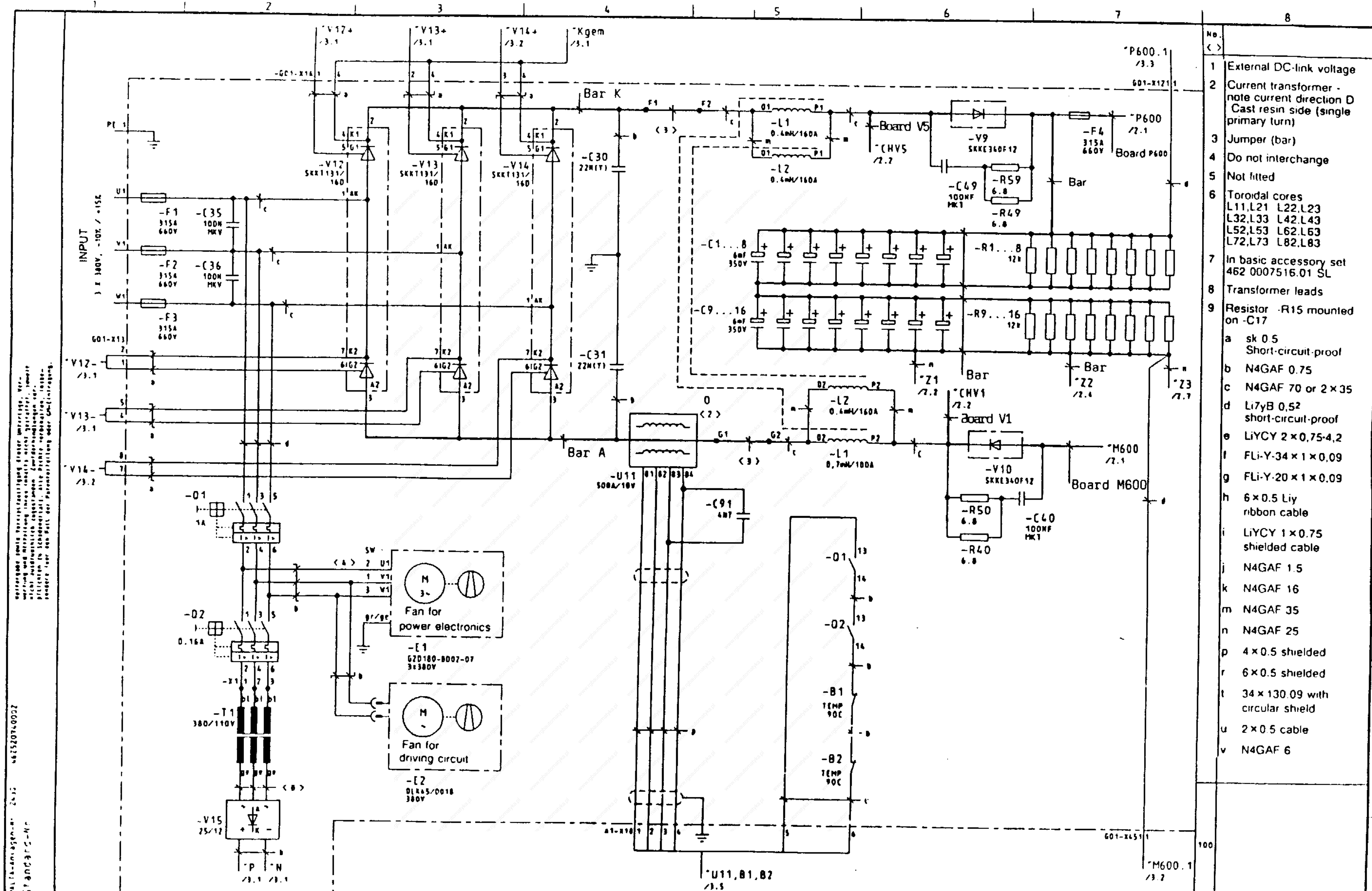

Vorgegebene Bauteile verwenden! Die Bauteilebezeichnungen, Werte und Anordnungen sind durch die Zeichnung eindeutig definiert. Änderungen sind nur durch eine schriftliche Freigabe der Zeichnung zulässig. Die Zeichnung ist die verbindliche Grundlage für die Fertigung.

No.	Legend
1	External DC-link voltage
2	Current transformer - note current direction D Cast resin side (single primary turn)
3	Jumper (bar)
4	Do not interchange
5	Not fitted
6	Toroidal cores L11,L21 L22,L23 L32,L33 L42,L43 L52,L53 L62,L63 L72,L73 L82,L83
7	In basic accessory set 462 0007516.01 SL
8	Transformer leads
9	Resistor -R15 mounted on -C17
a	sk 0.5 Short-circuit-proof
b	N4GAF 0.75
c	N4GAF 70 or 2 x 35
d	Li7yB 0,52 short-circuit-proof
e	LiCY 2 x 0,75-4,2
f	FLi-Y-34 x 1 x 0,09
g	FLi-Y-20 x 1 x 0,09
h	6 x 0,5 Lii ribbon cable
i	LiCY 1 x 0,75 shielded cable
j	N4GAF 1.5
k	N4GAF 16
m	N4GAF 35
n	N4GAF 25
p	4 x 0.5 shielded
r	6 x 0.5 shielded
t	34 x 130.09 with circular shield
u	2 x 0.5 cable
v	N4GAF 6

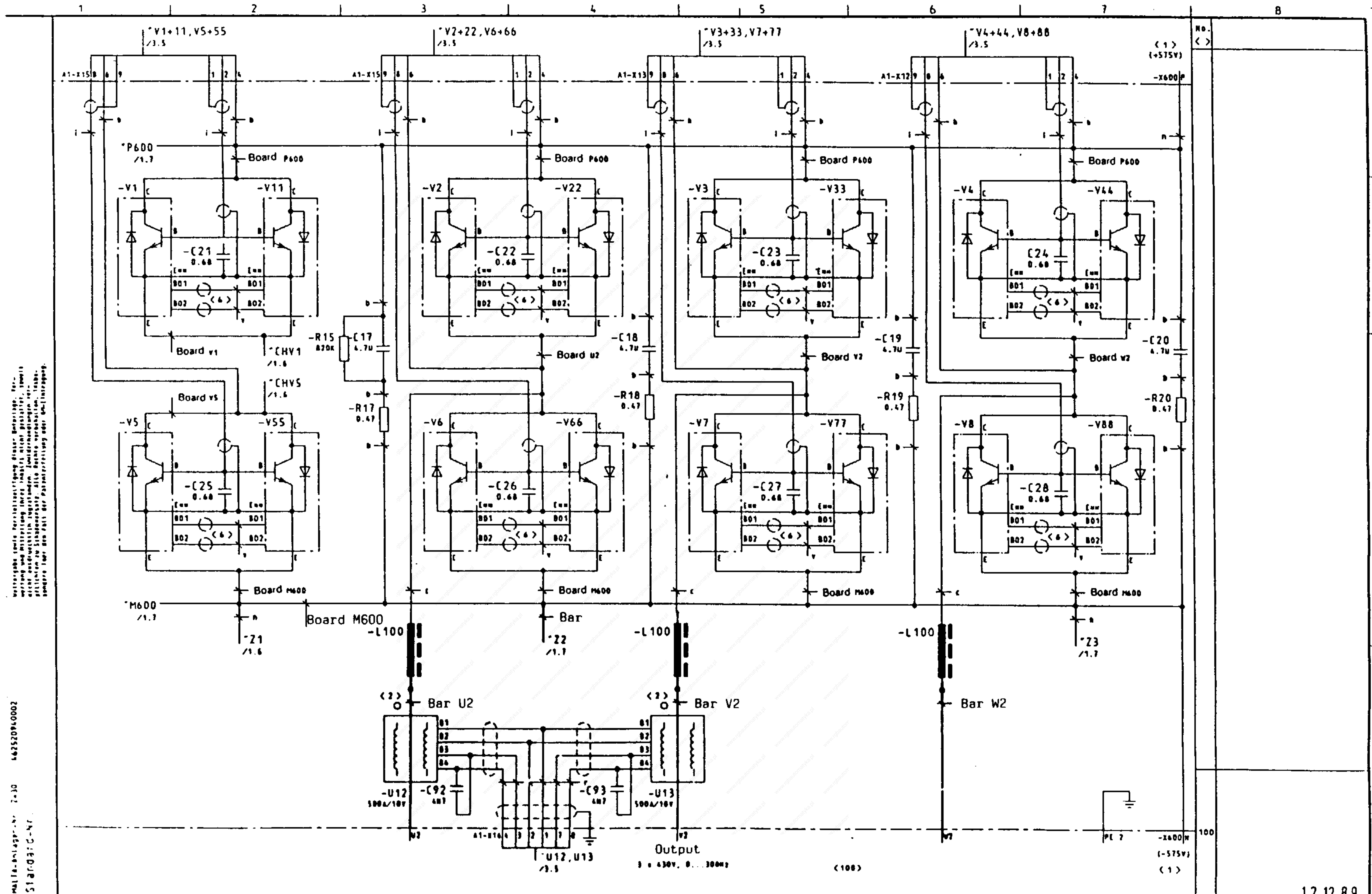

Weitergabe sowie Vervielfältigung dieses Dokuments, Ver-  
 wendung und Mitteilung dieses Dokuments Dritten, Ver-  
 änderung, Nachdruck, Verbreitung, Verbreitung, Ver-  
 öffentlichung, Verbreitung, Verbreitung, Verbreitung,  
 sind ohne schriftliche Genehmigung der Siemens AG  
 sind ohne schriftliche Genehmigung der Siemens AG

Maf-Anlage-Nr. 7-30 16252094002  
 STAB: C-Vr

		Datum	30.11.89	Siemens AG		SIMODRIVE			
		Gepr.	ZAMORAN/BS	Bereich AUT		AC main spindle drive			
		Gepr.	STEINIGEWEG	Gerätevers. Erlangen		Power section 200 A			
1	2	3	4	5	6	7	8	9	10
110140		17.04.91	0m	AUT (2422)		3GE.462.520.9400.02 SP d		Blatt 2-	
Kategorie		Datum	Name	Urspr./Ers. 1/Ers. 0				Blatt 2-	

12.12.89



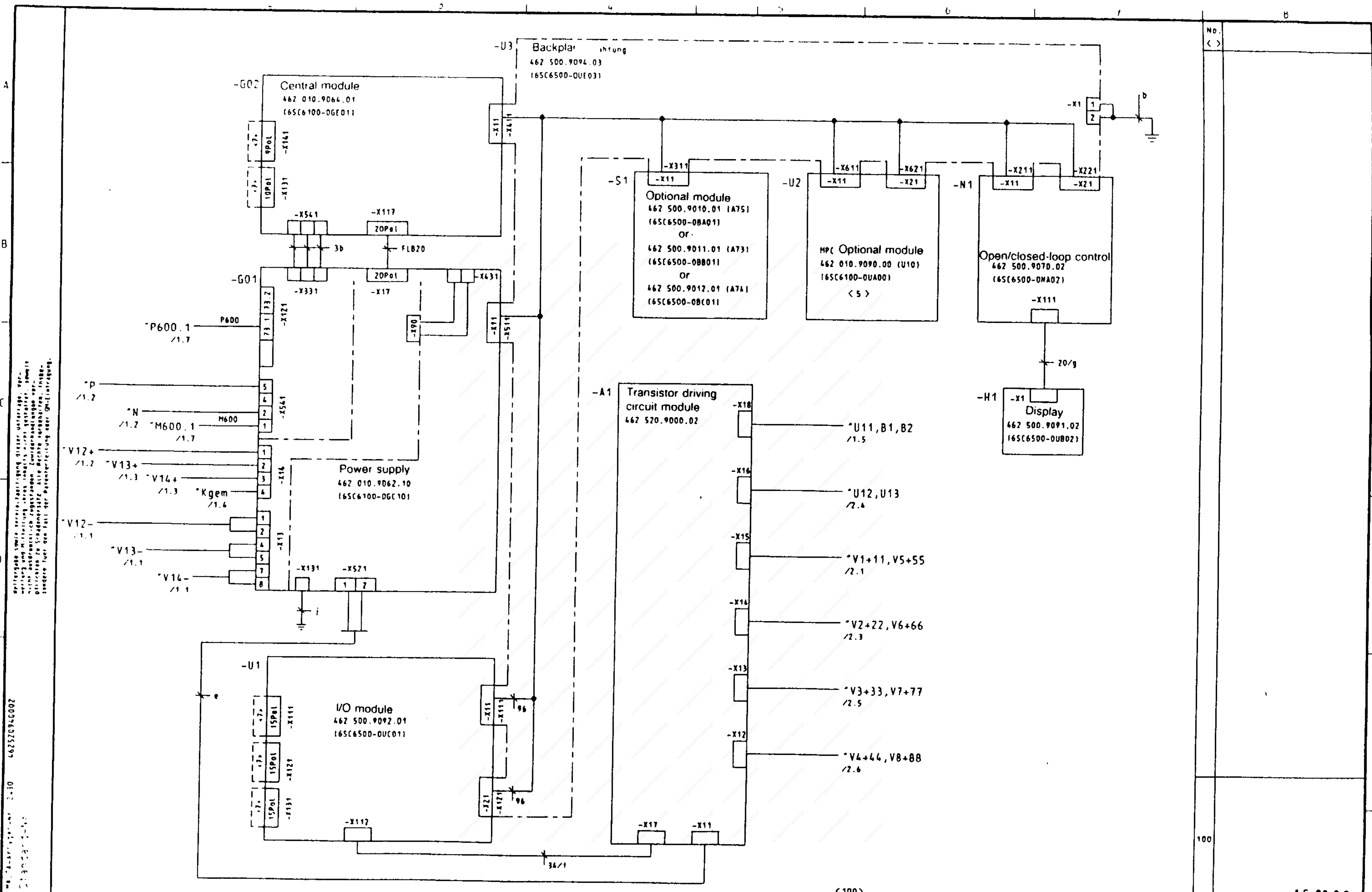

Bitte beachten: Die Montageanleitung ist Bestandteil des Produktes. Sie enthält wichtige Hinweise zur sicheren Montage und Inbetriebnahme. Bitte lesen Sie die Montageanleitung vor der Montage. Die Montageanleitung ist in deutscher Sprache. Bei Fragen wenden Sie sich an den Kundendienst.

46252094002  
 15.03.90

1	00001	00 01 90 05	Datum	30.11.89	Siemens AG Bereich AUT Gerätewerk Erlangen	SIMODRIVE AC main spindle drive Power section 200 A	AUT E241	3GE 462 520 9400 02 SP b	Blatt 3 Bl.
2	00002	00 01 90 05	Bearb.	ZANDRAK/DS					
3	00003	00 01 90 05	Gepr.	STEINIGEWIG	Urspr./Ers. f./Ers. d.				

15.03.90

100

<100>

6.4 Dimension drawings  
6.4.1 Converter dimension drawings

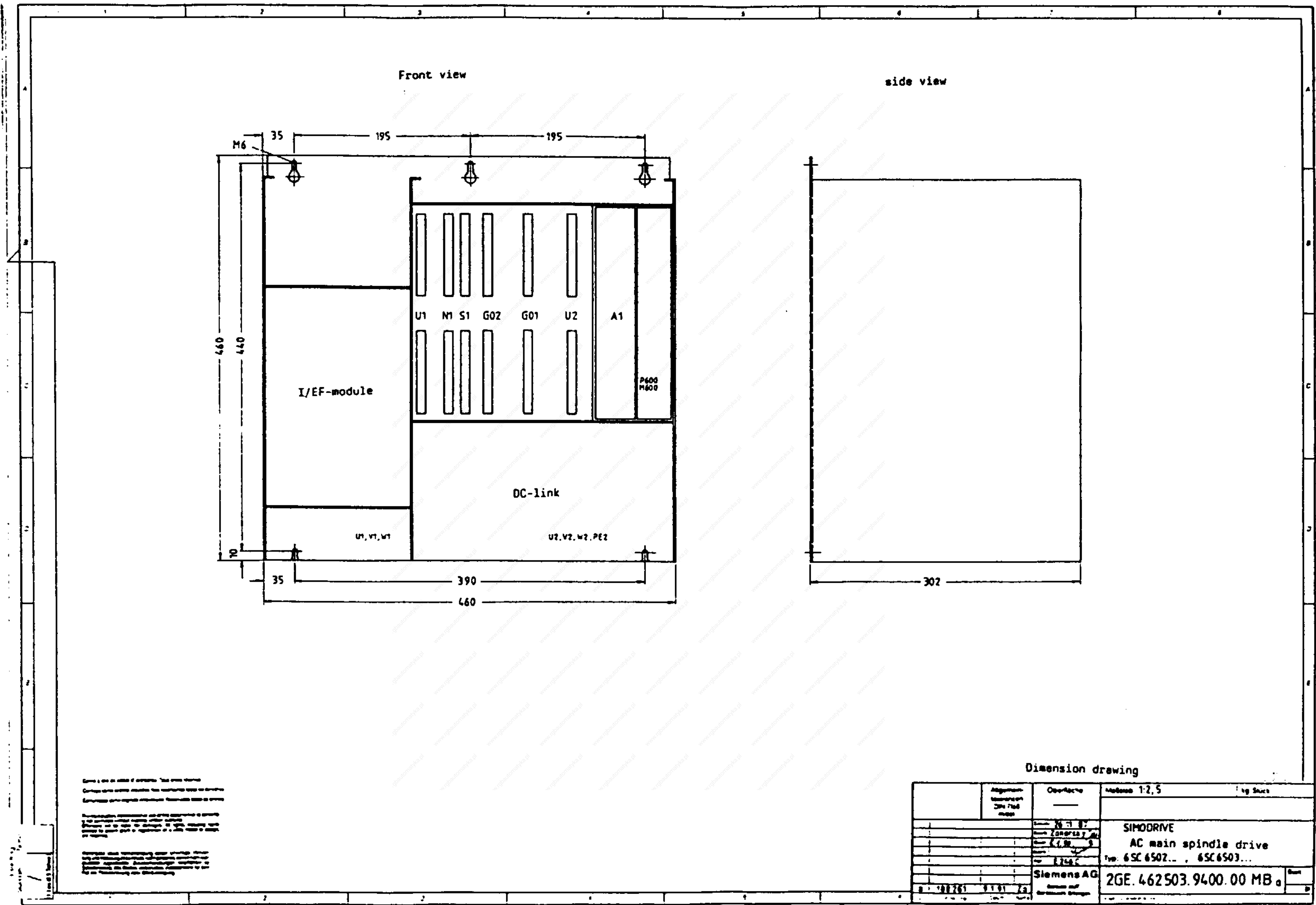

Fig. 6.6 Dimension drawing for 6SC6502 and 6SC6503

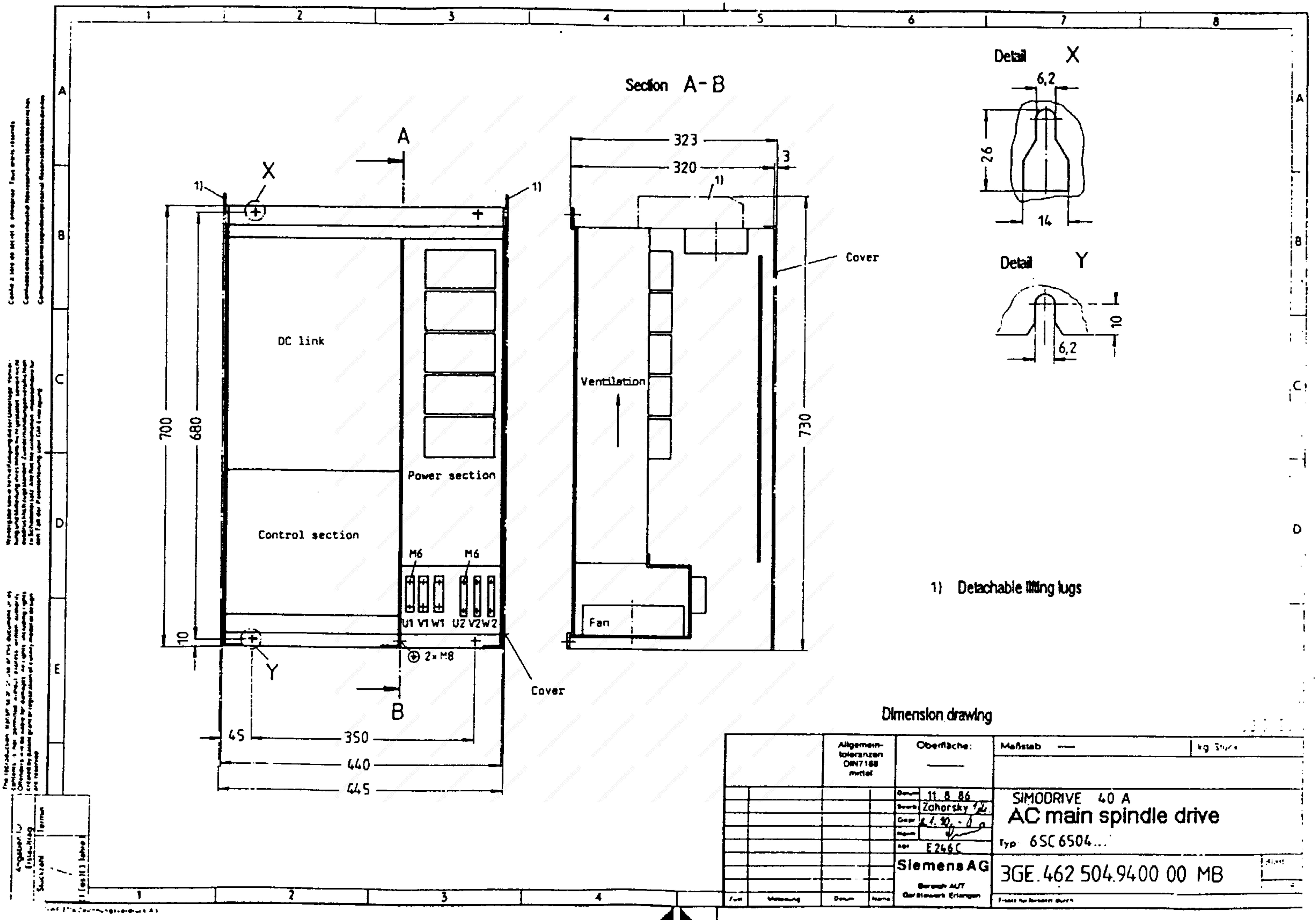

Fig. 6.7 Dimension drawing for 6SC6504 and 6SC6506

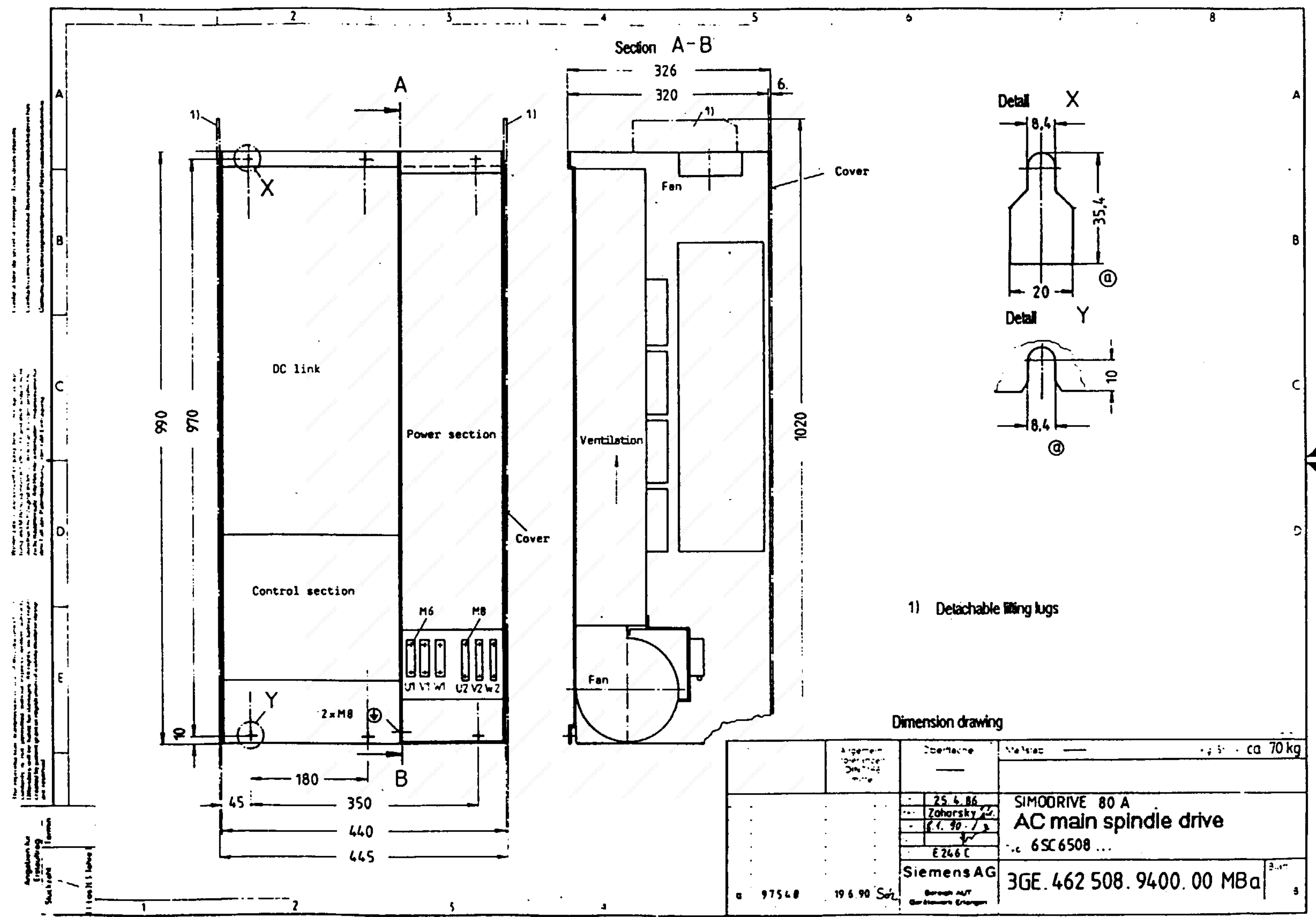

Fig. 6.8 Dimension drawing for 6SC6508

© Siemens AG 1989 All Rights Reserved  
SIMODRIVE 650 (BE) 6SC6501-0AA76

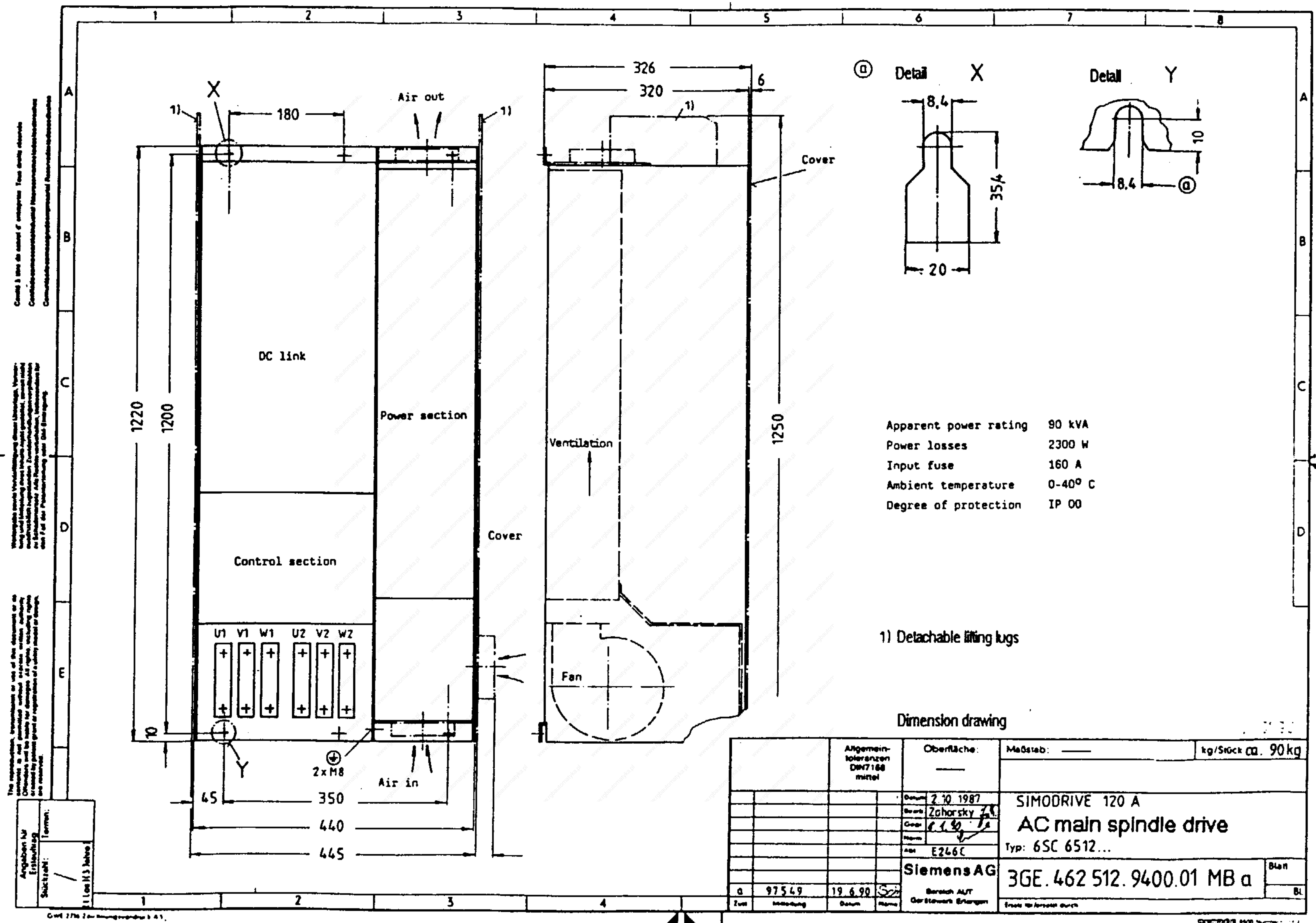

Fig. 6.9 Dimension drawing for 6SC6512

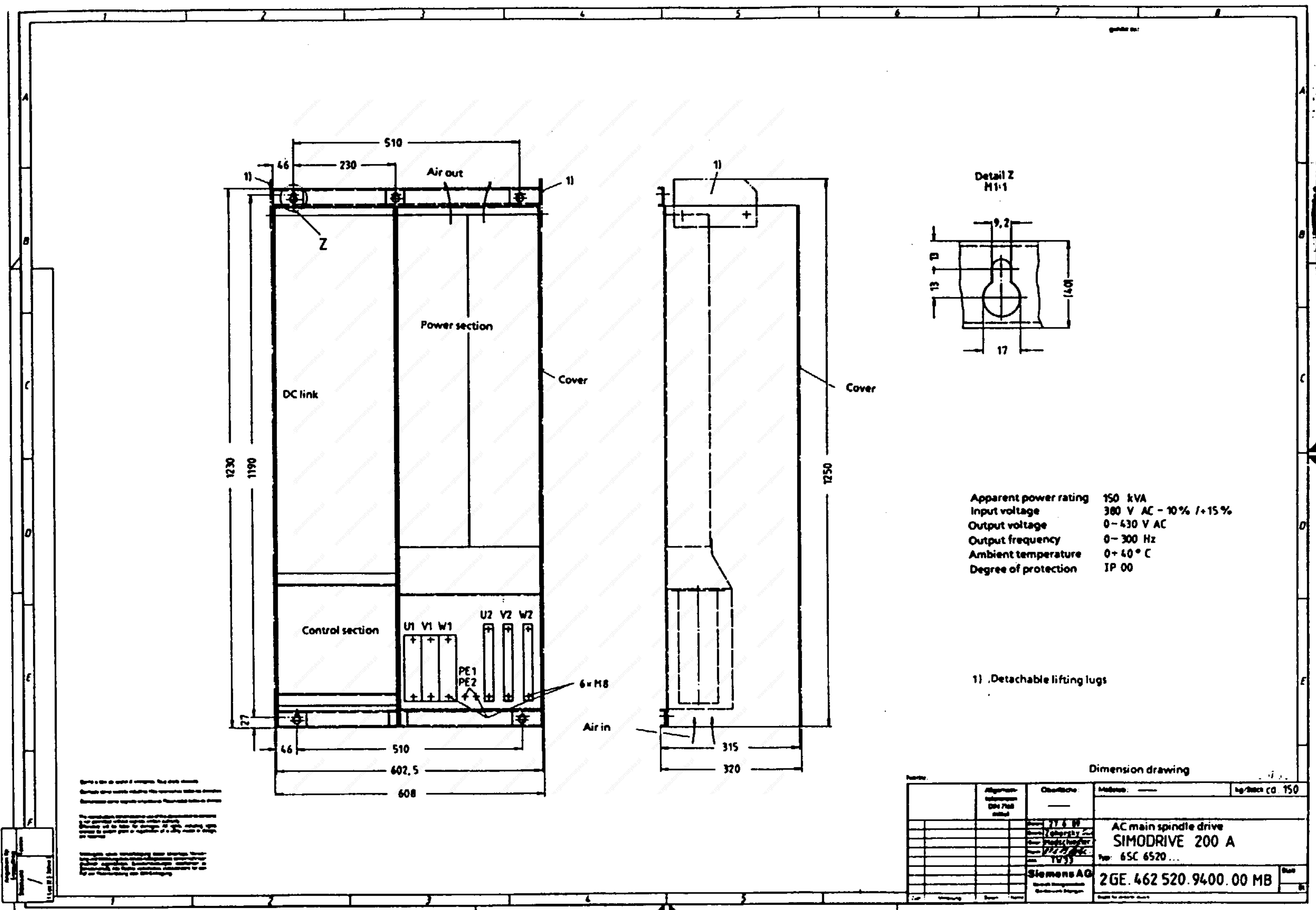

Fig. 6.10 Dimension drawing for 6SC6520

© Siemens AG 1989 All Rights Reserved 6SC6501-0AA76  
SIMODRIVE 650 (BE)

6.4.2 E45 external heat dissipation option

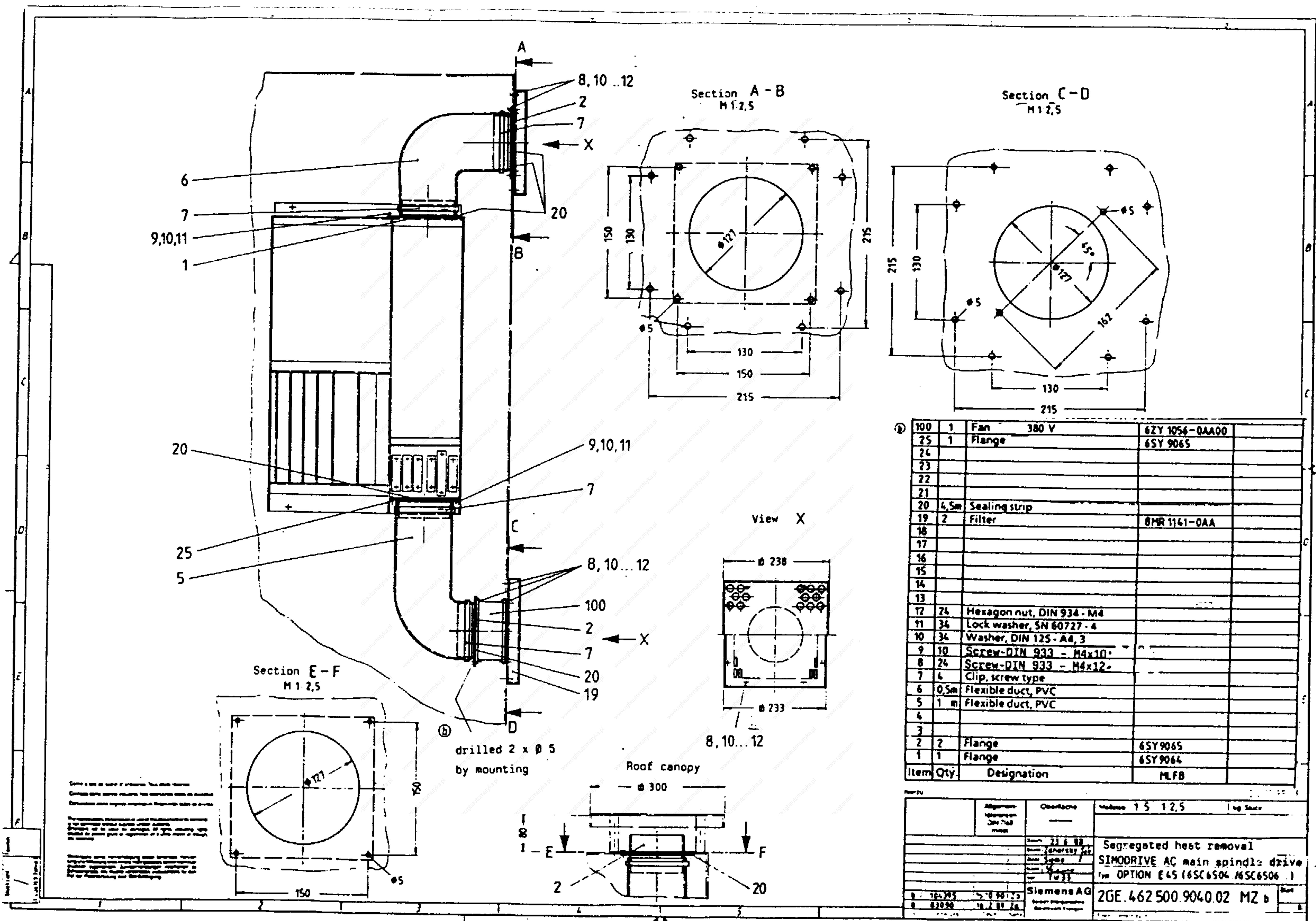

Fig. 6.11 External heat dissipation for 6SC6504 and 6SC6506

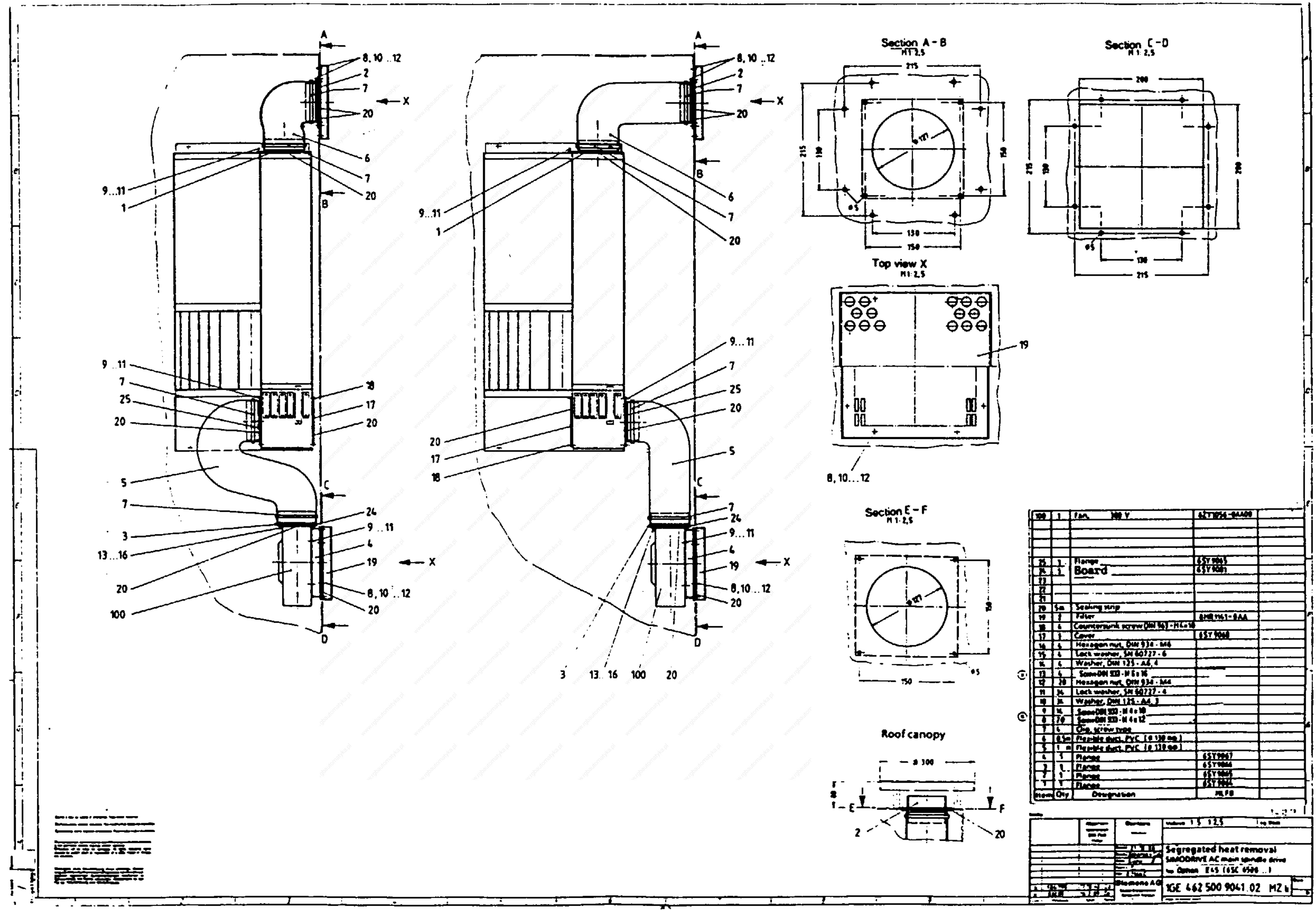

Fig. 6.12 External heat dissipation for 6SC6508

© Siemens AG 1989 All Rights Reserved  
SIMODRIVE 650 (BE) 6SC6501-0AA76



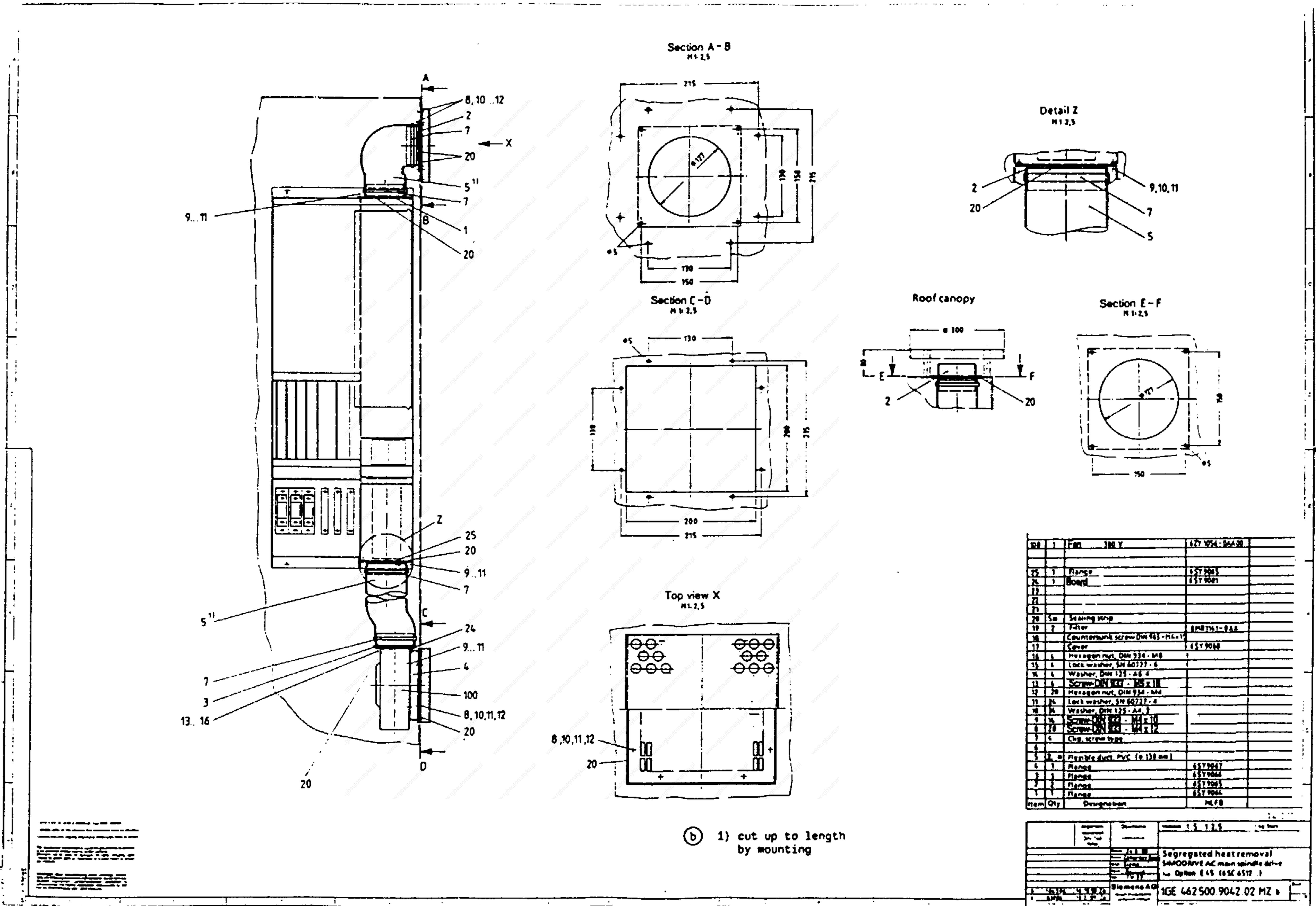

Fig. 6.13 External heat dissipation for 6SC6512

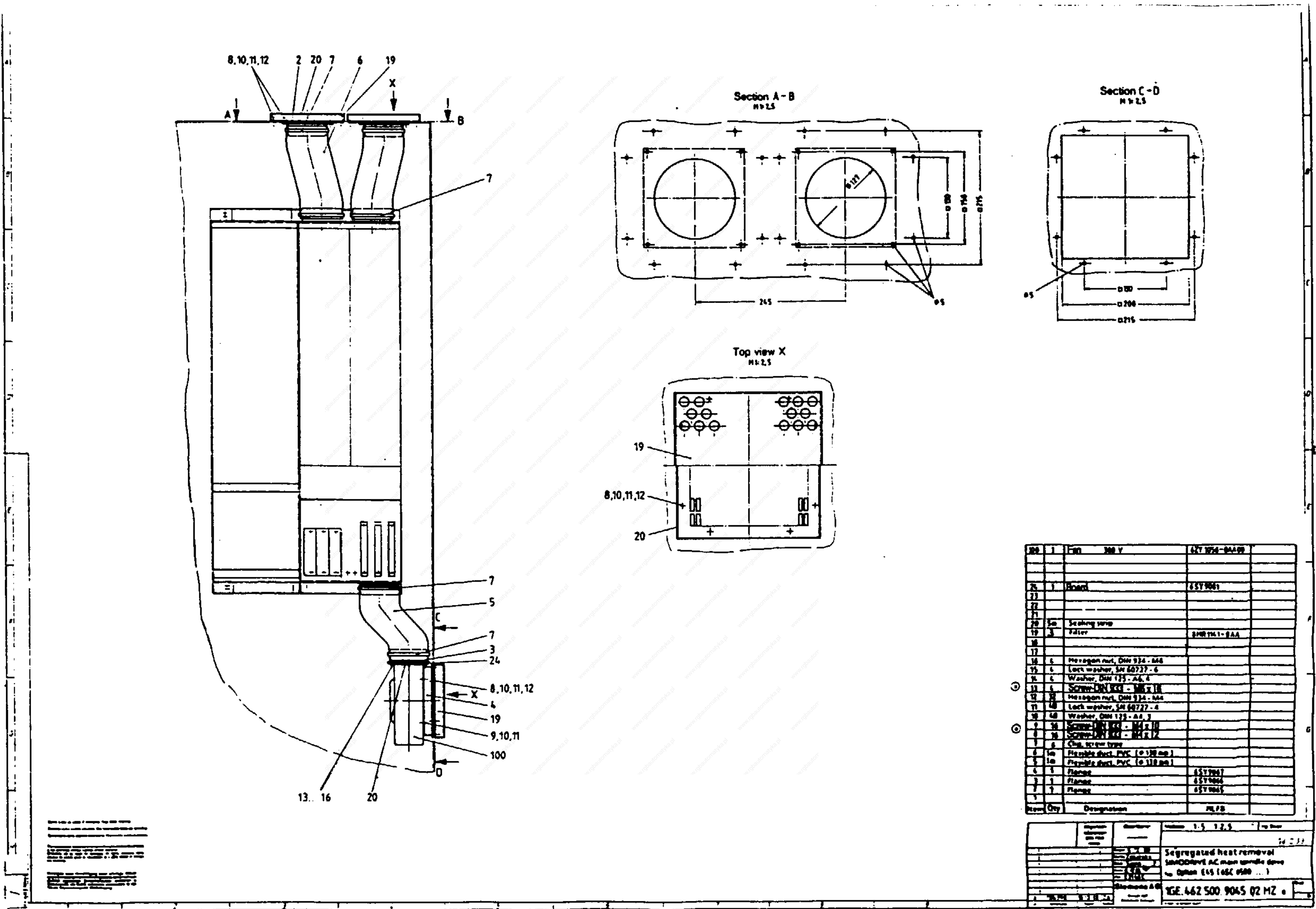

Fig. 6.14 External heat dissipation for 6SC6520

© Siemens AG 1989 All Rights Reserved 6SC6501-0AA76  
SIMODRIVE 650 (BE)

6.4.3 E55 connecting flange option

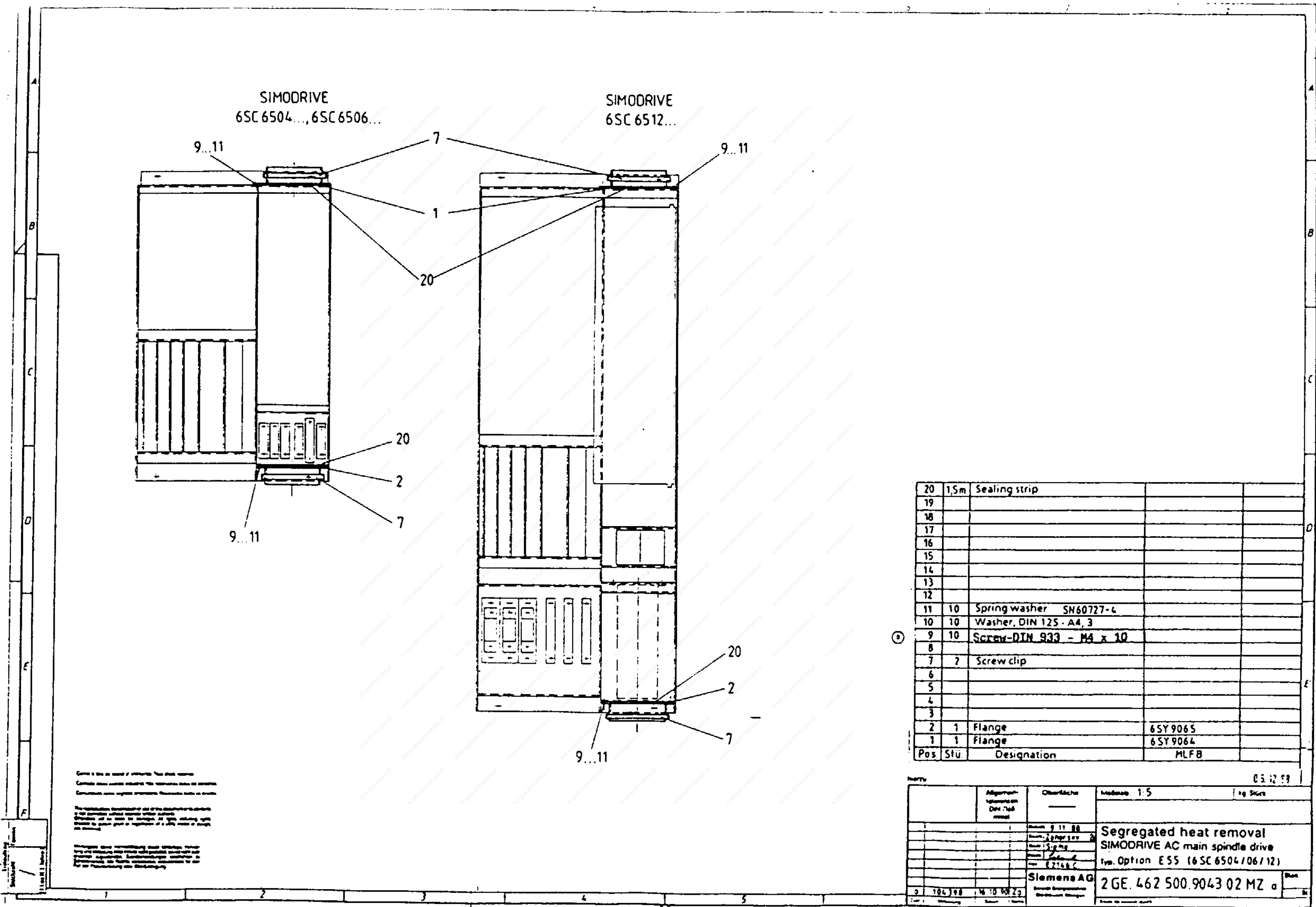

Fig. 6.15 E55 connecting flange for 6SC6504, 6SC6506, 6SC6512

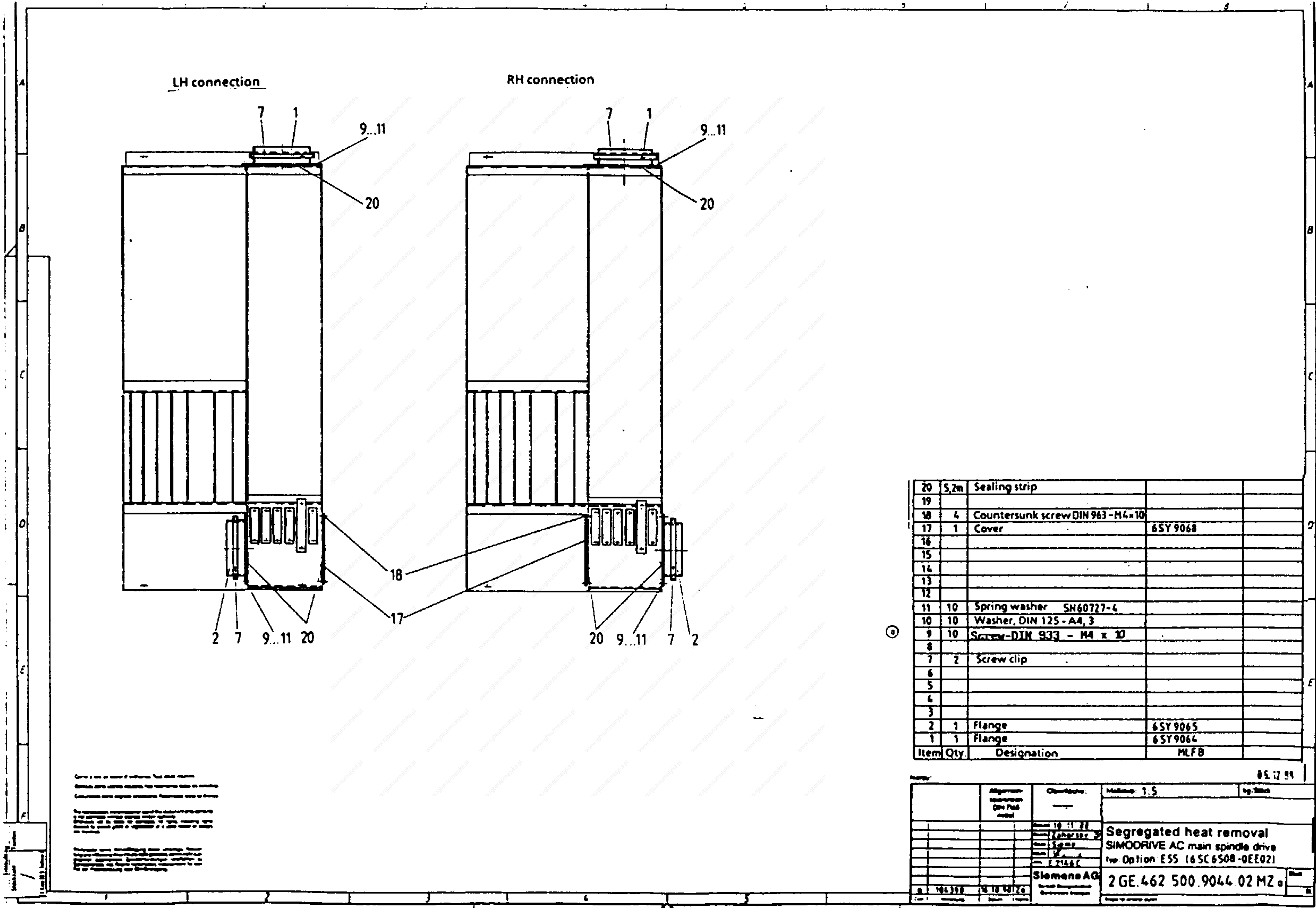
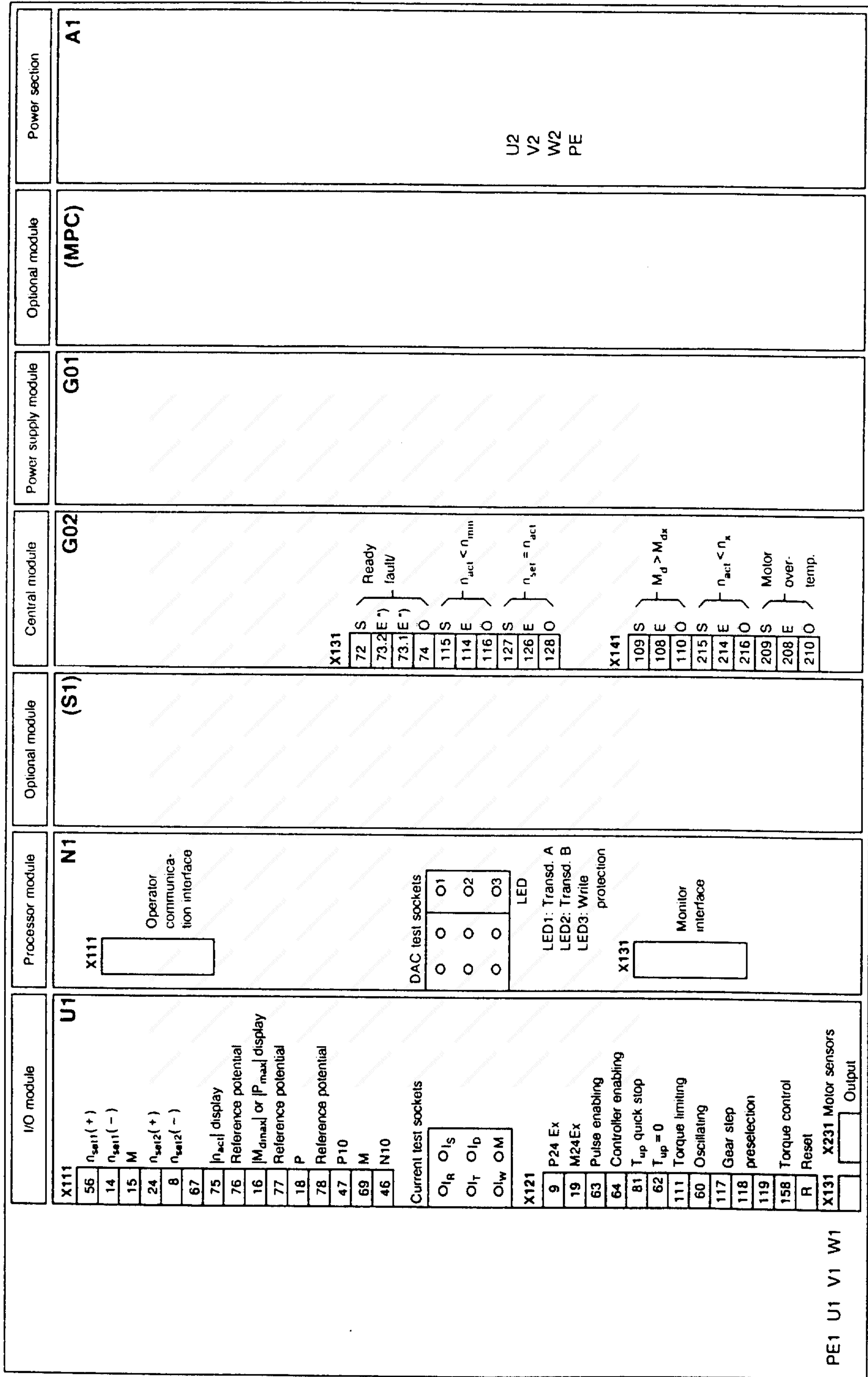

Fig. 6.16 Connecting flange for 6SC6508

© Siemens AG 1989 All Rights Reserved 6SC6501-0AA76  
SIMODRIVE 650 (BE)

### 6.5 Location of the interfaces



\* ) Terminals 73.1 and 73.2 are interconnected via a 0  $\Omega$  resistor.

Fig. 6.17 Location of the interfaces, PWM converters 6SC6502 and 6SC6503

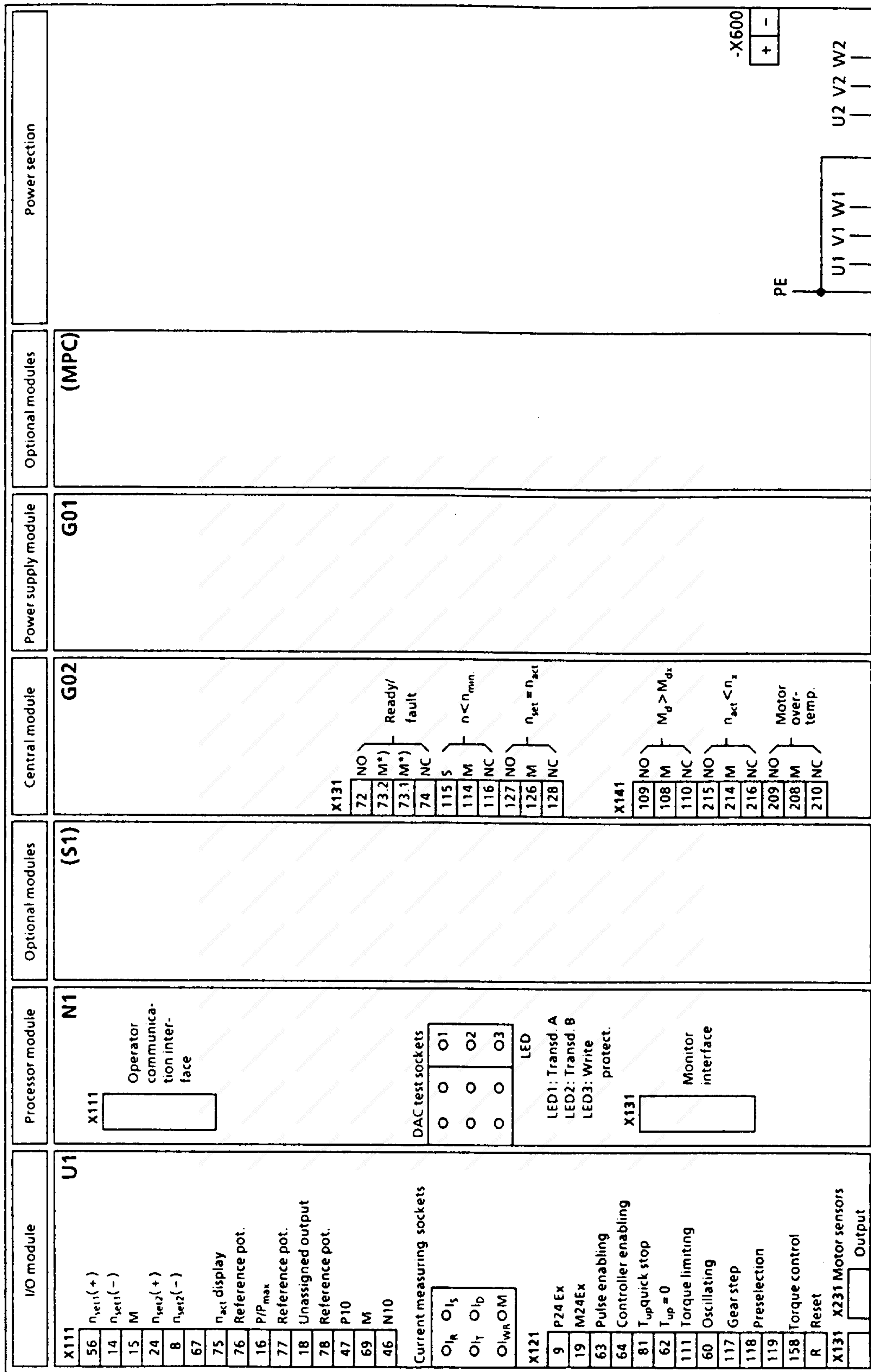

\*) Terminals 73.1 and 73.2 are interconnected via a 0 Ω resistor.

Fig. 6.18 Location of the interfaces, PWM converters 6SC6504, 6SC6506, 6SC6508, 6SC6512 and 6SC6520

## 6.6 Overview of the setting parameters

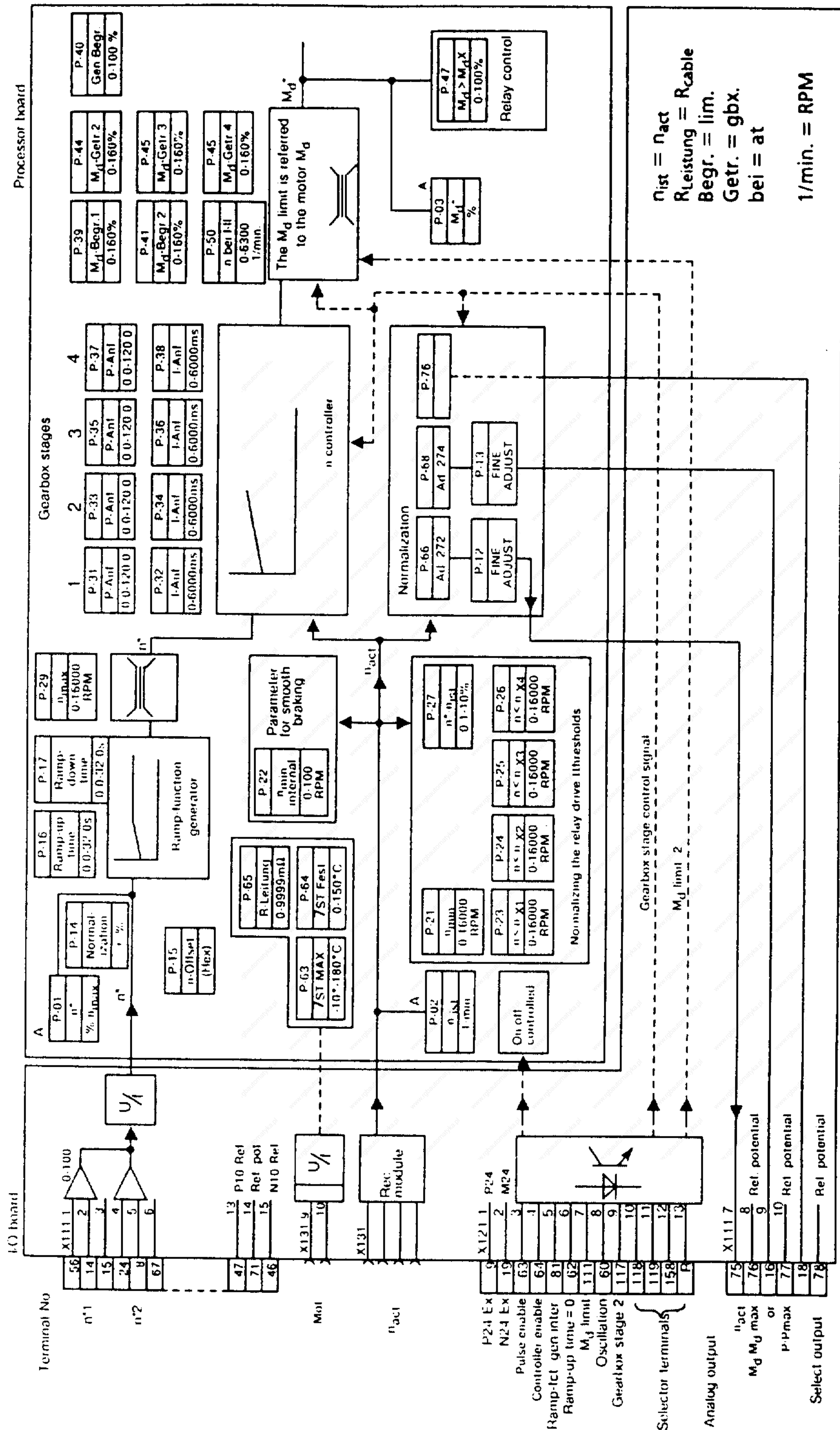

Overview of the setting and optimization parameters (DHSA)

## 6.7 Parameter list

The parameters in brackets are only display parameters.

		Included in Section	Valid from software release
(P-00)	Operating display	3.3.1	03
(P-01)	Speed setpoint (%)	3.3.2	03
(P-02)	Speed actual value (RPM)	3.3.2	03
(P-03)	Torque setpoint (%)	3.3.2	05
(P-04)	$M_d/M_{dmax}$ and $P/P_{max}$ (%)	3.3.2	05
(P-05)	Motor frequency (Hz)	3.3.2	03
(P-06)	DC link voltage (V)	3.3.2	03
(P-07)	DC link current (A)	3.3.2	03
(P-08)	DC link power (kW)	3.3.2	03
(P-09)	Supply frequency (Hz)	3.3.2	03
(P-10)	Stator temperature (°C)	3.3.2	03
(P-11)	Input word (hex)	3.3.2	03
P-12	Normalization D/A converter $n_{act}$ display (%)	3.3.3	05
P-13	Normalization D/A converter $P/P_{max}$ display (%)	3.3.3	05
P-14	Normalization, speed setpoint (%)	3.3.4	03
P-15	Offset correction, speed setpoint (hex)	3.3.4	03
P-16	Ramp-function generator, ramp-up time	3.3.5	08
P-17	Ramp-function generator, ramp-down time	3.3.5	08
P-18	Degree of rounding-off	3.3.5	08
(P-20)	Speed actual value, fault counter	4.7.4	08
P-21	$n_{act} < n_{min}$ relay 1 (RPM)	3.3.6	03
P-22	$n_{min}$ internal (RPM)	3.3.6	03
P-23	$n_{act} < n_x$ relay, gearbox stage 1 (RPM)	3.3.6	03
P-24	$n_{act} < n_x$ relay, gearbox stage 2 (RPM)	3.3.6	03
P-25	$n_{act} < n_x$ relay, gearbox stage 3 (RPM)	3.3.6	03
P-26	$n_{act} < n_x$ relay, gearbox stage 4 (RPM)	3.3.6	03
P-27	$n_{set} = n_{act}$ relay (%)	3.3.6	03
(P-28)	Fault flag	4.7.3	09
P-29	Speed limiting (RPM)	3.3.6	03
(P-30)	Display of the active functions P-83 to P-86	3.3.14	04
P-31	Speed controller, P component, gearbox stage 1 (1)	3.3.7	03
P-32	Speed controller, I component, gearbox stage 1 (ms)	3.3.7	03
P-33	Speed controller, P component, gearbox stage 2 (1)	3.3.7	03
P-34	Speed controller, I component, gearbox stage 2 (ms)	3.3.7	03
P-35	Speed controller, P component, gearbox stage 3 (1)	3.3.7	03
P-36	Speed controller, I component, gearbox stage 3 (ms)	3.3.7	03
P-37	Speed controller, P component, gearbox stage 4 (1)	3.3.7	03
P-38	Speed controller, I component, gearbox stage 4 (ms)	3.3.7	03
P-39	1st torque limit value (%)	3.3.8	03
P-40	Regenerative limit (%)	3.3.8	03
P-41	2nd torque limit value (%)	3.3.8	03
P-42	$M_d$ limit for change from mot. to regen. oper. (%)	3.3.8	05
P-43	$M_d$ limiting time P-42 (ms)	3.3.8	05



Parameters in brackets are only display parameters.

		Included in Section	Valid from software release
P-44	Torque limit, gearbox stage 2 (%)	3.3.8	03
P-45	Torque limit, gearbox stage 3 (%)	3.3.8	03
P-46	Torque limit, gearbox stage 4 (%)	3.3.8	03
P-47	$M_d > M_{dx}$ relay (%)	3.3.8	03
P-48	Normalization $M_{dset}$ (%)	3.3.8	04
P-49	Offset $M_{dset}$ (hex)	3.3.8	04
P-50	Switching speed, torque limit from $M_{d1}$ to $M_{d2}$ (RPM)	3.3.8	03
P-51	Keyword, write protection (hex)	3.3.9	03
P-52	Transfer into EEPROM (hex)	3.3.9	03
P-53	Control word, ready/fault message (hex)	3.3.9	08
P-54	M19 - normalization speed setpoint (%)	3.3.10	03
P-55	M19 - offset correction speed setpoint (hex)	3.3.10	03
P-56	M19 - changeover point (RPM)	3.3.10	03
P-57	M19 - position controller gain (1)	3.3.10	03
P-58	M19 - speed actual value gain	3.3.10	06
P-59	M19 - positioning window (1)	3.3.10	03
P-60	M19 - monitoring time (s)	3.3.10	03
(P-61)	M19 - position controller output	3.3.10	05
P-62	M19 - switching threshold for I component, speed controller	3.3.10	12
P-63	Max. motor temperature (°C)	3.3.11	03
P-64	Fixed temperature (°C)	3.3.11	03
P-65	Cable resistance (mΩ)	-	03
P-66	Assignment D/A converter 1 (hex)	3.3.12	03
P-67	Normalization D/A converter 1 (hex)	3.3.12	03
P-68	Assignment D/A converter 2 (hex)	3.3.12	03
P-69	Normalization D/A converter 2 (hex)	3.3.12	03
(P-70)	Transistor diagnostics	4.7.2	05
P-74	DC link voltage setpoint	3.3.13	14
P-75	Forming the DC link capacitors	3.3.13	03
P-76	Assignment D/A converter 3 (hex)	3.3.12	09
P-77	Normalization D/A converter 3 (hex)	3.3.12	09
P-78	Offset D/A converter 1	3.3.12	04
P-79	Offset D/A converter 2	3.3.12	04
P-80	Offset D/A converter 3	3.3.12	04
P-81	Rotor resistance correction	-	03
P-82	Magnetization time	-	05
P-83	Terminal function assignment, terminal 119 (hex)	3.3.14	04
P-84	Terminal function assignment, terminal 158 (hex)	3.3.14	04
P-85	Terminal function assignment, terminal R (hex)	3.3.14	04
P-86	Terminal function assignment, terminal 118 (hex)	3.3.14	12
P-90	Control parameter	3.3.9	12
P-94	DC link capacitance (μF) (for combination unit)	3.3.15	09
P-95	Converter code number (1)	3.3.15	03
P-96	Motor code number (1)	3.3.15	03
P-97	Initialization	3.3.15	03
P-98	Encoder pulses/revolution (1)	3.3.15	03

The parameters in brackets are only display parameters.		Included in Section	Valid from software release
(P-99)	Date of the software release, D80/D82 control (DD/M/J)	3.3.16	03
(P-100)	Operating display	3.3.17	07
(P-101)	$n_{set}$ (‰)	3.3.18	04
(P-102)	$n_{act}$ (hex)	3.3.18	04
P-103	Digital filter	3.3.18	04
P-104	Filter quality	3.3.18	04
P-105	P gain speed controller for C-axis speed actual value (1)	3.3.18	03
P-106	Integral-act. time $T_N$ , speed contr. C-axis speed act. val. (ms)	3.3.18	03
P-107	Changeover speed to C-axis operation (RPM)	3.3.18	03
P-108	Changeover speed to std. $n_{act}$ val. in the C-axis mode (RPM)	3.3.18	03
P-109	Switching parameter, C axis (hex)	3.3.18	08
P-110	Encoder matching factor, C axis sin/cos (hex)	3.3.18	04
P-111	P gain, speed controller for standard $n_{act}$ value (1)	3.3.18	03
P-112	Integr.-act. time $T_N$ , speed contr. for standard $n_{act}$ value (ms)	3.3.18	03
P-113	Speed setpoint, channel selection (dec.)	3.3.4	04
P-114	Normalization $n_{set}$ C-axis operation, gearbox stage 1 (%)	3.3.18	03
P-115	P gain, current controller (inverter)	3.3.18	04
P-116	Integral-action time (inverter)	3.3.18	04
P-117	Activation of the $n_{act}$ filter	3.3.18	04
P-118	Encoder matching factor (hex)	3.3.18	04
P-119	Flux matching factor (%)	3.3.18	04
P-121	Position setpoint 1, internal (dec.)	3.3.18	04
P-122	Position setpoint 1, internal (dec.)	3.3.18	04
P-123	Position setpoint 1, internal (dec.)	3.3.18	04
P-124	Position setpoint 1, internal (dec.)	3.3.18	04
P-125	Position setpoint 2, internal (dec.)	3.3.18	04
P-126	Cut-in point, re-enabling the I component of the speed controller (degrees)	3.3.18	11
P-127	Position setpoint "incremental positioning" internal (dec.)	3.3.18	04
(P-128)	Actual position setpoint (dec.)	3.3.18	06
P-129	Flag position = internal zero mark (hex)	3.3.18	04
P-130	Internal zero mark (dec.)	3.3.18	04
P-131	Max. pulse number between two zero marks GS1 (dec.)	3.3.18	04
P-132	Max. pulse number between two zero marks GS2 (dec.)	3.3.18	04
P-133	Max. pulse number between two zero marks GS3 (dec.)	3.3.18	04
P-134	Max. pulse number between two zero marks GS4 (dec.)	3.3.18	04
P-135	Cut-in point $K_V$ factor 1 (degrees)	3.3.18	03
P-136	Cut-in point $K_V$ factor 2 (degrees)	3.3.18	03
P-137	$K_V$ factor 1 (hex), dependent on the encoder pulse number	3.3.18	03
P-138	$K_V$ factor 2 (hex), dependent on the encoder pulse number	3.3.18	03
P-139	Multiplication factor for braking parabola (0 1 0 0 H $\neq$ 1)	3.3.18	03
(P-140)	Position controller status (dec.)	3.3.18	04
P-141	Switching parameter (hex)	3.3.18	03
P-142	Flag for speed increase (hex)	3.3.18	03
(P-143)	Zero mark identification bandwidth (degrees)	3.3.18	03
P-144	Response bandwidth, relay 1 "position reached" (degrees)	3.3.18	03
P-145	Response bandwidth, relay 2 "position reached" (degrees)	3.3.18	03
P-146	Search speed GS1 (RPM)	3.3.18	03
P-147	Search speed GS2 (RPM)	3.3.18	03
P-148	Search speed GS3 (RPM)	3.3.18	03
P-149	Start-up parameter (hex)	3.3.18	03

The parameters in brackets are only display parameters.

		Included in Section	Valid from software release
P-150	Search speed GS4 (RPM)	3.3.18	03
P-151	Keyword, write protection (hex)	3.3.9	03
P-152	Transfer into EEPROM (hex)	3.3.9	03
P-153	Not assigned		
P-154	Oscillation setpoint 1 (hex)	3.3.19	05
P-155	Oscillation setpoint 2 (hex)	3.3.19	05
P-156	Oscillation interval time (s)	3.3.19	05
P-157	Normalization, $n_{set}$ C-axis operation, gearbox stage 2 (%)	3.3.18	06
P-158	Normalization, $n_{set}$ C-axis operation, gearbox stage 3 (%)	3.3.18	06
P-159	$K_V$ factor "holding brake" (C-axis operation)	3.3.18	08
P-160	Rated motor output (kW)	3.3.20	04*)
P-161	Rated current (A)	3.3.20	04*)
P-162	Rated voltage (V)	3.3.20	04*)
P-163	Rated speed (RPM)	3.3.20	04*)
P-164	Rated frequency (Hz)	3.3.20	04*)
P-165	No-load voltage (V)	3.3.20	04*)
P-166	No-load current (A)	3.3.20	04*)
P-167	Stator resistance, cold (m $\Omega$ )	3.3.20	04*)
P-168	Rotor resistance, cold (m $\Omega$ )	3.3.20	04*)
P-169	Stator leakage reactance (m $\Omega$ )	3.3.20	04*)
P-170	Rotor leakage reactance (m $\Omega$ )	3.3.20	04*)
P-171	Main field reactance (m $\Omega$ )	3.3.20	04*)
P-172	First transition frequency (Hz)	3.3.20	04*)
P-173	Second transition frequency (Hz)	3.3.20	04*)
P-174	Maximum speed (RPM)	3.3.20	04*)
P-175	Max. motor temperature (°C)	3.3.20	04*)
P-176	Speed cut-in point for $M_d$ reduction due to stability limit	3.3.20	08
P-177	The data is calculated and stored by setting to 1	3.3.20	04
P-180	Flux reduction	3.3.20	12
P-181	Address of the monitored variable	4.7.5	09
(P-182)	Minimum value display	4.7.5	09
(P-183)	Maximum value display	4.7.5	09
P-184	U/f open-loop controlled operation (hex)	4.7.6	06
P-185	Memory address selection (hex)	3.3.21	08
P-186	Response value (hex)	3.3.21	08
P-187	Pull-in delay (s)	3.3.21	08
P-188	Drop-out delay (s)	3.3.21	08
P-189	Response value hysteresis (hex)	3.3.21	08
	} Selectable relay function		
P-190	DC link pre-control	3.3.22	09
P-191	Offset correction, DC link setpoint (hex)	–	05
(P-192)	Pos. counter status (squarewave encoder 90 000 pulses/rev.) (hex)	–	08
(P-193)	Pos. counter status (sine-cosine encoder) (hex)	–	08
(P-194)	Pos. controller output of the function "holding brake" (hex)	–	08
P-195	Comp. time change (filter function, C-axis operation)	3.3.18	06

\*) From software release 08, parameter values from P-160 to P-176 can be stored

The parameters in brackets are only display parameters.

		Included in Section	Valid from software release
P196	Control flag for damping elements	3.3.23	09
P197	Resonant frequency	3.3.23	09
P198	Damping constant	3.3.23	09
(P-199)	Date of the software release, inverter gating unit D76/D78	3.3.16	08
(P-201)	Position setpoint (dec.)	3.3.2	12
(P-202)	Position actual value (dec.)	3.3.2	12
(P-203)	Position setpoint (external) (hex) 3.3.2	12	
(P-204)	Not assigned		
(P-205)	Motor frequency (Hz)	3.3.2	12
(P-206)	Motor voltage (phase-to-phase) (V)	3.3.2	12
(P-207)	Pulse frequency (Hz)	3.3.2	12
(P-208)	Pulse frequency/motor frequency ratio	3.3.2	12
P-209 - 219 Not assigned			
P-220	Rated motor output (kW)	3.3.2.4	12
P-221	Rated current (A)	3.3.2.4	12
P-222	Rated voltage (V)	3.3.2.4	12
P-223	Rated speed (RPM)	3.3.2.4	12
P-224	Rated frequency (Hz)	3.3.2.4	12
P-225	No-load voltage (V)	3.3.2.4	12
P-226	No-load current (A)	3.3.2.4	12
P-227	Stator resistance, cold (mΩ)	3.3.2.4	12
P-228	Rotor resistance, cold (mΩ)	3.3.2.4	12
P-229	Stator leakage reactance (mΩ)	3.3.2.4	12
P-230	Rotor leakage reactance (mΩ)	3.3.2.4	12
P-231	Main field reactance (mΩ)	3.3.2.4	12
P-232	First transition frequency (Hz)	3.3.2.4	12
P-233	Second transition frequency (Hz)	3.3.2.4	12
P-234	Maximum speed (RPM)	3.3.2.4	12
P-235	Not assigned		
P-236	Speed cut-in point for $M_d$ reduction due to stability limit		12
P-237	The data is calculated and stored by setting to 1		12

Delta connection

P-238	Not assigned		
P-239	Torque limit value (%) C-axis operation	3.3.18	13
P-240	Not assigned		
P-241	Relay function selection for terminals 108 - 110	3.3.2.5	12
P-242	Relay function selection for terminals 214 - 216	3.3.2.5	12
P-243	Relay function selection for terminals 114 - 116	3.3.2.5	12
P-249	Cancellation window for the compulsory direction of rotation (option A74)	3.3.18	12
P-251	Keyword, write protection (hex)	3.3.9	14
P-252	P gain, synchronization controller	3.3.26	14
P-253	Speed threshold for $n_{act}$ generation from the rotor angle (Lambda).	3.3.10	13
P-254	Shutdown threshold ( $n^*$ for M19)	3.3.10	12

## 6.8 Setting and check data

Serial No.:

Parameter	Significance	Setting range	Dimension	Factory setting	Setting
-----------	--------------	---------------	-----------	-----------------	---------

### D/A converter setting data (refer to Section 3.3.3)

P-12	Norm., D/A converter, $n_{act}$ display	- 200.0 - + 300.0	%	100.0	
P-13	Normalization, D/A converter, $P/P_{max}$ display	- 200.0 - + 300.0	%	100.0	

### Speed settings (refer to Section 3.3.4)

P-113	Speed setpoint channel selection	0 - 3	Dec.	3	
P-14	Normalization $n_{set}$	- 250.0 - + 250.0	%	100.0	
P-15	Offset correction $n_{set}$	0 0 0 0 - F F F F	Hex	0 0 0 0	

### Ramp-function generator settings (refer to Section 3.3.5)

P-16	Ramp-function gen. ramp-up time	0.00 - 32.00	s	4.0	
P-17	Ramp-function gen. ramp-down time	0.00 - 32.00	s	4.0	
P-18	Degree of rounding-off	0 - 10	Dec.	0	

### Speed monitoring settings (refer to Section 3.3.6)

P-21	$n_{act} < n_{min}$ relay	0 - 6300	RPM	7	
P-22	$n_{min}$ internal	0 - 1500	RPM	11	
P-23	$n_{act} < n_{x1}$ relay	0 - 16000	RPM	1500	
P-24	$n_{act} < n_{x2}$ relay	0 - 16000	RPM	1500	
P-25	$n_{act} < n_{x3}$ relay	0 - 16000	RPM	1500	
P-26	$n_{act} < n_{x4}$ relay	0 - 16000	RPM	1500	
P-27	$n_{set} = n_{act}$ relay	0.1 - 11.0	%	3.9	
P-29	$n_{max}$ setting	0 - 20100	RPM	*)	

### Speed control setting parameters (refer to Section 3.3.7)

P-31	P component for gearbox stage 1	0.0 - 120.0	Dec.	32.0	
P-32	I component for gearbox stage 1	5 - 6000	ms	512	
P-33	P component for gearbox stage 2	0.0 - 120.0	Dec.	32.0	
P-34	I component for gearbox stage 2	5 - 6000	ms	512	
P-35	P component for gearbox stage 3	0.0 - 120.0	Dec.	32.0	
P-36	I component for gearbox stage 3	5 - 6000	ms	512	
P-37	P component for gearbox stage 4	0.0 - 120.0	Dec.	32.0	
P-38	I component for gearbox stage 4	5 - 6000	ms	512	

\*) Dependent on the motor type

Parameter	Significance	Setting range	Dimensions	Factory setting	Setting
-----------	--------------	---------------	------------	-----------------	---------

**Torque limit values** (refer to Section 3.3.8)

P-39	1st limit value $M_d$	0.0 - 180.0	%	100.0	
P-40	Regenerative limit	0 - 100	%	80	
P-41	2nd limit value $M_d$	0.0 - 180.0	%	100.0	
P-42	$M_d$ limit, mot. → gen.	25 - 80	%	33	
P-43	$M_d$ limiting time, P-42	40 - 200	ms	80	
P-44	$M_d$ limit value, gearbox stage 2	0.0 - 180.0	%	100.0	
P-45	$M_d$ limit value, gearbox stage 3	0.0 - 180.0	%	100.0	
P-46	$M_d$ limit value, gearbox stage 4	0.0 - 180.0	%	100.0	
P-47	$M_d > M_{dx}$ relay	0.0 - 100.0	%	90.0	
P-48	Normalization, $M_{dset}$	- 250.0 - + 250.0	%	100.0	
P-49	Offset correction $M_{dset}$	0 0 0 0 - F F F F	Hex	0 0 0 0	
P-50	Switching speed $M_{d1} / M_{d2}$	0 - 11500	RPM	6000	

**Control word** (refer to Section 3.3.9)

P-53	Ready/fault message	0 0 0 0 - F F F F	Hex	0 1 0 1	
P-90	Control parameter	0 0 0 0 - F F F F	Hex	0 0 0 1	

**Settings for M19 NC auxiliary function** (refer to Section 3.3.10)

P-54	Normalization, $n_{set}$	- 200.0 - + 250.0	%	25.0	
P-55	Offset correction $n_{set}$	0 0 0 0 - F F F F	Hex	0 0 0 0	
P-56	Changeover point	0 - 8000	RPM	750	
P-57	Position controller gain	0 0 0 0 - F F F F	Hex	0 0 0 0	
P-58	$n_{act}$ gain	1 - 10	Dec	2	
P-59	Positioning window	0 0 0 0 - F F F F	Hex	0 0 0 1	
P-60	Monitoring time	0.0 - 16.0	s	0.85	
P-62	Switch-in I comp., speed controller	0 - 3000	RPM	20	
P-253	Limit value for $n_{act}$ generation from the rotor angle ( $\lambda$ )	0 0 0 0 - F F F F	Hex	0 0 0 5	
P-254	Switch-off threshold ( $n^*$ for M19)	0 0 0 0 - F F F F	Hex	0 0 4 0	

Parameter	Significance	Setting range	Dimensions	Factory setting	Setting
-----------	--------------	---------------	------------	-----------------	---------

**Motor data and cable resistance setting** (refer to Section 3.3.11)

P-63	Max. motor temperature	0 - 150	°C	150	
P-64	Fixed temperature	0 - 150	°C	0	
P-65	Cable resistance	0 - 9999	mΩ	0	
P-81 *)	Correction, rotor resistance	50 - 200	%	100	
P-82 *)	Magnetization time	6 - 10	Dec	8	

**Assignment and normalization of the D/A converter** (refer to Section 3.3.12)

P-66	Assignment, D/A converter 1	0 0 0 0 - F F F F	Hex	0 2 7 2	
P-67	Normalization	0 0 0 0 - F F F F	Hex	0 0 0 0	
P-68	Assignment, D/A converter 2	0 0 0 0 - F F F F	Hex	0 2 7 4	
P-69	Normalization	0 0 0 0 - F F F F	Hex	0 0 0 0	
P-76	Assignment, D/A converter 3	0 0 0 0 - F F F F	Hex	0 3 1 E	
P-77	Normalization	0 0 0 0 - F F F F	Hex	0 0 0 0	
P-78	Offset D/A converter 1	0 0 0 0 - F F F F	Hex	0 0 0 0	
P-79	Offset D/A converter 2	0 0 0 0 - F F F F	Hex	0 0 0 0	
P-80	Offset D/A converter 3	0 0 0 0 - F F F F	Hex	0 0 0 0	

**DC link voltage setpoint** (refer to Section 3.3.13)

P-74	DC link voltage setpoint	570-600	V	600	
------	--------------------------	---------	---	-----	--

**Assignment of the terminal functions** (refer to Section 3.3.14)

P-83	Terminal 119	0 0 0 0 - 0 4 0 0	Hex	0 0 0 1	
P-84	Terminal 158	0 0 0 0 - 0 4 0 0	Hex	0 0 0 2	
P-85	Terminal R	0 0 0 0 - 0 4 0 0	Hex	0 0 0 4	
P-86	Terminal 118	0 0 0 0 - 0 4 0 0	Hex	0 2 0 0	

**Converter and motor data** (refer to Section 3.3.15)

P-94	DC link capacitance (for combination unit)	0 - 30000	μF	**)	
P-95	Converter Code No.	1 - 14	Dec	1	
P-96	Motor Code No.	101 - 206	Dec	101	
P-98	Encoder pulses/revolution	256 - 32000	Dec	1024	

\*) Can only be changed, when P-51 is set to 0 0 1 0 H.

\*\*) Dependent on the converter type



Parameter	Significance	Setting range	Dimensions	Factory setting	Setting
-----------	--------------	---------------	------------	-----------------	---------

**Software release date** (refer to Section 3.3.16)

(P-99)	Control	-	Dec	*)	
(P-199)	Gating unit	-	Dec	*)	

**C-axis controller settings** (refer to Instruction Manual 6SC6501-0AC00)

P-103	Center frequency ( $n_{act}$ filter)	30 - 100	Hz	50	
P-104	Filter quality	0 - 6	Dec	3	
P-105	P component (C axis actual value)	0 - 120,0	Dec	64,0	
P-106	I component (C axis actual value)	0 - 6000	ms	32	
P-107	Changeover speed, C axis	0 - 400	RPM	93	
P-108	Changeover speed, actual value	0 - 50	RPM	46	
P-109	Switching parameter, C axis	0 0 0 0 - F F F F	Hex	0 0 0 0	
P-110 **)	Encoder adaption factor, C axis sin/cos	0 0 0 0 - F F F F	Hex	0 8 E 3	
P-111	P component (normalized act. value)	0 - 120,0	Dec	32,0	
P-112	I component (normalized act. value)	0 - 6000	ms	128	
P-113	Speed setpoint, channel selection	0 - 3	Dec	3	
P-114	Normalization, $n_{set}$ (gearbox stage 1)	- 200,0 - + 250,0	%	100,0	
P-115 **)	P component, current controller	0,01 - 1,00	Dec	0,36	
P-116 **)	I component, current controller	0 0 0 0 - F F F F	Hex	1 0 0 0	
P-117	Activate the $n_{act}$ filter	0 0 0 0 - F F F F	Hex	0 0 0 0	
P-118 **)	Encoder adaption factor	0 0 0 0 - F F F F	Hex	0 8 5 8	
P-119 **)	Flux adaption factor	10 - 100	%	100	
P-149	Start-up parameter	0 0 0 0 - F F F F	Hex	0 0 0 0	
P-157	Normalization, $n_{set}$ (gearbox stage 2)	- 200,0 - + 250,0	%	100,0	
P-158	Normalization, $n_{set}$ (gearbox stage 3)	- 200,0 - + 250,0	%	100,0	
P-159	$K_V$ factor, "holding brake"	0 0 0 0 - F F F F	Hex	0 0 0 A	
P-195	Computation time, C-axis mode	0 0 0 0 - F F F F	Hex	0 6 D 6	
P-239	$M_d$ limit, C axis	0 - 200,0	%	100,0	

\*) Dependent on the software release

\*\*) After setting and transfer into the EEPROM (P-52):

Switch-off the unit and after the 7-segment display has disappeared, switch-on again, only then are the changed values transferred.

Parameter	Significance	Setting range	Dimension	Factory setting	Setting
<b>Positioning settings</b> (refer to Instruction Manual 6SC6501-0AD00)					
P-121	Setpoint 1 for gearbox stage 1	0 - 64000	Dec	0	
P-122	Setpoint 1 for gearbox stage 2	0 - 64000	Dec	0	
P-123	Setpoint 1 for gearbox stage 3	0 - 64000	Dec	0	
P-124	Setpoint 1 for gearbox stage 4	0 - 64000	Dec	0	
P-125	Setpoint 2	0 - 64000	Dec	0	
P-126	Cut-in point, re-enabling the I component of the speed controller	2,0 - 360,0	Degree	10,0	
P-127	Setpoint in increments	- 32767 - + 32767	Dec	256	
P-129	Internal zero mark	0 0 0 0 - F F F F	Hex	0 0 0 0	
P-130	Internal zero mark	0 - 64000	Dec	0	
P-131	Maximum pulse number between two zero marks for gearbox stage 1	0 - 64000	Dec	4096	
P-132	Maximum pulse number between two zero marks for gearbox stage 2	0 - 64000	Dec	4096	
P-133	Maximum pulse number between two zero marks for gearbox stage 3	0 - 64000	Dec	4096	
P-134	Maximum pulse number between two zero marks for gearbox stage 4	0 - 64000	Dec	4096	
P-135	Cut-in point, $K_V$ factor 1	0,2 - 180,0	Degree	10,0	
P-136	Cut-in point, $K_V$ factor 2	0,2 - 180,0	Degree	2,0	
P-137	$K_V$ factor 1 (dep. on enc. pulse No.)	0 0 0 0 - F F F F	Hex	0 1 0 0	
P-138	$K_V$ factor 2 (dep. on enc. pulse No.)	0 0 0 0 - F F F F	Hex	0 1 0 0	
P-139	Multiplier for braking parabola	0 0 0 0 - F F F F	Hex	0 1 0 0	
P-141 *)	Switching parameter	0 0 0 0 - F F F F	Hex	0 0 0 1	
P-142	Flag for speed increase	0 0 0 0 - F F F F	Hex	0 0 0 0	
(P-143)	Zero mark identification bandwidth	180,0 - 350,0	Degree	**)	
P-144	Response bandwidth, relay 1	0 - 18,00	Degree	1,00	
P-145	Response bandwidth, relay 2	0 - 18,00	Degree	5,00	
P-146	Search speed 1	- 4000 - + 4000	RPM	375	
P-147	Search speed 2	- 4000 - + 4000	RPM	375	
P-148	Search speed 3	- 4000 - + 4000	RPM	375	

\*) After setting and transfer into the EEPROM (P-52):

Switch-off the unit and after the 7-segment display has disappeared, switch-on again, only then are the changed values transferred.

\*\*) Internally calculated from software release 12 onwards.

Parameter	Significance	Setting range	Dimensions	Factory setting	Setting
-----------	--------------	---------------	------------	-----------------	---------

**Positioning settings** (refer to Instruction Manual 6SC6501-0AD00) (continued)

P-149	Start-up parameters	0 0 0 0 - F F F F	Hex	0 0 0 0	
P-150	Search speed	- 4000 - + 4000	RPM	375	
P-249	Cancellation window of the compulsory direction of rotation (A74)	0 0 0 0 - F F F F	Hex	0 0 0 A	

**Oscillation mode settings** (refer to Section 3.3.19)

P-154	Oscillation setpoint 1	0 0 0 0 - F F F F	Hex	0 0 1 4	
P-155	Oscillation setpoint 2	0 0 0 0 - F F F F	Hex	F F E C	
P-156	Oscillation interval time	0.10 - 60.00	s	0.20	

**Motor data** (refer to Section 3.3.20)

P-160 *)	Rated output	0 - 100.00	kW	**)	
P-161 *)	Rated current	0 - 200.0	A	**)	
P-162 *)	Rated voltage	100 - 431	V	**)	
P-163 *)	Rated speed	100 - 6000	RPM	**)	
P-164 *)	Rated frequency	10.0 - 120.0	Hz	**)	
P-165 *)	No-load voltage	100 - 430	V	**)	
P-166 *)	No-load current	0.0 - 100.0	A	**)	
P-167 *)	Stator resistance, cold	0 - 10000	mΩ	**)	
P-168 *)	Rotor resistance, cold	0 - 10000	mΩ	**)	
P-169 *)	Stator leakage reactance	0 - 10000	mΩ	**)	
P-170 *)	Rotor leakage reactance	10 - 10000	mΩ	**)	
P-171 *)	Main field reactance	1000 - 32767	mΩ	**)	
P-172 *)	First transition frequency	10.0 - 125.0	Hz	**)	
P-173 *)	Second transition frequency	50.0 - 125.0	Hz	**)	
P-174 *)	Maximum speed	100 - 20000	RPM	**)	
P-175 *)	Maximum motor temperature	0 - 200	°C	**)	
P-176 *) ***)	Speed cut-in point for M <sub>d</sub> reduction due to stability limit	0 - 10000	RPM	**)	
P-180	Flux reduction	25 - 100	%	100	

**U/f open-loop control** (refer to Section 4.7.6)

P-184 *)	U/f open-loop control	0 0 0 0 - F F F F	Hex	0 0 0 0	
----------	-----------------------	-------------------	-----	---------	--

- \*) Can only be changed, if P-51 is set to 0 0 1 0 H  
 \*\*) Dependent on the motor type (from software release 12)  
 \*\*\*) After setting and transfer into the EEPROM (P-52):  
 Switch-off the unit and after the 7-segment display has been cancelled, switch-on again, only then are the changed values transferred.

Parameter	Significance	Setting range	Dimensions	Factory setting	Setting
-----------	--------------	---------------	------------	-----------------	---------

**Selectable relay function** (refer to Section 3.3.21)

P-185	Select memory address	0 0 0 0 - F F F F	Hex	0 5 F E	
P-186	Response value	0 0 0 0 - F F F F	Hex	0 2 0 0	
P-187	Pull-in delay	0.01 - 10.00	s	0.40	
P-188	Drop-out delay	0.01 - 10.00	s	0.40	
P-189	Response value hysteresis	0 0 0 0 - F F F F	Hex	0 0 1 0	

**Pre-control** (refer to Section 3.3.22)

P-190	Pre-control DC link control	0.1 - 10.0	Dec	5.0	
-------	--------------------------------	------------	-----	-----	--

**Damping element** (refer to Section 3.3.23)

P-196	Control flag for damping element	0 0 0 0 - 0 1 0 0	Hex	0 0 0 0	
P-197	Resonant frequency	50.0 - 100.0	Hz	96.0	
P-198	Damping constant	0.01 - 0.38	1	0.37	

**Motor data, delta connection** (refer to Section 3.3.24)

P-220	Rated output	0 - 100.00	kW	0	
P-221	Rated current	1.0 - 200.0	A	0	
P-222	Rated voltage	10 - 431	V	0	
P-223	Rated speed	100 - 6000	RPM	0	
P-224	Rated frequency	10.0 - 120.0	Hz	0	
P-225	No-load voltage	216 - 431	V	0	
P-226	No-load current	0.0 - 100.0	A	0	
P-227	Stator resistance, cold	0 - 10000	mΩ	0	
P-228	Rotor resistance, cold	0 - 10000	mΩ	0	
P-229	Stator leakage reactance	0 - 10000	mΩ	0	
P-230	Rotor leakage reactance	10 - 10000	mΩ	0	
P-231	Main field reactance	1000 - 32767	mΩ	0	
P-232	First transition frequency	10 - 125.0	Hz	0	
P-233	Second transition frequency	50.0 - 125.0	Hz	0	
P-234	Maximum speed	100 - 20000	RPM	0	
P-235	Free				
P-236	Speed cut-in point for $M_d$ reduction due to stability limit	100 - 20000	RPM	0	

Parameter	Significance	Setting range	Dimensions	Factory setting	Setting
<b>Assignment of the relay functions (refer to Section 3.3.25)</b>					
P-241	Relay, terminals 108 - 110 ( $M_d > M_{dx}$ )	0 0 0 0 - 0 4 0 0	Hex	0 0 2 0	
P-242	Relay, terminals 214 - 216 ( $n_{act} < n_x$ )	0 0 0 0 - 0 4 0 0	Hex	0 0 4 0	
P-243	Relay, terminals 114 - 116 ( $n_{act} < n_{min}$ )	0 0 0 0 - 0 4 0 0	Hex	0 0 0 8	
<b>P gain, synchronization controller (refer to Section 3.3.26)</b>					
P-252	P gain, synchronization controller	1 - 4	Dec	3	

## 6.9 ECB instructions

### Components which can be destroyed by electrostatic discharge (ECB)

Generally, electronic boards should only be touched when absolutely necessary.

The human body must be electrically discharged before touching an electronic board. This can be simply done by touching a conductive, grounded object directly beforehand (e.g. bare metal cubicle components, socket outlet protective conductor contact).

Boards must not come into contact with highly-insulating materials - e.g. plastic foils, insulated desktops, articles of clothing manufactured from man-made fibers.

Boards must only be placed on conductive surfaces.

When soldering, the soldering iron tip must be grounded.

Boards and components should only be stored and transported in conductive packaging (e.g. metalized plastic boxes, metal containers).

If the packing material is not conductive, the boards must be wrapped with a conductive packing material, e.g. conductive foam rubber or household aluminum foil.

The necessary ECB protective measures are clearly shown in the following diagram.

- |                              |                               |
|------------------------------|-------------------------------|
| a = Conductive floor surface | d = ECB overall               |
| b = ECB table                | e = ECB chain                 |
| c = ECB shoes                | f = Cubicle ground connection |

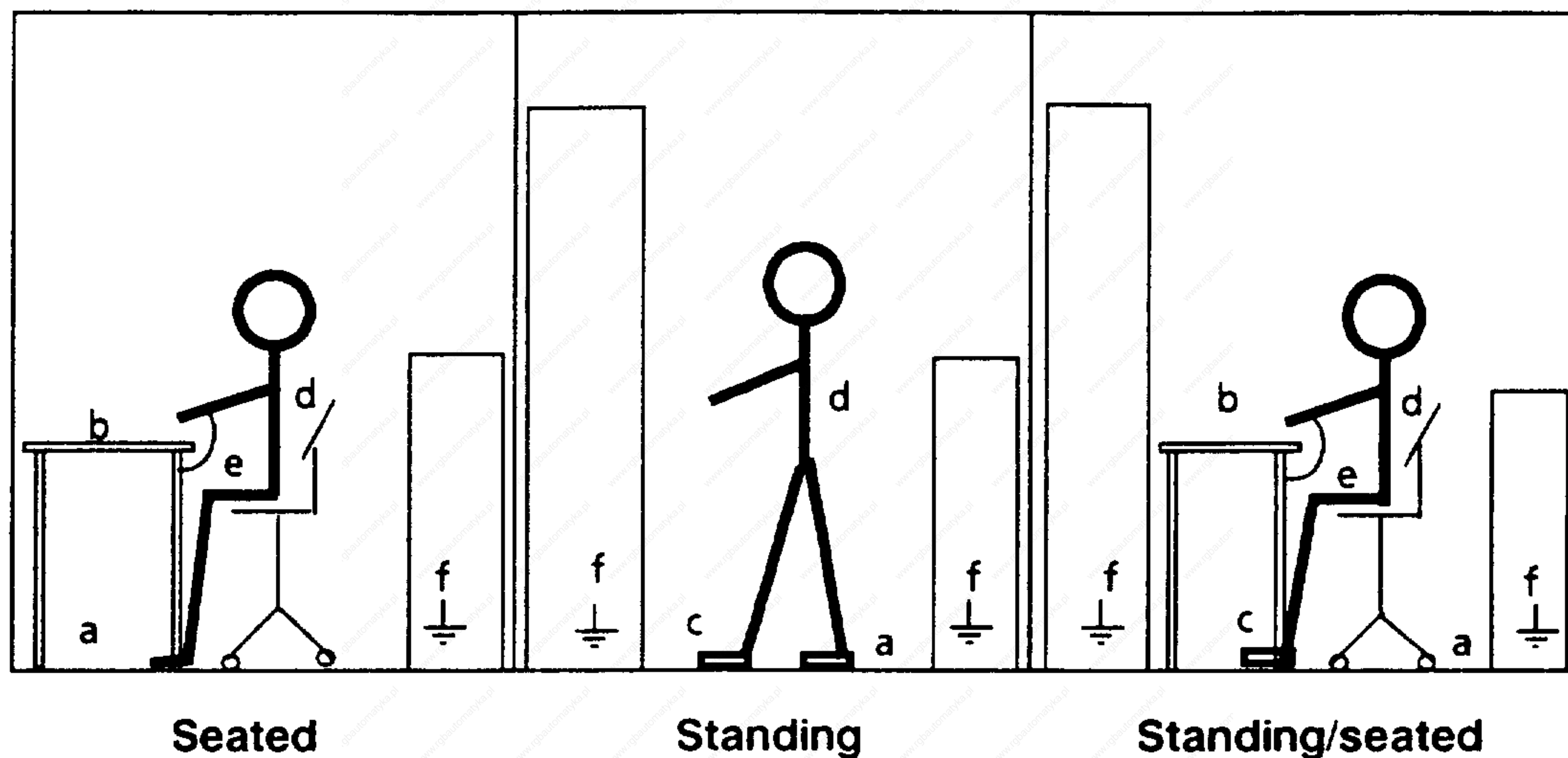

## 6.10 Standards and specifications

DIN VDE 0100	Specifications for installing power equipment with voltages up to 1000 V
DIN VDE 0106	Protection against electric shock
DIN VDE 0113	Electrical equipment on industrial machines
DIN VDE 0160	Specifications for equipping power systems with electronic equipment
DIN VDE 0558	VDE specifications for semiconductor converters

Can be obtained from: DIN:    DIN VDE:

Beuth-Verlag GmbH  
Postfach 1145 Merianstraße 29  
1000 Berlin 30

VDE-Auslieferungsstelle  
(document supply)  
6050 Offenbach

Siemens AG

AUT E234  
Postfach 4848  
W-8500 Nürnberg 1  
Federal Republic of Germany

**Suggestions**

**Corrections**

concerning booklet:  
SIMODRIVE 6SC65..  
Instructions  
Order No.:  
6SC6501-0AA76

Sender:

Name .....

Firm/Department .....

Address .....

Telephone .....

If you have discovered any printing errors when reading this document, please send us details using this printed form. We would also be very grateful for any ideas and suggestions for improvement.

Suggestions and/or corrections:





Published by Siemens AG  
Automation Group  
Automation Systems for  
Machine Tools, Robots, and  
Special-Purpose Machines  
Postfach 48 48, W-8500 Nürnberg 1  
Federal Republic of Germany

© Siemens AG 1988 All Rights Reserved  
Subject to change without prior notice

Siemens Aktiengesellschaft

Order No.: 6SC6501-0AA76  
Printed in the Fed. Rep. of Germany  
01921.0 GWE 462 500.9600.76 Jg-101



Progress  
in Automation.  
Siemens