

# Electromagnetic Flowmeters

SITRANS F M MAG 5000/6000

Operating Instructions • 01/2010



## SITRANS F

## SIEMENS



# SIEMENS

## SITRANS F

### Flowmeters

### SITRANS F M MAG 5000/6000

#### Operating Instructions

<u>Introduction</u>	<b>1</b>
<u>Safety notes</u>	<b>2</b>
<u>Description</u>	<b>3</b>
<u>Installing/Mounting</u>	<b>4</b>
<u>Connecting</u>	<b>5</b>
<u>Commissioning</u>	<b>6</b>
<u>Service and maintenance</u>	<b>7</b>
<u>Functions</u>	<b>8</b>
<u>Alarm, error, and system messages</u>	<b>9</b>
<u>Troubleshooting/FAQs</u>	<b>10</b>
<u>Technical data</u>	<b>11</b>
<u>Spare parts/Accessories</u>	<b>12</b>
<u>Menu diagrams</u>	<b>A</b>
<u>Appendix</u>	<b>B</b>

Electromagnetic flow transmitter designed for use with  
flow sensor types  
MAG 1100/1100 F/3100/3100 P/5100 W  
Compact and remote installation

## Legal information

### Warning notice system

This manual contains notices you have to observe in order to ensure your personal safety, as well as to prevent damage to property. The notices referring to your personal safety are highlighted in the manual by a safety alert symbol, notices referring only to property damage have no safety alert symbol. These notices shown below are graded according to the degree of danger.

<b>⚠ DANGER</b>
indicates that death or severe personal injury <b>will</b> result if proper precautions are not taken.
<b>⚠ WARNING</b>
indicates that death or severe personal injury <b>may</b> result if proper precautions are not taken.
<b>⚠ CAUTION</b>
with a safety alert symbol, indicates that minor personal injury can result if proper precautions are not taken.
<b>CAUTION</b>
without a safety alert symbol, indicates that property damage can result if proper precautions are not taken.
<b>NOTICE</b>
indicates that an unintended result or situation can occur if the corresponding information is not taken into account.

If more than one degree of danger is present, the warning notice representing the highest degree of danger will be used. A notice warning of injury to persons with a safety alert symbol may also include a warning relating to property damage.

### Qualified Personnel

The product/system described in this documentation may be operated only by **personnel qualified** for the specific task in accordance with the relevant documentation for the specific task, in particular its warning notices and safety instructions. Qualified personnel are those who, based on their training and experience, are capable of identifying risks and avoiding potential hazards when working with these products/systems.

### Proper use of Siemens products

Note the following:

<b>⚠ WARNING</b>
Siemens products may only be used for the applications described in the catalog and in the relevant technical documentation. If products and components from other manufacturers are used, these must be recommended or approved by Siemens. Proper transport, storage, installation, assembly, commissioning, operation and maintenance are required to ensure that the products operate safely and without any problems. The permissible ambient conditions must be adhered to. The information in the relevant documentation must be observed.

### Trademarks

All names identified by ® are registered trademarks of the Siemens AG. The remaining trademarks in this publication may be trademarks whose use by third parties for their own purposes could violate the rights of the owner.

### Disclaimer of Liability

We have reviewed the contents of this publication to ensure consistency with the hardware and software described. Since variance cannot be precluded entirely, we cannot guarantee full consistency. However, the information in this publication is reviewed regularly and any necessary corrections are included in subsequent editions.

# Table of contents

<b>1</b>	<b>Introduction.....</b>	<b>7</b>
1.1	Preface.....	7
1.2	Items supplied.....	7
1.3	History.....	8
1.4	Further Information.....	9
<b>2</b>	<b>Safety notes.....</b>	<b>11</b>
2.1	Laws and directives.....	11
2.2	Installation in hazardous location.....	12
<b>3</b>	<b>Description.....</b>	<b>13</b>
3.1	System components.....	13
3.2	Operating principle.....	13
3.3	Applications.....	13
3.4	Features.....	14
3.5	MAG 5000/MAG 6000 versions.....	15
<b>4</b>	<b>Installing/Mounting.....</b>	<b>17</b>
4.1	Installation conditions.....	18
4.2	MAG 5000/6000 compact.....	20
4.3	Remote installation.....	22
4.4	MAG 5000/6000 CT.....	27
4.4.1	Installing hardware key.....	27
4.4.2	Seal device.....	28
4.5	Turning transmitter/keypad.....	29
<b>5</b>	<b>Connecting.....</b>	<b>33</b>
5.1	Electrical connection.....	34
5.2	Connection of add-on modules.....	35
<b>6</b>	<b>Commissioning.....</b>	<b>37</b>
6.1	MAG 5000/6000 Blind.....	37
6.2	Local user interface.....	38
6.3	Menu structure.....	39
6.4	Changing password.....	40
6.5	Changing basic settings.....	40
6.6	Changing operator menu setup.....	42
6.7	Changing language.....	43

<b>7</b>	<b>Service and maintenance .....</b>	<b>45</b>
7.1	Transmitter check list .....	45
7.2	Technical support.....	46
7.3	Return procedures .....	48
7.4	Recalibration .....	48
<b>8</b>	<b>Functions.....</b>	<b>49</b>
8.1	Output settings .....	49
8.2	External input .....	50
8.3	Sensor characteristics.....	51
8.4	Reset mode .....	52
8.5	Service mode .....	53
8.6	MAG 5000 CT and MAG 6000 CT settings.....	53
8.7	MAG 6000 SV .....	54
<b>9</b>	<b>Alarm, error, and system messages .....</b>	<b>55</b>
9.1	Diagnostics.....	55
9.2	List of error numbers .....	57
<b>10</b>	<b>Troubleshooting/FAQs.....</b>	<b>59</b>
<b>11</b>	<b>Technical data .....</b>	<b>61</b>
11.1	Technical specifications .....	61
11.2	Accuracy.....	64
11.3	Output characteristics .....	66
11.4	Cable data .....	68
11.5	Cable requirements.....	68
<b>12</b>	<b>Spare parts/Accessories.....</b>	<b>69</b>
12.1	Ordering .....	69
12.2	Accessories .....	69
12.3	Spare parts.....	70
12.4	Sun shield.....	71
<b>A</b>	<b>Menu diagrams.....</b>	<b>73</b>
A.1	Overview MAG 5000/6000.....	73
A.2	Overview MAG 5000/6000 CT .....	75
A.3	Change password .....	76
A.4	Basic settings .....	77
A.5	Operator menu setup .....	78
A.6	Language mode .....	79
A.7	Current output .....	79

A.8	Digital output - pulse .....	79
A.9	Digital output - frequency .....	80
A.10	Error level.....	80
A.11	Error number .....	80
A.12	Direction/limit.....	81
A.13	Batch .....	82
A.14	Cleaning .....	82
A.15	External input .....	83
A.16	Sensor characteristics.....	84
A.17	Reset mode.....	85
A.18	Reset mode - MAG 6000 SV .....	86
A.19	Service mode .....	87
A.20	Product identity .....	88
A.21	HART module.....	89
<b>B</b>	<b>Appendix.....</b>	<b>91</b>
B.1	Factory settings.....	91
B.2	Sensor dependent factory settings for MAG 5000/6000 Blind.....	93
B.3	Approvals/certificates .....	94
B.3.1	Certificates .....	94
	<b>Index.....</b>	<b>95</b>



# Introduction

## 1.1 Preface

These instructions contain all the information you need for using the device.

The instructions are aimed at persons mechanically installing the device, connecting it electronically, configuring the parameters and commissioning it as well as service and maintenance engineers.

---

### Note

It is the responsibility of the customer that the instructions and directions provided in the manual are read, understood and followed by the relevant personnel before installing the device.

---

## 1.2 Items supplied

- SITRANS F M MAG 5000/6000 transmitter
- Calibration report
- SITRANS F literature CD
- Quick start guide

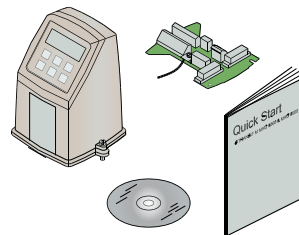

## Inspection

1. Check for mechanical damage due to possible improper handling during shipment. All claims for damage are to be made promptly to the shipper.
2. Make sure the scope of delivery, and the information on the type plate corresponds to the ordering information

Device identification

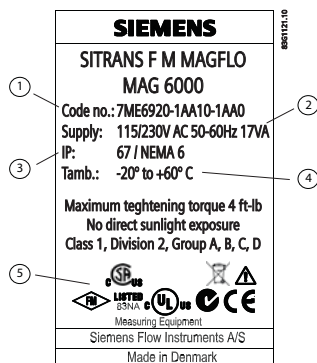

- ① Code number
- ② Power supply
- ③ Enclosure rating
- ④ Ambient temperature
- ⑤ Approvals

Figure 1-1 MAG 5000/6000 type plate

1.3 History

This document describes:

- SITRANS F MAG 5000 and MAG 6000 transmitters (standard version).
- Optional versions:
  - MAG 5000 Blind and MAG 6000 Blind
  - MAG 5000 CT and MAG 6000 CT
  - MAG 6000 SV

Documentation history

The contents of these instructions are regularly reviewed and corrections are included in subsequent editions. We welcome all suggestions for improvement.

The following table shows the most important changes in the documentation compared to each previous edition.

Edition	Remarks
01 01/2010	First edition

## **1.4 Further Information**

The contents of these Operating Instructions shall not become part of or modify any prior or existing agreement, commitment or legal relationship. All obligations on the part of Siemens AG are contained in the respective sales contract which also contains the complete and solely applicable warranty conditions. Any statements contained herein do not create new warranties or modify the existing warranty.

### **Product information on the Internet**

The Operating Instructions are available on the CD-ROM shipped with the device, and on the Internet on the Siemens homepage, where further information on the range of SITRANS F flowmeters may also be found:

Product information on the internet (<http://www.siemens.com/flowdocumentation>)

### **Worldwide contact person**

If you need more information or have particular problems not covered sufficiently by the operating instructions, please get in touch with your contact person. You can find contact information for your local contact person on the Internet:

Local contact person (<http://www.automation.siemens.com/partner>)



## Safety notes

** CAUTION**

Correct, reliable operation of the product requires proper transport, storage, positioning and assembly as well as careful operation and maintenance. Only qualified personnel should install or operate this instrument.

**Note**

Alterations to the product, including opening or improper repairs of the product, are not permitted.

If this requirement is not observed, the CE mark and the manufacturer's warranty will expire.

## 2.1 Laws and directives

### General requirements

Installation of the equipment must comply with national regulations. For example EN 60079-14 for the European Community.

### Instrument safety standards

The device has been tested at the factory, based on the safety requirements. In order to maintain this condition over the expected life of the device the requirements described in these Operating Instructions must be observed.

### CE marked equipment

The CE-mark symbolizes the compliance of the device with the following guidelines:

- EMC-guideline 89/336/EEC
- Low voltage guideline 73/23/EWG
- ATEX Directive 94/9/EG
- CT: (MI-001) Directive 2004/22/EC

## 2.2 Installation in hazardous location

 <b>WARNING</b>
Equipment used in hazardous areas must be Ex-approved and marked accordingly. It is required that the special conditions for safe use provided in the manual and in the Ex certificate are followed!

### Ex approvals

CSA Class I, Division 2, Groups A, B, C and D. Code T5 for an ambient temperature of +60°C.

FM Class I, Division 2, Groups A, B, C and D and Class I, Zone 2, Group IIC indoor/outdoor Type IP67 hazardous (classified) locations

### Temperature specifications for Ex use

Temperature class	Ambient temperature [°C]		
	-40...+40	-40...+50	-40...+60
T2	180 (process temperature)	-	-
T3	165 (process temperature)	140 (process temperature)	-
T4	100 (process temperature)	100 (process temperature)	80 (process temperature)
T5	65 (process temperature)	65 (process temperature)	65 (process temperature)
T6	50 (process temperature)	50 (process temperature)	50 (process temperature)

### EX requirements

It is required that:

- Electrical connections are in accordance with Elex V (VO in explosion hazardous areas) and EN60079-14 (Installing Electrical Systems in Explosion Hazardous Areas).
- The protective cover over the power supply is properly installed. For intrinsically safe circuits the connection area can be opened.
- Appropriate cable connectors are used for the output circuits: intrinsically safe: blue, non-intrinsically safe: black
- Sensor and transmitter are connected to the potential equalization. For intrinsically safe output circuits potential equalization must be maintained along the entire connection path.
- Sensor insulation thickness is max. 100mm (only insulated sensors).
- EN50281-1-2 is considered for installation in areas with combustible dust.
- When protective earth (PE) is connected, no potential difference between the protective earth (PE) and the potential equalization (PA) can exist, even during a fault condition.

## Description

### 3.1 System components

A SITRANS F M MAG 5000/6000 flowmeter system includes:

- Transmitter (type SITRANS F M MAG 5000/6000)
- Sensor (types: SITRANS F MAG 1100/1100F/3100/3100 P/5100 W)
- Communication module (optional) (types: HART, PROFIBUS PA/DP, MODBUS RTU RS 485, Foundation Fieldbus H1, Devicenet)
- SENSORPROM memory unit

#### Communication solutions

The SITRANS F USM II range of add on modules, presently including HART, Foundation Fieldbus, MODBUS RTU RS 485, PROFIBUS PA / DP and Devicenet, are all applicable with the SITRANS F M MAG 6000 transmitter.

### 3.2 Operating principle

The transmitters are microprocessor-based with a built-in alphanumeric display in several languages. The flow measuring principle is based on Faraday's law of electromagnetic induction. Magnet coils mounted diametrically on the measuring pipe generate a pulsed electromagnetic field. The liquid flowing through this electromagnetic field induces a voltage.

The transmitters evaluate the signals from the associated electromagnetic sensors, convert the signals into appropriate standard signals such as 4 ... 20 mA, and also fulfil the task of a power supply unit providing the magnet coils with a constant current.

The transmitter consists of a number of function blocks which convert the sensor voltage into flow readings.

### 3.3 Applications

The DC-powered magnetic flowmeters are suitable for measuring the flow of almost all electrically conductive liquids, pastes, and slurries with max. 40% solids. The main applications can be found in the following sectors:

- Water and waste water
- Chemical and pharmaceutical industries
- Food & beverage industry
- Mining, aggregates and cements industries
- Pulp and paper industry
- Steel industry
- Power generation; utility and chilled water industry

## 3.4 Features

### Power supply

2 different types of power supply are available. A 12 ... 24 V AC/DC and a 115 ... 230 V AC switch mode type.

Coil current module generates a pulsating magnetizing current that drives the coils in the sensor. The current is permanently monitored and corrected. Errors or cable faults are registered by the self-monitoring circuit.

Input circuit amplifies the flow-proportional signal from the electrodes. The input impedance is extremely high:  $>10^{14} \Omega$  which allows flow measurements on fluids with conductivities as low as  $5 \mu\text{S/cm}$ . Measuring errors due to cable capacitance are eliminated due to active cable screening.

Digital signal processor converts the analog flow signal to a digital signal and suppresses electrode noise through a digital filter. Inaccuracies in the transmitter as a result of long-term drift and temperature drift are monitored and continuously compensated for via the self-monitoring circuit. The analog to digital conversion takes place in an ultra low noise ASIC with 23 bit signal resolution. This has eliminated the need for range switching. The dynamic range of the transmitter is therefore unsurpassed with a turn down ratio of minimum 3000:1.

### CAN communication

The transmitter operates internally via an internal CAN communication bus. Signals are transferred through a signal conditioner to the display module and to/from internal/external option modules and the dialog module.

### Dialog module

The display unit consists of a 3-line display and a 6-key keypad. The display shows a flow rate or a totalizer value as a primary reading.

### Output module

The output module converts flow data to analog, digital and relay outputs. The outputs are galvanically isolated and can be individually set to suit a particular application.

## 3.5 MAG 5000/MAG 6000 versions

The transmitters are designed in various versions and offer high performance and easy installation, commissioning and maintenance.

### Standard version



The standard version is an IP67 version for compact or remote installation. Its robust design ensures a long lifetime if installed outdoors.

### Blind version



This version carries all the normal MAG 5000/6000 features, except those associated with the display and keypad.

Both current and digital outputs are available.

Factory setting of current output in unit is switched off when delivered.

### CT version



The MAG 5000/6000 CT version is a custody transfer-approved transmitter.

It is approved according to:

- Cold water pattern approval (MAG 5000/6000 CT):
  - PTB
  - OIML R 49
- Cold water pattern approval (MAG 6000 CT only):
  - MI-001
- Hot water pattern approval (MAG 6000 CT only):
  - PTB
- Heat meter pattern approval (MAG 6000 CT only):
  - OIML R 75
- Other media than water (MAG 6000 CT only):
  - OIML R 117

### SV version (MAG 6000 only)



This version is identical to the standard MAG 6000 transmitters except for the following additional functions:

- Zero point adjustment
- Adjustable excitation frequency up to 44 Hz

*Description*

---

*3.5 MAG 5000/MAG 6000 versions*

## Installing/Mounting

This chapter describes how to install the flowmeter in the compact version as well as in the remote version.

The transmitter is delivered ready for mounting on the sensor. The transmitter is delivered with a compression plate ready for mounting on the sensor. No further assembling is necessary.

The transmitter can be installed either compact on the sensor or remote.

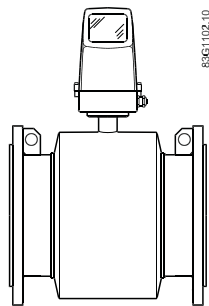

Figure 4-1 Compact installation

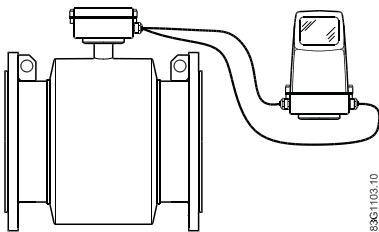

Figure 4-2 Remote installation

**⚠ CAUTION**

See Cable requirements (Page 68) before installing transmitter

### 4.1 Installation conditions

Reading and operating the flowmeter is possible under almost any installation conditions because the display can be oriented in relation to the sensor. To ensure optimum flow measurement, attention should be paid to the following:

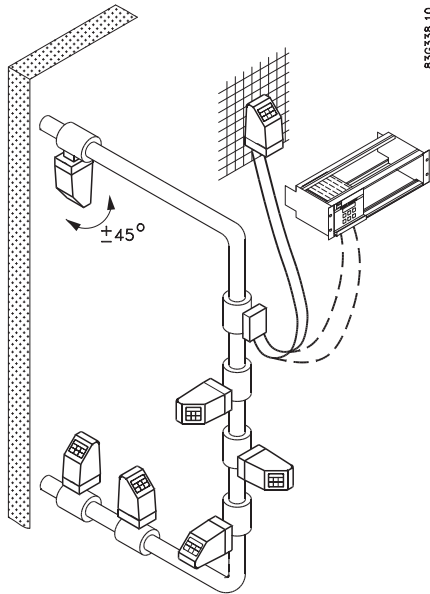

### Vibrations

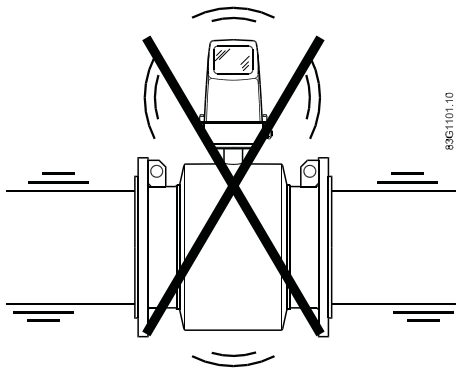
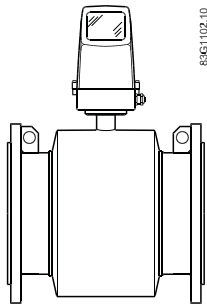

Figure 4-3 Avoid strong vibrations

### Compact installation



Medium temperature must be in accordance with the graphs showing max. ambient temperature as a function of medium temperature.

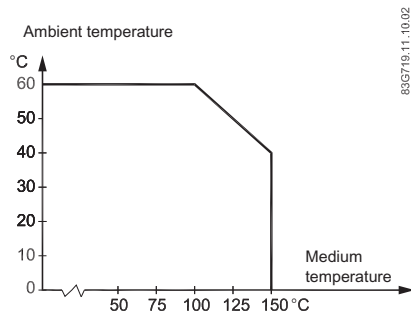

Figure 4-4 Standard, blind and SV versions

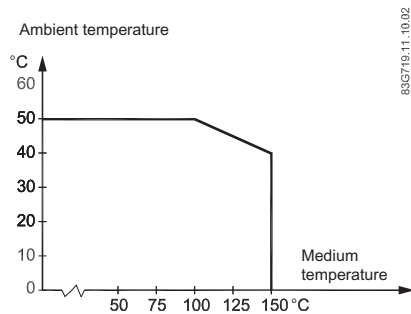
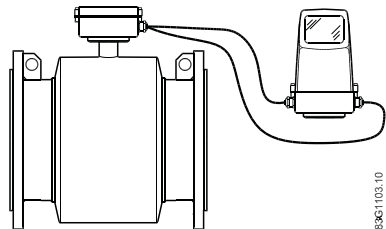

Figure 4-5 CT version

### Remote installation



Cable length and type (as described in Cable requirements) must be used.

For installation conditions for sensors, see respective sensor operating instructions.

## 4.2 MAG 5000/6000 compact

### Install MAG 5000 / MAG 6000 compact version

1. Remove and discard terminal box lid of sensor.

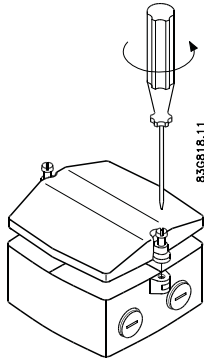

2. Ensure SENSORPROM® memory unit is installed.
3. Fit M20 or ½" NPT cable glands for supply and output cables.
4. Unplug the two black plug assemblies for coil and electrode cables in terminal box.
5. Connect earth wire from connection board to bottom of terminal box.
6. Connect 2-pin connector and 3-pin connector as shown to their corresponding terminal numbers on connection board as shown in Electrical connection (Page 34).

---

#### Note

System will not register flow if black plugs are not connected to connection board

---

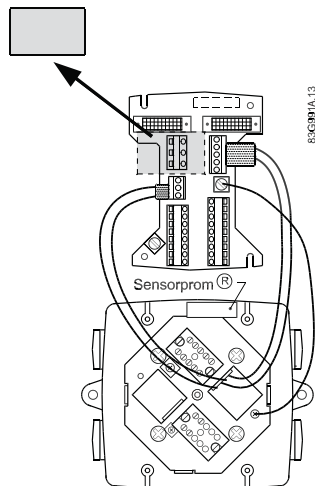

7. Fit supply and output cables through cable glands and connect to connection plate as shown in Electrical connection (Page 34).

8. Mount connection plate in terminal box.

**Note**

Check that your connection board lines up with SENSORPROM® unit, if not, move SENSORPROM® unit to the other side of terminal box.

SENSORPROM® memory unit connections will be established automatically when connection plate is mounted in terminal box.

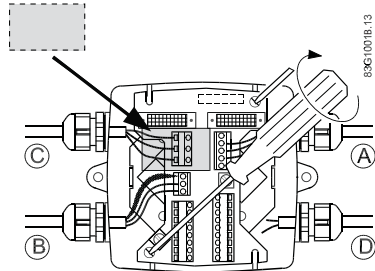

9. Tighten cable glands to obtain optimum sealing.
10. Mount transmitter on terminal box.

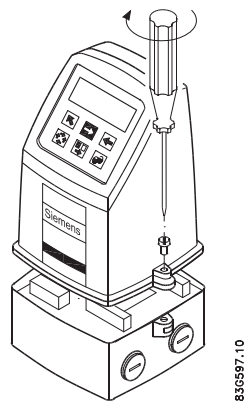

11. Transmitter is ready to be powered up.

**CAUTION**

Exposing transmitter to direct sunlight may increase operating temperature above its specified limit, and decrease display visibility.

A sunshield is available as accessory.

## 4.3 Remote installation

### At sensor

1. Remove terminal box lid.

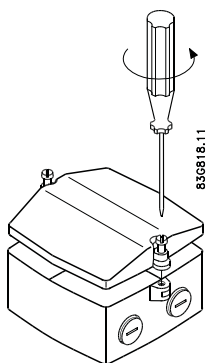

2. Remove SENSORPROM® unit from sensor terminal box and mount it in terminal box of wall mounting unit.

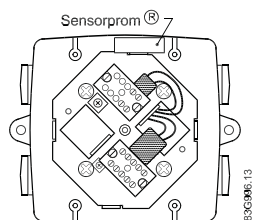

3. Fit M20 or 1/2" NPT cable glands for cables.

4. Fit and connect electrode (1) and coil (2) cables as shown in Electrical connection (Page 34).

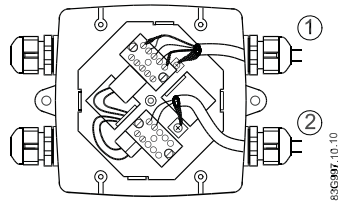

**Note**

Unscreened cable ends must be kept as short as possible.  
Electrode cable and coil cable must be kept separate to prevent interference.

5. Tighten cable glands well to obtain optimum sealing.

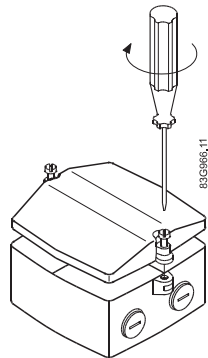

 <b>WARNING</b>
Mount terminal box lid before power up.

Wall mounting

1. Mount bracket on a wall or on a horizontal or a vertical pipe using ordinary hose clips or duct straps.

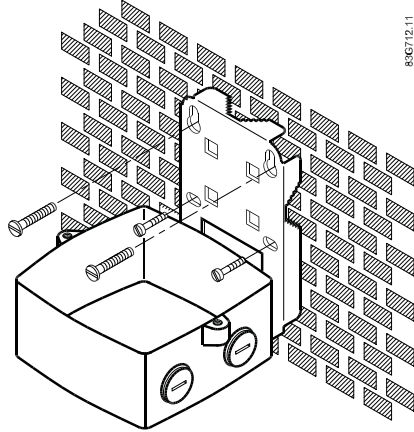

Figure 4-6 Wall mounting

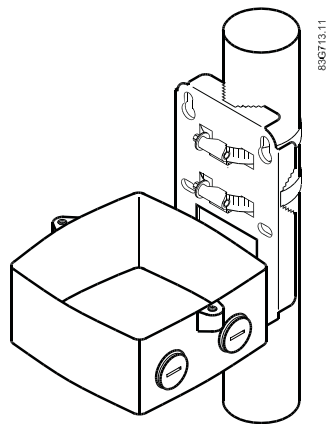

Figure 4-7 Pipe mounting - vertical

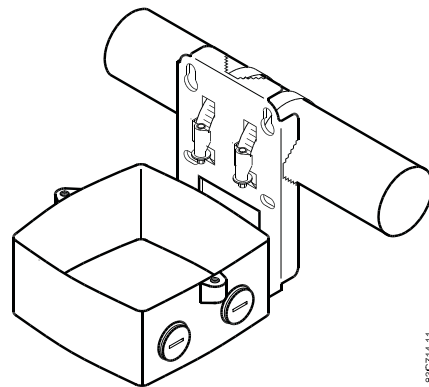
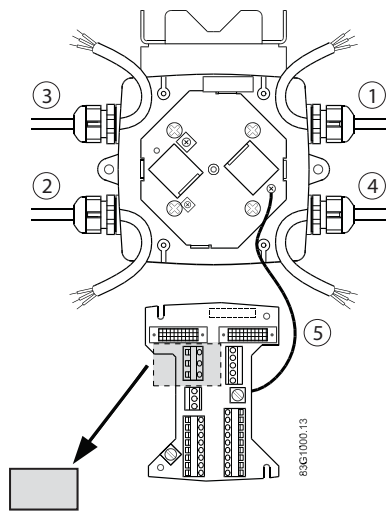

Figure 4-8 Pipe mounting - horizontal

2. Ensure that correct SENSORPROM® memory unit is mounted in wall/pipe mounting unit.
3. Fit M20 or ½" NPT cable glands for cables from bottom or sides of terminal box.

4. Mount earth wire in bottom of terminal box.



- 1 Connect electrode cable
- 2 Connect coil cable - keep separate from electrode cable
- 3 Connect power supply
- 4 Connect output cable
- 5 Connect PE (ground) wire

1. Mount connection plate in terminal box.

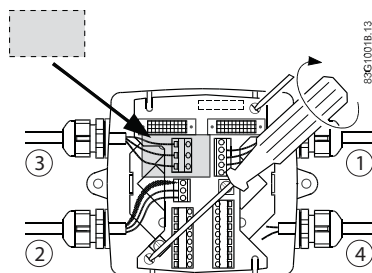

- 1 Electrode cable
- 2 Coil cable
- 3 Power supply
- 4 Output cable

1. Fit coil, electrode, supply and output cables through cable glands and connect to connection plate as shown in Electrical connection (Page 34).
2. Fix connection plate with the two diagonally opposite screws.
3. Tighten cable glands to obtain optimum sealing.

**⚠ CAUTION**

When remote mounted, power supply PE wire must be connected to PE terminal (⊕).  
Coil cable shield must be connected to SHIELD terminal.

4. Mount transmitter on terminal box.

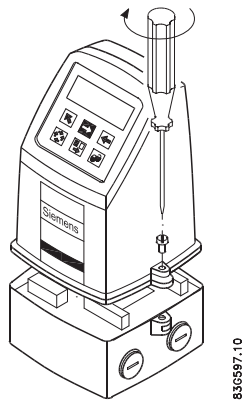

5. Transmitter is ready to be powered up.

<b>CAUTION</b>
Exposing the transmitter to direct sunlight may increase the operating temperature above its specified limit, and decrease display visibility. A sun shield is available as accessory.

## 4.4 MAG 5000/6000 CT

To ensure that the settings of this custody transfer-approved MAG 5000/6000 CT transmitter are not changed, it is necessary to install a hardware key to lock the software functions and to seal the device.

MAG 6000 CT is installed like a Standard MAG 6000 except for the final sealing.

Calibration sealing has been carried out at calibration.

### 4.4.1 Installing hardware key

#### Use hardware key on non-verified transmitter

1. Mount hardware key on transmitter connection plate during setting of primary operating parameters such as  $Q_{max.}$ , low-flow cut-off, units, approvals, etc. in connection with commissioning or calibration. See setup menus in appendix menu diagrams (Page 73).

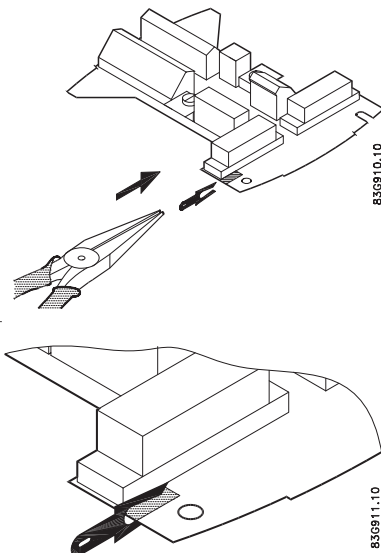

2. Remove hardware key after setting up and calibrating unit.

This locks the menu structure and the selected settings.

---

#### Note

##### Hardware key function

Setting of primary operating parameters is blocked during normal operation.

When key is mounted, access to all menu items is gained. When key is removed, primary settings are blocked in accordance with requirements in authorisation.

---

### 4.4.2 Seal device

#### Seal transmitter

**CAUTION**  
Seal transmitter to prevent unauthorized access.

1. Seal connection plate to prevent access to SENSORPROM® memory unit as shown below. 1 indicates sealing locations.

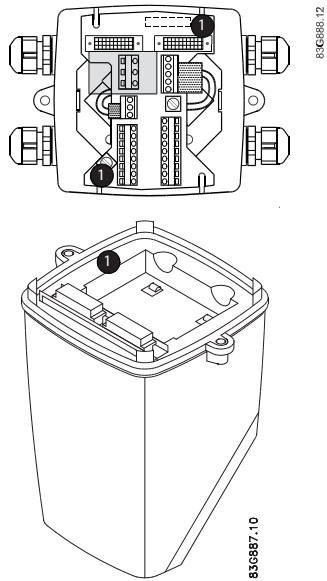

2. Drill through marked drilling holes in terminal box and transmitter/lid. Seal transmitter externally as shown below.

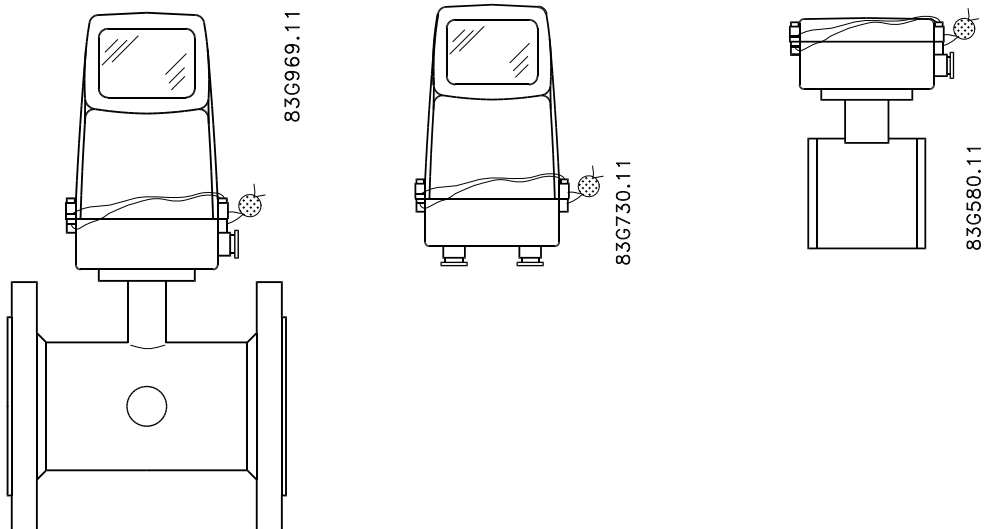

## 4.5 Turning transmitter/keypad

It is possible to alter the standard assembly, e.g. to turn transmitter or keypad.

### Transmitter

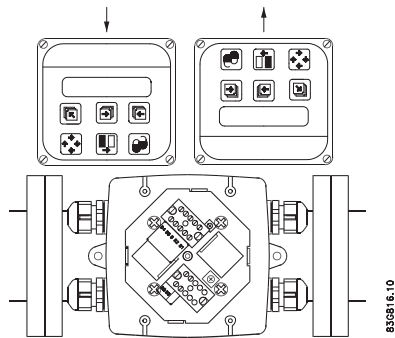

Figure 4-9 Transmitter can be mounted with its front in either direction indicated by the arrows without turning terminal box

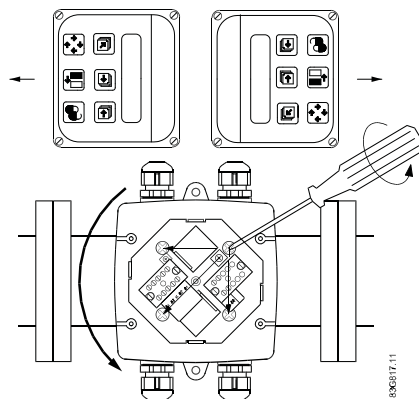
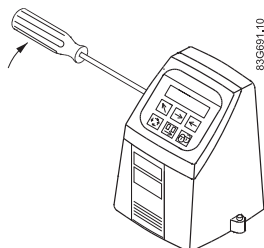

Figure 4-10 Terminal box can be rotated  $\pm 90^\circ$  in order to optimize viewing angle of transmitter display/keypad

1. Unscrew the four screws in bottom of terminal box.
2. Turn terminal box to required position.
3. Retighten screws firmly.

### Keypad

1. Remove outer frame using a screwdriver.



2. Loosen the four screws retaining keypad.

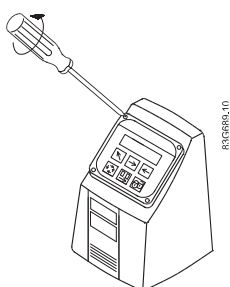

3. Withdraw keypad and turn it to required orientation.

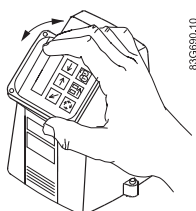

4. Tighten the four screws until a mechanical stop is felt in order to obtain IP67 enclosure.

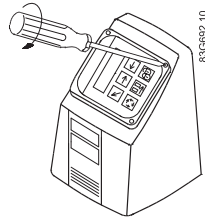

5. Snaplock outer frame onto keypad (click).

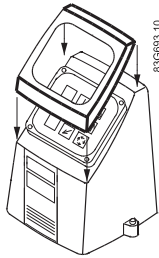



 **WARNING**

**Mains supply from building installation Class II**

A switch or circuit breaker (Max. 15 A) must be installed in close proximity to the equipment and within easy reach of the operator. It must be marked as the disconnecting device for the equipment.

 **WARNING**

**Protective conductor terminal**

The required cable is min. AGW16 or 1.5 Cu.

 **WARNING**

**Wire insulation**

The insulation between the connected mains supply and 24 V AC/DC supply for the flowmeter must at least be rated with double or reinforced insulation at mains voltage.

For field wiring installation: Ensure that the **National Installation Code** of the country in which the flowmeters are installed is met.

---

**Note**

**National installation code**

Observe country specific installation directives for field wiring.

---

## 5.1 Electrical connection

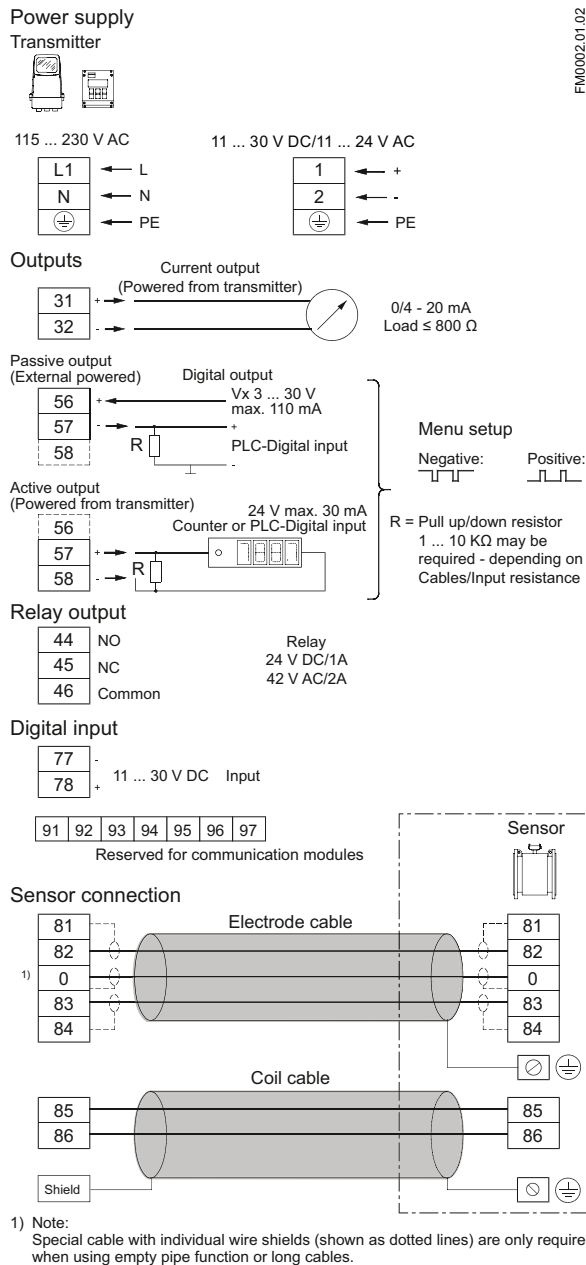

Figure 5-1 Wiring diagram

### Note

Terminals 81 and 84 are only to be connected if special electrode cable with double screening is used, e.g. when empty pipe function or long cables are used.

### Mains supply

Mains supply 115 ... 230 V AC from building installation Class II.

 <b>WARNING</b>
--

<b>Grounding</b>
------------------

Connect mains protective earth wire to PE terminal in accordance with diagram (due to class 1 power supply).
--

### Mechanical counter

Connect a 1000  $\mu$ F capacitor (capacitor+ to terminal 56 and capacitor- to terminal 58) if a mechanical counter is connected to terminals 57 and 58 (active output).

### Output cables

Use screened cables if long cables are used in noisy environments.

### Digital output

If internal resistance of a load exceeds 10 k $\Omega$ , connect an external 10 k $\Omega$  load resistor in parallel to this load.

 <b>WARNING</b>
--

<b>Intrinsically safe terminals</b>
-------------------------------------

<b>Always</b> ensure that distance between cables/wires is <b>minimum 50 mm</b> in order to avoid that wires/terminals of intrinsically safe circuits get into contact with wires of other cables.
--

Fasten cables/wires in a way that they <b>cannot</b> get into contact with each other, not even in case of an error. Keep wire ends as short as possible.
---

## 5.2 Connection of add-on modules

When the add-on module has been installed, the electrical connections are available on terminal rows 91-97.

### For more information

Refer to the relevant BUS communication Quick Start or Operating Instructions available at the SITRANS F literature CD or on the internet, at : [www.siemens.com/flowdocumentation](http://www.siemens.com/flowdocumentation) ([www.siemens.com/flowdocumentation](http://www.siemens.com/flowdocumentation)).



## Commissioning

In this chapter it is described how to commission the device via the local user interface (LUI). The display is described in details in section Local user interface (Page 38).

Furthermore, the following functions are described in details:

- Changing password (Page 40)
- Changing basic settings (Page 40)
- Changing operator menu setup (Page 42)
- Changing language (Page 43)

Detailed diagrams concerning the specific menu are shown in appendix menu diagrams (Page 73).

For factory settings, see Factory settings (Page 91).

### 6.1 MAG 5000/6000 Blind

---

#### Note

Does not have a display. All factory settings will be uploaded from the SENSORPROM® unit after power-up.

---

For sensor dependent factory settings, see Appendix B (Page 93).

#### Changing settings

If other settings are required, a standard transmitter with display and similar power supply can be used.

1. Unscrew and remove MAG 5000/6000 Blind.
2. Mount standard MAG 5000/6000 transmitter.
3. Change required settings via display and keypad.

All changed data will be stored in SENSORPROM® memory unit.

4. Remove standard transmitter and remount Blind transmitter.
5. Fasten screws holding transmitter.

New settings stored in SENSORPROM® memory unit will be uploaded in blind transmitter.

## 6.2 Local user interface

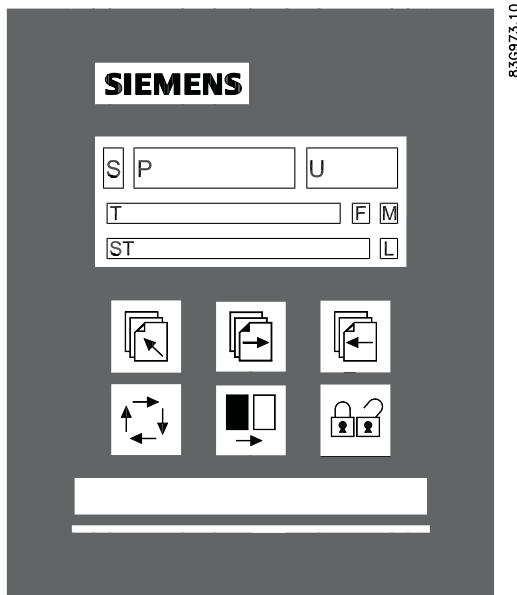

836973.10

















- S Sign field
- P Primary field for numeric value flow rate, Totalizer 1 or Totalizer 2)
- U Unit field
- T Title line with individual information according to operator or setup menu selected.
- ST Subtitle line which will either add information to the title line or keep individual information independent of the title line.
- F Alarm field.  Two flashing triangles will appear in case of a fault condition.
- M Mode field
- L Lock field

Figure 6-1 Local User Interface

### Mode field symbols







	Communication mode		Language mode		Sensor characteristics
	Service mode		Basic settings		Reset mode
	Operator menu		Output		Operator-active
	Product identity		External input		Operator-inactive

## Lock field symbols

	Ready for change		Access to submenu
	Value locked		RESET MODE: Zero setting of totalizers and initialization of setting

## Keypad



The keypad is used to set the flowmeter. The keys function as follows:

TOP UP KEY		This key (when held for 2 sec.) is used to switch between operator menu and setup menu. In transmitter setup menu, a short press will cause a return to previous level.
FORWARD KEY		This key is used to step forward through the menus. It is the only key normally used by the operator.
BACKWARD KEY		This key is used to step backwards through the menus.
CHANGE KEY		With this key settings or numerical values are changed.
SELECT KEY		With this key figures to be changed are selected.
LOCK/UNLOCK KEY		This key enables the operator to change settings and it gives access to submenus.

## 6.3 Menu structure

The menu is built up of two parts. An **operator menu** and a **setup menu**, see also overview diagrams MAG 5000/6000 (Page 73) and MAG 5000/6000 CT (Page 75).

### Operator menu

The operator menu is for daily operation. It is customized in the operator menu setup. The transmitter always starts up in operator menu No. 1. The forward  and the backward keys  are used to step through the operator menus.



### Setup menu

The setup menu is for commissioning and service only. Access to the setup menu is gained by pressing the top up key  for 2 seconds. The setup menu operates in two modes:

- View mode
- Setup mode

**View mode** is a read-only mode. The pre-selected settings can only be scanned.









**Setup mode** is a read and write mode. The pre-selected settings can be scanned and changed. Access to the setup mode is password-protected. The factory set password is 1000.

Access to a submenu in the setup menu is gained by pressing the lock key . Press the top up key  briefly to return to the previous menu. Press longer (2 sec.) to exit the setup menu and return to operator menu No. 1.

## 6.4 Changing password

The setup menu is password-protected in order to ensure that only authorized personnel can make any changes in transmitter settings.



Change password as follows:

1. Press top up key  for 2 sec.
2. Enter password.
3. Use forward key  or backward key  to reach password menu.
4. Press lock/unlock key  to unlock password.
5. Use select key  and change key  to change password.
6. Press lock/unlock key  to confirm new password.
7. Press top up key  two times to exit setup mode.

See change password diagram (Page 76).

The factory-set password is 1000, but it can be changed to any value between 1000 and 9999.

Factory setting of password can be re-established as follows:

1. Switch off power supply.
2. While pressing top up key  - switch on power supply.
3. Release top up key  after 10 sec.

## 6.5 Changing basic settings

In the basic settings menu it is possible to set the following parameters:

Parameter	Description
Main frequency	Selection of main power supply frequency corresponding to the country in which the flowmeter is installed (e.g. 60 Hz in America).
Flow direction	Selection of correct flow direction in pipe.
Q <sub>max</sub>	Setting of measuring range, analog outputs and frequency output. Also individual dimension-dependent setting of value, decimal point, unit and time.
Q <sub>max 2</sub>	Setting of measuring range, analog outputs and frequency output. Also individual dimension-dependent setting of value, decimal point, unit and time. This menu is only visible if chosen as external digital input.
Totalizer	Setting of unit and decimal point.
Low flow cut-off	Setting of a percentage of selected Q <sub>max</sub> . This filters noise in installation reducing fluctuations in display and all outputs.

Parameter	Description
Empty pipe cut-off	When set to "On" the alarm will indicate when sensor is running empty. All readings, display and outputs, will indicate zero.
Error level	Selecting error level at which flowmeter will detect an error.

---

**Note**

Totalizer 2 is not visible when batch is selected as digital output.











---

**Note**

$Q_{max}$  2 is visible only when chosen as external input.

---



Change basic settings as follows:

1. Press top up key  for 2 sec.
2. Enter password.
3. Use forward key  to reach basic settings menu.
4. Press lock/unlock key  to unlock settings.
5. Use forward key  or backward key  to reach relevant menu.
6. Press lock/unlock key  to unlock settings.
7. Use select key  and change key  to change settings.
8. Press lock/unlock key  to confirm new settings.
9. Repeat steps 5-8 to change other settings.
10. Press top up key  two times to exit setup mode.



See change basic settings menu diagram (Page 77).

Decimal point can be positioned and units set individually for flow rate in totalizer 1 and totalizer 2.

### Changing decimal point position

1. Enter the respective totalizer menu.
2. Use select key  to position cursor below decimal point.
3. Use change key  to move decimal point to requested position.

### Changing units



1. Use select key  to position cursor below unit.
2. Press change key  until requested unit is displayed.

## 6.6 Changing operator menu setup



In the operator menu the menus required for daily operation of the flowmeter are shown. It is possible to hide and change some of the menus in the operator menu. This is done in the operator menu setup menu, see operator menu setup diagram (Page 78).

### Customizing menus in operator menu

To customize the menus in the operator menu perform the following steps:

1. Press top up key  for 2 sec.
2. Enter password.
3. Use forward key  or backward key  to reach operator menu.

### Changing text in line 1

1. Press lock/unlock key  to unlock setting.
2. Use change key  to select desired text.
3. Press lock/unlock key  to confirm selected text.









---

#### Note





If "Text" is selected in line 2, this line functions as a heading for the value shown in line 3. Otherwise it shows the actual value of the reading selected.

---

### Enabling two readings

1. Use forward key  to reach requested menu.
2. Press lock/unlock key  to unlock setting.
3. Use select key  to move cursor to upper line.
4. Use change key  to select requested reading.
5. Press lock/unlock key  to confirm selection.
6. Use select key  to move cursor to line 3.
7. Use change key  to select desired setting.
8. Press lock/unlock key  to confirm new setting.
9. Repeat steps 1-8 for each requested menu.







### Showing/hiding menus in operator menu

1. Use forward key  to reach requested menu.
2. Press lock/unlock key  to unlock setting.
3. Use select key  to move cursor to  $\sqrt{I \cdot \frac{d}{L}}$  symbol.
4. Press change key  to select visible ( $\sqrt{\quad}$ ) or hidden ( $\frac{\quad}{L}$ ).
5. Press lock/unlock key  to confirm new setting.

## 6.7 Changing language

It is possible to change language in transmitter. Default language is English, but it can be changed to various other languages.

Change language as follows:

1. Press top up key  for 2 sec.
2. Enter password.
3. Use forward key  or backward key  to reach language menu.
4. Press lock/unlock key  to unlock language.
5. Use change key  to select desired language.
6. Press lock/unlock key  to confirm new language.
7. Press top up key  two times to exit setup mode.

See language mode diagram (Page 79)



## Service and maintenance

The device is maintenance-free, however, a periodic inspection according pertinent directives and regulations must be carried out.

An inspection can include check of:

- Ambient conditions
- Seal integrity of the process connections, cable entries, and cover screws
- Reliability of power supply, lightning protection, and grounds

Under ideal conditions the flowmeter will operate continuously with no manual adjustment or intervention required.

The SITRANS F M Vericator is an external tool developed for verifying the MAG 5000/6000 system, installation, and application. It is a highly advanced instrument, which carries out the complex verification of the entire flowmeter system according to unique SIEMENS patented principles. The verification test is automated and the instrument easy to use, so no human error or influence will affect the verification.

### 7.1 Transmitter check list

If unstable/wrong measurements occur, it is often due to insufficient/wrong earthing or potential equalization. If earthing connection is OK, check transmitter as described below, and sensor as described in sensor check lists (see the respective operating instructions).

The easiest way to check the transmitter in a SITRANS F M installation is to replace the transmitter with another MAG 5000/6000 with a similar power supply.

As all settings are stored in and downloaded from the SENSORPROM®, replacement is easily done and no extra settings need to be made.

#### Check transmitter

If no replacement transmitter is available, check transmitter according to the following check table.

Power on transmitter		
0	Display light on?	Yes ⇒ 1
		No ⇒ 2
1	Flashing error triangles?	Yes ⇒ Check error table
		No ⇒ 1.2
1.2	Output and display readings OK?	Yes ⇒ 1.2.1
		No ⇒ 1.2.2
1.2.1	Transmitter OK	Check application Check installation/sensor/earthing connection etc.

Power on transmitter		
1.2.2	Check cables/conndections Check connection board Check pins in transmitter multiplug	OK ⇒ 1.2.1
		Not OK ⇒ correct fault
2	Check cables/conndections Check connection board Check pins in transmitter multiplug	OK ⇒ 2.1
		Not OK ⇒ Correct fault
2.1	Output readings OK?	Yes ⇒ 2.1.1
		No ⇒ 2.1.2.
2.1.1	Dispaly defective	Replace display
2.1.2	Transmitter defective	Replace transmitter

**Note**

**Sensor check list**

Check list for sensors are included in the respective sensor operating instructions.

## 7.2 Technical support

<b>CAUTION</b>
Repair and service must be carried out by approved Siemens Flow Instruments personnel only.

**Note**

Siemens Flow Instrument defines sensors as non-repairable products.

### Technical Support

If you have any technical questions about the device described in these Operating Instructions and do not find the right answers, you can contact Technical Support:

- Via the Internet using the **Support Request:**  
Support request (<http://www.siemens.com/automation/support-request>)
- Phone: +49 (0) 180 5050 222

Further information about our technical support is available in the Internet at Technical support (<http://support.automation.siemens.com/WWW/view/en/16604318>)

## **Service & Support on the Internet**

In addition to our documentation, we offer a comprehensive knowledge base online on the Internet at:

Service and support (<http://www.siemens.com/automation/service&support>)

There you will find:

- The latest product information, FAQs, downloads, tips and tricks.
- Our newsletter, providing you with the latest information about your products.
- A Knowledge Manager to find the right documents for you.
- Our bulletin board, where users and specialists share their knowledge worldwide.
- You can find your local contact partner for Industry Automation and Drives Technologies in our partner database.
- Information about field service, repairs, spare parts and lots more under "Services."

## **Additional Support**

Please contact your local Siemens representative and offices if you have additional questions about the device

Find your contact partner at:

Local contact person (<http://www.automation.siemens.com/partner>)

## 7.3 Return procedures

Enclose the delivery note, the cover note for return delivery together with the declaration of decontamination form on the outside of the package in a well-fastened clear document pouch.

### Required forms

- **Delivery Note**
- **Cover Note for Return Delivery** with the following information  
Cover note  
([http://cache.automation.siemens.com/dnl/zY/zY0OTg1AAAA\\_16604370\\_TxtObj/Begleitschein\\_RW\\_AD.pdf](http://cache.automation.siemens.com/dnl/zY/zY0OTg1AAAA_16604370_TxtObj/Begleitschein_RW_AD.pdf))

- product (ordering number)
- number of devices or spare parts returned
- reason for the return

- **Declaration of Decontamination**

Decontamination declaration

([http://pia.khe.siemens.com/efiles/feldg/files/Service/declaration\\_of\\_decontamination\\_en.pdf](http://pia.khe.siemens.com/efiles/feldg/files/Service/declaration_of_decontamination_en.pdf))

With this declaration you certify *that the returned products/spare parts have been carefully cleaned and are free from any residues.*

If the device has been operated together with toxic, caustic, flammable or water-damaging products, clean the device before return by rinsing or neutralizing. Ensure that all cavities are free from dangerous substances. Then, double-check the device to ensure the cleaning is completed.

We will not service a device or spare part unless the declaration of decontamination confirms proper decontamination of the device or spare part. Shipments without a declaration of decontamination will be cleaned professionally at your expense before further proceeding.

You can find the forms on the Internet and on the CD delivered with the device.

## 7.4 Recalibration

Siemens Flow Instruments offers to recalibrate the sensor. The following calibrations are offered as standard:

- Standard matched pair calibration
- Customer specified matched pair calibration (up to 10 points)
- Accredited matched pair calibration

---

### Note

For recalibration the memory unit must always be returned with the sensor

---

# Functions

This chapter describes the various menus of the transmitter in details. The menu diagrams are shown in appendix menu diagrams (Page 73).

## 8.1 Output settings

Three outputs are available:

- Current output (range and time constant); terminals 31 and 32.
- Digital output (pulse, frequency, error, limit, or batch settings); terminals 56, 57, and 58.
- Relay output (error, limit, and batch settings); terminals 44, 45, and 46.

### Current output

In the current output menu it is possible to select current output range and time constant, see also Current output menu diagram (Page 79).

If current output is set to "4-20 mA+Alarm", the current output will show the following mA:

- 1.3 mA (if error level is "Fatal").
- 2 mA (if error level is "Permanent").
- 3 mA (if error level is "Warning").

For setting of error level, see error level menu diagram (Page 80).

If current output is not used, it must be set to "Off".

### Digital output

Digital output can be used to configure various settings:

- Pulse (volume/pulse, pulse output, pulse width, pulse polarity, and time constant), see pulse menu diagram (Page 79).
- Frequency (frequency output, max frequency, and time constant), see frequency menu diagram (Page 80).
- Error settings (level and number), see error level menu diagram (Page 80) and error number menu diagram (Page 80).

- Limit settings (number of setpoints, setpoint settings, and hysteresis), see direction/limit menu diagram (Page 81).
- Batch settings (quantity, time and counter settings, and time constant), see batch menu diagram (Page 82).

---

**Note**

**Batch settings**

Only MAG 6000.

Not available in MAG 5000, MAG 5000 CT and MAG 6000 CT.

---

**Note**

When relay is set to batch function, pulse/frequency is not available on digital output.

---

## Relay outputs

Relay output can be used to configure various settings:

- Error settings (level and number), see error level menu diagram (Page 80) and error number menu diagram (Page 80).
- Limit settings (number of setpoints, setpoint settings, and hysteresis), see direction/limit menu diagram (Page 81).
- Batch settings (quantity, time and counter settings, and time constant), see batch menu diagram (Page 82).
- Cleaning (cycle time), see cleaning menu diagram (Page 82).

---

**Note**

**Batch settings**

Only MAG 6000.

Not available in MAG 5000, MAG 5000 CT and MAG 6000 CT.

---

**Note**

**Cleaning**

If a cleaning unit is installed together with transmitter, relay output must **always** be used to operate this unit. It cannot be used for other purposes.

---

## 8.2 External input

By applying 11 ... 30 V DC to terminals 77 and 78, it is possible to perform:

- Batch control (start, stop, hold/continue)
- Reset totalizer
- Force/freeze output
- $Q_{max} 2$  (night)

See external input menu diagram (Page 83).

---

**Note****Batch settings**

Only MAG 6000.

Not available in MAG 5000, MAG 5000 CT and MAG 6000 CT.

---

**Note****Manual cleaning**

If the digital input is used for manual cleaning, the relay output also automatically changes to "cleaning".

---

## 8.3 Sensor characteristics

The sensor characteristics menu shows:







- If a SENSORPROM® is installed or not.
- Suppress error P 40 (SENSORPROM® not installed)
- Sensor size.
- Calibration factor.
- Correction factor.
- Excitation.

See also sensor characteristics menu diagram (Page 84).

## 8.4 Reset mode

The reset mode is used for resetting totalizers/counters or for restoring MAG 5000/6000 to its factory settings.

### Resetting

1. Press top up key  for 2 sec.
2. Enter password.
3. Use forward key  or backward key  to reach reset mode menu.
4. Press lock/unlock key  to enter reset menu.
5. Press forward key  to reach totalizer/counter to be reset or default setting menu.
6. Press lock/unlock key  to start resetting.

If restoring of factory settings is required:









1. Press lock/unlock key  again to confirm destruction of customized settings.

See also reset menu diagram (Page 85).







### Zero point adjustment (MAG 6000 SV only)



#### Auto adjustment

Before auto zero point adjustment is carried out ensure that valves to and from flowmeter are completely closed and that flow velocity in sensor is zero.

1. Press top up key  for 2 sec.
2. Enter password.
3. Use forward key  or backward key  to reach reset mode menu.
4. Press lock/unlock key  to enter reset menu.
5. Press forward key  to reach zero adjust menu.
6. Press lock/unlock key  to enter the menu.
7. Use change key  to select "auto".
8. Press forward key  to view actual offset (lower line in display). Value will be zero after adjustment has been performed.
9. Press lock/unlock key  to start adjustment.

#### Manual adjustment.

1. Press top up key  for 2 sec.
2. Enter password.
3. Use forward key  or backward key  to reach reset mode menu.
4. Press lock/unlock key  to enter reset menu.
5. Press forward key  to reach zero adjust menu.
6. Press lock/unlock key  to enter the menu.
7. Use change key  to select "manual".

8. Press forward key  and then select key  and change key  to key in offset value.
9. Press lock/unlock key  to start adjustment.

Zero point can be adjusted manually in range -1.000 ... +1.000 m<sup>3</sup>/s. If value outside this range is keyed in, zero point adjustment will not be implemented.

See also reset mode menu diagram (MAG 6000 SV) (Page 86).

## 8.5 Service mode

All outputs of the transmitter can be forced-controlled in the service mode menu, see also service mode menu diagram (Page 87).

Here it is possible to check whether e.g. the current output is functioning.

Error pending and status log lists are also accessible from this menu and the operating time (in days) can be read.

The forced control is cut off and all previous settings are reinitialized the moment the service mode is left by pressing top up key .

## 8.6 MAG 5000 CT and MAG 6000 CT settings

### Internal totalizers

Depending on the type of approval it is possible to reset the internal totalizers. The type of approval is selected in the reset menu (Page 85) with the hardware key mounted. It is possible to choose between:

- Hot/cold water
- Other liquids

Resetting of totalizers by electrical input is not possible.

#### Hot/cold water

- Totalizer 1 is allocated to forward flow (cannot be reset)
- Totalizer 2 is allocated to reverse flow (cannot be reset)

#### Other liquids

Both totalizer 1 and totalizer 2 are allocated to measure the net flow, i.e. any reverse flow will make the totalizers count backwards.

- Totalizer 1 cannot be reset.
- Totalizer 2 can be reset if the flow velocity in the meter pipe is <0.25 m/s. When the totalizer is reset, the pulse output register will also be reset.

### Output

- When choosing hot water, changing the output settings is not allowed and the output setting menus are not shown in display.
- When choosing cold water or other liquids, all output settings can be changed.

## 8.7 MAG 6000 SV

### Excitation frequency

The MAG 6000 SV excitation frequency can be changed in sensor characteristics menu (Page 84) to one of the following frequencies:

- $1 \frac{9}{16}$  Hz
- $3 \frac{1}{8}$  Hz
- $6 \frac{1}{4}$  Hz
- $12 \frac{1}{2}$  Hz
- 25 Hz
- 44 Hz

---

#### Note

Calibration has been made with the frequency stored in SENSORPROM® memory unit. A change in excitation frequency is not recommended and will always mean decreased measuring accuracy. In some instances, however, it may be necessary to change frequency due to pulsating flow from piston pumps or other resonance frequencies from surroundings.

---

It is highly recommended to carry out a zero point adjustment after changing the excitation frequency as the offset is affected by the frequency selected. When this is done, the decrease in measuring accuracy can be kept below 1% o.r.

A too high frequency for the sensor used will cause a coil current alarm indication.

# Alarm, error, and system messages

## 9.1 Diagnostics

### Error system

Transmitter system is equipped with an error and status log system with 4 groups of information.

(I) Information - system will continue to measure as normal, relay and current outputs will not be affected.

(W) Warning - system will continue to measure, but an event that may cause a system malfunction and require operator attention has occurred. The cause of the error may disappear on its own.

(P) Permanent error - may cause malfunction in the application and operator attention is required.

(F) Fatal error - is essential for the operation of the flowmeter. Immediate operator attention is required.

Two menus are available in service and operator menus for registration of information and errors.

- Error pending
- Status log

### Error pending

The first 9 pending errors are stored in the error pending list. When the error is corrected, it is removed from the error pending list.

The acceptance level for "error pending" can be individually configured to a particular application.

The acceptance level is set in the basic settings menu (Page 40).

### Acceptance levels

The following three acceptance levels are selectable.

- Fatal error: Only fatal errors are registered as errors
- Permanent error: Permanent and fatal errors are registered as errors
- Warning (Default value): Warnings, permanent and fatal errors are registered as errors

Error information is displayed in title and subtitle lines, see display layout (Page 38). Title line will show time since occurrence of error in days, hours and minutes. Subtitle line will flash between an error text and a remedy text. Error text will indicate type of error (I, W, P or F), error number, and error text. Remedy text will inform operator of action to take to remove error.

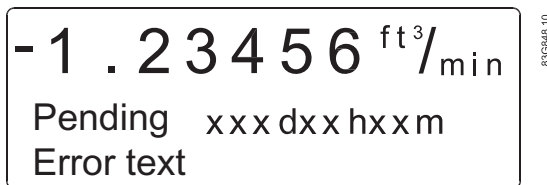

### Status log

The latest 9 errors are stored in the status log. Errors are stored in the status log for 180 days, even if they are corrected.

### Alarm field

The alarm field on the display will always flash when an error is pending.

### Error output

The digital and relay output can be activated individually error by error (error level). The relay output is default selected to error level. An output can also be selected to activate on a single error number.

The alarm field, error output and error pending always operate together.

The analog output turns to a 1 mA level when in the 4 ... 20 mA mode.

### Operator menu

Error pending and status log are as default enabled (✓) in the operator menu.

## 9.2 List of error numbers

Error No.	Error text Remedy text	Comment	Output status	Input status
1	<i>I1 - Power on</i> OK	Device powered on	Active	Active
2	<i>I2 - Add-on module</i> Applied	A new module has been applied to the system	Active	Active
3	<i>I3 - Add-on module</i> Install	An add-on module is defect or has been removed. This can be an internal add-on module	Active	Active
4	<i>I4 - Param. corrected</i> OK	A less vital parameter in the transmitter has been replaced by its default value	Active	Active
20	<i>W20 - Totalizer 1</i> Reset manually	During initialisation the check of the saved totalizer value has failed. It is not possible to rely on the saved totalizer value anymore. The totalizer value must be reset manually in order to rely on future readings	Active	Active
20	<i>W20 - Totalizer 2</i> Reset manually	During initialisation the check of the saved totalizer value has failed. It is not possible to rely on the saved totalizer value anymore. The totalizer value must be reset manually in order to rely on future readings	Active	Active
21	<i>W21 - Pulse overflow</i> Adj. pulse settings	Actual flow is too big compared with pulse width and volume/pulse	Reduced pulse width	Active
22	<i>W22 - Batch timeout</i> Check installation	Duration of batching has exceeded a predefined maximum time	Batch output on zero	Active
23	<i>W23 - Batch overrun</i> Check installation	Batch volume has exceeded a predefined maximum overrun volume	Batch output on zero	Active
24	<i>W24 - Batch neg. flow</i> Check flow direction	Negative flow direction during batch	Active	Active
30	<i>W30 - Overflow</i> Adj. $Q_{max}$	Flow is above $Q_{max}$ settings	Max. 120 %	Active
31	<i>W31 - Empty pipe</i>	Pipe is empty	Zero	Active
40	<i>P40 - SENSORPROM®</i> Insert/change	SENSORPROM® unit not installed	Active	Active
41	<i>P41 - Parameter range</i> Switch off and on	A parameter is out of range. The parameter could not be replaced by its default value. The error will disappear at the next power-on	Active	Active

## 9.2 List of error numbers

Error No.	Error text Remedy text	Comment	Output status	Input status
42	<i>P42 - Current output</i> Check cables	Current loop is disconnected or the loop resistance is too big	Active	Active
43	<i>P43 - Internal error</i> Switch off and on	Too many errors occurred at the same time. Some errors are not detected correctly	Active	Active
44	<i>P44 - CT SENSORPROM®</i>	SENSORPROM® unit has been used as CT version	Active	Active
60	<i>F60 - CAN comm. error</i> Transmitter/AOM	CAN bus communication error. An add-on module, the display module or the transmitter is defective	Zero	Inactive
61	<i>F60 - SENSORPROM® error</i> Replace	It is not possible to rely on the data in SENSORPROM® unit anymore	Active	Active
62	<i>F62 - SENSORPROM® ID</i> Replace	The SENSORPROM® unit ID does not comply with the product ID. The SENSORPROM® unit is from another type of product SITRANS F C, SITRANS F US etc.	Zero	Inactive
63	<i>F63 - SENSORPROM®</i> Replace	It is not possible to read from the SENSORPROM® unit anymore	Active	Active
70	<i>F70 - Coil current</i> Check cables	Coil excitation has failed	Active	Active
71	<i>F71 - Internal error</i> Replace transmitter	Internal conversion error in ASIC	Active	Active

## Troubleshooting/FAQs

Symptom	Output signals	Error code	Cause	Remedy
Empty display	Minimum		1. No power supply	Power supply Check MAG 5000/6000 for bended pins on the connector
			2. MAG 5000/6000 defective	Replace MAG 5000/6000
No flow signal	Minimum		1. Current output disabled	Turn on current output
			2. Digital output disabled	Turn on digital output
			3. Reverse flow direction	Change direction
		F70	Incorrect or no coil current	Check cables/connections
	W31	Measuring pipe empty	Ensure that the measuring pipe is full	
	F60	Internal error	Replace MAG 5000/6000	
	Undefined	P42	1. No load on current output	Check cables/connections
2. MAG 5000/6000 defective			Replace MAG 5000/6000	
Indicates flow with no flow in pipe	Undefined		Measuring pipe empty	Select empty pipe cut-off
			Empty pipe cut-off is OFF	Ensure that the measuring pipe is full
			Electrode connection missing/electrode cable is insufficiently screened	Ensure that electrode cable is connected and sufficiently screened
Unstable flow signal	Unstable		1. Pulsating flow	Increase time constant
			2. Conductivity of medium too low	Use special electrode cable
			3. Electrical noise potential between medium and sensor	Ensure sufficient potential equalization
			4. Air bubbles in medium	Ensure medium does not contain air bubbles
			5. High concentration of particles or fibres	Increase time constant
Measuring error	Undefined		Incorrect installation	Check installation
		P40	No SENSORPROM® unit	Install SENSORPROM® unit
		P44	CT SENSORPROM® unit	Replace SENSORPROM® unit or reset SENSORPROM® unit with MAG CT transmitter
		F61	Defective SENSORPROM® unit	Replace SENSORPROM® unit
		F62	Wrong type of SENSORPROM® unit	Replace SENSORPROM® unit
		F63	Defective SENSORPROM® unit	Replace SENSORPROM® unit

Symptom	Output signals	Error code	Cause	Remedy
		F71	Loss of internal data	Replace MAG 5000/6000
	Maximum	W30	Flow exceeds 100% of Qmax.	Check Q <sub>max</sub> (Basic Settings)
		W21	Pulse overflow Volume/pulse too small	Change volume/pulse
			Pulse width too large	Change pulse width
Measuring approx. 50%			Missing one electrode connection	Check cables
Loss of totalizer data	OK	W20	Initializing error	Reset totalizer manually
##### Signs in display	OK		Totalizer roll over	Reset totalizer or increase totalizer unit

## Technical data

### 11.1 Technical specifications



<b>Mode of operation and design</b>	Measuring principle	Electromagnetic with pulsed constant field
	Empty pipe	Detection of empty pipe (special cable required in remote mounted installation)
	Excitation frequency	Depends on sensor size
	Electrode input impedance	$> 1 \times 10^{14} \Omega$
<b>Input</b>	<b>Digital input</b>	11 ... 30 V DC, $R_i = 4.4 \text{ k}\Omega$
	Activation time	50 ms
	Current	$I_{DC 11 \text{ V}} = 2.5 \text{ mA}$ , $I_{DC 30 \text{ V}} = 7 \text{ mA}$
<b>Output</b>	<b>Current output</b>	
	Signal range	0 ... 20 mA or 4 ... 20 mA, Alarm
	Load	$< 800 \Omega$
	Time constant	0.1 ... 30 s, adjustable (for batch: fixed at 0.1 s)
	<b>Digital output</b>	
	Frequency	0 ... 10 kHz, 50% duty cycle (uni/bidirectional)
	Pulse (active)	DC 24 V, 30 mA, $1 \text{ k}\Omega \leq R_i \leq 10 \text{ k}\Omega$ , short-circuit protected (power supplied from flowmeter)
	Pulse (passive)	DC 3 ... 30 V, max. 110 mA, $200 \Omega \leq R_i \leq 10 \text{ k}\Omega$ (powered from connected equipment)
	Time constant	0.1 ... 30 s, adjustable (for batch: fixed at 0.1 s)
	<b>Relay output</b>	
Time constant	Changeover relay, same as current output	
Load	42 V AC/2 A, 24 V DC/1 A	
<b>Low flow cut off</b>	0 ... 9.9% of maximum flow	

Technical data

11.1 Technical specifications

<b>Galvanic isolation</b>	All inputs and outputs are galvanically isolated	
<b>Max. measuring error (incl. sensor and zero point)</b>	MAG 5000	0.4% ± 1 mm/s (for v > 0.1 m/s)
	MAG 6000	0.2% ± 1 mm/s (for v > 0.1 m/s)
<b>Functions</b>	Flow rate, 2 totalizers, low-flow cut-off, empty pipe cut-off, flow direction, error system, operating time, uni/bidirectional flow, limit switches, pulse output, control for cleaning and batch	
<b>Rated operation conditions</b>	<b>Ambient temperature</b>	
	Operation	Standard IP67, 19", blind and SV versions: -20 ... +60 °C (-4 ... +140 °F) CT version: -20 ... +50 °C (-4 ... +122 °F)
	Storage	-40 ... +70 °C (-40 ... +158 °F)
<b>Mechanical load</b>	18 ... 1000 Hz, 3.17 G rms, sinusoidal in all directions to IEC 68-2-36	
<b>Degree of protection</b>	IP67/NEMA 4X/6 to IEC 529 and DIN 40050 (1 mH <sub>2</sub> O 30 min.)	
<b>EMC performance</b>	EN 61326-1 (industrial environments)	
	EN 61326-2-5	
<b>Display and keypad</b>	Totalizer	Two eight-digit counters for forward, net or reverse flow
	Display	Background illumination with alphanumeric text, 3 x 20 characters to indicate flow rate, totalized values, settings and faults; Reverse flow indicated by negative sign
	Time constant	Time constant as current output time constant
	<b>Design</b>	Enclosure material
	Dimensions	See dimensional drawings
	Weight	0.75 kg (2 lb)
<b>Power supply</b>	115 ... 230 V AC +10% -15%, 50 ... 60 Hz, Fuse: 500 mA T 11 ... 30 V DC or 11 ... 24 V AC; Fuse 2 A T	
<b>Power consumption</b>	115 ... 230 V AC: 17 VA 24 V AC: 9 VA, I <sub>N</sub> = 380 mA, I <sub>ST</sub> = 8 A (30 ms) 12 V DC: 11 W, I <sub>N</sub> = 920 mA, I <sub>ST</sub> = 4 A (250 ms)	
<b>Certificates and approvals</b>	CE, C-UL US general purpose, C-tick, CSA/FM Class 1, div 2	
	Custody transfer approval (MAG 5000/6000 CT)	Cold water pattern approval: PTB OIML R 49, MI-001 Hot water pattern approval: PTB and DANAK OIML R 75 (MAG 6000 CT) Other media than water (milk, beer etc.) pattern approval: PTB and DANAK OIML R 117 (MAG 6000 CT)

Communication	MAG 5000	Without communication or HART as option
	MAG 6000	Prepared for client mounted add-on modules: HART, MODBUS RTU/RS485, FOUNDATION Fieldbus H1, DeviceNet, PROFIBUS PA, PROFIBUS DP as add-on modules
	MAG 5000 CT / MAG 6000 CT	No communication modules approved

**Transmitter IP67/NEMA 4X/6 compact polyamide**

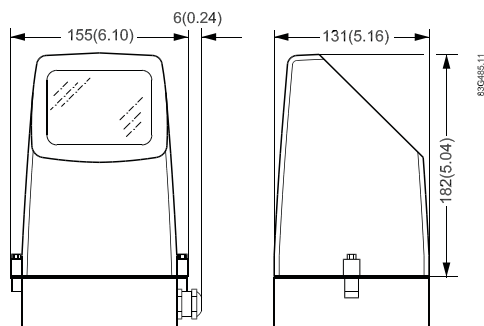

Weight: MAG 5000/6000: 0.75 kg (1.65 lbs)

**Transmitter IP67/NEMA 4X/6 wall-mounted polyamide**

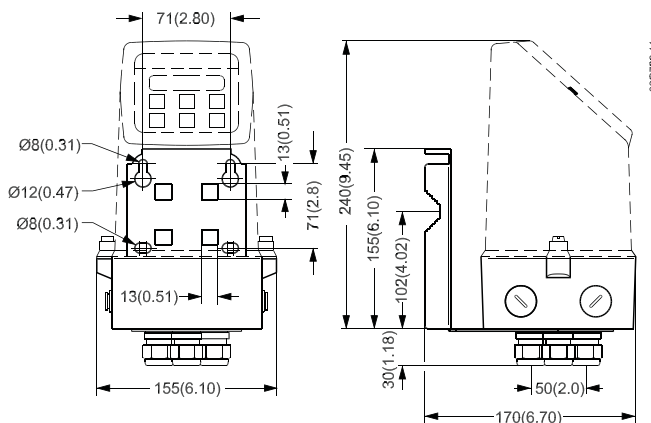

Weight(transmitter and wall mounting bracket): 1.65 kg (3.64 lbs)

## 11.2 Accuracy

For accuracy reference conditions, please see below.

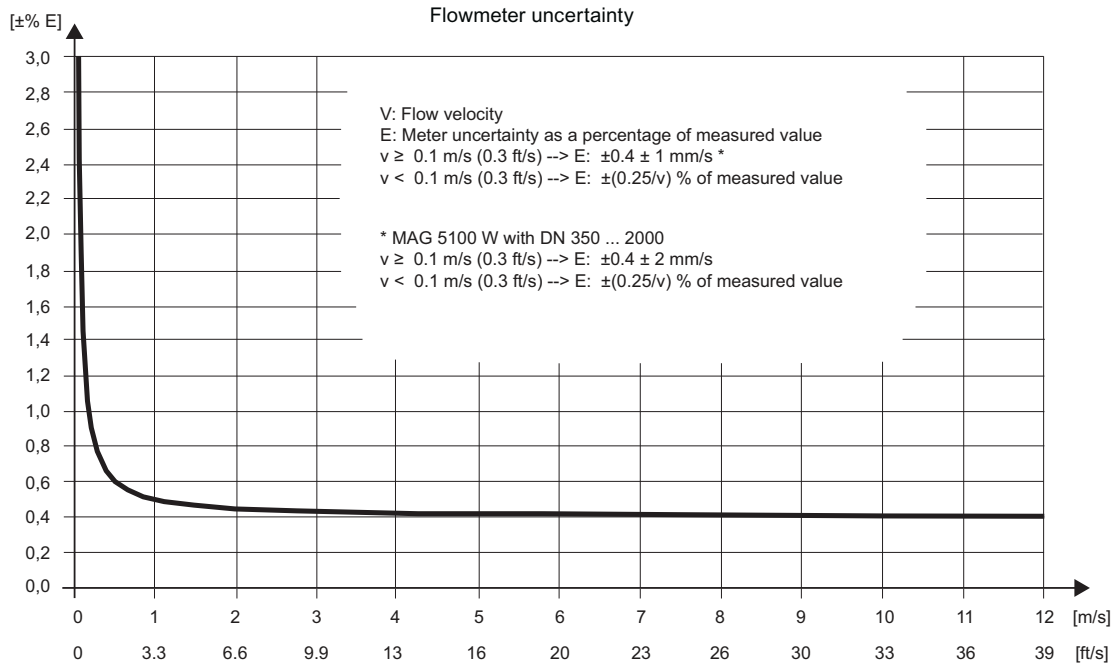

Figure 11-1 MAG 5000 with MAG 1100, MAG 1100 F, MAG 5100 W, MAG 3100 and MAG 3100 P

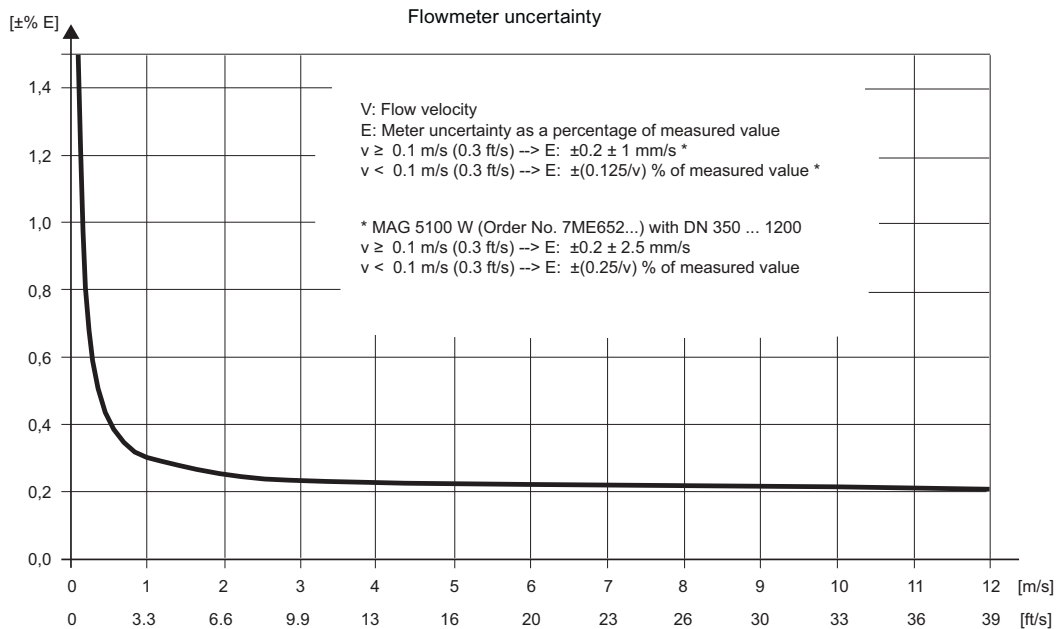

Figure 11-2 MAG 6000 with MAG 1100 (not PFA), MAG 1100 F (not PFA), MAG 5100 W, MAG 3100 and MAG 3100 P

## Reference conditions

(ISO 9104 and DIN/EN 29104)

A calibration certificate is shipped with every sensor and calibration data are stored in SENSORPROM memory unit.

Medium temperature	20°C ± 5°C (68°F ± 9°C)
Ambient temperature	20°C ± 5°C (68°F ± 9°C)
Supply voltage	$U_n \pm 1\%$
Warming-up time	30 minutes
Incorporation in conductive pipe section	
Inlet section	10 x DN (DN ≤ 1200/48") 5 x DN (DN > 1200/48")
Outlet section	5 x DN (DN ≤ 1200/48") 3 x DN (DN > 1200/48")
Flow conditions	Fully developed flow profile

Reference conditions for sensor calibration

Current output	As pulse output ± (0.1% of actual flow + 0.05% FSO)
Effect of ambient temperature	< ± 0.003% / °C act. < ± 0.005% / °C act.
Display/frequency/pulse output	
Current output	
Effect of supply voltage	< 0.005% of measuring value on 1% change
Repeatability	± 0.1% of actual flow for $V \geq 0.5$ m/s (1.5 ft/s) and conductivity ≥ 10 µS/cm

Additions in the event of deviations from reference conditions

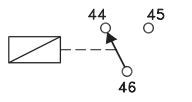
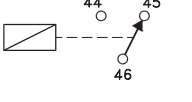
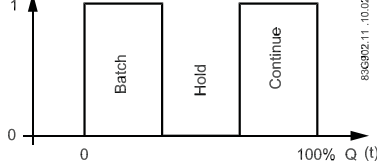
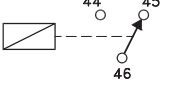
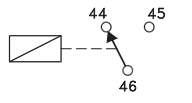

### 11.3 Output characteristics

Output characteristics	Bidirectional mode		Unidirectional mode	
0 ... 20 mA				
4 ... 20 mA				
Frequency				
Pulse output				
Relay	Power down		Active	
Error relay	No error		Error	
Limit switch or direction switch				
	Low flow (Reverse flow)		Intermediate flow	

Output characteristics	Bidirectional mode		Unidirectional mode	
	High flow (Forward flow)		High flow / Low flow	
Batch on digital output				
Batch on relay	Hold		Batch	

## 11.4 Cable data

### Description

Cable for standard electrode or coil	
Electrode cable, double shielded	
Cable kit with standard coil cable and electrode cable double shielded (also available as low noise cable for MAG 1100 sensor)	

### Technical data

		Standard electrode cable (electrode/coil)	Special cable (electrode)
Basic data	No. of conductors	3	3
	Sqr. area	1.5 mm <sup>2</sup>	0.25 mm <sup>2</sup>
	Screen	Yes	Double
	Color code	Brown, blue, black	Brown, blue, black
	Outside color	Grey	Grey
	Ext. diameter	7.8 mm	8.1 mm
	Conductor	Flexible CU	Flexible CU
	Isolation material	PVC	PVC
Ambient temperature	Flexible installation	-5 ... +70°C (23 ... 158°F)	-5 ... +70°C (23 ... 158°F)
	Non-flexible installation	-30 ... +70°C (-22 ... 158°F)	-30 ... +70°C (-22 ... 158°F)
Cable parameter	Capacity	161.50 pF/m	N/A
	Inductance	0.583 µH/m	N/A
	L/R	43.83 pH/Ω	N/A

## 11.5 Cable requirements

		Coil cable	Electrode cable
Basic data	No. of conductors	2	3
	Min. sqr. area	0.5 mm <sup>2</sup>	0.2 mm <sup>2</sup>
	Screen	Yes	Yes
	Max. capacitance	N/A	350 pF/m
Max. cable loop resistance	Media temperature:		
	< 100 °C	40 Ω	N/A
	> 200 °C	6 Ω	N/A
Cable glands on sensor and transmitter	M20x1.5 gland - Cable ø 5 ... 13 mm (0.20 ... 0.51 inches)		
	½ NPT gland - cable ø 5 ... 9 mm (0.20 ... 0.35 inches)		



## Spare parts/Accessories

### 12.1 Ordering





In order to ensure that the ordering data you are using is not outdated, the latest ordering data is always available on the Internet:

Catalog process instrumentation (<http://www.siemens.com/processinstrumentation/catalogs>)

### 12.2 Accessories

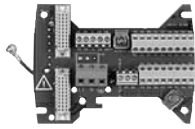
Description	
Wall mounting unit	
Display protection lid	
Communication modules for MAG 6000	

## 12.3 Spare parts

Description	
Connection plate	
SENSORPROM® memory unit	
Display unit	
Communication modules for MAG 6000	

## 12.4 Sun shield

Description	
Sun shield	



## Menu diagrams

### A.1 Overview MAG 5000/6000

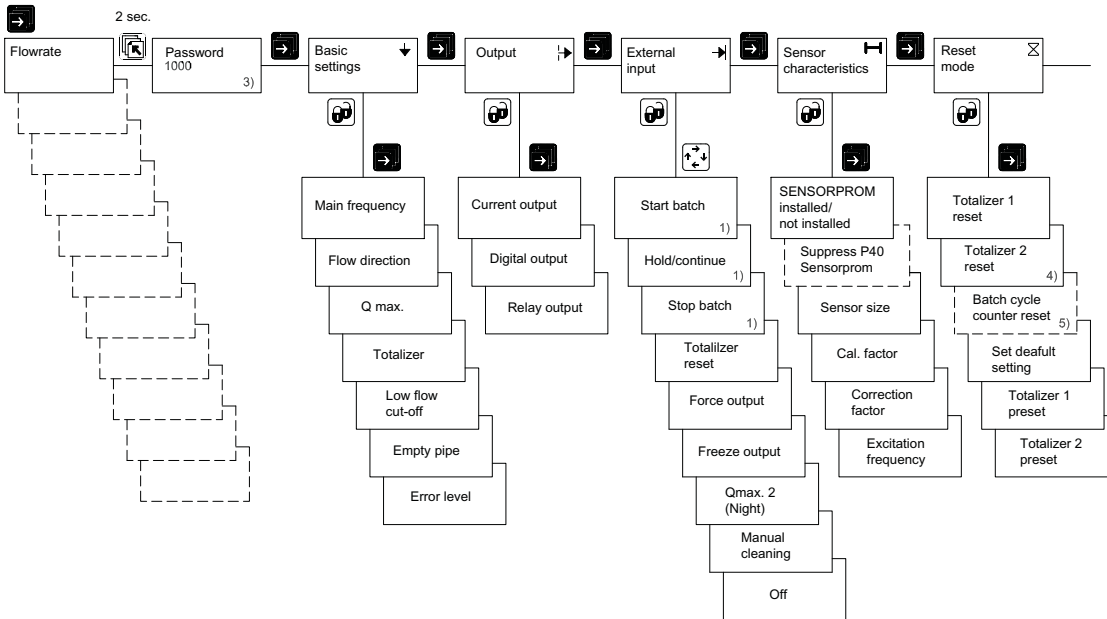
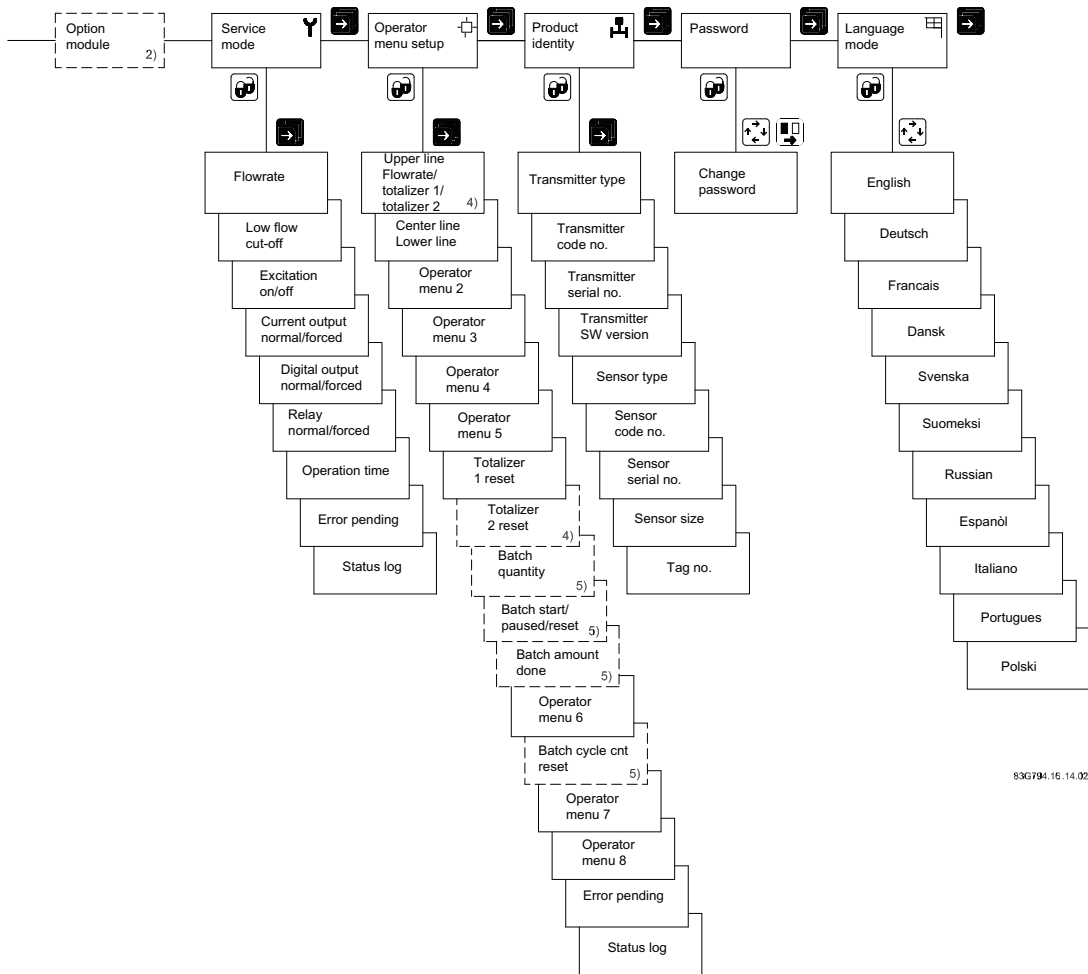

Figure A-1 Overview MAG 5000 and MAG 6000 (part 1)



83G794.16.14.02

- 1) MAG 6000 I only
- 2) Add-on module
- 3) Factory-set password: 1000
- 4) Not available when batch
- 5) Only available when batch

## A.2 Overview MAG 5000/6000 CT

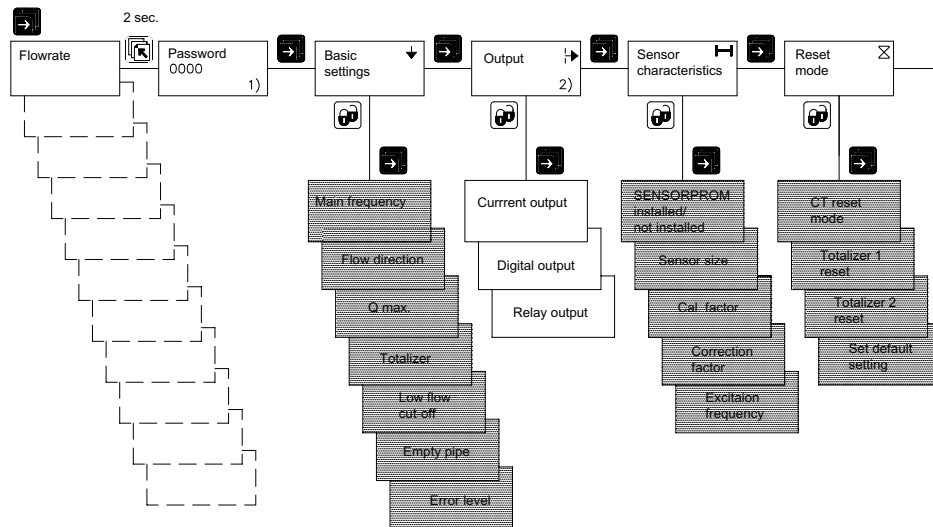
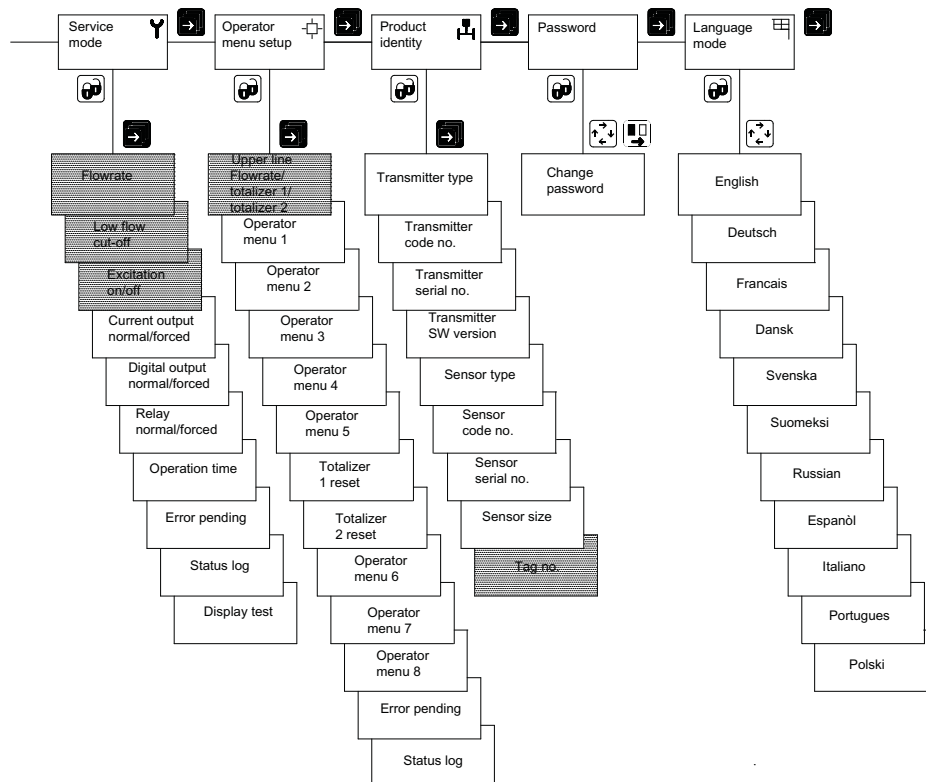

Figure A-2 Overview MAG 5000 CT and MAG 6000 CT (part 1)



83G885.11 .11.02

- 1) Factory-set password: 1000
- 2) Not visible when CT mode is "Hot water"

Figure A-3 Overview MAG 5000 CT and MAG 6000 CT (part 2)

**Note**

**Sealing**

Menus marked with gray are locked when transmitter is sealed.

---

### A.3 Change password

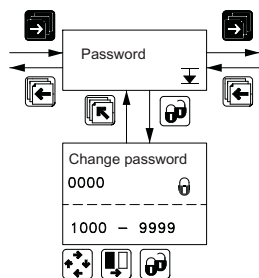

830843.1.0.10.02

## A.4 Basic settings

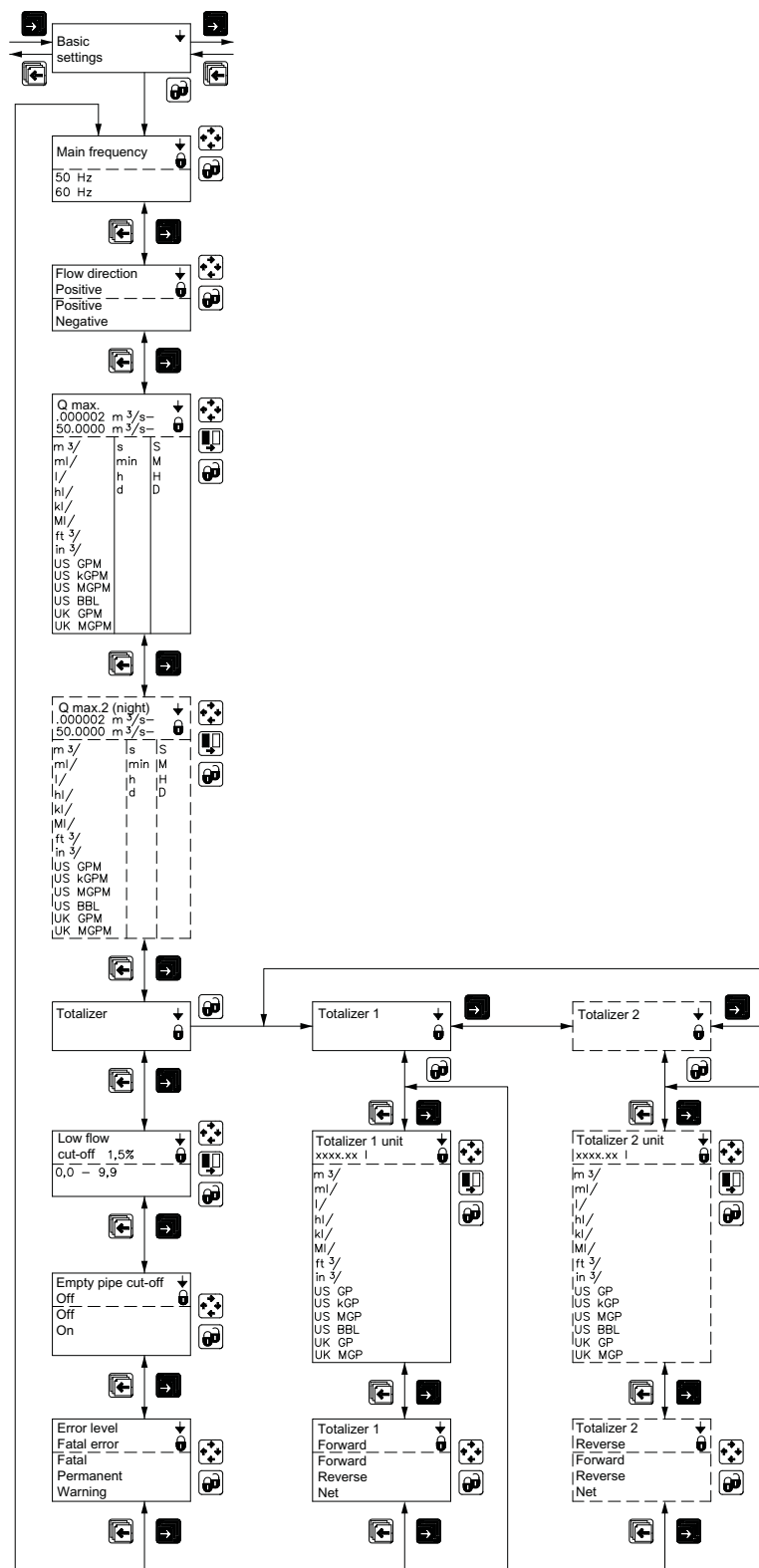

832796.12.10.02

## A.5 Operator menu setup

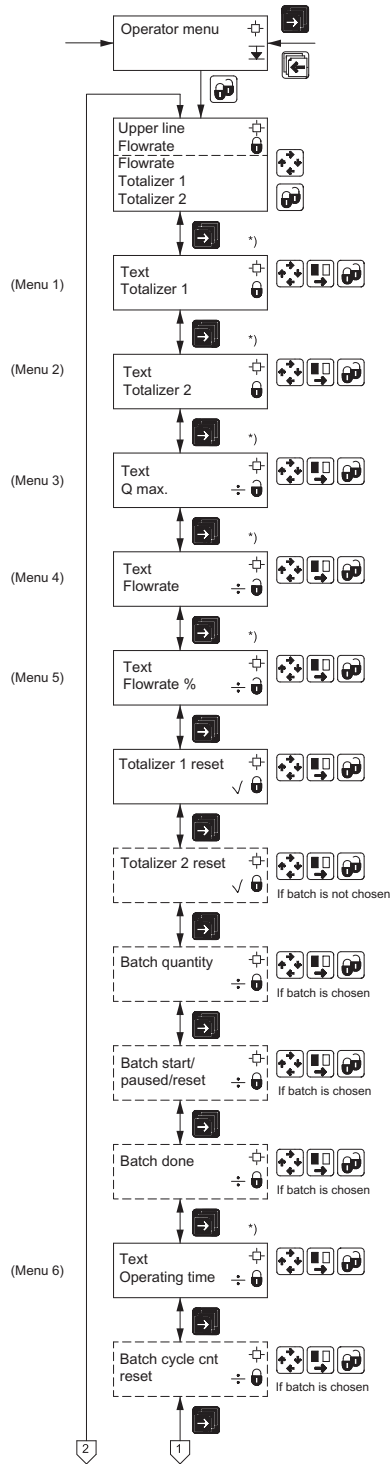

83G9333.10 -10.02

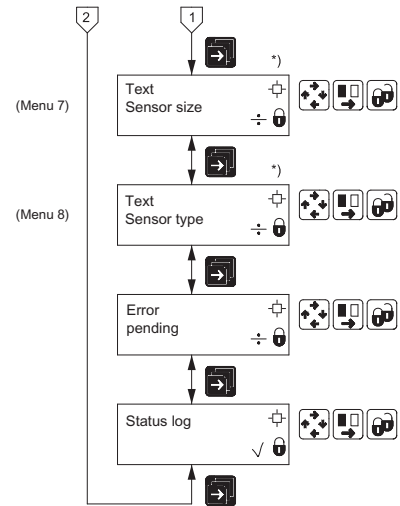

83G9445.10 -10.02

## A.6 Language mode

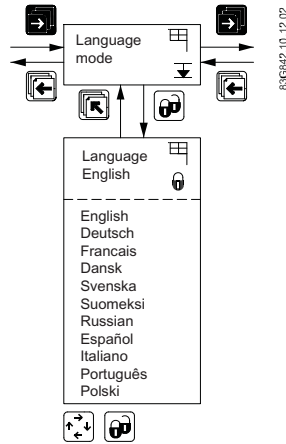

## A.7 Current output

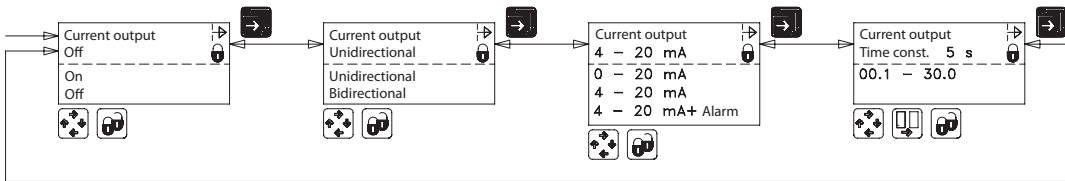

## A.8 Digital output - pulse

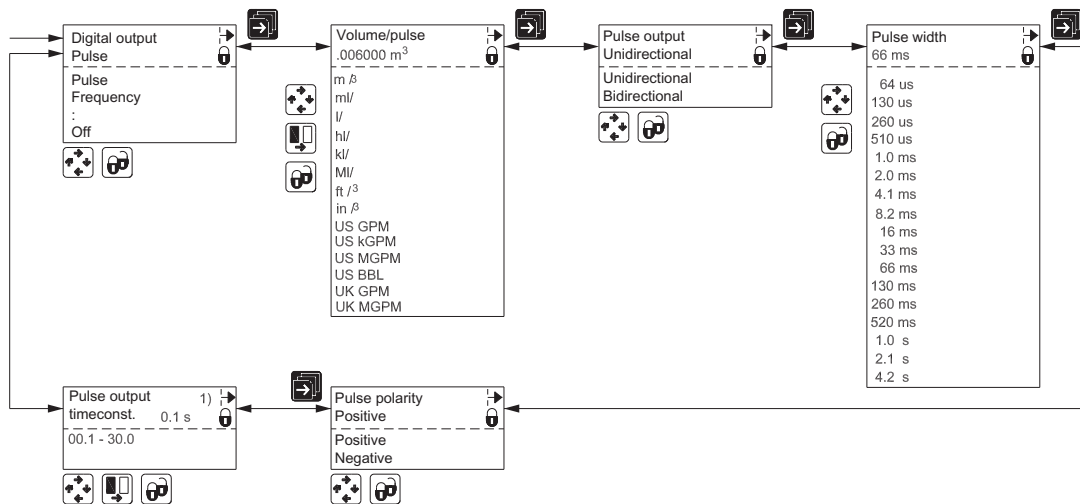

1) Not at batch

### A.9 Digital output - frequency

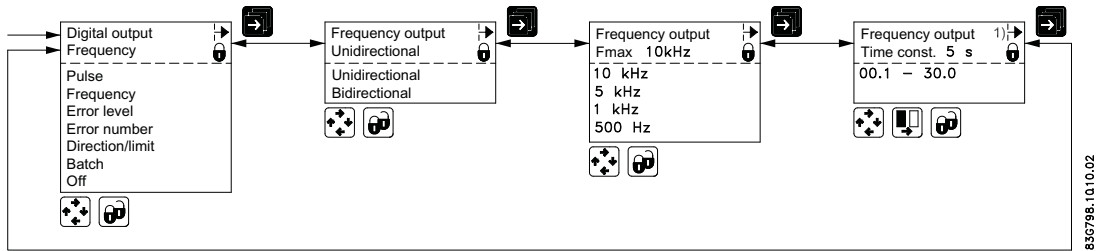

### A.10 Error level

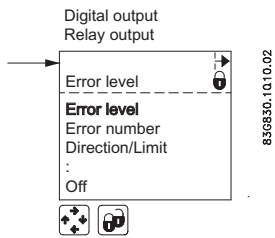

### A.11 Error number

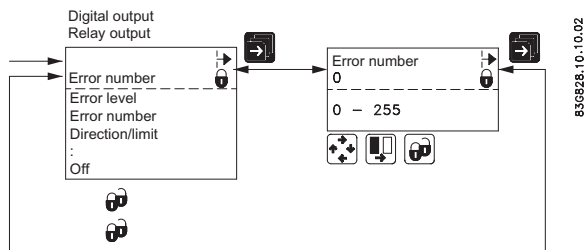

## A.12 Direction/limit

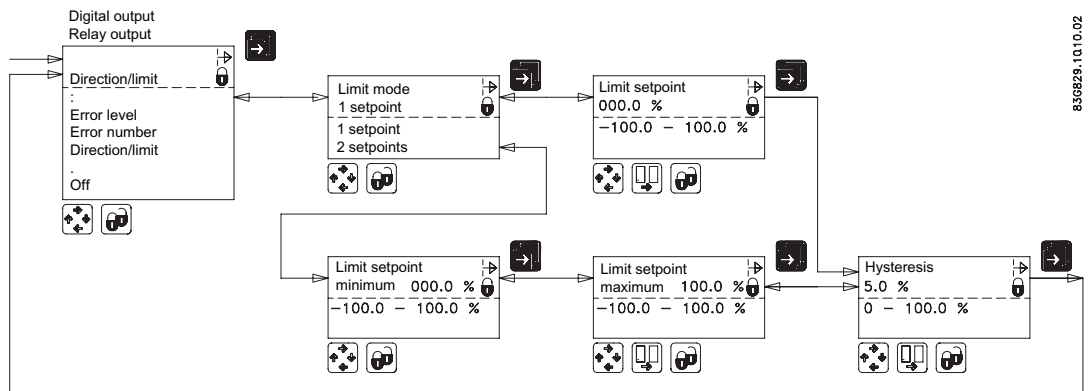

### A.13 Batch

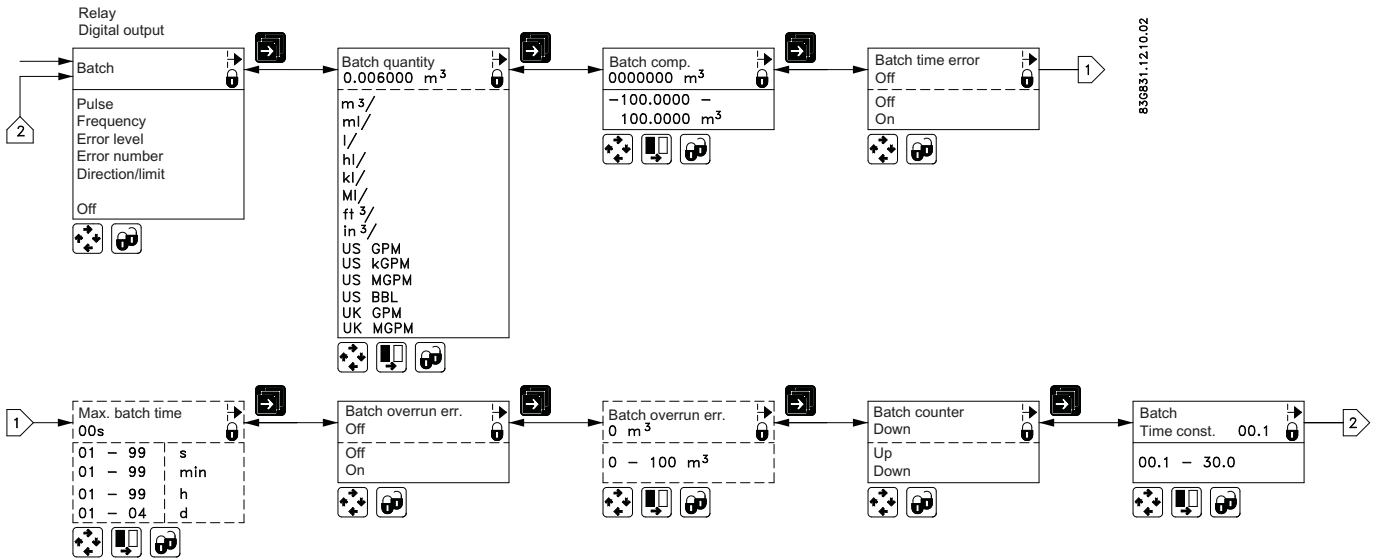

### A.14 Cleaning

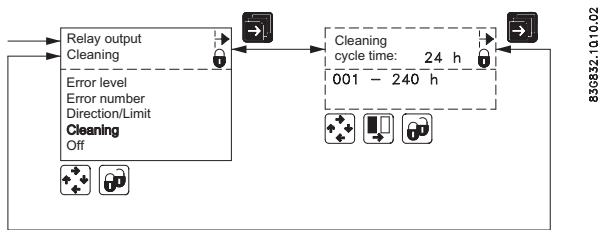

**Note**

**Relay outputs**

If cleaning unit is installed, relay outputs must always be used to operate cleaning.

Relay outputs cannot be used for other purposes

## A.15 External input

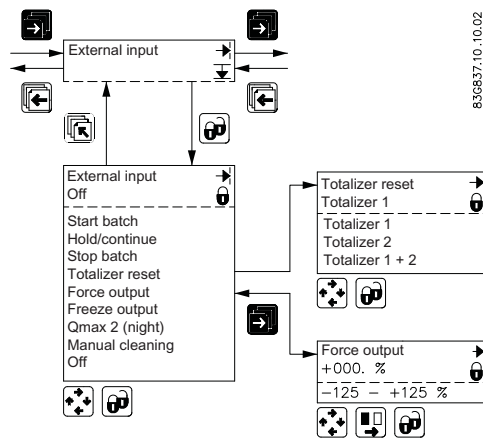

## A.16 Sensor characteristics

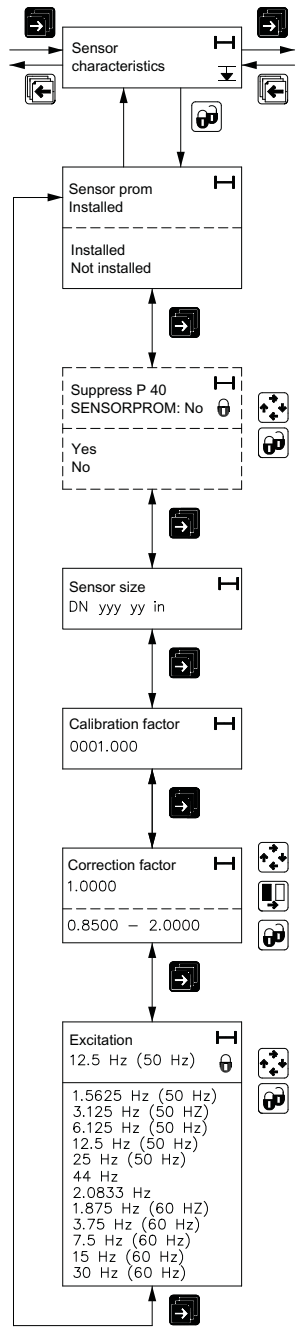

**Note**

**MAG 6000 SV**

The frequency can be set to 44 Hz in the MAG 6000 SV transmitter only.

## A.17 Reset mode

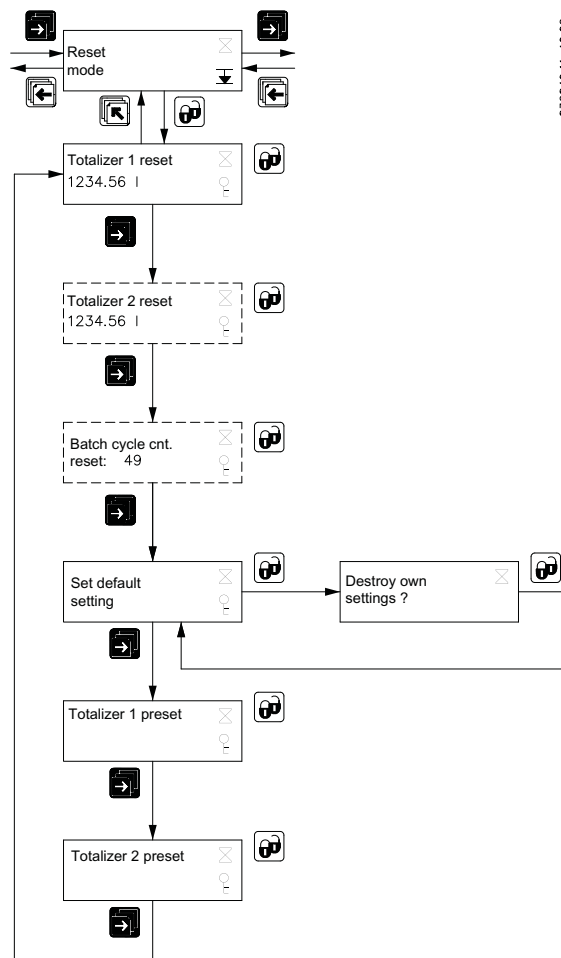

### A.18 Reset mode - MAG 6000 SV

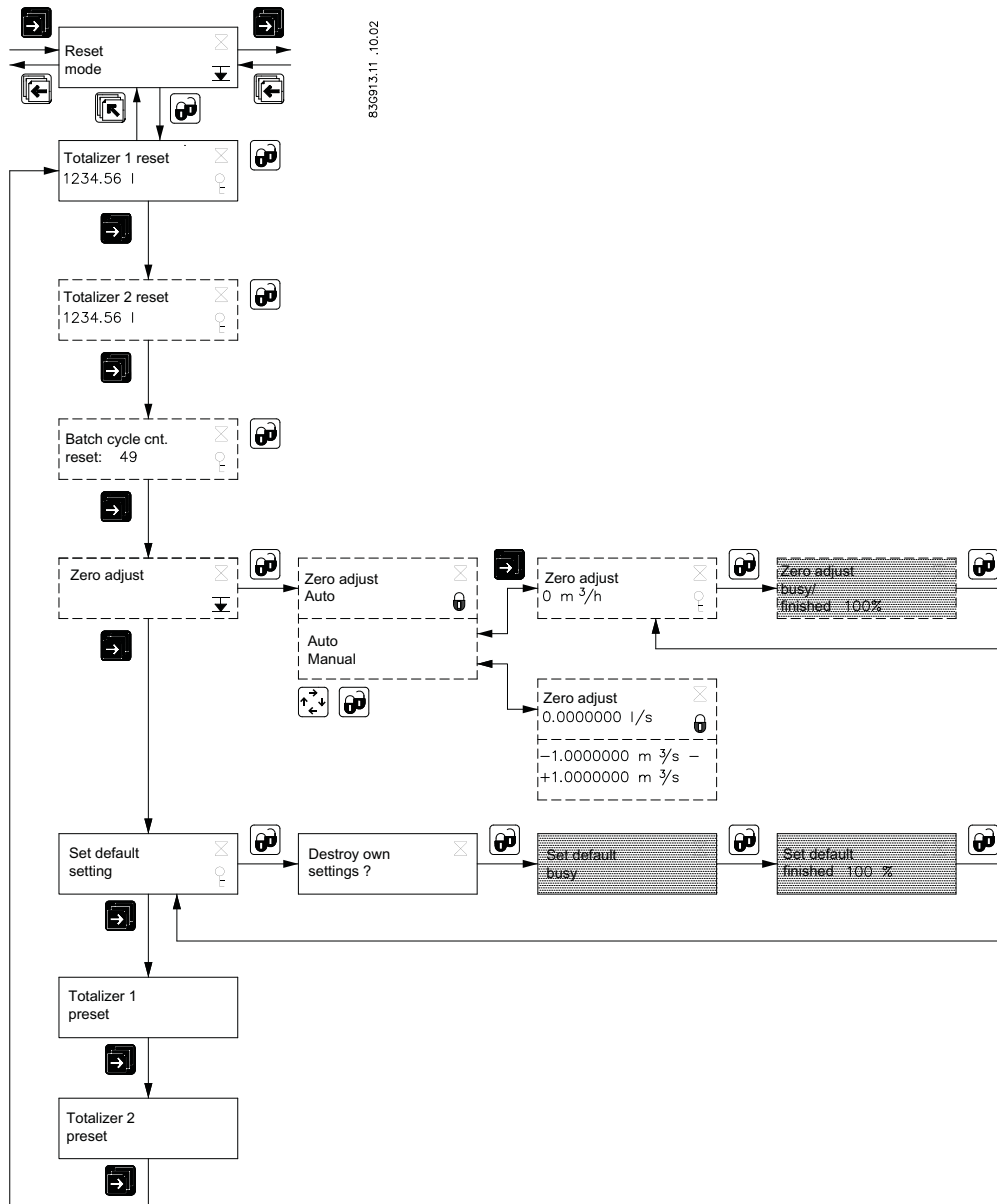

## A.19 Service mode

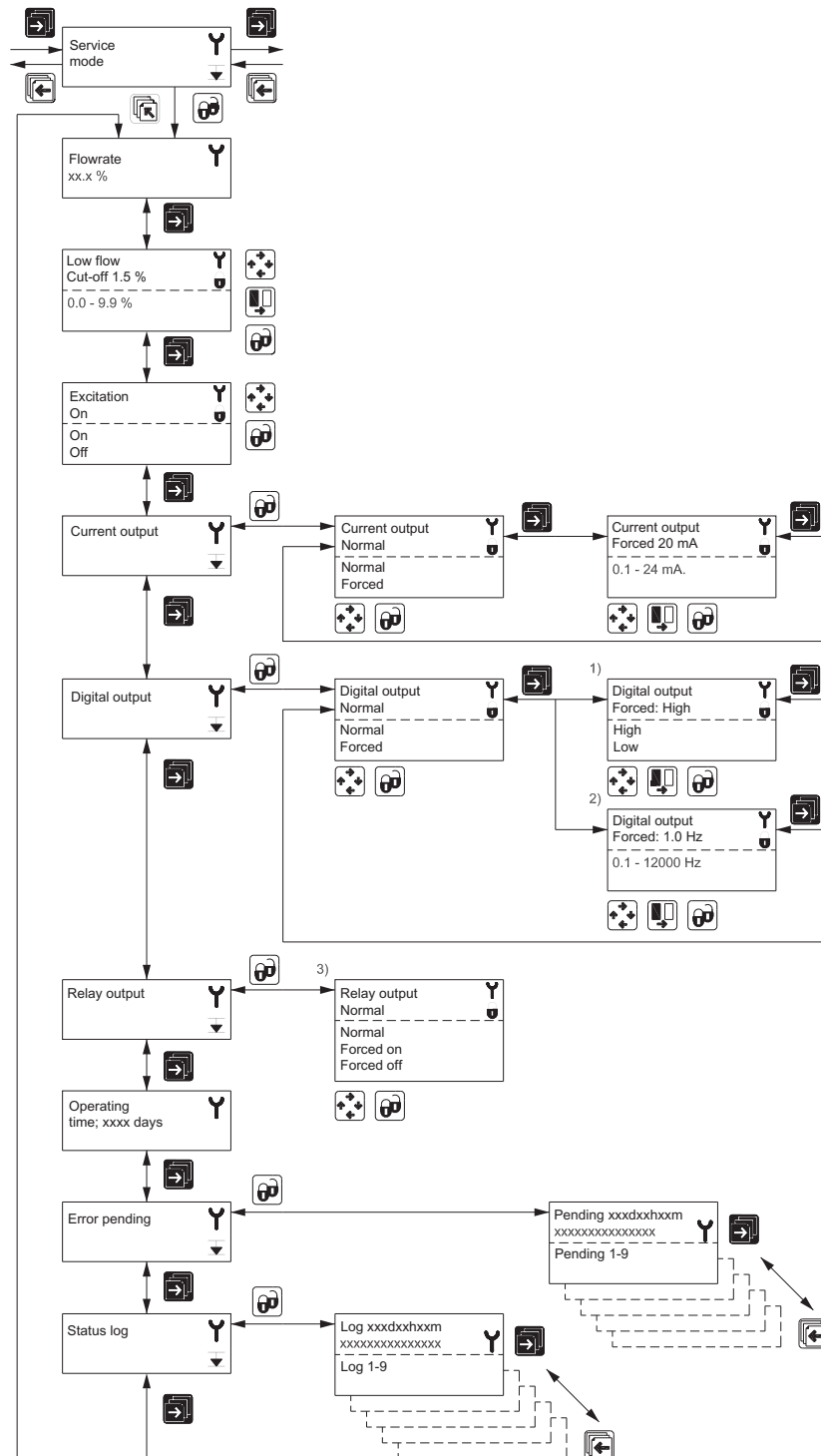

85G936;11\_12.02

- 1) Standard
- 2) If digital input is set to frequency
- 3) Not when relay is set to batch

## A.20 Product identity

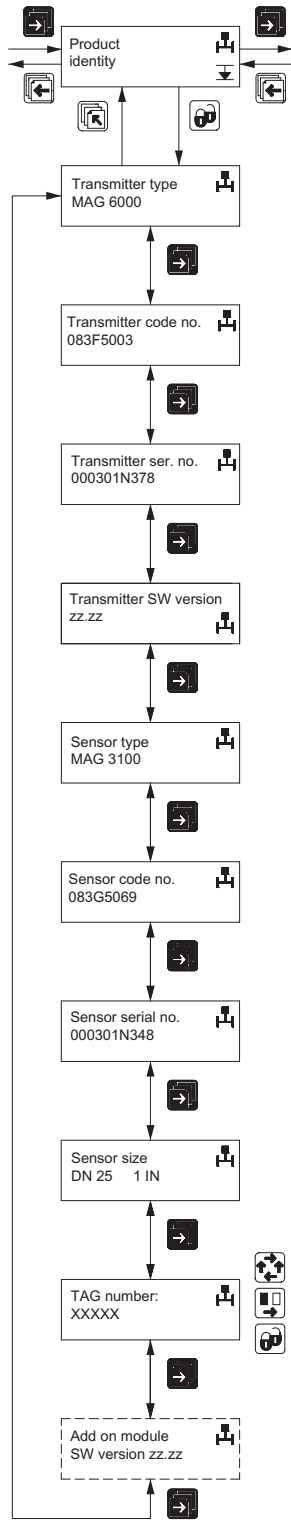

83:0836-11.11.02

## A.21 HART module

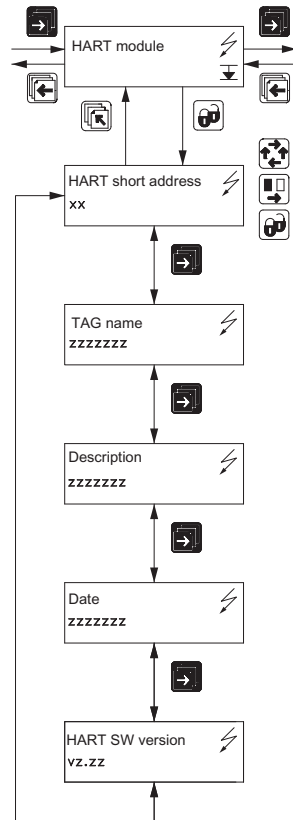

8339506-1 Q11.02



## Appendix

### B.1 Factory settings

The transmitter is delivered with the following factory settings:

Menu item	Parameter	Factory settings	Options	More info
<b>Password</b>	Password	1000	1000 ... 9999	Changing basic settings (Page 40)
<b>Basic settings</b>	Flow direction	Positive	Positive, negative	Basic settings (Page 77)
	Q <sub>max</sub>	Dimension-dependent	Dimension-dependent	
	• <i>volume unit</i>	<i>Dimension-dependent</i>	<i>m<sup>3</sup>, ml, l, hl, kl, Ml, f<sup>3</sup>, in<sup>3</sup>, US G, US kG, US MG, US BBL, UK G, UK MG</i>	
	• <i>time unit</i>	<i>Dimension-dependent</i>	<i>Sec., min., hour, day</i>	
	Totalizer 1	Forward	Forward, reverse, net	
	• <i>Totalizer 1 unit</i>	<i>Dimension-dependent</i>	<i>m<sup>3</sup>, ml, l, hl, kl, Ml, f<sup>3</sup>, in<sup>3</sup>, US G, US kG, US MG, US BBL, UK G, UK MG</i>	
	Totalizer 2	Reverse	Forward, reverse, net	
	• <i>Totalizer 2 unit</i>	<i>Dimension-dependent</i>	<i>m<sup>3</sup>, ml, l, hl, kl, Ml, f<sup>3</sup>, in<sup>3</sup>, US G, US kG, US MG, US BBL, UK G, UK MG</i>	
	Low flow cut-off	1.5%	0 ... 9.9%	
	Empty pipe	Off	On, Off	
	Error level	Warning	Fatal, permanent, warning	
<b>Output</b>	Current output	Off	On/off, Unidirectional/bidirectional, 0 ... 20 mA/4 ... 20 mA	Current output (Page 79)
	• <i>Time constant</i>	<i>5 s</i>	<i>0.1 ... 30 s</i>	
	Digital output	Pulse	Error, direction/limit, batch <sup>1)</sup> , frequency, pulse, error number, off	Direction/limit (Page 81)
	Relay output	Error	Error, direction/limit, cleaning, error number, off	
	Direction/limit switch	Off	1 setpoint, 2 setpoints	
	• <i>Setpoints</i>	<i>0 ... 100%</i>	<i>-100 ... +100%</i>	
	• <i>Hysteresis</i>	<i>5%</i>	<i>0.0 ... 100%</i>	Batch (Page 82)
	Batch <sup>1)</sup>	Off		
	• <i>Batch quantity</i>	<i>0</i>	<i>Dimension-dependent</i>	

Menu item	Parameter	Factory settings	Options	More info
	• <i>Batch compensation</i>	0	-100 ... +100 m3	
	• <i>Batch counter</i>	Down	Up, down	
	• <i>Time constant</i>	0.1 s	0.1 ... 30 s	
	Frequency	Off	500 Hz, 1 kHz, 5 kHz, 10 kHz	Digital output - frequency (Page 80)
	• <i>Time constant</i>	5 s	0.1 ... 30 s	
	Pulse	On		Digital output - pulse (Page 79)
	• <i>Pulse polarity</i>	Positive	Positive, negative	
	• <i>Pulse width</i>	66 ms	64 $\mu$ s, 130 $\mu$ s, 260 $\mu$ s, 510 $\mu$ s, 1.0 ms, 2.0 ms, 4.1 ms, 8.2 ms, 16 ms, 33 ms, 66 ms, 130 ms, 260 ms, 520 ms, 1.0 s, 2.1 s, 4.2 s	
	• <i>Volume/pulse</i>	Dimension-dependent	Dimension-dependent	
	• <i>Time constant</i>	0.1 s	0.1 ... 30 s	
<b>External input</b>	External input	Off	Batch <sup>1)</sup> , reset totalizer, freeze output, forced output, off	External input (Page 83)
	• <i>Batch</i>	Start	Start, hold/continue, stop, Qmax 2	
<b>Sensor characteristics</b>				Sensor characteristics (Page 84)
	Correction factor	1	0.85 ... 2.00	
<b>Language</b>	Language	English	English, German, French, Danish, Swedish, Finnish, Spanish, Russian, Italian, Portuguese, Polish	Language mode (Page 79)
<b>Operator menu</b>	Primary field	Flow rate	Flow rate, Totalizer 1, Totalizer 2	Operator menu setup (Page 78)
	Title/subtitle lines	Flow rate	Flow rate, Flow rate %, Qmax, Totalizer 1, Totalizer 2, Totalizer 1 reset, Totalizer 2 reset, Batch start/paused/stop, Batch cycle counter, Batch cycle counter reset, Sensor size, Sensor type, Error pending, Status log, Tag No.	

<sup>1)</sup>: Available on MAG 6000 only.

## B.2 Sensor dependent factory settings for MAG 5000/6000 Blind

Nominal size		50 Hz		60 Hz	
mm	inch	BASIC SETTING Q-max	OUTPUT SETUP Volume/pulse	BASIC SETTING Q-max	OUTPUT SETUP Volume/pulse
DN 2	1/12	30 l/h	0.1 l	0.13 US GPM	1 US G
DN 3	1/8	70 l/h	0.1 l	0.31 US GPM	1 US G
DN 6	1/4	300 l/h	1 l	1.3 US GPM	1 US G
DN 10	3/8	900 l/h	1 l	4 US GPM	1 US G
DN 15	1/2	2000 l/h	1 l	9 US GPM	1 US G
DN 25	1	5000 l/h	10 l	22 US GPM	1 US G
DN 40	1½	12 m³/h	10 l	52 US GPM	1 US G
DN 50	2	20 m³/h	10 l	88 US GPM	1 US G
DN 65	2½	30 m³/h	100 l	132 US GPM	1 US G
DN 80	3	50 m³/h	100 l	220 US GPM	1 US G
DN 100	4	120 m³/h	100 l	528 US GPM	1 US G
DN 125	5	180 m³/h	100 l	793 US GPM	1 US G
DN 150	6	250 m³/h	100 l	1101 US GPM	1 US G
DN 200	8	400 m³/h	1 m³	1761 US GPM	1 US G
DN 250	10	700 m³/h	1 m³	3082 US GPM	1 US G
DN 300	12	1000 m³/h	1 m³	4402 US GPM	1 US G
DN 350	14	1200 m³/h	1 m³	5283 US GPM	1 US G
DN 400	16	1800 m³/h	1 m³	7925 US GPM	1 US G
DN 450	18	2000 m³/h	1 m³	8806 US GPM	1 US G
DN 500	20	3000 m³/h	1 m³	13 209 US GPM	1 US G
DN 600	24	4000 m³/h	10 m³	17 611 US GPM	10 US G
DN 700	28	5000 m³/h	10 m³	19 812 US GPM	10 US G
DN 750	30	6000 m³/h	10 m³	22 014 US GPM	10 US G
DN 800	32	7000 m³/h	10 m³	30 820 US GPM	10 US G
DN 900	36	9000 m³/h	10 m³	39 626 US GPM	10 US G
DN 1000	40	12 000 m³/h	10 m³	52 834 US GPM	10 US G
DN 1050	42	12 000 m³/h	10 m³	52 834 US GPM	10 US G
DN 1100	44	14 000 m³/h	10 m³	61 640 US GPM	10 US G
DN 1200	48	15 000 m³/h	10 m³	66 043 US GPM	10 US G
DN 1400	54	25 000 m³/h	10 m³	110 072 US GPM	1000 US G
DN 1500	60	30 000 m³/h	10 m³	132 086 US GPM	1000 US G
DN 1600	66	35 000 m³/h	10 m³	154 100 US GPM	1000 US G
DN 1800	72	40 000 m³/h	10 m³	176 115 US GPM	1000 US G
DN 2000	78	45 000 m³/h	10 m³	198 129 US GPM	1000 US G

## B.3 Approvals/certificates

### B.3.1 Certificates

All certificates are posted on the Internet. Additionally, the CE Declaration of Conformity as well as ATEX approvals are available on the Sitrans F literature CD-ROM.

Certificates (<http://support.automation.siemens.com/WW/view/en/10806951/134200>)

# Index

## A

- Add-on module, 13
- Add-on modules
  - Electrical connection: Add-on modules, 35

## C

- Communication module, (See Add-on module)
- Compliance, 11
- Contact person, 9
- Customer Support Hotline, 46

## D

- Decontamination, 47
- Device
  - Identification, 8
  - Inspection, 7

## E

- Electrical connection, 35

## H

- Hotline, 46

## I

- Internet
  - Contact person, 9, 47
  - Flowdocumentation, 9
  - Support, 46
- Introduction, 7

## L

- Laws and directives, 11

## M

- Mains supply, 33
- Maintenance, 45

## P

- Protective conductor terminal, 33
- Protective earth, 33

## R

- Recalibration, 48
- Repair, 46
- Return procedures, 47

## S

- Safety
  - Instrument safety standards, 11
- Safety notes, 11
- Service, 46
- Support, 46
- System components, 13

## W

- Wire insulation, 33

## For more information

[www.siemens.com/flow](http://www.siemens.com/flow)

Siemens Flow Instruments A/S  
Nordborgvej 81  
DK-6430 Nordborg

Subject to change without prior notice  
Order No.: A5E02338368-01  
Copyright Siemens AG 01.2010  
All rights reserved



A 5 E 0 2 3 3 8 3 6 8 - 0 1

[www.siemens.com/processautomation](http://www.siemens.com/processautomation)