







<p>System PKZ 0- Motor Protector</p>	<p>Overview</p>	<p>7/2</p>
	<p>Manual Motor Protector Motor Protector for high inrush loads Motor Protector Combinations with Contactor NEC Group Motor Application Ratings</p>	<p>7/6 7/8</p>
	<p>Auxiliary Contacts Voltage Trips (High Capacity) Magnetic Contactors + Accessories</p>	<p>7/10 7/11 7/12</p>
	<p>Enclosures, Housings Handles, Accessories Wiring accessories: Feeder Connectors Bus Bar Adapters Mounting & Wiring System MVS</p>	<p>7/14 7/15 7/16 7/17 7/18</p>
<p>System PKZ 2- Motor Protector</p>	<p>Overview</p>	<p>7/20</p>
	<p>Manual Motor Protector Motor Protector Combinations with Contactor NEC Group Motor Application Ratings Motor Protector without Protective Trip Module Protective Trip Module</p>	<p>7/24 7/25 7/26</p>
	<p>Auxiliary Contacts Voltage Trips Remote Control Drives High Capacity Magnetic Contactors + Accessories</p>	<p>7/28 7/29 7/30 7/32</p>
	<p>Enclosures, Housings Handles, Accessories Wiring accessories: Feeder Connectors Bus Bar Adapters</p>	<p>7/36 7/37 7/37 7/38</p>
	<p>System PKZ 0- Motor Protector Coil Voltage Ratings System PKZ 2- Motor Protector Coil Voltage Ratings</p>	<p>7/39 7/40</p>
	<p>Technical Data- System PKZ 0 - Motor Protector - Electrical Life Curves - Let-through Current and Energy Curves - General Technical Information - Short Circuit Ratings IEC/EN 60 947</p>	<p>7/42 7/43 7/44 7/47</p>
	<p>Technical Data- System PKZ 2 - Motor Protector - Electrical Life Curves - Let-through Current and Energy Curves - General Technical Information - Short Circuit Ratings IEC/EN 60 947</p>	<p>7/48 7/49 7/50 7/54</p>
	<p>Dimensions</p>	<p>7/55</p>



System **PKZ 0** refers to all of the components and accessories which make up the line of **PKZM 0** Motor Protectors. It is a modular system, with ample flexibility and comprehensive ratings to accommodate a broad range of industrial control motor switching and protection requirements. System **PKZ 0** components are in compliance with all pertinent international and domestic standards and can be installed world-wide. Maximum ratings: 25 Amps, 600 V AC

1 Manual Motor Protector

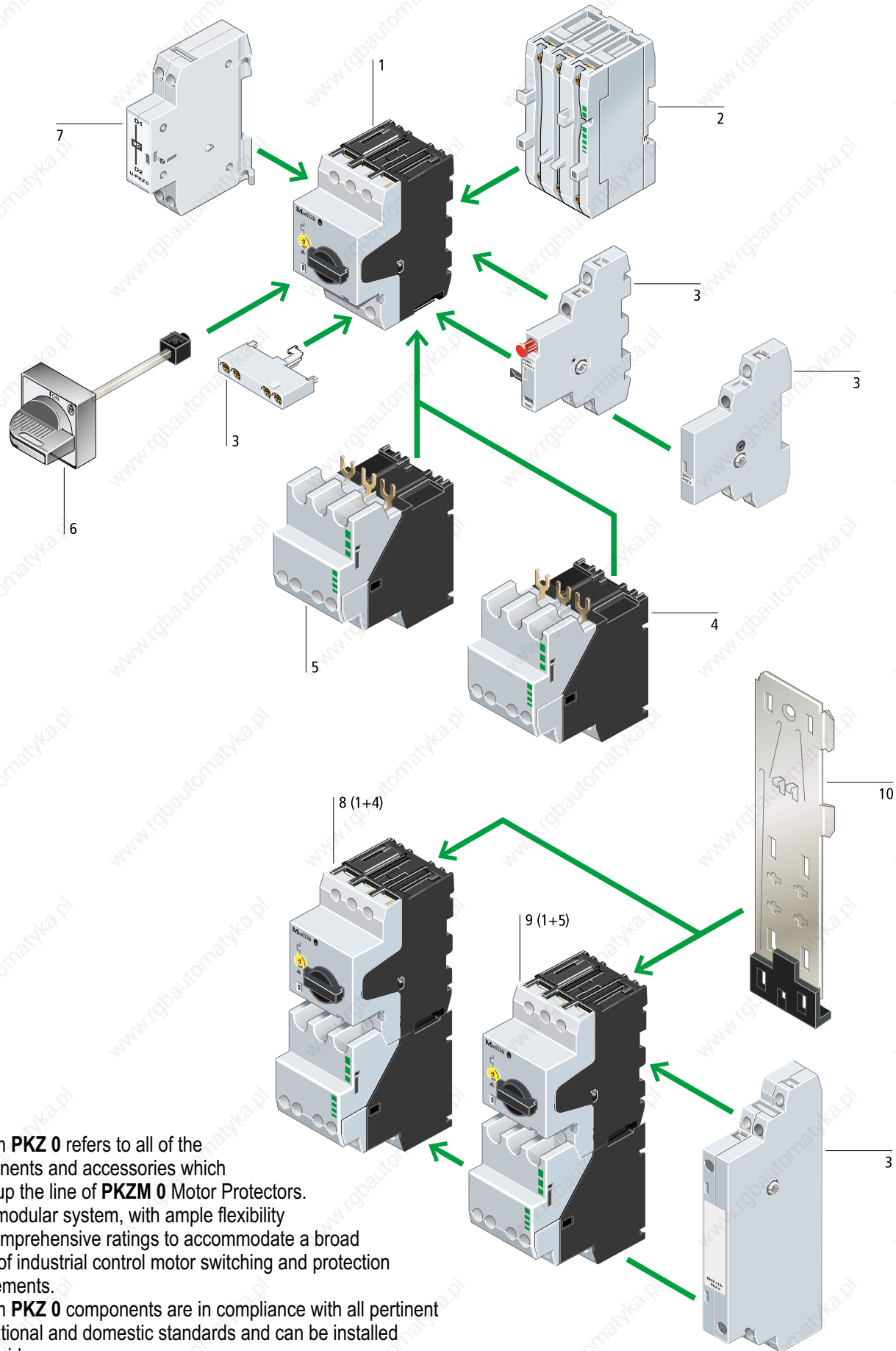
Thermal-Magnetic Motor Protector
 Rated up to 25 Amps
 Maximum 3 Phase HP rating: 15/ 20 @ 460/ 575 V AC
 UL Listed for Group installations per NEC 430-53
 CSA Certified for Group installations per CEC Part 1, 28-206
 High Short Circuit Rating: Up to 50 kA @ 600 V AC
 UL Listed, CSA Certified, in Conformity with IEC/EN 60 947
 CE Marked
 Type: **PKZM 0-...**

2 Current Limiter Module

Increases short circuit current rating of the **PKZM 0**.
 Fuseless, current limiting set of contacts housed in a module.
 Mounts directly beneath or ahead of the **PKZM 0**.
 Type: **CL-PKZ 0**

3 Auxiliary Contact Modules

Signals ON/OFF status of **PKZM 0** Motor Protector and Motor Protector + Contactor combination.
 Trip indicating contacts which differentiate between overload and short circuit tripping.
 Early-Make contacts for use with undervoltage trips.
 Type: **NHI-..., AGM-..., VHI-...**

4 Magnetic Contactor Module

AC or DC operated versions.
 Supplied with 1 N.O./1N.C. or 2 N.O. contacts.
 Plugs into the load side of the **PKZM 0** protector or can be separately mounted.
 Rated 7 1/2 HP @ 460 V AC/ 10 HP @ 575 V AC
 UL Listed with **PKZM 0** Motor Protector for Group installations per NEC 430-53.
 CSA Certified with **PKZM 0** Motor Protector for Group installations per CEC 28-206.
 IEC 60 947-4-1 rated for Type 1 co-ordination.
 Type: **SE 00-...**

5 High Capacity Magnetic Contactor Module

Same approvals & features as Type **SE00** above except:
 Internal current limitation feature to increase short circuit current rating and self-protection characteristics per IEC/EN 60 947.
 IEC 60 947-4-1 rated for Type 2 co-ordination.
 Type: **S 00**

6 Door Mounted Handle

Rated IP 65/ NEMA/UL 12, 3R.
 3 Positions- ON, OFF, Tripped.
 Door interlocking feature and padlockable with up to 3 padlocks. (Also available without door interlocking or padlockable feature.)
 Plug-in extension shaft to accommodate various mounting depths.
 Black, or Red/Yellow for E-Stop function
 Type: **(R)H-PKZ 0, HSOV-PKZ 0**

7 Voltage trips

Undervoltage trip module
 Shunt trip module
 Mounts to the side of the **PKZM 0**.
 Type: **U-PKZ0, A-PKZ0**

8(1+4) Magnetic Motor Protector Combination

Thermal-Magnetic Motor Protector (1) combined with the Magnetic Contactor Module (4) on a clip plate, suitable for DIN rail mounting (EN 50 022).
 Maximum rating: 7 1/2 HP @ 460 V AC/ 10 HP @ 575 V AC
 UL Listed for Group installations per NEC 430-53.
 CSA Certified for Group installations per CEC 28-206.
 High Short Circuit Rating: Up to 50 kA @ 600 V AC
 UL Listed, CSA Certified, in Conformity with IEC/EN 60 947 IEC 60 947-4-1 rated for Type 1 co-ordination.
 CE Marked
 Type: **PKZM 0-.../SE 00**

9(1+5) Magnetic Motor Protector Combination with High Capacity Contactor

Thermal-Magnetic Motor Protector (1) combined with the High Capacity Magnetic Contactor Module (5) on a clip plate, suitable for DIN rail mounting (EN 50 022).
 Maximum rating: 7 1/2 HP @ 460 V AC/ 10 HP @ 575 V AC
 UL Listed for Group installations per NEC 430-53
 CSA Certified for Group installations per CEC 28-206.
 High Short Circuit Rating: Up to 50 kA @ 600 V AC
 UL Listed, CSA Certified, in Conformity with IEC/EN 60 947 IEC 60 947-4-1 rated for Type 2 co-ordination.
 CE Marked
 Type: **PKZM 0-.../S 00**

10 Mounting/Wiring

Clip plate, onto which the compact motor protector combinations **PKZM 0-.../S(E) 00** are mounted.
 Suitable for DIN rail mounting (EN 50 022).
 Other Mounting/Wiring Hardware:
 - Adapters for direct busbar feeds in control panels.
 - Mounting and Wiring system Type **MVS-...** to combine **PKZM 0** protectors with Type **DIL...M** magnetic contactors. (Refer to Section 3 for **DIL...M** info.)
 Refer to pages 7/16-18 for additional details on these mounting and wiring accessories.

System PKZ 0- Motor Protector Overview of Combinations

The possible combinations of open and enclosed motor protectors with various accessories is indicated by a dot ● in each shaded row.

Open Devices, Enclosures

Contacts and Modules

Standard Auxiliary Contacts



NHI 11-PKZ 0
NHI 21-PKZ 0
NHI 12-PKZ 0

Standard Auxiliary Contacts



NHI-E-11-PKZ 0
NHI-E-10-PKZ 0

Early Make Auxiliary Contacts







VHI 20-PKZ 0

Trip Indicating Contacts

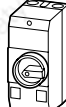

AGM 2-10-PKZ 0
AGM 2-01-PKZ 0

Type	Type	Degree of Protection	NHI 11-PKZ 0 NHI 21-PKZ 0 NHI 12-PKZ 0	NHI-E-11-PKZ 0 NHI-E-10-PKZ 0	VHI 20-PKZ 0	AGM 2-10-PKZ 0 AGM 2-01-PKZ 0
Manual Motor Protector						
PKZM 0-...	-	IP 20	●	● or	●	●
	Insulated Enclosure for Flush Mounting					
	E-PKZ 0	Front IP 40	● -	- -	- -	- -
	E-PKZ 0-G(R)	Front IP 55	● -	● ●	- -	● -
	Insulated Enclosure for Surface Mounting					
	CI-PKZ 0	IP 40 UL/NEMA 1	● -	- -	- -	- -
	CI-PKZ 0-G(R)	IP 55 UL/NEMA 12	● -	● ●	- -	● -
	CI-PKZ 0-G(R)V	IP 55 UL/NEMA 12	- -	- -	● -	- -
	Motor Protector Combination					
	PKZM 0-.../S(E) 00	IP 20	● -	● or ● or	● ●	● -
	Insulated Enclosure for Surface Mounting					
CI 23X -125-NA	IP 65 UL/NEMA 12	● -	● or ● or	● ●	● -	
						

Manual Motor Protectors, Motor Protectors with Contactor
Motor Starter Combinations

7

System PKZ 0- Motor Protector Overview of Combinations

Standard Auxiliary
Contacts



NH12-11S-PKZ 0

Contactor



SE 00-...PKZ 0
S 00-...PKZ 0

Undervoltage
Trip



U-PKZ 0

Shunt Trip



A-PKZ 0

Door Mounting
Handle



H-PKZ 0
RH-PKZ 0
HSOV-PKZ 0

Indicating Light



L-PKZ 0

Standard Auxiliary Contacts	Contactor	Undervoltage Trip	Shunt Trip	Door Mounting Handle	Indicating Light
-	●	● or	●	●	-
-	-	- or	-	-	●
-	-	● or	●	-	●
-	-	- or	●	-	●
-	-	●	-	-	●
●	-	● or	●	●	-
●	-	● or	●	● IP 65 ● IP 65	●

Manual Motor Protectors, Motor Protectors with Contactor
Motor Starter Combinations

7



1	2	3	4	5
	Circuit Diagram	UL/CSA 3 Phase HP Ratings (Single phase ratings & IEC kW Ratings, see pages 7/44 & 7/45)	Type	Price
		200 V 230 V 460 V 575 V		\$

Manual Motor Protectors

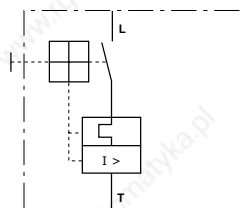

In this range select Motor Protector in accordance with the Motor nameplate Full Load Current.

1/2	1/2	1	1 1/2
1	1	2	3
1 1/2	1 1/2	3	5
3	3	7 1/2	10
3	5	10	10
5	5	10	15
5	7 1/2	15	20

- PKZM 0-0.16
- PKZM 0-0.25
- PKZM 0-0.4
- PKZM 0-0.63
- PKZM 0-1
- PKZM 0-1.6
- PKZM 0-2.5
- PKZM 0-4
- PKZM 0-6.3
- PKZM 0-10
- PKZM 0-16
- PKZM 0-20
- PKZM 0-25

Manual Motor Protectors

For more inductive loads-Higher inrush currents

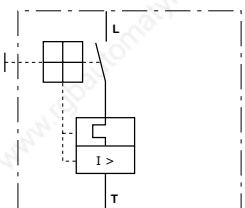

In this range select Motor Protector in accordance with the Motor nameplate Full Load Current.

1/2	1/2	1	1 1/2
1	1	2	3
1 1/2	1 1/2	3	5
3	3	7 1/2	10
3	5	10	10
5	5	10	15

- PKZM 0-0.16-T
- PKZM 0-0.25-T
- PKZM 0-0.4-T
- PKZM 0-0.63-T
- PKZM 0-1-T
- PKZM 0-1.6-T
- PKZM 0-2.5-T
- PKZM 0-4-T
- PKZM 0-6.3-T
- PKZM 0-10-T
- PKZM 0-16-T
- PKZM 0-20-T

The **PKZM 0...(-T)** is a 3 phase thermal-magnetic motor protective device incorporating adjustable bimetal trips for motor overload protection and magnetic trips to de-energize the motor circuit in case of a short circuit. The **PKZM 0...-T** has its magnetic trip set at a higher response level to provide better protection against nuisance tripping in circuits with higher current inrush ratings e.g. in circuits employing control circuit transformers. The **PKZM 0...** and the **PKZM 0...-T** are UL listed and CSA certified as HP rated motor controllers which provide motor running overload protection. In addition, they are UL listed and CSA certified for group applications as per NEC 430-53(c) and GEC part 1, Rule 28-206. This means that a group of motors, each protected and controlled by a **PKZM 0...** or a **PKZM 0...-T** can be combined under a single branch circuit short circuit and ground fault protective device, the maximum rating of which is marked on each **PKZM 0** motor protector. (See columns 8-10 for UL/CSA short circuit current and backup overcurrent protection ratings.)

Features:

- Ratings: 25 Amp, 600 V AC - 15 HP @ 460 V, 20 HP @ 575 V max.
- Approved for world markets = UL, CSA, IEC/EN 60 947, CE Marked
- Phase failure sensitive & ambient compensated.
- Adjustable thermal trips set to motor FLC or nameplate current.
- Fixed instantaneous magnetic trip response.
- Open or door mounted handle, padlockable, with 3 position indication (ON, OFF, Trip). See Accessories on page 7/15
- 'Finger Safe' construction.
- 35 mm DIN rail or panel mounting.

Ordering Information:

Specify Type from column 4. Example: **PKZM0-10**

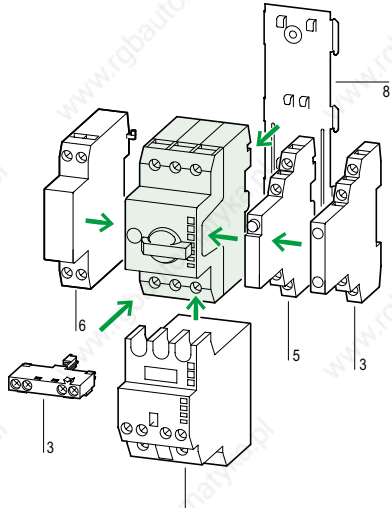
6	7	8	9	10	11
Adjustable Thermal Range	Response Current of Magnetic Trips	UL/CSA Short Circuit Current Rating @ 600 V AC.	Maximum Listed Branch Circuit Protective Fuse	Maximum Listed Branch Circuit Protective Breaker	Remarks
A	A	kA	A	A	
0.1 - 0.16	2.2	50	600	600	 <p>1 - PKZM 0(-T) Motor Protector 7/6 2 - Side-mounted Auxiliary Contact 7/10 3 - Top-mounted Auxiliary Contact 7/10 4 - Trip Indicating Auxiliary Contact 7/11 5 - Shunt Trip Undervoltage Trip 7/11 6 - Magnetic Contactor Module* 7/12 7 - Clip Plate 7/15 - Accessories 7/10 - 7/19</p> <p>* Note: The PKZM 0-...-T cannot be combined with the high capacity contactor module (Type S 00).</p>
0.16 - 0.25	3.4	50	600	600	
0.25 - 0.4	5.6	50	600	600	
0.4 - 0.63	8.8	50	600	600	
0.63 - 1	14	50	600	600	
1 - 1.6	22	50	600	600	
1.6 - 2.5	35	50	600	600	
2.5 - 4	56	50	600	600	
4 - 6.3	88	50	600	600	
6.3 - 11	140	22 ¹⁾	150	125	
10 - 16	224	10 ¹⁾	150	125	
16 - 20	280	10 ¹⁾	150	125	
20 - 25	350	10 ¹⁾	150	125	
0.1 - 0.16	2.4	50	600	600	
0.16 - 0.25	4.25	50	600	600	
0.25 - 0.4	6.8	50	600	600	
0.4 - 0.63	11.97	50	600	600	
0.63 - 1	20	50	600	600	
1 - 1.6	32	50	600	600	
1.6 - 2.5	50	50	600	600	
2.5 - 4	84	50	600	600	
4 - 6.3	141	50	600	600	
6.3 - 11	224	22 ¹⁾	150	125	
10 - 16	358	10 ¹⁾	150	125	
16 - 20	380	10 ¹⁾	150	125	

Manual Motor Protectors, Motor Protectors with Contactor Motor Starter Combinations

System PKZ 0 Motor Protectors in Group Motor Applications

PKZM 0 motor protectors are UL listed and CSA certified for group applications as per the intent of NEC 430-53 and CEC part 1, Rule 28-206. This eliminates the need for individual motor branch circuit overcurrent protective devices for each motor, thus greatly reducing the cost and space requirements of industrial control panels and assemblies.

In group installations involving a number of **PKZM 0** motor protectors, the maximum rating of the group branch circuit overcurrent protective device is based on the lowest backup overcurrent rating marked on each motor protector in the group, combined with applicable NEC installation rules.

Please refer to the UL/CSA short circuit current and backup overcurrent protection ratings in columns 8-10 for selection guidelines on **PKZM 0** Motor protectors.

1) Higher short circuit ratings can be obtained by use of the **CL-PKZ0** accessory: (See page 7/11).
 - **PKZM 0-... + CL-PKZ0**: 50 kA @ 600 V AC, for 10 A and 16 A models
 - **PKZM 0-... + CL-PKZ0**: 18 kA @ 600 V AC, for 20 A and 25 A models

System PKZ 0 Magnetic Motor Protector Combinations Type PKZM 0.../S(E) 00

UL / CSA / IEC / CE

1	2	3	4	5
	<p>Circuit Diagram</p> <p>Contactors supplied standard with 1 N.O. & 1 N.C. Auxiliary contacts.</p>	<p>UL/CSA 3 Phase HP Ratings</p> <p>(Single phase ratings & IEC kW Ratings, see pages 7/44 & 7/45)</p>	<p>Type</p>	<p>Price</p>
		<p>200 V 230 V 460 V 575 V</p>		

Magnetic Motor Protector Combination

UL/CSA Group installations
IEC/EN 60 947-4-1 "Type 1" co-ordination level

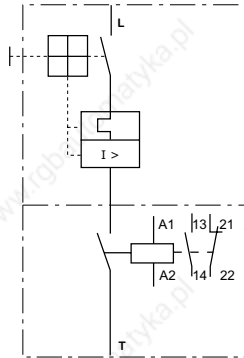

In this range select Motor Protector in accordance with the Motor nameplate Full Load Current.

1/2	1/2	1	1 1/2
1	1	2	3
1 1/2	1 1/2	3	5
2	3	7 1/2	10

Specify Coil Voltage from page 7/39 when ordering (...)

- PKZM 0-0.16/SE 00-11 (...)
- PKZM 0-0.25/SE 00-11 (...)
- PKZM 0-0.4/SE 00-11 (...)
- PKZM 0-0.63/SE 00-11 (...)
- PKZM 0-1/SE 00-11 (...)
- PKZM 0-1.6/SE 00-11 (...)
- PKZM 0-2.5/SE 00-11 (...)
- PKZM 0-4/SE 00-11 (...)
- PKZM 0-6.3/SE 00-11 (...)
- PKZM 0-10/SE 00-11 (...)

Magnetic Motor Protector Combination with High Capacity Contactor

UL/CSA Group installations
IEC/EN 60 947-4-1 "Type 2" co-ordination level

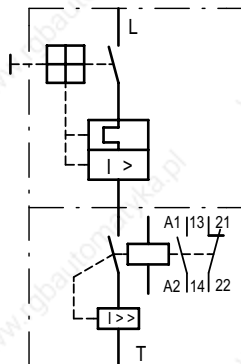

In this range select Motor Protector in accordance with the Motor nameplate Full Load Current.

1/2	1/2	1	1 1/2
1	1	2	3
1 1/2	1 1/2	3	5
2	3	7 1/2	10

Specify Coil Voltage from page 7/39 when ordering (...)

- PKZM 0-0.16/S 00-11 (...)
- PKZM 0-0.25/S 00-11 (...)
- PKZM 0-0.4/S 00-11 (...)
- PKZM 0-0.63/S 00-11 (...)
- PKZM 0-1/S 00-11 (...)
- PKZM 0-1.6/S 00-11 (...)
- PKZM 0-2.5/S 00-11 (...)
- PKZM 0-4/S 00-11 (...)
- PKZM 0-6.3/S 00-11 (...)
- PKZM 0-10/S 00-11 (...)

The PKZM 0.../SE 00 and PKZM 0.../S 00 are motor protector combinations made up of PKZM 0... manual motor protectors (see page 7/6) and System PKZ 0 magnetic contactors (Types SE 00 and S 00).

These Motor Protector combinations are UL listed and CSA certified as assemblies which provide motor controller functions and running overload protection. In addition, they are UL listed and CSA certified for group applications as per NEC 430-53(c) and CEC part 1, Rule 28-206. This means that a group of motors, each protected and controlled by a PKZM 0.../S(E) 00, can be combined under a single branch circuit short circuit and ground fault protective device, the maximum rating of which is marked on each PKZM 0 motor protector. (See columns 8-10 for UL/CSA short circuit current and backup overcurrent protection ratings.)

Features:

- Ratings: 11 Amp, 600 V AC - 7 1/2 HP @ 460 V, 10 HP @ 575 V max.
- Approved for world markets = UL, CSA, IEC/EN 60 947, CE Marked
- Conformity with "Type 1" and "Type 2" co-ordination levels
- Phase failure sensitive & ambient compensated.
- Adjustable thermal trips set to motor FLC or nameplate current.
- Fixed instantaneous magnetic trip response.
- Open or door mounted handle, padlockable, with 3 position indication (ON, OFF, Trip). See Accessories on page 7/15
- 'Finger Safe' construction.
- Assembled on clip plate for 35 mm DIN rail or panel mounting.

Ordering Information: Specify Type from column 4 and add desired control voltage. Example: PKZM 0-10/SE 00-11 (120V, 60Hz)

6	7	8	9	10	11
Adjustable Thermal Range (Set to Motor FLC)	Response Current of Magnetic Trips	UL/CSA Short Circuit Current Rating RMS Sym @ 600 V AC.	Maximum Listed Branch Circuit Protective Fuse	Maximum Listed Branch Circuit Protective Circuit Breaker	Remarks
A	A	kA	A	A	

0.1 - 0.16	2.2	50	600	600
0.16 - 0.25	3.4	50	600	600
0.25 - 0.4	5.6	50	600	600
0.4 - 0.63	8.8	50	600	600
0.63 - 1	14	50	600	600
1 - 1.6	22	50	600	600
1.6 - 2.5	35	50	600	600
2.5 - 4	56	50	600	600
4 - 6.3	88	50	600	600
6.3 - 11	140	22	150	125

System PKZ 0 Motor Protector Combinations & Accessories

- 1 - **PKZM 0/S(E) 00-11**
Motor Protector Combination
- 2 - Side Mounted Auxiliary Contact 7/10
- 3 - Top Mounted Auxiliary Contact 7/10
- 4 - Side Mounted Auxiliary Contact to fit over entire starter 7/11
- 5 - Trip Indicating Auxiliary Contact 7/11
- 6 - Shunt Trip Undervoltage Trip 7/11
- 7 - Clip Plate 7/12

Additional Accessories 7/10 - 7/19

Note:
DC operated versions come standard with built-in surge suppressors.
Surge Suppressors available for AC versions as an option. See page 7/12

Group Motor Applications

PKZM 0.../S(E) 00 Motor Protector combinations are UL listed and CSA certified for group applications as per the intent of NEC 430-53 and CEC part 1, Rule 28-206. This eliminates the need for individual motor branch circuit overcurrent protective devices for each motor, thus greatly reducing the cost and space requirements of industrial control panels and assemblies.

In group installations involving a number of System **PKZ 0** motor protectors, the maximum rating of the group branch circuit overcurrent protective device is based on the lowest backup overcurrent rating marked on each motor protector in the group, combined with applicable NEC installation rules.









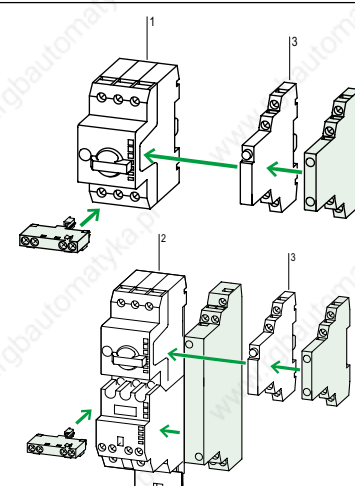
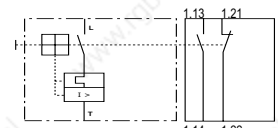
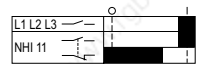
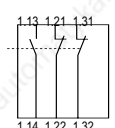

Please refer to the UL/CSA short circuit current and backup overcurrent protection ratings in columns 8-10 for selection guidelines on **PKZM 0** and **PKZM 0.../S(E) 00** motor protectors.

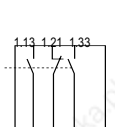
Additional Notes:

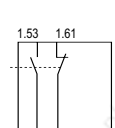

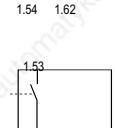

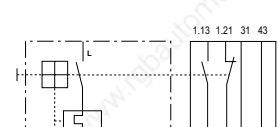

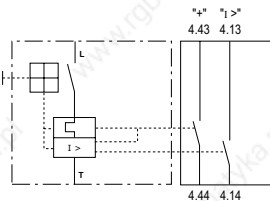
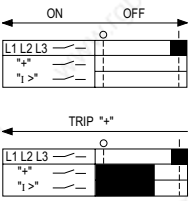
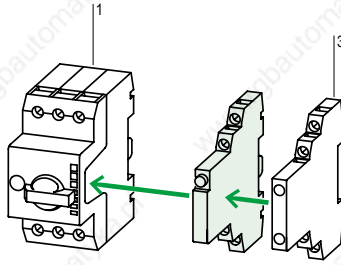
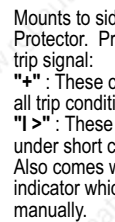
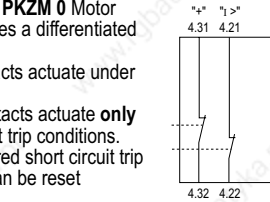
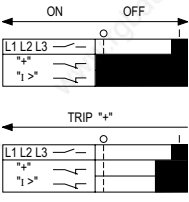

PKZM 0.../SE 00 Motor Protector combinations are in conformity with Type 1 co-ordination levels @ up to 500 V AC, per IEC/EN 60 947-4-1.

PKZM 0.../S 00 Motor Protector combinations are in conformity with Type 2 co-ordination levels @ up to 500 VAC, per IEC/EN 60 947-4-1. Further, during UL/CSA short circuit testing of this combination, no heater burn-out or contact welding occurred.

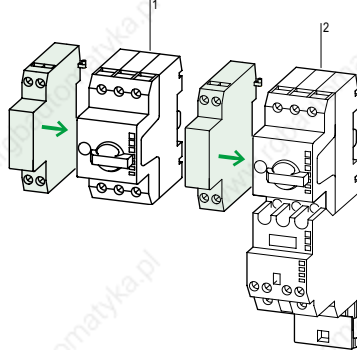
System PKZ 0- Motor Protector Accessories- Auxiliary Contacts

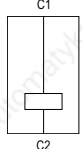
1	2	3	4	5	6	7
	Connection Diagram	Auxiliary Contact state in relation to Main Contacts	Number of Contacts N.O. = Normally Open N.C. = Normally Closed N. O. N. C.	Type	Price \$	Remarks
Manual Motor Protectors, Motor Protectors with Contactor Motor Starter Combinations 7 Clips onto top portion of PKZM 0 Motor Protector	Standard Auxiliary Contacts Short Version- Side Mounted		1	1	NHI 11-PKZ 0	 <p>1 - Manual Motor Protector 7/6 2 - Motor Protector Combinations 7/8 3 - Trip Indicating Contact 7/11</p> <p>The Side Mounted contacts (Short Version) mount on the right side of the protector and can be combined with:</p> <ul style="list-style-type: none"> - Trip indicating contacts Type AGM... - Top-Mounted contacts Type NHI-E... <p>but cannot be combined with the long version contact module Type NHI2-11S-PKZ0.</p> <p>The Top-Mounted contacts Type NHI-E... have the added benefit of not increasing the width or height of the Motor Protector when inserted.</p> <p>The long version contact module Type NHI2-11S-PKZ0 mounts on the right side of the PKZM0/S(E) 00 Motor Protector Combination and can be combined with:</p> <ul style="list-style-type: none"> - Top-Mounted contacts Type NHI-E... <p>but cannot be combined with:</p> <ul style="list-style-type: none"> - Short version contact Modules Type NHI... - Trip indicating contacts Type AGM... <p>Ordering Information: If ordered separately: - Specify Type from Column 5 Example: NHI 21-PKZ 0 If ordered with device: - Add a + in front of Type Example: + NHI 21-PKZ 0</p>
	 	1	1	NHI 11-PKZ 0		
	 	1	2	NHI 12-PKZ 0		
	 	2	1	NHI 21-PKZ 0		
	Standard Auxiliary Contacts Top Mounted		1	1	NHI-E-11-PKZ 0	
	 	1	1	NHI-E-11-PKZ 0		
	 	1	0	NHI-E-10-PKZ 0		
	Standard Auxiliary Contacts Long Version- Side Mounted		2	2	NHI 2-11S-PKZ 0	
	 	2	2	NHI 2-11S-PKZ 0		
Mounts on side of PKZM 0/S(E) 00 protector combination. Features two sets of contacts: - One set actuated by Motor Protector - One set actuated by Contactor Permits differentiated signalling of the state of Motor Protector and Contactor Main Contacts.						

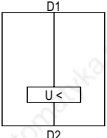
System PKZ 0- Motor Protector Accessories- Auxiliary Contacts, Voltage Trips

1	2	3	4	5	6	7	
	Connection Diagram	Auxiliary Contact state in relation to Main Contacts	Number of Contacts N.O. = Normally Open N.C. = Normally Closed N.O. N.C.	Type	Price	Remarks	
Trip Indicating Auxiliary Contacts							
			2 0	AGM 2-10-PKZ 0	See Price List	 <p>1 - Manual Motor Protector 7/6 3 - Standard Auxiliary Contact 7/10 - Accessories 7/13</p> <p>The AGM... trip indicating contact mounts on the right side of the Motor Protector and can be combined with: Standard Auxiliary Contacts: NHI 11-PKZ 0 NHI 12-PKZ 0 NHI 21-PKZ 0 NHI-E-PKZ 0 It cannot be combined with the long version auxiliary contact: NHI 2-11S-PKZ 0</p>	
			0 2	AGM 2-01-PKZ 0	See Price List		
Early-Make Auxiliary Contacts							
			2 0	VHI 20-PKZ 0	See Price List	<p>Clips onto top portion of PKZM 0 Motor Protector. Ideally used in combination with the undervoltage trip module in Emergency-Stop circuits</p>  <p>1 - Manual Motor Protector 7/6 2 - Motor Protector Combinations 7/8</p> <p>Voltage trip modules mount on the left side of the main device.</p> <p>A-PKZ 0 shunt trips cannot be combined with U-PKZ 0 undervoltage trips. The DC version is rated for short time duty: Max. 5 sec.</p> <p>U-PKZ 0 undervoltage trips cannot be combined with A-PKZ 0 shunt trips. Can be used in conjunction with the Motor Protector PKZM 0 and VHI early-make contacts to provide Emergency-Stop functions.</p>	
Voltage trips							
Shunt Trip AC and DC ratings							
				A-PKZ 0 (...) A-PKZ 0 (...) DC	See Price List	<p>Insert desired Voltage rating from page 7/39</p>	
Undervoltage Trip AC ratings							
				U-PKZ 0 (...)	See Price List		
Fuseless Current Limiter							
		Used to increase the short circuit rating of Motor Protectors and Motor Protector Combinations. Mounts beneath or next to PKZM 0 Motor Protector.		CL- PKZ 0	See Price List		

Manual Motor Protectors, Motor Protectors with Contactor
Motor Starter Combinations

7

Ordering Information:

- If ordered separately: Specify Type from Column 5. Example: **U-PKZ 0 (120V, 60Hz)**
- If ordered with device: Add a + in front of Type: Example: **+ U-PKZ 0 (120V, 60 Hz)**

System PKZ 0- Motor Protector Contactors and Accessories, Auxiliary Contacts, Surge Suppressors

1	2	3	4	5
	Connection Diagram	UL/CSA Maximum 3 Phase HP Rating @: (Single phase ratings: page 7/44)	Number of Contacts N.O. = Normally Open N.C. = Normally Closed	For Use With:
		200 V 230 V 460 V 575 V	N. O. N. C.	

Magnetic Contactor Module

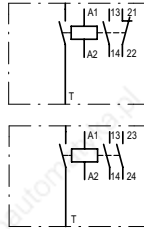

2	3	5	5	1	1	PKZM 0
2	3	5	5	2	-	PKZM 0
2	3	5	5	2	-	PKZM 0
2	3	5	5	1	1	PKZM 0

High Capacity Magnetic Contactor Module with Current Limiting Contact Assembly

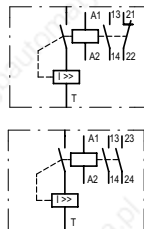

2	3	5	5	1	1	PKZM 0
2	3	5	5	2	-	PKZM 0
2	3	5	5	2	-	PKZM 0
2	3	5	5	1	1	PKZM 0

Plug-fit into load side
of Motor Protector

Surge Suppressors for AC Contactor Coils

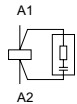

Voltage Range (50,60Hz):

24 - 48 V AC
110 - 250 V AC

S(E)00-...-PKZ 0
S(E)00-...-PKZ 0

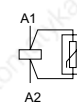

24 - 48 V AC
110 - 250 V AC
380 - 415 V AC

S(E)00-...-PKZ 0
S(E)00-...-PKZ 0
S(E)00-...-PKZ 0

Base for separate mounting



S(E)00-PKZ 0 (...)
HI 11-S/EZ-PKZ 0

Mechanical Interlock



S(E)00-PKZ 0 (...)
PKZM 0-../S(E)00

Auxiliary contact module

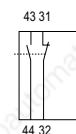



1 1 S(E)00 + EZ-PKZ 0

Manual Motor Protectors, Motor Protectors with Contactor
Motor Starter Combinations



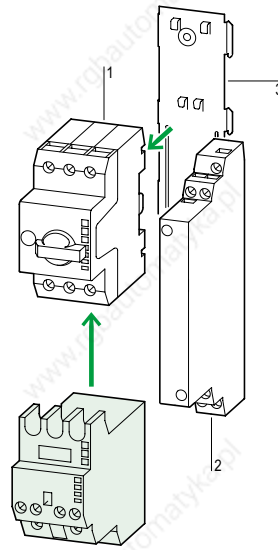
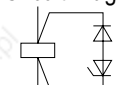
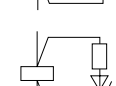

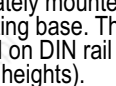
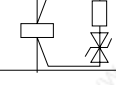
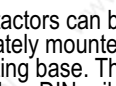

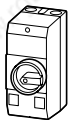

7

System PKZ 0- Motor Protector Contactors and Accessories, Auxiliary Contacts, Surge Suppressors

6 Type	7 Price	8 Notes	9 Remarks
<p>Specify Coil Voltage from page 7/39 when ordering ↓</p> <p>SE00-11-PKZ 0 (...)</p> <p>SE00-20-PKZ 0 (...)</p> <p>SE00-20-PKZ 0 (...V DC)</p> <p>SE00-11-PKZ 0 (...V DC)</p> <p>Specify Coil Voltage from page 7/39 when ordering ↓</p> <p>S00-11-PKZ 0 (...)</p> <p>S00-20-PKZ 0 (...)</p> <p>S00-20-PKZ 0 (...V DC)</p> <p>S00-11-PKZ 0 (...V DC)</p>	<p>See Price List</p> <p>See Price List</p> <p>See Price List</p> <p>See Price List</p> <p>See Price List</p> <p>See Price List</p> <p>See Price List</p> <p>See Price List</p>	<p>SE 00 and S 00 contactors are only suitable for use with PKZM 0 protectors.</p> <p>The Contactors are designed to plug into the load side of the PKZM 0 Motor Protector to form a compact and contoured fit.</p> <p>A clip plate (see figure at right), onto which the combination is mounted, is a necessary part of the assembly and must be ordered separately if the Motor Protector combination is not purchased complete as shown on page 7/8.</p> <p>S(E) 00 contactors can also be Individually mounted using the EZ-PKZ 0 mounting base. Contactors so mounted can also be equipped with a side-mounted auxiliary contact module Type HI11-S/EZ-PKZ 0. (See below).</p> <p>The S 00 contactor is identical to the SE 00 except for the built-in current limiting contact assembly, which makes it suitable for "Type 2" co-ordination levels per IEC/EN 60 947 and no welding performance in combination with the PKZM 0 Motor Protector.</p>	 <p>1 - PKZM 0 Motor Protector 7/6</p> <p>2 - Side-mounted, long version Auxiliary Contact 7/10</p> <p>3 - Clip Plate 7/13</p> <p>- Additional Accessories 7/14</p>
<p>RC SPKZ 0 48</p> <p>RC SPKZ 0 250</p> <p>VG SPKZ 48</p> <p>VG SPKZ 250</p> <p>VG SPKZ 415</p>	<p>See Price List</p> <p>See Price List</p> <p>See Price List</p> <p>See Price List</p> <p>See Price List</p>	<p>DC rated contactor coils are supplied standard with built-in surge suppressors.</p> <p>Coil Voltage: Circuit Diagram:</p> <p>12 V DC </p> <p>24 V DC </p> <p>48 V DC </p> <p>60 V DC </p> <p>110 V DC </p> <p>220 V DC </p>	
<p>EZ-PKZ 0</p>	<p>See Price List</p>	<p>SE 00 and S 00 contactors can be individually or separately mounted using the EZ-PKZ 0 mounting base. The base can also be mounted on DIN rail (on rails of 7.5 mm or 15 mm heights).</p>	
<p>MV-PKZ 0</p>	<p>See Price List</p>	<p>The MV-PKZ 0 can be used to mechanically interlock two S(E) 00 contactors e.g. to build reversing starter combinations.</p>	
<p>HI11-S/EZ-PKZ 0</p>	<p>See Price List</p>	<p>Cannot be combined with: PKZM 0-.../S(E) 00 equipped with NHI-...-PKZ 0 and/or AGM-...-PKZ 0.</p>	<p>Ordering Information: Specify Type from Column 6. Example: MV-PKZ 0</p> <p>Insert desired coil voltage where specified. Example: SE00-11-PKZ 0 (120V, 60Hz) S00-20- PKZ 0 (24V DC)</p>

Manual Motor Protectors, Motor Protectors with Contactor
Motor Starter Combinations



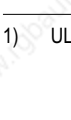



System PKZ 0- Motor Protector Insulated Enclosures, Housings, Padlocking provisions

1	2	3	4	5	6	7
	Notes	Degree of Protection	For Use With	Remarks	Type	Price
Insulated Enclosures for surface mounting						
For Motor Protector						
	Cover with opening dimensioned to accommodate front of Motor Protector	IP 40 UL/NEMA 1	PKZM 0-...+NHI or U or A, +L-PKZ 0 (Max. 2 lights)	Includes ground terminal connection, 2 PG 16 cable entry knockouts, top and bottom	CI-PKZ 0	See Price List
	With black/gray handle	IP 55 UL/NEMA 12	PKZM 0-..., +NHI+NHI-E or U+NHI-E or A+NHI-E, +L-PKZ 0 (Max. 2 lights)		CI-PKZ 0-G	See Price List
	With red/yellow handle for use in Emergency-Stop circuits.	IP 55 UL/NEMA 12	PKZM 0-..., +VHI...+ U...		CI-PKZ 0-GR	See Price List
For Motor Protector with early-make contacts						
	With black/gray handle	IP 55 UL/NEMA 12	PKZM 0-... +VHI...+ U...	Includes ground terminal connection, 2 PG 16 cable entry knockouts, top and bottom	CI-PKZ 0-GV	See Price List
	With red/yellow handle for use in Emergency-Stop circuits.	IP 55 UL/NEMA 12	PKZM 0-... +VHI...+ U...		CI-PKZ 0-GRV	See Price List
For Motor Protector enclosures						
	Padlocking assembly accommodating up to 3 padlocks with a hasp thickness of 3 - 6 mm		CI-PKZ 0-G(R)(V)	Padlockable in the OFF position of the PKZM 0 Manual Motor Protector	SVB-PKZ 0-CI	See Price List
For Motor Protector Combinations						
	Suitable for cover interlocking handle (R)H-PKZ 0 (IP 65).	IP 65 UL/NEMA 12 ¹⁾	PKZM 0-.../S(E)00 +NHI or NHI...S +NHI-E, +U or A +(R)H +L PKZ 0 (MAX. 2 lights)	Mounting depth 125 mm, additional M3-CI23 mounting plate required	CI23X-125-NA	See Price List
Insulated Housings for cavity mounting						
	Cover with opening dimensioned to accommodate front of Motor Protector	Front IP 40	PKZM 0-..., +NHI or U or A, +L-PKZ 0 (Max.2 lights)	Includes ground terminal connection, 2 PG 16 cable entry knockouts, top and bottom	E-PKZ 0	See Price List
	With black/gray rotary handle	Front IP 55	PKZM 0-..., +NHI+NHI-E or U+NHI-E or A+NHI-E, +AGM or U+NHI-E or A+NHI-E, +L-PKZ 0		E-PKZ 0-G	See Price List
	With red/yellow rotary handle for use in Emergency-Stop circuits	Front IP 55			E-PKZ 0-GR	See Price List
	Padlocking accessory to accommodate up to 3 padlocks with a hasp thickness of 3 - 6 mm		E-PKZ 0-G(R)	Padlockable in the OFF position of the PKZM 0 Manual Motor Protector	SVB-PKZ 0-E	See Price List

1) UL Type 12 currently under submittal

Ordering Information:
Specify Type from Column 6.
Example: **CI-PKZ 0-G**

System PKZ 0- Motor Protector Accessories- Clip plates, Handles, Indicating Lights

1	2	3	4
	Notes	Type	Price
Clip Plate			
	Always necessary when combining a PKZM 0 manual protector and a S(E) 00 magnetic contactor to create a magnetic Motor Protector Combination. Can be either panel mounted with screws or DIN rail mounted using one 15 mm height rail or two 7.5 or 15 mm height rails. DIN rails must conform to EN 50 022-35.	C-PKZ 0	See Price List
Door Coupling Handles UL/NEMA 12 / IEC IP 65¹⁾			
Drive dog and A-H-PKZ 0 extension shaft supplied with all door coupling handles. The extension shaft can be cut to any required length to accommodate mounting depths of 100 – 240 mm.			
	For use as Main Switch. Door/Cover interlocked when switch is in the ON position. Color: Black with On/Off and "+" (Trip) switch positions, lockable in OFF position using three 4 - 8 mm padlocks. Can also be modified to be lockable in the ON position.	H-PKZ 0	See Price List
	For use as Main Switch with Emergency-Stop function. Door/Cover interlocking feature. Color: Red/yellow with On/Off and "+" (Trip) switch positions, lockable in OFF position using three 4 - 8 mm padlocks.	RH-PKZ 0	See Price List
	Simpler mechanism, without any door/cover interlocking or padlocking capability. Color: Black, with On/Off and "+" (Trip) switch positions.	HSOV-PKZ 0	See Price List
1/4" Padlockable Knob for Manual Protector			
	Replaces standard PKZM 0 knob handle with a padlockable version. Accommodates 1/4" padlocks (range: 3 – 6.35 mm). Padlockable in OFF position.	AK-PKZ 0	See Price List
Tamper sealing Cover			
	To prevent unauthorized access to the Motor FLC thermal trip dial setting and the Test-to-Trip function. Uses conventional lead seal.	PL-PKZ 0	See Price List
Indicator Lights			
For CI23X-... , CI-PKZ 0-... , E-PKZ 0-... Enclosures and Housings			
	Color: White	Voltages: 110 - 230 V	L-PKZ 0 (230V)
		230 - 400 V	L-PKZ 0 (400V)
		415 - 500 V	L-PKZ 0 (500V)
	Color: Green	Voltages: 110 - 230 V	L-PKZ 0-GN (230V)
		230 - 400 V	L-PKZ 0-GN (400V)
		415 - 500 V	L-PKZ 0-GN (500V)
	Color: Red	Voltages: 110 - 230 V	L-PKZ 0-RT (230V)
		230 - 400 V	L-PKZ 0-RT (400V)
		415 - 500 V	L-PKZ 0-RT (500V)

1) UL Type 12 currently under submittal









Ordering Information:
Specify Type from Column 3.
Example: **AK-PKZ 0**

System PKZ 0- Motor Protector Wiring Accessories

1	2	3	4	5	6	7
	Notes	Number of Motor Protectors	Connector Length	Unit Width available per Motor Protector	Type	Price
			mm	mm		

Three-Phase Feeder Bus Connectors

Reduces mounting space and wiring time by eliminating daisy-chain wiring. Can be joined to accommodate more units. Finger-Safe!

	For Motor Protector and Motor Protector Combinations without side-mounted auxiliary contacts or voltage trips.	2	90	45	B3.0/2-PKZ 0	See Price List
		4	180	45	B3.0/4-PKZ 0	See Price List
	For Motor Protector and Motor Protector Combinations each with one side-mounted auxiliary contact or trip-indicating contact module, or a single voltage trip.	2	99	45 + 9	B3.1/2-PKZ 0	See Price List
		3	153	45 + 9	B3.1/3-PKZ 0	See Price List
		4	207	45 + 9	B3.1/4-PKZ 0	See Price List
		5	261	45 + 9	B3.1/5-PKZ 0	See Price List
	For Motor Protector and Motor Protector Combinations each having one auxiliary contact and trip-indicating auxiliary contact module mounted on the right, or a voltage trip mounted on the left, or for Motor Protector Combinations having a long NHI 2-11S-PKZ 0 standard auxiliary contact mounted on the right.	2	108	45 + 18	B3.2/2-PKZ 0	See Price List
		4	234	45 + 18	B3.2/4-PKZ 0	See Price List

Protective Shroud for Unused Terminals

	Finger-safe covers which slip over unused terminals of a three-phase feeder bus connector to protect against accidental contact.				H-B3-PKZ 0	See Price List
--	--	--	--	--	-------------------	----------------

Connector Feeder Terminal

	Incoming supply terminal to feed bus connectors. Finger-safe design. Maximum Ampacity: 63 A Permissible Conductor Range: AWG 10...4, Cu Only				BK25/3-PKZ 0	See Price List
--	--	--	--	--	---------------------	----------------



Ordering Information:
Specify Type from Column 6. Example: **B3.1/2-PKZ 0**

Manual Motor Protectors, Motor Protectors with Contactor Motor Starter Combinations



1	2	3	4	5	6	7
	For use with	Maximum Rated Current	Adapter Supply leads	Adapter Width	Type	Price
		Amps	AWG	mm		

Control Panel Bus Bar Adapters, 3-Pole

For mounting in industrial control panels on Cu 20 x 5 mm busbar arrangements with 60 mm phase separation. The back of the adapter connects onto the bus. Components are mounted on top of the adapter and wired to the supply leads. All assembly is done under de-energized (Power OFF) conditions.

	PKZM 0-... or PKZM 0-.../S(E)00 + AGM or NHI	25	10	54	AD 25/5-1	See Price List
	2 x PKZM 0-... or 2 x PKZM 0-.../S(E) 00 + AGM or NHI, or 1 x PKZM 0-... + 2 x EZ-PKZ 0 + MV-PKZ 0	25	10	108	AD 25/5-2	See Price List
	2 x PKZM 0-... or 2 x PKZM 0-.../S(E) 00 + AGM or NHI, or 1 x PKZM 0-... + 2 x EZ-PKZ 0 + MV-PKZ 0 + AGM or NHI	25	10	144	AD 25/5-144	See Price List

Same as above except for mounting on Cu 30 x 10 and 20 x 10 mm busbar arrangements with 60 mm phase separation.

	PKZM 0-... or PKZM 0-.../S(E) 00 + AGM or NHI	25	10	54	AD 25/10-1	See Price List
	2 x PKZM 0-... or 2 x PKZM 0-.../S(E) 00 + AGM or NHI, or 1 x PKZM 0-... + 2 x EZ-PKZ 0 + MV-PKZ 0	25	10	108	AD 25/10-2	See Price List
	2 x PKZM 0-... or 2 x PKZM 0-.../S(E) 00 + AGM or NHI, or 1 x PKZM 0-... + 2 x EZ-PKZ 0 + MV-PKZ 0 + AGM or NHI	25	10	144	AD 25/10-144	See Price List

Adapter Extension

	Push-fit strip, can be fitted onto AD... to extend mounting width			9	AD-E	See Price List
---	---	--	--	---	-------------	----------------

Ordering Information:
Specify Type from Column 6. Example: **AD 25/10-1**

System PKZ 0- Motor Protector MVS Mounting and Wiring Accessory Kits for Motor Starter Combinations

1	2	3	4	5	6
	For Use With PKZM 0 Motor Protectors + DIL...M Magnetic Contactors (Refer to Section 3 for info on Type DIL...M contactors.)	UL/CSA Maximum 3 Phase HP Rating @: 460 V 575 V	MVS Kit Type	Price	Remarks

Full Voltage, Non-Reversing Starter Combinations

	PKZM 0 + DIL (E)EM	5	5	MVS-D4	Includes a mounting plate and finger-safe wiring harness to accommodate FVNR motor starter combinations consisting of PKZM 0 Motor Protectors and DIL...M Magnetic Contactors in various HP sizes. UL listed/CSA certified for group installations and high fault short circuit current ratings (see page 7/19) in association with Moeller Electric components.
	PKZM 0 + DIL 00(A)M	7½	10	MVS-D5	
	PKZM 0 + DIL 0M	10	15	MVS-D11	
	PKZM 0 + DIL 0AM	15	20	MVS-D11	

Accommodates Mechanically Interlocked Contactors

	PKZM 0 + DIUL (E)EM/21/MV	5	5	MVS-W4	Includes a mounting plate and finger-safe wiring harnesses to accommodate FVR motor starter combinations consisting of PKZM 0 Motor Protectors and DIL...M mechanically interlocked Magnetic Contactors in various HP sizes. UL listed/CSA certified for group installations and high fault short circuit current ratings (see page 7/19) in association with Moeller Electric components.
	PKZM 0 + DIUL 00(A)M/11/MV	7½	10	MVS-W5MV	
	PKZM 0 + DIUL 0M/11/MV	10	15	MVS-W11MV	
	PKZM 0 + DIUL 0AM/11/MV	15	20	MVS-W11MV	

Star-Delta Starter Combinations

Open Transition

	PKZM 0 + DIL EM/EEM +DIL ET 11-30-A	7½	10	MVS-S5	Includes a mounting plate and finger-safe wiring harnesses to accommodate Star-Delta motor starter combinations consisting of PKZM 0 Motor Protectors, electronic timing relays and DIL...M Magnetic Contactors in various HP sizes. UL listed/CSA certified for group installations and high fault short circuit current ratings (see page 7/19) in association with Moeller Electric components.
	PKZM 0 + DIL 00AM/00M +ETR 4-51-A	10	15	MVS-S7	
	PKZM 0 + DIL 0M/00AM +ETR 4-51-A	15	20	MVS-S11	

For PKZM 0 Motor Protector Combinations

	PKZM 0-.../SE 00 PKZM 0-.../S 00			MVS-C45-S	Mounting Plate to combine PKZM 0-.../S(E) 00 Motor Protector Combinations with other MVS starters. Also allows feed using bus bar connectors (page 7/16).
--	---	--	--	------------------	---

Notes:

Control Circuit Voltage

The **MVS** System wiring harnesses are designed to accommodate **DIL (E)EM** contactors that are either AC or DC energized and **DIL...M** contactors that are AC energized only.

Surge Suppressors for DIL...M contactors

The following surge suppressors can be used with **DIL...M** contactors mounted on **MVS** mtg. plates:
RC B DIL 250 (RC filter), **VG B DIL 250** (Varistor suppressor) and **FD B-DIL** (diode suppressor)

Refer to Section 3 for more information on **DIL (E)EM** and **DIL M** contactors.

Ordering Information:

Specify Type from Column 4.
Example: **MVS-D5**

MVS System

The **MVS** system consists of mounting plates and wiring harnesses designed to combine **PKZM 0** Motor Protectors and **DIL...M** Magnetic Contactors in various Motor Starter configurations.

MVS Motor Starter Combinations are UL Listed and CSA Certified for group installations per the intent of NEC 430-53 and are also rated for high fault current ratings in association with listed upstream protective circuit breakers or fuses.

The **MVS** mounting and wiring system greatly cuts down the amount of mounting and wiring assembly time normally associated with motor starters and is thus ideally suited for use in industrial control panels.

Installation Instructions

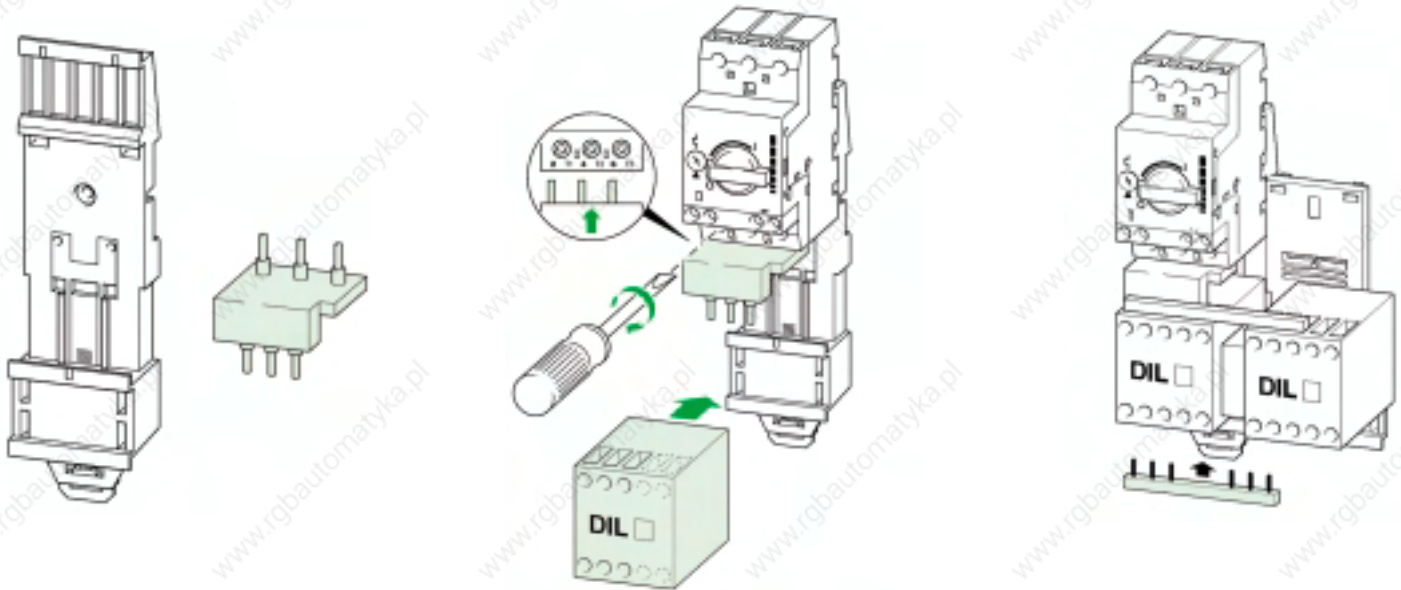

The **MVS** System Mounting plates are equipped with DIN Rails onto which **PKZM 0** Motor Protector and **DIL...M** Magnetic Contactors are securely fastened. Each **MVS** type comes with its own set of wiring harnesses to accommodate a number of starter configurations such as Full Voltage Non-Reversing and Full Voltage Reversing combinations. Once the wiring harness is in place it will provide a finger-safe connection between the Motor Protector and Contactor(s). One size screwdriver is the only tool required to complete the assembly. The mounting plate itself can either be panel mounted using screws or snapped onto a 35 mm DIN rail (EN 50 022) for quicker assembly. Depending on the starter type, assembly and wiring time is reduced by more than 50% over conventional methods. In addition to the time saving, the **MVS** System kits will further lower costs by reducing overall panel space requirements.

Full Voltage Non-Reversing Combinations: **MVS-D...**

Full Voltage Reversing Combinations: **MVS-W...(MV)**

Star-Delta Combinations **MVS-S...**

UL/CSA Short Circuit Current / NEC Group Protection Ratings

MVS System used in association with PKZM 0 Motor Protectors, DIL...M Magnetic Contactors and Listed Branch Circuit Overcurrent Protective Devices

	RMS Short Circuit Current Rating @ 600 V AC kA	Listed Group Protection Back-up Device	
		Fuse	Breaker
PKZM 0-6.3 + DIL...M + MVS	50	600 A	600 A
PKZM 0-10 + DIL...M + MVS	22	150 A	125 A
PKZM 0-16, 20, 25 + DIL...M + MVS	10	150A	125 A

Manual Motor Protectors, Motor Protectors with Contactor
Motor Starter Combinations

7

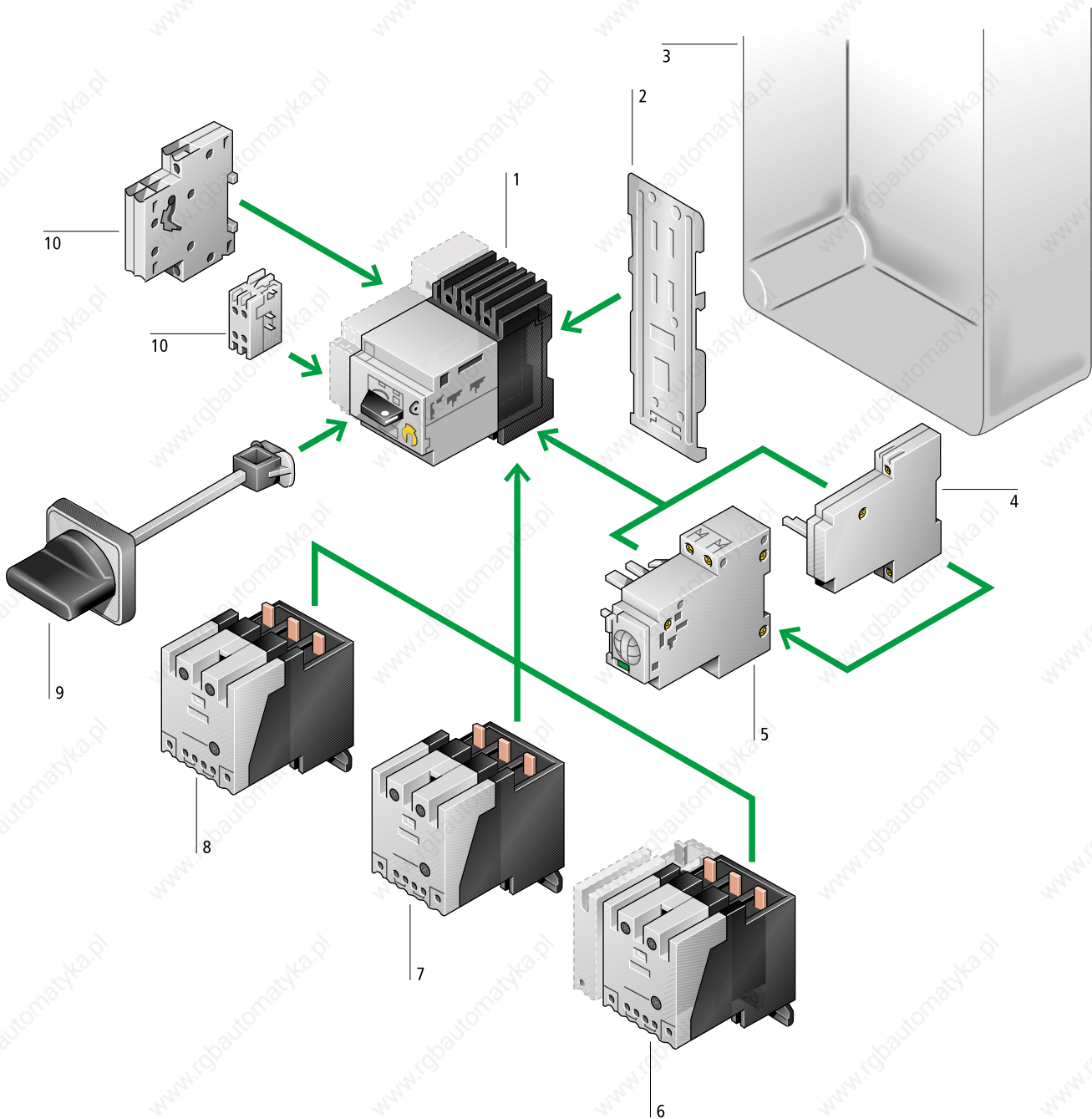

System **PKZ 2** refers to all of the components and accessories which make up the line of **PKZ 2** Motor Protectors. It is a modular system, with ample flexibility and comprehensive ratings to accommodate a broad range of industrial control motor switching and protection requirements.

System **PKZ 2** components are in compliance with all pertinent international and domestic standards and can be installed world-wide.

Maximum ratings: 42 Amps, 600 V AC

1 Manual Motor Protector
 Thermal-Magnetic Motor Protector
 Adjustable Thermal & Magnetic Trips
 Ambient Compensated, Phase failure sensitive
 Rated up to 42 Amps
 Maximum 3 Phase HP rating: 30 @ 460/ 575 V AC
 UL Listed for Group installations per NEC 430-53
 CSA Certified for Group installations per CEC Part 1, 28-206
 High Short Circuit Rating: Up to 65 kA/42 kA @ 480/600 V AC
 UL Listed, CSA Certified, in Conformity to IEC/EN 60 947
 CE Marked
 Type: **PKZ 2/ZM-...**

2 Mounting/Wiring
 Clip plate, onto which combinations of the **PKZ 2/ZM-...** Motor Protector and **S-PKZ 2** Magnetic contactors are mounted to form Motor Protector Combinations.
 Suitable for DIN rail mounting (EN 50 022). Can also be panel mounted with screws.
 Other Mounting/Wiring Hardware:
 - Adapters for direct busbar feeds in control panels.
 - 3 Phase Bus connectors to eliminate the need for daisy-chain wiring of motor protector combinations.
 Type: **C-PKZ 2**

3 Corrosion Resistant Enclosures
 Corrosion resistant enclosures made of high industrial grade insulating material to house **PKZ 2/ZM** Manual Motor Protectors and **PKZ 2/ZM-.../S** Magnetic Motor Protector Combinations.
 UL/NEMA 12, IEC IP 40 and 54 Environmental ratings with cover interlocked operating handle.
 Type: **CI...**

4 Voltage trip Modules
 Undervoltage trip modules:
 - With Early-Make auxiliary contacts
 - With Drop-Off delay and Early-Make auxiliary contacts
 Shunt trip module
 Mounts on the side of the **PKZ 2/ZM** Motor Protector.
 Type: **U-PKZ 2, UHI 20-PKZ 2, UVHI-PKZ 2, A-PKZ 0**

5 Remote Control Drive
 Electrically turns **PKZ 2/ZM** Motor Protector ON and OFF
 Electrically resets **PKZ 2/ZM** Motor Protector from Tripped position.
 Available in both AC and DC models.
 Has HAND and AUTO settings for maximum flexibility.
 HAND and AUTO positions are also signalled with an auxiliary contact.
 HAND position can be padlocked OFF.
 Type **RS-PKZ 2** can be directly energized by a 24 V DC from a PLC.
 Type: **RE-PKZ 2, RS-PKZ 2**

output

6 Magnetic Contactor Module
 AC or 24 V DC operated versions.
 AC Supplied with 1 N.O./1N.C. or 2 N.O. contacts.
 Plugs into the load side of the **PKZ 2/ZM** protector or can be separately mounted.
 Can be equipped with 4th (Neutral) Pole.
 Rated 20 kW @ 400/415 V AC.
 IEC 60 947-4-1 rated for Type 1 co-ordination.
 CE Marked. For IEC/EN applications.
 Type: **SE1A/...-PKZ 2, SE1A-G-...-PKZ 2**
 (Consult Moeller Electric for further info)

7 High Capacity Magnetic Contactor Module
 Internal current limitation feature to increase short circuit current rating and self-protection characteristics.
 AC or 24 V DC operated versions.
 AC Supplied with 1 N.O./1N.C. or 2 N.O. contacts.
 Plugs into the load side of the **PKZ 2/ZM** protector to create **PKZ 2/ZM-.../S** Magnetic Motor Protector combination.
 In association with **PKZ 2/ZM**:
 Maximum 3 Phase HP rating: 30 @ 460/ 575 V AC
 UL Listed for Group installations per NEC 430-53
 CSA Certified for Group installations per CEC Part 1, 28-206
 High Short Circuit Rating: Up to 65 kA/42 kA @ 480/600 V AC
 Rated 20 kW @ 400/415 V AC.
 IEC 60 947-4-1 rated for Type 2 co-ordination.
 UL Listed, CSA Certified, in conformity with IEC/EN 60 947
 CE Marked
 Type: **S-PKZ 2**

8 Current Limiter Module
 Fuseless, current limiting set of contacts housed in a module.
 Increases short circuit current rating of the **PKZ 2/ZM** up to 100 kA @ 500 V AC. For IEC/EN applications.
 Plugs directly into the **PKZ 2/ZM** or is separately mounted.
 Type: **CL-PKZ 2**

9 Door/Cover Mounted Handle
 Rated IP 65/ NEMA/UL 12, 3R.
 3 Positions- ON, OFF, Tripped.
 Door interlocking feature and padlockable with up to 3 padlocks.
 Plug-in extension shaft to accommodate various mounting depths.
 Black, or Red/Yellow for E-Stop function
 Type: **(R)H-PKZ 2**

10 Auxiliary Contact Modules
 Signals ON/OFF status of **PKZ 2/ZM** Motor Protector and **PKZ 2/ZM-.../S** Motor Protector + Contactor combination.
 Trip indicating contacts which differentiate between overload and short circuit tripping.
 Type: **NHI-...-PKZ 2, AGM-...-PKZ 2**

System PKZ 2- Motor Protector Overview of Combinations

The possible combinations of open and enclosed motor protectors with various accessories is indicated by a dot ● in each shaded row.

Open Devices, Enclosures

Accessories

Standard Auxiliary Contacts

Standard Auxiliary Contacts

Trip Indicating Contacts



NHI 11-PKZ 2
NHI 22-PKZ 2

NHI 11 S-PKZ 2
NHI 22 S-PKZ 2
NHI 2-11 S-PKZ 2

AGM 2-11-PKZ 2

Type

Type

Degree of Protection

Manual Motor Protector

PKZ 2/ZM-...

-

●

-

●



without Contactor

Surface Mounting Enclosures

Steel

CS 3-PKZ 2

Type 1
General Purpose

●

-

●

Insulating material

CI 19EE-PKZ2-NA



Type 12

●

-

●

Motor Protector Combination

PKZ 2/ZM-.../S

-

● or

●

●



with High Capacity Contactor

Surface Mounting Enclosures

Steel

S1 GK-PKZ 2

Type 1
General Purpose

● or

●

●

Insulating material

CI 43-PKZ 2



Type 12

● or

●

●

Manual Motor Protectors, Motor Protectors with Contactor
Motor Starter Combinations

7

System PKZ 2- Motor Protector Overview of Combinations

Remote Drive

Undervoltage Trip

Shunt Trip

Door Mounting Handle



RE-PKZ 2
RS-PKZ 2

U-PKZ 2
UVHI-PKZ 2

U-HI 20-PKZ 2

A-PKZ 2

H-PKZ 2
RH-PKZ 2

●	● or	● or	●	-
● or	● or	● or	●	-
-	● or	● or	●	●
●	● or	● or	●	-
-	● or	● or	●	●
-	● or	● or	●	●

Manual Motor Protectors, Motor Protectors with Contactor
Motor Starter Combinations

7



1	2	3	4	5
	Circuit Diagram	UL/CSA Maximum 3 Phase HP Rating @: (Single phase ratings: page 7/53)	Type	Price
		200 V 230 V 460 V 575 V		\$

Manual Motor Protectors

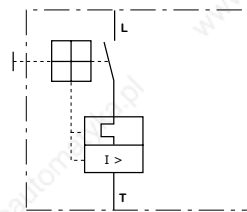

In this range select Motor Protector in accordance with the Motor nameplate Full Load Current.

	1/2	1/2	1	1 1/2
1/2	1/2	1	1 1/2	
1	1	2	3	
1 1/2	1 1/2	3	5	
2	3	5	7 1/2	
3	5	10	10	
7 1/2	7 1/2	20	25	
10	10	20	30	
10	15	30	30	

PKZ 2/ZM-0.6	See Price List
PKZ 2/ZM-1	See Price List
PKZ 2/ZM-1.6	See Price List
PKZ 2/ZM-2.4	See Price List
PKZ 2/ZM-4	See Price List
PKZ 2/ZM-6	See Price List
PKZ 2/ZM-10	See Price List
PKZ 2/ZM-16	See Price List
PKZ 2/ZM-25	See Price List
PKZ 2/ZM-32	See Price List
PKZ 2/ZM-40	See Price List

Magnetic Motor Protector Combination with High Capacity Contactor
UL/CSA Group installations
IEC/EN 60 947-4-1 "Type 2"
co-ordination level

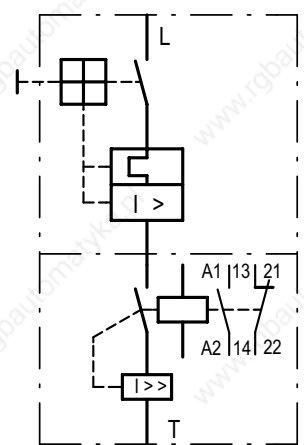

In this range select Motor Protector in accordance with the Motor nameplate Full Load Current.

	1/2	1/2	1	1 1/2
1/2	1/2	1	1 1/2	
1	1	2	3	
1 1/2	1 1/2	3	5	
2	3	5	7 1/2	
3	5	10	10	
7 1/2	7 1/2	20	25	
10	10	20	30	
10	15	30	30	

Specify Coil Voltage from page 7/40 when ordering (...)

PKZ 2/ZM-0.6/S (...)	See Price List
PKZ 2/ZM-1/S (...)	See Price List
PKZ 2/ZM-1.6/S (...)	See Price List
PKZ 2/ZM-2.4/S (...)	See Price List
PKZ 2/ZM-4/S (...)	See Price List
PKZ 2/ZM-6/S (...)	See Price List
PKZ 2/ZM-10/S (...)	See Price List
PKZ 2/ZM-16/S (...)	See Price List
PKZ 2/ZM-25/S (...)	See Price List
PKZ 2/ZM-32/S (...)	See Price List
PKZ 2/ZM-40/S (...)	See Price List

The PKZ 2/ZM-... is a 3 phase thermal-magnetic motor protective device incorporating adjustable bimetal trips for motor overload protection and magnetic trips to de-energize the motor circuit in case of a short circuit. The PKZ 2/ZM-.../S is a combination of the PKZ 2/ZM-... manual motor protector and the S-PKZ 2 High Capacity magnetic contactor.

The PKZ 2/ZM-... and the PKZ 2/ZM-.../S are UL listed and CSA certified as HP rated motor controllers which provide motor running overload protection. In addition, they are UL listed and CSA certified for group applications as per NEC 430-53(c) and CEC part 1, Rule 28-206. This means that a group of motors, each protected and controlled by a PKZ 2/ZM-... or a PKZ 2/ZM-.../S, can be combined under a single branch circuit short circuit and ground fault protective device, the maximum rating of which is marked on each PKZ 2 motor protector. (See columns 7-9 for UL/CSA short circuit current and backup overcurrent protection ratings.)

- Features:**
- Ratings: 42 Amp, 600 V AC - 30 HP/460 V, 30 HP/575 V max.
 - Approved for world markets = UL, CSA, IEC/EN 60 947, CE Marked
 - Conformity with IEC/EN 60 947 "Type 2" co-ordination levels
 - Phase failure sensitive.
 - Adjustable thermal trips set to motor FLC. Ambient compensated.
 - Adjustable magnetic trips.
 - Open or door mounted handle, padlockable, with 3 position indication (ON, OFF, Trip). See Accessories on page 7/37
 - 'Finger Safe' construction.
 - 35 mm DIN rail or panel mounting.

Ordering Information: Specify Type from column 4 and add desired control voltage if applicable.
 Example: PKZ 2/ZM-16, or PKZ 2/ZM-16/S (120V, 60Hz)

Manual Motor Protectors, Motor Protectors with Contactor
 Motor Starter Combinations

7

6	7	8	9	10	11
Adjustable Thermal Range (Set to Motor FLC)	Adjustable Trip Setting Current of Magnetic Trips	UL/CSA Short Circuit Current Rating kA RMS Sym @	Maximum Listed Branch Circuit Protective Fuse	Maximum Listed Branch Circuit Protective Circuit Breaker	Remarks
A	A	480 V AC 600 V AC	A	A	

0.4 - 0.6	5 - 8	65	42	500	600
0.6 - 1	8 - 14	65	42	500	600
1 - 1.6	14 - 22	65	42	500	600
1.6 - 2.4	20 - 35	65	42	500	600
2.4 - 4	35 - 55	65	42	500	600
4 - 6	50 - 80	65	42	500	600
6 - 10	80 - 140	65	42	500	600
10 - 16	130 - 220	65	42	500	600
16 - 27	200 - 350	65	42	500	600
24 - 32	275 - 425	65	42	500	600
32 - 42	350 - 500	65	42	500	600

0.4 - 0.6	5 - 8	65	42	2000	2000
0.6 - 1	8 - 14	65	42	2000	2000
1 - 1.6	14 - 22	65	42	2000	2000
1.6 - 2.4	20 - 35	65	42	2000	2000
2.4 - 4	35 - 55	65	42	2000	2000
4 - 6	50 - 80	65	42	2000	2000
6 - 10	80 - 140	65	42	2000	2000
10 - 16	130 - 220	65	42	2000	2000
16 - 27	200 - 350	65	42	2000	2000
24 - 32	275 - 425	65	42	2000	2000
32 - 42	350 - 500	65	42	2000	2000

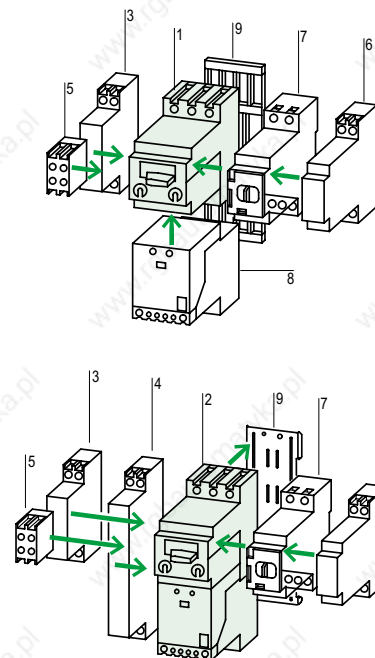

- 1 - PKZ 2/ZM-... Manual Motor Protector
 - 2 - PKZ 2/ZM-.../S Magnetic Motor Protector Combination
 - 3 - Standard Auxiliary Contact (Short Form) 7/28
 - 4 - Standard Auxiliary Contact (Long Form) 7/28
 - 5 - Trip Indicating/Differentiating Contact 7/28
 - 6 - Shunt Trip Undervoltage Trip 7/29
 - 7 - Remote Control Operator 7/30
 - 8 - High Capacity Contactor Module 7/32
 - 9 - Clip Plate 7/37
- Accessories 7/28 - 7/38

Manual Motor Protectors, Motor Protectors with Contactor Motor Starter Combinations

7

System PKZ 2 Motor Protectors in Group Motor Applications

PKZ 2/ZM Manual Motor Protectors and PKZ 2/ZM-.../S Magnetic Motor Protector Combinations are UL listed and CSA certified for group applications as per the intent of NEC 430-53 and CEC part 1, Rule 28-206. This eliminates the need for individual motor branch circuit overcurrent protective devices for each motor, thus greatly reducing the cost and space requirements of industrial control panels and assemblies.

In group installations involving a number of System PKZ 2 Motor protectors, the maximum rating of the group branch circuit overcurrent protective device is based on the lowest backup overcurrent rating marked on each motor protector in the group, combined with applicable NEC installation rules.

Please refer to the UL/CSA short circuit current and backup overcurrent protection ratings in columns 8-10 for selection guidelines on System PKZ 2 Motor protectors.

System PKZ 2- Motor Protector

Motor Protectors without Trip Modules, Trip Modules

UL / CSA / IEC / CE

1	2	3	4	5	6
	Rated Uninterrupted Current	Type	Price		UL/CSA Maximum 3 Phase HP Rating @: (Single phase ratings: page 7/53)
	A		\$		200 V 230 V 460 V 575 V

Manual Motor Protector without Plug-in Trip Module



42

PKZ 2

Magnetic Motor Protector Combination without Plug-in Trip Module

Specify Coil Voltage from page 7/40 when ordering



42

PKZ 2/S (...)

Plug-in Motor Protective Trip Modules



In this range select Motor Protector in accordance with the Motor nameplate Full Load Current.

1/2	1/2	1/2	1/2
3/4	1	1	1
1/2	1/2	1	1 1/2
1	1	2	3
1 1/2	1 1/2	3	5
2	3	5	7 1/2
3	5	10	10
7 1/2	7 1/2	20	25
10	10	20	30
10	15	30	30

Plug-in Motor Protective Trip Modules with Overload Relay Function



In this range select Motor Protector in accordance with the Motor nameplate Full Load Current.

1/2	1/2	1/2	1/2
3/4	1	1	1
1/2	1/2	1	1 1/2
1	1	2	3
1 1/2	1 1/2	3	5
2	3	5	7 1/2
3	5	10	10
7 1/2	7 1/2	20	25
10	10	20	30
10	15	30	30

The **PKZ 2** Manual Motor Protector and **PKZ 2/S...** Motor Protector Combination without plug-in trip modules make up one frame size rated for a maximum continuous motor load current of 42 Amps.

These products can be stocked, or mounted and wired in a panel, without prior knowledge of motor HP ratings. Motor overload and overcurrent protection is provided by the Plug-in Motor Protective trip Modules shown at right, which are inserted into the slots below the handle (between the disconnect and contactor portions) and enable the Motor Protector to cover a motor range from fractional HP up to 30 HP at 460/575 V AC.

Once motor loads are determined, selection of the appropriate plug-in motor protective trip module can take place. Exchanging trip modules is easy and does not require any removal of wiring or cables. Removal of the trip module provides an additional safety benefit by creating an open circuit path to the motor. This still allows the performance of routine motor maintenance tasks and circuit function checks but effectively rules out any inadvertent energization of the motor.

The plug-in Motor protective trip modules have the following features:

- Adjustable thermal and magnetic trips set in accordance with the motor FLC.
- Tamper-proof lids that cover thermal and magnetic settings when the device is on.
- Ambient compensation.
- Phase failure sensitivity.
- Coding accessory to insure insertion of correct module for the motor rating.

Manual Motor Protectors, Motor Protectors with Contactor Motor Starter Combinations

7

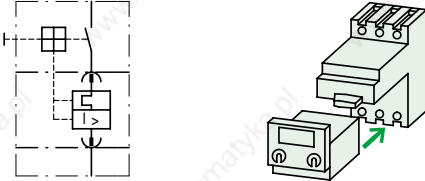
7	8	9	10	11
Type	Price	Adjustable Thermal Range (Set to Motor FLC)	Setting Range of Adjustable Magnetic Trips	Remarks
	\$	A	A	
ZM-0.6-PKZ 2	See Price List	0.4 - 0.6	5 - 8	 <p>Standard Trip Modules ZM...-PKZ 2 are inserted on the load side of the Motor Protector disconnect handle. In case of overload or short circuit the trip module will cause the Motor Protector switch mechanism to open and disconnect power to the load.</p> <p>- Accessories 7/28 - 7/38</p>
ZM-1-PKZ 2	See Price List	0.6 - 1	8 - 14	
ZM-1.6-PKZ 2	See Price List	1 - 1.6	14 - 22	
ZM-2.4-PKZ 2	See Price List	1.6 - 2.4	20 - 35	
ZM-4-PKZ 2	See Price List	2.4 - 4	35 - 55	
ZM-6-PKZ 2	See Price List	4 - 6	50 - 80	
ZM-10-PKZ 2	See Price List	6 - 10	80 - 140	
ZM-16-PKZ 2	See Price List	10 - 16	130 - 220	
ZM-25-PKZ 2	See Price List	16 - 27	200 - 350	
ZM-32-PKZ 2	See Price List	24 - 32	275 - 425	
ZM-40-PKZ 2	See Price List	32 - 42	350 - 500	
ZMR-0.6-PKZ 2	See Price List	0.4 - 0.6	5 - 8	
ZMR-1-PKZ 2	See Price List	0.6 - 1	8 - 14	
ZMR-1.6-PKZ 2	See Price List	1 - 1.6	14 - 22	
ZMR-2.4-PKZ 2	See Price List	1.6 - 2.4	20 - 35	
ZMR-4-PKZ 2	See Price List	2.4 - 4	35 - 55	
ZMR-6-PKZ 2	See Price List	4 - 6	50 - 80	
ZMR-10-PKZ 2	See Price List	6 - 10	80 - 140	
ZMR-16-PKZ 2	See Price List	10 - 16	130 - 220	
ZMR-25-PKZ 2	See Price List	16 - 27	200 - 350	
ZMR-32-PKZ 2	See Price List	24 - 32	275 - 425	
ZMR-40-PKZ 2	See Price List	32 - 42	350 - 500	

Manual Motor Protectors, Motor Protectors with Contactor
Motor Starter Combinations

7

Ordering Information:







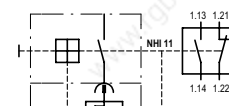
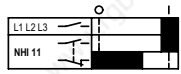

- Specify Type from column 3 and add desired control voltage if applicable.
Example: **PKZ 2, PKZ 2/S (120V, 60 Hz)**

- Specify Type from column 7.
Example: **ZM-16-PKZ 2**

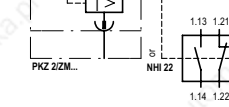
System PKZ 2- Motor Protector Auxiliary Contacts, Trip indicating contacts, Trip indicator, Current Limiter

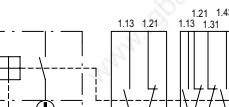
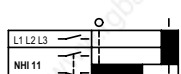
1	2	3	4	5	6	7
Connection Diagram	Number of Contacts	Type	Price	Remarks		
			N.O. = Normally Open N.C. = Normally Closed			
			N. O. N. C.		\$	

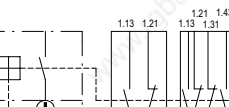
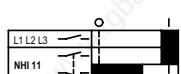
Standard Auxiliary Contacts

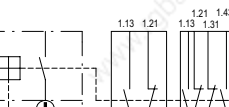
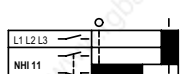
			1	1	NHI 11-PKZ 2
			2	2	NHI 22-PKZ 2
			1	1	NHI 11S-PKZ 2
			2	2	NHI 22S-PKZ 2
			2 x 1	2 x 1	NHI 2-11S-PKZ 2

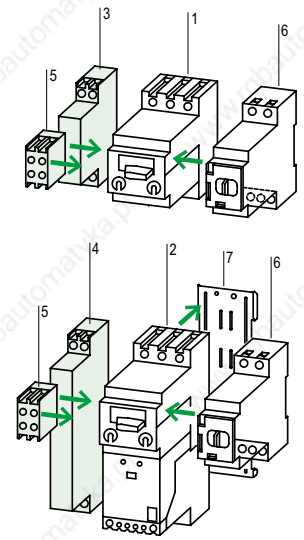

- 1 - PKZ 2/ZM Motor Protector
- 2 - PKZ 2/ZM-.../S Combination
- 3 - NHI...PKZ 2 auxiliary contacts
- 4 - NHI...S PKZ 2 auxiliary contacts
- 5 - AGM...PKZ 2 trip differentiating contacts
- 6 - R(E)(S)-PKZ 2 Remote Control drive
- 7 - C- PKZ 2 Clip plate

Trip Indicating Auxiliary Contacts with Short Circuit Indicator

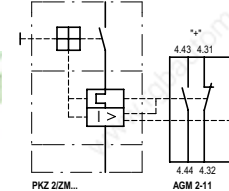
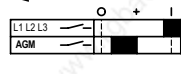
			1	1	AGM 2-11-PKZ 2
--	---	---	---	---	----------------

Supplied with red short circuit trip indicator which can be reset manually. (K-AGM-PKZ 2)

"+" : This set of contacts actuates under all trip conditions.
 "I >" : This set of contacts actuate only under short circuit trip conditions.

Additional Accessories 7/28-7/38

The Side Mounted NHI-...(S) auxiliary contacts operate in conjunction with the Motor Protector contacts and can be combined with AGM... Trip indicating contacts. Type NHI2-11S-PKZ 2 has a set of contacts operated by the Motor Protector, the other set by the contactor.

Short Circuit Indicator

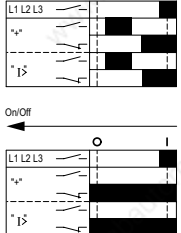
		K-AGM-PKZ 2
--	---	-------------

Red flag indicator signals a short circuit trip condition and can be manually reset.

The AGM...-PKZ 2 provides trip differentiating contacts and is supplied with K-AGM-PKZ 2 short circuit indicator.

The K-AGM-PKZ 2 provides a visual signal of a short circuit trip condition via a resettable red flag indicator. Differentiated trip signalling possible in conjunction with handle position.

Current Limiter

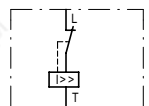





		Fuseless, current limiting set of contacts housed in a module. Increases short circuit current rating of the PKZ2/ZM up to 100kA @ 500VAC in IEC group applications. Not UL/CSA	CL-PKZ 2
--	---	---	----------

The CL-PKZ 2 plugs directly into the Motor Protector or can be separately mounted using the EZ-PKZ 2 mounting base.

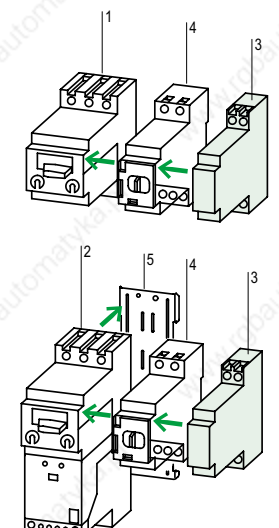
Ordering Information:
Specify Type from column 5
Example: NHI 22-PKZ 2

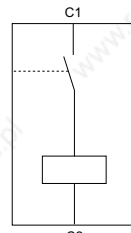
Manual Motor Protectors, Motor Protectors with Contactor Motor Starter Combinations

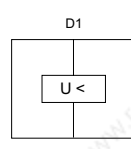
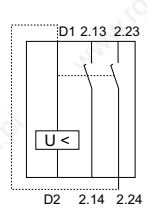
7

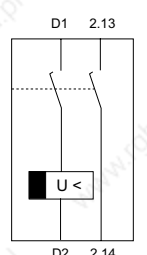
1	2	3	4	5	6	7
Connection Diagram			Voltage Ratings	Type	Price	Remarks
					\$	
Shunt Trips Suitable for both AC and DC voltages		Range of AC and DC voltages that can be accommodated with one shunt trip coil.		A-PKZ 2-A A-PKZ 2-B A-PKZ 2-C	See Price List See Price List See Price List	
		24 V DC 48 V DC 60 V DC 24 V 50 HZ 48 V 50 HZ 24 V 60 HZ 48 V 60 HZ	110 V DC 125 V DC 250 V DC 110 V 50 HZ 127 V 50 HZ 220 V 50 HZ 230 V 50 HZ 240 V 50 HZ 110 V 60 HZ 120 V 60 HZ 208 V 60 HZ 220 V 60 HZ 240 V 60 HZ	See Price List See Price List See Price List		
		380 V 50 HZ 400 V 50 HZ 415 V 50 HZ 440 V 50 HZ 500 V 50 HZ 480 V 60 HZ 600 V 60 HZ				
Undervoltage Trips		Specify Coil Voltage from page 7/40 when ordering		U-PKZ 2 (...) U-PKZ 2 (...) DC	See Price List See Price List See Price List	<ol style="list-style-type: none"> 1 - PKZ 2/ZM Motor Protector 2 - PKZ 2/ZM-../S Combination 3 - A-PKZ 2... and U...-PKZ 2 voltage trips 4 - R(E)(S)-PKZ 2 Remote Control drive 5 - C- PKZ 2 Clip plate <p>The A-PKZ 2... Shunt Trips are available in 3 models which cover a broad range of AC and DC voltages. They can be used in combination with R(E)(S)-PKZ 2 Remote Control drives.</p> <p>The Undervoltage Trips are available in the following versions:</p> <p>U-PKZ 2...</p> <ul style="list-style-type: none"> - Can be combined with the Motor Protector to accomplish Emergency-Off circuitry per IEC/EN 60 204. - Can be used in combination with R(E)(S)-PKZ 2 Remote Control drives. <p>U-HI 20-PKZ 2:</p> <ul style="list-style-type: none"> - Can be combined with the Motor Protector to accomplish Emergency-Off circuitry per IEC/EN 60 204. - Can be used in combination with R(E)(S)-PKZ 2 Remote Control drives. - Includes a set of Early-Make contacts. In the trip position, both contacts will be closed. The U-trip coil can be energized early by jumpering from the contact (see diagram), however, in this mode it will not be possible to combine it with the Remote Control Drive R(E)(S)- PKZ 2. <p>UVHI-PKZ 2:</p> <ul style="list-style-type: none"> - Has a built-in time delay to prevent tripping due to momentary power losses of 200 ms or less. - In the trip position, both contacts will be closed. - Can be used in combination with R(E)(S)-PKZ 2 Remote Control drives.
For AC		For DC				
						
For AC, with Auxiliary Contact				U-HI 20-PKZ 2 (...)	See Price List See Price List See Price List	
		ON L1 L2 L3 — — — — — + HI 20 — — — — —	OFF / Trip L1 L2 L3 — — — — — + HI 20 — — — — —			
Drop-Off Delayed (200 ms) For AC, with Auxiliary Contact				UVHI-PKZ 2 (...)	See Price List See Price List See Price List	
		ON L1 L2 L3 — — — — — + UVHI — — — — —	OFF / Trip L1 L2 L3 — — — — — + UVHI — — — — —			

Ordering Information:
 Specify Type from column 5. Example: **A-PKZ 2-B**
 Insert Coil Voltage rating if applicable. Example: **U-HI 20-PKZ 2 (120V, 60HZ)**

System PKZ 2- Motor Protector Remote Control Drives

1	2	3	4
	Connection Diagram	Circuit Diagram for Pulsed Operation	Notes

RE-PKZ 2 Remote Control Drive

Uses same potential for Line and Control feed.

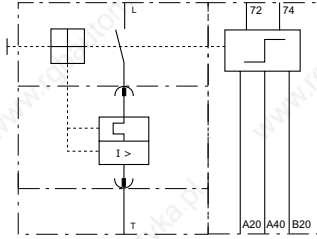

OFF and RESET Separate

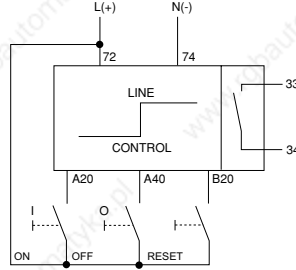

RE-PKZ 2 Mode of Operation:

Line and Control feeds have the same potential.

The Control section can be energized by a single impulse ($\leq 2 \text{ VA/W}$ power draw) of 15 ms duration, or by a maintained contact. Upon energizing, the Line connection draws its power requirement (700 VA/W for a duration of 30 ms) directly from the Line.

Control section can also be actuated via auxiliary contacts from various Moeller Electric components:

NHI, AGM, ETR 4-VS 3, EK..., and dry output contacts from PLC's with no RC filter type surge suppression.

OFF Equals RESET

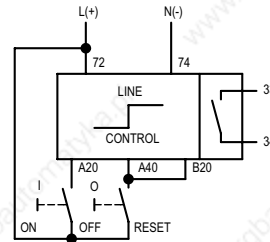

RS-PKZ 2 Remote Control Drive

Line and Control feed are separate.

Control supply is 24 V DC

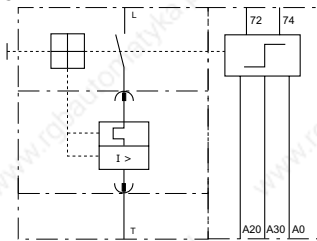

OFF Equals RESET

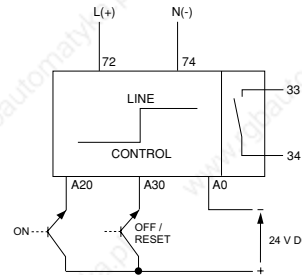

Line and Control sections are galvanically separated.

The Control section is energized solely from a 24 V DC source by a single impulse ($\leq 2 \text{ VA/W}$, 15 ms duration) or by a maintained contact. Suitable for energizing directly from an electronic PLC output.

Upon energizing, the Line connection draws its power requirement (700 VA/W for a duration of 30 ms) directly from the Line.

The control portion of the RS-PKZ 2 Remote Control Drive is designed to be directly actuated by a PLC with 24 V DC electronic outputs.

Minimum Command Time for Remote Operators

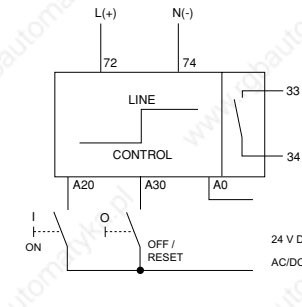
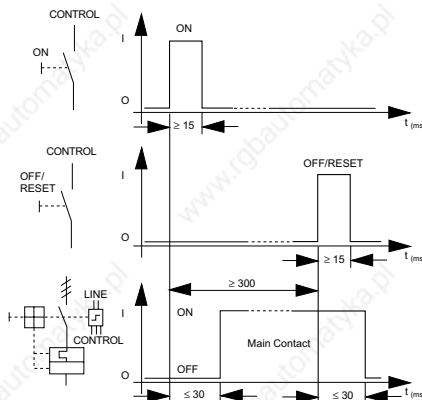

RE-PKZ 2 and **RS-PKZ 2** Remote Control Drives can be used to electrically operate the Motor Protector from a remote location:

- OFF to ON
- ON to OFF
- Reset to OFF after Trip

Highly desirable in factory automated operations and/or physically hard to reach locations!

Manual Motor Protectors, Motor Protectors with Contactors
Motor Starter Combinations

7

5	6	7	8
Type	Price		Remarks
Specify Supply Voltage from page 7/40 when ordering(...)	\$		
RE-PKZ 2 (...)	See Price List	Notes on RE-PKZ 2 and RS-PKZ 2 Remote Control Drives: They can be used with both the Motor Protector and Motor Protector Combination. They are used to electrically operate the Motor Protector (ON, OFF and Reset to OFF (after Trip) operations.) They can be switched OFF at the device and the thumb-grip handle can be padlocked using a 6 mm padlock. Suitable for use with either AC or DC voltages. Can be combined with U... , U-HI 20 and UVHI-PKZ 2 Undervoltage Trips or A-PKZ 2-... Shunt Trips. Always use Standard auxiliary contact Type NHI... when using RE/RS-PKZ 2 Remote Control Drives to electrically signal the open or closed status of the Motor Protector. Remote Control Drives cannot be used in conjunction with (R)H-PKZ 2 door interlock handle. Mounting is possible in both ON and OFF positions of the Motor Protector. An internal electronic interlock always sets OFF as the default setting. The thumb-grip handle has two positions: HAND and AUTO. In HAND: The drive displays the color GREEN and blocks any remote electrical actuation. The internal signalling contact 33/34 is open. In AUTO: The drive displays the color RED, indicating that remote electrical actuation is possible. The internal signalling contact 33/34 is closed.	<ul style="list-style-type: none"> 1 - PKZ 2/ZM Motor Protector 2 - PKZ 2/ZM-../S Motor Protector Combination 3 - NHI..PKZ 2 Auxiliary contacts 4 - NHI..S PKZ 2 Auxiliary contacts 5 - AGM...PKZ 2 Trip differentiating contacts 6 - R(E)(S)-PKZ 2 Remote Control Drive 7 - C- PKZ 2 Clip plate
RS-PKZ 2 (...)	See Price List		

Note: The supply voltage refers to the Line and Control feed for the **RE-PKZ 2** and the Line feed for the **RS-PKZ 2**.
 The Control section of the **RS-PKZ 2** is supplied with 24 V DC only.
 Both Remote Control Drives will draw their power requirement (700 VA for 30 ms) directly from the Line.

Ordering Information:
 Specify Type from column 5 and insert desired Supply Voltage from page 7/40.
 Example: **RE-PKZ 2 (24V DC)**
RS-PKZ 2 (120V, 60Hz)

System PKZ 2- Motor Protector Magnetic Contactors, Surge Suppressors

1	2	3	4	5
	Circuit Diagram	UL/CSA Maximum 3 Phase HP Rating @:	Number of Contacts N.O. - Normally Open N.C. - Normally Closed	For Use With
		200 V 230 V 460 V 575 V	N.O. N.C.	

High Capacity Magnetic Contactor Module

With Internal current limitation feature to increase short circuit current rating and self-protection characteristics of PKZ 2/ZM-.../S Motor Protector Combination.

AC Operated

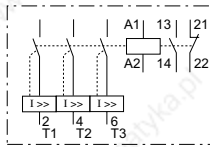

10	15	30	30	1	1	PKZ 2 PKZ 2/ZM-...
----	----	-----------	----	---	---	-----------------------

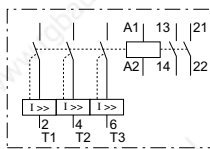

10	15	30	30	2	-	PKZ 2 PKZ 2/ZM-...
----	----	-----------	----	---	---	-----------------------

DC Operated with built-in surge suppression

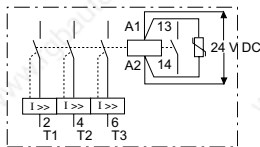

10	15	30	30	1	-	PKZ 2 PKZ 2/ZM-...
----	----	-----------	----	---	---	-----------------------

Surge Suppressors Varistor Type for AC coils

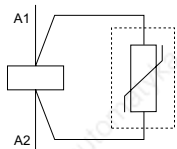

Actuating Voltages		
24 - 48 V AC		S-...-PKZ 2
110 - 250 V AC		
380 - 415 V AC		

Mounting Base For separate mounting of the S-...-PKZ 2 contactor







S-...-PKZ 2

Manual Motor Protectors, Motor Protectors with Contactor
Motor Starter Combinations

7

6 Type	7 Price	8 Notes	9 Remarks
Specify Coil Voltage from page 7/40 when ordering (▼) \$			
S-PKZ 2 (...)	See Price List	<p>The contactors can be directly plugged into the manual Motor Protector PKZ 2/ZM-... to form a Magnetic Motor Protector Combination. Use of a C-PKZ 2 clip plate is essential for this purpose. (See diagram at right.)</p> <p>The combination on a clip plate can then either be conventionally panel mounted using screws or clipped onto one, or two, 15 mm high DIN rails conforming to EN 50 022-35. The contactors can also be individually mounted using the EZ-PKZ 2 mounting base (see below).</p> <p>RC filter surge suppressors for AC coils, as an alternative to varistor types shown on this page, are available on request.</p> <p>Contactors that are individually mounted can also be mechanically interlocked using the MV-PKZ 2 mechanical interlock e.g. for Reversing applications.</p>	
S/Hi 20-S-PKZ 2 (...)	See Price List		
S-G-PKZ 2 (... DC)	See Price List		
VG SPKZ 48 VG SPKZ 250 VG SPKZ 415	See Price List See Price List See Price List	Surge suppressors for AC coils of S-...-PKZ 2 contactors. RC filters also available on request.	<ol style="list-style-type: none"> 1 - PKZ 2/ZM Motor Protector 2 - S-...PKZ 2 High Capacity Magnetic Contactor 3 - C-PKZ 2 Clip plate 4 - NHI...PKZ 2 Auxiliary contacts 5 - NHI...S PKZ 2 Auxiliary contacts 6 - AGM...PKZ 2 Trip differentiating auxiliary contacts 7 - U-...-PKZ 2, A-PKZ 2-... Voltage Trips 8 - R(E)(S)-PKZ 2 Remote Control Drives
EZ-PKZ 2	See Price List	Used to mount the S-...-PKZ 2 contactor separate from the PKZ 2... Motor Protector. Always required for reversing applications. Also allows extra contactor operated auxiliary contacts to be added: Type HI 11-S/EZ-PKZ 2 (1 N.O. & 1 N.C.) The base can be either panel mounted using screws (M4) or clipped onto a 35 mm DIN rail conforming to EN 50 022.	

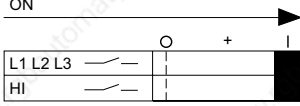
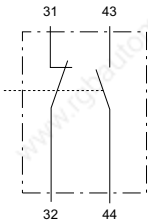
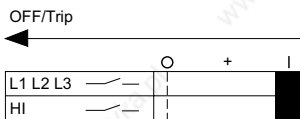
System PKZ 2- Motor Protector Accessories for S-...-PKZ 2 High Capacity Magnetic Contactors

1	2	3	4	5
	Connection Diagram		Type	Price
				\$
	Control Circuit Terminal Tap-offs		ST-PKZ 2	See Price List
				See Price List
	Mechanical Interlock		MV-PKZ 2	See Price List
				See Price List
	Auxiliary Contact Modules Fits to the side of separately mounted Contactors			See Price List
		Number of Contacts N.O. - Normally Open N.C. - Normally Closed		See Price List
		N.O. N.C.		See Price List
		1 1	ON  L1 L2 L3 HI	HI 11-S/EZ-PKZ 2
			OFF/Trip  L1 L2 L3 HI	
	Auxiliary Contact Inserts Mounts in the top portion of the contactor			See Price List
		1 1		HI 11-S-PKZ 2
		2 -		HI 20-S-PKZ 2
	Separate Coil		Specify Coil Voltage from page 7/41 when ordering (...)	See Price List
			J-S-PKZ 2 (...)	See Price List

Ordering Information: Specify Type from column 4. Example: **MV-PKZ 2**.
If applicable, insert desired Supply Voltage from p 7/41: Example: **J-S-PKZ 2 (120V, 60Hz)**

Manual Motor Protectors, Motor Protectors with Contactor Motor Starter Combinations

7

Provides easy access to the load side terminals of the **PKZ 2/ZM** Motor Protector for control circuit tap-off purposes when the protector and **S-PKZ 2** High Capacity magnetic contactor are mounted together as a combination unit. (**PKZ 2/ZM-.../S**)

Accepts 2.8 mm Fast-on connectors (insulated/non-insulated)
Control Circuit conductor cross-section range: AWG 16 – 20, Cu only.

Max. current draw: 1 Amp or 15% of thermal dial (FLC) value, whichever is less.
Increase the setting of the dial accordingly to compensate for the tapped off current.

To mechanically interlock two **S-PKZ 2** contactors. Contactors must be separately mounted using **EZ-PKZ 2** mounting bases.
Useful for reversing applications or when there is a need to mechanically interlock the contactors of two **PKZ 2/ZM-.../S** Motor Protector Combinations (e.g. 2 speed motors with 2 separate windings). Supplied with 4 end-brackets.

Provides an additional set of contactor operated auxiliary contacts (1 N.O. & 1 N.C.) for **S-PKZ 2** contactors that are mounted separately using the **EZ-PKZ 2** mounting base.

Auxiliary contact inserts are used as an exchange or replacement of the insert normally supplied with the contactor.
Exception: Exchange or replacement of insert is not possible with DC operated contactor type **S-G-PKZ 2**.

Separate coils available in AC voltages.
See page 7/32-33 for varistor type surge suppressors.
RC type filters can also be supplied on demand.

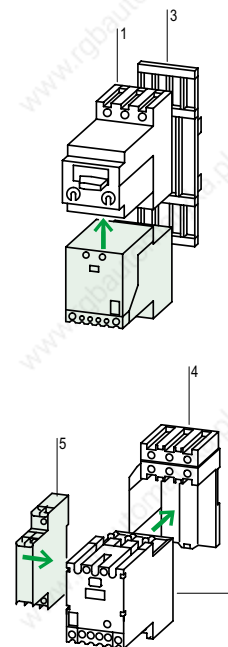

- 1 - **PKZ 2/ZM** Motor Protector
- 2 - **S-...PKZ 2** High Capacity Magnetic Contactor
- 3 - **C-PKZ 2** Clip plate
- 4 - **EZ-PKZ 2** Mounting base
- 5 - **HI 11-S/EZ-PKZ 2** Auxiliary Contact Module



The **S-...PKZ 2** High Capacity Magnetic Contactor can either be directly plugged into the load side of the **PKZ 2/ZM** Motor Protector to create a Motor Protector Combination as shown in the top diagram, or separately mounted using the **EZ-PKZ 2** mounting base. (Refer to page 7/32-33).

Whether the components form one unit or are individually mounted does not affect the overall ratings of the combination.

When the contactor is separately mounted, an additional set of auxiliary contacts (1 N.O. & 1N.C.) can be side mounted to the base (Item 5 above).

Note: When the contactor is plugged into the Motor Protector, an additional set of contactor operated auxiliary contacts is also possible, using the long version auxiliary contact module Type **NHI 2-11S-PKZ 2**. Refer to page 7/28 for further details.

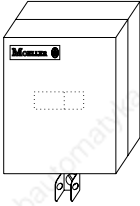

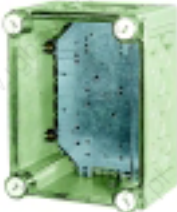







System PKZ 2- Motor Protector Enclosures

1	2	3	4	5	6
	Notes	For Use With the following components and accessories	Type	Price	Remarks
				\$	
Enclosures for Manual Motor Protector PKZ 2/ZM-...					
General Purpose, steel					
	NEMA Type 1	PKZ 2/ZM-... +NHI, +AGM +U or A or RE or RS	CS 3-PKZ 2	See Price List	General purpose enclosure with lift-off cover. Includes a rectangular cutout for the Motor Protector handle (not necessary to include the (R)H-PKZ 2 door mounted handle). Also includes a knockout for the R(E)S-PKZ 2 Remote Control Drives and a knockout for a pilot light.
Insulating Material, Dust tight					
	NEMA Type 12	PKZ 2/ZM-... +NHI, +AGM +U or A +(R)H	CI 19 EE-PKZ 2-NA	See Price List	NEMA Type 12, dust tight industrial use enclosure with lift-off cover. Must be equipped with the (R)H-PKZ 2 door mounted handle. Comes with a 15 mm DIN rail, and provided with top and bottom steel plates and brass strip for continuity of ground.
Enclosures for Motor Protector Combination PKZ 2/ZM-.../S					
General Purpose, steel					
	NEMA Type 1	PKZ 2/ZM-.../S +NHI(S), +AGM +U or A +(R)H-PKZ 2	S1 GK-PKZ 2	See Price List	General purpose enclosure with hinged cover. Must be equipped with the (R)H-PKZ 2 door mounted handle.
Insulating Material, Dust tight					
	UL/NEMA Type 12 IEC Type IP 65	PKZ 2/ZM-.../S +NHI(S), +AGM +U or A +(R)H-PKZ 2	CI 43-PKZ 2	See Price List	Corrosion resistant and dust tight insulating material enclosure. Must be equipped with the (R)H-PKZ 2 door mounted handle.

Ordering Information:
Specify Type from column 4. Example: **CS 3-PKZ 2**.

Manual Motor Protectors, Motor Protectors with Contactor Motor Starter Combinations

7

1	2	3	4	5
	Notes	Type	Price \$	Remarks
Clip Plate				
	Plate onto which the PKZ 2/ZM-... Motor Protector and S-PKZ 2 High Capacity Magnetic Contactor are mounted as a unit. The plate can be either DIN rail mounted or panel mounted using screws.	C-PKZ 2	See Price List	Snaps onto one 15 mm high or two 10 mm high DIN rails conforming to EN 50 022-35. Can alternatively be panel mounted using M4 screws. Can also be mounted on AD busbar adapters. Refer to page 7/38
Door/Cover Mounted Handles				
	NEMA/UL Type 3R, 12 IEC Type IP 65 Color: Black, for use as Main Disconnect switch	H-PKZ 2	See Price List	Door/Cover Interlock feature. Lockable in OFF or ON position. Up to three padlocks; hasp thickness 4 - 8 mm. Additional front plates: ZFS...T0 or ZFS...P3 (page 6/52) and ZFS...-NZM 7 (page 8/51)
	Color: Red/Yellow, for use as Main Disconnect switch with Emergency-Stop function	RH-PKZ 2	See Price List	Lockable in OFF position only. Up to three padlocks; hasp thickness 4 - 8 mm.
	Plug-in extension shaft to accommodate mounting depths from 171 – 300 mm.	A-H-PKZ 2	See Price List	
Three-Phase Feeder Bus Connectors & Incoming Supply Terminal				
Reduces mounting space and wiring time by eliminating daisy-chain wiring. Can be joined to accommodate more units. Finger-Safe construction.				
	For wiring three PKZ 2 Motor Protectors. Space is provided for either two auxiliary contacts or two Voltage Trips.	B3.1/3-PKZ 2	See Price List	222 mm wide. Can be joined to feed additional PKZ 2/ZMs . Maximum rating: 100 Amps.
	For wiring two PKZ 2 Motor Protectors. Space is provided for either one auxiliary contact or one Voltage Trip.	B3.1/2-PKZ 2	See Price List	140 mm wide. Can be joined to feed additional PKZ 2/ZMs . Maximum rating: 85 Amps.
	Terminal used to feed Bus Connectors. Accepts: AWG 14 – 0, Cu only	BK50/3-PKZ 2	See Price List	For connecting larger cable cross-sections to feed bus connectors. Finger-safe design is maintained and protects against shock hazards.
Cover for Unused Terminals				
	Protection against accidental contact of unused terminals on the bus connector.	H-B3-PKZ 2	See Price List	The feeder bus connector must have a latching provision to secure the cover.
Padlocking Feature				
	For padlocking the Motor Protector in the OFF position when the panel door is open.	SVB-PKZ 2	See Price List	Accepts up to three padlocks; hasp thickness 5 - 8 mm. Suitable for 1/4" padlocks.
Coding Pins				
	Uses binary coding to match the Motor Protector with a trip module.	CS-PKZ 2	See Price List	Coding pins prevent switching of the Motor Protector if an incorrect trip module is inserted.

Ordering Information:
Specify Type from column 3. Example: **SVB-PKZ 2**

	Single Voltage, Single Frequency	Single Voltage, Single Frequency	Single Voltage, Dual Frequency	Dual Voltage, Dual Frequency ¹⁾	
AC Coils	50 Hz	60 Hz	50/60 Hz	50 Hz, 60 Hz	DC Coils

Coil Voltage ratings for PKZM 0-.../S(E) 00-11 (...) Motor Protector Combinations and S(E) 00 individual contactors

Standard Coils	24 V 50 Hz 48 V 50 Hz 240 V 50 Hz	24 V 60 Hz 110 V 60 Hz 115 V 60 Hz	24 V 50/60 Hz 42 V 50/60 Hz 110 V 50/60 Hz 230 V 50/60 Hz	42 V 50 Hz, 48 V 60 Hz 110 V 50 Hz, 120 V 60 Hz 190 V 50 Hz, 220 V 60 Hz 220 V 50 Hz, 240 V 60 Hz 230 V 50 Hz, 240 V 60 Hz 380 V 50 Hz, 440 V 60 Hz 400 V 50 Hz, 440 V 60 Hz 415 V 50 Hz, 480 V 60 Hz	12 V DC 24 V DC 48 V DC 60 V DC 110 V DC 220 V DC
-----------------------	---	--	--	--	--

Coil Voltage ratings for A-PKZ 0 (...) Shunt Trips

Standard Coils	24 V 50 Hz 48 V 50 Hz 110 V 50 Hz 220 V 50 Hz 230 V 50 Hz 240 V 50 Hz 380 V 50 Hz 400 V 50 Hz 415 V 50 Hz	120 V 60 Hz 240 V 60 Hz 440 V 60 Hz 480 V 60 Hz		24 V DC 48 V DC 60 V DC 110 V DC 125 V DC 220 V DC 250 V DC
-----------------------	---	--	--	---

Special Coils 24 - 500 V 50 Hz 24 - 600 V 60 Hz

Coil Voltage ratings for U-PKZ 0 (...) Undervoltage Trips

Standard Coils	24 V 50 Hz 48 V 50 Hz 110 V 50 Hz 220 V 50 Hz 230 V 50 Hz 240 V 50 Hz 380 V 50 Hz 400 V 50 Hz 415 V 50 Hz	120 V 60 Hz 240 V 60 Hz 440 V 60 Hz 480 V 60 Hz
-----------------------	---	--

Special Coils 24 - 500 V 50 Hz 24 - 600 V 60 Hz

1) For ordering purposes it is only necessary to fill in one of the ratings from the dual voltage, dual frequency column.
Example:

Motor Protector Type: **PKZM 0-10/SE 00-11 (...)** (from page 7/8)
Desired voltage rating: **120 V, 60 Hz**
Complete Part Number: **PKZM 0-10/SE 00-11 (120V, 60Hz)**

Note:
Coil Voltage ratings must be added to the product Type number in order to complete the ordering information.

PKZM 0-.../S(E) 00-11 (...) Motor Protector Combinations may be found on page 7/8.
S(E) 00 individual contactors may be found on page 7/13.
A-PKZ 0 (...) Shunt Trips and **U-PKZ 0 (...)** Undervoltage Trips may be found on page 7/11.

System PKZ 2 - Motor Protector Coil Voltage Ratings

	Single Voltage, Single Frequency	Single Voltage, Single Frequency	Single Voltage, Dual Frequency	Dual Voltage, Dual Frequency ¹⁾	
AC Coils	50 Hz	60 Hz	50/60 Hz	50 Hz, 60 Hz	DC Coils

Coil Voltage ratings for PKZ 2/ZM-.../S (...) Motor Protector Combinations²⁾

Standard Coils	24 V 50 Hz 48 V 50 Hz 240 V 50 Hz	24 V 60 Hz	24 V 50/60 Hz 110 V 50/60 Hz 230 V 50/60 Hz	110 V 50 Hz, 120 V 60 Hz 190 V 50 Hz, 220 V 60 Hz 220 V 50 Hz, 240 V 60 Hz 230 V 50 Hz, 240 V 60 Hz 380 V 50 Hz, 440 V 60 Hz 400 V 50 Hz, 440 V 60 Hz 415 V 50 Hz, 480 V 60 Hz	24 V DC 125 V DC
Special Coils	24 - 600 V 50 Hz	24 - 600 V 60 Hz			

Coil Voltage ratings for U-PKZ 2 (...) Undervoltage Trips

Standard Coils	24 V 50 Hz 48 V 50 Hz 240 V 50 Hz	208 / 220 V 60 Hz	24 V 50/60 Hz 48 V 50/60 Hz	110 V 50 Hz, 120 V 60 Hz 220 V 50 Hz, 240 V 60 Hz 230 V 50 Hz, 240 V 60 Hz 380 V 50 Hz, 440 V 60 Hz 400 V 50 Hz, 440 V 60 Hz 415 V 50 Hz, 480 V 60 Hz	24 V DC 48 V DC 60 V DC 110 / 125 V DC
Special Coils	24 - 600 V 50 Hz	24 - 600 V 60 Hz			

Coil Voltage ratings for U-HI 20-PKZ 2 (...) and UVHI-PKZ 2 (...) Undervoltage Trips

Standard Coils	24 V 50 Hz 48 V 50 Hz 240 V 50 Hz	208 / 220 V 60 Hz	24 V 50/60 Hz 48 V 50/60 Hz	110 V 50 Hz, 120 V 60 Hz 220 V 50 Hz, 240 V 60 Hz 230 V 50 Hz, 240 V 60 Hz 380 V 50 Hz, 440 V 60 Hz 400 V 50 Hz, 440 V 60 Hz 415 V 50 Hz, 480 V 60 Hz	
Special Coils	24 - 600 V 50 Hz	24 - 600 V 60 Hz			

Line/Control Voltage ratings for RE-PKZ 2 (...) Remote Control Drives

Line Voltage rating for RS-PKZ 2 (...) Remote Control Drives³⁾

Standard Ratings			24 V 50/60 Hz 42 V 50/60 Hz 48 V 50/60 Hz 110 - 120 V 50/60 Hz 120 - 130 V 50/60 Hz 190 - 220 V 50/60 Hz 220 - 240 V 50/60 Hz 380 - 415 V 50/60 Hz		24 V DC 42 V DC 48 V DC 110-120 V DC 120-130 V DC 190-220 V DC 220-240 V DC
Special Ratings			60 V 50/60 Hz 110 V 50/60 Hz 170 - 190 V 50/60 Hz 440 V 50/60 Hz		60 V DC 110 V DC 170 - 190 V DC

	Single Voltage, Single Frequency	Single Voltage, Single Frequency	Single Voltage, Dual Frequency	Dual Voltage, Dual Frequency ¹⁾	
AC Coils	50 Hz	60 Hz	50/60 Hz	50 Hz, 60 Hz	DC Coils

Coil Voltage ratings for AC operated S-PKZ 2 (...), S/Hi 20-S-PKZ 2 (...), High Capacity Magnetic Contactors and J-S-PKZ 2 (...) Individual Coils

Standard Coils	24 V 50 Hz 48 V 50 Hz 240 V 50 Hz	24 V 60 Hz	24 V 50/60 Hz 110 V 50/60 Hz 230 V 50/60 Hz	110 V 50 Hz, 120 V 60 Hz 190 V 50 Hz, 220 V 60 Hz 220 V 50 Hz, 240 V 60 Hz 230 V 50 Hz, 240 V 60 Hz 380 V 50 Hz, 440 V 60 Hz 400 V 50 Hz, 440 V 60 Hz 415 V 50 Hz, 480 V 60 Hz	
Special Coils	24 - 600 V 50 Hz	24 - 600 V 60 Hz			

Coil Voltage ratings for DC operated S-G-PKZ 2 (...) High Capacity Magnetic Contactors

Standard Coils					24 V DC 125 V DC
-----------------------	--	--	--	--	---------------------

1) For ordering purposes it is only necessary to fill in one of the ratings from the dual voltage, dual frequency column.

Example:

Motor Protector Type: **PKZ 2/ZM-16/S (...)** (from page 7/24)

Desired coil voltage rating: **120V, 60Hz**

Complete Part Number: **PKZ 2/ZM-16/S (120V,60Hz)**

2) For Motor Protector Combinations with DC operated contactor add suffix **"-G"** to the part number.

Example:

Motor Protector Type: **PKZ 2/ZM-16/S (...)** (from page 7/24)

Desired DC voltage rating: **24 V DC**

Complete Part Number: **PKZ 2/ZM-16/S-G (24V DC)**

3) Control Voltage Rating = 24 V DC for **RS-PKZ 2**

Note:

Coil Voltage ratings must be added to the product Type number in order to complete the ordering information.

PKZ 2/ZM-.../S (...) Motor Protector Combinations may be found on page 7/24.

U-PKZ 0 (...), U-HI 20-PKZ 2 (...), and UVHI-PKZ 2 (...) Undervoltage Trips may be found on page 7/29.

RE-PKZ 2 (...) and **RS-PKZ 2 (...)** Remote Control Drives may be found on page 7/31.

S-(G)-PKZ 2 (...) and **S/Hi 20-S-PKZ 2 (...)** High Capacity Magnetic Contactors may be found on page 7/33.

J-S-PKZ 2 (...) Individual Coils may be found on page 7/34.

SE 00-PKZ 0 Contact Module

Normal Switching Duty¹⁾

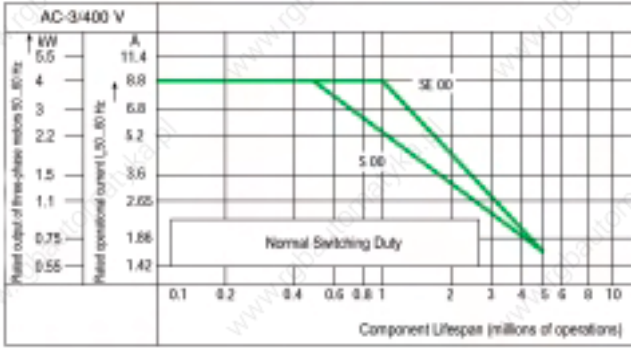

Extreme Switching Duty¹⁾

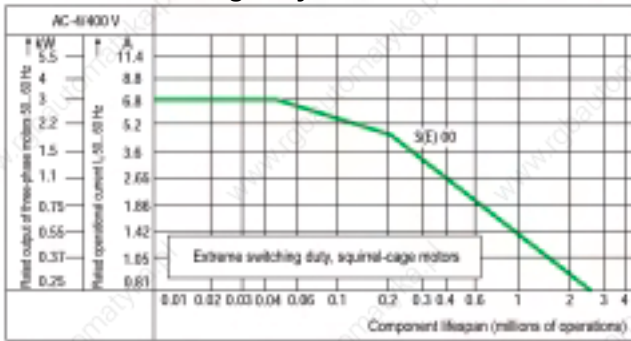

Light Switching Duty¹⁾

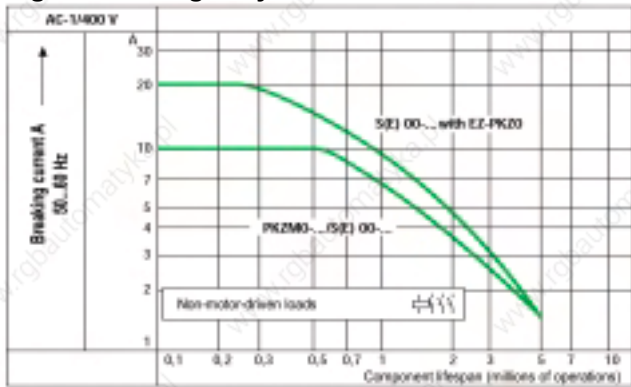

Determination of the Maximum Number of Operations per hour Dependent on the Switching Capacity and Utilization Category (approximate values)

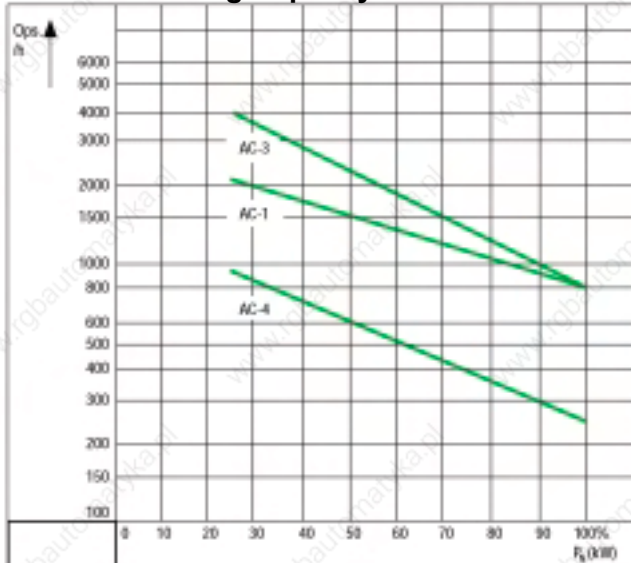

For Squirrel-Cage Motors

Operating characteristics:

Starting: from rest
Stopping: after attaining full running speed

Typical applications:

Compressors Lifts Mixers
Pumps Escalators Agitators
Fans Conveyors Centrifuges
Valves Bucket-elevators Air-Conditioning Systems

Drives in general for manufacturing and processing machines

Electrical Characteristics:

Make: up to 6 x motor rated current
Break: 1 x motor rated current

Utilization Category:

100 % AC-3

For Squirrel-Cage Motors

Operating characteristics:

Inching, plugging, reversing

Typical applications:

Printing machines
Wire-drawing machines
Centrifuges
Special drives for manufacturing and processing machines

Electrical Characteristics:

Make: 6 x motor rated current
Break: 6 x motor rated current

Utilization Category:

100 % AC-4

Non-Motor-Driven Loads

Operating characteristics:

Non-inductive or slightly-inductive load

Typical applications:

Electric heat

Electrical Characteristics:

Make: up to 1.5 x rated current
Break: 1 x rated current

Utilization Category:

100 % AC-1

1) AC... Utilization Category are determined at 400 V AC. Apply a derating factor of .9 (90%) for corresponding 460 V AC values.

P_N = Maximum HP Rating of the Contactor.
Ops/h. = Maximum operating frequency per hour.

Tripping Characteristics Manual Motor Protectors,
 Motor Protector Combinations

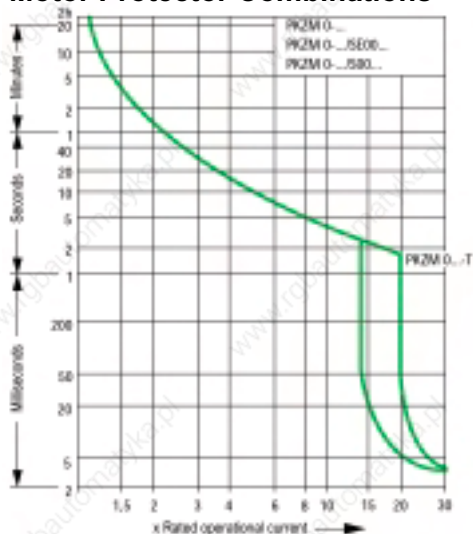

Let-Through Current Characteristics,
 Manual Motor Protectors

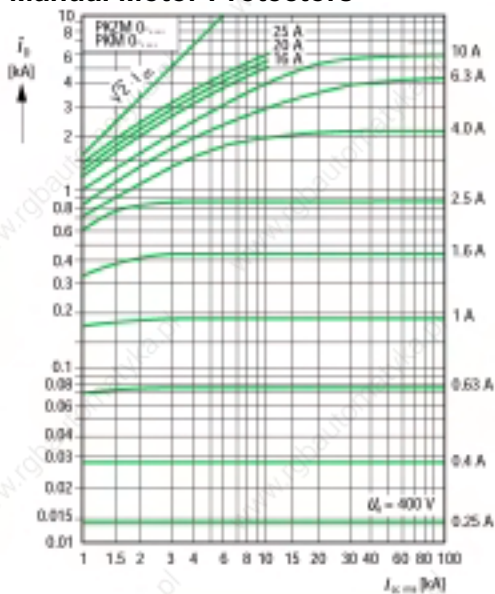

Let-Through Energy Characteristics,
 Manual Motor Protectors

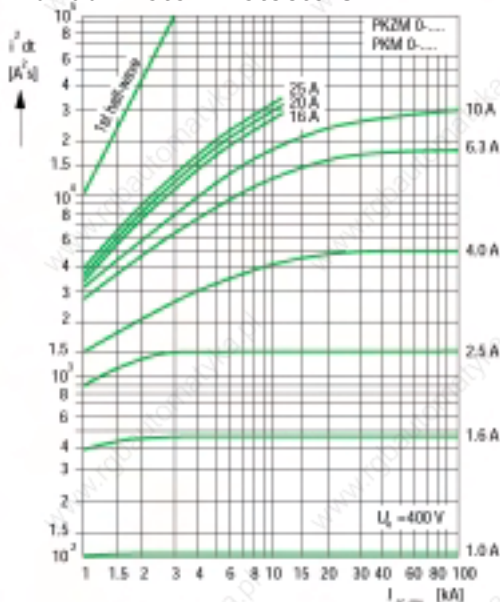

Let-Through Current Characteristics,
 Motor Protector Combinations

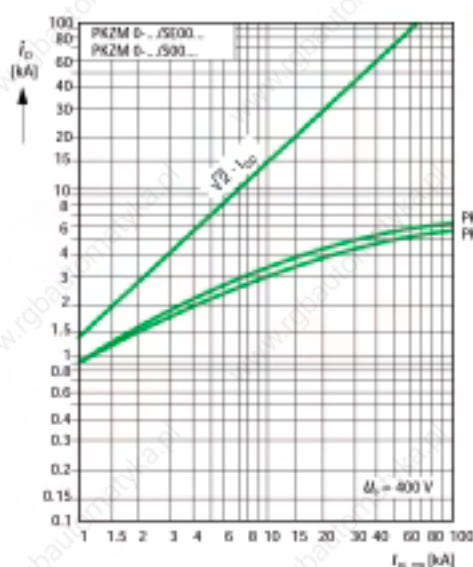

Let-Through Energy Characteristics,
 Motor Protector Combinations

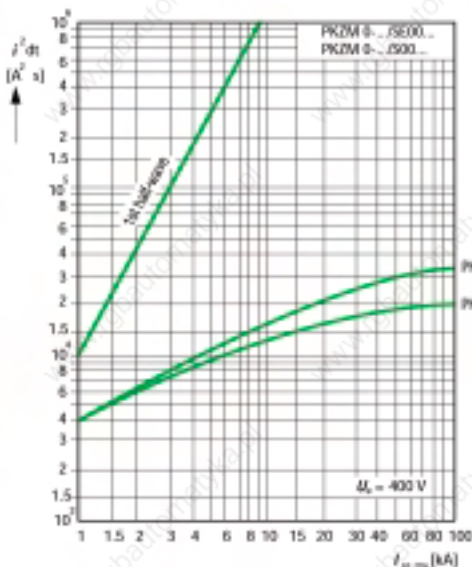

System PKZ 0- Motor Protector

Technical Data

General

Standards	IEC/EN 60 947, VDE 0660, UL 508, CSA C 22.2 No. 14, CE, GL, LR, DNV, PRS, BV, RINA, RS, MEEI, EZU		
Climatic Proofing	Damp Heat, Constant, to IEC 60 068 Part 2-3 Damp Heat, Cyclical, to IEC 60 068 Part 2-30		
Ambient Temperature	Storage	min./max.	°C
	Open	min./max.	°C
	Enclosed	min./max.	°C
Mounting Position			

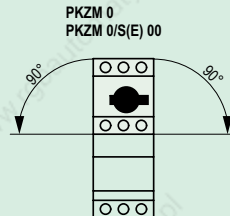

Direction of Incoming Supply	Manual Motor Protector: Optional Motor Protector Combination: From the top		
Environmental rating (Field-wiring terminals)	IP 20 (IP 00)		
Protection against electric shock hazards	Finger- and back-of-hand proof to IEC 536 (VDE 0106 Part 100)		
Impact Shock Resistance (Half-sinusoidal shock 10 ms)	g	Manual Motor Protector: 25 Motor Protector Combination: 8	
Altitude	m	2000	
IEC Terminal Capacities			
1 Conductor: Solid	min./max.	mm ²	1 - 6
Flexible with Ferrule	min./max.	mm ²	1 - 4
2 Conductors: Solid	min./max.	mm ²	1 - 2.5
Flexible with Ferrule	min./max.	mm ²	1 - 2.5
UL/CSA Terminal Capacities	min./max.	AWG	14 - 10
Tightening torque	Power terminals	Nm	1.8
	Control Terminals	Nm	1.0

Main Contacts

IEC/EN 60 947 Data:			
Rated Impulse Withstand Voltage U_{imp}	V	6000	
Overtoltage Category / Pollution Degree		III/3	
Maximum Rated Operational Voltage U_e	V AC	690	
Rated Uninterrupted Current I_u = Rated Operational Current I_e	A	25 or Thermal Trip Dial Setting	
Rated Frequency	Hz	40 - 60	
Number of Poles		3	
Current Heat Losses	3-Pole, warm state	W	Manual Motor Protector: 6 Combination Motor Protector: 9.5
Lifespan, Mechanical	Ops.	Manual Motor Protector: 0.1×10^6 (High Capacity) Magnetic Contactor: 5.0×10^6	Refer to Utilization Curves on page 7/42
Lifespan, Electrical	Ops.		
Max. Operating Frequency	Ops./hr	Manual Motor Protector: 40 (High Capacity) Magnetic Contactor: See Curve on page 7/42	

Trip Blocks

Temperature Compensation			
- IEC/EN 60 947, VDE 0660	min./max.	°C	-5/+40
- Operating Range	min./max.	°C	-25/+55
Temperature Compensation Residual Error		%/K	≤ 0.25 - 0.4
Thermal Trip Dial Setting Range	x I_u		0.6...1
Fixed Magnetic Trip Response	x I_u		14 (20 for PKZM 0-...T)
Magnetic Trip Tolerance	%		± 20
Single-Phasing Sensitivity	IEC/EN 60 947-4-1, DIN VDE 0660 Part 102, UL 508, CSA 22.2 # 14		

UL/CSA Single Phase HP Ratings

Always use 3 Poles for wiring	1 Phase HP @	115 V AC	200 V AC	230 V AC
Manual Motor Protector Type	PKZM 0-1.6	-	-	$1/10$
	PKZM 0-2.5	-	$1/8$	$1/6$
	PKZM 0-4.0	$1/8$	$1/4$	$1/3$
	PKZM 0-6.3	$1/4$	$1/2$	$1/2$
	PKZM 0-10	$1/2$	1	$1 1/2$
	PKZM 0-16	1	2	2
	PKZM 0-20...25	$1 1/2$	3	3
(High Capacity) Magnetic Contactor	S(E) 00-...	$1/2$	1	$1 1/2$

**S(E) 00-PKZ 0 Magnetic Contactors
Magnet System**

AC Operation

Operating Range (U_s = Coil Voltage Rating)				
Single-Voltage Coil 50 Hz and Dual-Voltage Coil 50 Hz, 60 Hz	Pick-up	$x U_s$		0.85 - 1.1
	Drop-out	$x U_s$		0.4 - 0.6
Dual-Frequency Coil ...V 50/60 Hz	Pick-up	$x U_s$		0.85 - 1.1
	Drop-out	$x U_s$		0.25 - 0.5

Power Consumption				
Single-Voltage Coil 50 Hz and Dual-Voltage Coil 50 Hz, 60 Hz	Pick-up	VA/W		25/22
	Sealing	VA/W		4.6/1.3
Dual Frequency Coil ...V 50/60 Hz at 50 Hz	Pick-up	VA/W		30/26
	Sealing	VA/W		5.6/1.6
...V 50/60 Hz at 60 Hz	Pick-up	VA/W		29/24
	Sealing	VA/W		3.9/1.1

Operating Times at 100 % U_s				
(Main Contacts)				
	Closing Delay	ms		14 - 21
	Opening Delay	ms		8 - 18

DC Operation

Operating Range	Pick-up	$x U_s$		0.85 - 1.1
Power Consumption	Pick-up = Sealing (Main Contacts)	W		2.6
Operating Times at 100 % U_s				
	Closing Delay	ms		26 - 35
	Opening Delay	ms		15 - 20
Duty Factor		% DF		100

Component Lifespan Lifespan Characteristics Page 7/42

Terminal Capacities				
1 Conductor or 2 Conductors	min./max.	mm ²		1 - 2.5
Solid or Flexible with Ferrule	min./max.	AWG		18 - 14

**System PKZ 0 Motor Protector
IEC kW Ratings (AC 3)**

	AC 3 kW Rating @	220 V	380 V	440 V	500 V	660 V
		230 V	400 V			690 V
		240 V	415 V			
Manual Motor Protector Type		kW	kW	kW	kW	kW
PKZM 0-0.16		-	-	-	-	0.06
PKZM 0-0.25		-	0.06	0.06	0.06	0.12
PKZM 0-0.4		0.06	0.09	0.12	0.12	0.18
PKZM 0-0.63		0.09	0.12	0.18	0.25	0.25
PKZM 0-1		0.12	0.25	0.25	0.37	0.55
PKZM 0-1.6		0.25	0.55	0.55	0.75	1.1
PKZM 0-2.5		0.37	0.75	1.1	1.1	1.5
PKZM 0-4.0		0.75	1.5	1.5	2.2	3
PKZM 0-6.3		1.1	2.2	3	3	4
PKZM 0-10		2.2	4	4	4	7.5
PKZM 0-16		4	7.5	9	9	12.5
PKZM 0-20		5.5	9	11	12.5	15
PKZM 0-25		5.5	12.5	12.5	15	22
Motor Protector + Contactor Combination						
PKZM 0-0.16/S(E) 00...		-	-	-	-	0.06
PKZM 0-0.25/S(E) 00...		-	0.06	0.06	0.06	0.12
PKZM 0-0.4/S(E) 00...		0.06	0.09	0.12	0.12	0.18
PKZM 0-0.63/S(E) 00...		0.09	0.12	0.18	0.25	0.25
PKZM 0-1/S(E) 00...		0.12	0.25	0.25	0.37	0.55
PKZM 0-1.6/S(E) 00...		0.25	0.55	0.55	0.75	1.1
PKZM 0-2.5/S(E) 00...		0.37	0.75	1.1	1.1	1.5
PKZM 0-4.0/S(E) 00...		0.75	1.5	1.5	2.2	3
PKZM 0-6.3/S(E) 00...		1.1	2.2	3	3	4
PKZM 0-10/S(E) 00...		2.2	4	4	4	-

System PKZ 0- Motor Protector Technical Data

Auxiliary Contacts

UL/CSA Pilot Duty Ratings				A 600, Q 300 NHI...(S),AGM...	E 150 (for NHI-E-...-PKZ 0)
IEC/EN 60 947 Ratings					
Rated Operational Current I _e AC-15	220 - 240 V 380 - 415 V 440 - 500 V	A A A	3.5 2 1		1 (for NHI-E-...-PKZ 0)
DC-13 (L/R ≤ 100 ms)	24 V 60 V 110 V 220 V	A A A A	2 1.5 1 0.25		2 (for NHI-E-...-PKZ 0) 1 (for NHI-E-...-PKZ 0) 0.5 (for NHI-E-...-PKZ 0) 0.25 (for NHI-E-...-PKZ 0)
Component Lifespan	Mechanical	Ops.	NHI NHI-E-... AGM		0.1 x 10 ⁶ 0.1 x 10 ⁶ 0.01 x 10 ⁶
	Electrical	Ops.	NHI...S, HI NHI NHI-E-... AGM NHI...S, HI		5 x 10 ⁶ 0.05 x 10 ⁶ 0.1 x 10 ⁶ 5 x 10 ³ 1 x 10 ⁶
Control Circuit Reliability Fault Probability at Rated Operational Voltage 24 V DC (U _{min} = 17 V, I _{min} = 5.4 mA)					< 10 ⁻⁸ , < 1 Fault in 1 x 10 ⁸ Operations
Positively Driven Contacts to ZH 1/457				NHI 11, NHI 12, NHI 21 NHI 2-11S, HI 11-S/EZ	
Terminal Capacities 1 or 2 Conductors Solid or Flexible (with Ferrule for IEC/EN applications)					
	IEC/EN UL/CSA	min./max. min./max.	mm ² AWG	0.75 - 2.5 18 - 14	0.75 - 1.5 (for NHI-E-...-PKZ 0) 18 - 16 (for NHI-E-...-PKZ 0)

Voltage Trips- General

Rated Operational Voltage U _e			V AC V DC	42 - 480 24 - 250
Terminal Capacities 1 or 2 Conductors Solid or Flexible (with Ferrule for IEC/EN applications)				
	IEC/EN UL/CSA	min./max. min./max.	mm ² AWG	0.75 - 2.5 18 - 14

Shunt Trips

(U_s = Trip coil rated voltage)

Operating Range	AC DC (Intermittent Operation: 5 s)	x U _s x U _s	0.7 - 1.1 0.7 - 1.1
Power Consumption	Pull-in AC Sealing AC Pick-up DC Sealing DC	VA VA W W	5 3 3 3

Undervoltage Trips

(U_s = Trip coil rated voltage)

Pick-up Voltage	x U _s	0.85
Drop-out Voltage	x U _s	0.7 - 0.35
Power Consumption	Pull-in AC Sealing AC	VA VA
		5 3

PKZM 0 Motor Protector Trip curve

The trip curve shows the tripping time of the Motor Protector in relation to the response current. The curve shows mean values of the tolerance ranges at an ambient temperature of 20 °C, starting from cold. The tripping time of the bimetal trips at operational temperature (warm state) is reduced to approximately 1/4 of the values shown. System PKZ 0 Motor Protectors are suitable for protection of IEC Type EEx e- explosion-proof motors. Specific characteristics for each individual setting range are available on request. These characteristics, in 55 x 75 mm format (self-adhesive), can be used as on-site documentation to verify the suitability of each Motor Protector for this application. The data has been independently verified by the German PTB testing agency and laboratory.

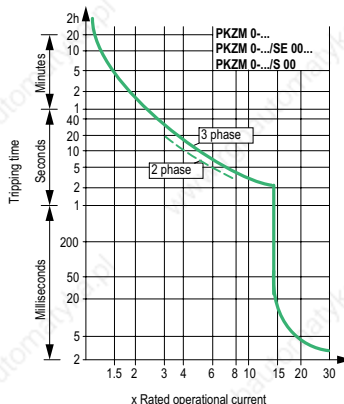

System PKZ 0 Motor Protectors:
Suitable for protection of IEC Type EEx e
Explosion-proof motors.

System PKZ 0 Short Circuit Ratings per IEC/EN 60 947 Standards for international applications

I_u = Maximum Continuous Current Rating of each device.

I_q = Conditional Short Circuit Current Rating (per IEC/EN 60 947-4-1, relevant for Motor Starters and Motor Starter Combinations)

I_{cu} = Ultimate Breaking Capacity (per IEC/EN 60 947-2, relevant for circuit breakers)

I_{cs} = Continuity of Service Breaking Capacity (per IEC/EN 60 947-2, relevant for circuit breakers)

(All kA ratings are RMS Sym. values)

- Indicates Self-Protected Range (100 kA)

N - Not necessary. Back-up protection is not required since device is operating within its self-protected range.

A - On Request

I_u A	230 V				400 V				440 V				500 V				690 V			
	I_q kA	I_{cu} kA	I_{cs} kA	A ¹⁾	I_q kA	I_{cu} kA	I_{cs} kA	A ¹⁾	I_q kA	I_{cu} kA	I_{cs} kA	A ¹⁾	I_q kA	I_{cu} kA	I_{cs} kA	A ¹⁾	I_q kA	I_{cu} kA	I_{cs} kA	A ¹⁾

PKZM 0-... Motor Protector, Coordination Types "1" and "2"

0.16 - 1					N					N					N					N			
1.6					N					N					N					N			
2.5					N					N					N					5	5	5	50
4					N					N					N					3	3	3	50
6.3					N					N					N					3	3	2	50
10					N					N					N					3	3	2	50
16	16	16	8	50	16	16	8	50	10	10	10	50	6	6	6	50	3	3	2	50			
20	16	16	8	50	16	16	8	50	10	10	10	50	6	6	6	50	3	3	2	50			
25	16	16	8	50	16	16	8	50	10	10	10	50	6	6	6	50	3	3	2	50			

PKZM 0-... Motor Protector +CL-PKZ 0 Current Limiter

0.16 - 1					N					N					N					20	N		
1.6					N					N					N					20	N		
2.5					N					N					N					20	20	20	N
4					N					N					N					20	20	20	N
6.3					N					N					N					50	50	50	N
10					N					N					N					20	20	20	N
16					N					N					N					20	20	20	N
20					N					N					N					10	10	10	N
25					N					N					N					10	10	10	N

PKZM 0+CL-PKZ 0+ upstream CL-PKZ 0 used as additional back-up protection

0.16 - 1					N					N					N					A	N		
1.6					N					N					N					A	N		
2.5					N					N					N					40	40	A	N
4					N					N					N					40	40	A	N
6.3					N					N					N					40	40	40	N
10					N					N					N					40	40	40	N
16					N					N					N					40	40	40	N
20					N					N					N					20	20	20	N
25					N					N					N					20	20	20	N

Motor Protector Combination PKZM 0-.../SE 00.... (Coordination) Type "1" and PKZM 0-.../S 00... Type "1" and "2"

0.16 - 1					-	-	N					-	-	N					-	-	N	
1.6					-	-	N					-	-	N					-	-	N	
2.5					-	-	N					-	-	N					5	-	-	50
4					-	-	N					-	-	N					5	-	-	50
6.3					-	-	N					-	-	N					6	-	-	50
10					-	-	N					-	-	N					6	-	-	50

1) Additional Back-up protection is required whenever the available short circuit fault current exceeds the I_q Conditional Short Circuit Current Rating of the device shown in the table. The Conditional Short Circuit Current Rating is then dependent on the short circuit rating of the fuse:
 With 50 A gL Characteristic fuse $I_q = 100kA$
 With 100 A gL Characteristic fuse $I_q = 30 kA$

S-PKZ 2 Contact Module

Normal Switching Duty¹⁾

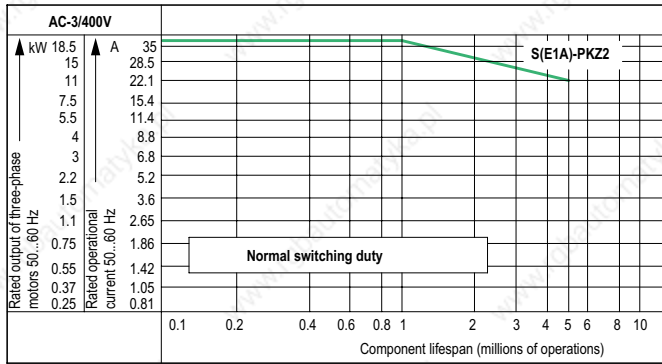

Extreme Switching Duty¹⁾

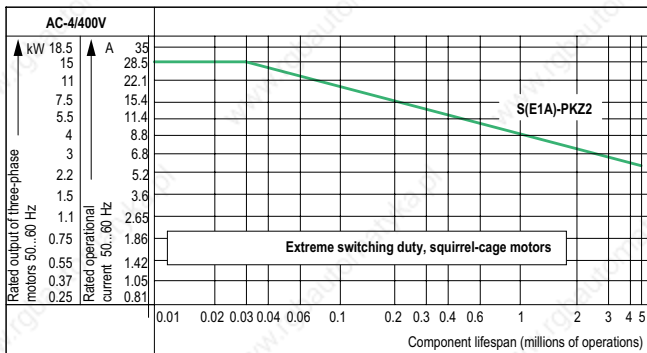

Light Switching Duty¹⁾

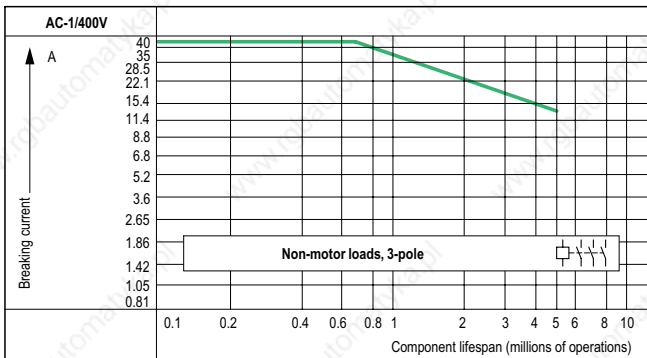

For Squirrel-Cage Motors

Operating characteristics: Starting: from rest
Stopping: after attaining full running speed

Typical applications: Compressors Lifts Mixers
Pumps Escalators Agitators
Fans Conveyors Centrifuges
Valves Bucket-elevators Air-Conditioning Systems

Drives in general for manufacturing and processing machines

Electrical Characteristics: Make: up to 6 x motor rated current
Break: 1 x motor rated current

Utilization Category: 100 % AC-3

For Squirrel-Cage Motors

Operating characteristics: Inching, plugging, reversing

Typical applications: Printing machines
Wire-drawing machines
Centrifuges
Special drives for manufacturing and processing machines

Electrical Characteristics: Make: 6 x motor rated current
Break: 6 x motor rated current

Utilization Category: 100 % AC-4

Non-Motor-Driven Loads

Operating characteristics: Non-inductive or slightly-inductive load

Typical applications: Electric heat

Electrical Characteristics: Make: up to 1.5 x rated current
Break: 1 x rated current

Utilization Category: 100 % AC-1

1) AC... Utilization Category are determined at 400 V AC. Apply a derating factor of .9 (90%) for corresponding 460 V AC. values.

Determination of the Maximum Number of Operations per hour Dependent on the Switching Capacity and Utilization Category (approximate values)

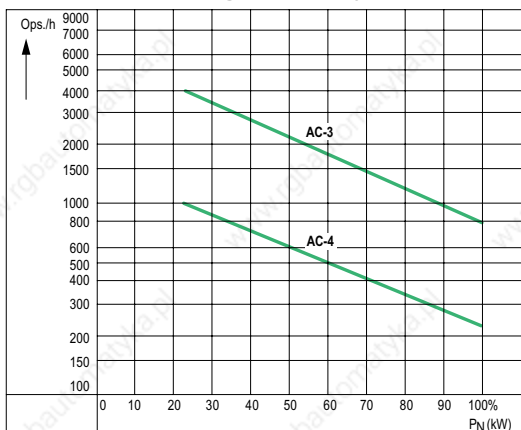

P_N = Maximum HP Rating of the Contactor.
Ops./h. = Maximum operating frequency per hour.

Tripping Characteristics Manual Motor Protectors, Motor Protector Combinations

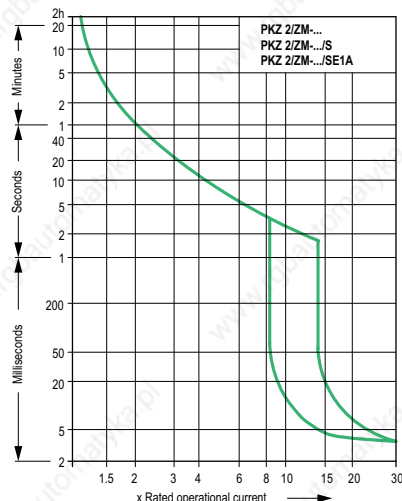

Let-Through Current Characteristics, Manual Motor Protectors

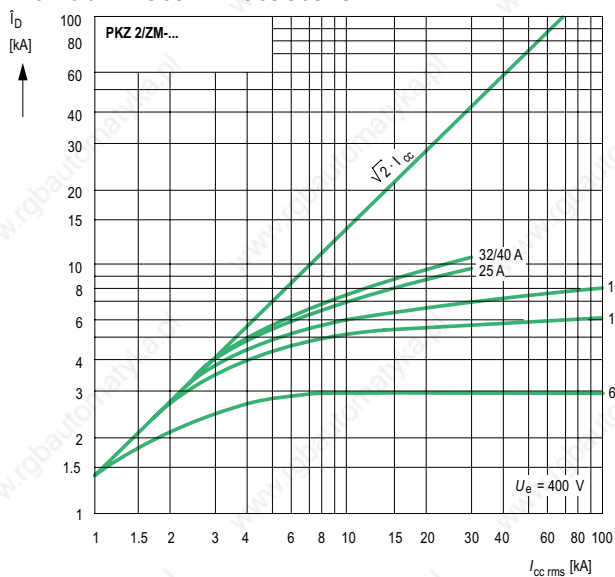

Let-Through Energy Characteristics, Manual Motor Protectors

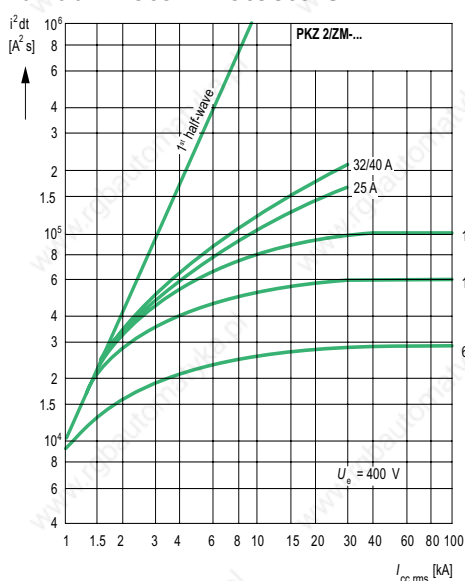

Let-Through Current Characteristics, Motor Protector Combinations

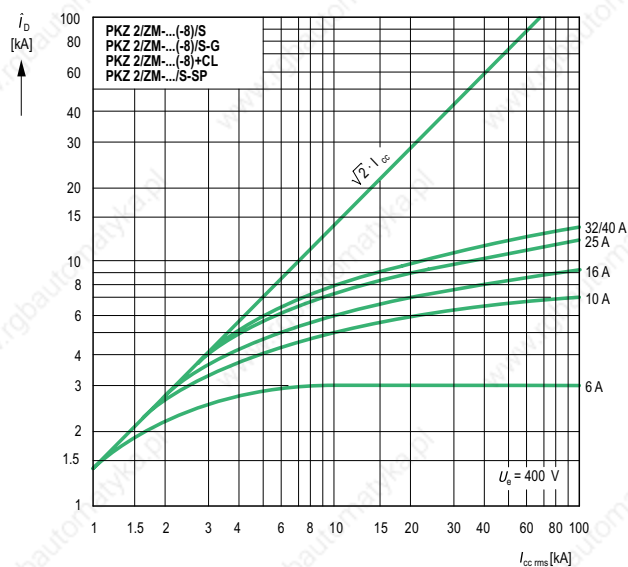

Let-Through Energy Characteristics, Motor Protector Combinations

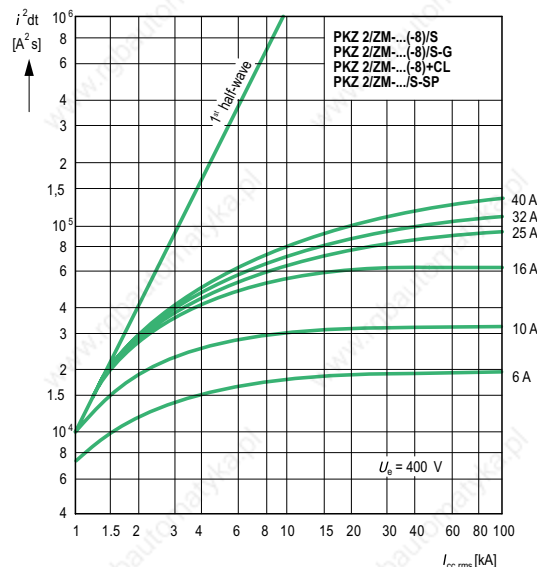

System PKZ 2- Motor Protector

Technical Data

General

Standards	IEC/EN 60 947, DIN VDE 0660, UL 508, CSA C 22.2 No. 14, CE, GL, LR, DNV, PRS, BV, RINA, RS, MEEI, EZU		
Climatic Proofing	Damp Heat, Constant, to IEC 60 068 Part 2-3 Damp Heat, Cyclical, to IEC 60 068 Part 2-30		
Ambient Temperature	Storage	min./max. °C	-25/+70
	Open	min./max. °C	-25/+60
	Enclosed	min./max. °C	-25/+40
Mounting Position			

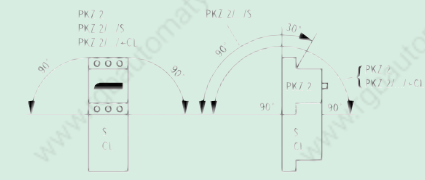

Direction of Incoming Supply	Optional, top or bottom feed		
Environmental rating	IP 20		
Mechanical Shock Resistance (Half-sinusoidal shock 20 ms)	g	Manual Motor Protector: 30	Motor Protector Combination: 8
Altitude	m	2000	
IEC Terminal Capacities			
1 Conductor: Solid	min./max. mm ²	1...16	
Flexible with Ferrule	min./max. mm ²	1.5...10	
2 Conductors: Solid	min./max. mm ²	1...6	
Flexible with Ferrule	min./max. mm ²	1.5...6	
UL/CSA Terminal Capacities	min./max. AWG	14...6	
Tightening Torque	Power terminals	Nm	1.8
	Control Terminals	Nm	1.0

Main Contacts

IEC/EN 60 947 Data:			
Rated Impulse Withstand Voltage U _{imp}	V	6000	
Oversvoltage Category / Pollution Degree		III/3	
Maximum Rated Operational Voltage U _e	V AC	690	
Rated Uninterrupted Current I _u = Rated Operational Current I _e	A	42 or Thermal Trip Dial Setting	
Rated Frequency	Hz	50 - 60	
Current Heat Losses	3-Pole at Operational Temperature	W	Manual Motor Protector: 14 Motor Protector Combination: 23
Lifespan, Mechanical	Ops.	Manual Motor Protector: 0.1 x 10 ⁶	High Capacity Magnetic Contactor: 5.0 x 10 ⁶
Lifespan, Electrical (At max. loading.)	(100 %) AC-3	(the mechanical life is reduced by 30% for a dual-frequency coil 50/60 Hz)	
(Refer to curves p. 7/48)	AC-4	Manual Motor Protector: 0.05 x 10 ⁶	High Capacity Magnetic Contactor: 1 x 10 ⁶
Max. Operating Frequency	Ops./hr	High Capacity Magnetic Contactor: 0.03 x 10 ⁶	
		Manual Motor Protector: 60	High Capacity Magnetic Contactor: Characteristic Curves, Page 7/47
Motor Switching Capacity AC-3	V AC	max. 690	
Motor Switching Capacity DC-5	V DC	max. 250	
	ADC	max. 40	
DC Application			
Rated Short-Circuit Breaking Capacity		PKZ 2/ZM-...:	PKZ 2/ZM-.../S(+CL):
I _{cn} (250 V DC) L/R = 15 ms	kA	30	50
I _{cn} (125 V DC)	kA	50	65
Operating Times under Short-Circuit Conditions		PKZ 2/ZM-...:	PKZ 2/ZM-.../S(+CL)
Minimum Command Time	Approx. ms	2	2
Opening Delay	Approx. ms	0.5	0.5
Total Clearing Time	Approx. ms	6	4

Motor Protective Trip Modules

ZM-...-PKZ 2, ZMR-...-PKZ 2

Temperature Compensation	min./max. °C	-5/+40
Temperature Compensation Residual Error	%/K	0.25
Magnetic Trip Tolerance	%	± 20
Adjustable Thermal Setting Range	x I _u	0.6...1.0
Adjustable Magnetic trip Setting range	x I _u	8.5...14
Single-Phasing Sensitivity	IEC/EN 60 947-4-1, DIN VDE 0660 Part 102, UL 508, CSA C 22.2 No. 14	

Manual Motor Protectors, Motor Protectors with Contactor
Motor Starter Combinations

7

S-PKZ 2 High Capacity Magnetic Contactor

Magnet Systems

AC Operation

(U_s = Coil Voltage Rating)

Operating Range	Pull-in	$x U_s$	0.85...1.1
	Drop-out	$x U_s$	0.4...0.6
Power Consumption	Pull-in	VA	≤ 190
	Sealing	VA	≤ 13

DC Operation

Rated Coil Voltage Rating U_s		V DC	24
Power Consumption	Pull-in	VA	150
	Pull-in	A	6.3 (16 - 22 ms)
	Sealing	W	2.7
	Sealing	mA	113
Switching Times			
Closing Time		ms	9 - 30
Opening Time		ms	4 - 12
Duty Factor		% DF	100

Note:
24 V DC energization using PLC semi-conductor outputs is possible. Use PLC Type: **PS 416-OUT-410** (Refer to Section 1) and switching two outputs in parallel. The alternative is to use the interface relay Type **ETS 4-VS 3** (Section 2).

Auxiliary Contacts

UL/CSA Pilot Duty Ratings	NHI, NHI...S AGM NHI 2-11S, HI...-S HI 11-S/EZ ZMR	A 600, R 300 A 600, R 300 A 600, R 300 A 600, R 300 0.5 A @ 300 V AC
---------------------------	---	--

IEC/EN 60 947 Ratings

Rated Operational Current I_o
AC-15

NHI 11, NHI 11S, NHI 2-11S, HI 11S/EZ	A	6	3	1.5
NHI 22, NHI 22S, HI 11-S, HI 20-S	A	6	1.5	1.5
AGM 2-11	A	5	3	1.5
ZMR... 95 - 96	A	1.5	0.7	0.5
ZMR... 97 - 98	A	1.5	0.5	0.3

DC-13

ZMR... L/R ≤ 200 ms	A	1	0.8	0.7	0.3
--	---	---	-----	-----	-----

Lifespan,

Mechanical

NHI, NHI...S	S	0.1×10^6
AGM		0.01×10^6
NHI 2-11S, HI...-S		5×10^6
HI 11-S/EZ		5×10^6
ZMR		0.01×10^6
NHI, NHI...S	S	0.05×10^6
AGM		5×10^3
NHI 2-11S, HI...-S		1×10^6
HI 11-S/EZ		1×10^6
ZMR		5×10^6

Electrical

Control Circuit Reliability

Fault Probability H_f at Rated Operational Voltage 24 V DC
($U_{min} = 24$ V, $I_{min} = 10$ mA)

Fail-Safe over the Entire Mechanical Lifespan

Positively Driven Contacts to ZH 1/457

Short-Circuit Rating Without Welding: (IEC/EN 60 204 applications)
Fuseless

NHI 2-11S, AGM 2-11

With PKZM 0-6.3:	240 V
PKZM 0-4:	415 V
PKZM 0-1.6:	500 V

Fuse

A gL	10
------	----

Terminal Capacities

1 or 2 Conductors

Solid or Flexible (with Ferrule for IEC/EN applications)

IEC/EN min./max.	mm ²	0.75...2.5
UL/CSA min./max.	AWG	18...14
Torque	Nm	1



System PKZ 2- Motor Protector Technical Data

Voltage Trips- General

Rated Operational Voltage U_s	V AC	24...600
	V DC	A-PKZ 2: 24...250; U-PKZ 2: 24...125
Terminal Capacities 1 or 2 Conductors Solid or Flexible (with Ferrule for IEC/EN applications)		

IEC/EN	min./max.	mm ²	0.75...2.5
UL/CSA	min./max.	AWG	22...14

Shunt Trips

(U_s = Trip coil rated voltage)

Operating Range	AC	x U_s	0.7...1.1
	DC	x U_s	0.7...1.1
Power Consumption	AC	Pull-in	VA
		Sealing	VA
	DC	Pull-in	W
		Sealing	W

Undervoltage Trips

Drop-out Voltage	(U_s = Trip coil rated voltage)	x U_s	0.7...0.35
Power Consumption	AC	Pull-in	VA
		Sealing	VA
	DC	Pull-in	W
		Sealing	W
Drop-out Delay with UVHI-PKZ 2		ms	200

Auxiliary Contacts **U-HI 20-PKZ 2**, **UVHI-PKZ 2**:

IEC/EN 60 947 Rated Operational Current I_s AC-15	A	230 V	400 V	440 V
		6	3	1.5
UL/CSA Pilot Duty Ratings		B600, R300		

RE-PKZ 2, RS-PKZ 2 Remote Control Drives

Rated Operational Voltage	U_s AC (50/60 Hz), DC	V	24...120 (> 120V, IEC only)
	U_s AC (50/60 Hz)	V	380...440 (IEC only)

Necessary short-time power requirement	VA/W	700 VA/W, for a duration of 30 ms
Control Transformer Short-Time duration Power Rating	VA	1100 VA → (Use STI 0.4 transformer from Section 12)
Total Closing Time	ms	≤ 30
Total Opening Time	ms	≤ 30
Reset to OFF Time	ms	≤ 30
Operating Frequency	Ops./h	60
Operating Range	x U_s	0.85...1.1
	x U_s	0.85...1
Lifespan, Electrical	Operations	50000

Integral Auxiliary Contacts (Hand/Auto 33/34):

UL/CSA Pilot Duty Ratings		D 300, R 300		
IEC/EN 60 947 Rated Operational Current I_s AC-14	50 Hz	230/240 V	400/415 V	440 V
	A	1.5	1	0.5

Terminal Capacities
1 or 2 Conductors
Solid or Flexible (with Ferrule for IEC/EN applications)

IEC/EN	min./max.	mm ²	0.75...2.5
UL/CSA	min./max.	AWG	22...14

Three Phase Feeder Bus Connectors

UL/CSA Data:		V AC	600
Maximum Rated Voltage		A	85
Maximum Rated Current	Type B 3.1/2-PKZ 2	A	100
	Type B 3.1/3-PKZ 2	A	100

Bus connector Incoming Supply Terminal

UL/CSA Data:		V AC	600
Maximum Rated Voltage		A	100A
Maximum Rated Current	Type BK 50/3-PKZ 2		
Terminal Capacities	UL/CSA	min./max.	AWG
		Torque Rating	Nm
			14...0
			4.5

UL/CSA Single Phase HP Ratings

Always use 3 Poles for wiring

Manual Motor Protector Type

1 Phase HP @	115VAC	200VAC	230VAC
PKZ 2/ZM-1.6	-	-	1/10
PKZ 2/ZM-2.4	-	1/8	1/6
PKZ 2/ZM-4	1/8	1/4	1/3
PKZ 2/ZM-6	1/4	1/2	1/2
PKZ 2/ZM-10	1/2	1	1 1/2
PKZ 2/ZM-16	1	2	2
PKZ 2/ZM-25	2	3	3
PKZ 2/ZM-32	2	5	5
PKZ 2/ZM-40	3	5	7 1/2

(High Capacity) Magnetic Contactor

S-PKZ 2	3	5	7 1/2
----------------	---	---	-------

Three Phase IEC kW Ratings (AC 3)

Manual Motor Protector Type	AC 3 kW Ratings @					
	220V 230V 240V	380V 400V 415V	440V	500V	660V 690V	
PKZ 2/ZM-0.6	0.09	0.12	0.18	0.25	0.25	
PKZ 2/ZM-1	0.18	0.25	0.25	0.37	0.55	
PKZ 2/ZM-1.6	0.25	0.55	0.55	0.8	1.1	
PKZ 2/ZM-2.4	0.37	0.8	1.1	1.1	1.5	
PKZ 2/ZM-4	0.8	1.5	1.5	2.2	3	
PKZ 2/ZM-6	1.5	2.5	3	3	4	
PKZ 2/ZM-10	2.5	4	5	5.5	7.5	
PKZ 2/ZM-16	4	7.5	9	10	13.5	
PKZ 2/ZM-25	5.5	12.5	12.5	15	22	
PKZ 2/ZM-32	7.5	15	17.5	22	22	
PKZ 2/ZM-40	11	20	22	24	30	

Motor Protector + Contactor
Combination

PKZ 2/ZM-0.6/S...	0.09	0.12	0.18	0.25	0.25
PKZ 2/ZM-1/S...	0.18	0.25	0.25	0.37	0.55
PKZ 2/ZM-1.6/S...	0.25	0.55	0.55	0.8	1.1
PKZ 2/ZM-2.4/S...	0.37	0.8	1.1	1.1	1.5
PKZ 2/ZM-4/S...	0.8	1.5	1.5	2.2	3
PKZ 2/ZM-6/S...	1.5	2.5	3	3	4
PKZ 2/ZM-10/S...	2.5	4	5	5.5	7.5
PKZ 2/ZM-16/S...	4	7.5	9	10	13.5
PKZ 2/ZM-25/S...	5.5	12.5	12.5	15	22
PKZ 2/ZM-32/S...	7.5	15	17.5	22	22
PKZ 2/ZM-40/S...	11	20	22	24	30

PKZ2/ZM(R)-...(S) Motor Protector Trip curve

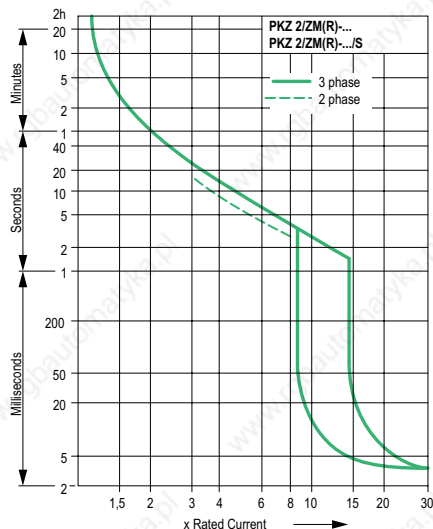

The trip curve shows the tripping time of the Motor Protector in relation to the response current. The curve shows mean values of the tolerance ranges at an ambient temperature of 20 °C, starting from cold. The tripping time of the bimetal trips at operational temperature (warm state) is reduced to approximately 1/4 of the values shown. System PKZ 2 Motor Protectors are suitable for protection of IEC Type EEx e- explosion-proof motors. Specific characteristics for each individual setting range are available on request. These characteristics, in 55 x 75 mm format (self-adhesive), can be used as on-site documentation to verify the suitability of each Motor Protector for this application. The data has been independently verified by the German PTB testing agency and laboratory.

Circuit Diagram

For PKZ 2/ZMR-...
and PKZ 2/ZMR-.../S

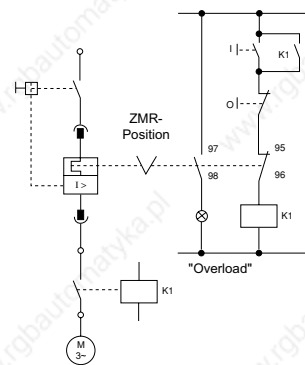

Note: Use of the ZMR-...-PKZ 2 Protective Trip Module in EEx e applications: In EEx e applications the N.C. 95 - 96 of the ZMR protective trip module must always be wired in series with the contactor coil in the starter circuit. See diagram above.

System PKZ 2 Motor Protectors:
Suitable for protection of IEC Type EEx e
Explosion-proof motors.

System PKZ 2 Short Circuit Ratings per IEC/EN 60 947 Standards for international applications

I_u = Maximum Continuous Current Rating of each device.
 I_q = Conditional Short Circuit Current Rating (per IEC/EN 60 947-4-1, relevant for Motor Starters and Motor Starter Combinations)
 I_{cu} = Ultimate Breaking Capacity (per IEC/EN 60 947-2, relevant for circuit breakers)
 I_{cs} = Continuity of Service Breaking Capacity (per IEC/EN 60 947-2, relevant for circuit breakers)
 (All kA ratings are RMS Sym. values)

- Indicates Self-Protected Range (100kA)
- N - Not necessary. Back-up protection is not required whenever device is operating within its self-protected range or up to the available short circuit fault current value shown in each respective column.

I_u A	230 V				400 V				440 V				500 V				690 V			
	I_q kA	I_{cu} kA	I_{cs} kA	A	I_q kA	I_{cu} kA	I_{cs} kA	A	I_q kA	I_{cu} kA	I_{cs} kA	A	I_q kA	I_{cu} kA	I_{cs} kA	A	I_q kA	I_{cu} kA	I_{cs} kA	A

PKZ 2/ZM-...Motor Protector, Coordination Types "1" and "2"

0.16 - 1.6					N					N					N					N								
2.4					N					N					N					N								
4					N					N					N					4.5	4.5	2.5	63					
6					N					N					N					4.5	4.5	2.5	80					
10					30	N					30	N					10	10	5	80	7	7	3.5	80	4.5	4.5	2.5	80
16					30	N					30	N					10	10	5	100	7	7	3.5	100	4.5	4.5	2.5	100
25	30	30	7.5	160	30	30	7.5	160	10	10	5	125	7	7	3.5	125	4.5	4.5	2.5	125	4.5	4.5	2.5	125				
32	30	30	7.5	160	30	30	7.5	160	10	10	5	160	7	7	3.5	160	4.5	4.5	2.5	160	4.5	4.5	2.5	160				
40	30	30	7.5	160	30	30	7.5	160	10	10	5	160	7	7	3.5	160	4.5	4.5	2.5	160	4.5	4.5	2.5	160				

PKZ 2/ZM-... Motor Protector + CL-PKZ 2 Current Limiter, Coordination Types "1" and "2"

0.16 - 1.6					N					N					N					N								
2.4					N					N					N					N								
4					N					N					N					10	4.5	2.5	N					
6					N					N					N					10	4.5	2.5	N					
10					30	N					30	N					5	N					3.5	N	10	4.5	2.5	N
16					30	N					30	N					5	N					3.5	N	10	4.5	2.5	N
25					7.5	N					7.5	N					5	N					3.5	N	10	4.5	2.5	N
32					7.5	N					7.5	N					5	N					3.5	N	10	4.5	2.5	N
40					7.5	N					7.5	N					5	N					3.5	N	10	4.5	2.5	N

PKZ 2/ZM-.../S(-G) High capacity Motor Protector Combination, Coordination Types "1" and "2"

0.6 - 2.4		-	-	N		-	-	N		-	-	N		-	-	N		-	-	N	
4 - 6		-	-	N		-	-	N		-	-	N		-	-	N		10	-	-	80
10 - 16		-	-	N		-	-	N		-	-	N		-	-	N		10	-	-	100
25 - 40		-	-	N		-	-	N		-	-	N		-	-	N		10	-	-	160

Manual Motor Protectors, Motor Protectors with Contactor
Motor Starter Combinations

7

Manual Motor Protectors

PKZM 0-... (+NHI-E-...-PKZ 0)

PKZM 0-...T

PKZ 0-...

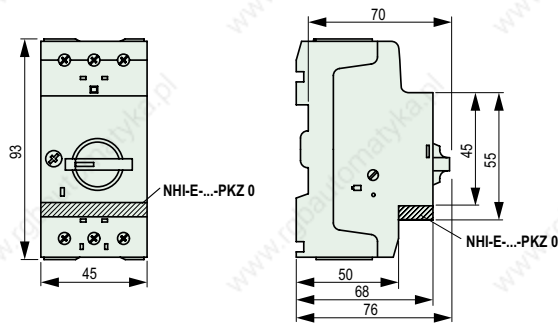

PKZM 0-... +AK-PKZ 0

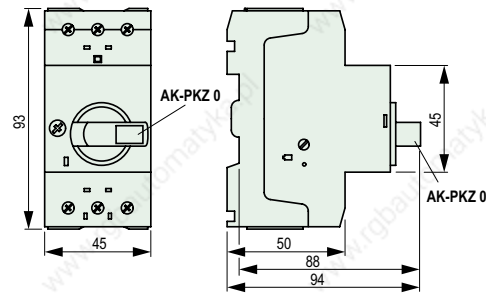

Current Limiters

CL-PKZ

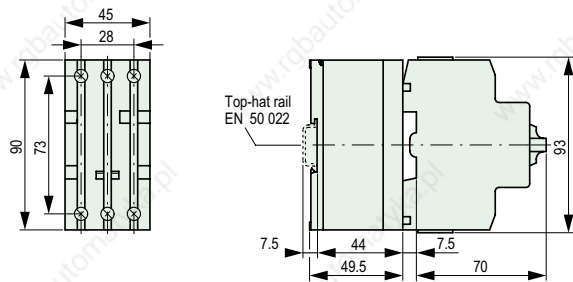

Manual Motor Protectors

PKZM 0-... +VHI-...-PKZ 0

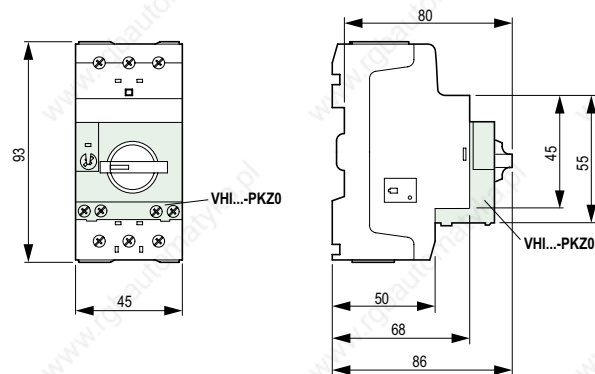

Magnetic Motor Protector Combinations

PKZM 0-.../S(E) 00 (+NHI-E-...-PKZ 0)

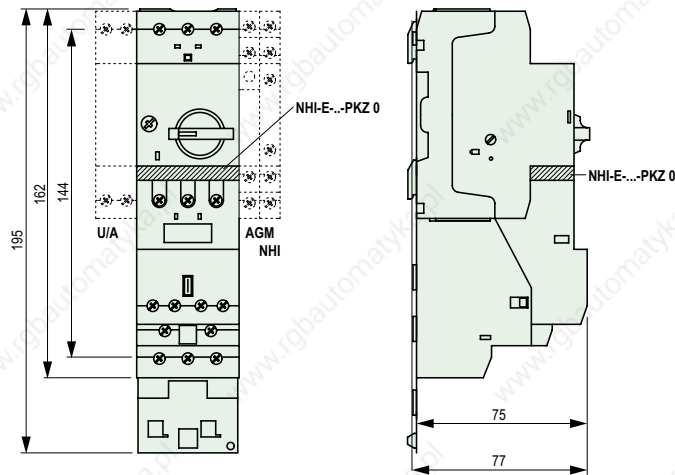

Standard Auxiliary Contacts for Motor Protector Combinations

NHI 2-11S-PKZ 0

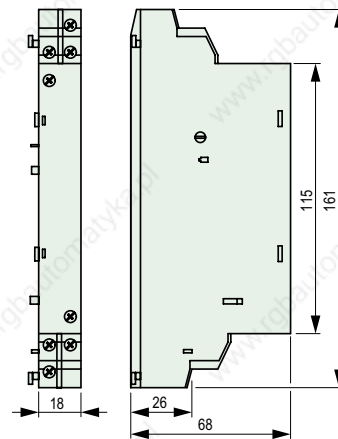

Standard Auxiliary Contacts

NHI-...-PKZ 0

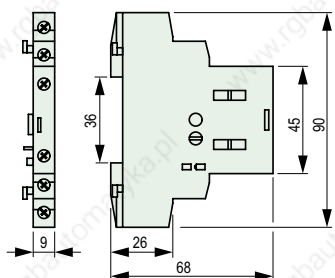

Trip-Indicating Auxiliary Contacts

AGM 2-...-PKZ 0

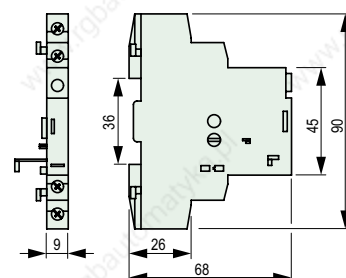

Voltage Trips

U/A-PKZ 0

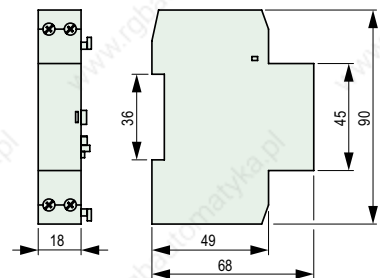

System PKZ 0 Dimensions

Magnetic Contactor Modules S(E) 00-PKZ 0

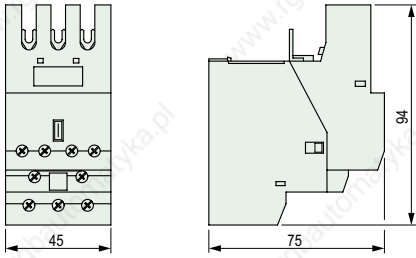

Separate Mounting EZ-PKZ 0

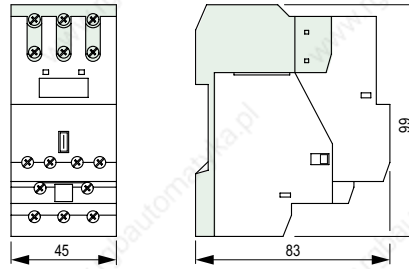

Auxiliary Contacts for Magnetic Contactor Modules HI 11-S/EZ-PKZ 0

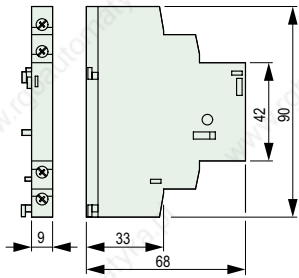

Mechanical Interlocks MV-PKZ 0

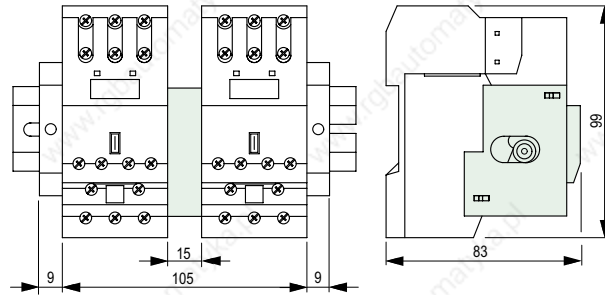

Three-Phase Feeder Bus Connectors B3.0/2-PKZ 0 B3.0/4-PKZ 0

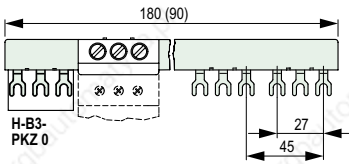

B3.2/2-PKZ 0 B3.2/4-PKZ 0

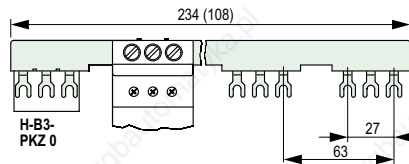

Three-Phase Feeder Bus Connectors B3.1/2-PKZ 0 B3.1/3-PKZ 0 B3.1/4-PKZ 0 B3.1/5-PKZ 0

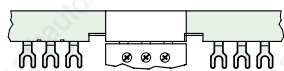
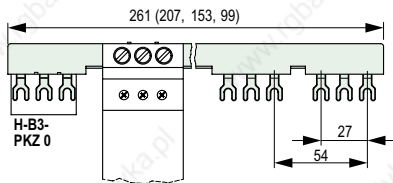

Use overlapping mounting to extend three-phase feeder bus connectors.

Terminals BK25/3-PKZ 0

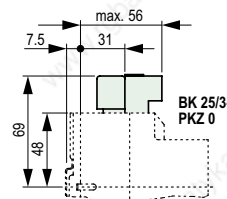

Cover for Unused Terminals H-B3-PKZ 0

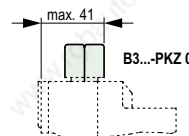
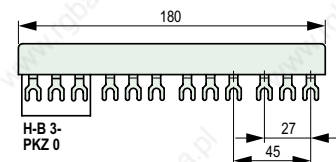

**Insulated Enclosures for Surface Mounting
CI-PKZ 0**

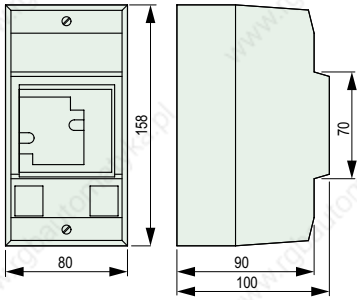

CI-PKZ 0-G(R)(V)

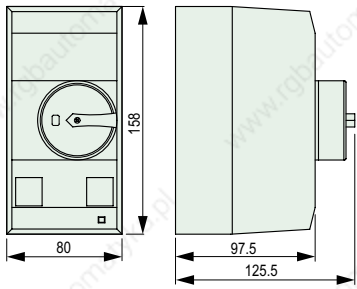

**CI-PKZ 0-G(R)(V)
+SVB-PKZ 0-CI**

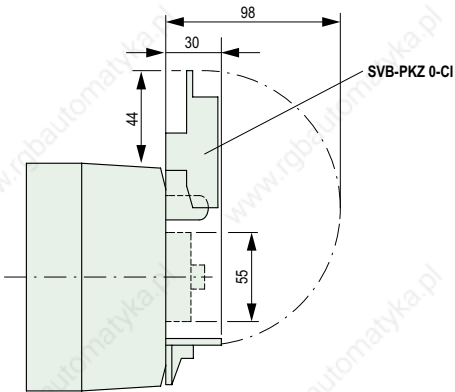

**Drilling dimensions
CI-PKZ 0...**

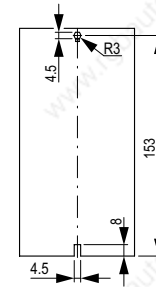
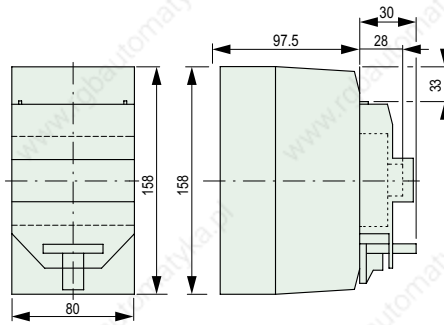

System PKZ 0 Dimensions

Insulated Enclosures for Surface Mounting CI 23 X-125-NA

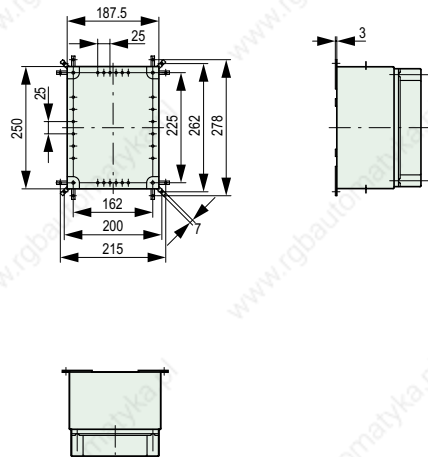

Door Coupling Handles (R)H-PKZ 0, HS0V-PKZ 0

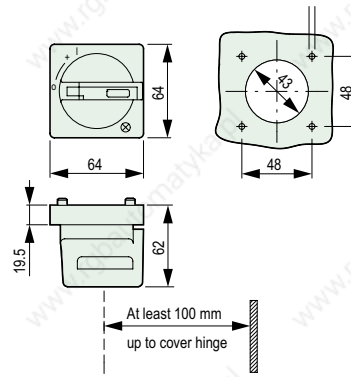

Mounting depth:
100 to 240 mm from top edge
of mounting rail to front edge
of panel door/cover

Mounting Plate M 3-CI 23

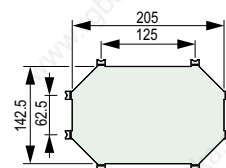

Insulated Housings for Cavity Mounting E-PKZ 0 E-PKZ 0-G(R)

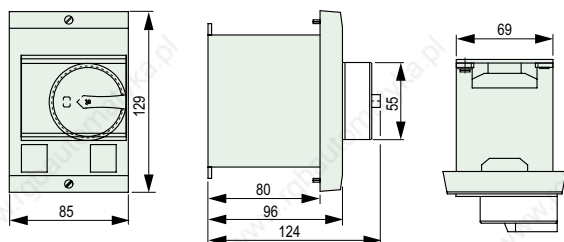

Mounting Opening E-PKZ 0...

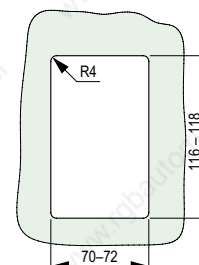

E-PKZ 0-G(R) +SVB-PKZ 0-E

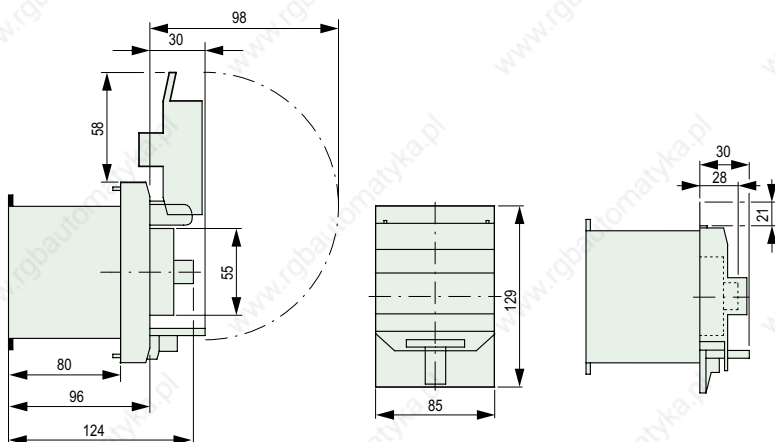

Component Adapters

AD 25/5(10)-1

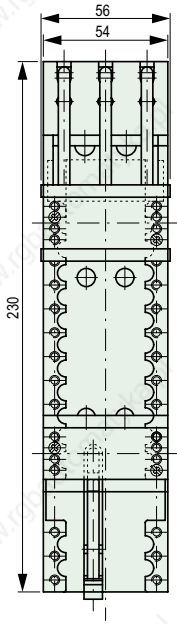

AD 25/5(10)-2

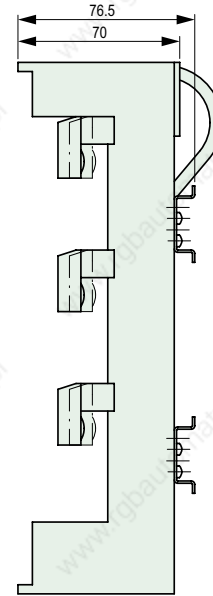
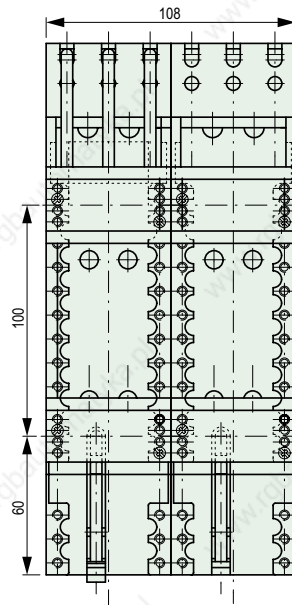

AD 25/5(10)-144

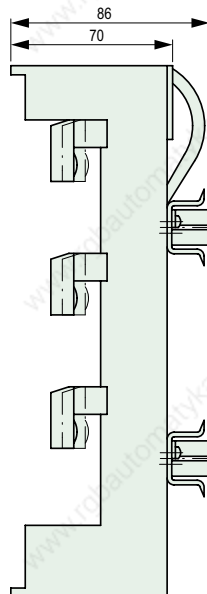
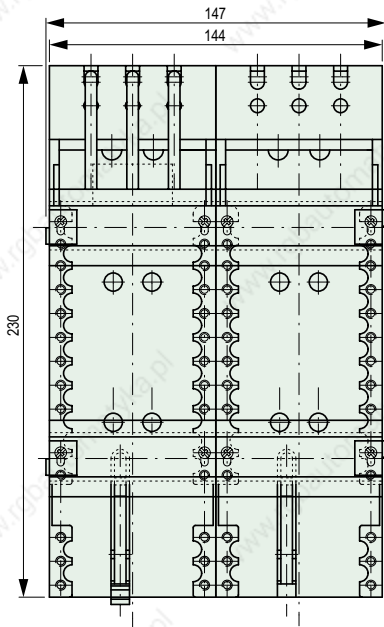

System PKZ 2 Dimensions

Manual Motor Protectors, Trip Modules

PKZ 2/(Z)M-...
ZMR-...-PKZ 2

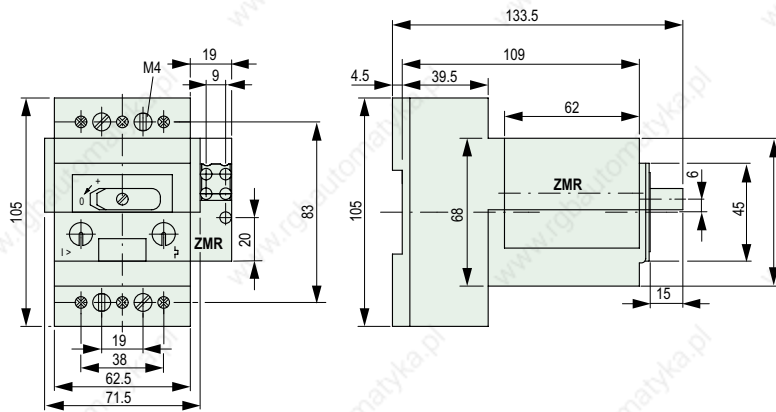

Trip Indicating Auxiliary Contacts

AGM 2-11 PKZ 2

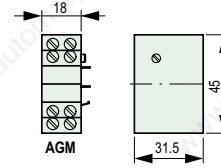

Standard Auxiliary Contacts

NHI...PKZ 2

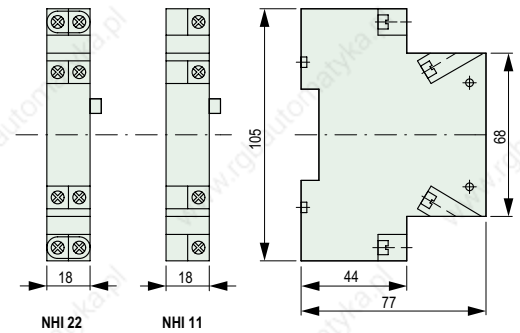

Remote Control Drives

RE-PKZ 2 (...)
RS-PKZ 2 (...)

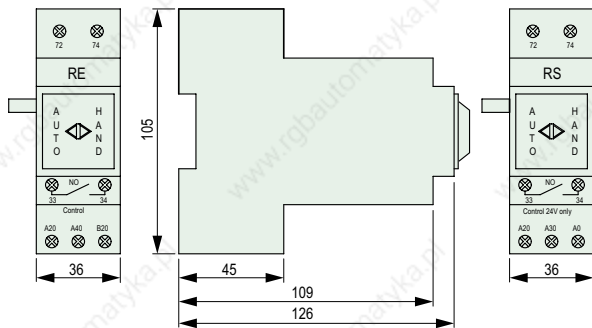

Voltage Trips

U-PKZ 2 (...)
A-PKZ 2-...

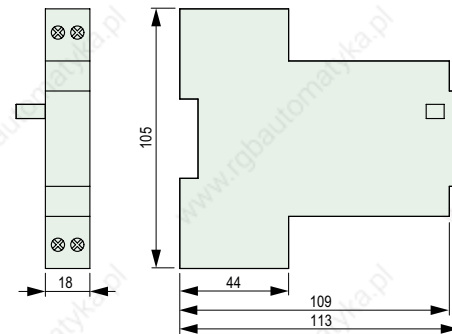

Manual Motor Protectors, Motor Protectors with Contactor
Motor Starter Combinations

7

High Capacity Magnetic Motor Protector Combinations

PKZ 2/ZM-.../S(-SP)

PKZ 2/ZM-.../S(-G)

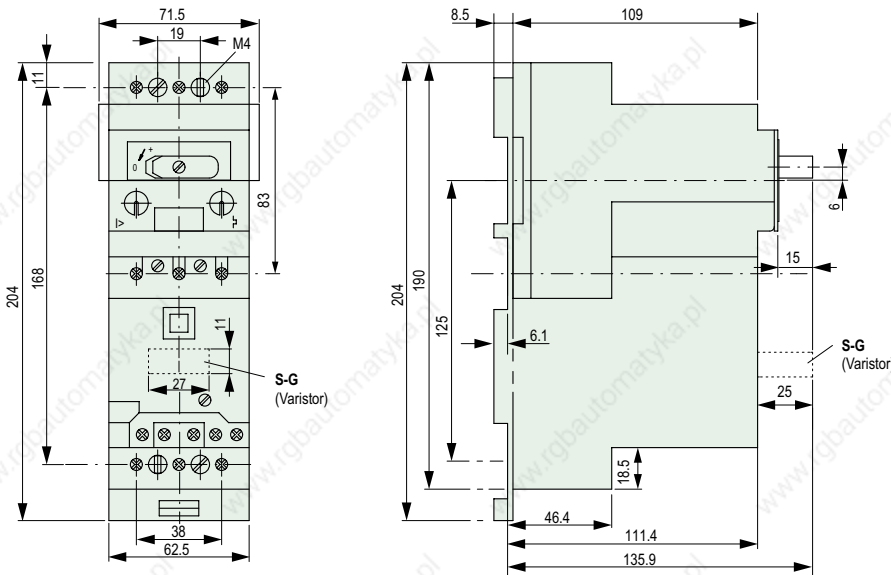

Standard Auxiliary Contacts for High Capacity Magnetic Motor Protector Combinations

NHI...S-PKZ 2

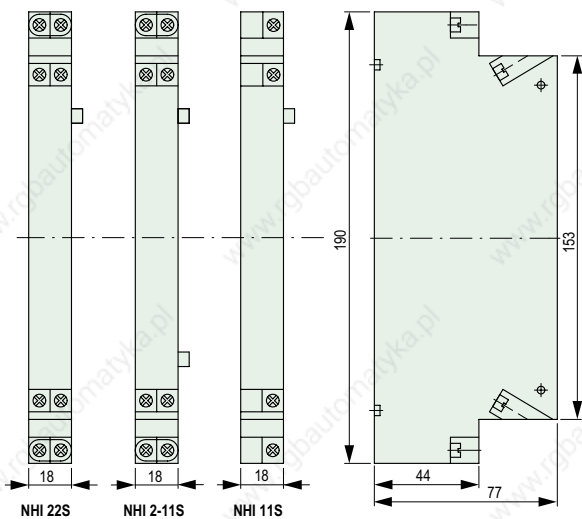

System PKZ 2 Dimensions

S(-G) High Capacity Magnetic Contactor Module
CL Current Limiters

EZ Base for Separate Mounting
HI11-S/EZ Standard Auxiliary Contact for **EZ** Separate Mounting

Manual Motor Protectors, Motor Protectors with Contactor
Motor Starter Combinations

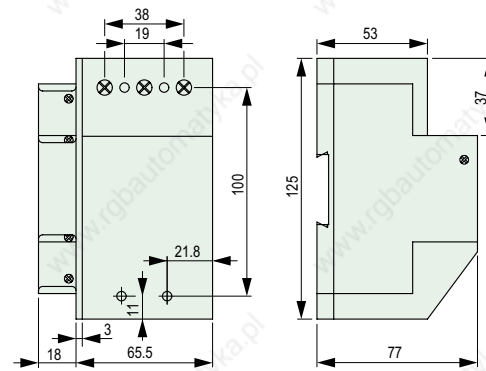
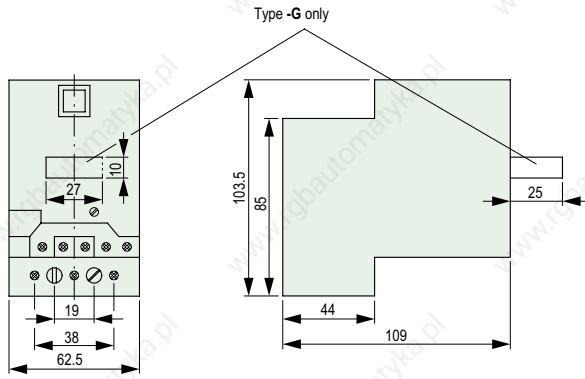

Enclosures for Surface Mounting CI 19 EE-PKZ 2-NA

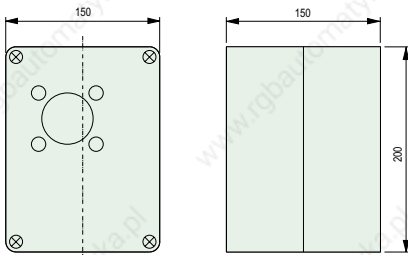

CS3-PKZ 2

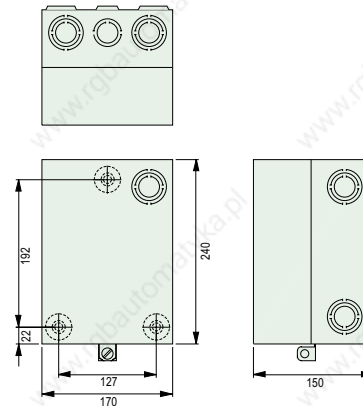

S1 GK-PKZ 2

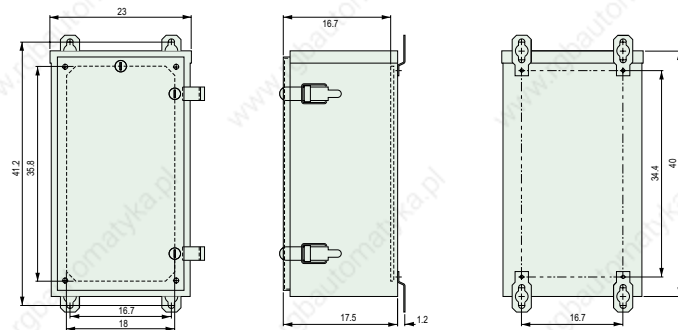

CI 43-PKZ 2

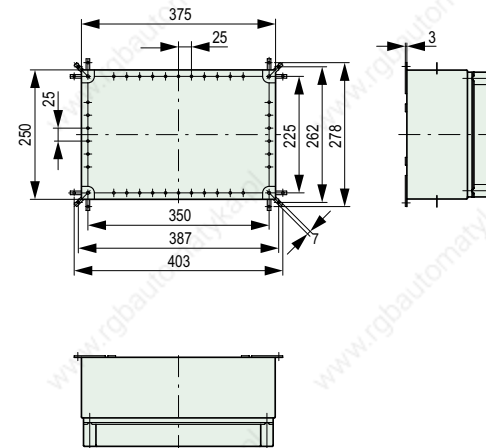

**Mechanical Interlock for High Capacity
Magnetic Contactor Module**

MV-PKZ 2

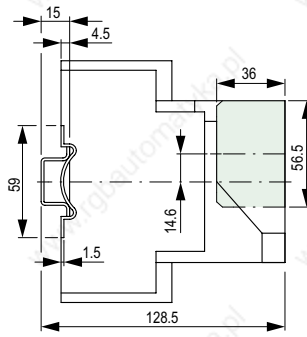
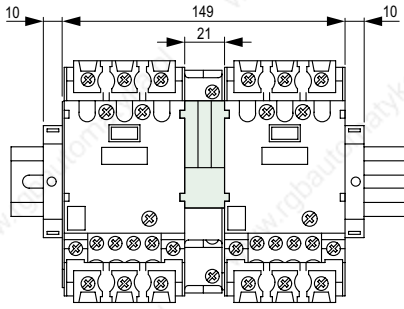

**Door Coupling Handle
(R)H-PKZ 2**

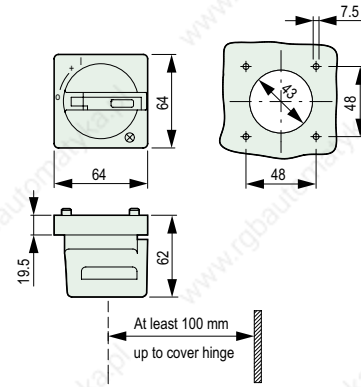

**Three-Phase Feeder Bus Connector
B3.1/3 PKZ 2**

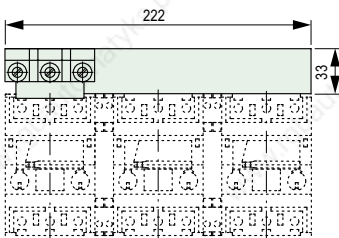

B3.1/3 PKZ 2

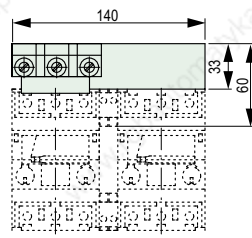

**Terminal
BK.50/3-PKZ 2**

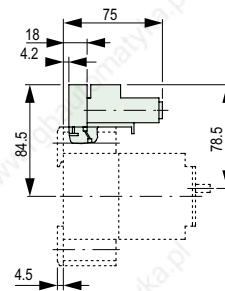

**Cover for Unused
Terminals
HB-3-PKZ 2**

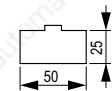

Measurement
three-phase feeder
bus connector

System PKZ 2 Dimensions

Component Adapters
AD 40/5(10)-1

AD 40/5(10)-1

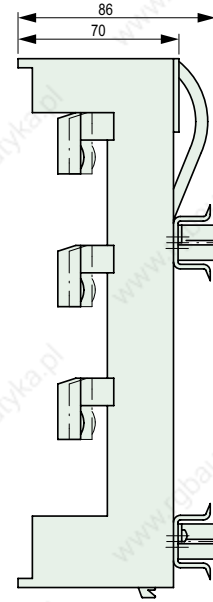
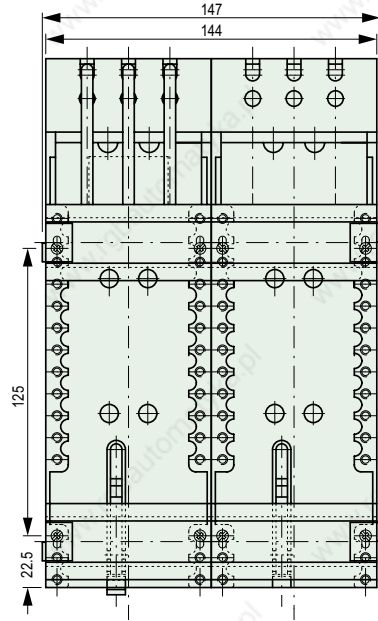
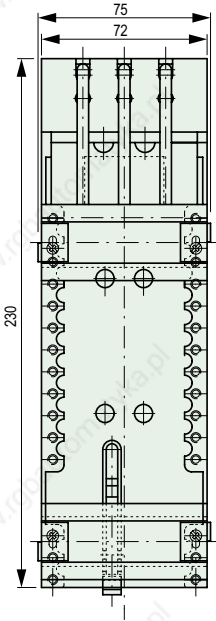

Manual Motor Protectors, Motor Protectors with Contactor
Motor Starter Combinations

7