



11/91 AWA 27-772

## SUCOS PS 316

### Allgemeine Hinweise

#### Transport, Lagerung, Austausch

Zur Verhinderung elektrostatischer Entladungen empfehlen wir, die Baugruppen nur am Griff und/oder an der Frontplatte anzufassen.



**Die Baugruppen nur bei spannungsloser PS ziehen oder stecken.  
Baugruppencodierung beachten!**

### General notes

#### Transport, storage, exchange

In order to prevent cards being damaged, we recommend that you hold the cards only by the handle and/or the front plate.



**Switch off PS316 before inserting or removing the cards.  
Note the coding of the cards!**

### Remarques générales

#### Transport, stockage, remplacement

Afin d'éviter les décharges électrostatiques, il est recommandé de ne saisir les modules que par la poignée et/ou le plastron.



**Avant d'embrocher ou de débrocher un module, mettre toujours l'automate  
hors tension.  
Attention au codage des modules!**

### Istruzioni generali

#### Trasporto, montaggio, sostituzione

Per evitare che le schede vengano danneggiate si raccomanda di prenderle solo per l'impugnatura e/o sulla piastra frontale.



**Togliere tensione al PS 316 prima di inserire o rimuovere i moduli.  
Fare attenzione alla codifica della scheda!**

### Indicaciones generales

#### Transporte, almacenamiento, sustitución

Para evitar daños en la tarjeta, recomendamos sujetarla solo desde la maneta y/o de la placa frontal.



**Las tarjetas deben insertarse o extraerse sólo con el PS desconectado.  
¡Atención a la codificación de las tarjetas!**

## Baugruppenträgeranordnung

## Rack arrangement

## Disposition des racks

## Disposizione dei rack

## Disposición de los racks

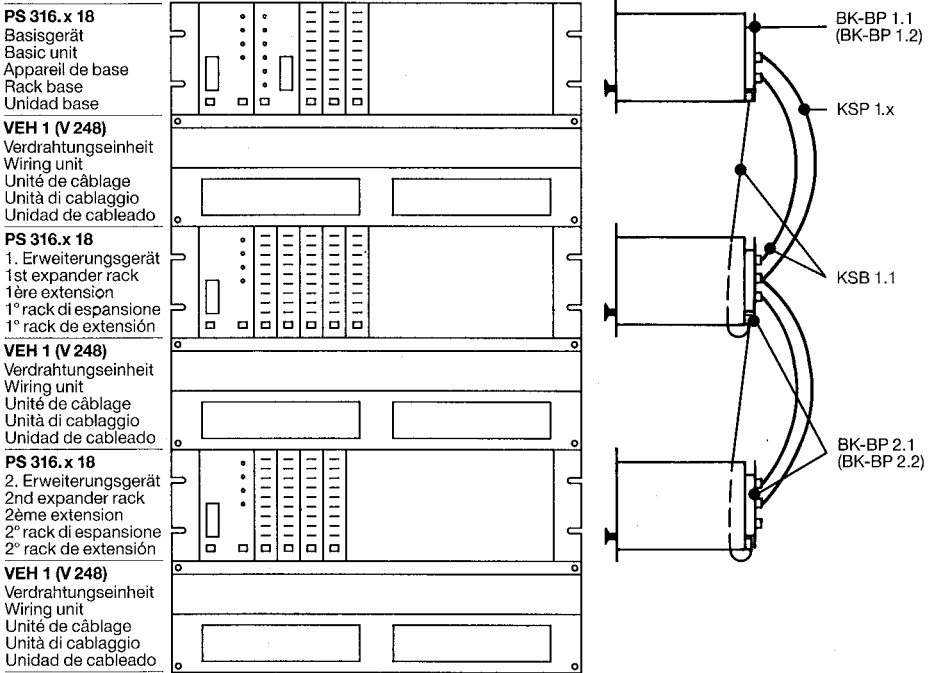

### Achtung:

Typen BK-BPx.1 und BK-BPx.2 nicht gemischt in einem Aufbau verwenden.

### Attention:

Types BK-BPx.1 and BK-BPx.2 cannot be mixed.

### Attention:

Les types BK-BPx.1 et BK-BPx.2 ne doivent pas être combinés.

### Attenzione:

I tipi BK-BPx.1 e BK-BPx.2 non possono essere utilizzati assieme.

### Atención:

Los tipos BK-BPx.1 y BK-BPx.2 no deben mezclarse.

### Montage der Basisgeräte PS 316.x 08 und PS 316.x 12

Kabelklammern aufkleben, Klebestellen vorher mit fettlösendem Reinigungsmittel säubern.

### Fitting the PS 316.x 08 and PS 316.x 12 basic units

Stick the cable clamp in place after cleaning area with a degreasing agent.

### Montage des appareils de base PS 316.x 08 et PS 316.x 12

Coller les attaches de câbles après avoir nettoyé les emplacements avec un solvant de graisses.

### Montaggio dei rack base PS 316.x 08 e PS 316.x 12

Incollare il guida cavo dopo aver pulito la superficie con un solvente per grassi.

### Montaje de las unidades base PS 316.x 08 y PS 316.x 12

Pegar los sujetacables después de limpiar el área con un desengrasante.

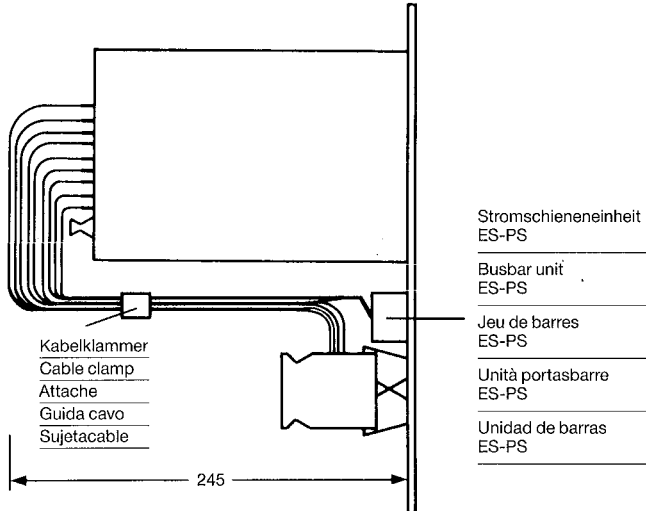

### Verdrahtung

110-V-/220-V- AC-Leitungen sind getrennt von 24-V-DC-Leitungen zu verlegen.

### Wiring

110V/220V a.c. cables are to be laid separately from 24V d.c. cables.

### Câblage

Les lignes 110V/220V CA doivent être posées séparément des lignes 24V CC.

### Cablaggio

Le linee a 110V/220V AC devono essere separate dalle linee a 24V DC

### Conexión

Los cables de 110V/220V AC deben quedar separados de los cables de 24V DC.

# Steckplatzbelegung des Basisgerätes

## Module location of the basic unit

## Affectation des postes d'enfichage de l'appareil de base

## Inserimento dei moduli sul rack base

## Ubicación de las tarjetas en la unidad base

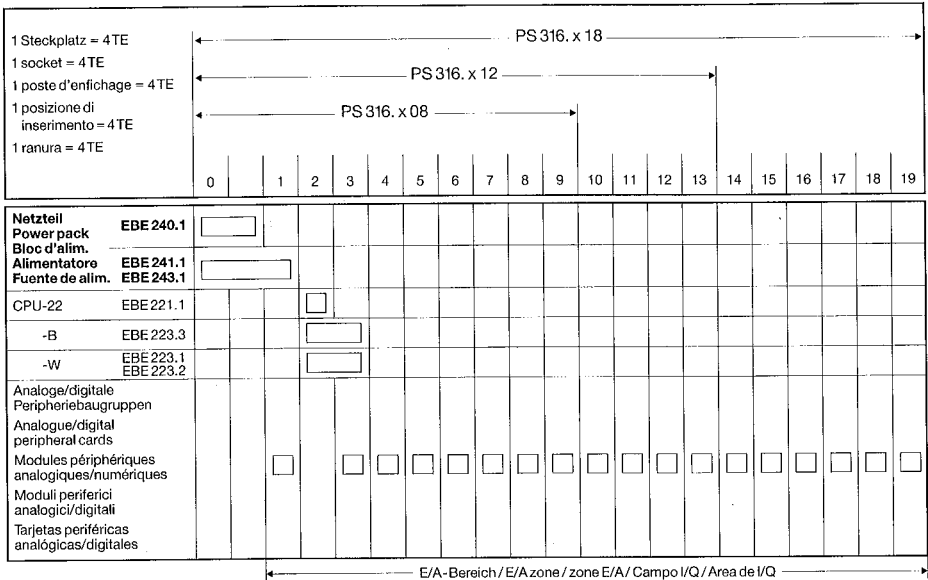

## Systemausbau

Maximal 1 Basisgerät + 4 Erweiterungsgeräte mit BK-BP x. 1  
maximal 1 Basisgerät + 7 Erweiterungsgeräte mit BK-BP x.2  
Bei mehr als 2 Erweiterungsgeräten muß ein Netzfilter FIL-PS vor die Netzteile EBE 241.1 geschaltet werden.

**ACHTUNG:**  
Bei Aufbauten mit mehr als 4 Erweiterungsgeräten müssen für alle Geräte die Buskoppereinheiten BK-BP x.2 verwendet werden.

---

## System Expansion

Max. 1 basic unit + 4 expander racks with BK-BP x.1  
Max. 1 basic unit + 7 expander racks with BK-BP x.2  
An FIL-PS mains filter must be connected in front of the EBE 241.1 power supply units if more than 2 expander racks are used.

**CAUTION:**  
The BK-BP x.2 bus coupling units must be used for all systems involving more than 4 expander racks.

---

## Extension du système

Max. 1 appareil de base + 4 appareils d'extension avec BK-BP x.1  
Max. 1 appareil de base + 7 appareils d'extension avec BK-BP x.2  
S'il y a plus de 2 appareils d'extension, un filtre d'alimentation doit être connecté en série avec les blocs d'alimentation EBE 241.1

**ATTENTION:**  
Pour les systèmes avec plus de 4 appareils d'extension, les unités de couplage pour bus BK-BP x.2 doivent être utilisés pour tous les appareils.

---

## Espansione del sistema

Max. 1 rack base + 4 rack espansione con BK-BP x.1  
Max. 1 rack base + 7 rack espansione con BK-BP x.2  
Se vengono utilizzati più di 2 rack di espansione deve essere montato un filtro di alimentazione sul lato frontale dell'alimentatore EBE 241.1.

**ATTENZIONE:**  
Per i sistemi con più di 4 rack di espansione devono essere utilizzate le unità di accoppiamento bus BK-BP x.2.

---

## Configuración del sistema

1 unidad base + 4 racks de extensión con BK-BP x.1 como máximo  
1 unidad base + 7 racks de extensión con BK-BP x.2 como máximo  
En sistemas con más de 2 racks de extensión debe utilizarse un filtro FIL-PS para las fuentes de alimentación EBE 241.1

**ATENCION:**  
En sistemas con más de 4 racks de extensión deben utilizarse en todos los racks las tarjetas de acoplamiento de bus BK-BP x.2.

# Buskopplung zu Erweiterungsgeräten

## Bus coupling for expander racks

### Couplage des bus pour appareils d'extension

### Collegamento bus per rack di espansione

### Acoplamiento de bus a racks de extensión

#### Montage

#### Installation

#### Montage

#### Montaggio

#### Montaje

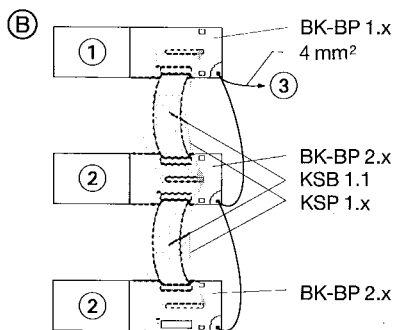
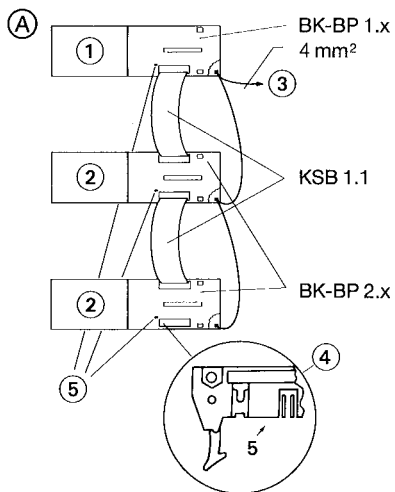
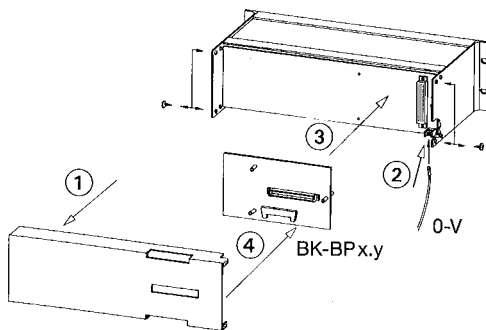

## Kodierung / Kabelanschluß

- Ⓐ Bit-I/O-Buskopplung
  - Ⓑ Parallelbuskopplung
- ① Basisgerät (Rückseite)
  - ② Erweiterungsgerät (Rückseite)
  - ③ Bei Betrieb mit potentialgebundenen Baugruppen (z. B. EBE 200, EBE 250): 0-V-Brücke zur Spannungsversorgung der potentialgebundenen Baugruppe.
  - ④ Jumper auf Stiftpaar Nr. 5 (von links)
  - ⑤ Kodierbrücke: immer offen
- 

## Coding / Cable connection

- Ⓐ Bit-I/O-Bus coupling
  - Ⓑ Parallel bus coupling
- ① Basic unit (rear)
  - ② Expander unit (rear)
  - ③ For potential-dependent modules, e. g. EBE 200 and EBE 250, connect the 0V-bridge to the power supply of the potential-dependent module concerned.
  - ④ Jumper on pin pair No. 5 (from left)
  - ⑤ Coding: always open
- 

## Codage / Raccordement des câbles

- Ⓐ Couplage de bus bit E/S
  - Ⓑ Couplage de bus parallèle
- ① Appareil de base (face arrière)
  - ② Appareil d'extension (face arrière)
  - ③ Pour opération sous potentiel (EBE 200, EBE 250): Pont 0V pour bloc d'alimentation des modules sous potentiel.
  - ④ Shunt sur paire de broches no. 5 (vu de gauche)
  - ⑤ Codage: toujours ouvert
- 

## Codifica / collegamento cavi

- Ⓐ Collegamento del bus a bit I/O
  - Ⓑ Collegamento del bus parallelo
- ① Rack di base (retro)
  - ② Rack di espansione (retro)
  - ③ Per il funzionamento con moduli non separati galvanicamente (p. es. EBE 200, EBE 250) ponte 0V per l'alimentazione dei moduli non separati galvanicamente.
  - ④ Jumper su coppia di spine N° 5 (da sinistra)
  - ⑤ Ponte di codifica: sempre aperto.
- 

## Codificación / Conexión de cables

- Ⓐ Acoplamiento del bus de I/Q de bit
  - Ⓑ Acoplamiento del bus paralelo
- ① Unidad base (parte posterior)
  - ② Rack de extensión (parte posterior)
  - ③ Al usar tarjetas con potencial (p. e. EBE 200, EBE 250): puente 0V a la alimentación de la tarjeta con potencial.
  - ④ Puente en pins N° 5 (desde la izquierda)
  - ⑤ Codificación: siempre abierto
-

## Stromversorgungen

Eine Kombination der Typen EBE241.1 und EBE243.1 in einem Aufbau ist unzulässig. EBE 240.1 nur für Einzelgeräte verwenden.

### Kodierung der EBE 241.1 / EBE 243.1

- ① Überwachungsfunktionen (BUS aktiv und LOOP)

---

## Power supplies

A combination of types EBE 241.1 and EBE 243.1 is not permissible. Use type EBE 240.1 only for basic units without expander racks.

### Coding of EBE 241.1 / EBE 243.1

- ① Monitoring functions (BUS ACTIVE with LOOP)

---

## Alimentations

L'utilisation simultanée des EBE 241.1 et EBE 243.1 est interdite. Utiliser EBE 240.1 seulement pour appareils de base sans appareils d'extension.

### Codage de l'EBE 241.1 / EBE 243.1

- ① Fonctions de surveillance (BUS ACTIVE et LOOP)

---

## Alimentazione

Non è possibile la combinazione dei moduli EBE 241.1 e EBE 243.1 nella stessa configurazione. Utilizzare il tipo EBE 240.1 solo per rack base senza rack espansione.

### Codifica dell'EBE 241.1 / EBE 243.1

- ① Funzioni di controllo (BUS ATTIVO e LOOP)

---

## Fuentes de alimentación

Una combinación de las tarjetas EBE 241.1 y EBE 243.1 en el mismo sistema no está permitido. La tarjeta EBE 240.1 debe utilizarse solo en unidades base (sin racks de extensión).

### Codificación de la EBE 241.1 / EBE 243.1

- ① Función de supervisión (BUS ACTIVO y LOOP)



EBE 241.1/  
EBE 243.1

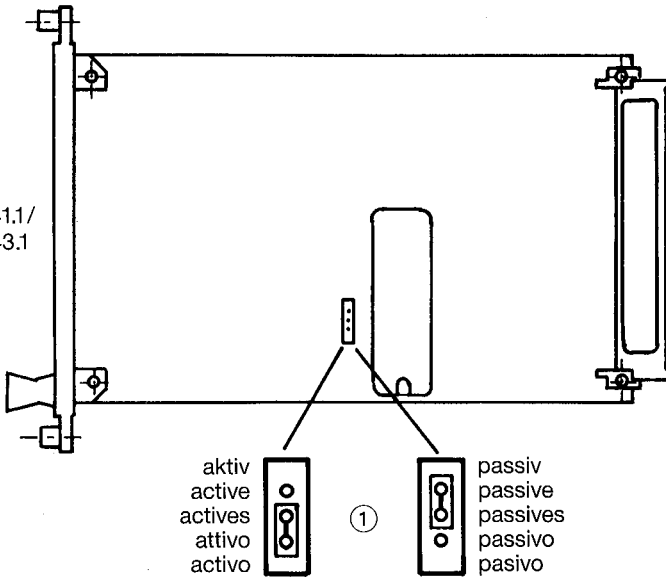

**Achtung!**

Bei Parallelbusbetrieb ist nur die Kodierung „aktiv“ erlaubt!

**Caution!**

Only “active” coding permissible with parallel bus operation.

**Attention!**

En cas de fonctionnement avec bus parallèle, seul le codage «actives» est admis.

**Attenzione!**

In caso di funzionamento con bus parallelo è ammessa soltanto una codifica “attiva”.

**¡Atención!**

En caso de funcionamiento con el bus paralelo, sólo se permite la codificación “activo”.

# Maßtabellen / Dimensions / Encombres / Dimensioni / Dimensiones

PS 316. x 18

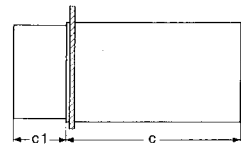
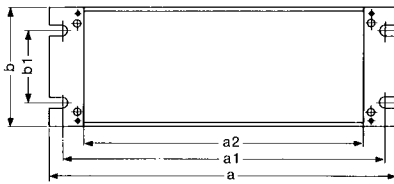

PS 316. x 18

PS 316. x 08  
PS 316. x 12

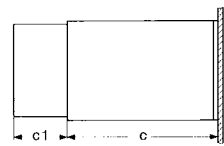
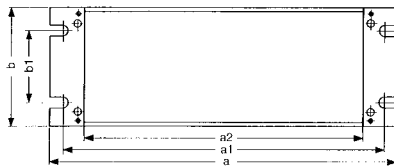

PS 316. x 08/ . x 12

VEH 1

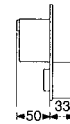
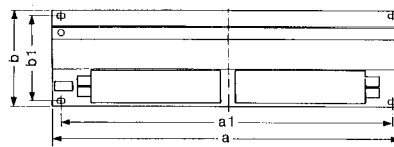

V248

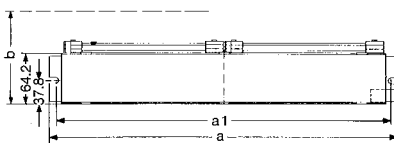

ES-PS

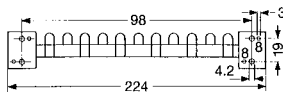

Typ/Type/Référence

| Tipo/Tipo    | a   | a1  | a2  | b     | b1    | c   | c1 |
|--------------|-----|-----|-----|-------|-------|-----|----|
| PS 316. x 08 | 288 | 275 | 255 | 132,5 | 100   | 205 | —  |
| dito +SAM    |     |     |     |       |       |     | 50 |
| dito +SEM    |     |     |     |       |       |     | 68 |
| dito +S2...  |     |     |     |       |       |     | 70 |
| PS 316. x 12 | 362 | 350 | 336 | 132,5 | 100   | 205 | —  |
| dito +SAM    |     |     |     |       |       |     | 50 |
| dito +SEM    |     |     |     |       |       |     | 68 |
| dito +S2...  |     |     |     |       |       |     | 70 |
| PS 316. x 18 | 483 | 465 | 427 | 132,5 | 57    | 230 | —  |
| dito +SAM    |     |     |     |       |       |     | 50 |
| dito +SEM    |     |     |     |       |       |     | 68 |
| dito +S2...  |     |     |     |       |       |     | 70 |
| VEH 1        | 483 | 465 | —   | 132,5 | 120,5 | —   | —  |
| V248         | 483 | 465 | —   | 88    | —     | —   | —  |
| MBP 3        | 483 | 465 | —   | 132,5 | 120,5 | —   | —  |
| MBP 1        | 483 | 465 | —   | 43,6  | 31,7  | —   | —  |

|                     |   |                     |              |        |
|---------------------|---|---------------------|--------------|--------|
| <b>Codierung</b>    | Alle Baugruppen dürfen nur bei ausgeschalteter Versorgungsspannung ausgetauscht werden. | <b>Schalter</b>     | 0 = off/open | 1 = on |
| <b>Coding</b>       | Cards must be exchanged only while the supply voltage is disconnected.                  | <b>Switches</b>     |              |        |
| <b>Codage</b>       | Les modules doivent tous être remplacés hors tension.                                   | <b>Codeurs</b>      |              |        |
| <b>Codifica</b>     | Togliere tensione prima di inserire o rimuovere i moduli.                               | <b>Interruttori</b> |              |        |
| <b>Codificación</b> | Las tarjetas deben insertarse o extraerse sólo con la alimentación desconectada.        | <b>Codificador</b>  |              |        |

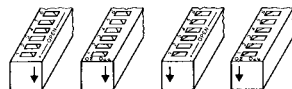

Baugruppentyp / Module Type / Type de module /  
Tipi di moduli / Tipo de tarjeta

Schalternummer / Switch Number / No. de microrrupteur /  
N° interruttore / N° de codificador

| A          |            | B  |                                      | C  |   | S8   |  | D       |   |   |   |   |   |   |   |   |
|------------|------------|--|--------------------------------------|--|---|--|--|---------|---|---|---|---|---|---|---|---|
| EBE 261    |            | EBE 200<br>EBE 201<br>EBE 205<br>EBE 206.1<br>EBE 206.2<br>EBE 213.1<br>EBE 250 A<br>EBE 252<br>EBE 258<br>EBE 266.1 |                                      | EBE 202.1<br>EBE 211 (F)<br>EBE 254.1<br>EBE 255<br>EBE 256<br>EBE 260<br>EBE 265<br>EBE 267.1 |   | on/off<br>on/off<br>on/off<br>-<br>-<br>off<br>off<br>on/off   |  | EBE 253 |   |   |   |   |   |   |   |   |
|            |            |  |                                      |  |   |  |  | 1       | 2 | 3 | 4 | 5 | 6 | 7 | 8 |   |
| 0.0...1.15 | 0.0...0.15 | 0.0...0.7  | 0.0...0.3<br>0.4...0.7<br>0.8...0.15 | 0.0...0.7<br>1.0...1.15  | 0.0...0.7<br>1.0...1.7<br>1.8...1.15<br>1.12...1.15               | 0.0...0.3<br>0.4...0.7<br>0.8...0.11<br>0.12...0.15<br>1.0...1.3<br>1.4...1.7<br>1.8...1.11<br>1.12...1.15 | on/off<br>on/off<br>on/off<br>-<br>-<br>off<br>off<br>on/off | 1       | 1 | 1 | 1 | 1 | 1 | 1 | 1 |   |
| 2.0...3.15 | 2.0...2.15 | 2.0...2.7  | 2.0...2.3<br>2.4...2.7               | 2.0...2.15   | 2.0...2.7<br>2.8...2.15<br>3.0...3.7<br>3.8...3.15<br>3.12...3.15 | 2.0...2.3<br>2.4...2.7<br>2.8...2.11<br>2.12...2.15<br>3.0...3.3<br>3.4...3.7<br>3.8...3.11<br>3.12...3.15 | on/off<br>on/off<br>on/off<br>-<br>-<br>off<br>off<br>on/off | 1       | 1 | 1 | 0 | 1 | 1 | 1 | 1 | 1 |
| 4.0...5.15 | 4.0...4.15 | 4.0...4.7  | 4.0...4.3<br>4.4...4.7               | 4.0...4.15   | 4.0...4.7<br>4.8...4.15<br>5.0...5.7<br>5.8...5.15<br>5.12...5.15 | 4.0...4.3<br>4.4...4.7<br>4.8...4.11<br>4.12...4.15<br>5.0...5.3<br>5.4...5.7<br>5.8...5.11<br>5.12...5.15 | on/off<br>on/off<br>on/off<br>-<br>-<br>off<br>off<br>on/off | 1       | 1 | 1 | 1 | 0 | 1 | 1 | 1 | 1 |
| 6.0...7.15 | 6.0...6.15 | 6.0...6.7  | 6.0...6.3<br>6.4...6.7               | 6.0...6.15   | 6.0...6.7<br>6.8...6.15<br>7.0...7.7<br>7.8...7.15<br>7.12...7.15 | 6.0...6.3<br>6.4...6.7<br>6.8...6.11<br>6.12...6.15<br>7.0...7.3<br>7.4...7.7<br>7.8...7.11<br>7.12...7.15 | on/off<br>on/off<br>on/off<br>-<br>-<br>off<br>off<br>on/off | 1       | 1 | 1 | 0 | 0 | 1 | 1 | 1 | 1 |
| 8.0...9.15 | 8.0...8.15 | 8.0...8.7  | 8.0...8.3<br>8.4...8.7               | 8.0...8.15   | 8.0...8.7<br>8.8...8.15<br>9.0...9.7<br>9.8...9.15                | 8.0...8.3<br>8.4...8.7<br>8.8...8.11<br>8.12...8.15<br>9.0...9.3<br>9.4...9.7<br>9.8...9.11<br>9.12...9.15 | on/off<br>on/off<br>on/off<br>-<br>-<br>off<br>off<br>on/off | 1       | 1 | 1 | 1 | 1 | 0 | 1 | 1 | 1 |

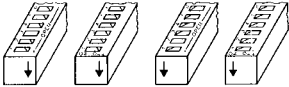

|   |   |
|---|---|
| <p><b>Codierung</b> Alle Baugruppen dürfen nur bei ausgeschalteter Versorgungsspannung ausgetauscht werden.</p> <p><b>Coding</b> Cards must be exchanged only while the supply voltage is disconnected.</p> <p><b>Codage</b> Les modules doivent tous être remplacés hors tension.</p> <p><b>Codifica</b> Togliere tensione prima di inserire o rimuovere i moduli.</p> <p><b>Codificación</b> Las tarjetas deben insertarse o extraerse sólo con la alimentación desconectada.</p> | <p><b>Schalter</b> 0 = off/open      1 = on</p> <p><b>Switches</b></p> <p><b>Codeurs</b></p> <p><b>Interruttori</b></p> <p><b>Codificador</b></p>  |
|---|---|

Baugruppentyp / Module Type / Type de module / Tipi di moduli / Tipo de tarjeta Schalternummer / Switch Number / No. de microrrupteur / N° interruttore / N° de codificador

| A            | B            | C             | D             |   |   |   |   |   |   |   |   |   |
|--------------|--------------|---------------|---------------|---|---|---|---|---|---|---|---|---|
|              |              |               | 1             |   | 2 |   | 3 |   | 4 |   |   |   |
|              |              |               | 1             | 2 | 3 | 4 | 5 | 6 | 7 | 8 |   |   |
|              |              |               | 1             | 2 | 3 | 4 | 5 | 6 | 7 | 8 |   |   |
| 24.0...25.15 | 24.0...24.15 | 24.0...24.7   | 24.0...24.3   | 1 | 1 | 1 | 1 | 1 | 0 | 0 | 0 | 1 |
|              |              |               | 24.4...24.7   | 0 | 1 | 1 | 1 | 1 | 0 | 0 | 0 | 1 |
|              |              |               | 24.8...24.15  | 1 | 0 | 1 | 1 | 1 | 0 | 0 | 0 | 1 |
|              | 25.0...25.15 | 25.0...25.7   | 24.12...24.15 | 0 | 0 | 1 | 1 | 1 | 0 | 0 | 0 | 1 |
|              |              |               | 25.0...25.3   | 1 | 1 | 0 | 1 | 1 | 0 | 0 | 0 | 1 |
|              |              |               | 25.4...25.7   | 0 | 1 | 0 | 1 | 1 | 0 | 0 | 0 | 1 |
| 26.0...27.15 | 26.0...26.15 | 26.0...26.7   | 25.8...25.15  | 1 | 0 | 0 | 1 | 1 | 0 | 0 | 0 | 1 |
|              |              |               | 26.0...26.3   | 1 | 1 | 1 | 0 | 1 | 0 | 0 | 0 | 1 |
|              |              |               | 26.4...26.7   | 0 | 1 | 1 | 0 | 1 | 0 | 0 | 0 | 1 |
|              | 27.0...27.15 | 26.8...26.15  | 26.8...26.11  | 1 | 0 | 1 | 0 | 1 | 0 | 0 | 0 | 1 |
|              |              |               | 26.12...26.15 | 0 | 0 | 1 | 0 | 1 | 0 | 0 | 0 | 1 |
|              |              |               | 27.0...27.7   | 1 | 1 | 0 | 0 | 1 | 0 | 0 | 0 | 1 |
| 28.0...29.15 | 28.0...28.15 | 27.0...27.7   | 27.4...27.7   | 0 | 1 | 0 | 0 | 1 | 0 | 0 | 0 | 1 |
|              |              |               | 27.8...27.11  | 1 | 0 | 0 | 0 | 1 | 0 | 0 | 0 | 1 |
|              |              |               | 27.12...27.15 | 0 | 0 | 0 | 0 | 1 | 0 | 0 | 0 | 1 |
|              | 29.0...29.15 | 28.8...28.15  | 28.0...28.7   | 1 | 1 | 1 | 1 | 0 | 0 | 0 | 0 | 1 |
|              |              |               | 28.4...28.7   | 0 | 1 | 1 | 1 | 0 | 0 | 0 | 0 | 1 |
|              |              |               | 28.8...28.11  | 1 | 0 | 1 | 1 | 0 | 0 | 0 | 0 | 1 |
| 30.0...31.15 | 30.0...30.15 | 28.12...28.15 | 29.0...29.3   | 0 | 0 | 1 | 1 | 0 | 0 | 0 | 0 | 1 |
|              |              |               | 29.4...29.7   | 1 | 1 | 0 | 1 | 0 | 0 | 0 | 0 | 1 |
|              |              |               | 29.8...29.11  | 0 | 1 | 0 | 1 | 0 | 0 | 0 | 0 | 1 |
|              | 31.0...31.15 | 29.0...29.7   | 29.12...29.15 | 0 | 0 | 0 | 1 | 0 | 0 | 0 | 0 | 1 |
|              |              |               | 30.0...30.7   | 1 | 1 | 1 | 0 | 0 | 0 | 0 | 0 | 1 |
|              |              |               | 30.4...30.7   | 0 | 1 | 1 | 0 | 0 | 0 | 0 | 0 | 1 |
| 32.0...33.15 | 30.0...30.15 | 30.8...30.15  | 30.8...30.11  | 1 | 0 | 1 | 0 | 0 | 0 | 0 | 0 | 1 |
|              |              |               | 30.12...30.15 | 0 | 0 | 1 | 0 | 0 | 0 | 0 | 0 | 1 |
|              |              |               | 31.0...31.3   | 1 | 1 | 0 | 0 | 0 | 0 | 0 | 0 | 1 |
|              | 32.0...32.15 | 31.0...31.7   | 31.4...31.7   | 0 | 1 | 0 | 0 | 0 | 0 | 0 | 0 | 1 |
|              |              |               | 31.8...31.11  | 1 | 0 | 0 | 0 | 0 | 0 | 0 | 0 | 1 |
|              |              |               | 31.12...31.15 | 0 | 0 | 0 | 0 | 0 | 0 | 0 | 0 | 1 |
| 33.0...33.15 | 32.0...32.15 | 32.0...32.7   | 32.0...32.3   | 1 | 1 | 1 | 1 | 1 | 1 | 1 | 0 |   |
|              |              |               | 32.4...32.7   | 0 | 1 | 1 | 1 | 1 | 1 | 1 | 0 |   |
|              |              |               | 32.8...32.15  | 1 | 0 | 1 | 1 | 1 | 1 | 1 | 0 |   |
|              | 33.0...33.15 | 32.8...32.15  | 32.12...32.15 | 0 | 0 | 1 | 1 | 1 | 1 | 1 | 0 |   |
|              |              |               | 33.0...33.3   | 1 | 1 | 0 | 1 | 1 | 1 | 1 | 0 |   |
|              |              |               | 33.4...33.7   | 0 | 1 | 0 | 1 | 1 | 1 | 1 | 0 |   |
| 34.0...35.15 | 33.0...33.15 | 33.8...33.15  | 33.8...33.11  | 1 | 0 | 0 | 1 | 1 | 1 | 1 | 0 |   |
|              |              |               | 33.12...33.15 | 0 | 0 | 0 | 1 | 1 | 1 | 1 | 0 |   |
|              |              |               | 34.0...34.7   | 1 | 1 | 1 | 0 | 1 | 1 | 1 | 0 |   |
|              | 35.0...35.15 | 34.0...34.15  | 34.4...34.7   | 0 | 1 | 1 | 0 | 1 | 1 | 1 | 0 |   |
|              |              |               | 34.8...34.11  | 1 | 0 | 1 | 0 | 1 | 1 | 1 | 0 |   |
|              |              |               | 34.12...34.15 | 0 | 0 | 1 | 0 | 1 | 1 | 1 | 0 |   |
| 36.0...37.15 | 35.0...35.15 | 35.0...35.7   | 35.0...35.3   | 1 | 1 | 0 | 0 | 1 | 1 | 1 | 0 |   |
|              |              |               | 35.4...35.7   | 0 | 1 | 0 | 0 | 1 | 1 | 1 | 0 |   |
|              |              |               | 35.8...35.11  | 1 | 0 | 0 | 0 | 1 | 1 | 1 | 0 |   |
|              | 36.0...36.15 | 35.8...35.15  | 35.12...35.15 | 0 | 0 | 0 | 0 | 1 | 1 | 1 | 0 |   |
|              |              |               | 36.0...36.7   | 1 | 1 | 1 | 0 | 1 | 1 | 1 | 0 |   |
|              |              |               | 36.4...36.7   | 0 | 1 | 1 | 0 | 1 | 1 | 1 | 0 |   |
| 37.0...37.15 | 36.0...36.15 | 36.8...36.15  | 36.8...36.11  | 1 | 0 | 1 | 1 | 0 | 1 | 1 | 0 |   |
|              |              |               | 36.12...36.15 | 0 | 0 | 1 | 1 | 0 | 1 | 1 | 0 |   |
|              |              |               | 37.0...37.7   | 1 | 1 | 0 | 1 | 0 | 1 | 1 | 0 |   |
|              | 37.0...37.15 | 37.0...37.7   | 37.4...37.7   | 0 | 1 | 0 | 1 | 0 | 1 | 1 | 0 |   |
|              |              |               | 37.8...37.11  | 1 | 0 | 0 | 1 | 0 | 1 | 1 | 0 |   |
|              |              |               | 37.12...37.15 | 0 | 0 | 0 | 1 | 0 | 1 | 1 | 0 |   |

**Codierung** Alle Baugruppen dürfen nur bei ausgeschalteter Versorgungsspannung ausgetauscht werden.

**Coding** Cards must be exchanged only while the supply voltage is disconnected.

**Codage** Les modules doivent tous être remplacés hors tension.

**Codifica** Togliere tensione prima di inserire o rimuovere i moduli.

**Codificación** Las tarjetas deben insertarse o extraerse sólo con la alimentación desconectada.

**Schalter** 0 = off/open 1 = on

**Switches**

**Codeurs**

**Interruttori**

**Codificador**

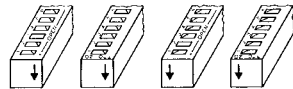

**Baugruppentyp / Module Type / Type de module /  
Tipi di moduli / Tipo de tarjeta**

**Schalternummer / Switch Number / No. de microrupteur /  
N° interruttore / N° de codificador**

| A            | B            | C            |             |   |   |   |   |   |   |   |   |   |   |   |
|--------------|--------------|--------------|-------------|---|---|---|---|---|---|---|---|---|---|---|
|              |              |              |             |   |   |   |   |   |   |   |   |   |   |   |
|              |              |              |             |   |   |   | 1 | 2 | 3 | 4 | 5 | 6 | 7 | 8 |
|              |              |              |             |   | 1 | 2 | 3 | 4 | 5 | 6 | 7 | 8 |   |   |
| 38.0...39.15 | 38.0...38.15 | 38.0...38.7  | 38.0...38.3 | 1 | 1 | 1 | 0 | 0 | 1 | 1 | 1 | 0 |   |   |
|              |              |              | 38.4...38.7 | 0 | 1 | 1 | 0 | 0 | 1 | 1 | 1 | 0 |   |   |
|              |              | 38.8...38.15 | 1           | 0 | 1 | 0 | 0 | 1 | 1 | 1 | 0 |   |   |   |
|              | 39.0...39.15 | 39.0...39.7  | 39.0...39.3 | 1 | 1 | 0 | 0 | 0 | 1 | 1 | 0 |   |   |   |
|              |              |              | 39.4...39.7 | 0 | 1 | 0 | 0 | 0 | 1 | 1 | 0 |   |   |   |
|              |              | 39.8...39.15 | 1           | 0 | 0 | 0 | 0 | 1 | 1 | 0 |   |   |   |   |
| 40.0...41.15 | 40.0...40.15 | 40.0...40.7  | 40.0...40.3 | 1 | 1 | 1 | 1 | 1 | 0 | 1 | 0 |   |   |   |
|              |              |              | 40.4...40.7 | 0 | 1 | 1 | 1 | 1 | 0 | 1 | 0 |   |   |   |
|              |              | 40.8...40.15 | 1           | 0 | 1 | 1 | 1 | 0 | 1 | 0 |   |   |   |   |
|              | 41.0...41.15 | 41.0...41.7  | 41.0...41.3 | 1 | 1 | 0 | 1 | 1 | 0 | 1 | 0 |   |   |   |
|              |              |              | 41.4...41.7 | 0 | 1 | 0 | 1 | 1 | 0 | 1 | 0 |   |   |   |
|              |              | 41.8...41.15 | 1           | 0 | 0 | 1 | 1 | 0 | 1 | 0 |   |   |   |   |
| 42.0...43.15 | 42.0...42.15 | 42.0...42.7  | 42.0...42.3 | 1 | 1 | 1 | 0 | 1 | 0 | 1 | 0 |   |   |   |
|              |              |              | 42.4...42.7 | 0 | 1 | 1 | 0 | 1 | 0 | 1 | 0 |   |   |   |
|              |              | 42.8...42.15 | 1           | 0 | 1 | 0 | 1 | 0 | 1 | 0 |   |   |   |   |
|              | 43.0...43.15 | 43.0...43.7  | 43.0...43.3 | 1 | 1 | 0 | 0 | 1 | 0 | 1 | 0 |   |   |   |
|              |              |              | 43.4...43.7 | 0 | 1 | 0 | 0 | 1 | 0 | 1 | 0 |   |   |   |
|              |              | 43.8...43.15 | 1           | 0 | 0 | 0 | 1 | 0 | 1 | 0 |   |   |   |   |
| 44.0...45.15 | 44.0...44.15 | 44.0...44.7  | 44.0...44.3 | 1 | 1 | 1 | 1 | 0 | 0 | 1 | 0 |   |   |   |
|              |              |              | 44.4...44.7 | 0 | 1 | 1 | 1 | 0 | 0 | 1 | 0 |   |   |   |
|              |              | 44.8...44.15 | 1           | 0 | 1 | 1 | 0 | 0 | 1 | 0 |   |   |   |   |
|              | 45.0...45.15 | 45.0...45.7  | 45.0...45.3 | 1 | 1 | 0 | 1 | 0 | 0 | 1 | 0 |   |   |   |
|              |              |              | 45.4...45.7 | 0 | 1 | 0 | 1 | 0 | 0 | 1 | 0 |   |   |   |
|              |              | 45.8...45.15 | 1           | 0 | 0 | 1 | 0 | 0 | 1 | 0 |   |   |   |   |
| 46.0...47.15 | 46.0...46.15 | 46.0...46.7  | 46.0...46.3 | 1 | 1 | 1 | 0 | 0 | 0 | 1 | 0 |   |   |   |
|              |              |              | 46.4...46.7 | 0 | 1 | 1 | 0 | 0 | 0 | 1 | 0 |   |   |   |
|              |              | 46.8...46.15 | 1           | 0 | 1 | 0 | 0 | 0 | 1 | 0 |   |   |   |   |
|              | 47.0...47.15 | 47.0...47.7  | 47.0...47.3 | 1 | 1 | 0 | 0 | 0 | 0 | 1 | 0 |   |   |   |
|              |              |              | 47.4...47.7 | 0 | 1 | 0 | 0 | 0 | 0 | 1 | 0 |   |   |   |
|              |              | 47.8...47.15 | 1           | 0 | 0 | 0 | 0 | 0 | 1 | 0 |   |   |   |   |
| 48.0...49.15 | 48.0...48.15 | 48.0...48.7  | 48.0...48.3 | 1 | 1 | 1 | 1 | 1 | 1 | 0 | 0 |   |   |   |
|              |              |              | 48.4...48.7 | 0 | 1 | 1 | 1 | 1 | 1 | 0 | 0 |   |   |   |
|              |              | 48.8...48.15 | 1           | 0 | 1 | 1 | 1 | 1 | 0 | 0 |   |   |   |   |
|              | 49.0...49.15 | 49.0...49.7  | 49.0...49.3 | 0 | 0 | 1 | 1 | 1 | 1 | 0 | 0 |   |   |   |
|              |              |              | 49.4...49.7 | 1 | 1 | 0 | 1 | 1 | 1 | 0 | 0 |   |   |   |
|              |              | 49.8...49.15 | 1           | 0 | 0 | 1 | 1 | 1 | 0 | 0 |   |   |   |   |
| 50.0...51.15 | 50.0...50.15 | 50.0...50.7  | 50.0...50.3 | 1 | 1 | 1 | 0 | 1 | 1 | 0 | 0 |   |   |   |
|              |              |              | 50.4...50.7 | 0 | 1 | 1 | 0 | 1 | 1 | 0 | 0 |   |   |   |
|              |              | 50.8...50.15 | 1           | 0 | 1 | 0 | 1 | 1 | 0 | 0 |   |   |   |   |
|              | 51.0...51.15 | 51.0...51.7  | 51.0...51.3 | 0 | 0 | 1 | 0 | 1 | 1 | 0 | 0 |   |   |   |
|              |              |              | 51.4...51.7 | 1 | 1 | 0 | 0 | 1 | 1 | 0 | 0 |   |   |   |
|              |              | 51.8...51.15 | 1           | 0 | 0 | 0 | 1 | 1 | 0 | 0 |   |   |   |   |

|                     |   |                     |              |        |
|---------------------|---|---------------------|--------------|--------|
| <b>Codierung</b>    | Alle Baugruppen dürfen nur bei ausgeschalteter Versorgungsspannung ausgetauscht werden. | <b>Schalter</b>     | 0 = off/open | 1 = on |
| <b>Coding</b>       | Cards must be exchanged only while the supply voltage is disconnected.                  | <b>Switches</b>     |              |        |
| <b>Codage</b>       | Les modules doivent tous être remplacés hors tension.                                   | <b>Codeurs</b>      |              |        |
| <b>Codifica</b>     | Togliere tensione prima di inserire o rimuovere i moduli.                               | <b>Interruttori</b> |              |        |
| <b>Codificación</b> | Las tarjetas deben insertarse o extraerse sólo con la alimentación desconectada.        | <b>Codificador</b>  |              |        |

**Baugruppentyp / Module Type / Type de module /  
Tipi di moduli / Tipo de tarjeta**

**Schalternummer / Switch Number / No. de microrupteur /  
N° interruttore / N° de codificador**

| A            | B            | C            | D             |              |   |   |   |   |   |   |   |   |   |
|--------------|--------------|--------------|---------------|--------------|---|---|---|---|---|---|---|---|---|
|              |              |              | 1             |              |   | 2 |   |   |   |   |   |   |   |
|              |              |              | 1             | 2            | 3 | 4 | 5 | 6 | 7 | 8 |   |   |   |
|              |              |              | 1             | 2            | 3 | 4 | 5 | 6 | 7 | 8 |   |   |   |
| 52.0...53.15 | 52.0...52.15 | 52.0...52.7  | 52.0...52.3   | 1            | 1 | 1 | 1 | 0 | 1 | 0 | 0 | 0 |   |
|              |              |              | 52.4...52.7   | 0            | 1 | 1 | 1 | 0 | 1 | 0 | 0 | 0 |   |
|              |              |              | 52.8...52.15  | 1            | 0 | 1 | 1 | 0 | 1 | 0 | 0 | 0 |   |
|              | 53.0...53.15 | 53.0...53.7  | 53.0...53.3   | 53.0...53.3  | 1 | 1 | 0 | 1 | 0 | 1 | 0 | 0 | 0 |
|              |              |              |               | 53.4...53.7  | 0 | 1 | 0 | 1 | 0 | 1 | 0 | 0 | 0 |
|              |              |              |               | 53.8...53.15 | 1 | 0 | 0 | 1 | 0 | 1 | 0 | 0 | 0 |
| 54.0...55.15 | 54.0...54.15 | 54.0...54.7  | 54.0...54.3   | 1            | 1 | 1 | 0 | 0 | 1 | 0 | 0 | 0 |   |
|              |              |              | 54.4...54.7   | 0            | 1 | 1 | 0 | 0 | 1 | 0 | 0 | 0 |   |
|              |              |              | 54.8...54.15  | 1            | 0 | 1 | 0 | 0 | 1 | 0 | 0 | 0 |   |
|              | 55.0...55.15 | 55.0...55.7  | 55.0...55.3   | 55.0...55.3  | 1 | 1 | 0 | 0 | 0 | 1 | 0 | 0 | 0 |
|              |              |              |               | 55.4...55.7  | 0 | 1 | 0 | 0 | 0 | 1 | 0 | 0 | 0 |
|              |              |              |               | 55.8...55.15 | 1 | 0 | 0 | 0 | 0 | 1 | 0 | 0 | 0 |
| 56.0...57.15 | 56.0...56.15 | 56.0...56.7  | 56.0...56.3   | 1            | 1 | 1 | 1 | 1 | 0 | 0 | 0 | 0 |   |
|              |              |              | 56.4...56.7   | 0            | 1 | 1 | 1 | 1 | 0 | 0 | 0 | 0 |   |
|              |              |              | 56.8...56.15  | 1            | 0 | 1 | 1 | 1 | 0 | 0 | 0 | 0 |   |
|              | 57.0...57.15 | 57.0...57.7  | 57.0...57.3   | 57.0...57.3  | 1 | 1 | 0 | 1 | 1 | 0 | 0 | 0 | 0 |
|              |              |              |               | 57.4...57.7  | 0 | 1 | 0 | 1 | 1 | 0 | 0 | 0 | 0 |
|              |              |              |               | 57.8...57.15 | 1 | 0 | 0 | 1 | 1 | 0 | 0 | 0 | 0 |
| 58.0...59.15 | 58.0...58.15 | 58.0...58.7  | 58.0...58.3   | 1            | 1 | 1 | 0 | 1 | 0 | 0 | 0 | 0 |   |
|              |              |              | 58.4...58.7   | 0            | 1 | 1 | 0 | 1 | 0 | 0 | 0 | 0 |   |
|              |              |              | 58.8...58.15  | 1            | 0 | 1 | 0 | 1 | 0 | 0 | 0 | 0 |   |
|              | 59.0...59.15 | 59.0...59.7  | 59.0...59.3   | 59.0...59.3  | 1 | 1 | 0 | 0 | 1 | 0 | 0 | 0 | 0 |
|              |              |              |               | 59.4...59.7  | 0 | 1 | 0 | 0 | 1 | 0 | 0 | 0 | 0 |
|              |              |              |               | 59.8...59.15 | 1 | 0 | 0 | 0 | 1 | 0 | 0 | 0 | 0 |
| 60.0...61.15 | 60.0...60.15 | 60.0...60.7  | 60.0...60.3   | 1            | 1 | 1 | 1 | 0 | 0 | 0 | 0 | 0 |   |
|              |              |              | 60.4...60.7   | 0            | 1 | 1 | 1 | 0 | 0 | 0 | 0 | 0 |   |
|              |              |              | 60.8...60.15  | 1            | 0 | 1 | 1 | 0 | 0 | 0 | 0 | 0 |   |
|              | 61.0...61.15 | 61.0...61.7  | 61.0...61.3   | 61.0...61.3  | 1 | 1 | 0 | 1 | 0 | 0 | 0 | 0 | 0 |
|              |              |              |               | 61.4...61.7  | 0 | 1 | 0 | 1 | 0 | 0 | 0 | 0 | 0 |
|              |              |              |               | 61.8...61.15 | 1 | 0 | 0 | 1 | 0 | 0 | 0 | 0 | 0 |
| 62.0...63.15 | 62.0...62.15 | 62.0...62.7  | 62.0...62.3   | 1            | 1 | 1 | 0 | 0 | 0 | 0 | 0 | 0 |   |
|              |              |              | 62.4...62.7   | 0            | 1 | 1 | 0 | 0 | 0 | 0 | 0 | 0 |   |
|              |              |              | 62.8...62.15  | 1            | 0 | 1 | 0 | 0 | 0 | 0 | 0 | 0 |   |
|              | 63.0...63.15 | 63.0...63.7  | 63.0...63.3   | 63.0...63.3  | 1 | 1 | 0 | 0 | 0 | 0 | 0 | 0 | 0 |
|              |              |              |               | 63.4...63.7  | 0 | 1 | 0 | 0 | 0 | 0 | 0 | 0 | 0 |
|              |              |              |               | 63.8...63.15 | 1 | 0 | 0 | 0 | 0 | 0 | 0 | 0 | 0 |
| 63.8...63.15 | 63.8...63.15 | 63.8...63.15 | 63.8...63.15  | 1            | 0 | 0 | 0 | 0 | 0 | 0 | 0 | 0 |   |
|              |              |              | 63.12...63.15 | 0            | 0 | 0 | 0 | 0 | 0 | 0 | 0 | 0 |   |