

9097250 TOSHIBA (DISCRETE/OPTO)

90D 16307 DT-33-35

TOSHIBA SEMICONDUCTOR
TECHNICAL DATA

TOSHIBA GTR MODULE
MG20Q6EK1
SILICON NPN TRIPLE DIFFUSED TYPE

HIGH POWER SWITCHING APPLICATIONS.
MOTOR CONTROL APPLICATIONS.

- . The Collector is Isolated from Case.
- . 6 Darlingtons Transistors are Built-in to 1 Package.
- . With Built-in Free Wheeling Diode.
- . High DC Current Gain
: $h_{FE}=100(\text{Min.})(I_C=20A)$
- . Low Saturation Voltage
: $V_{CE}(\text{sat})=2.5V(\text{Max.})(I_C=20A)$

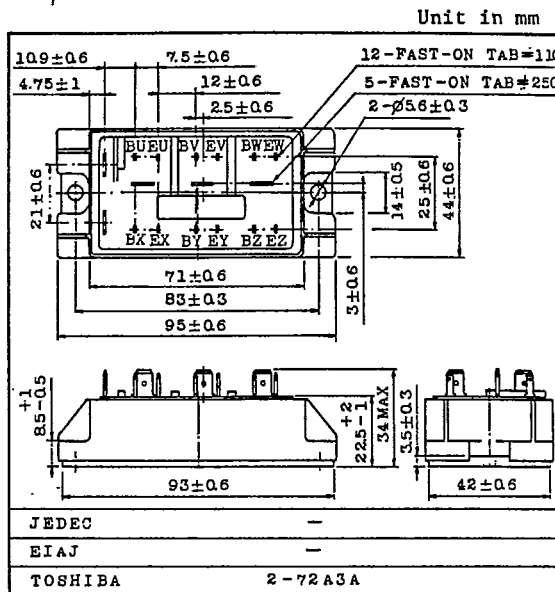

Weight : 225g

EQUIVALENT CIRCUIT

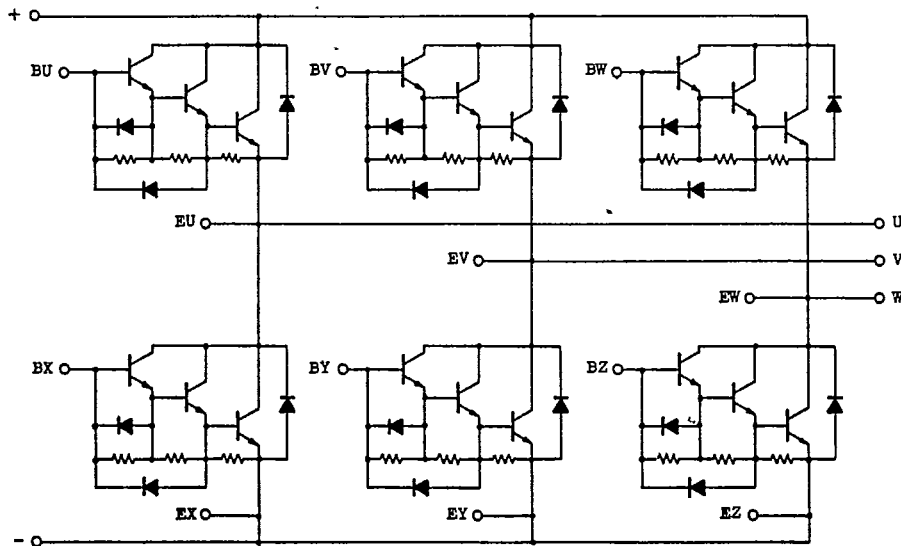

MG20Q6EK1-1
TOSHIBA CORPORATION

9097250 TOSHIBA (DISCRETE/OPTO)

90D 16308

DT-33-35

TOSHIBA SEMICONDUCTOR

TECHNICAL DATA

MG20Q6EK1

MAXIMUM RATINGS (Ta=25°C)

CHARACTERISTIC		SYMBOL	RATING	UNIT
Collector-Base Voltage		VCBO	1200	V
Collector-Emitter Sustaining Voltage		VCEX(SUS)	1200	V
		VCEO(SUS)	900	
Emitter-Base Voltage		VEBO	7	V
Collector Current	DC	IC	20	A
	1ms	ICP	40	
Forward Current	DC	IF	20	A
	1ms	IFM	40	
Base Current		IB	2.0	A
Collector Power Dissipation (Tc=25°C)		PC	200	W
Junction Temperature		Tj	150	°C
Storage Temperature Range		Tstg	-40~125	°C
Isolation Voltage		Visol	2500 (AC 1 Minute)	V
Screw Torque		-	30	kg·cm

ELECTRICAL CHARACTERISTICS (Ta=25°C)

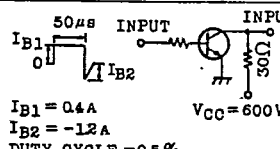
CHARACTERISTIC		SYMBOL	TEST CONDITION	MIN.	TYP.	MAX.	UNIT
Collector Cut-off Current		ICBO	VCB=1200V, IE=0	-	-	1.0	mA
Emitter Cut-off Current		IEBO	VEB=7V, IC=0	-	-	200	mA
Collector-Emitter Sustaining Voltage		VCEO(SUS)	IC=0.5A, L=40mH	900	-	-	V
DC Current Gain		hFE	VCE=5V, IC=20A	100	-	-	-
Collector-Emitter Saturation Voltage		VCE(sat)	IC=20A, IB=0.4A	-	2.1	2.5	V
Base-Emitter Saturation Voltage		VBE(sat)		-	2.8	3.5	V
Switching Time	Turn-on Time	ton	 <p>50µs INPUT IB1 IB2 INPUT 30pF 300Ω VCC=600V</p>	-	0.8	2.0	µs
	Storage Time	tstg		-	8	14	
	Fall Time	tf		-	4	6	
Forward Voltage		VF	IF=20A, IB=0	-	1.4	1.8	V
Reverse Recovery Time		trr	IF=20A, VBE=-3V di/dt=60A/µs	-	1.0	2.0	µs
Thermal Resistance		Rth(j-c)	Transistor	-	-	0.625	°C/W
			Diode	-	-	1.8	

MG20Q6EK1-2

TOSHIBA SEMICONDUCTOR
TECHNICAL DATA

MG20Q6EK1

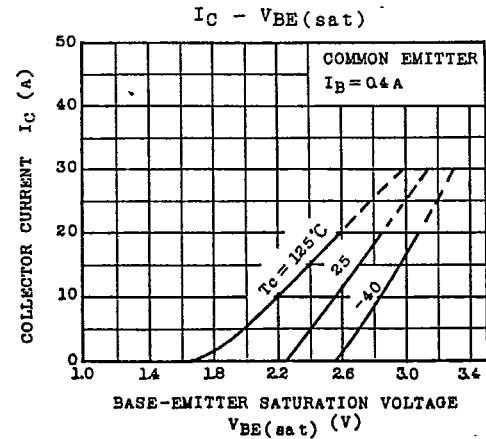
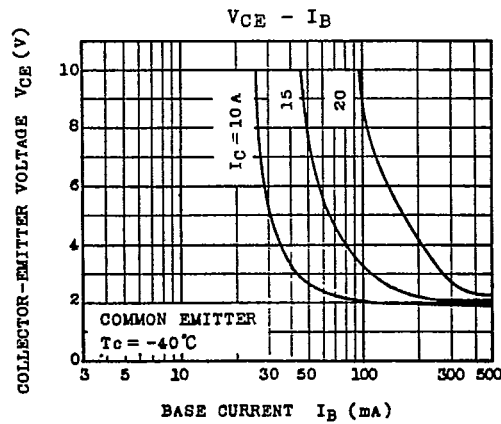
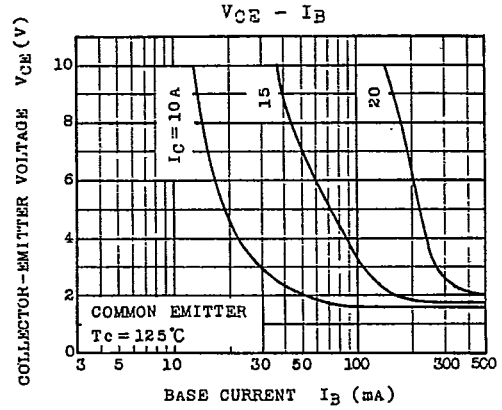
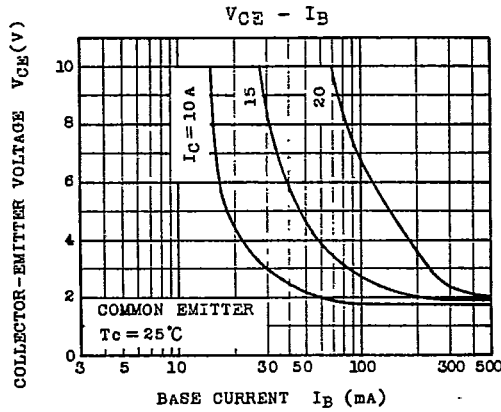
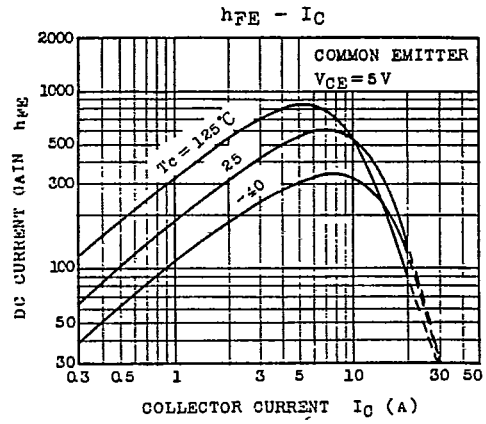
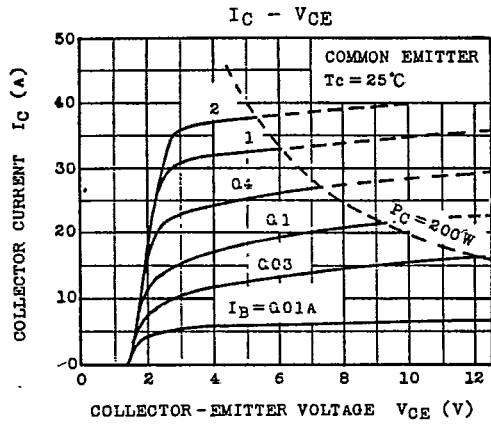

MG20Q6EK1-3
TOSHIBA CORPORATION

TOSHIBA SEMICONDUCTOR
TECHNICAL DATA

MG20Q6EK1

