

# L-force *Servo Motors*

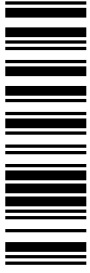

## Operating Instructions

## MC., MQA, MD...

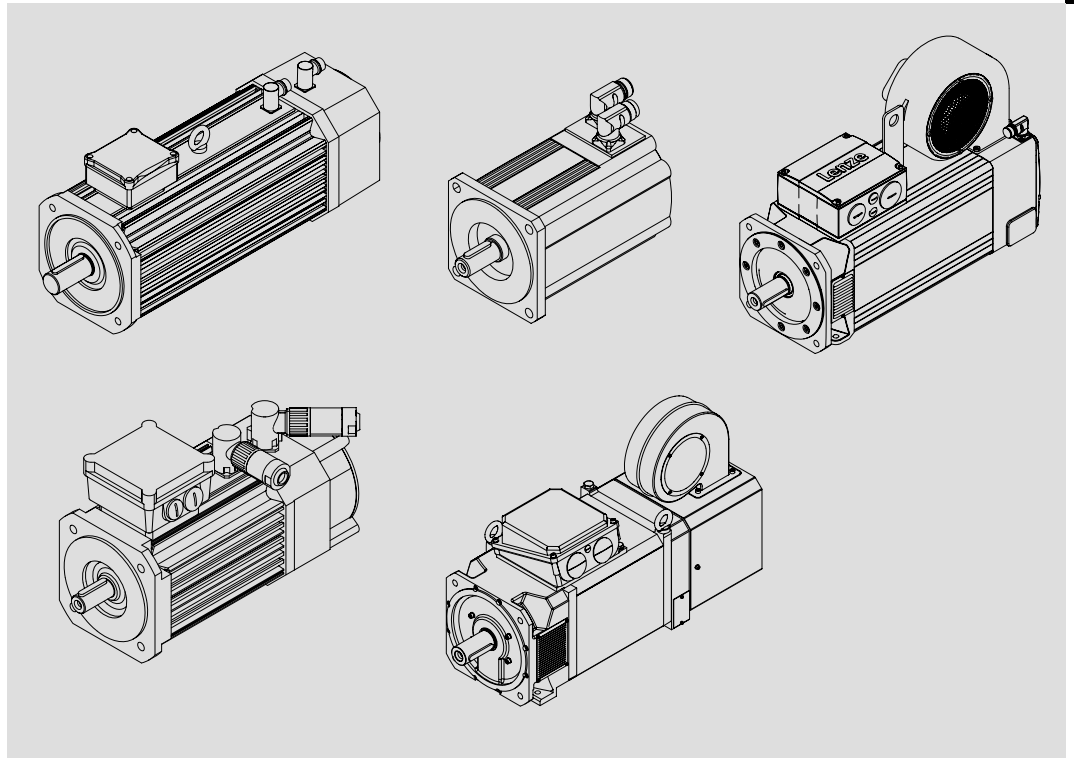

**MCA, MCS, MQA, MD□KS, MDFQA**

**Asynchronous servo motors, synchronous servo motors**



Please read these instructions before you start working!  
Follow the enclosed safety instructions.

<b>1</b>	<b>About this documentation</b> .....	<b>5</b>
1.1	Document history .....	5
1.2	Conventions used .....	6
1.3	Terminology used .....	6
1.4	Notes used .....	7
<b>2</b>	<b>Safety instructions</b> .....	<b>8</b>
2.1	General safety instructions for drive components .....	8
2.2	Application as directed .....	10
2.3	Improper use .....	11
2.4	Residual hazards .....	11
<b>3</b>	<b>Product description</b> .....	<b>13</b>
3.1	Identification .....	13
3.1.1	Nameplate .....	14
3.1.2	Product key .....	16
<b>4</b>	<b>Technical data</b> .....	<b>20</b>
4.1	General data and operating conditions .....	20
4.1.1	Setting the switching frequency to the rated motor data .....	21
<b>5</b>	<b>Mechanical installation</b> .....	<b>22</b>
5.1	Important notes .....	22
5.2	Preparation .....	22
5.3	Assembly of built-on accessories .....	23
5.3.1	Installation .....	23
5.4	Holding brake (option) .....	24
5.4.1	Permanent magnet holding brakes .....	25
5.4.2	Spring-applied holding brakes .....	27
<b>6</b>	<b>Electrical installation</b> .....	<b>29</b>
6.1	Important notes .....	29
6.2	Wiring according to EMC .....	30
6.3	Plug connectors .....	30
6.3.1	Power connections / holding brake .....	30
6.3.2	Holding brake .....	31
6.3.3	Fan .....	31
6.3.4	Feedback system .....	32

6.4	Terminal box .....	33
6.4.1	Power connections .....	35
6.4.2	AC holding brake with rectifier (option) .....	35
6.4.3	DC holding brake (optional) .....	35
6.4.4	Fan .....	36
6.4.5	Feedback system .....	37
<b>7</b>	<b>Commissioning and operation .....</b>	<b>38</b>
7.1	Important notes .....	38
7.2	Before switching on .....	38
7.3	Functional test .....	39
7.4	Functional test .....	39
7.5	During operation .....	39
<b>8</b>	<b>Maintenance/repair .....</b>	<b>40</b>
8.1	Important notes .....	40
8.2	Maintenance intervals .....	40
8.2.1	Holding brake .....	41
8.3	Maintenance operations .....	41
8.3.1	Blower .....	41
8.3.2	Fan with dust protection filter .....	42
8.3.3	Motors with bearing relubricating devices .....	42
8.3.4	Motor plug connection assignment .....	42
8.3.5	Power connection for plug-in connector at the cable end .....	43
8.3.6	Plug-in connector at the cable end .....	45
8.4	Repair .....	45
<b>9</b>	<b>Troubleshooting and fault elimination .....</b>	<b>46</b>

# 1 About this documentation

## Contents

- ▶ The present operating instructions are intended for safe working on and with the motors. They contain safety instructions that must be observed.
- ▶ All personnel working on and with the motors must have the operating instructions available during work and observe the information and notes relevant for them.
- ▶ The operating instructions must always be complete and in a perfectly readable state.

If the information and notes provided in this documentation do not meet your requirements, please refer to the controller and/or gearbox documentation.



### Tip!

Documentation and software updates for further Lenze products can be found on the Internet in the "Services & Downloads" area under <http://www.Lenze.com>

## Validity

This documentation is valid for servo motors:

Type	Designation
MCS	Synchronous servo motors
MCA	Asynchronous servo motors
MQA	
MDFQA	
MD□KS	Synchronous servo motors

## Target group

This documentation is directed at qualified skilled personnel according to IEC 60364.

Qualified skilled personnel are persons who have the required qualifications to carry out all activities involved in installing, mounting, commissioning, and operating the product.

## 1.1 Document history



Material no.	Version			Description
13314243	1.0	07/2009	TD09	First edition of the operating instructions, separate from three-phase AC motors
13342412	2.0	06/2010	TD09	Complete revision

# 1 About this documentation

## Conventions used

### 1.2 Conventions used

This documentation uses the following conventions to distinguish different types of information:

Type of information	Identification	Examples/notes
Spelling of numbers		
Decimal separator	Point	In general, the decimal point is used. For instance: 1234.56
Warnings		
UL warnings		Are only provided in English.
Icons		
Page reference		Reference to another page with additional information For instance:  16 = see page 16

### 1.3 Terminology used

Term	In the following text used for
Motor	Servo motor in the versions according to the product key, see page 16 to page 18 .
Controller	Any servo inverter Any frequency inverter
Drive system	Drive systems with servo motors and with other Lenze drive components

## 1.4 Notes used

The following pictographs and signal words are used in this documentation to indicate dangers and important information:

### Safety instructions

Structure of safety instructions:



#### Danger!

(characterises the type and severity of danger)

#### Note

(describes the danger and gives information about how to prevent dangerous situations)

Pictograph and signal word	Meaning
<b>Danger!</b>	<b>Danger of personal injury through dangerous electrical voltage.</b> Reference to an imminent danger that may result in death or serious personal injury if the corresponding measures are not taken.
<b>Danger!</b>	<b>Danger of personal injury through a general source of danger.</b> Reference to an imminent danger that may result in death or serious personal injury if the corresponding measures are not taken.
<b>Stop!</b>	<b>Danger of property damage.</b> Reference to a possible danger that may result in property damage if the corresponding measures are not taken.

### Application notes

Pictograph and signal word	Meaning
<b>Note!</b>	Important note to ensure troublefree operation
<b>Tip!</b>	Useful tip for simple handling
<b>Reference to another documentation</b>	Reference to another documentation

### Special safety instructions and application notes for UL and UR

Pictograph and signal word	Meaning
<b>Warnings!</b>	<b>Safety or application note for the operation of a UL-approved device in UL-approved systems.</b> Possibly the drive system is not operated in compliance with UL if the corresponding measures are not taken.
<b>Warnings!</b>	<b>Safety or application note for the operation of a UR-approved device in UL-approved systems.</b> Possibly the drive system is not operated in compliance with UL if the corresponding measures are not taken.

(in accordance with Low-Voltage Directive 2006/95/EC)

At the time of dispatch, the drive components are in line with the latest state of the art and can be regarded as operationally safe.

**Scope**

The following safety instructions generally apply to Lenze drive components.

**The product-specific safety and application notes given in this documentation must be observed!**

**General hazards****Danger!**

Disregarding the following basic safety measures may lead to severe personal injury and damage to material assets!

- ▶ Lenze drive components ...
  - ... must only be applied as directed.
  - ... must never be commissioned if visibly damaged.
  - ... must never be technically modified.
  - ... must never be commissioned if incompletely mounted.
  - ... must never be operated without the required covers.
- ▶ All specifications of the corresponding enclosed documentation must be observed. This is vital for a safe and trouble-free operation as well as for achieving the specified product features.
- ▶ Only qualified, skilled personnel is permitted to work on and with Lenze drive components.

According to IEC 60364 / CENELEC HD 384, these are persons who ...

  - ... are familiar with the installation, mounting, commissioning, and operation of the product.
  - ... have the qualifications required for their occupation.
  - ... know and are able to apply all national regulations for the preventions of accidents, directives and laws applicable on site.



### Transport, storage

- ▶ Transport and storage in a dry, low-vibration environment without aggressive atmosphere; preferably in the packaging provided by the manufacturer.
  - Protect against dust and shocks.
  - Comply with climatic conditions according to the technical data.
- ▶ Before transport
  - Check that all transport locking devices are mounted.
  - Tighten all transport aids.



#### Note!

Do not apply extra loads to the product as the transport aids (such as eye bolts or bearing plates) are designed for the weight of the motor only (refer to the catalogue for the weight).



#### Danger!

Completely screw in transport aids (such as eye bolts or bearing plates), they must be flat and applied over their entire surface!

If possible, the transport aids (such as eye bolts or bearing plates) must be stressed vertically in the direction of the screw axis! Angular tension or tension to the sides reduces the payload! Observe the information provided in the DIN 580!

Use additional appropriate lifting aids, if required, to achieve a direction of loading which is as vertical as possible (highest payload). Secure lifting aids against shifting!

If you do not install the motor immediately, ensure proper storage conditions.

- ▶ Up to one year:
  - Shafts and uncoated surfaces are delivered in a protected against rust status. Aftertreatment is required where the corrosion protection has been damaged.
  - Remove the plug for motors with condensation drain holes (special version).
- ▶ More than one year, up to two years:
  - Apply a long-term corrosion preventive (e.g. Anticorit BW 366 from the Fuchs company) to the shafts and uncoated surfaces before storing the motor away.



#### Stop!

**Observe load carrying capacity!**

**Staying under floating load is prohibited!**

### Mechanical installation

- ▶ Provide for a careful handling and avoid mechanical overload. During handling neither bend components, nor change the insulation distances.

**Electrical installation**

- ▶ Carry out the electrical installation according to the relevant regulations (e. g. cable cross-sections, fusing, connection to the PE conductor). Additional notes are included in the documentation.
- ▶ The documentation contains notes for the EMC-compliant installation (shielding, earthing, arrangement of filters and installation of the cables). The manufacturer of the system or machine is responsible for the compliance with the limit values required in connection with EMC legislation.
- ▶ Only plug in or remove pluggable terminals in the deenergised state!

**Commissioning**

- ▶ If required, you have to equip the system with additional monitoring and protective devices in accordance with the respective valid safety regulations (e. g. law on technical equipment, regulations for the prevention of accidents).
- ▶ Before commissioning remove transport locking devices and keep them for later transports.

**2.2****Application as directed**

Low-voltage machines are no household appliances, they are designed as components for industrial or professional use in terms of IEC/EN 61000-3-2 only.

They comply with the harmonised standards of the series IEC/EN 60034.

Low-voltage machines are components for installation into machines as defined in the Machinery Directive 2006/42/EC. Commissioning is prohibited until the conformity of the end product with this directive has been established (follow i. a. IEC/EN 60204-1).

It is only permissible to use low-voltage machines with IP23 protection or less outdoors if special protective measures are taken.

The integrated brakes must not be used as safety brakes. It cannot be ruled out that interference factors which cannot be influenced cause a brake torque reduction.

- ▶ Drives
  - ... must only be operated under the operating conditions and power limits specified in this documentation.
  - ... comply with the protection requirements of the EC Low-Voltage Directive.

**Any other use shall be deemed inappropriate!**

### **2.3 Improper use**

- ▶ Do not operate the motors
  - ... in explosion-protected areas
  - ... in aggressive environments (acid, gas, vapour, dust, oil)
  - ... in water
  - ... in radiation environments

### **2.4 Residual hazards**

#### **Protection of persons**

- ▶ The motor surfaces can become very hot. Danger of burns when touching!
  - Provide protection against accidental contact, if necessary.
- ▶ High-frequency voltages can be capacitively transferred to the motor housing through the inverter supply.
  - Carefully earth the motor housing.
- ▶ Danger of unintentional starting or electrical shocks
  - Connections must only be made when the equipment is deenergised and the motor is at standstill.
  - Built-in brakes are not fail-safe brakes.

**Motor protection**

- ▶ Integrated temperature sensors **do not provide full protection** for the machine.
  - Limit the maximum current if necessary. Select parameter settings for the controller which ensure a switch-off if operated at  $I > I_r$  after a couple of seconds, particularly if a danger of blocking exists.
  - The integrated overload protection function does not prevent overloading under all circumstances.
- ▶ Built-in brakes are **not fail-safe brakes** .
  - Torque reduction is possible through disruptive factors which cannot be influenced, e.g. through oil ingress due to a defective shaft sealing ring at the A end.
- ▶ Fuses do not protect the motor.
  - Use current-dependent motor protection switches for average operating frequency.
  - Use built-in thermal detectors at high operating frequency.
- ▶ Excessive torques lead to a break of the motor shaft or demagnetisation.
  - Do not exceed the maximum torques according to the catalogue.
- ▶ Lateral forces from the motor shaft are possible.
  - Perfectly align shafts of motor and driving machine to each other.
- ▶ If deviations from normal operation occur, e.g. increased temperature, noise, vibration, determine the cause and, if necessary, contact the manufacturer. If in doubt, switch off the motor.

**Fire protection**

- ▶ Fire hazard
  - Avoid contact with inflammable substances.

### 3 Product description

#### 3.1 Identification

##### Types MC., MQA

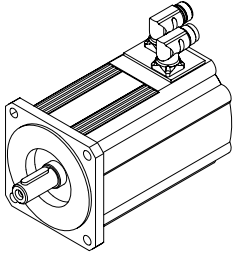
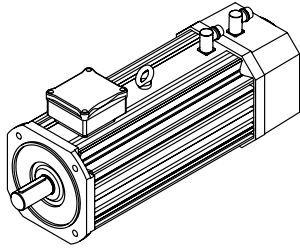
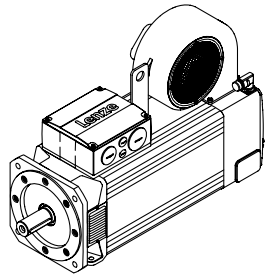
Synchronous servo motors	Asynchronous servo motors	
MCS	MCA	MQA
		
MT-MCS-001.iso	MT-MCA-001.iso	MT-MQA-001.iso

##### Type MD...

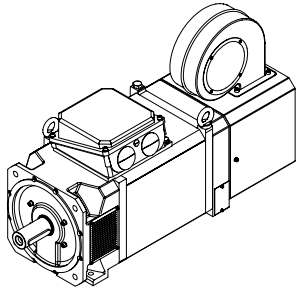
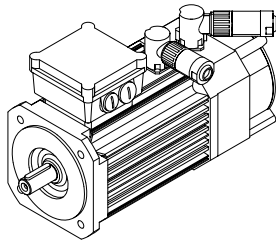
Asynchronous servo motors	Synchronous servo motors
MDFQA	MD□KS
	
MT-MDFQA-002.iso	MT-MDFKS-001.iso

# 3 Product description

## Identification

### Nameplate

#### 3.1.1 Nameplate

**Asynchronous and synchronous servo motors**

The diagram shows a rectangular nameplate with the following layout:

- Top left: **Lenze** logo (1)
- Top middle: Address: Hans-Lenze-Straße 1, 31855 Aerzen, GERMANY (3, 19, 20, 21)
- Top right: Made in Germany (22), UL E210321 (23), CE EN60034 (24, 25)
- Below the address: A grid of 5 columns and 4 rows of empty boxes for technical specifications (2, 4, 5, 6, 7, 8, 13, 10, 11, 12, 9)
- Far right: Two additional empty boxes (18, 17, 16)

Nameplate SYN-001.iso

**IP23 MDFQA asynchronous servo motors**









The diagram shows a nameplate with a table structure for technical specifications:





Lenze	Hans-Lenze-Straße 1 31855 Aerzen GERMANY	Made in Germany	Typ	[ ]	
			Hz	[ ]	[ ]
			kW	[ ]	[ ]
			r/min	[ ]	[ ]
			V	[ ]	[ ]
			A	[ ]	[ ]
			COSφ	[ ]	[ ]
			C86	[ ]	[ ]

Callouts 1-25 point to various fields and logos on the nameplate.

Nameplate-SYN-002.iso

No.	Explanation
1	Manufacturer
2	Motor type
3	Lenze motor type
4	Rated voltage $U_r$ [V]
5	Rated current $I_r$ [A]
6	Maximum current $I_{max}$ [A]
7	Labelling of encoder (example: IG2048 - 5V - T; explanation  19) / resolver correction value C 416
8	Data for holding brake: voltage, current, torque
9	Motor no.
10	Degree of protection
11	Thermal class
12	Rated ambient temperature
13	8-digit identification number + 16-digit serial number
14	General motor standard
15	Circuit of the winding
16	Temperature sensor
17	Selection number for operation on servo inverters (enter the provided selection number in C0086 to automatically optimise the control mode)
18	Rated speed $n_r$ [rpm]
19	Rated power $P_r$ [HP]
20	Rated power $P_r$ [kW]
21	Continuous standstill torque $M_0$ [Nm]
22	Rated torque $M_r$ [Nm]
23	Rated power factor $\cos \varphi$
24	Rated frequency $f_r$ [Hz]
25	Valid conformities and approvals

Example: MCA					Example: MCS				
 Hans-Lenze-Straße 1 31855 Aerzen GERMANY					 Hans-Lenze-Straße 1 31855 Aerzen GERMANY				
Made in Germany  					Made in Germany  				
3~MOT	Typ	MCA 21X25-RS0P1-A38R-ST5S00N-R0SU			3~MOT	Typ	MCS 14H32-SRMP1-B24N-ST6S00N-R0SU		
390 V~	6.4 kW	24.6 Nm	85 Hz	2490 r/min	295 V~	4.7 kW	14.0 Nm	215 Hz	3225 r/min
13.5 A	8.58 HP	$M_0$ 39 Nm	$\cos \varphi$ 0.83	C86: 1378	11.9 A	HP	$M_0$ 21.0 Nm	$U_{in}$ 246 V	C86: 1331
	IP 54	I. CL. F	$T_a$ 40°C	KTY	max. 45.5 A	IP 65	I. CL. F	$T_a$ 40°C	KTY + 2PTC
Geber Feedback	RS12345678	C416:	Id.Nr. 15061467		Geber Feedback	AM1024-8V-H	C416:	Id.Nr. 15227910	
Bremse Brake	24 V- 1.46 A	80.0 Nm			Bremse Brake	24V- 0.87 A	18.0 Nm		
SN 15061467100000170712345 					SN 152279100000170712345 				
MT-MCA-002.iso/dms					MT-MCS-002.iso/dms				

Example: MDFQA							
 Hans-Lenze-Straße 1 31855 Aerzen GERMANY							
Made in Germany  							
3~MOT	EN60034	CE	$T_a$ 40°C	Hz	31	18	
I. CL. F	IP 23s	KTY/TKO		kW	40.5	22.6	
Br.	480 V	0.18 A	150 Nm				
Geber	IG2048-5V-T			r/min	890	498	
MAT-NR.	13148476			V	355	360	
AUF-NR.	00000123			A	87.0	51.5	
MOT-NR:	13148476100000170712345			$\cos \varphi$	0.86	0.87	
				C86	1302	1301	
							
MT-MDFQA-003.iso/dms							

3.1.2

Product key

Servo motors MCA, MCS, MQA

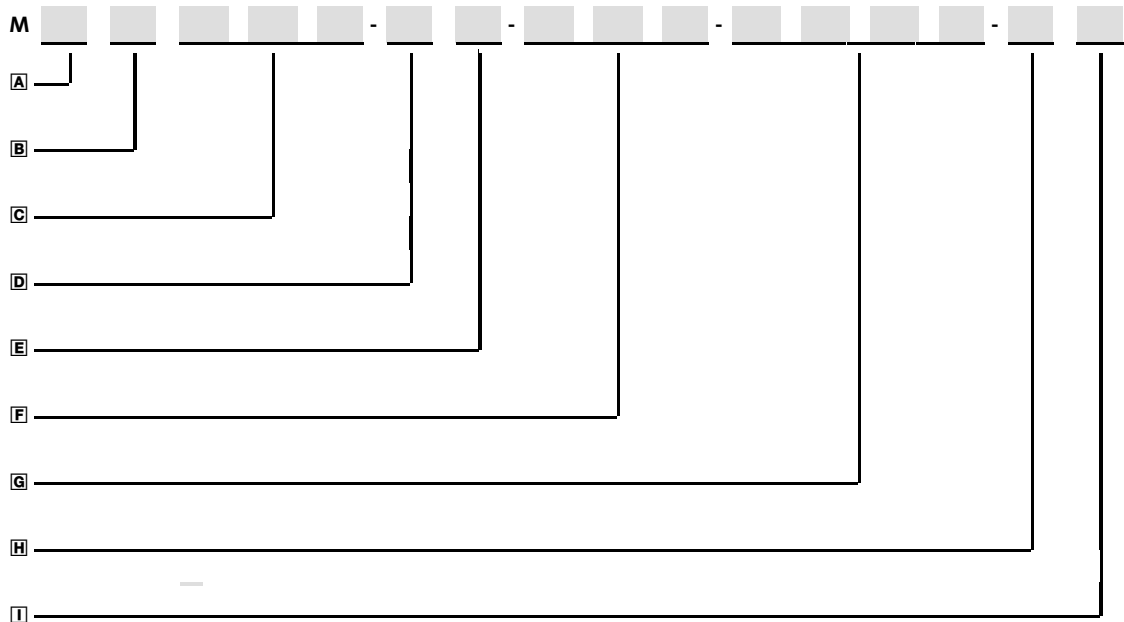

Legend for product key

A Type			
C	Compact servo motors (if required, with axial ventilation)	Q	Radially ventilated motor
B Design			
A	Asynchronous	S	Synchronous
C Motor frame size, motor length, speed			
06	Square dimension 62 mm	19	Square dimension 192 mm
09	Square dimension 89 mm	20	Square dimension 200 mm
10	Square dimension 102 mm	21	Square dimension 214 mm
12	Square dimension 116 mm	22	Square dimension 220 mm
13	Square dimension 130 mm	26	Square dimension 260 mm
14	Square dimension 142 mm	C...X	Overall length
17	Square dimension 165 mm	XX	Speed in 100 min <sup>-1</sup>
D Speed sensor, angle sensor			
RS0	Resolver p=1		
SRS	Singleturn absolute value encoder with sin/cos signals, Hiperface		
SRM	Multiturn absolute value encoder with sin/cos signals, Hiperface		
ECN	Singleturn absolute value encoder with sin/cos signals, EnDat		
EQN	Multiturn absolute value encoder with sin/cos signals, EnDat		
EQI	Multiturn absolute value encoder with sin/cos signals, EnDat		
CXX	Incremental encoder TTL with commutation signals UVW	S1S	Incremental encoder with safety function
TXX	Incremental encoder TTL	SXX	Incremental encoder sin/cos (IS2048)
HXX	Incremental encoder HTL	NNO	No encoder
E Brake			
B0	Without brake	FH	Spring-applied brake 230V AC, reinforced
F1	Spring-applied brake 24V DC	P1	PM brake 24V DC
F2	Spring-applied brake 24V DC, reinforced	P2	PM brake 24V DC, reinforced
F5	Spring-applied brake 205V DC	P5	PM brake 205V DC
F6	Spring-applied brake 205V DC, reinforced	P6	PM brake 205V-DC, reinforced
FG	Spring-applied brake 230V AC		



**▣ Design, shaft, concentricity/vibrational severity/direct gearbox attachment**

Design

A	Standard flange form A/FF with through hole, cyl. shaft without keyway		
B	Standard flange form A/FF with through hole, cyl. shaft with keyway		
C	Standard flange form C/FT with threaded holes, cyl. shaft without keyway		
N	Standard flange form C/FT with threaded holes, cyl. shaft with keyway (standard attachment)		
F	Same as version A except that flange is large	V	Same as version N except that flange is large
G	Same as version B except that flange is large	O	Without flange and without keyway
U	Same as version C except that flange is large	P	Without flange and with keyway

Shaft

11	Shaft 11x23 (MCS06)	24	Shaft 24x50 (MCS14; MCA14, 17)
14	Shaft 14x30 (MCS09; MCA 10)	28	Shaft 28x60 (MCS19; MCA19)
19	Shaft 19x40 (MCS12; MCA13)	38	Shaft 38x80 (MCA21)

Concentricity/vibrational severity/direct gearbox attachment

N or R	Concentricity/vibrational severity		
Z0X	Direct gearbox attachment: Motor without pinion for mounting on open gearbox with pinion; flange for direct gearbox attachment without intermediate cover, with tapered hollow shaft		
Y0X	Direct gearbox attachment: Motor without pinion for mounting on open gearbox with pinion; flange for direct gearbox attachment with intermediate cover, with tapered hollow shaft		

**▣ Electrical connection, enclosure, cooling, load flywheel**

Electrical connection

ST	Separate circular connectors for power/brake, encoder/thermal detector, fan		
SQ	Shared rectangular connector for power, encoder...		
KK	Separate terminal boxes for power/brake, encoder/thermal detector/fan		
KG	Separate terminal boxes for power/brake, blower circular connectors for encoder, thermal detector		
KS	Terminal box for power+brake; circular connector for encoder and thermal detector; circular connector for blower		
SK	Circular connector for power+brake; circular connector for encoder+thermal detector; terminal box for fan		

Degree of protection

2	IP23	6	IP65 with shaft sealing ring
5	IP54 without shaft sealing ring (except for direct mounting on gearbox)		
A	IP64 (A-flange, without shaft sealing ring) / IP65		
B	IP54 with shaft sealing ring (A-bearing, oil-tight)		
C	IP54 with shaft sealing ring, double lip (A bearing dust-tight)		
D	IP65 with double-lip shaft sealing ring		

Cooling

S00	Self cooling/without fan	F10	Blower 230V; AC; 1N
F1F	Blower 230V; AC; 1N; filter	F30	Blower 400V; AC; 3N
F3F	Blower 400V; AC; 3N; filter	F50	Blower 115V; AC; 1N
FWO	Blower 480V; AC; 3N	FWF	Blower 480V; AC; 3N; filter

Load flywheel

N	Without additional load flywheel	J	With additional mass inertia
---	----------------------------------	---	------------------------------

**▣ Temperature protection, electronic nameplate, colour/specification**

Temperature protection

B	NC thermal contact	R	KTY sensor
E	KTY sensor; electronic nameplate		

Electronic nameplate

0	Standard nameplate	2	Second nameplate supplied loose
1	Standard nameplate + electronic nameplate	3	Second nameplate supplied loose + electronic nameplate

Colour/specification

S	Colour: black	U	Specification - UL design, UR approval
---	---------------	---	--

**▣ Miscellaneous**

## Product description

Identification

Product key

### Servo motors MD□□□

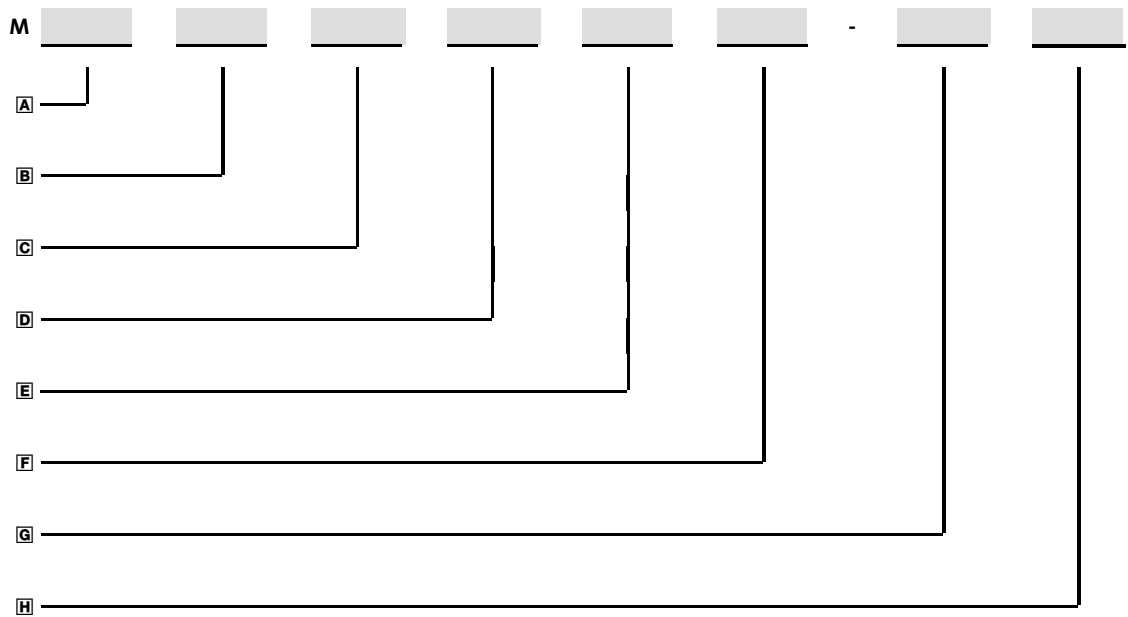

### Legend for type code

#### A Type

D Three-phase AC current

#### B Cooling method, ventilation

F Forced ventilated

S Natural ventilation (cooling by convection and radiation)

#### C Design, housing

K Compact servo motor with square housing and cooling ribs

Q IP23 servo motor with square housing

#### D Machine type

A Asynchronous machine

S Synchronous machine

#### E Built-on accessories

AG Absolute value encoder

BA Brake and sin-cos absolute value encoder or SSI absolute value encoder

BI Brake, incremental encoder

BS Brake and resolver

BR Brake, resolver

IG Incremental encoder

RS Resolver

#### F Frame size

036; 056; 071; 100; 112; 132; 160

#### G Overall length

0; 1; 2; 3; 4

#### H Number of pole pairs

1, 2; 3

### Feedback system

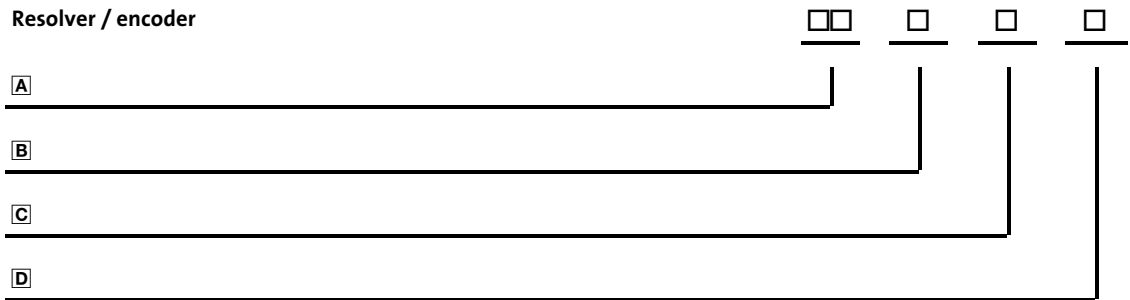

### Legend

<b>A</b>	<b>Type</b>			
	RS	Resolver		
	IG	Incremental encoder		
	IK	Incremental encoder with commutation signal		
	AS	Singleturn absolute value encoder		
	AM	Multiturn absolute value encoder		
<b>B</b>	<b>Number</b>			
	0	2-pole resolver for servo motors		
	1	2-pole resolver for three-phase AC motors		
	2, 3, 4...	Number of pole pairs for resolvers		
	32, 512, 1024, 2048, ...	Number of steps / increments per revolution		
<b>C</b>	<b>Voltage</b>			
	5 V, 9 V, 15 V, 24 V, ...	Medium supply voltage		
<b>D</b>	<b>Interface or signal level</b>			
	<b>Standard</b>		<b>with safety function</b>	
	T	TTL	U	TTL
	H	HTL for incremental encoders	K	HTL (for incremental encoders)
	H	Hiperface for absolute value encoders	K	Hiperface (for absolute value encoders)
	E	EnDat	F	EnDat
	S	sin/cos 1 V <sub>SS</sub>	V	sin/cos 1 V <sub>SS</sub>

## 4 Technical data

### General data and operating conditions

## 4 Technical data

### 4.1 General data and operating conditions

#### General data

Conformity and approval		
Conformity		
CE	2006/95/EC	Low-Voltage Directive
Approvals		
UL/CSA	File no. E210321	
Protection of persons and equipment		
Degree of protection		See nameplate Degrees of protection only apply to horizontal installation All unused plug-in connections must be sealed with protective caps or dummy connectors.
Thermal class	F (155 °C) IEC 60034	Exceeding the temperature limit weakens or destroys the insulation
Permissible voltage		According to limiting curve A of the pulse voltage from IEC / TS 60034-25 (image 14)
EMC		
Noise emission	IEC/EN 61800-3	Depending on the controller, see documentation for the controller.
Noise immunity		

#### Operating conditions

Ambient conditions			
Climatic			
Transport	IEC/EN 60721-3-2	2K3 (-20 ... +70 °C)	
Storage	IEC/EN 60721-3-1	1K3 (-20 ... +60 °C)	< 3 months
		1K3 (-20 ... +40 °C)	> 3 months
Operation	IEC/EN 60721-3-3	Without brake -15 °C ... +40 °C	Without power reduction
		With brake -10 °C ... +40 °C > +40 °C	With power reduction see, catalogue
Site altitude		< 1000 m amsl - without power reduction > 1000 m amsl < 4000m amsl with power reduction, see catalogue	
Humidity		Average relative humidity 85 %, without condensation	
Electrical			
The motor connection type depends on the controller			
Length of motor cable		See inverter instructions	
Length of cable for speed feedback			
Mechanical			
	IEC/EN60721-3-3	3M6	

**4.1.1 Setting the switching frequency to the rated motor data**

The rated data are valid for operation on an inverter with a switching frequency of at least 8 kHz. If operated at a switching frequency of  $f_{ch}=4$  kHz, the following consequences must be observed.

Motor type	Consequences
MDFQA 160	<ul style="list-style-type: none"> <li>At <math>f_{ch} = 4</math> kHz, the motor continuously reaches only approx. 95 % of its rated torque.</li> <li>Strongly increased noise emission</li> </ul>
MQA 20, 22, 26 MCA 20, 22, 26	<ul style="list-style-type: none"> <li>At <math>f_{ch} = 4</math> kHz, the motor continuously reaches only approx. 95 % of its rated torque.</li> <li>Increased noise emission</li> </ul>
MCS MCA 10, 13, 14, 17, 19, 21 MD□KS	<ul style="list-style-type: none"> <li>All published rated data remain valid if <math>f_{ch} = 4</math> kHz.</li> </ul>

## 5 Mechanical installation

### Important notes

## 5 Mechanical installation

### 5.1 Important notes



#### **Danger!**

Some of the motors mounted to the gearboxes are equipped with transport aids. They are **only** intended for the mounting/dismounting of the motor to the gearbox and must **not** be used for the entire geared motor!

- ▶ Only move the drive with means of transport or hoists that have sufficient load-bearing capacity.
- ▶ Ensure safe fixing.
- ▶ Avoid shocks!

### 5.2 Preparation

Remove the corrosion protection from the shaft ends and flanges. If necessary, remove dirt using standard cleaning solvents.



#### **Stop!**

Bearings or seals must not come into contact with the solvent - material damages.

After a long storage period (> 1 year) you have to check whether moisture has entered the motor. For this purpose, measure the insulation resistance (measuring voltage 500 V<sub>DC</sub>). In case of values  $\leq 1\text{k}\Omega$  per volt of rated voltage, dry the winding.

### 5.3 Assembly of built-on accessories

Follow the instructions below carefully. Please note that, in the event of impermissible alteration or modification of the motor, you will lose all entitlements to make claims under warranty and to benefit from product liability obligations.

- ▶ Mount the transmission elements:
  - Shocks and impacts must be avoided! They could destroy the motor.
  - Always use the centre bore in the motor shaft (in accordance with DIN 332, design D) for mounting.
  - Tolerances of the shaft ends:
    - ≤ Ø 50 mm: ISO k6, > Ø 50 mm: ISO m6.
- ▶ Only use an extractor for the disassembly.
- ▶ When using belts for torque/power transmission:
  - Tension the belts in a controlled manner.
  - Provide protection against accidental contact! During operation, surface temperatures of up to 140°C are possible.

#### 5.3.1 Installation

##### Important notes

- ▶ The mounting surface must be dimensioned for the design, weight and torque of the motor.
- ▶ The foot and flange faces must rest flat on the mounting surface.
  - Incorrect motor alignment reduces the service life of the roller bearings and transmission elements.

Impacts on shafts can cause bearing damages.

- ▶ Do not exceed the permissible range of ambient operating temperature (📖 Chap. 4.1).
- ▶ Fasten the motor securely
- ▶ Ensure that the ventilation is not impeded. The exhaust air, also the exhaust air of other machines next to the drive system, must not be taken in immediately.
- ▶ During operation, surfaces are hot, up to 140 °C! Ensure that guard preventing accidental contact is in place!

Ensure an even surface, solid foot/flange mounting and exact alignment if a direct clutch is connected. Avoid resonances with the rotational frequency and double mains frequency which may be caused by the assembly.

Use appropriate means to mount or remove transmission elements (heating) and cover belt pulleys and clutches with a touch guard. Avoid impermissible belt tensions.

The machines are half-key balanced. The clutch must be half-key balanced, too. The visible jutting out part of the key must be removed.

Designs with shaft end at the bottom must be protected with a cover which prevents the ingress of foreign particles into the fan.

## 5 Mechanical installation

Holding brake (option)  
Installation

### 5.4 Holding brake (option)

#### Important notes

As an option, the motors can be fitted with a brake. The installation of brakes (in or on the motor) increases the length of the motor.



#### Note!

The brakes used are not fail-safe because interference factors, which cannot be influenced (e.g. oil ingress), can lead to a reduction in torque.

The brakes are used as holding brakes and serve to hold the axes at standstill or in the deenergised state.

Emergency stops at higher speeds are possible, but high switching energy increases wear on the friction surfaces and the hub (see wear of brakes, page 26 and LEERER MERKER).

The brakes operate according to the closed-circuit principle, i.e. the brake is closed in the deenergised state. The brakes for DC supply can be fed with a bridge-rectified DC voltage (bridge rectifier) or with a smoothed DC voltage. Information on the permissible voltage tolerance is provided in the respective motor catalogue.

If long motor supply cables are used, pay attention to the ohmic voltage drop along the cable and compensate for it with a higher voltage at the input end of the cable.

The following applies to Lenze system cables:

$$U^* = U_B + \left[ \frac{0.08 \Omega}{\text{m}} \cdot L \cdot I_B \right]$$

U* [V]	Resulting supply voltage
U <sub>B</sub> [V]	Rated voltage of the brake
L [m]	Cable length
I <sub>B</sub> [A]	Rated current of the brake



#### Stop!

If no suitable voltage (incorrect value, incorrect polarity) is applied to the brake, the brake will be applied and can be overheated and destroyed by the motor continuing to rotate.

The shortest operating times of the brakes are achieved by DC switching of the voltage and a suppressor circuit (varistor or spark suppressor). Without suppressor circuit, the operating times may increase. A varistor/spark suppressor limits the breaking voltage peaks. It must be ensured that the power limit of the suppressor circuit is not exceeded. This limit depends on the brake current, brake voltage, disengagement time and the switching operations per time unit.

Furthermore, the suppressor circuit is necessary for interference suppression and also increases the service life of the relay contacts (external, not integrated in the motor).



Please refer to the catalogue for servo motors for detailed information about holding brakes.





**Note!**

The brake cannot be readjusted. When the wear limit is reached, the brake has to be replaced.

**5.4.1 Permanent magnet holding brakes**

These brakes are used as holding brakes and serve to hold the axes without backlash at standstill or in the deenergised state.

When activating the brake, it must be ensured that the brake is released or engaged at zero speed to avoid unnecessary and rapid wear of the brake.

When used solely as holding brakes, the brakes are virtually wear free on their friction surfaces. If the max. permissible switching energy per emergency stop (see catalogue) is not exceeded, at least 2000 emergency stop functions from a speed of 3000 rpm are possible.

$W = \frac{1}{2} \cdot J_{ges} \cdot \omega^2$	W [J]	Energy
	$J_{tot}$ [kgm <sup>2</sup> ]	Total moment of inertia
	$\omega$ [1/s]	Angular velocity $\omega=2\pi \cdot n/60$ , n= speed [rpm]

The holding torques specified in the catalogue only apply when the motor is at standstill. In the case of a slipping brake, the dynamic braking torque always applies which depends on the speed.



**Stop!**

The holding brake is only designed for a limited number of emergency stops. Utilisation as a working brake, e.g. to decelerate a load, is not permissible.



**Note!**

The brakes are maintenance-free and cannot be adjusted. In the event of wear, e.g. through emergency stops, the brakes must be replaced.

These brakes operate according to the closed-circuit principle, i.e. the brake is closed in the deenergised state.

Brakes with a rated voltage of DC 24 V are designed for smoothed DC voltages with a ripple of <1 %. It must be ensured that the connector on the motor side is supplied with the minimum voltage of DC 24 V -10 %. If necessary, the voltage drop in the cable should also be considered. If the maximum voltage DC 24 V + 5 % is exceeded, the brake can close again. Supplying the brake with bridge-rectified DC voltage (bridge rectifier without additional smoothing) or a DC voltage with a ripple of >1 % can lead to a malfunctioning of the brake or an increase in the engagement and disengagement times.

Brakes with a rated voltage of DC 205 V are designed for bridge-rectified DC voltage, i.e. for supply via a bridge rectifier from the 230 V mains (half-wave rectifiers are not permissible). Supplying the brake with smoothed DC voltage can lead to malfunctioning or an increase in the engagement and disengagement times. With regard to the minimum and maximum voltages, the same conditions apply as for brakes with 24 V, i.e. the permissible voltage tolerance is 205 V DC +5 %, -10 %.

**Wear of permanent magnet brakes**

If applied as directed (application as holding brakes), the permanent magnet brakes of the servo motors are wear free and intended for long operating times. The wear on the friction lining is due to e.g. emergency stops.

The table below describes the different reasons for wear and their impact on the components of the permanent magnet brakes.

Component	Effect	Influencing factors	Cause
Friction lining / friction surface at the armature plate and external pole	Wear on the friction lining	Applied friction energy	Braking during operation (impermissible, holding brakes!)
			Emergency stops
			Overlapping wear when the drive starts and stops
Springs	Fatigue failure of the springs	Number of switching operations of the brake	Axial duty cycle of the springs
Permanent magnet	Useless brake	Temperature, overvoltage	Excessive overvoltages / temperatures

**Stop!**

In case of wear above the maximum air gap (📖 brake operating instructions), application of the brake cannot be ensured. In this case, no braking process is carried out.

### 5.4.2 Spring-applied holding brakes

These brakes are used as holding brakes and serve to hold the axes without backlash at standstill or in the deenergised state.

For permissible operating speeds and characteristics, please see the respective valid motor catalogue. Emergency stops at higher speeds are possible, but high switching energy increases wear on the friction surfaces and the hub.



#### Stop!

The friction surfaces must always be free from oil and grease because even small amounts of grease or oil will considerably reduce the braking torque.

The formula below provides a simplified way to calculate friction energy per switching cycle which must not exceed the limit value for emergency stops that depends on the operating frequency (see motor catalogue; Lenze drive solutions: Formulas, dimensioning, and tables).

$Q = \frac{1}{2} \cdot J_{ges} \cdot \Delta\omega^2 \cdot \frac{M_K}{M_K - M_L}$	Q [J]	Friction energy
	$J_{tot}$ [kgm <sup>2</sup> ]	Total mass inertia (motor + load)
	$\Delta\omega$ [1/s]	Angular velocity $\omega=2\pi \cdot n/60$ , n= speed [rpm]
	$M_K$ [Nm]	Characteristic torque
	$M_L$ [Nm]	Load torque

Depending on the operating conditions and possible heat dissipation, the surface temperatures can be up to 130 °C.

The spring-applied brakes operate according to the closed-circuit principle, i.e. the brake is closed in the deenergised state. The brakes can be fed with a bridge-rectified DC voltage (bridge rectifier) or with a smoothed DC voltage. The permissible voltage tolerance is ±10%.



For more information on spring-applied brakes, please refer to the corresponding catalogues and operating instructions of the brakes.

#### Wear on spring-applied brakes

Spring-applied brakes are wear-resistant and designed for long maintenance intervals.

However, the friction lining, the teeth between the brake rotor and the hub, and also the braking mechanism are naturally subject to wear due to the way in which the equipment functions. In order to ensure safe and problem-free operation, the brake must therefore be checked regularly and, if necessary, replaced.

If the brake is used purely as a holding brake, the amount of wear on the friction surfaces is only very small. Emergency stops increase wear on the friction surfaces.

The following table describes the different causes of wear and their effect on the components of the spring-applied brake. In order to calculate the service life of the rotor and brake and determine the required maintenance intervals, the relevant influencing factors must be quantified. The most important factors are the applied friction energy, the starting speed of braking and the switching frequency. If several of the indicated causes of wear on the friction lining occur in an application, their effects are to be added together.

## Mechanical installation

Holding brake (option)

Spring-applied holding brakes

Component	Cause	Effect	Influencing factors
Friction lining	Emergency stops	Wear on the friction lining	Applied friction energy
	Overlapping wear when the drive starts and stops		
	Active braking by the drive motor with the help of the brake (quick stop)		
	Starting wear if motor is mounted in a position with the shaft vertical, even if the brake is open		Number of start-stop cycles
Armature plate and flange	Rubbing of the brake lining	Running-in of armature plate and flange	Applied friction energy
Teeth of the brake rotor	Relative movement and impacts between brake rotor and brake hub	Teeth wear (primarily at the rotor end)	Number of start-stop cycles, level of the braking torque
Armature plate bracket	Load changes and impacts due to reversal error during interaction between armature plate, cap screws and guide bolts	Armature plate, cap screws and bolts are deflected	Number of start-stop cycles, level of braking torque
Springs	Axial load cycle and shearing stress on the springs due to radial reversed error of the armature plate	Fatigue failure of the springs	Number of switching operations of the brake

## 6 Electrical installation

### 6.1 Important notes



#### Danger!

Hazardous voltage on the power connections even when disconnected from mains: residual voltage >60 V!

Before working on the power connections, always disconnect the drive component from the mains and wait until the motor is at standstill. Verify safe isolation from supply!



#### Stop!

Electrical connections must be carried out in accordance with the national and regional regulations!

Comply with the tolerance specified in IEC/EN 60034-1:

- Voltage  $\pm 5\%$
- Frequency  $\pm 2\%$
- Waveform, symmetry (increases the temperature and affects the electromagnetic compatibility)

Observe the data on the nameplate, operating notes, and the connection diagram in the terminal box.

- ▶ The connection must ensure a permanent safe electrical connection, i.e.
  - no loose wire ends,
  - use assigned cable end fittings,
  - ensure good electrical conductivity of the contact (remove residual lacquer) if an (additional) PE connection on the motor housing is used,
  - establish a safe PE conductor connection,
  - tighten the plug-in connector to the limit stop.
- ▶ The smallest air gaps between uncoated, live parts and against earth must not fall below the following values.

Minimum requirements for basic insulation according to IEC/EN 60664-1 (CE)	Higher requirements for UL design	Motor diameter
3.87 mm	6.4 mm	< 178 mm
	9.5 mm	> 178 mm

- ▶ The terminal box must be free of foreign particles, dirt and moisture.
- ▶ All unused cable entries and the box itself must be sealed against dust and water.

## 6 Electrical installation

### Wiring according to EMC

#### 6.2 Wiring according to EMC

The EMC-compliant wiring of the motors is described in detail in the Operating Instructions for the Lenze controllers.

- ▶ Use of metal EMC cable glands with shield connection.
- ▶ Connect the shielding to the motor and to the device.

#### 6.3 Plug connectors



#### Stop!

- ▶ Tighten the coupling ring of the connector.
- ▶ If plugs **without** SpeedTec bayonet nut connectors are used, the connector boxes for the power / encoder / fan connections must be secured by O-rings if loadings by vibration occur:
  - M17 connector box with O-ring 15 x 1.3 mm
  - M23 connector box with O-ring 18 x 1.5 mm
  - M40 connector box with O-ring 27 x 4.0 mm

Plug-in connectors (plug/connector box) with SpeedTec bayonet nut connectors are vibration-proof.

- ▶ Never disconnect plugs when voltage is being applied! Otherwise, the plugs could be destroyed! Inhibit the controller before disconnecting the plugs!

##### 6.3.1 Power connections / holding brake

6-pole (external view of poles)			M23
Pin	Standard description	Meaning	
1	BD1	Holding brake +	
2	BD2	Holding brake -	
⊕	PE	PE conductor	
4	U	Power phase U	
5	V	Power phase V	
6	W	Power phase W	

MCA, MCS, MQA (external view of poles)			M40
Pin	Standard description	Meaning	MCA 19...21, MCS 14...19, MQA 20
1	Not assigned		
+	BD1	Holding brake +	
-	BD2	Holding brake -	
⊕	PE	PE conductor	
U	U	Power phase U	
V	V	Power phase V	
W	W	Power phase W	

\* At times, older documents also stated plug sizes of 1.0 (M23) and 1.5 (M40).

### 6.3.2 Holding brake

MDFQA		
Pin	Standard description	Meaning
1	BD1	Holding brake +
2	BD2	Holding brake -

### 6.3.3 Fan

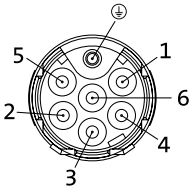
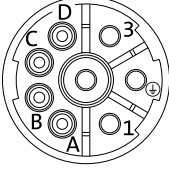
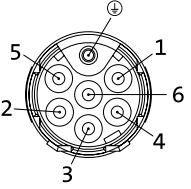
Single-phase (external view of poles)			M17
⊕	PE	PE conductor	
1	U1	Fan	
2	U2	Fan	
3	Not assigned		
4			
5			
6			
8-pole (external view of poles)			M23
⊕	PE	PE conductor	
1	Not assigned		
2			
3			
A	U1	Fan	
B	U2	Fan	
C	Not assigned		
D			
Three-phase (external view of poles)			M17
⊕	PE	PE conductor	
1	U	Fan	
2	Not assigned		
3	V	Fan	
4	Not assigned		
5			
6	W	Fan	

\* At times, older documents also stated plug sizes of 1.0 (M23) and 1.5 (M40).

## 6 Electrical installation

Plug connectors  
Feedback system

### 6.3.4 Feedback system

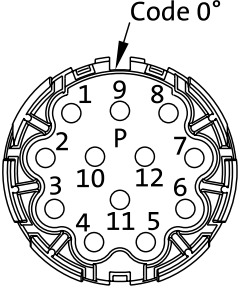
Resolver (external view of poles)			M23
Pin	Designation	Meaning	
1	+ Ref	Transformer windings (reference windings)	
2	- Ref		
3	+VCC ENP	Supply: electronic nameplate <sup>1)</sup>	
4	+ Cos	Stator windings cosine	
5	- Cos		
6	+ Sin	Stator windings sine	
7	- Sin		
8			
9	Not assigned		
10			
11	+ KTY	KTY thermal detector	
12	- KTY		

Incremental encoder / sin/cos absolute value encoder Hiperface (external view of poles)			M23
Pin	Designation	Meaning	
1	B	Track B / + SIN	
2	$\bar{A}$	Track A inverse / - COS	
3	A	Track A / + COS	
4	+ U <sub>B</sub>	Supply + Earth	
5	GND		
6	$\bar{Z}$	Zero track inverse / - RS485 Zero track / + RS485	
7	Z		
8	Not assigned		
9	$\bar{B}$	Track B inverse / - SIN	
10		Not assigned	
11	+ KTY	KTY thermal detector	
12	- KTY		

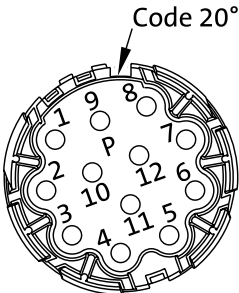
Sin/cos absolute value encoder with EnDat interface (external view of poles)			M23
Pin	Designation	Meaning	
1	UP sensor	Supply UP sensor	
2			
3	Not assigned		
4	0 V sensor	0 V sensor supply	
5	+ KTY	KTY thermal detector	
6	- KTY		
7	+ U <sub>B</sub>	Supply + / +VCC ENP <sup>1)</sup>	
8	Clock pulse	Clock pulse EnDat interface Clock pulse inverse EnDat interface	
9	Clock pulse		
10	GND	Earth	
11	Shield	Shield for housing of encoder	
12	B	Track B	
13	$\bar{B}$	Track B inverse	
14	Data	Data EnDat interface	
15	A	Track A	
16	$\bar{A}$	Track A inverse	
17	Data	Data inverse EnDat interface	

1) Only for versions with electronic nameplate ENP.

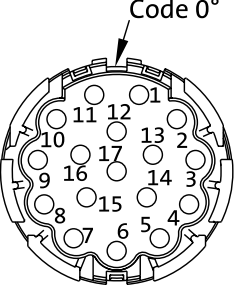
\* At times, older documents also stated plug sizes of 1.0 (M23) and 1.5 (M40).



## 6.4 Terminal box

Terminal box with knock out

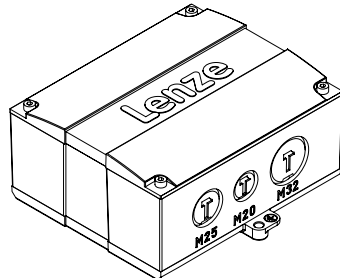

MT-terminal box-001.iso

The openings in the terminal box are cast closed and can be opened by the customer as required.

Terminal box with screwed connections

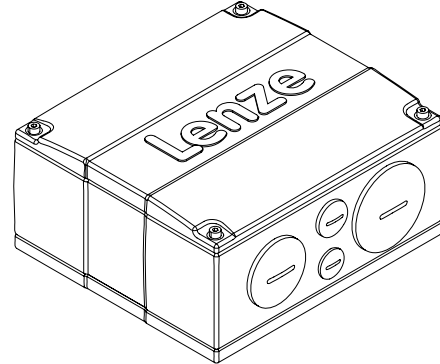

MT-terminal box-002.iso



### Note!

Open the holes on the underside of the knock out terminal box when the cover is closed.

## Cable glands and terminal studs for the power terminal box

Motor type/size	Cable glands	Power connection			Terminal board		
		Cable cross-section [mm <sup>2</sup> ]	Terminal Stripping length [mm]	Tightening torque [Nm]	Threaded bolt	Tightening torque [Nm]	
MCA	10, 13, 14, 17	1 x M20 x 1.5 + 1 x M16 x 1.5	0,08 ... 2,5	10 ... 11	2)	-----	-----
	19, 21	1 x M32 x 1.5 + 1 x M25 x 1.5	0,2 ... 10	10 ... 11	2)	-----	-----
	20	2 x M20 + 2 x M 25 + 2 x M32	2,5 ... 16	18 ... 20	2)	-----	-----
	22	1 x M40x1.5 + 1 x M50x1.5 + 1 x M20x1.5 + 1 x M16x1.5	10 ... 35	18	3,2	-----	-----
	26	1 x M50 x 1.5 + 1 x M63 x 1.5 + 1 x M20 x 1.5 + 1 x M16 x 1.5	-----		2)	M12	15,5
MQA	20	2 x M20 + 2 x M 25 + 2 x M32	2,5 ... 16	18 ... 20	2)	-----	-----
	22	1 x M40x1.5 + 1 x M50x1.5 + 1 x M20x1.5 + 1 x M16x1.5	10 ... 35	18	3,2	-----	-----
	26	1 x M50 x 1.5 + 1 x M63 x 1.5 + 1 x M20 x 1.5 + 1 x M16 x 1.5	-----		2)	M12	15,5
MCS	09, 12, 14D, 14H, 14L15, 14P14, 19F15, 19J15	2 x M20 + 2 x M25 + 2 x M32	0,08 ... 2,5 <sup>1)</sup>	10 ... 11	2)	-----	-----
	14L32, 14P32, 19F13, 19J30, 19P		0,2 ... 10	10 ... 11	2)	-----	-----
MDFQA	160	2 x M63 x 1.5 + 1 x M16 x 1.5			2)	M12	15,5
MD□KS	056, 071	1 x M20 x 1.5 + 1 x M16 x 1.5	0,08 ... 2,5	10 ... 11	2)	-----	-----

Tab. 1 Cable glands and connecting terminals

1) 4 mm<sup>2</sup> without wire end ferrule

2) Spring terminal

## Cable glands for the fan terminal box

Motor type/size	Screwed connection
MCA/MQA	
20	
22	1 x M 16 x 1.5
26	

6.4.1 Power connections

MCA; MCS, MQA, MD□KS		
Terminal Standard/Lenze designation	Meaning	
⊕	PE	PE conductor for motor housing
U	U1	Motor winding phase U
V	V1	Motor winding phase V
W	W1	Motor winding phase W
TP1 (P1)	PTC	PTC thermistor
TP2 (P2)	PTC	
TB1 (S1)		Thermostat (NC contact)
TB2 (S2)		

MCA 26, MQA 26, MDFQA 160			Star connection	Delta connection
Terminal	Meaning			
⊕	PE conductor			
1	U1	Motor winding phase U		
2	V1	Motor winding phase V		
3	W1	Motor winding phase W		
4	Not assigned			
5				
6				

6.4.2 AC holding brake with rectifier (option)

Terminal	Standard description	Meaning	
~	BA1	Connection to L1 - mains	
~	BA2	Connection to N - mains	
+	BD1 (factory-set wiring)	Connection of holding brake +	
-	BD2 (factory-set wiring)	Connection of holding brake -	
⊖	Switching contact, DC switching		

6.4.3 DC holding brake (optional)

MDFQA		
Terminal	Standard description	Meaning
BD1	BD1	Holding brake +
BD2	BD2	Holding brake -

## 6.4.4

## Fan

MCA, MQA, MD□K□ - single-phase		
Terminal	Standard description	Meaning
⊕	PE	PE conductor
U1	U1	Connection to L1 - mains
U2	U2	Connection to N - mains

MQA, MDFQA - three-phase		
Terminal	Standard description	Meaning
⊕	PE	PE conductor
L1	U	Connection to L1 mains
L2	V	Connection to L2 mains
L3	W	Connection to L3 mains

### 6.4.5 Feedback system

Resolver		
Terminal	Designation	Meaning
B1	+ Ref	Transformer windings (reference windings)
B2	- Ref	
B3	+ VCC ENP	Supply: electronic nameplate <sup>1)</sup>
B4	+ Cos	Stator winding cosine
B5	- Cos	
B6	+ Sin	Stator winding sine
B7	- Sin	
B8		Not assigned
R1	+ KTY	KTY thermal detector
R2	- KTY	

1) Only for versions with electronic nameplate ENP.

Incremental encoder / sin/cos absolute value encoder with Hiperface		
Terminal	Designation	Meaning
B1	+ U <sub>B</sub>	Supply + Earth
B2	GND	
B3	A	Track A / + COS Track A inverse / - COS
B4	$\bar{A}$	
B5	B	Track B / + SIN Track B inverse / - SIN
B6	$\bar{B}$	
B7	Z	Zero track / + RS485 Zero track inverse / - RS485
B8	$\bar{Z}$	
B10	Shield - housing	Incremental encoder - shield
R1	+ KTY	Temperature sensor KTY + Temperature sensor KTY -
R2	- KTY	

Sin/cos absolute value encoder with EnDat interface		
Terminal	Designation	Meaning
B1	+ U <sub>B</sub>	Supply + / + VCC ENP <sup>1)</sup>
B2	GND	Earth
B3	A	Track A Track A inverse
B4	$\bar{A}$	
B5	B	Track B Track B inverse
B6	$\bar{B}$	
B7	<u>Data</u>	Data EnDat interface
B8	$\overline{\text{Data}}$	Data inverse EnDat interface
B20	<u>Clock pulse</u>	Clock pulse EnDat interface Clock pulse inverse EnDat interface
B21	$\overline{\text{Clock pulse}}$	
B22	UP sensor	UP sensor
B23	0 V sensor	0 V sensor
B24	Shield	Shield for housing of encoder
B25		Not assigned
R1	+ KTY	Temperature sensor KTY + Temperature sensor KTY -
R2	- KTY	

1) Only for versions with electronic nameplate ENP.

## 7 Commissioning and operation

Important notes

## 7 Commissioning and operation

### 7.1 Important notes

For trial run without output elements, lock the featherkey. Do not deactivate the protective devices, not even in a trial run.

Check the correct operation of the brake before commissioning motors with brakes.

### 7.2 Before switching on



#### Note!

Before switch-on, you must ensure that the motor starts with the intended direction of rotation.

Lenze motors rotate CW (looking at the driven shaft) if a clockwise three-phase field L1 → U1, L2 → V1, L3 → W1 is applied.

Before initial commissioning, before commissioning after an extended standstill period, or before commissioning after an overhaul of the motor, the following must be checked:

- ▶ Measure the insulation resistance, in case of values  $\leq 1 \text{ k}\Omega$  per volt of rated voltage, dry the winding.
- ▶ Have all screwed connections of the mechanical and electrical parts been firmly tightened?
- ▶ Is the unrestricted supply and removal of cooling air ensured?
- ▶ Has the PE conductor been connected correctly?
- ▶ Have the protective devices against overheating (temperature sensor evaluation) been activated?
- ▶ Is the controller correctly parameterised for the motor?  
( Controller operating instructions)
- ▶ Are the electrical connections o.k.?
- ▶ Does the motor connection have the correct phase sequence?
- ▶ Are rotating parts and surfaces which can become very hot protected against accidental contact?
- ▶ Is the contact of good electrical conductivity if a PE connection on the motor housing is used?

### 7.3 Functional test

### 7.4 Functional test

- ▶ Check all functions of the drive after commissioning:
- ▶ Direction of rotation of the motor
  - Direction of rotation in the disengaged state (see chapter "Electrical connection").
- ▶ Torque behaviour and current consumption
- ▶ Function of the feedback system

### 7.5 During operation



#### Stop!

- ▶ Fire hazard! Do not clean or spray motors with flammable detergents or solvents.
- ▶ Avoid overheating! Deposits on the drives impede the heat dissipation required and have to be removed regularly.



#### Danger!

During operation, motor surfaces may not be touched. According to the operating status, the surface temperature for motors can be up to 150°C. For the protection against burn injuries, provide protection against contact, if necessary. Observe cooling-off times!

During operation, carry out inspections on a regular basis. Pay special attention to:

- ▶ Unusual noises
- ▶ Oil spots on drive end or leakages
- ▶ Irregular running
- ▶ Increased vibration
- ▶ Loose fixing elements
- ▶ Condition of electrical cables
- ▶ Speed variations
- ▶ Impeded heat dissipation
  - Deposits on the drive system and in the cooling channels
  - Pollution of the air filter

In case of irregularities or faults: chapter 9.

## 8 Maintenance/repair

### Important notes

## 8 Maintenance/repair

### 8.1 Important notes



#### **Danger!**

Hazardous voltage on the power connections even when disconnected from mains: residual voltage >60 V!

Before working on the power connections, always disconnect the drive component from the mains and wait until the motor is at standstill. Verify safe isolation from supply!

Shaft sealing rings and roller bearings have a limited service life.

Regrease bearings with relubricating devices while the low-voltage machine is running. Only use the grease recommended by the manufacturer. If the grease drain holes are sealed with a plug, (IP54 drive end; IP23 drive and non-drive end), remove plug before commissioning. Seal bore holes with grease.

### 8.2 Maintenance intervals

#### **Inspections**

- ▶ If the machine is exposed to dirt, clean the air channels regularly.

#### **Motor**

- ▶ Only the bearings and shaft sealing rings become worn.
  - Check bearings for noise (after approx. 15,000 h at the latest).
- ▶ In order to prevent overheating, remove dirt deposits on the drives regularly.
- ▶ We recommend carrying out an inspection after the first 50 operating hours. In this way, you can detect and correct any irregularities or faults at an early stage.



### 8.2.1 Holding brake

The brakes need to be checked on a regular basis to ensure safe and trouble-free operation.

The necessary maintenance intervals primarily depend on the stress to which the brake is subjected in an application. When a maintenance interval is being calculated, all causes of wear must be taken into account (see notes "Wear on spring-applied brakes"). In the case of brakes which are subjected to low levels of stress, e.g. holding brakes with emergency stop function, regular inspections at a fixed time interval are recommended. In order to reduce the amount of work involved in maintenance, perform the inspection at the same time as other maintenance work carried out cyclically on the machine if possible.

If the brakes are not properly serviced, operating faults, production outages or damage to machinery can occur. A maintenance concept adapted to the operating conditions and the stresses to which the brakes are subjected must therefore be drawn up for every application. For brakes, the maintenance intervals and servicing work listed in the following table are necessary.

Maintenance interval for holding brake with emergency stop	Maintenance work
At least every 2 years	Inspection of the brake integrated in the motor: <ul style="list-style-type: none"> <li>• Check ventilation function and activation/deactivation</li> </ul>
After 1 million cycles at the latest	
Shorter intervals in the case of frequent emergency stops!	

The brakes of the MCS, MCA, MQA, and MD□KS motors cannot be accessed from the outside! (Maintenance work on the brakes must be carried out by Lenze Service staff only!)

## 8.3 Maintenance operations



### Stop!

- ▶ Make sure that no foreign bodies can enter the inside of the motor!
- ▶ Only work on the drive system when it is in a deenergised state!
- ▶ Do not remove plugs when voltage is being applied!
- ▶ Hot motor surfaces up to 140 °C. Observe cooling times!
- ▶ Remove loads acting on motors or secure loads acting on the drive!

### 8.3.1 Blower

If the motor is equipped with a dust protection filter, this filter must be cleaned or even replaced at regular intervals depending on the amount of dust (if necessary, daily).

For motors equipped with a dry filter, the dust must be shaken out completely. If the dust is wet, the filter mat must be replaced.

**8.3.2**      **Fan with dust protection filter**

Dry-type filters are used for the motors. Dry dust should be removed completely by tapping.



**Note!**

The dust filter is mounted on the ventilation aggregate. Depending on the amount of dust, the filter must be cleaned and replaced in regular intervals!

Soiled filters reduce the amount of cooling air significantly. This leads to a higher winding temperature, reduces its service life and may lead to damages.

When replacing the filter you **must** take care that all covers and filters are tightly fixed so that there are no leaks for harmful dust!

In case of **wet** dust you must install new filter mats. The internal cleanness of the motor should be checked at the latest when you replace the filter for the first time.

**8.3.3**      **Motors with bearing relubricating devices**

Under normal operating conditions, the bearings used have a service life of approx. 20.000 operating hours. Ex works the bearings are filled with a high-quality, heat-resistant roller bearing grease. (The permissible operating temperature range of the grease used is between -25°C and +120°C).

**Relubrication period, type of grease and amount of grease are stated on an additional indicating label on the motor.**

<b>Nachschmierung / Lubrication</b>	
Herstellbezeichnung/ Manufacturer designation	<input type="text"/> <b>A</b>
Bezeichnung nach DIN51502/ Standard designation	<input type="text"/> <b>B</b>
Nachschmierfrist/ Lubrication period	<input type="text"/> <b>C</b>
Fettmenge/ Quantity of grease	<input type="text"/> <b>D</b>

- A** Manufacturer designation
- B** Designation of grease type according to DIN51502
- C** Relubrication period
- D** Amount of grease

**8.3.4**      **Motor plug connection assignment**

This motor-plug assignment is a rough selection of possible mechanical combinations.



**Note!**

When making your selection, the motor data and permissible currents of the cables according to the system cable system manual must be observed.



Further information is provided in the system cables system manual at:  
www.Lenze.de → Services & Downloads → Technical documentation → Library →  
X1\_Zubehör → X15\_Externes\_Zubehör → X153\_Systemleitungen

Connector	Connectable cross-section of the motor cable
EWS0001 / EWS1001	1.0 mm <sup>2</sup> , 1.5 mm <sup>2</sup> , 2.5 mm <sup>2</sup>
EWS0012 / EWS1012	2.5 mm <sup>2</sup> , 4.0 mm <sup>2</sup>
EWS0013 / EWS1013	6.0 mm <sup>2</sup> , 10.0 mm <sup>2</sup> , 16.0 mm <sup>2</sup>

### 8.3.5 Power connection for plug-in connector at the cable end

#### Asynchronous servo motors

Motor type	Plug size *	Screw plug		SpeedTec							
		Spare part designation	Coding in the system cable type code	Spare part designation	Coding in the system cable type code						
MCA	10I40- ... S00	M23	EWS0001	M01	EWS1001	M04					
	13I34- ... Fx0										
	13I41- ... S00										
	14L16- ... Fx0										
	14L20- ... S00										
	14L35- ... Fx0										
	14L41- ... S00										
	17N17- ... Fx0										
	17N23- ... S00										
	17N35- ... Fx0										
	17N41- ... S00										
	19S17- ... Fx0						M40	EWS0012	M02	EWS1012	M05
	19S23- ... S00										
	19S35- ... Fx0						M40	EWS0012	M02	EWS1012	M05
EWS0013		M03	EWS1013	M06							
19S42- ... S00	M40	EWS0012	M02	EWS1012	M05						
		EWS0013				M03	EWS1013	M06			
20X14- ... Fx0	M40	EWS0013	M03	EWS1013	M05						
					M06						
20X29- ... Fxx	M40	EWS0013	M03	EWS1013	M06						
21X17- ... Fx0	M40	EWS0012	M02	EWS1012	M05						
		EWS0013				M03	EWS1013	M06			
21X25- ... S00	M40	EWS0012	M02	EWS1012	M05						
21X35- ... Fx0		EWS0013	M03	EWS1013	M06						
21X42- ... S00		EWS0012	M02	EWS1012	M05						
MQA	20	EWS0013	M03	EWS1013	M06						

\* At times, older documents also stated plug sizes of 1.0 (M23) and 1.5 (M40).

**Synchronous servo motors**

Motor type		Plug size *	Screw plug		SpeedTec						
			Spare part designation	Coding in the system cable type code	Spare part designation	Coding in the system cable type code					
MDSKS 036 - 071		M23	EWS0001	M01	EWS1001	M04					
MDFKS 071											
MCS	06										
	09										
	12										
	14D										
	14H12- ... Fx0										
	14H15- ... S00										
14H28- ... Fx0							M40	EWS0012 EWS0013	M02 M03	EWS1012 EWS1013	M05 M06
14H32- ... S00							M23	EWS0001	M01	EWS1001	M04
14L14- ... Fx0											
14L15- ... S00											
14L30- ... Fx0							M40	EWS0012 EWS0013	M02 M03	EWS1012 EWS1013	M05 M06
14L32- ... S00											
14P11- ... Fx0		M23	EWS0001	M01	EWS1001	M04					
S43.14											
14P26- ... Fx0		M40	EWS0012 EWS0013	M02 M03	EWS1012 EWS1013	M05 M06					
14P32- ... S00											
19F12- ... Fx0		M23	EWS0001	M01	EWS1001	M04					
19F14- ... S00			EWS0001	M01	EWS1001	M04					
19F29- ... Fx0		M40	EWS0012 EWS0013	M02 M03	EWS1012 EWS1013	M05 M06					
19F30- ... S00											
19J12- ... Fx0											
19J14- ... S00		M23	EWS0001	M01	EWS1001	M04					
19J29- ... Fx0		M40	EWS0013	M03	EWS1013	M06					
19J30- ... S00		M40	EWS0012 EWS0013	M02 M03	EWS1012 EWS1013	M05 M06					
19P12- ... Fx0											
19P14- ... S00		M23	EWS0001	M01	EWS1001	M04					
19P29- ... Fx0		M40	EWS0013	M03	EWS1013	M06					
19P30- ... S00											

\* At times, older documents also stated plug sizes of 1.0 (M23) and 1.5 (M40).

### 8.3.6 Plug-in connector at the cable end

#### Feedback

Type of encoder	Plug size *	Screw plug		SpeedTec	
		Spare part designation	Coding in the system cable type code	Spare part designation	Coding in the system cable type code
Resolver	M23	EWS0006	F01	EWS1006	F05
Incremental encoder		EWS0010	F02	EWS1010	F06
Sin/cos encoder, Hiperface		EWS0010	F02	EWS1010	F06
Sin/cos encoder, EnDat		EWS0017	F03	EWS1017	F07
Incremental encoder, Renco R35		EWS0023	F04	EWS1023	F08

#### Blower

Blower	Plug size *	Screw plug		SpeedTec	
		Spare part designation	Coding in the system cable type code	Spare part designation	Coding in the system cable type code
MDFKS	M23	EWS0003	L01	EWS1003	L03
MCS, MCA, MQA	M17	EWS0021	L02	EWS1021	L04

\* At times, older documents also stated plug sizes of 1.0 (M23) and 1.5 (M40).

### 8.4 Repair

- ▶ It is recommended to have all repairs performed by Lenze Service.
- ▶ Delivery of spare parts is available upon request.
- ▶ Errors must be ruled out between motor and encoder to ensure functional safety.



#### **Note!**

Repair work or replacement of defective safety encoders must only be carried out by Lenze service personnel!

### 9 Troubleshooting and fault elimination

If faults occur during operation of the drive system:

- ▶ First check the possible causes of malfunction according to the following table.
- ▶ Also observe the corresponding chapters in the operating instructions to the other components of the drive system.

If the fault cannot be remedied using one of the listed measures, please contact the Lenze Service.



#### Danger!

- ▶ Only work on the drive system when it is in a deenergised state!
- ▶ Hot motor surfaces of up to 150 °C. Observe cooling times!
- ▶ Remove loads acting on motors or secure loads acting on the drive!

Fault	Cause	Remedy
Motor too hot  Can only be evaluated by measuring the surface temperature: <ul style="list-style-type: none"> <li>● Non-ventilated motors &gt; 140 °C</li> <li>● Externally ventilated or self-ventilated motors &gt; 110 °C</li> </ul>	Insufficient cooling air, blocked air ducts.	Ensure unimpeded circulation of cooling air
	Preheated cooling air	Ensure a sufficient supply of fresh cooling air
	Overload, with normal mains voltage the current is too high and the speed too low	Use larger drive (determined by power measurement)
	Rated operating mode exceeded (S1 to S8 IEC/EN 60034-1)	Adjust rated operating mode to the specified operating conditions. Determination of correct drive by expert or Lenze customer service
	Loose contact in supply cable (temporary single-phase operation!)	Tighten loose contact
	Fuse has blown (single-phasing!)	Replace fuse
	Overloading of the drive	<ul style="list-style-type: none"> <li>● Check load and, if necessary, reduce by means of longer ramp-up times</li> <li>● Check winding temperature</li> </ul>
Heat dissipation impeded by deposits	Clean surface and cooling ribs of the drives	
Motor does not start	Voltage supply interrupted	<ul style="list-style-type: none"> <li>● Check error message on the drive controller</li> <li>● Check electrical connection (□ Chapter 6)</li> </ul>
	Controller inhibited	<ul style="list-style-type: none"> <li>● Check display at drive controller</li> <li>● Check controller enable</li> </ul>
	Fuse has blown	Replace fuse
	Encoder cable broken	<ul style="list-style-type: none"> <li>● Check error message at drive controller</li> <li>● Check encoder cable</li> </ul>
	Brake does not release	Check electrical connection Check air gap (see brake operating instructions) Check continuity of magnetic coil
	Drive is blocked	Check components for easy movement, remove foreign particles if necessary
	Motor cable polarity is reversed	Check electrical connection
Motor suddenly stops and does not start again	Overload monitoring of the inverter responds	<ul style="list-style-type: none"> <li>● Check settings on controller</li> <li>● Reduce load by means of longer acceleration times</li> </ul>
Incorrect direction of rotation of the motor, correct display on the controller	Motor cable polarity is reversed	Check and correct polarity
	Encoder cable polarity is reversed	

Fault	Cause	Remedy
Motor rotates normally but does not generate the expected torque	Motor cable interchanged cyclically	Connect the phases at the motor cable connection correctly
Motor rotates in one direction at maximum speed in an uncontrolled manner	Motor cable interchanged cyclically	Check motor connection and, if necessary, correct it
	Polarity of encoder cable reversed	Check encoder connection and, if necessary, correct it
Motor rotates slowly in one direction and cannot be influenced by the drive controller	Polarity of motor cable and encoder cable reversed	Check the polarity and correct it
Unsteady running	Shielding of motor cable or resolve cable inadequate	Check shielding and earth connection
	Gain of the drive controller too high	Adapt gain of the controller (see operating instructions for drive controller)
Vibrations	Insufficiently balancing of coupling elements or machine	Rebalance
	Inadequate alignment of drive train	Realign machine, if necessary, check foundation
	Loose fixing screws	Check screwed connections and tighten them if necessary
Running noises	Foreign particles inside the motor	Repair by manufacturer if necessary
	Bearing damage	
Surface temperature > 140°C	Overload of the drive	<ul style="list-style-type: none"> <li>● Check overload and reduce through longer acceleration times, if necessary</li> <li>● Check winding temperature</li> </ul>
	Heat dissipation impeded by dirt deposits	Clean surface and cooling ribs of the drives



© 06/2010



Lenze Drives GmbH  
Postfach 10 13 52  
D-31763 Hameln  
Germany



+49 (0)51 54 / 82-0



+49 (0)51 54 / 82-28 00



Lenze@Lenze.de



www.Lenze.com

Service

Lenze Service GmbH  
Breslauer Straße 3  
D-32699 Extertal  
Germany



00 80 00 / 24 4 68 77 (24 h helpline)



+49 (0)51 54 / 82-13 96



Service@Lenze.de

BA 33.0006-EN ■ 13342412 ■ 2.0 ■ TD09

10 9 8 7 6 5 4 3 2 1