



## OFFICIAL DISTRIBUTOR

RGB ELEKTRONIKA AGACIAK CIACIEK SP.J.  
ul. Jana Długosza 2-6  
51-162 Wrocław

+48 71 325 15 05  
[biuro@rgbelektronika.pl](mailto:biuro@rgbelektronika.pl)

ENCODER RON 255 18000 RON25518000 SIN/COS 18000 PPR +5V REPLACEMENT  
ID23621



**PRECIZIKA**  
METROLOGY



# A90H

## PHOTOELECTRIC ANGLE ENCODER



Photoelectric angle encoder A90H is used to measure angular position of the key machine components, industrial robots, comparators, rotary tables and to establish an informational link with DCC, NC or Digital Readout Units. It provides information about the value and direction of motion. The encoder is used in automatic control, on-line gauging, process monitoring systems, etc.

Three versions of output signals are available:

- A90H-A - sinusoidal signals, with amplitude approx. 1 V<sub>pp</sub>;

- A90H-AV - sinusoidal signals, with amplitude approx. 1 V<sub>pp</sub>;
- A90H-F - square-wave signals (TTL) with integrated subdividing electronics for interpolation x1, x2, x5, x10, x20, x25, x50 and 100.

The modification with distance-coded reference marks is available.

The encoder has two coupling versions: P- via shaft collar and H – via central screw.

### MECHANICAL DATA

Line number on disc (z)	18000
Number of output pulses per revolution for A90H-F	Z x k, where k = 1, 2, 3, 4, 5, 8, 10, 20, 25, 50, 100
Reference signal: - standard (S) - distance-coded (K)	one per shaft revolution 36 per shaft revolution
Permissible mech. speed	≤ 3000 rp
Max. operating speed (depends on number of output pulses)	600 to 1000 rpm
Accuracy grades	±5.0 arc. sec; ±7.5 arc. sec
Starting torque at 20°C	≤ 0.08 Nm

Permissible shaft run out:

- axial 0.02 mm
- radial ±0.02 mm

Rotor moment of inertia	< 0.6x10 <sup>-4</sup> kgm <sup>2</sup>
Protection (IEC 529)	IP64
Maximum weight without cable	1.2 kg
Operating temperature	0...+70 °C
Storage temperature	-30...+85 °C
Maximum humidity (non condensing)	98 %
Permissible vibration (55 to 2000 Hz)	≤ 100 m/s <sup>2</sup>
Permissible shock (5 ms)	≤ 300 m/s <sup>2</sup>

### MOUNTING TYPE P (CLAMP)

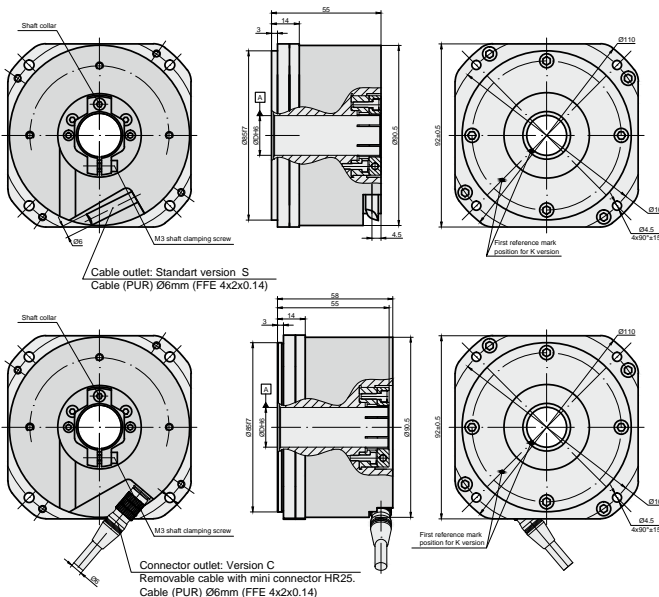

øD, mm

20

22

### MOUNTING TYPE H (SCREW)

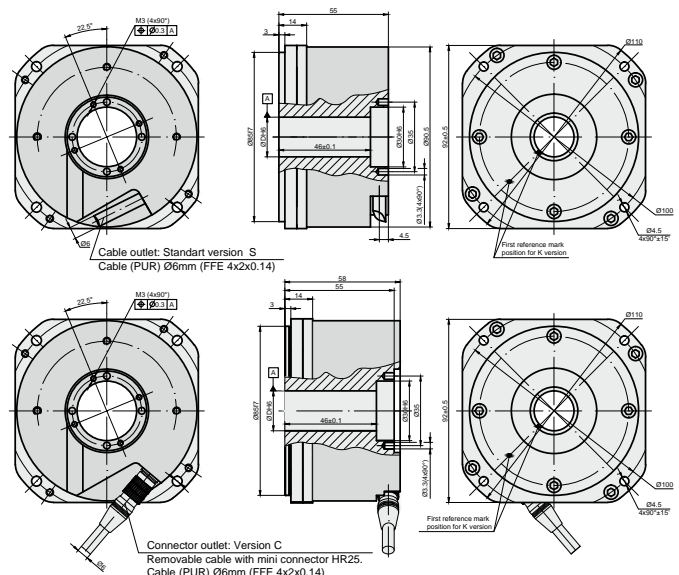

øD, mm

20

22

## ELECTRICAL DATA

VERSION	A90H-A $\sim$ 11 $\mu$ App	A90H-AV $\sim$ 1 Vpp	A90H-F $\square$ TTL
Supply voltage ( $U_p$ )	+5 V $\pm$ 5%	+5 V $\pm$ 5%	+5 V $\pm$ 5%;
Max. supply current (without load)	100 mA	120 mA	150 mA
Light source	LED	LED	LED
Incremental signals	Two sinusoidal $I_1$ and $I_2$ Amplitude at 1 k $\Omega$ load: - $I_1 = 7 \dots 16 \mu$ A - $I_2 = 7 \dots 16 \mu$ A	Differential sine +A/-A and +B/-B Amplitude at 120 $\Omega$ load: - A = 0.6...1.2 V - B = 0.6...1.2 V	Differential square-wave $U1/\overline{U1}$ and $U2/\overline{U2}$ . Signal levels at 20 mA load current: - low (logic "0") $\leq$ 0.5 V - high (logic "1") $\geq$ 2.4 V
Reference signal	One quasi-triangular $I_0$ peak per revolution. Signal magnitude at 1 k $\Omega$ load: - $I_0 = 2 \dots 8 \mu$ A (usable component)	One quasi-triangular +R and its complementary -R per revolution. Signals magnitude at 120 $\Omega$ load - R = 0.2...0.8 V (usable component)	One differential square-wave $U0/\overline{U0}$ per revolution. Signal levels at 20 mA load current: - low (logic "0") < 0.5 V - high (logic "1") > 2.4 V
Maximum operating frequency	(-3 dB) $\geq$ 160 kHz	(-3 dB) $\geq$ 180 kHz	160-2500 kHz (depends on interpolation factor)
Direction of signals	$I_2$ lags $I_1$ for clockwise rotation (viewed from encoder mounting side)	+B lags +A for clockwise rotation (viewed from encoder mounting side)	$U2$ lags $U1$ with clockwise rotation (viewed from encoder mounting side)
Maximum rise and fall time	-	-	< 0.2 $\mu$ s
Standard cable length	1 m, without connector	1 m, without connector	1 m, without connector
Maximum cable length	5 m	25 m	25 m
Output signals			

Note:

- Maximum working rotation speed (with proper encoder counting) is limited by maximum operating frequency and maximum mechanical rotation speed.
- If cable extension is used, power supply conductor cross-section should not be smaller than 0.5 mm<sup>2</sup>.

## MOUNTING REQUIREMENTS

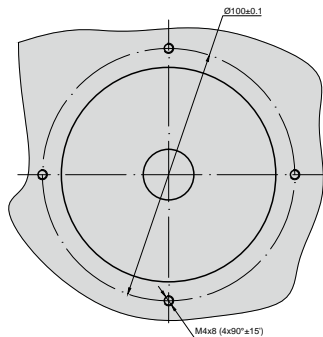

MOUNTING TYPE P (CLAMP)

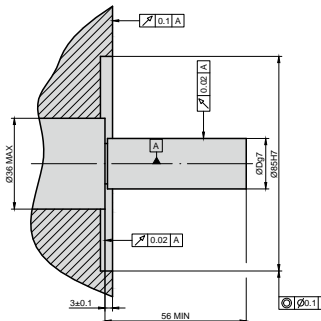

MOUNTING TYPE H (SCREW)

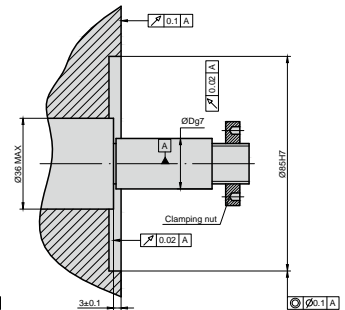

## ACCESSORIES

<b>CONNECTORS FOR CABLE</b>	B12 12-pin round connector	C9 9-pin round connector	C12 12-pin round connector	D9 9-pin flat connector	D15 15-pin flat connector	RS10 10-pin round connector	ONC 10-pin round connector	HR25 8-pins round mini connector
<b>DIGITAL READOUT DEVICES</b>	CS3000					CS5000		
<b>EXTERNAL INTERPOLATOR</b>	NK							

## ORDER FORM

OUTPUT SIGNAL VERSION:	PULSE NUMBER PER REVOLUTION:	REFERENCE SIGNAL:	ACCURACY GRADE:	DIAMETER OF SHAFT HOLE:	MOUNTING TYPE:	CABLE OR CONNECTOR OUTLET:	CABLE LENGTH:	CONNECTOR TYPE:
A AV F	1...18000 ... 1...1800000	S - one per revolution K - 36 per revolution, distance-coded	50 - $\pm$ 5.0 arc.sec. 75 - $\pm$ 7.5 arc.sec.	20 - 20mm 22 - 22mm	P - clamp H - screw	S - version S (cable outlet) C-version C (connector outlet)	AR01 - 1m AR02 - 2m AR03 - 3m ....	W - without connector B12 - round, 12 pins C9 - round, 9 pins C12 - round, 12 pins D9 - flat, 9 pins D15 - flat, 15 pins RS10 - round, 10 pins ONC - round, 10 pins
ORDER EXAMPLE:	1) A90H-A-18000-K-50-20-P-S-AR01/W							